

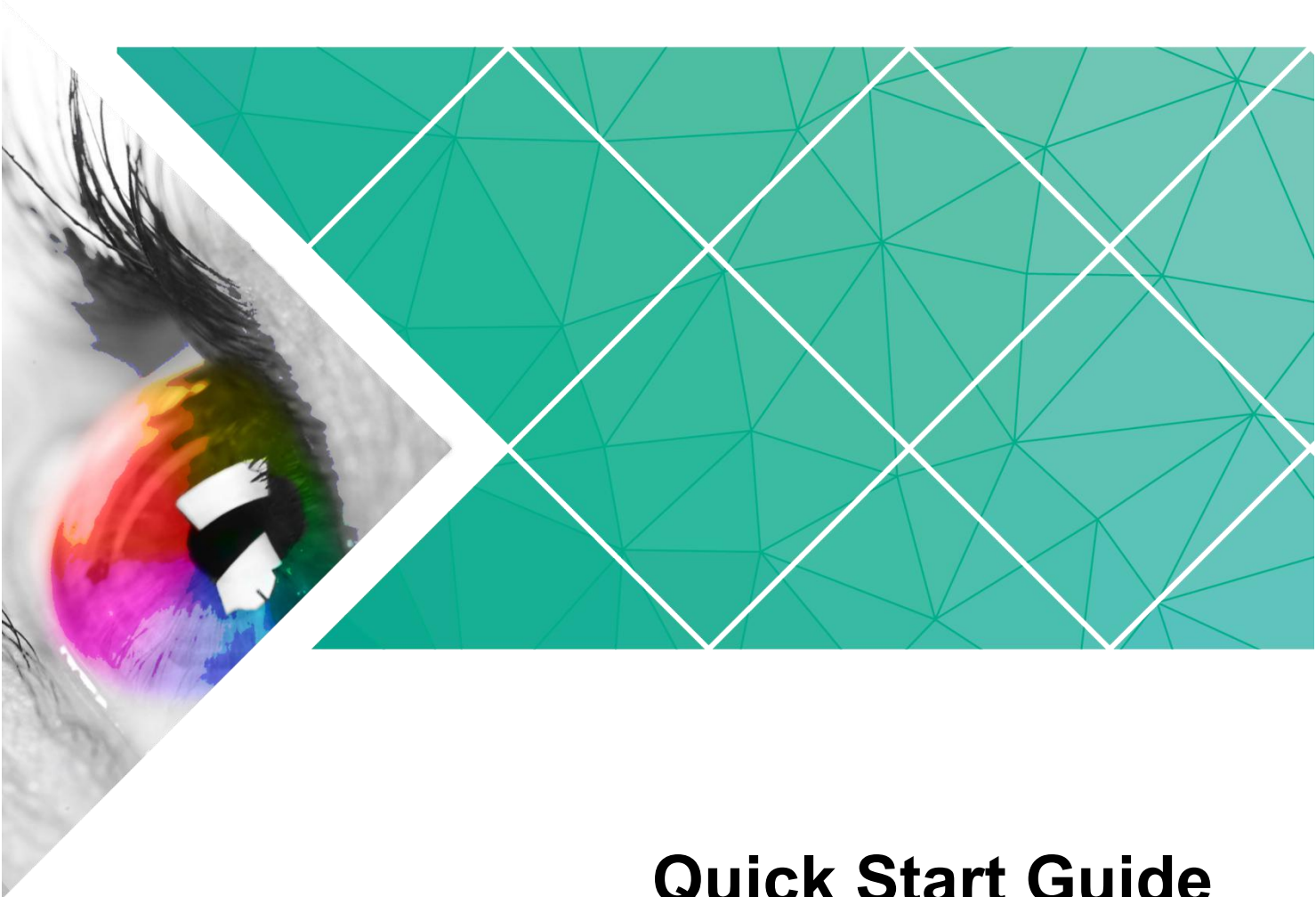

Taurus Series

Multimedia Players



Quick Start Guide

Version: V1.0.0

Doc. ID: NS120100144

Change History

Version	Release Date	Description
V1.0.0	2017-07-20	First release.

Table of Contents

Change History	i
Table of Contents	ii
1 Overview	1
1.1 Scenario.....	1
1.2 Procedures.....	1
2 Preparation	2
2.1 Getting and Installing Software.....	2
2.2 Getting Documents.....	3
2.3 Getting Required Account Information.....	3
3 Taurus Connections	4
3.1 Connecting via Ethernet Cable.....	4
3.2 Connecting via Local Area Network (LAN).....	4
3.3 Connecting via Wi-Fi.....	5
3.3.1 Wi-Fi AP Mode.....	5
3.3.2 WiFi Sta Mode.....	6
3.3.3 WiFi AP+Sta Mode.....	6
4 Receiving Card Parameter Configuration	8
4.1 Loading Configuration File or Configuring the Parameters Manually Through NovaLCT-Taurus.....	8
4.2 Loading the Configuration File Through ViPlex Handy.....	9
5 Screen Configuration	10
5.1 Configuring a Screen Through ViPlex Handy.....	10
6 General Operations	11
6.1 Taurus Login with ViPlex Handy (Android and iOS).....	11
6.2 Taurus Login with ViPlex Express (Windows).....	11
7 Caution	13

1 Overview

1.1 Scenario

This document introduces a quick way to use Taurus series multimedia players and provides instructions for the first-timer.

1.2 Procedures

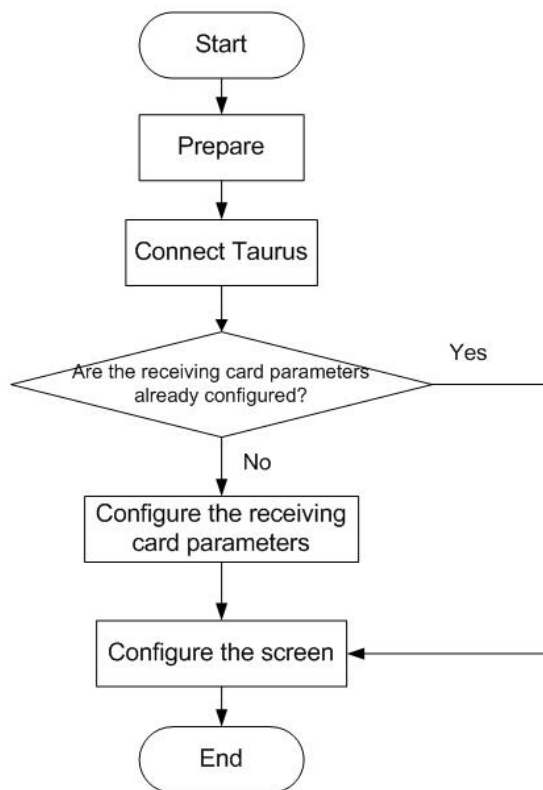

2 Preparation

2.1 Getting and Installing Software

Item	Description	How to get	How to install
ViPlex Handy	It is a LAN-based display management software, including the one applicable to Android and iOS operating systems, is mainly used for display management as well as solution editing and publishing.	Scan the following OR code to download and install the APP.  Use the App Store on your iPhone to get ViPlex Handy for iOS.	Software installation is the same as other applications.
ViPlex Express	It is a LAN-based display management software applicable to the Windows operating system, and is mainly used for display management as well as solution editing and publishing.	Visit www.novastar.tech , download and install the required software.	
NovaLCT-Taurus	Screen configuration software, which only supports Windows and is mainly used for adjusting screens to the optimal display status.	Visit www.novastar.tech , download and install the required software.	

2.2 Getting Documents

Item	Description	How to get
<i>Taurus Series Multimedia Players Product Description-V1.0.0</i>	Describing application scenarios, features, safety instructions, hardware structure, software structure and specifications of Taurus series products.	Visit www.novastar.tech to download the required documents.

2.3 Getting Required Account Information

Item	Account Name	Default Password
Connect Taurus WiFi AP	AP+ <i>last 8 digits of the SN</i> , For example: AP10000033	12345678
Log into the Taurus	admin	123456

3 Taurus Connections

3.1 Connecting via Ethernet Cable

Network Diagram

Users can access the Taurus directly when it is connected via the Ethernet cable.

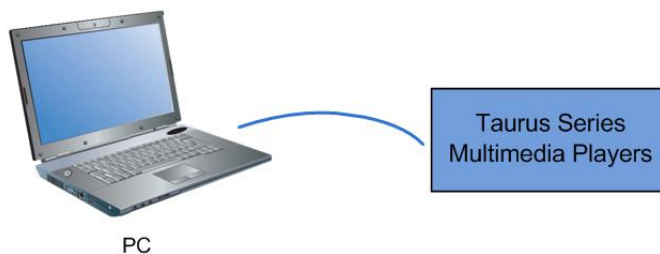

Configuration

Step 1 Refer to “[6 General Operations](#)” to log in to the Taurus.

Step 2 Turn off DHCP and set static IP address for the Taurus.

- ViPlex Handy: Select **Network Setting, Wired Network Setting** in the **Screen management** page.
- ViPlex Express: Select **Screen Control, Network configuration**.

3.2 Connecting via Local Area Network (LAN)

Network Diagram

Users can access the Taurus through LAN when it is connected via LAN.

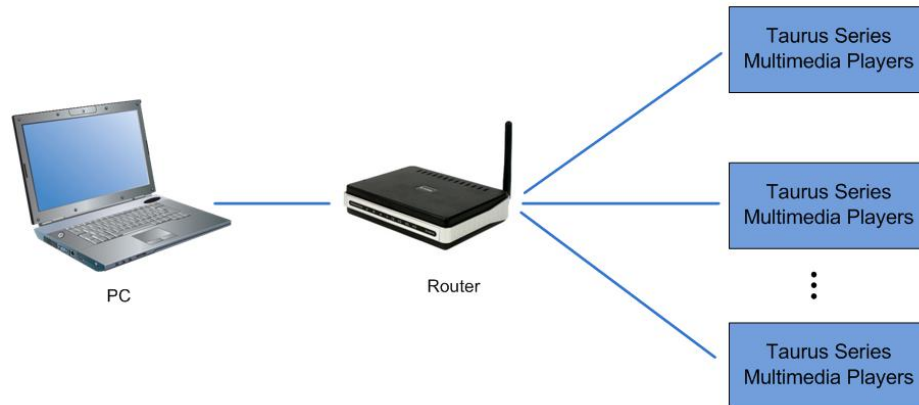

Configuration

No need for configuration.

3.3 Connecting via Wi-Fi

The Taurus series products have dual WiFi function which can provide Wi-Fi hotspot as well as serve as WiFi Station at the same time. The WiFi working frequency range is 2400~2483.5MHz.

3.3.1 Wi-Fi AP Mode

Network Diagram

Users can access the Taurus directly when it is connected via WiFi AP.

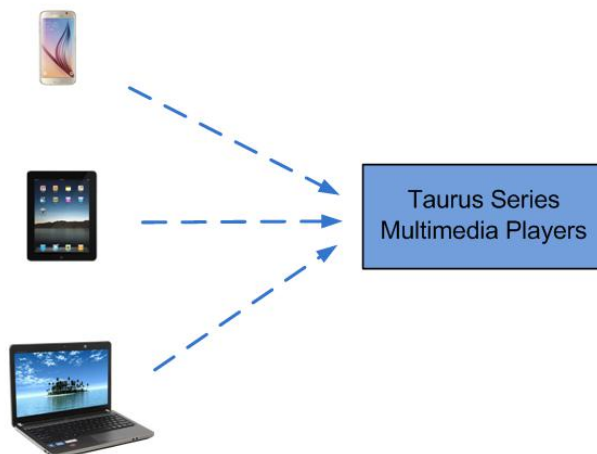

Configuration

No need for configuration. Please connect the WiFi AP of the Taurus. SSID is "AP + last 8 digits of the SN", for example, "AP10000033".

3.3.2 WiFi Sta Mode

Network Diagram

Users can access Taurus through external router when it is connected via WiFi Sta.

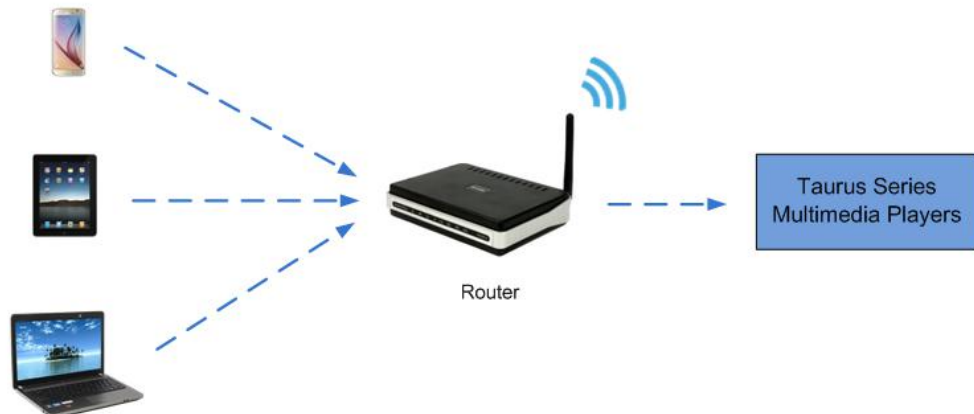

Configuration

Step 1 Refer to “[6 General Operations](#)” to log in to the Taurus.

Step 2 Turn on Wi-Fi Sta mode. Click the Wi-Fi name of the external router and then enter the password of the Wi-Fi.

- ViPlex Handy: Select **Network Setting, WiFi Setting** in the **Screen management** page.
- ViPlex Express: Select **Screen Control, Network configuration**.

3.3.3 WiFi AP+Sta Mode

Network Diagram

By using WiFi AP+Sta connection, users can directly access the Taurus or access the Internet through bridging connection.

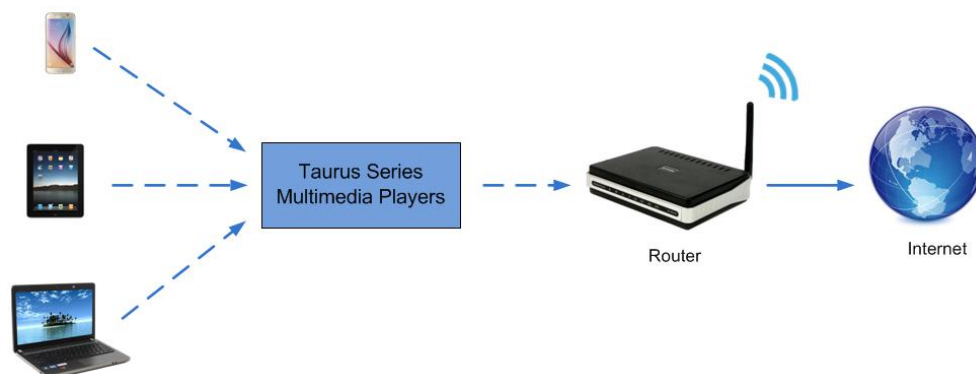

Configuration

Step 1 Refer to “[6 General Operations](#)” to log in to the Taurus.

Step 2 Turn on Wi-Fi Sta mode. Click the Wi-Fi name of the external router and then enter the password of the Wi-Fi.

- ViPlex Handy: Select **Network Setting, WiFi Setting** in the **Screen management** page.
- ViPlex Express: Select **Screen Control, Network configuration**.

Related Information

The Taurus can be connected to the Internet through following two ways. The priority order of the three ways is from high to low.

- Wired network
- WiFi Sta

4 Receiving Card Parameter Configuration

If receiving card parameters are already configured, please skip this chapter and perform the operations in “[5 Screen Configuration](#)”.

4.1 Loading Configuration File or Configuring the Parameters Manually Through NovaLCT-Taurus

- Step 1 Start NovaLCT-Taurus.
- Step 2 Select **System, Search All Display**.
System will display the screen information list.
- Step 3 Click screen information and click **Connect System**.
The gray button on the page will become normal.
- Step 4 Select **User, Advanced login**.
- Step 5 Enter password and click **Login**.
Default password is “admin”.
- Step 6 Click  to enter the **Screen Config** page.
- Step 7 Confirm whether the local PC has the required receiving card configuration file.
 - Yes. Please perform **Load Configuration File**.
 - No. Please perform **Manual Configuration**.

Loading Configuration File

- Step 1 Select **Cascading scan board** and **Load Configuration File**. Click **Browse** to choose a configuration file from the local PC.
- Step 2 Click **Next** to load the configuration file.

Manual Configuration

- Step 1 Select **Cascading scan board** and click **Next**.
- Step 2 Configure receiving card parameters based on actual conditions.

- Step 3 Click **Send To HW**.
- Step 4 Set parameters based on actual conditions and click **Send**.
- Step 5 Adjust parameters until the screen displays normally and then click **Save to Screen**.
- Step 6 (Optional) Click **Save Config File** to back up the receiving card configuration file to the local PC.

4.2 Loading the Configuration File Through ViPlex Handy

- Step 1 Save the receiving card configuration file to mobile phone.
- Step 2 Refer to “[6 General Operations](#)” to log in to the Taurus.
- Step 3 Click screen name to enter the **Screen management** page.
- Step 4 Select **Screen Setting, Receiving card configuration** to enter the **Receiving card configuration** page.
- Step 5 Select the receiving card configuration file and click **Send**.

5 Screen Configuration

5.1 Configuring a Screen Through ViPlex Handy

- Step 1 Refer to “[6 General Operations](#)” to log in to the Taurus.
- Step 2 Click screen name to enter the **Screen management** page.
- Step 3 Select **Screen Setting, Screen configuration** to enter the **Screen configuration** page.
- Step 4 Configure screen information based on actual conditions and click **OK**.

6 General Operations

6.1 Taurus Login with ViPlex Handy (Android and iOS)

Before You Begin

- Acquire the SSID and password of Wi-Fi AP of Taurus series products. SSID is default to be composed of AP and the last 8 numbers of SN, and the password is default as “**12345678**”.
- Acquire the login password of user “admin” of which the default password is “**123456**”.



Operating Procedures

ViPlex Handy can connect numerous Taurus series products.

Step 1 Connect Wi-Fi AP of the Taurus series products.

Step 2 Start ViPlex Handy.

System can automatically detect the Taurus series products and refresh **Screen list**. Users can also slide down **Screen list** to manually refresh the list.

- : denotes that Taurus is online and you can log into it.
- : denotes that Taurus is offline and you cannot log into it.
- : denotes that Taurus login is successful.

Step 3 Click **Connect** next to the screen name.

Step 4 Enter the user name and password and click **Login**.

6.2 Taurus Login with ViPlex Express (Windows)

Before You Begin

- Acquire the SSID and password of Wi-Fi AP of Taurus series products. SSID is default to be composed of AP and the last 8 numbers of SN, and the password is default as “**12345678**”.
- Acquire the login password of user “admin” of which the default password is “**123456**”.



Operating Procedures

ViPlex Express can connect numerous Taurus series products.

Step 1 Connect Wi-Fi AP of the Taurus series products.

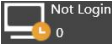

Step 2 Start the ViPlex Express.

Step 3 Click **Refresh** and the screen list will be displayed on the page.

- : denotes that Taurus is online and you can log into it.
- : denotes that Taurus is offline and you cannot log into it.
- : denotes that Taurus login is successful.

After the Taurus is found by ViPlex Express, the ViPlex express will try to log into to the Taurus with the default account or the account used for last login.

Step 4 Taurus login is successful or not.

- Yes.  appears and no further operation is required.
- No.  appears and then perform Step 5.

Step 5 Click **Connect** on the right of the screen information.

Step 6 Enter the username and password, and click **OK**.

7 Caution

FCC Caution:

Any changes or modifications not expressly approved by the party responsible for compliance could void the user's authority to operate the equipment.

This device complies with part 15 of the FCC Rules. Operation is subject to the following two conditions: (1) This device may not cause harmful interference, and (2) this device must accept any interference received, including interference that may cause undesired operation.

Note: This equipment has been tested and found to comply with the limits for a Class A digital device, pursuant to part 15 of the FCC Rules. These limits are designed to provide reasonable protection against harmful interference when the equipment is operated in a commercial environment. This equipment generates, uses, and can radiate radio frequency energy and, if not installed and used in accordance with the instruction manual, may cause harmful interference to radio communications. Operation of this equipment in a residential area is likely to cause harmful interference in which case the user will be required to correct the interference at his own expense.

This equipment complies with FCC radiation exposure limits set forth for an uncontrolled environment. This equipment should be installed and operated with minimum distance 20cm between the radiator & your body.

This transmitter must not be co-located or operating in conjunction with any other antenna or transmitter.

CE Caution:

This equipment should be installed and operated with minimum distance 20cm between the radiator & your body.

IC Warning:

RSS-Gen Issue 3 December 2010" & "CNR-Gen 3e édition Décembre 2010:

- English:

This device complies with Industry Canada licence-exempt RSS standard(s).

Operation is subject to the following two conditions: (1) This device may not cause interference, and (2) This device must accept any interference, including interference that may cause undesired operation of the device.

- French:

Le présent appareil est conforme aux CNR d'Industrie Canada applicables aux appareils radio exempts de licence. L'exploitation est autorisée aux deux conditions suivantes:

(1) l'appareil ne doit pas produire de brouillage, et

(2) l'utilisateur de l'appareil doit accepter tout brouillage radioélectrique subi, même si le brouillage est susceptible d'en compromettre le fonctionnement.

Battery Caution:

**CAUTION
RISK OF EXPLOSION IF BATTERY IS REPLACED
BY AN INCORRECT TYPE.
DISPOSE OF USED BATTERIES ACCORDING
TO THE INSTRUCTIONS**



正基科技股份有限公司

SPECIFICATION

SPEC. NO. : _____ REV : 1.3

DATE : 12.26.2014

PRODUCT NAME : AP6212

	APPROVED	CHECKED	PREPARED	DCC ISSUE
NAME				

AMPAK

AP6212

WiFi+Bluetooth 4.1+FM RX
SIP Module Spec Sheet

Revision History

Date	Revision Content	Revised By	Version
2014/04/08	- Preliminary	Brian	1.0
2014/09/02	- Pin Definition Modified	Brian	1.1
2014/11/26	- Bluetooth Spec Modified	Brian	1.2
2014/12/26	- Add Process	Brian	1.3

AMPAK
Confidential

Contents

Contents	2
1. Introduction.....	3
2. Features.....	4
3. Deliverables	5
3.1 Deliverables.....	5
3.2 Regulatory certifications	5
4. General Specification	6
4.1 General Specification.....	6
4.2 Voltages.....	6
4.2.1 Absolute Maximum Ratings.....	6
4.2.2 Recommended Operating Rating	6
5. WiFi RF Specification	7
5.1 2.4GHz RF Specification.....	7
6. Bluetooth Specification.....	9
6.1 Bluetooth Specification	9
7. FM Specification	10
7.1 FM Specification (TBD).....	10
8. Pin Assignments.....	11
8.1 Pin Outline	11
8.2 Pin Definition	11
9. Dimensions	13
9.1 Physical Dimensions	13
9.2 Layout Recommendation.....	14
10. External clock reference	15
10.1 SDIO Pin Description.....	15
11. Host Interface Timing Diagramo	16
11.1 Power-up Sequence Timing Diagram	16
11.2 SDIO Default Mode Timing Diagram.....	18
11.3 SDIO High Speed Mode Timing Diagram.....	19
12. Recommended Reflow Profile	20
13. Package Information.....	22
13.1 Label	22
13.2 Dimension	23
13.3 MSL Level / Storage Condition	25

1. Introduction

AMPAK Technology would like to announce a low-cost and low-power consumption module which has all of the WiFi, Bluetooth and FM functionalities. The highly integrated module makes the possibilities of web browsing, VoIP, Bluetooth headsets, FM radio functional applications and other applications. With seamless roaming capabilities and advanced security, also could interact with different vendors' 802.11b/g/n Access Points in the wireless LAN.

The wireless module complies with IEEE 802.11 b/g/n standard and it can achieve up to a speed of 72.2Mbps with single stream in 802.11n draft, 54Mbps as specified in IEEE 802.11g, or 11Mbps for IEEE 802.11b to connect to the wireless LAN. The integrated module provides SDIO interface for WiFi, UART / I2S / PCM interface for Bluetooth and UART / I2S / PCM interface for FM.

This compact module is a total solution for a combination of WiFi + BT + FM technologies. The module is specifically developed for Smart phones and Portable devices.

2. Features

- 802.11b/g/n single-band radio
- Bluetooth V4.1(HS) with integrated Class 1.5 PA and Low Energy (BLE) support
- Concurrent Bluetooth, FM (RX) RDS/RBDS, and WLAN operation
- Simultaneous BT/WLAN receive with single antenna
- WLAN host interface options:
 - SDIO v2.0 — up to 50 MHz clock rate
- BT host digital interface:
 - UART (up to 4 Mbps)
- FM multiple audio routing options: I2S, PCM, eSCO, A2DP
- IEEE Co-existence technologies are integrated die solution
- ECI — enhanced coexistence support, ability to coordinate BT SCO transmissions around WLAN receives

A simplified block diagram of the module is depicted in the figure below.

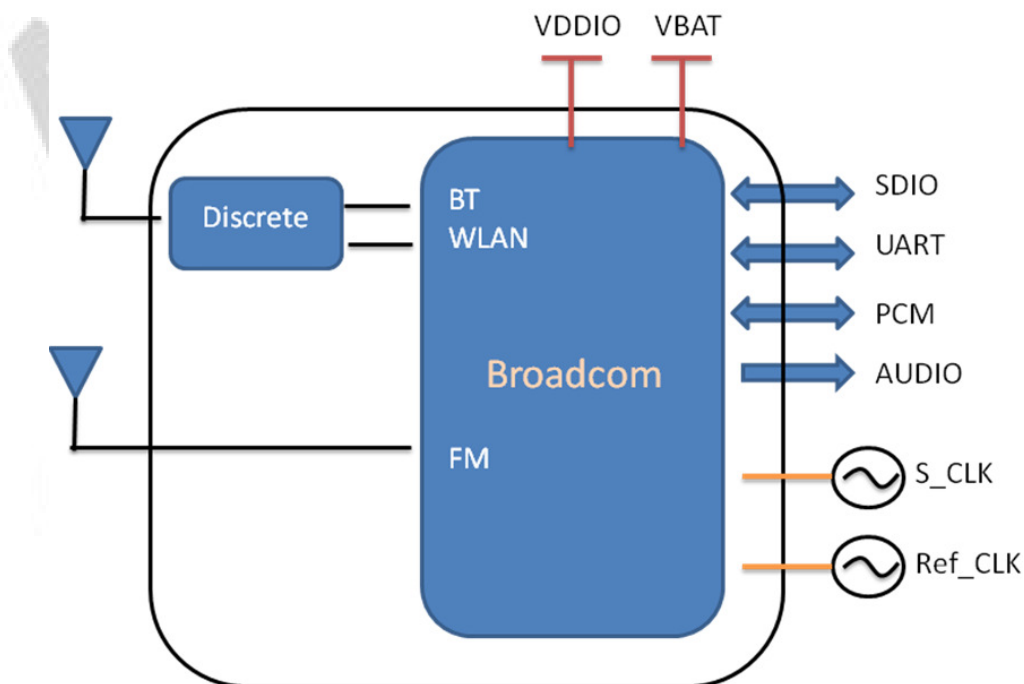

3. Deliverables

3.1 Deliverables

The following products and software will be part of the product.

- Module with packaging
- Evaluation Kits
- Software utility for integration, performance test.
- Product Datasheet.
- Agency certified pre-tested report with the adapter board.

3.2 Regulatory certifications

The product delivery is a pre-tested module, without the module level certification. For module approval, the platform's antennas are required for the certification.

4. General Specification

4.1 General Specification

Model Name	AP6212
Product Description	Support WiFi/Bluetooth/FM functionalities
Dimension	L x W x H: 12 x 12 x 1.5 (typical) mm
WiFi Interface	SDIOV2.0
BT Interface	UART / PCM
FM Interface	UART / PCM / Audio
Operating temperature	-30°C to 85°C
Storage temperature	-40°C to 85°C
Humidity	Operating Humidity 10% to 95% Non-Condensing

4.2 Voltages

4.2.1 Absolute Maximum Ratings

Symbol	Description	Min.	Max.	Unit
VBAT	Input supply Voltage	-0.5	5.5	V
WL_VIO_SD	Digital/Bluetooth/SDIO/ I/O Voltage	-0.5	3.6	V

4.2.2 Recommended Operating Rating

The module requires two power supplies: VBAT and VDDIO.

	Min.	Typ.	Max.	Unit
Operating Temperature	-30	25	85	deg.C
VBAT	3.0	3.6	4.8	V
VDDIO	1.7	3.3	3.6	V

5. WiFi RF Specification

5.1 2.4GHz RF Specification

Conditions : VBAT=3.6V ; VDDIO=3.3V ; Temp:25°C

Feature	Description
WLAN Standard	IEEE 802.11b/g/n, WiFi compliant
Frequency Range	2.400 GHz ~ 2.497 GHz (2.4 GHz ISM Band)
Number of Channels	2.4GHz : Ch1 ~ Ch14
Modulation	802.11b : DQPSK, DBPSK, CCK 802.11 g/n : OFDM /64-QAM, 16-QAM, QPSK, BPSK
Output Power	802.11b /11Mbps : 16 dBm ± 1.5 dB @ EVM ≤ -9dB
	802.11g /54Mbps : 15 dBm ± 1.5 dB @ EVM ≤ -25dB
	802.11n /65Mbps : 14 dBm ± 1.5 dB @ EVM ≤ -28dB
Receive Sensitivity (11n,20MHz) @10% PER	- MCS=0 PER @ -85 dBm, typical
	- MCS=1 PER @ -84 dBm, typical
	- MCS=2 PER @ -82 dBm, typical
	- MCS=3 PER @ -80 dBm, typical
	- MCS=4 PER @ -77 dBm, typical
	- MCS=5 PER @ -73 dBm, typical
	- MCS=6 PER @ -71 dBm, typical
	- MCS=7 PER @ -68 dBm, typical
Receive Sensitivity (11g) @10% PER	- 6Mbps PER @ -86 dBm, typical
	- 9Mbps PER @ -85 dBm, typical
	- 12Mbps PER @ -85 dBm, typical
	- 18Mbps PER @ -83 dBm, typical
	- 24Mbps PER @ -81 dBm, typical
	- 36Mbps PER @ -78 dBm, typical
	- 48Mbps PER @ -73 dBm, typical
	- 54Mbps PER @ -71 dBm, typical
Receive Sensitivity (11b) @8% PER	- 1Mbps PER @ -90 dBm, typical
	- 2Mbps PER @ -88 dBm, typical
	- 5.5Mbps PER @ -87 dBm, typical
	- 11Mbps PER @ -84 dBm, typical
Data Rate	802.11b : 1, 2, 5.5, 11Mbps
	802.11g : 6, 9, 12, 18, 24, 36, 48, 54Mbps

Data Rate (20MHz ,Long GI,800ns)	802.11n: 6.5, 13, 19.5, 26, 39, 52, 58.5, 65Mbps
Data Rate (20MHz ,short GI,400ns)	802.11n : 7.2, 14.4, 21.7, 28.9, 43.3, 57.8, 65,72.2Mbps
Maximum Input Level	802.11b : -10 dBm
	802.11g/n : -20 dBm
Antenna Reference	Small antennas with 0~2 dBi peak gain

AMPAK
Confidential

6. Bluetooth Specification

6.1 Bluetooth Specification

Conditions : VBAT=3.6V ; VDDIO=3.3V ; Temp:25 °C

Feature	Description		
General Specification			
Bluetooth Standard	Bluetooth V4.1 of 1, 2 and 3 Mbps.		
Host Interface	UART		
Antenna Reference	Small antennas with 0~2 dBi peak gain		
Frequency Band	2402MHz ~ 2480MHz		
Number of Channels	79 channels		
Modulation	FHSS, GFSK, DPSK, DQPSK		
RF Specification			
	Min.	Typical.	Max.
Output Power (Class 1.5)		8 dBm	
Sensitivity @ BER=0.1% for GFSK (1Mbps)		-86 dBm	
Sensitivity @ BER=0.01% for $\pi/4$ -DQPSK (2Mbps)		-86 dBm	
Sensitivity @ BER=0.01% for 8DPSK (3Mbps)		-80 dBm	
Maximum Input Level	GFSK (1Mbps):-20dBm		
	$\pi/4$ -DQPSK (2Mbps) :-20dBm		
	8DPSK (3Mbps) :-20dBm		

7. FM Specification

7.1 FM Specification (TBD)

Conditions : VBAT=3.6V ; VDDIO=3.3V ; Temp:25 °C

Feature	Description					
General Specification						
Frequency Band	76MHz-108MHz					
Host Interface	HCI UART, I2S/PCM					
Channel step	50 KHz					
Analog Audio output load	$R_L > 30K\Omega$, $C_L > 20pF$					
Characteristics	Condition	MIN	TYP	MAX	UNIT	
Transmitter (FM Tx load = 120nH, Q>30)	Output Power Level				dBuV	
	Audio harmonic distortion (fmod=1KHz, $\Delta f=75KHz$, Pilot $\Delta f=6.75KHz$)				%	
	Audio SNR ($\Delta f=22.5KHz$, I2S audio in SNR \geq 57dB)	MONO				dB
		Stereo				
Receiver (FM Tx Antenna = 120nH, Q>30)	RDS Sensitivity				dBm	
	Audio harmonic distortion (Vin=1mV, $\Delta f=75KHz$)	fmod= 1KHz				%
		fmod= 3KHz				
	Maximum SNR (fmod=1KHz, $\Delta f=22.5$ KHz, BW=300Hz to 15KHz)	MONO				dB
		Stereo				
RF input power level					dBuV	

8. Pin Assignments

8.1 Pin Outline

< TOP VIEW >

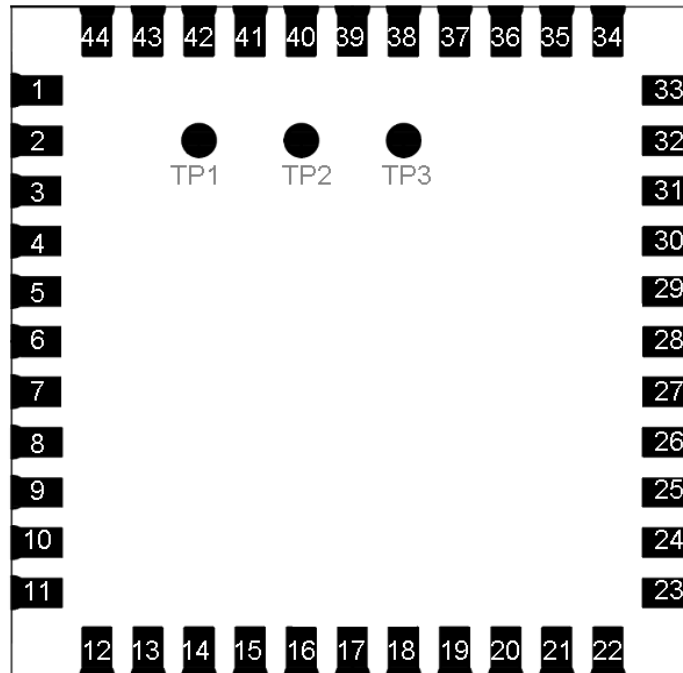

8.2 Pin Definition

NO	Name	Type	Description
1	GND	—	Ground connections
2	WL_BT_ANT	I/O	RF I/O port
3	GND	—	Ground connections
4	FM_RX	I	FM radio RF input antenna port
5	NC	—	Floating (Don't connected to ground)
6	BT_WAKE	I	HOST wake-up Bluetooth device
7	BT_HOST_WAKE	O	Bluetooth device to wake-up HOST
8	NC	—	Floating (Don't connected to ground)
9	VBAT	P	Main power voltage source input
10	XTAL_IN	I	Crystal input
11	XTAL_OUT	O	Crystal output
12	WL_REG_ON	I	Internal regulators power enable/disable
13	WL_HOST_WAKE	O	WLAN to wake-up HOST

14	SDIO_DATA_2	I/O	SDIO data line 2
15	SDIO_DATA_3	I/O	SDIO data line 3
16	SDIO_DATA_CMD	I/O	SDIO command line
17	SDIO_DATA_CLK	I/O	SDIO clock line
18	SDIO_DATA_0	I/O	SDIO data line 0
19	SDIO_DATA_1	I/O	SDIO data line 1
20	GND	—	Ground connections
21	VIN_LDO_OUT	P	Internal Buck voltage generation pin
22	VDDIO	P	I/O Voltage supply input
23	VIN_LDO	P	Internal Buck voltage generation pin
24	LPO	I	External Low Power Clock input (32.768KHz)
25	PCM_OUT	O	PCM Data output
26	PCM_CLK	I/O	PCM clock
27	PCM_IN	I	PCM data input
28	PCM_SYNC	I/O	PCM sync signal
29	NC	—	Floating (Don't connected to ground)
30	NC	—	Floating (Don't connected to ground)
31	GND	—	Ground connections
32	NC	—	Floating (Don't connected to ground)
33	GND	—	Ground connections
34	BT_RST_N	I	Low asserting reset for Bluetooth core
35	NC	—	Floating (Don't connected to ground)
36	GND	—	Ground connections
37	GPIO4	I/O	WiFi Co-existence pin with LTE
38	GPIO3	I/O	WiFi Co-existence pin with LTE
39	GPIO2	I/O	WiFi Co-existence pin with LTE
40	GPIO1	I/O	WiFi Co-existence pin with LTE
41	UART_RTS_N	O	Bluetooth/FM UART interface
42	UART_TXD	O	Bluetooth/FM UART interface
43	UART_RXD	I	Bluetooth/FM UART interface
44	UART_CTS_N	I	Bluetooth/FM UART interface
45	TP1	O	FM Analog AUDIO left output
46	TP2	O	FM Analog AUDIO right output
47	TP3 (NC)	—	Floating (Don't connected to ground)

9. Dimensions

9.1 Physical Dimensions

(Unit: mm)

< TOP VIEW >

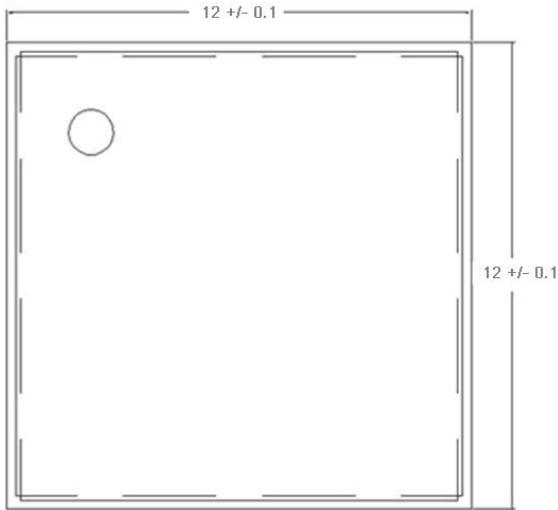

< Side View >

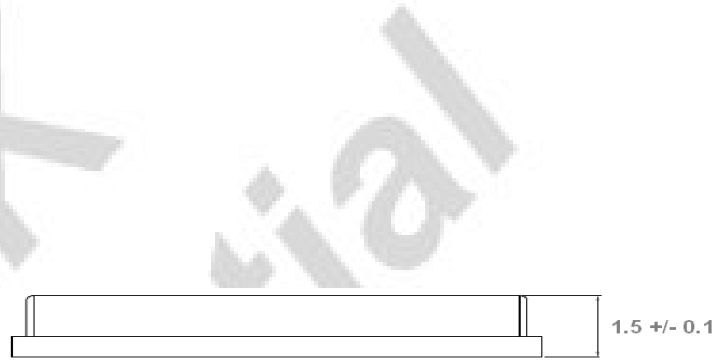

< TOP VIEW >

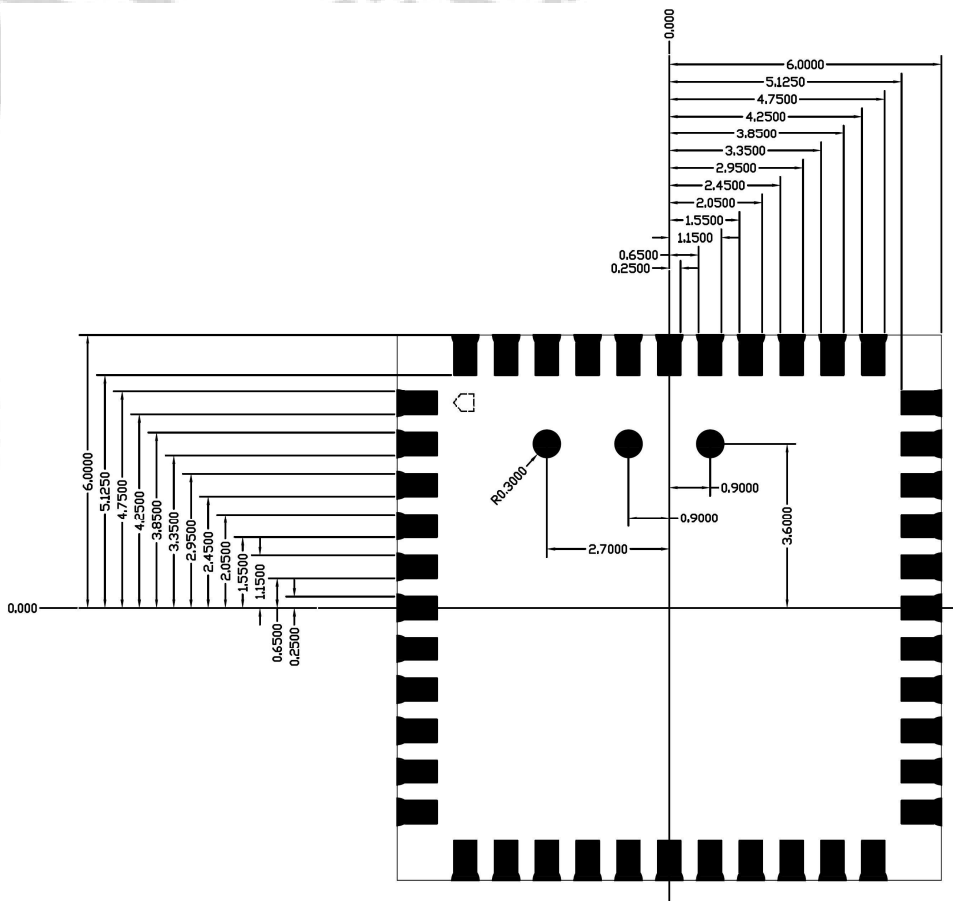

9.2 Layout Recommendation

(Unit: mm)

< TOP VIEW >

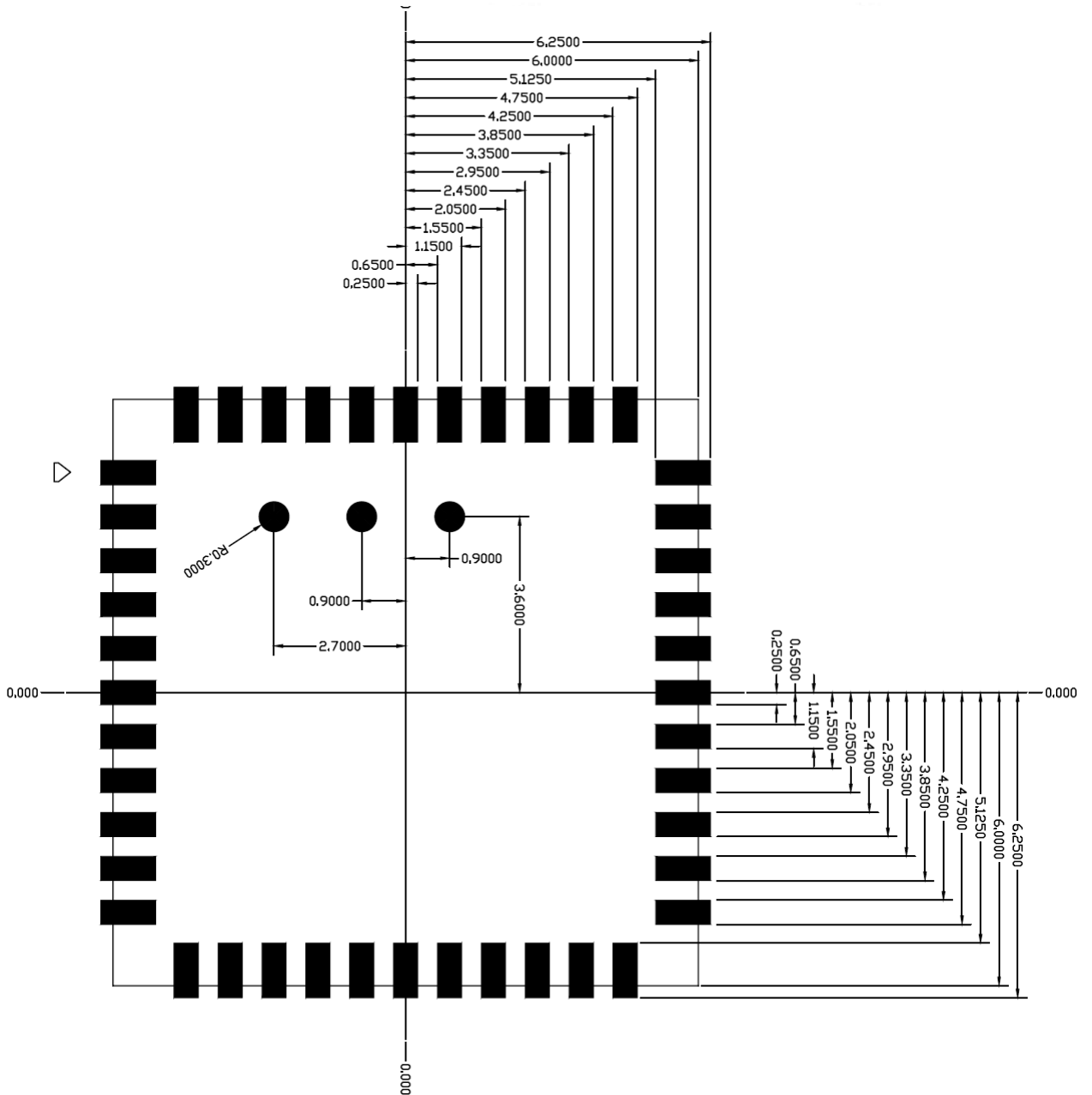

10. External clock reference

External LPO signal characteristics

Parameter	Specification	Units
Nominal input frequency	32.768	kHz
Frequency accuracy	±30	ppm
Duty cycle	30 - 70	%
Input signal amplitude	400 to 1800	mV, p-p
Signal type	Square-wave	-
Input impedance	>100k <5	Ω pF
Clock jitter (integrated over 300Hz – 15KHz)	<1	Hz
Output high voltage	0.7V _{io} - V _{io}	V

External Ref_CLK signal characteristics

No.	Item	Symb.	Electrical Specification				Remark
			Min.	Type	Max.	Units	
1	Nominal Frequency	F0	26.00000			MHz	
2	Mode of Vibration		Fundamental				
3	Frequency Tolerance	ΔF/F0	-10	-	10	ppm	at 25°C±3°C
4	Operating Temperature Range	T _{OPR}	-30	-	85	°C	
5	Frequency Stability	TC	-10	-	10	ppm	
6	Storage Temperature	T _{STG}	-55	-	125	°C	
7	Load capacitance	CL	-	16		pF	
8	Equivalent Series Resistance	ESR	-	-	50	Ω	
9	Drive Level	DL	-	100	200	μW	
10	Insulation Resistance	IR	500	-	-	MΩ	At 100V _{DC}
11	Shunt Capacitance	C0	-	-	3	pF	
12	Aging Per Year	Fa	-2	-	2	ppm	First Year

10.1 SDIO Pin Description

The module supports SDIO version 2.0 for 4-bit modes (100 Mbps), and high speed 4-bit (50 MHz clocks – 200 Mbps). It has the ability to stop the SDIO clock and map the interrupt signal into a GPIO pin. This 'out-of-band' interrupt signal notifies the host when the WLAN device wants to turn on the SDIO interface. The ability to force the control of the gated clocks from within the WLAN chip is also provided.

- ❖ Function 0 Standard SDIO function (Max BlockSize / ByteCount = 32B)
- ❖ Function 1 Backplane Function to access the internal System On Chip (SOC) address space (Max BlockSize / ByteCount = 64B)
- ❖ Function 2 WLAN Function for efficient WLAN packet transfer through DMA (Max BlockSize/ByteCount=512B)

SDIO Pin Description

SD 4-Bit Mode	
DATA0	Data Line 0
DATA1	Data Line 1 or Interrupt
DATA2	Data Line 2 or Read Wait
DATA3	Data Line 3
CLK	Clock
CMD	Command Line

11. Host Interface Timing Diagram

11.1 Power-up Sequence Timing Diagram

The module has signals that allow the host to control power consumption by enabling or disabling the Bluetooth, WLAN and internal regulator blocks. These signals are described below.

Additionally, diagrams are provided to indicate proper sequencing of the signals for various operating states. The timing value indicated are minimum required values: longer delays are also acceptable.

- ※ WL_REG_ON: Used by the PMU to power up the WLAN section. When this pin is high, the regulators are enabled and the WLAN section is out of reset. When this pin is low the WLAN section is in reset.
- ※ BT_RST_N: Low asserting reset for Bluetooth and FM only. This pin has no effect on WLAN and does not control any PMU functions. This pin must be driven high or low (not left floating).

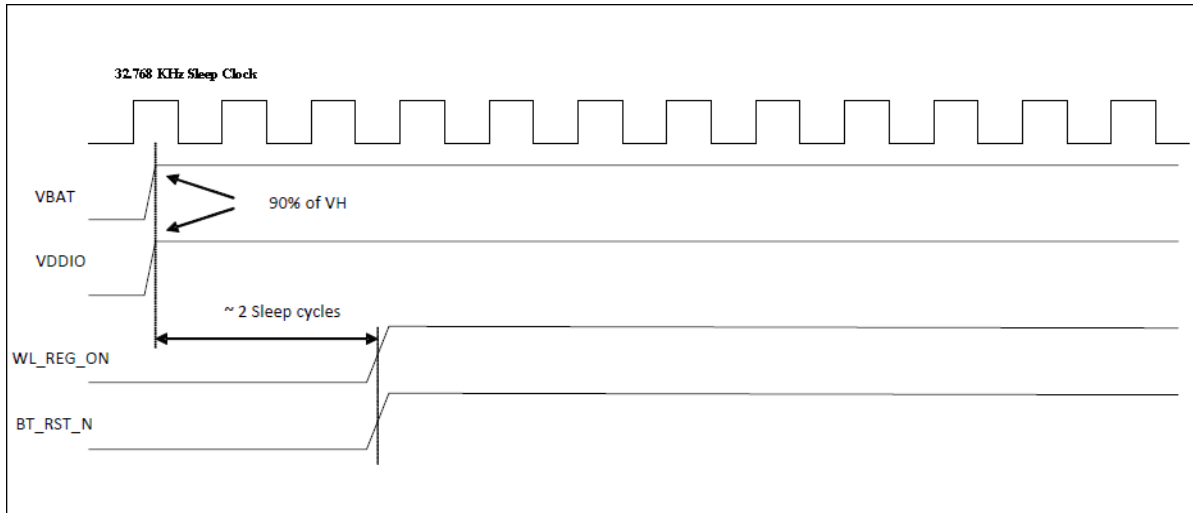

WLAN=ON, Bluetooth=ON

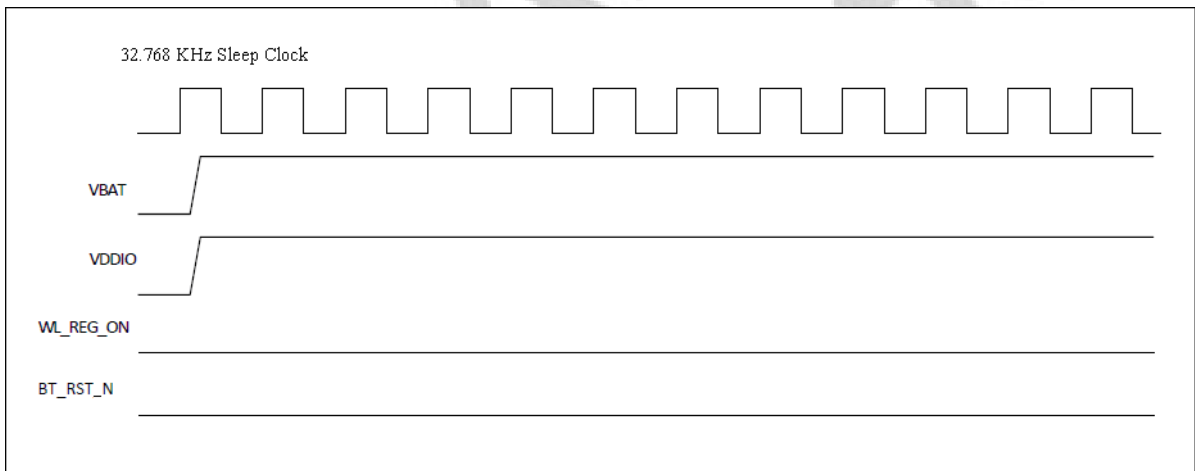

WLAN=OFF, Bluetooth=OFF

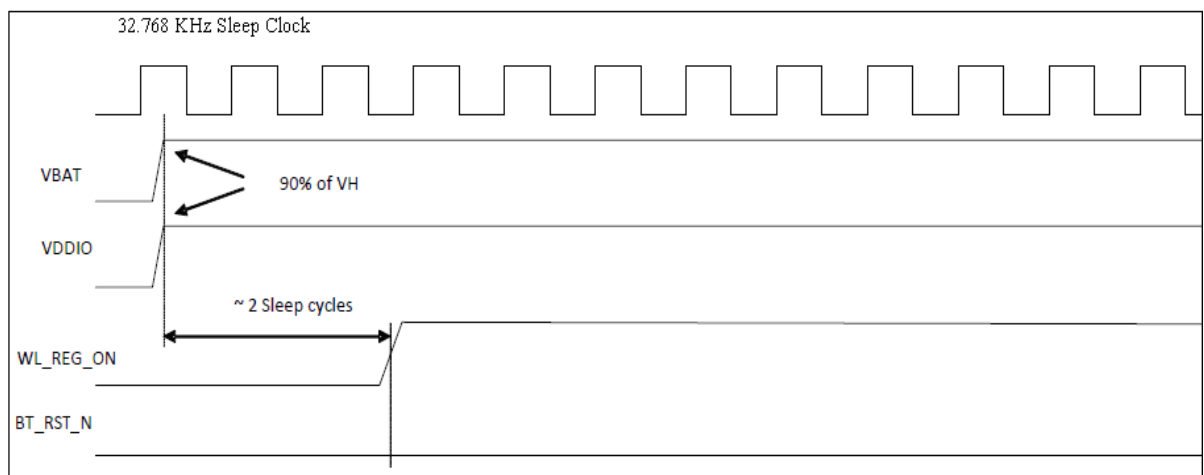

WLAN=ON, Bluetooth=OFF

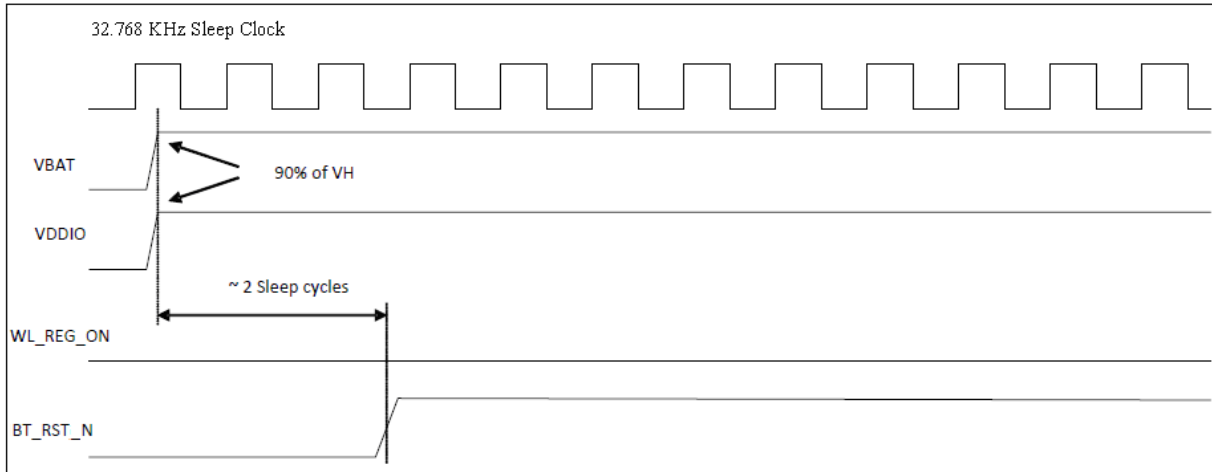

WLAN=OFF, Bluetooth=ON

11.2 SDIO Default Mode Timing Diagram

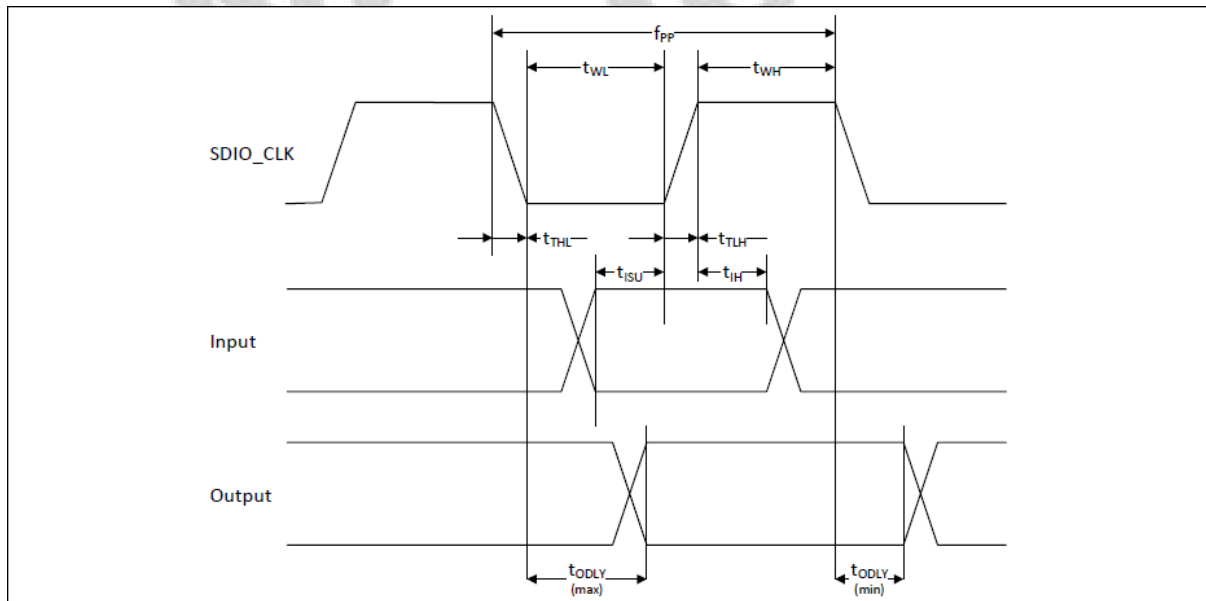

Parameter	Symbol	Minimum	Typical	Maximum	Unit
SDIO CLK (All values are referred to minimum VIH and maximum VIL^b)					
Frequency-Data Transfer mode	fPP	0	-	25	MHz
Frequency-Identification mode	fOD	0	-	400	kHz
Clock low time	tWL	10	-	-	ns
Clock high time	tWH	10	-	-	ns
Clock rise time	tTLH	-	-	10	ns
Clock low time	tTHL	-	-	10	ns
Inputs: CMD, DAT (referenced to CLK)					
Input setup time	tISU	5	-	-	ns
Input hold time	tIH	5	-	-	ns
Outputs: CMD, DAT (referenced to CLK)					
Output delay time - Data Transfer mode	tODLY	0	-	14	ns
Output delay time - Identification mode	tODLY	0	-	50	ns

a. Timing is based on CL ≤ 40pF load on CMD and Data.
 b. min(Vih) = 0.7 x VDDIO and max(Vil) = 0.2 x VDDIO.

11.3 SDIO High Speed Mode Timing Diagram

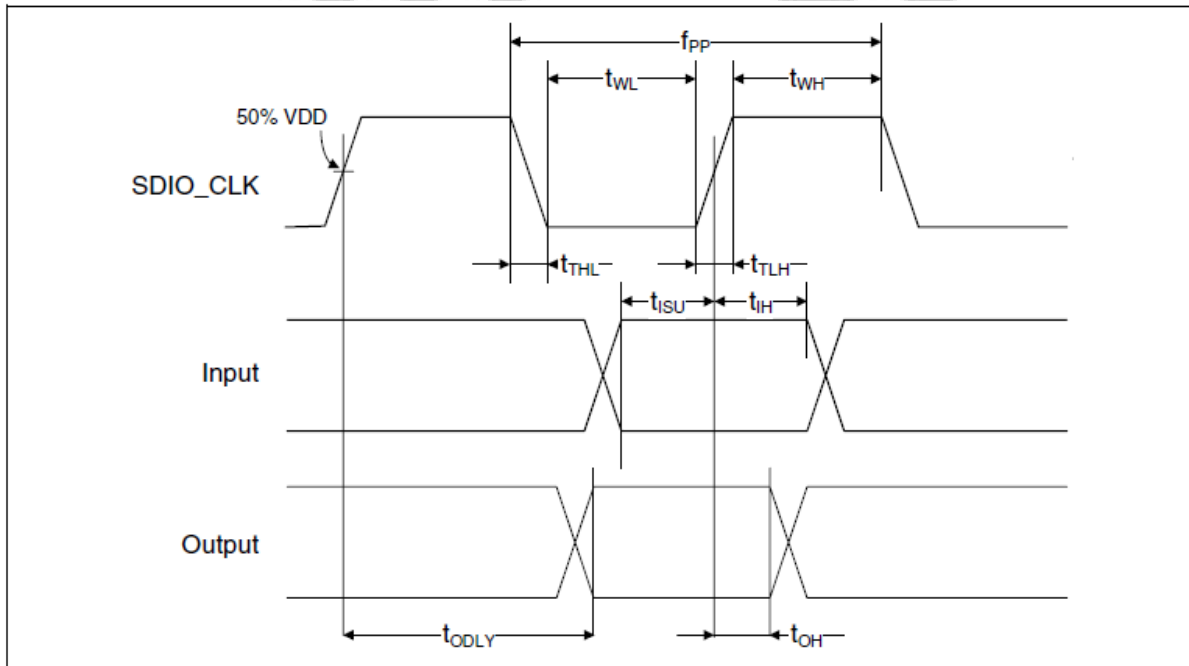

Parameter	Symbol	Minimum	Typical	Maximum	Unit
SDIO CLK (All values are referred to minimum VIH and maximum VIL^b)					
Frequency-Data Transfer mode	fPP	0	-	50	MHz
Frequency-Identification mode	fOD	0	-	400	kHz
Clock low time	tWL	7	-	-	ns
Clock high time	tWH	7	-	-	ns
Clock rise time	tTLH	-	-	3	ns
Clock low time	tTHL	-	-	3	ns
Inputs: CMD, DAT (referenced to CLK)					
Input setup time	tISU	6	-	-	ns
Input hold time	tIH	2	-	-	ns
Outputs: CMD, DAT (referenced to CLK)					
Output delay time - Data Transfer mode	tODLY	-	-	14	ns
Output hold time	tOH	2.5	-	-	ns
Total system capacitance (each line)	CL	-	-	40	pF

a. Timing is based on CL ≤ 40pF load on CMD and Data.
 b. min(Vih) = 0.7 x VDDIO and max(Vil) = 0.2 x VDDIO.

12. Recommended Reflow Profile

Referred to IPC/JEDEC standard.

Peak Temperature : <math>< 250^{\circ}\text{C}</math>

Number of Times : ≤ 2 times

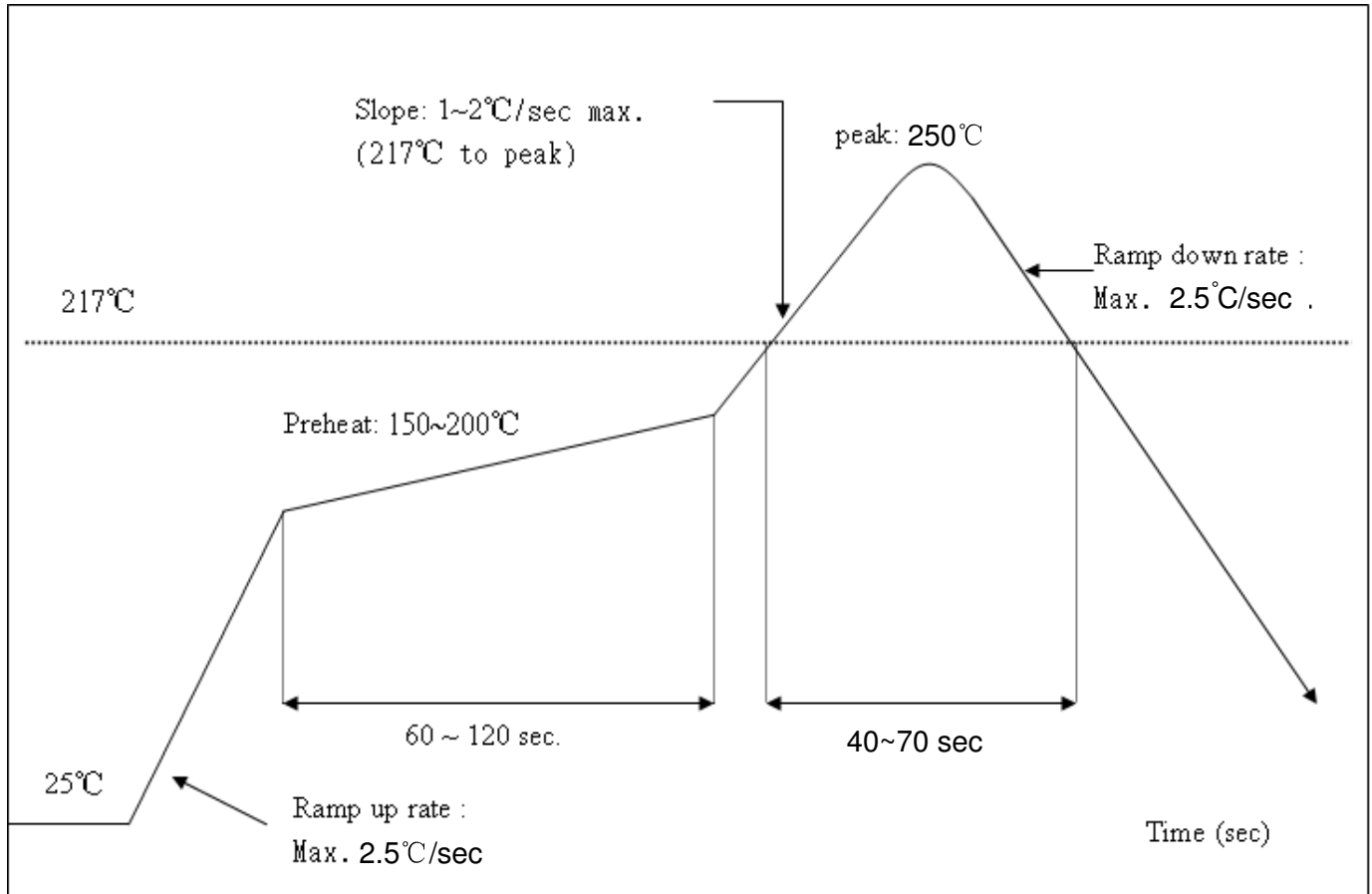

It must use N2 for reflow and suggest the concentration of oxygen less than 5000 ppm .

Solder Paste definition

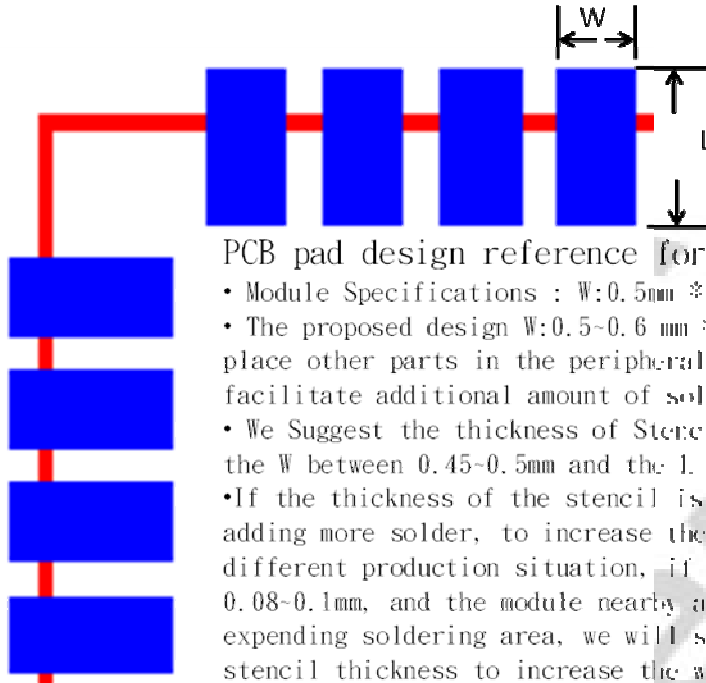

PCB pad design reference for AP Series models :

- Module Specifications : W:0.5mm * L:0.87mm pitch 0.9 mm
- The proposed design W:0.5-0.6 mm * L:1.25mm. Consider not place other parts in the peripheral area of 1 mm - 1.5 mm to facilitate additional amount of solder for PCB pad.
- We Suggest the thickness of Stencil between 0.12 mm - 0.15mm, the W between 0.45-0.5mm and the L between 1.1-1.5mm.
- If the thickness of the stencil is thinner, we suggest to adding more solder, to increase the wetting ability. Depends on different production situation, if the stencil thickness is 0.08-0.1mm, and the module nearby area is no more space for expending soldering area, we will suggest to increase the stencil thickness to increase the wetting ability.
- The major consideration points of stencil design is to increase the solder paste wetting ability.

• PCB pad design reference for AP Series models :

- Module Specifications L:0.7mm
- The design for PCB Pad : L:0.7mm
- We recommend the apertures for stencil L:0.5mm-0.6mm
- In order to avoid highness impact caused solder paste thickness, the stencil open size can be appropriately retracted

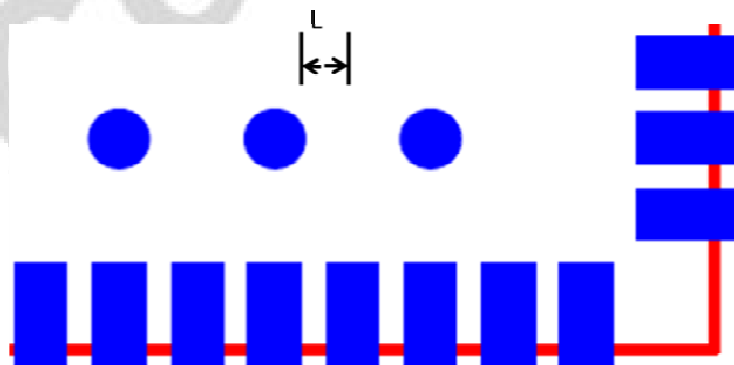

13. Package Information

13.1 Label

Label A → Anti-static and humidity notice

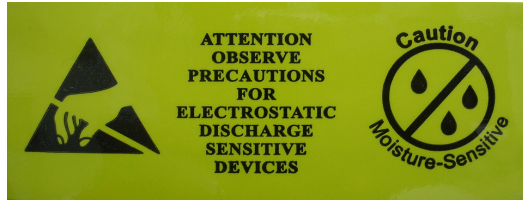





Label B → MSL caution / Storage Condition

	Caution This bag contains MOISTURE-SENSITIVE DEVICES	LEVEL <input type="text"/>
	If blank, see adjacent bar code label	
<ol style="list-style-type: none"> Calculated shelf life in sealed bag: 12 months at <40°C and <90% relative humidity (RH) Peak package body temperature: _____ °C <small>If blank, see adjacent bar code label</small> After bag is opened, devices that will be subjected to reflow solder or other high temperature process must be <ol style="list-style-type: none"> Mounted within: _____ hours of factory conditions <small>If blank, see adjacent bar code label</small> ≤30°C/60% RH, or Stored per J-STD-033 Devices require bake, before mounting, if: <ol style="list-style-type: none"> Humidity Indicator Card reads >10% for level 2a - 5a devices or >60% for level 2 devices when read at 23 ± 5°C 3a or 3b are not met If baking is required, refer to IPC/JEDEC J-STD-033 for bake procedure 		
Bag Seal Date: _____ <small>If blank, see adjacent bar code label</small>		
Note: Level and body temperature defined by IPC/JEDEC J-STD-020		

Label C → Inner box label .

PKG S/N :	 9PKG12013100001
Model:	 XXXXXXXXXX
P/N :	 99P-W01-0048R
Qty :	 1500
Date Code :	 1205
Lot Code :	 T0C102B

Label D → Carton box label .

AMPAK Technology	
Model Name :	 XXXXXXXXXX
Part No :	 99P-W01-0048R
Quantity :	 7500 ea
Lot DIC :	 20081000033
Manufacture :	 2012/02/22

13.2 Dimension

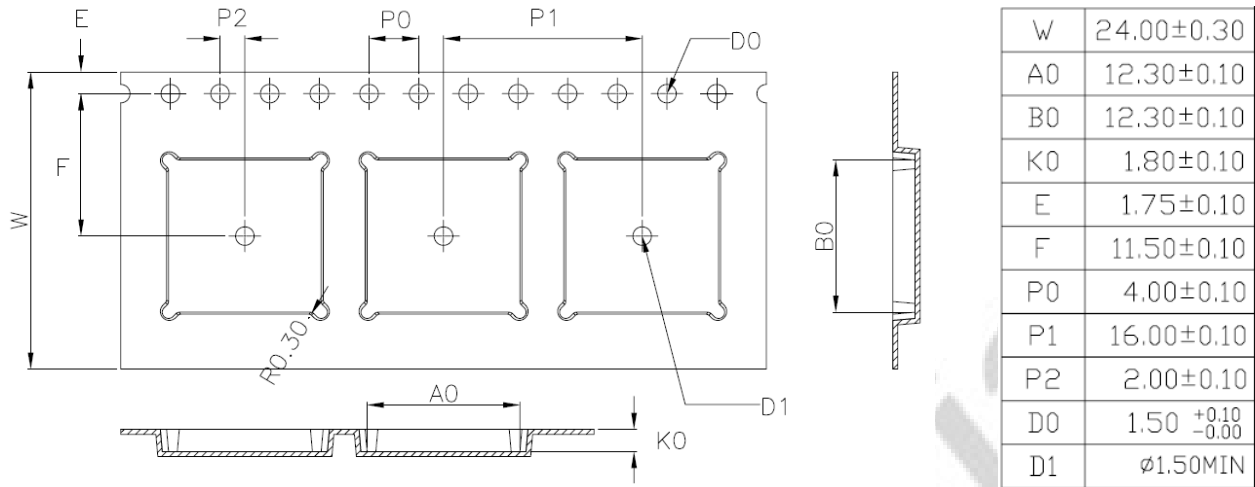

1. 10 sprocket hole pitch cumulative tolerance ±0.20.
2. Carrier camber is within 1 mm in 250 mm.
3. Material : Black Conductive Polystyrene Alloy.
4. All dimensions meet EIA-481-D requirements.
5. Thickness : 0.30±0.05mm.
6. Packing length per 22" reel : 98.5 Meters.(1:3)
7. Component load per 13" reel : 1500 pcs.

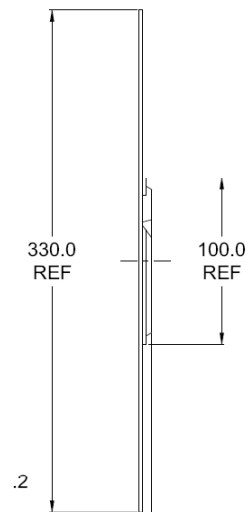
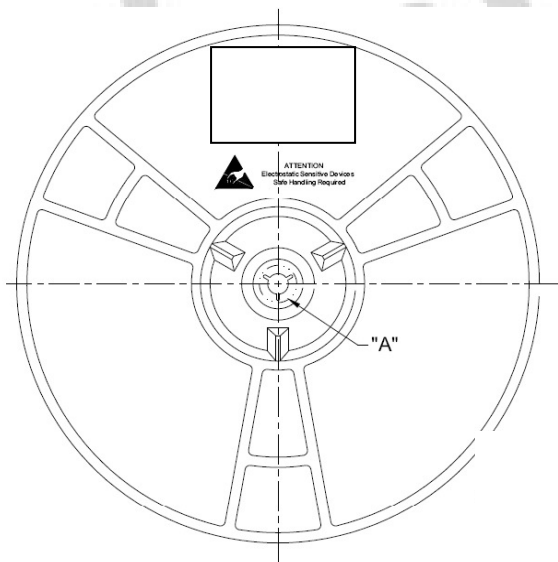

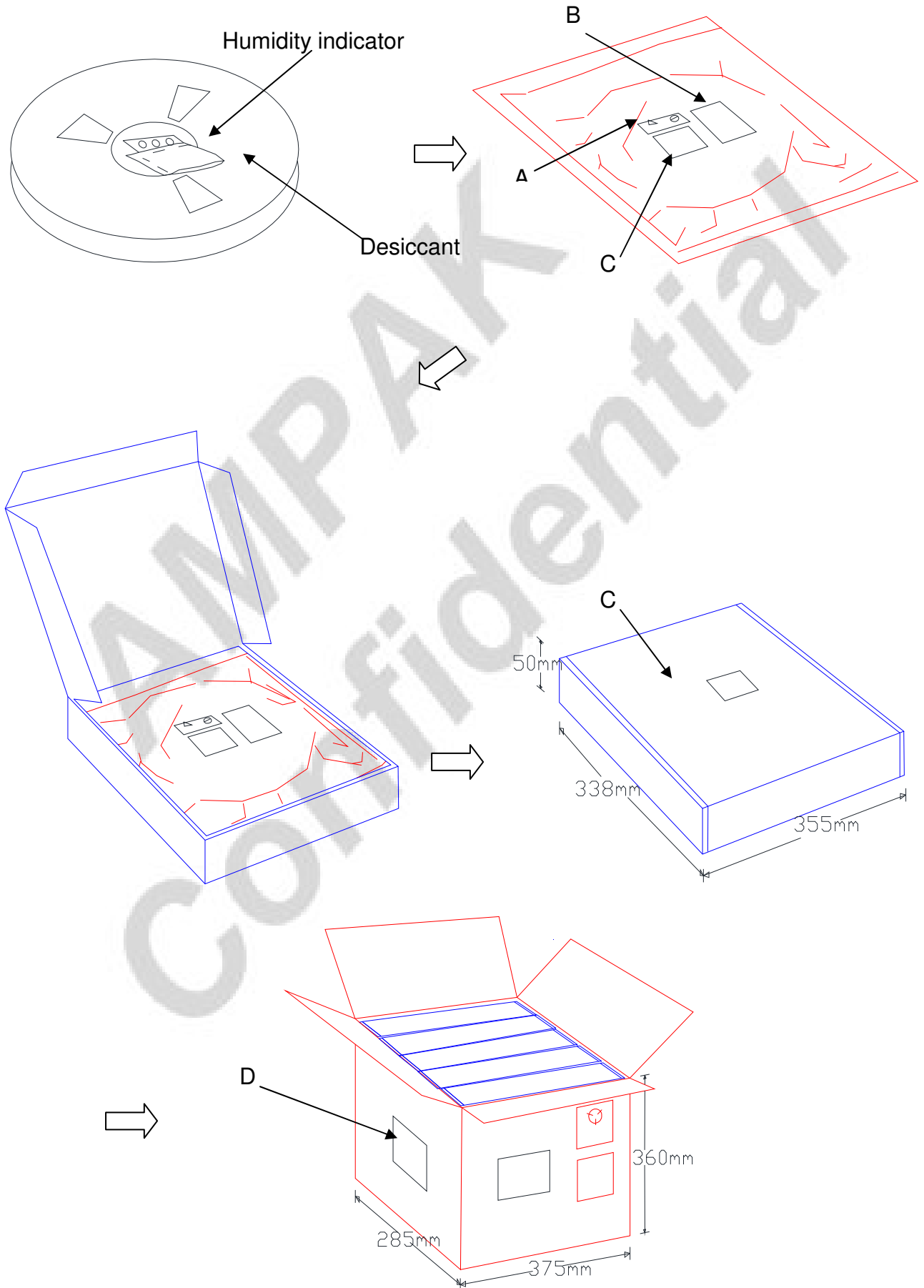

13.3 MSL Level / Storage Condition

	<p>Caution This bag contains MOISTURE-SENSITIVE DEVICES</p> <p>Do not open except under controlled conditions</p> <p>1. Calculated shelf life in sealed bag: 12 months at < 40°C and < 90% relative humidity(RH)</p> <p>2. Peak package body temperature: 225°C 240°C 250°C 260°C <input type="checkbox"/> <input type="checkbox"/> <input checked="" type="checkbox"/> <input type="checkbox"/></p> <p>3. After bag is opened, devices that will be subjected to reflow solder or other high temperature process must a) Mounted within: 48 hours of factory conditions <30°C/60% RH, OR b) Stored at <10% RH</p> <p>4. Devices require bake, before mounting, if: a) Humidity Indicator Card is >10% when read at 23±5°C b) 3a or 3b not met</p> <p>5. If baking is required, devices may be baked for 24 hours at 125±5°C</p> <p>Note : If device containers cannot be subjected to high temperature or shorter bake times are desired, reference IPC/JEDEC J-STD-033 for bake procedure</p> <p>Bag Seal Date: See-SEAL DATE LABEL</p> <p>Note: Level and body temperature defined by IPC/JEDEC J-STD-020</p>	<p>LEVEL</p> <div style="border: 1px solid black; padding: 10px; width: 60px; margin: 0 auto;"> <p style="font-size: 2em; font-weight: bold;">4</p> </div>
---	--	--

※NOTE : Accumulated baking time should not exceed 96hrs

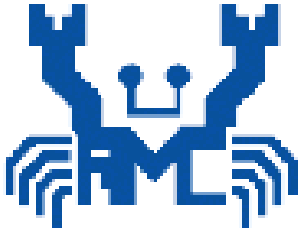

REALTEK

RTL8188EUS

SINGLE-CHIP IEEE 802.11b/g/n 1T1R WLAN

DATASHEET

(CONFIDENTIAL: Development Partners Only)

Rev. 0.2
27 Mar. 2012
Track ID:



Realtek Semiconductor Corp.

No. 2, Innovation Road II, Hsinchu Science Park, Hsinchu 300, Taiwan

Tel.: +886-3-578-0211. Fax: +886-3-577-6047

www.realtek.com

COPYRIGHT

©2011 Realtek Semiconductor Corp. All rights reserved. No part of this document may be reproduced, transmitted, transcribed, stored in a retrieval system, or translated into any language in any form or by any means without the written permission of Realtek Semiconductor Corp.

DISCLAIMER

Realtek provides this document “as is”, without warranty of any kind. Realtek may make improvements and/or changes in this document or in the product described in this document at any time. This document could include technical inaccuracies or typographical errors.

TRADEMARKS

Realtek is a trademark of Realtek Semiconductor Corporation. Other names mentioned in this document are trademarks/registered trademarks of their respective owners.

USING THIS DOCUMENT

This document is intended for the software engineer’s reference and provides detailed programming information.

Though every effort has been made to ensure that this document is current and accurate, more information may have become available subsequent to the production of this guide.

REVISION HISTORY

Revision	Release Date	Summary
0.2	2012/3/27	Preliminary release

Table of Contents

1. GENERAL DESCRIPTION	1
2. FEATURES	3
3. APPLICATION DIAGRAM.....	5
3.1. SINGLE-BAND 11N (1X1) SOLUTION WITH SINGLE ANTENNA	5
3.2. SINGLE-BAND 11N (1X1) SOLUTION WITH DUAL ANTENNA DIVERSITY	6
3.3. SINGLE-BAND 11N (1X1) SOLUTION WITH DUAL ANTENNA.....	6
4. PIN ASSIGNMENTS.....	7
4.1. PACKAGE IDENTIFICATION	7
5. PIN DESCRIPTIONS.....	7
5.1. USB BUS TRANSCEIVER INTERFACE.....	8
5.2. POWER PINS	8
5.3. RF INTERFACE	8
5.4. LED INTERFACE.....	9
5.5. CLOCK AND OTHER PINS.....	10
6. ELECTRICAL AND THERMAL CHARACTERISTICS.....	11
6.1. TEMPERATURE LIMIT RATINGS	11
6.2. DC CHARACTERISTICS	11
6.2.1. Power Supply Characteristics.....	11
6.2.2. Digital IO Pin DC Characteristics.....	11
7. INTERFACE TIMING SPECIFICATION	13
7.1. USB BUS DURING POWER ON SEQUENCE	13
8. MECHANICAL DIMENSIONS.....	14
8.1. MECHANICAL DIMENSIONS NOTES	14
9. ORDERING INFORMATION	15

List of Tables

TABLE 1. USB BUS TRANSCEIVER INTERFACE.....	8
TABLE 2. POWER PINS	8
TABLE 3. RF INTERFACE	8
TABLE 4. LED INTERFACE.....	9
TABLE 5. CLOCK AND OTHER PINS	10
TABLE 6. TEMPERATURE LIMIT RATINGS	11
TABLE 7. DC CHARACTERISTICS	11
TABLE 8. 3.3V GPIO DC CHARACTERISTICS	11
TABLE 9. 2.8V GPIO DC CHARACTERISTICS	11
TABLE 10. 1.8V GPIO DC CHARACTERISTICS	12
TABLE 11. THE TYPICAL TIMING RANGE	13
TABLE 12. ORDERING INFORMATION.....	15

List of Figures

FIGURE 1. SINGLE-BAND 11N (1X1) SOLUTION.....	5
FIGURE 2. SINGLE-BAND 11N (1X1) DUAL ANTENNA DIVERSITY SOLUTION.....	6
FIGURE 3. SINGLE-BAND 11N (1X1) DUAL ANTENNA SOLUTION.....	6
FIGURE 4. PIN ASSIGNMENTS	7
FIGURE 5. RTL8188EUS USB BUS POWER ON SEQUENCE.....	13

1. General Description

The Realtek RTL8188EUS is a highly integrated single-chip 802.11n Wireless LAN (WLAN) network USB interface (USB 1.0/1.1/2.0 compliant) controller. It combines a WLAN MAC, a 1T1R capable WLAN baseband, and WLAN RF in a single chip. The RTL8188EUS provides a complete solution for a high throughput performance integrated wireless LAN device.

The RTL8188EUS WLAN baseband implements Orthogonal Frequency Division Multiplexing (OFDM) with 1 transmit and 1 receive path and is compatible with the IEEE 802.11n specification. Features include one spatial stream transmission, short guard interval (GI) of 400ns, spatial spreading, and transmission over 20MHz and 40MHz bandwidth.

For legacy compatibility, Direct Sequence Spread Spectrum (DSSS), Complementary Code Keying (CCK) and OFDM baseband processing are included to support all IEEE 802.11b and 802.11g data rates. Differential phase shift keying modulation schemes, DBPSK and DQPSK with data scrambling capability, are available, and CCK provides support for legacy data rates, with long or short preamble. The high-speed FFT/IFFT paths, combined with BPSK, QPSK, 16QAM, and 64QAM modulation of the individual subcarriers and rate compatible punctured convolutional coding with coding rate of 1/2, 2/3, 3/4, and 5/6, provide higher data rates of 54Mbps and 150Mbps for IEEE 802.11g and 802.11n OFDM respectively.

The RTL8188EUS WLAN Controller builds in an enhanced signal detector, an adaptive frequency domain equalizer, and a soft-decision Viterbi decoder to alleviate severe multi-path effects and mutual interference in the reception of multiple streams.

Efficient IQ-imbalance, DC offset, phase noise, frequency offset, and timing offset compensations are provided for the radio frequency front-end. Selectable digital transmit and receive FIR filters are provided to meet transmit spectrum mask requirements and to reject adjacent channel interference, respectively.

The RTL8188EUS WLAN Controller supports fast receiver Automatic Gain Control (AGC) with synchronous and asynchronous control loops among antennas, antenna diversity functions, and adaptive transmit power control function to obtain the better performance in the analog portions of the transceiver.

The RTL8188EUS WLAN MAC supports 802.11e for multimedia applications, 802.11i for security, and 802.11n for enhanced MAC protocol efficiency. Using packet aggregation techniques such as A-MPDU

with BA and A-MSDU, protocol efficiency is significantly improved. Power saving mechanisms such as Legacy Power Save, and U-APSD, reduce the power wasted during idle time, and compensates for the extra power required to transmit OFDM. The RTL8188EUS provides simple legacy and 20MHz/40MHz co-existence mechanisms to ensure backward and network compatibility.

2. Features

General

- 46-pin QFN
- CMOS MAC, Baseband PHY, and RF in a single chip for IEEE 802.11b/g/n compatible WLAN
- Complete 802.11n solution for 2.4GHz band
- 72.2Mbps receive PHY rate and 72.2Mbps transmit PHY rate using 20MHz bandwidth
- 150Mbps receive PHY rate and 150Mbps transmit PHY rate using 40MHz bandwidth
- Compatible with 802.11n specification
- Backward compatible with 802.11b/g devices while operating in 802.11n mode

Interface

- Complies with USB 1.0/1.1/2.0 for WLAN

Standards Supported

- IEEE 802.11b/g/n compatible WLAN
- IEEE 802.11e QoS Enhancement (WMM)
- 802.11i (WPA, WPA2). Open, shared key, and pair-wise key authentication services

WLAN MAC Features

- Frame aggregation for increased MAC efficiency (A-MSDU, A-MPDU)
- Low latency immediate High-Throughput Block Acknowledgement (HT-BA)
- PHY-level spoofing to enhance legacy compatibility

- Power saving mechanism
- Channel management and co-existence
- Transmit Opportunity (TXOP) Short Inter-Frame Space (SIFS) bursting for higher multimedia bandwidth

WLAN PHY Features

- IEEE 802.11n OFDM
- One Transmit and one Receive path (1T1R)
- 20MHz and 40MHz bandwidth transmission
- Short Guard Interval (400ns)
- DSSS with DBPSK and DQPSK, CCK modulation with long and short preamble
- OFDM with BPSK, QPSK, 16QAM, and 64QAM modulation. Convolutional Coding Rate: 1/2, 2/3, 3/4, and 5/6
- Maximum data rate 54Mbps in 802.11g and 150Mbps in 802.11n
- Hardware antenna diversity in per packet base
- Selectable receiver FIR filters
- Programmable scaling in transmitter and receiver to trade quantization noise against increased probability of clipping
- Fast receiver Automatic Gain Control (AGC)
- On-chip ADC and DAC

Peripheral Interfaces

- General Purpose Input/Output (8 pins)
- Three configurable LED pins

3. Application Diagram

3.1. Single-Band 11n (1x1) Solution with Single Antenna

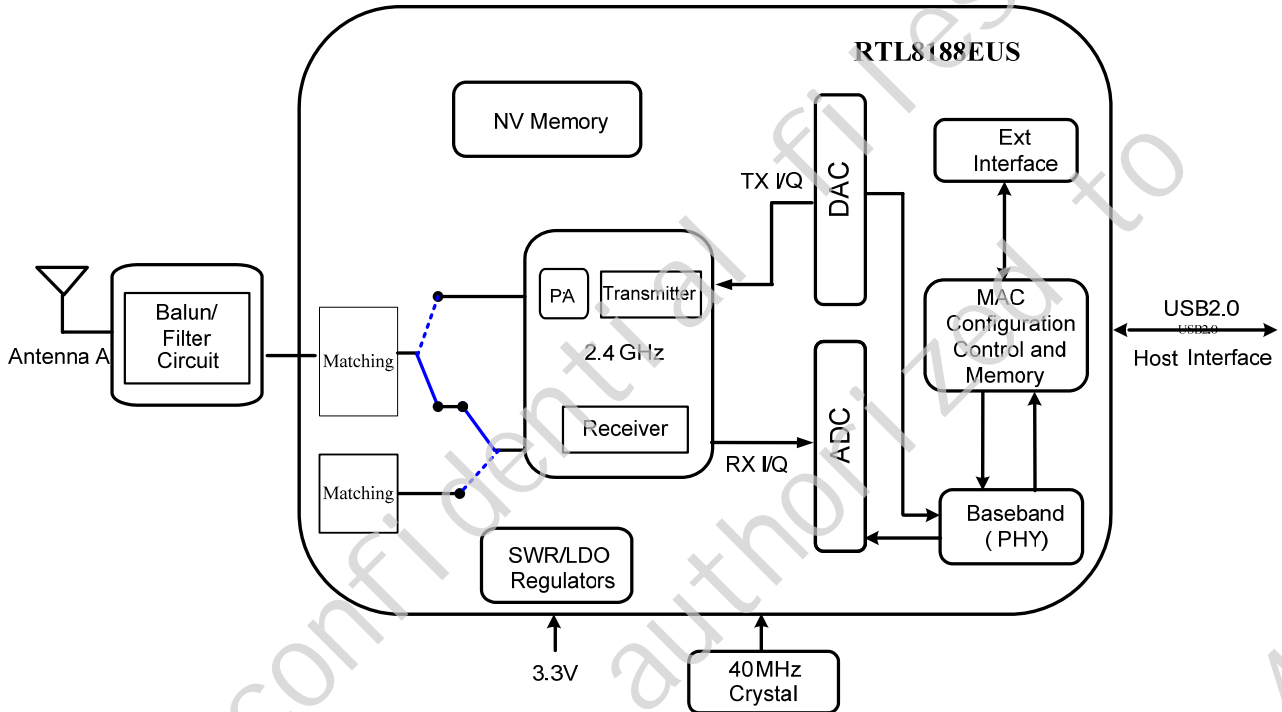

Figure 1. Single-Band 11n (1x1) Solution

3.2. Single-Band 11n (1x1) Solution with Transmit & Receive Diversity

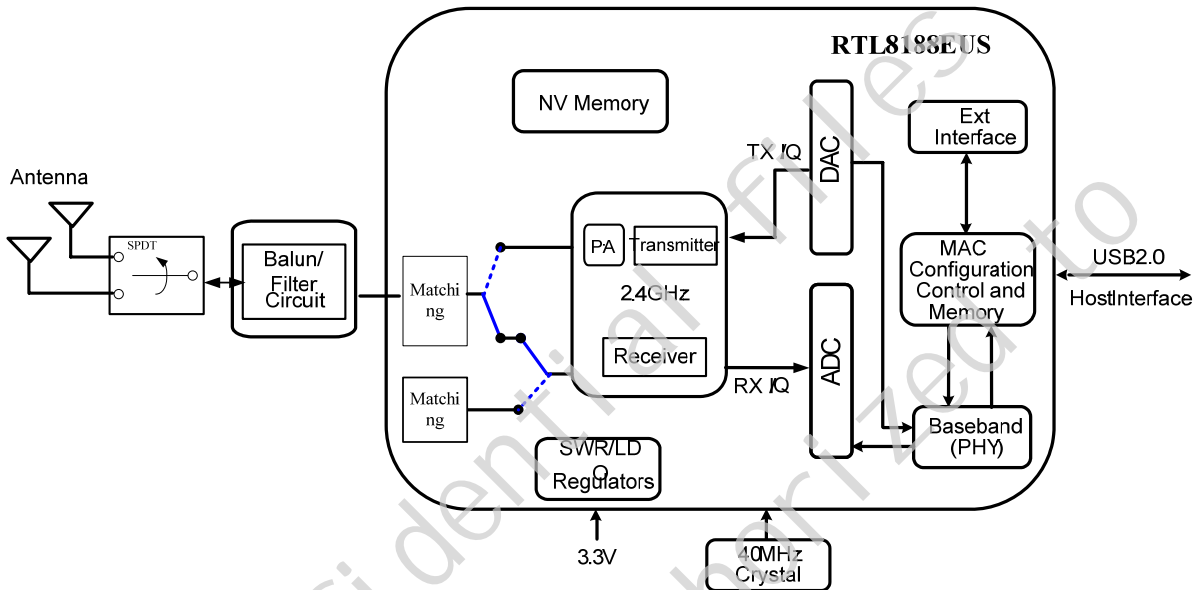

Figure 2. Single-Band 11n (1x1) Transmit & Receive Diversity solution

3.3. Single-Band 11n (1x1) Solution with Transmit & Receive Diversity

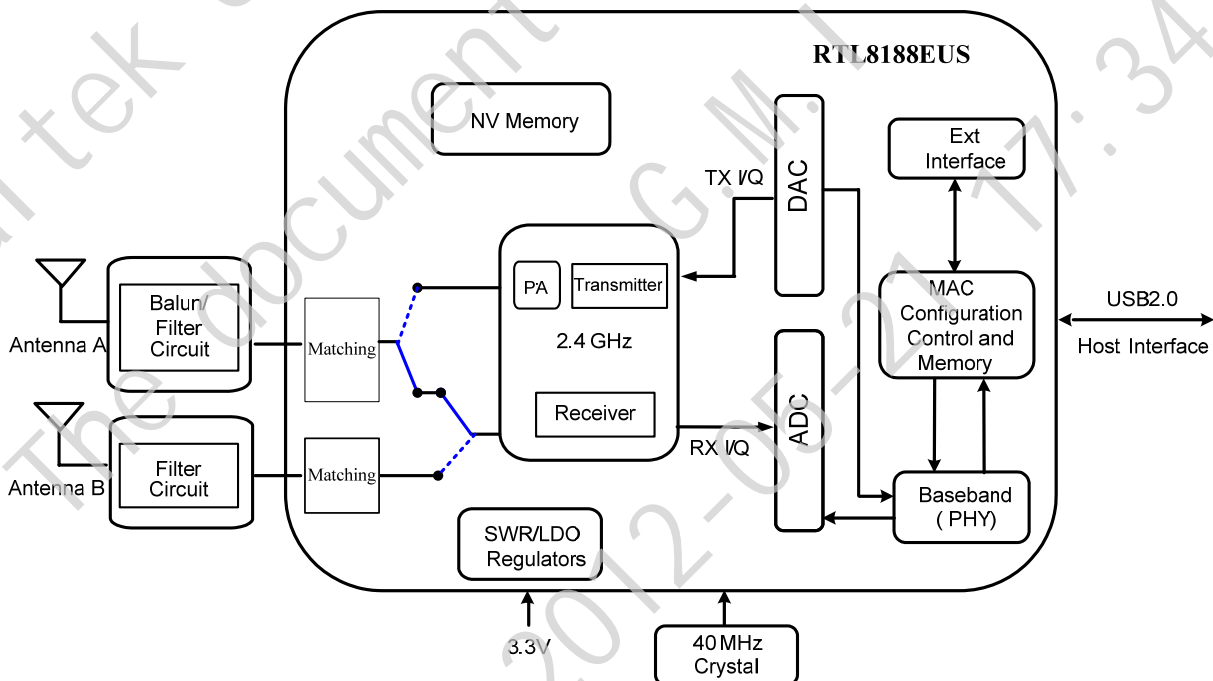

Figure 3. Single-Band 11n (1x1) Transmit & Receive Diversity sSolution

4. Pin Assignments

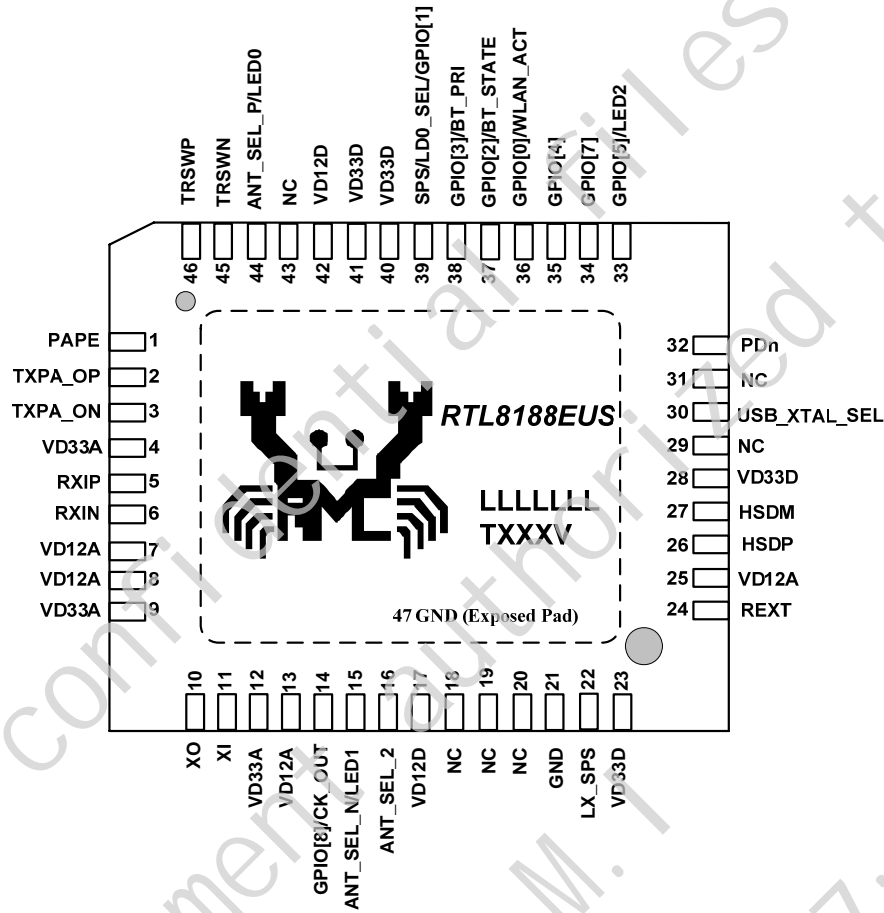

Figure 4. Pin Assignments

4.1. Package Identification

'Green' package is indicated by a 'G' in the location marked 'T' in Figure 4.

5. Pin Descriptions

The following signal type codes are used in the tables:

I: Input

O: Output

T/S: Tri-State bi-directional input/output pin

S/T/S: Sustained Tri-State

O/D: Open Drain

P: Power pin

5.1. USB Bus Transceiver Interface

Table 1. USB bus Transceiver Interface

Symbol	Type	Pin No	Description
HSDM/HSDP	I	27/26	USB Receive Differential Pair

5.2. Power Pins

Table 2. Power Pins

Symbol	Type	Pin No	Description
LX_SPS	P	22	Switching Regulator Output
VD33A	P	4,9,12,	VDD 3.3V for Analog
VD33D	P	23,28,40,41	VDD 3.3V for Digital
VD12A	P	7,8,13,25	Analog 1.2V Regulator Output
VD12D	P	17,42	Digital 1.2V Regulator Output
GND	P	21,47	Ground

5.3. RF Interface

Table 3. RF Interface

Symbol	Type	Pin No	Description
TRSWN	O	45	Transmit/Receive Shared with LED2, can be selected by control register
PAPE	O	1	2.4GHz Transmit Power Amplifier Power Enable 0
TRSWP	O	46	Transmit/Receive
TXPA_OP	O	2	RF TX Negative Signal
TXPA_ON	O	3	RF TX Positive Signal
RX_IP	I	5	RF RX Positive Signal
RX_IN	I	6	RF RX Negative Signal
ANT_SEL_P	O	44	Antenna Control Positive Signal Shared with LED0, can be selected by control register
ANT_SEL_N	O	15	Antenna Control Negative Signal Shared with LED1, can be selected by control register
ANT_SEL_2	O	16	Antenna Control Extend Signal

5.4. LED Interface

Table 4. LED Interface

Symbol	Type	Pin No	Description
LED0	O	44	LED Pins (Active Low) Shared with ANT_SEL_P, can be selected by control register
LED1	O	15	LED Pins (Active Low) Shared with ANT_SEL_N, can be selected by control register
LED2	O	33	LED Pins (Active Low) Shared with GPIO5, can be selected by control register

5.5. Clock and Other Pins

Table 5. Clock and Other Pins

Symbol	Type	Pin No	Description
XI	I	11	25/40MHz OSC Input Input of 25/40MHz Crystal clock reference
XO	O	10	Output of 25/40MHz Crystal Clock Reference
PDn	I	32	This Pin can Externally Shutdown RTL8188CE without Extra Power Switch
REXT	O	24	Band gap. It needs to link 24k resistor pull down.
USB_XTAL_SEL	I	30	Trap Function: Decide to use the 25/40Mhz crystal by this pin power on latch low or high. USB_XTAL_SEL = 1, XTAL frequency is 40MHz USB_XTAL_SEL = 0, XTAL frequency is 25MHz
GPIO0/WLAN_ACT	IO	36	General Purpose Input/Output Pin or Bluetooth Coexistence WLAN_ACT Pin The WLAN_ACT signal indicates when WLAN is either transmitting or receiving in the 2.4GHz ISM band.
GPIO1/ (SPS/LDO_SEL mode)	IO	39	Trap Function: Decide to use the SWR or LDO for 3.3V -> 1.2V by this pin power on latch low or high. LDO_SPS_SEL = 0, use SWR LDO_SPS_SEL = 1, use LDO General Purpose Input/Output Pin or Bluetooth Coexistence WLAN_RX Pin.
GPIO2/BT_STATE	IO	37	General Purpose Input/Output Pin or Bluetooth Coexistence BT_STAT Pin The BTSTAT signal indicates when normal Bluetooth packets are being transmitted or received.
GPIO3/BT_PRI	IO	38	General Purpose Input/Output Pin or Bluetooth Coexistence BT_PRI Pin The BTPRI signal indicates when a high priority Bluetooth packet is being transmitted or received.
GPIO4	IO	35	General Purpose Input/Output Pin
GPIO5/LED2	IO	33	General Purpose Input/Output Pin Shared with LED2, can be selected by control register
GPIO7	IO	34	This pin can also support WLAN Radio off function with host interface remaining connected.
GPIO8/CK_OUT	IO	14	General Purpose Input/Output Pin Buffered 25/40M clock outputs for other peripheral IC
NC	NA	18,19,20,29,31,43	No connect. Let it open.

6. Electrical and Thermal Characteristics

6.1. Temperature Limit Ratings

Table 6. Temperature Limit Ratings

Parameter	Minimum	Maximum	Units
Storage Temperature	-55	+125	°C
Ambient Operating Temperature	0	70	°C
Junction Temperature	0	125	°C

6.2. DC Characteristics

6.2.1. Power Supply Characteristics

Table 7. DC Characteristics

Symbol	Parameter	Minimum	Typical	Maximum	Units
VD33A, VD33D	3.3V I/O Supply Voltage	3.0	3.3	3.6	V
VD12A, VD12D	1.2V Core Supply Voltage	1.10	1.2	1.32	V
VD15A, VD15D	1.5V Supply Voltage	1.425	1.5	1.575	V
IDD33	3.3V Rating Current	-	-	600	mA

6.2.2. Digital IO Pin DC Characteristics

Table 8. 3.3V GPIO DC Characteristics

Symbol	Parameter	Minimum	Normal	Maximum	Units
V _{IH}	Input high voltage	2.0	3.3	3.6	V
V _{IL}	Input low voltage	--	0	0.9	V
V _{OH}	Output high voltage	2.97	--	3.3	V
V _{OL}	Output low voltage	0	--	0.33	V

Table 9. 2.8V GPIO DC Characteristics

Symbol	Parameter	Minimum	Normal	Maximum	Units
V _{IH}	Input high voltage	1.8	2.8	3.1	V
V _{IL}	Input low voltage	--	0	0.8	V
V _{OH}	Output high voltage	2.5	--	3.1	V
V _{OL}	Output low voltage	0	--	0.28	V

Table 10. 1.8V GPIO DC Characteristics

Symbol	Parameter	Minimum	Normal	Maximum	Units
V _{IH}	Input high voltage	1.7	1.8	2.0	V
V _{IL}	Input low voltage	--	0	0.8	V
V _{OH}	Output high voltage	1.62	--	1.8	V
V _{OL}	Output low voltage	0	--	0.18	V

7. Interface Timing Specification

7.1. USB Bus during Power On Sequence

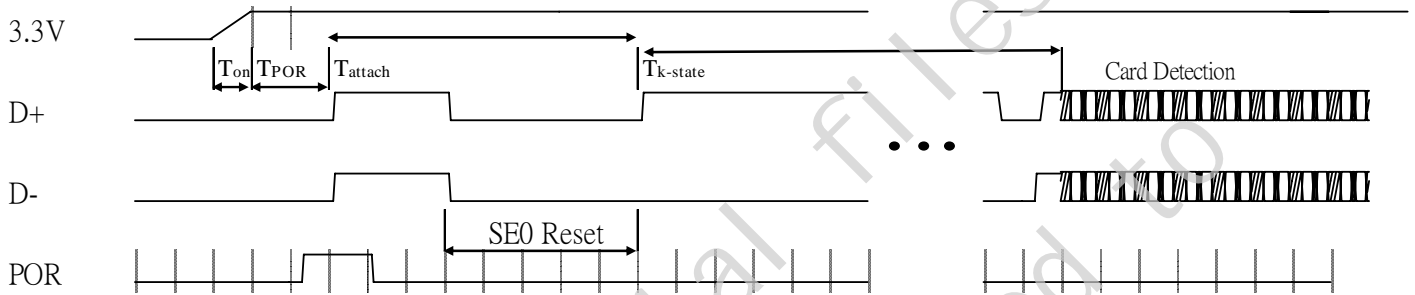

Figure 5. RTL8188EUS USB Bus Power On Sequence

T_{on}: The main power ramp up duration

T_{por}: The power on reset releases and power management unit executes power on tasks

T_{attach}: USB attach state

T_{k-state}: the duration from resistor attached to USB host starting card detection procedure

The power on flow description:

After main 3.3V ramp up, the internal power on reset is released by power ready detection circuit and the power management unit will be enabled. The power management unit enables the internal regulator and clock circuits.

The power management unit also enables the USB circuits.

USB analog circuits attach resistors to indicate the insertion of the USB device

Table 11. The typical timing range

	Unit	Min	Typical	Max
T_{on}	ms	--	1.5	5
T_{por}	ms	--	2	10
T_{attach}	ms	2	7	15
T_{k-state}	ms	50	250	-

8. Mechanical Dimensions

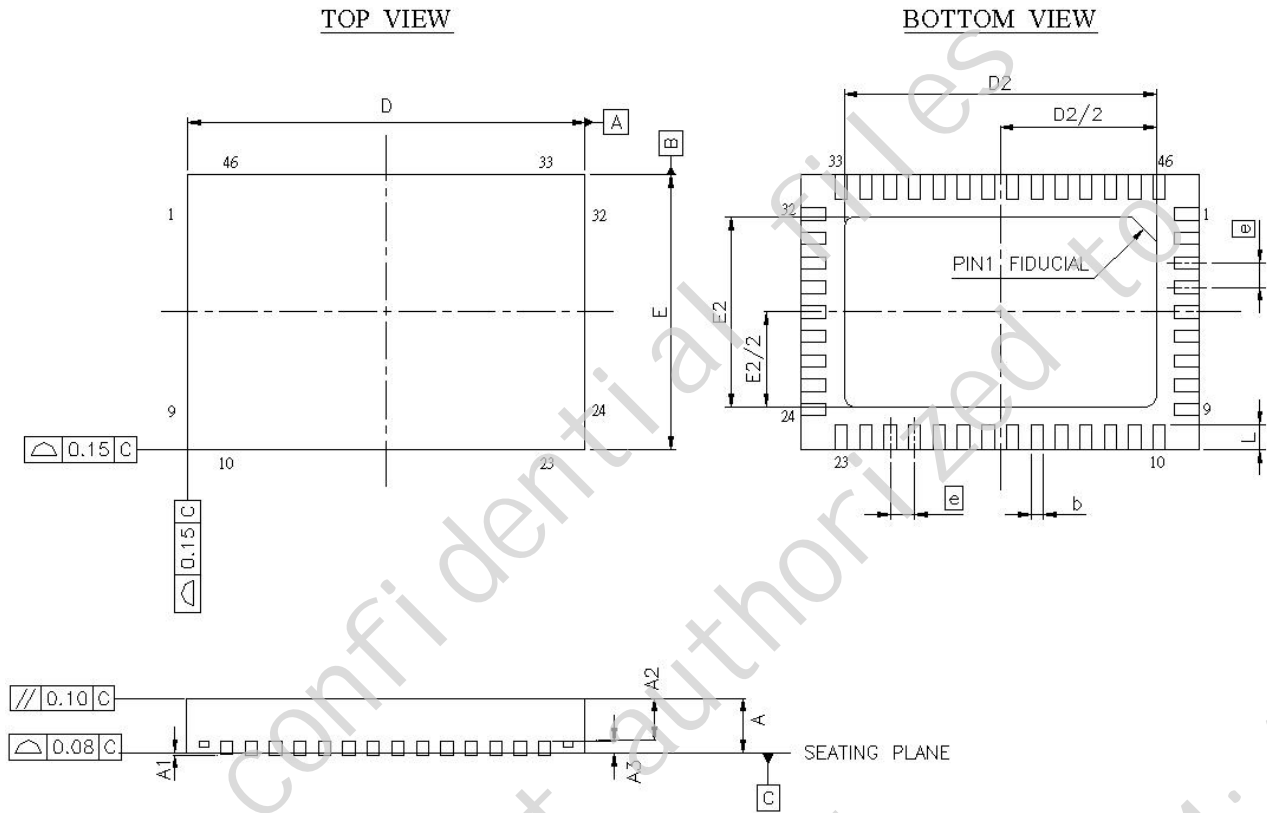

8.1. Mechanical Dimensions Notes

Symbol	Dimension in mm			Dimension in inch		
	Min	Nom	Max	Min	Nom	Max
A	0.75	0.85	1.00	0.030	0.034	0.039
A ₁	0.00	0.035	0.05	0.000	0.001	0.002
A ₂	0.55	0.65	0.80	0.022	0.026	0.032
A ₃	0.20 REF			0.008 REF		
b	0.15	0.20	0.25	0.006	0.008	0.010
D	6.50BSC			0.256BSC		
D2	4.85	5.1	5.35	0.191	0.201	0.211
E	4.5BSC			0.177BSC		
E2	2.25	2.5	2.75	0.088	0.098	0.108
e	0.40BSC			0.016BSC		
L	0.30	0.40	0.50	0.012	0.016	0.020

Notes :

1. CONTROLLING DIMENSION : MILLIMETER (mm).
2. REFERENCE DOCUMENTL : JEDEC MO-220.

9. Ordering Information

Table 12. Ordering Information

Part Number	Package	Status
RTL8188EUS-CG	QFN-46, 'Green' Package	Engineering Samples

Note: See page 7 for package identification.

Realtek Semiconductor Corp.**Headquarters**

No. 2, Innovation Road II, Hsinchu Science Park,
Hsinchu 300, Taiwan, R.O.C.

Tel: 886-3-5780211 Fax: 886-3-5776047

www.realtek.com