



# ***HS-SERIES***

2.4GHz FPV real-time video and image transmission Quad-copter

## **Instruction Manual**



- In order to make sure that it can meet the electromagnetic environment standard required by Aerial Radio Station, by taking the center point of the runway as the center of a circle, all kinds of R/C models are FORBIDDEN to be used within the radius of 5000 meters. During the period of the Radio Regulation Command formulated, all the related departments and authorities should STOP using the transmitter for this model within this area.
- Please refer to this Instruction Manual for either HS110W Model or HS200W, since both models are equipped with the same functions.(In case of discrepancy in the model color, the version for sale on-line shall prevail.)

# Table of Contents

1. Preface&Warning.....	1
2. Maintenance.....	2
3. Parts of the Model.....	3
4. The Remote Control.....	3
5. Charge the lithium battery.....	4
6. Preparation before taking off.....	4
7. Take Off.....	4
8. LED Display on the remote control.....	5
9. Altitude Hold Mode.....	5
10. Flight operations.....	6
11. Headless Mode.....	6
12. One Key Return.....	7
13. 3D Rolling.....	7
14. Assemble the camera.....	8
15. Assemble the phone holder.....	8
16. Download the App.....	8
17. App instructions.....	9
18. Mobile Phone control.....	9
19. Trouble shooting.....	10
20. Table of parts.....	10

## HIGHLIGHT OF THIS PRODUCT:

- One-Key START function.
- Auto switch-off function, the standby time is about 10 minutes.
- Altitude Hold function.
- FPV Camera function for real time view.
- Gravity Sensor function with the App in flight.



scan to visit our stores  
& to subscribe us on youtube

 [USA@HOLYSTONE.COM](mailto:USA@HOLYSTONE.COM) (America)  
[CA@HOLYSTONE.COM](mailto:CA@HOLYSTONE.COM) (Canada)

 +1 (626) 465-7134

 [WWW.HOLYSTONE.COM](http://WWW.HOLYSTONE.COM)

## ***Preface***

*To make your experience with this drone as straightforward and convenient as possible, please read this instruction manual carefully before operation. Keep it safe for future reference to ensure continued, safe and enjoyable use of your drone.*

## ***Important Statement***

- 1.This product is not just a toy. It is a high precision quadcopter integrating various electronic stability and control mechanisms. This drone requires careful and correct assembly and setup to ensure safe, accident free operation. This equipment should be operated in a safe and controlled way at all times. Incorrect or dangerous operation may cause damage to the device or property, or cause serious injury to those in the vicinity.
- 2.This product is suitable for experienced drone pilots over 14 years of age.
- 3.In case of difficulties with any aspect of the product, operation or maintenance, please contact your local sales agent or contact customer services here at Holy Stone.

## ***Safety Guidelines***

This product is a flying camera that offers easy, controllable flight when in good working order, however it is also a significant risk to property and people if flown irresponsibly or within confined spaces. Incorrect assembly or poor control by inexperienced pilots can result in damage to property or harm to people in an unexpected accident. Be fully aware of your surroundings when flying and always maintain complete control of the vehicle at all times.

### **1.Keep Your Distance**

- ★Always fly in locations that are clear of any obstructions, such as buildings, pylons, trees and so on
- ★Never fly above or near to a large crowd of people

### **2.Do not fly in adverse weather conditions**

- ★Keep clear of moisture, heavy rain, ice and excessive wind.
- ★Fly in moderate weather conditions only

### **3.Use and maintain the product according to the instructions**

- ★Operate this device legally in accordance with instructions provided within
- ★Always use original parts made by Holy Stone for maintenance and repair

### **4.Do not operate the device alone**

- ★If you are a new pilot, seek assistance from an experienced drone pilot as you learn
- ★Have others around to help you fly at all times

### **5.Safety First every time**

- ★Always operate the drone within your limits as a pilot. If you are ill, disoriented, or unsure of how to effectively fly the drone please seek help as this can lead to danger, damage or injury.

### **6.Keep clear of rotating parts**

- ★During operation the rotors revolve extremely quickly, please avoid contact with the blades and ensure that foreign objects are kept clear of all moving parts.

### **7.Avoid exposure to excessive heat**

- ★Due to the numerous material types used in construction, this drone is not suitable for exposure to heat. Please keep your device away from heat sources and avoid prolonged exposure to direct sunlight. High temperatures can distort the structure of the device, please check for such damage before flying.

## **Warning**

- 1.The information and guidance within this package and instruction manual is important for the safe operation and maintenance of your drone. Please keep it safe for future reference.
- 2.You accept sole responsibility for any injury, loss or damage that result from your operation of the device.
- 3.Always follow the instructions when assembling or operating the drone. Always keep at least 2 meters between the user or viewers and the model to avoid risk of injury. Pay attention to the device at all times while in flight.
- 4.Neither Holy Stone nor any distributors or agents accept any responsibility for loss, injury or damage caused by incorrect operation of the drone.
- 5.This drone is not suitable for children under the age of 14, and should always be operated under supervision for young pilots.
- 6.Please ensure assembly instructions are followed correctly to ensure proper operation and performance of your drone.
- 7.This product contains small parts. To avoid any choking hazard, please keep this drone and all components out of the reach of children.
- 8.You must not under any circumstances fly this drone over open water or near public highways to avoid risk of accident.
- 9.Keep all packaging materials away from children and dispose safely.
- 10.The internals of the drone are not user serviceable, please do not attempt to disassemble this drone or re-equip any part of the drone, to avoid malfunctions during flight.
- 11.Please ensure batteries are fitted in the correct orientation as shown in these instructions.
- 12.You can access the transmitter battery compartment by unscrewing the screws on the battery cover. Insert batteries ensuring they are in the right orientation. Always replace battery cover and tighten the screws to secure before use.
- 13.Only use the charger provided with your drone for safety.
- 14.The charger is not a toy.
- 15.Always pay close attention to battery polarity when inserting any batteries to make sure they are fitted correctly.
- 16.Use either rechargeable or non-rechargeable 'AA' batteries in the transmitter.
- 17.Use only recommended batteries in the transmitter, please remember that non-rechargeable batteries must not be charged.
- 18.For rechargeable batteries, always follow manufacturer's instructions and have adult supervision. Do not leave charging batteries unsupervised and as batteries get hot when charging, avoid any combustible material.
- 19.Avoid short circuits by fitting the batteries incorrectly, and do not crush or squash batteries as this carries a risk of explosion.
- 20.Do not mix new and old batteries as this can lead to unpredictable performance.
- 21.Dispose of used batteries carefully, do not litter.
- 22.The power socket must not be removed from this drone. Do not attempt to short circuit the connecting socket.
- 23.When disposing of batteries do not throw on fires, leave to decompose. Keep clear of heat sources and high temperatures at all times.
- 24.If the device is not going to be used for an extended period, remove batteries to prevent potential damage from battery leakage.
- 25.Care should be taken to keep your drone away from sources of magnetic interference or other electrical equipment to prevent signal issues during operation.
- 26.Keep clear of rotating parts and beware of loose clothing that could become entangled in the rotors causing injury.
- 27.Do not shoot the light beam directly at other people or yourself.
- 28.Be aware of the volume of noise the drone produces. Keep your distance to avoid ear damage.
- 29.The charge socket uses a mini USB 5V connection.
- 30.Always use the product in compliance with local aviation radio rules and comply with local authorities should they require you to refrain from operating at any time.

## **Maintenance**

- 1.Clean the product after each use with a clean, soft cloth.
- 2.Avoid prolonged exposure to direct sunlight and avoid heat buildup in the drone.
- 3.This device is not waterproof and must not be submerged in water under any circumstances. Failure of the unit will result from water contamination.
- 4.Check the charging plug and other accessories for signs of damage frequently. If any part of the device is damaged refrain from flying until maintenance can be carried out.



## PARTS NAME

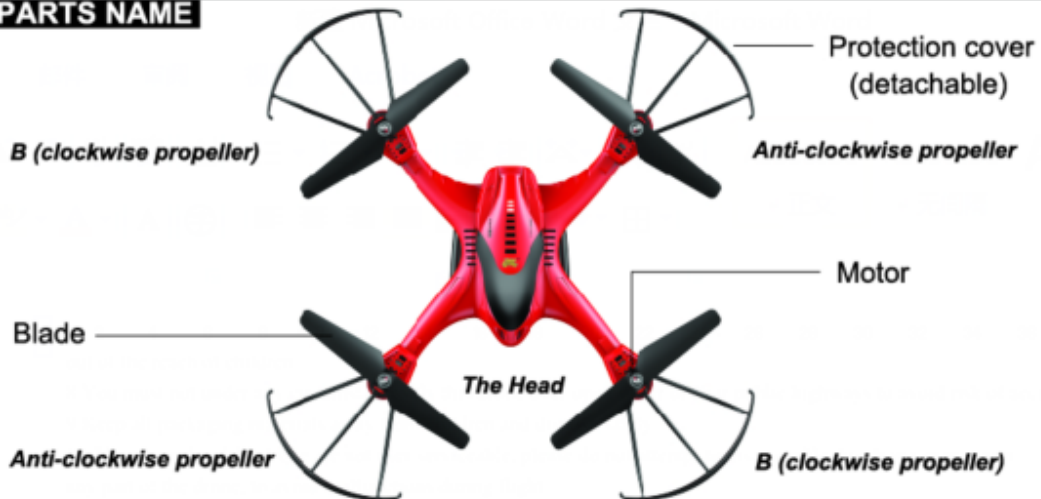

**⚠** Please note that all the propellers must be installed in the right orientation. (counterclockwise/clockwise adjacent, pay attention to the letter printed on each blade)

## REMOTE CONTROL & FUNCTIONS

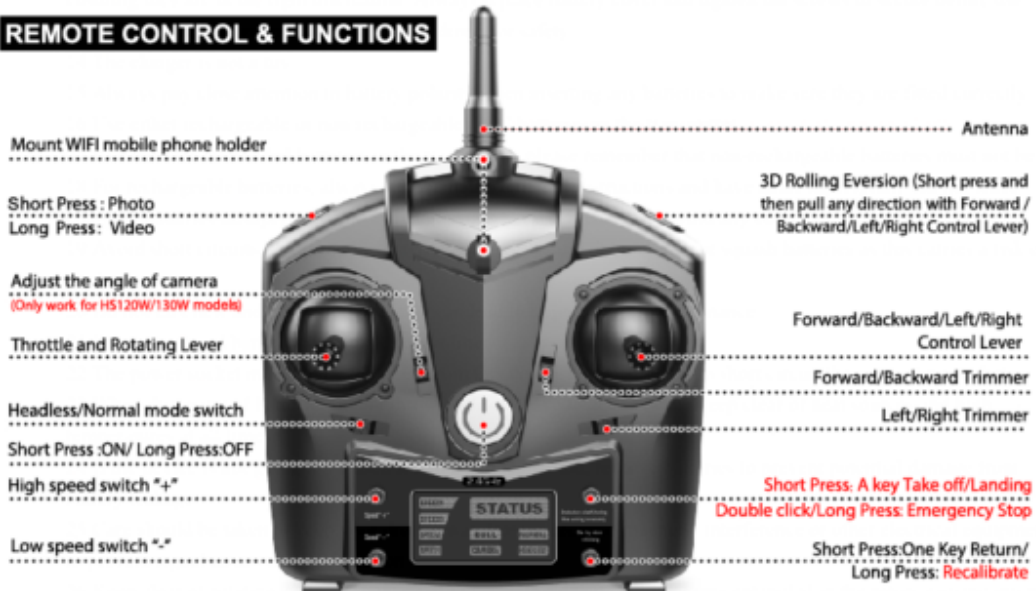

## ASSEMBLE THE REMOTE CONTROL

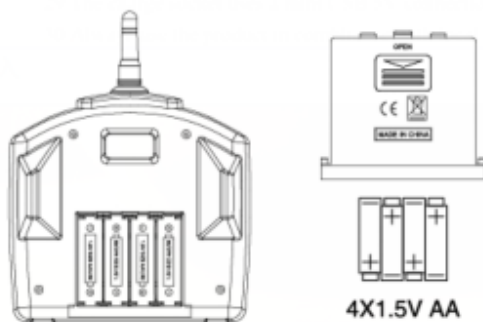

Take out the battery cover from the back of remote control, and install 4 batteries (size AA) into the battery case correctly (Refer to the picture), then shut the battery cover.

### Tips:

- (1) When installing the battery, follow the electrode instructions, and do not load the batteries reversely.
- (2) Don't mix new battery with old.
- (3) Don't use different types of batteries.

## CHARGING THE LITHIUM BATTERY:

1. Balanced charging: Switch off the power of the transmitter, please insert the USB port of the charger into the USB port of the computer, and then connect another end of the charger with the charging port of the drone. (see the picture below) When charging, the indicator of the drone is shown as red light. When it is fully charged, the indicator will be OFF and the charging process is finished.
2. You can use the mobile charger or car-loaded power to charge it.
3. It takes around 60 minutes to fully charge the battery. The flight time for a fully charged battery is around 8 minutes.



### CAUTIONS FOR CHARGING

1. When charging, please put this product on a dried or ventilated area and keep it far away from heat source or explosive product.
2. After flying, please do not charge the battery if it is still hot.
3. If the battery has been used for a long time, please replace them.
4. Please make sure that you use the original USB charger cable provided. When the battery has been used for a long time, or appears to be swollen, please replace them.
5. If a battery is not used for a long time, it would lose the power by itself. Charging or discharging too often may reduce the lifetime of the battery.

## PREPARATION BEFORE TAKE OFF:

1. Fly the quadcopter in a spacious indoors area, or an outdoors area free of obstacles, rain, snow, animals, and people. When flying outdoors, make sure there isn't too much wind.
2. Make sure all propellers are installed in the right orientation, otherwise, the drone would not be able to take off from the ground.
3. Make sure the remote control is assembled with brand new or fully charged AA batteries.
4. Make sure the lithium battery in the drone is also fully charged.

## TAKING OFF:

1. Turn on the remote control (short press the power button). It will beep once and the "STATUS" light will flash. (pic1)
2. Check the lithium battery (3.7V 650mAh), make sure it is inserted into the port inside the battery box of the drone (Pic.2).



(Pic.1)



(Pic.2)

3. Place the drone on a flat, level surface, then press down the power button of the drone to turn on the power (Pic.3). The lights on the drone begin blinking.

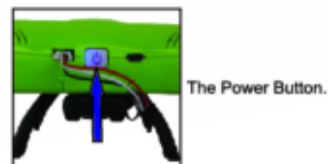

(Pic.3)

4. Quickly shift the throttle stick (left stick) up and down. If done correctly, the transmitter sound will beep (Pic.4), and the LED lights "STATUS", "SPEED2", "SPEED1", "ROLL", "NORMAL" on the remote control will turn on (Pic.5). And the LED lights on the drone keep flashing slowly (Pic.6).



(Pic.4)



(Pic.5)

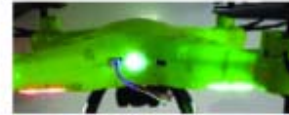

(Pic.6)

5. The drone is now connected to the remote control and ready to take off. Press down the A Key Take Off button, and the drone would take off automatically (Pic.7).



A key Take Off button



(Pic.7)

**Tips:**

- Once the drone takes off, you could use the throttle stick and forward/backward stick to control the flight.
- To avoid injuries or accidents, we suggest that the beginners read through the Instruction Manual before using the A Key Take Off function.
- If the pilot would like to stop the flight after taking off, simply press down the A Key Take Off/Landing button again, the drone would land back on the ground automatically, until the propellers stop rotating.

**LED LIGHTS DISPLAY**

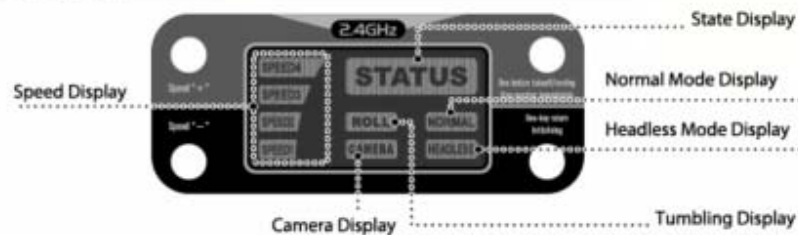

**ALTITUDE HOLD MODE:**

- The model is designed with Altitude Hold Mode by default. The drone will be kept at the same altitude in hovering.
- Throttle up the left stick, the drone will be ascending.
- Move the left throttle stick downward, the drone will be descending.
- When the throttle stick returns back to the neutral position, the drone will be kept at the same height.

## Operations

### Hover up and down



### Forward and backward



### Turn left and right



### Sideward fly



### Sideward fly fine-tuning



### Forward and backward fly fine-tuning



## HEADLESS MODE:

1. Place the drone in front of the pilot, before the pilot pairs the drone, make sure that the head of the drone face forward, and the tail face towards the pilot (Pic.8). After the drone takes off, press down the Headless Mode button on the remote control to enter into the Headless Mode, the LED light of "NORMAL" turns off, and the light of "HEADLESS" turns on (Pic.9).
2. In Headless Mode, the head of the drone not necessarily points to the forward direction, any side of the drone could point forward by moving the throttle stick and forward/backward/left/right stick.

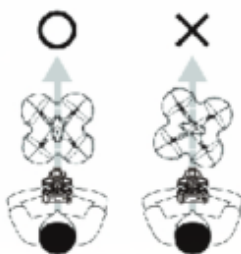

(Pic.8)



Press the Headless Mode button.

(Pic.9)



3. Press down the Headless Mode button again to exit the Headless mode, and the LED light of "HEADLESS" turns off on the remote control, the light of "NORMAL" turns on.



**Tips: (Important!)**

1. Make sure that the head of the quad face forward, and the tail face towards the pilot when being paired.
2. When flying in headless mode/One Key Return, the flyer should not move around. This is because the quadcopter will fly relative to the point where it is bound (to the remote), not relative to where the remote is.
3. That said, we suggest pilots to stay stationary and face the same direction in which he set the head of the quadcopter to face when binding the remote.

### ONE KEY RETURN:

The model is designed with One Key Return function. The function makes the drone drives itself back to the pilot automatically by simply pressing down the One Key Return button.

- **In Normal Mode(The LED light "NORMAL" turns on):**

Press down the One Key Return button, the drone would fly back to the direction where the tail of the drone points to when the drone is being paired(Pic.10).

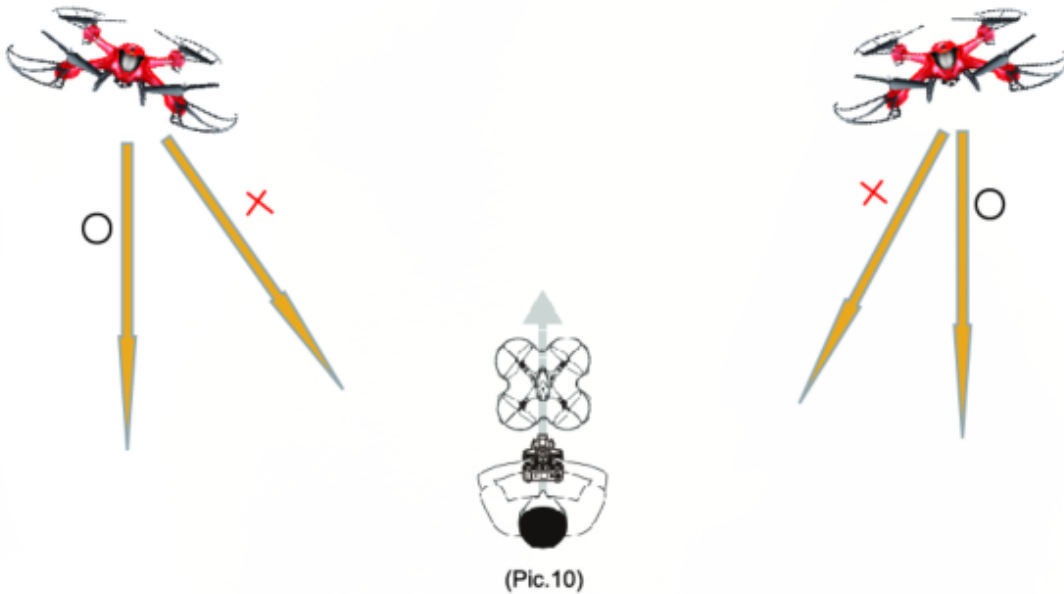

- **In Headless Mode(The LED light "HEADLESS" turns on):**

Press down the One Key Return button, the drone would fly back to the direction where the tail of the drone points to when the drone enters into the Headless Mode.

### 3D TUMBLING FUNCTION:

When you are familiar with all the basic actions, you can play some more amazing tumbling actions. When you fly the Quad-rotor to 3 meters above, please keep pressing the key (i.e. Tumbling Key) at the right up corner while pushing the Right Control Lever to Forward Backward/ Left/ Right until it reaches the highest position. This time the Quad-rotor can realize the Forward/Backward/Left/Right Tumbling Function. Under the Headless mode, it can not make tumbling action.

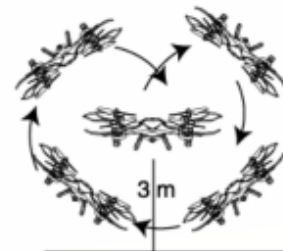

Caution: When the battery is fully charged, it will make the best tumbling performance.

## ASSEMBLE THE CAMERA

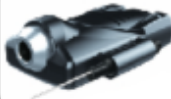

The camera is installed onto the drone out from the box. Check if the wires of the camera are well connected with the drone.

### Tips:

If the pilot uses the remote control to take photos/videos, please connect WIFI first.

- (1) Short press down the button on the top left of the remote control to take photo(Pic.11)
- (2) Long press down the button on the top left of the remote control to take video, short press down the button again to end the recording. When the drone is taking a video, the remote control sounds constant beeps, until the recording is ended.
- (3) All the images and videos would be reserved in the micro SD card which is inserted into the camera.



(Pic.11)

**Please connect the phone to the camera WIFI signal "HolyStoneFPV\*\*\*\*" before you use the camera function on the remote control.**

## ASSEMBLE THE PHONE HOLDER



A phone holder is included in the box for the FPV function, the assembling is shown as below.

1. Insert the phone holder stick into the hole at the middle top of the remote control(Pic.12).
2. Rotate the phone holder to bite the plastic tag on the remote control(Pic.13, Pic.14).
3. Fix the phone holder on the remote control by clockwise locking the black plastic screw(Pic.14)



(Pic.12)



(Pic.13)



(Pic.14)

## DOWNLOAD THE APP

The model is equipped with FPV real time camera function as well as gravity sensor control function, please download the correct App to use the functions.



QR code of "Deerc FPV" App for Apple IOS system  
(Please scan this QR code to download the App).



QR code of "Deerc FPV" App for Android system  
(Please scan this QR code to download the App).



Note: For IOS System smart phone, another option is to enter your App Store and search by "Deerc FPV". And as for Android System, users could go to our website to download the App: [www.holystone.com](http://www.holystone.com)

## APP INSTRUCTIONS – TAKE PHOTOS/VIDEOS

Turn on your quadcopter, then go into your phone settings, select WIFI, and then connect to "HolyStoneFPV\*\*\*", which is the camera connection. Once you have successfully connected, exit the settings menu on your phone and open the 'Deerc FPV' App. To see real time images from the quadcopter, simply press the play button in the app.



1. **Take Photos:** To take a photo, simply tap the Take Photo button. (Pic. 15)
2. **Take Videos:** To take video, simply tap the Take Video button. (Pic.16)



(Pic.15)



(Pic.16)

3. All images and videos will be saved to the camera's micro SD card, so make sure you have inserted that before flight. Once you have finished flying, simply push the card gently to remove it from the camera (Pic. 17), and insert it into a card reader and connect to your computer to access your files.(Pic. 19) All data is saved to a folder called "Deerc FPV" on the phone.



(Pic. 17)



(Pic 18)



(Pic.19)

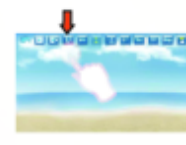

(Pic.20)

**Tip:** (1) The red light indicator will be flashing quickly when the Memory card is not inserted or already full.  
 (2) The video player must support AVI format.

## MOBILE PHONE CONTROL

You can control the quadcopter directly from within the app without using the transmitter. Hold the mobile phone horizontally when using the Gravity Sensor Mode. Always ensure that you turn off the transmitter before attempting to control the quadcopter via your phone.

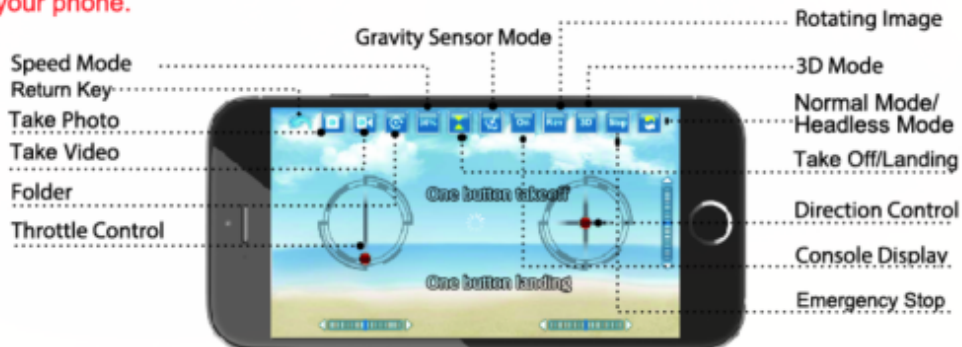

**COMMON PROBLEM AND SOLUTION INSTRUCTION:**

THE PROBLEM	REASON	COUNTERMEASURES
The indication light of the quadcopter is flashing and without reaction when operated.	1.Frequency modulation between the quadcopter and remote control is not operated correctly. 2.Insufficient battery power.	1.Refer to the Preparation for taking off, and re-modulate the frequency. 2.Recharge the battery.
The blades turn, but the quadcopter can't take off.	1.Insufficient battery power. 2.The blades distorted.	1.Recharge the battery. 2.Replace the blades.
The quadcopter shakes hardly.	The blades distorted.	Replace the blades
Use the tuning functions, but the quadcopter still couldn't keep balance.	1.The blades distorted. 2.The motor doesn't work properly.	1.Replace the blades. 2.Replace the motor.
The quadcopter is out of control after crashing.	Three-axis acceleration sensor lose it's balance after crashing.	Put the quadcopter on the level ground for 5-10 seconds.

**SPARE PARTS:**

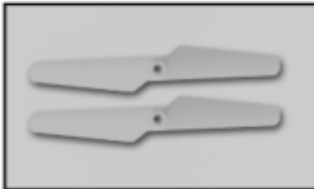

Blades

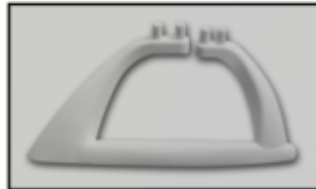

Landing Gear



Propeller Guard



USB Cable



Motor A



Motor B

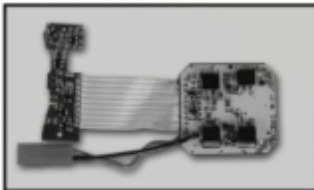

Receiver Board

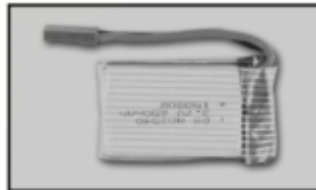

Battery



Transmitter



FPV WIFI Camera

**Tips:**

Please contact Holy Stone for the purchase of replacement parts if the users would need additional ones.



Made in China



NOTE: This equipment has been tested and found to comply with the limits for a Class B digital device, pursuant to Part 15 of the FCC Rules. These limits are designed to provide reasonable protection against harmful interference in a residential installation. This equipment generates, uses and can radiate radio frequency energy and, if not installed and used in accordance with the instructions, may cause harmful interference to radio communications. However, there is no guarantee that interference will not occur in a particular installation. ↵

If this equipment does cause harmful interference to radio or television reception, which can be determined by turning the equipment off and on, the user is encouraged to try to correct the interference by one or more of the following measures: ↵

- Reorient or relocate the receiving antenna.↵
- Increase the separation between the equipment and receiver. ↵
- Connect the equipment into an outlet on a circuit different from that to which the receiver is connected. ↵
- Consult the dealer or an experienced radio/TV technician for help.↵

changes or modifications not expressly approved by the party responsible for compliance could void the user's authority to operate the equipment.↵