

DEERC

8+
age

Instructions For Use

日本語マニュアル

Gebrauchsanweisung

V1.1

DE36W

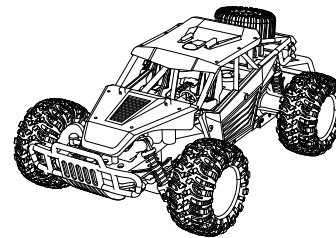
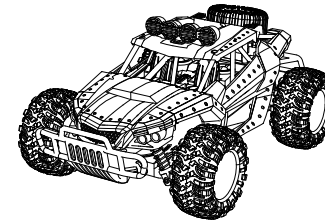

DE37

 usa@deerc.com (USA)
eu@deerc.com (EU)
jp@deerc.com (JP)

 +1(855) 777-8866

www.deerc.com

- English 1-18•
- 日本語 19-29•
- Deutsch 30-46•

Contents

- 1. Preface 01
- 2. Warnings 02
- 3. Package Contents 04
- 4. RC Car's Details 05
- 5. Transmitter Functions 05
- 6. Battery Installation
 - RC Car Battery 06
 - Transmitter Battery 06
- 7. Charging 07
- 8. Operation
 - Pairing 08
 - Forward 08
 - Backward 08
 - Forward to Left 09
 - Forward to Right 09
 - Reversing to the left 10
 - Reversing to the right 10
- 9. Trimmer Function 11
- 10. Specifications 12
- 11. Contact Us 13
- 12. General Information 14

< PREFACE >

To make your experience with this remote control car as straightforward and convenient as possible, please read this Instructions For Use before operating and keep it for the future reference and maintenance.

1. In order to protect the legitimate rights and interests of users, please be sure to carefully read the relevant contents of this manual provided with this product before using this product.
2. During the use of this product, please be sure to strictly observe and perform the requirements including but not limited to the instructions and safety instructions. For any personal injury, accident, property loss, legal dispute, or any other adverse event causing a conflict of interest resulting from the use of the product or any irresistible factors that are in violation of the safety instructions, the user shall bear the related responsibilities and losses. DEERC will not take any responsibility.
3. Once you start using this product, you are deemed to have read, understood, endorsed, and accepted all the terms and contents of the instructions (including disclaimers, safety instructions, warning instructions, etc.) included with this product.
4. In case of having difficulties on any aspect of the product, operation or maintenance, please contact your local sales agent or contact DEERC customer support.

< WARNINGS >

1. Please use under the guidance of an adult.
2. Please install and use it correctly according to instructions or instructions on the package. Some parts need to be assembled and adjusted by adults.
3. Please promptly put away the packing materials so as not to cause harm to children.







4. Do not operate in a place where water is trapped or in the rain. Parts on the product may get wet and cause malfunction.
5. Do not touch the rotating wheel to avoid unnecessary injury.
6. The product contains small parts that may pose a risk of ingestion or suffocation.
7. It is forbidden to remotely control the road or the crowd to avoid accidents.
8. It is necessary to periodically check the USB charging cable, plug, housing and other components and immediately stop using it when it is found to be damaged.
9. This product can only use the factory configured USB cable to charge the product battery.
10. USB cable, battery box, and battery must be inserted into the same specified power supply as the product symbol.
11. The USB cable and the battery is not a toy.
12. Disconnect the USB cable before cleaning the toy.
13. If you experience thunder, lightning, etc. during remote control, stop the remote control immediately.
14. When installing or replacing the battery, pay attention to the correct polarity of the battery.
15. The remote control car uses a 6V 800mAh Ni-MH battery.
16. Never short-circuit, disassemble, modify, impact, crush, puncture, drop high, throw fire, etc. to avoid risk.
17. Do not expose the battery to prolonged exposure to sunlight to prevent risk.
18. It is advisable to store the battery at a temperature below 30°C. Do not store it in a place with heat, high temperature, or humidity to avoid risk.
19. Non-rechargeable batteries cannot be charged.
20. When charging a rechargeable battery, adult supervision is required for correct polarity of the battery.

21. The rechargeable battery should be removed from the toy before charging.
22. Do not mix old and new or different types of batteries.
23. Only use the USB cable configured by this product to charge the battery when charging the battery.
24. Do not disassemble the battery or modify the battery at random to avoid the risk of fire or explosion.
25. After the battery is used, it should be taken out of the remote control car, and after cooling, fully charged and store in a safe position. Unplug the battery plug from the USB charging cable when it is not charging, and disconnect the power.
26. The battery should stop using the battery as soon as it smells or suddenly becomes hot, deformed, discolored, or otherwise abnormal during use or charging.
27. After the remote controller runs, the battery temperature is high. It is recommended that you wait for about 30 minutes before charging the battery. Otherwise, the battery may be damaged.
28. Exhausted batteries should be removed in time.
29. The wiring port should not be short-circuited.
30. If you do not use the product for a long time, remove the batteries of the remote control car and remote control.
31. The packaging and instructions contain important product information, please give it reservations.

< PACKAGE CONTENTS >

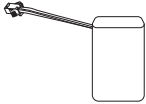
Note:

This instruction manual is applicable to DE36W / DE37. The illustrations all take DE36W as an example.

 × 1	 × 1	 × 1
Remote Control Car	Transmitter	RC Car Battery
 × 1	 × 1	 × 1
USB Charging Cable	Screwdriver	Instructions For Use

< RC CAR'S DETAILS >

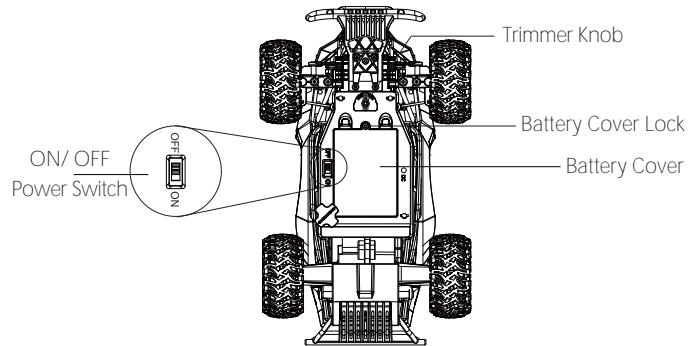

< TRANSMITTER FUNCTIONS >

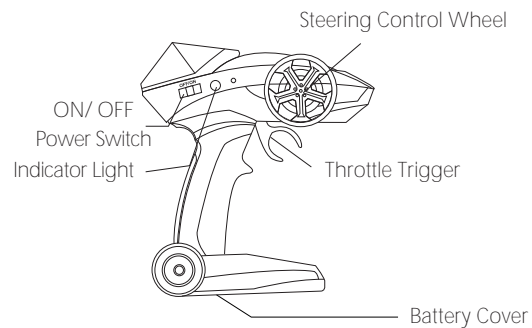

< BATTERY INSTALLATION >

1. RC Car Battery

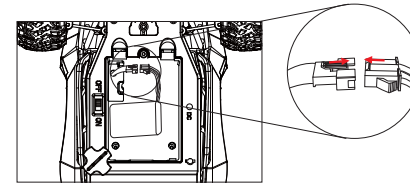

Remove the screw from the battery cover with a screwdriver to open the battery cover.

Put the battery into the battery compartment.

As shown in the diagram above, connect the battery cable to the cable in the battery compartment.

④ Close the battery cover.

2. Transmitter Battery

! Always pay close attention to battery polarity when installing the batteries to make sure they are fitted correctly.

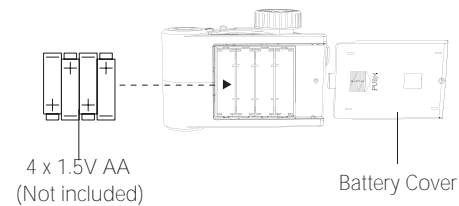

Using a Screwdriver, remove the fixing screw, push the Battery Cover out of the bottom of the transmitter, and insert 4 AA batteries.

When the transmitter is not used for a long time, please turn off the power and take out the battery.

< CHARGING >

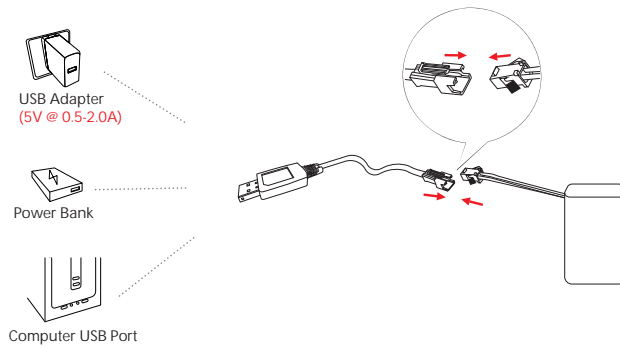

The battery is a new battery pack and it is recommended to be recharged before use.

1. Plug the USB charging cable into a USB charging port on the computer, power bank or USB adapter (5V @ 0.5-2.0A).
2. Connect the wire of battery with USB charging cable.
3. Charging time: about 240 minutes.
4. The red indicator light on the USB charging cable will flash when the battery is under charging, and will turn off when the battery is fully charged.
(If you find that the battery pack and USB charging cable are damaged, stop using it immediately and replace the accessories as soon as possible.)

ATTENTION:

Please keep the battery in sight for charging. Do not put the battery on the flammable surface.

When the battery of the RC car is low or not used for a long time, please turn off the power of the car, disconnect the battery from the RC car, and charge the battery in time to prolong the battery life.

< OPERATION >

1. Pairing

Turn on the power switch of the RC car and the transmitter respectively to operate the RC car. During the pair, the RC car indicator light will blink. When the indicator light turns solid, it means that the RC car pair is successful. After the pairing is finished, the RC car can be operated.

2. Forward

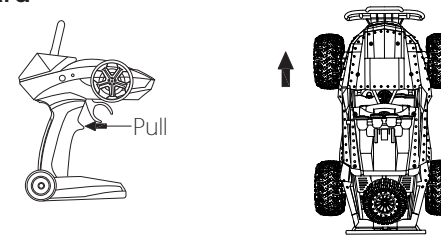

Pull the throttle trigger backward, the car goes forward. The amplitude of the trigger controls the speed of the RC car.

3. Backward

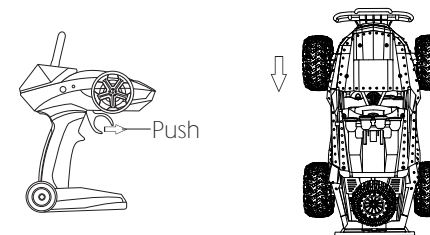

Push the throttle trigger forward, the car goes backward. The speed of the RC car can be controlled by the amplitude when the trigger is pushed.

< OPERATION >

4. Forward to Left

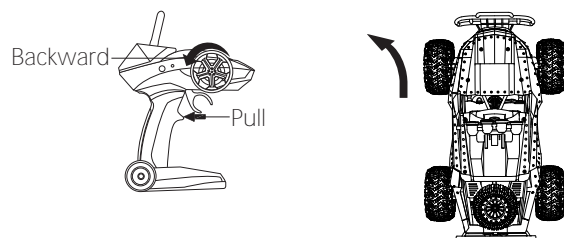

The forward movement of the RC car can be combined with the left turn. Rotates the steering wheel backward while the RC car is moving forward, and the RC car will make a left turn.

5. Forward to Right

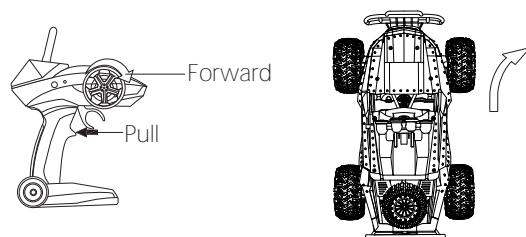

The forward movement of the RC car can be combined with the right turn. Rotates the steering wheel forward while the RC car is moving forward, and the RC car will make a right turn.

< OPERATION >

6. Reversing to the Left

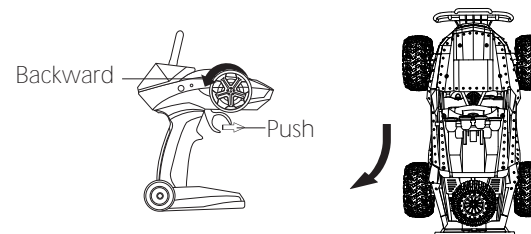

The backward movement of the RC car can be combined with the left turn. Rotates the steering wheel backward while the RC car is moving backward, and the RC car will reverse left.

7. Reversing to the Right

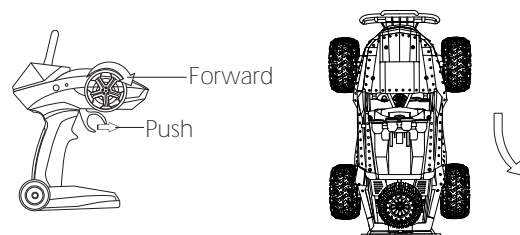

The backward movement of the RC car can be combined with the right turn. Rotates the steering wheel forward while the RC car is moving backward, and the RC car will reverse right.

< TRIMMER FUNCTION >

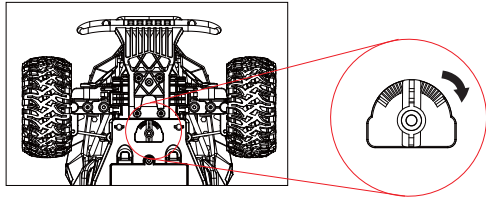

When the RC car is moving to the left, please turn the trimmer knob at the bottom of the RC car to the right until the car goes straight.

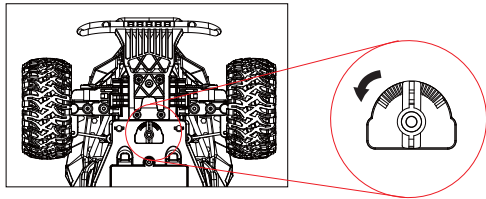

When the RC car is moving to the right, please turn the trimmer knob at the bottom of the RC car to the left until the car goes straight.

< SPECIFICATIONS >

RC CAR

Weight: 692 g / 24.3 oz (DE36W)

652 g / 22.9 oz (DE37)

Operating Time: ≤ 30 minutes

Running Speed: < 20 km/h

Operating Temperature Range: 32° to 104°F

Dimensions: 315 × 193 × 134 mm (DE36W)

315 × 193 × 120 mm (DE37)

TRANSMITTER

Operating Frequency: 2.4GHz

MAX Transmission Distance: 164 feet (outdoors and unobstructed)

Battery Type: 1.5V AA battery

Operating Temperature Range: 32° to 104°F

RC CAR BATTERY

Weight: 100 g / 3.5 oz

Capacity: 800 mAh

Voltage: 6 V

Battery Type: Ni-MH Battery

Charging Temperature Range: 41° to 104°F (5° to 40°C)

Charging Time: 120~150 minutes

USB CHARGING CABLE

Voltage: 5 V

Rated Power: ≤10 W

< CONTACT US >

Please do not hesitate to contact us if you need further support.



usa@deerc.com (America)

eu@deerc.com (Europe)

jp@deerc.com (Japan)



+1(855) 777-8866

changes or modifications not expressly approved by the party responsible for compliance could void the user's authority to operate the equipment.

This equipment has been tested and found to comply with the limits for a Class B digital device, pursuant to Part 15 of the FCC Rules. These limits are designed to provide reasonable protection against harmful interference in a residential installation. This equipment generates, uses and can radiate radio frequency energy and, if not installed and used in accordance with the instructions, may cause harmful interference to radio communications. However, there is no guarantee that interference will not occur in a particular installation.

If this equipment does cause harmful interference to radio or television reception, which can be determined by turning the equipment off and on, the user is encouraged to try to correct the interference by one or more of the following measures:

- Reorient or relocate the receiving antenna.
- Increase the separation between the equipment and receiver.
- Connect the equipment into an outlet on a circuit different from that to which the receiver is connected.
- Consult the dealer or an experienced radio/TV technician for help.

This equipment complies with FCC radiation exposure limits set forth for an uncontrolled

< GENERAL INFORMATION >

FCC Notice:

This device complies with Part 15 of the FCC Rules.

Operation is subject to the following two conditions:

- (1) This device may not cause harmful interference.
- (2) This device must accept any interference received, including interference that may cause undesired operation.

NOTE: This equipment has been tested and found to comply with the limits for a Class B digital device, pursuant to Part 15 of the FCC Rules. These limits are designed to provide reasonable protection against harmful interference in a residential installation. This equipment generates uses and can radiate radio frequency energy and, if not installed and used in accordance with the instructions, may cause harmful interference to radio communications. However, there is no guarantee that interference will not occur in a particular installation. If this equipment does cause harmful interference to radio or television reception, which can be determined by turning the equipment off and on, the user is encouraged to try to correct the interference by one or more of the following measures:

- Reorient or relocate the receiving antenna.
- Increase the separation between the equipment and receiver.
- Connect the equipment into an outlet on a circuit different from that to which the receiver is connected.
- Consult the dealer or an experienced radio/TV technician for help.

WARNING: Changes or modifications not expressly approved by the party responsible for compliance could void the user's authority to operate the equipment.

< GENERAL INFORMATION >

RF Exposure

The equipment complies with FCC radiation exposure limits set forth for an uncontrolled environment. This device should be installed and operated with minimum distance 20cm between the radiator & your body.

IC Notice:

This device complies with Canada Industry licence-exempt RSS standard(s). Operation is subject to the following two conditions:

- (1) this device may not cause interference; and
- (2) this device must accept any interference. Including interference that may cause undesired operation of the device.

CAN ICES-3 (B)

Avis d'Industrie Canada

Le présent appareil est conforme aux CNR d'industrie Canada applicables aux appareils radio exempts de licence. L'exploitation est autorisée aux deux conditions suivantes:

- 1) l'appareil ne doit pas produire de brouillage; et
- 2) l'utilisateur de l'appareil doit accepter le brouillage radioélectrique subi même si le brouillage est susceptible d'empêcher le fonctionnement de l'appareil. Cet appareil numérique de la classe B est conforme à la norme NMB-003 du Canada.

CAN NMB-3 (B)

RF Exposure

Radiation Exposure Statement:

This equipment complies with IC radiation exposure limits set forth for an uncontrolled environment. This equipment should be installed and

< GENERAL INFORMATION >

operated with minimum distance 20cm between the radiator & your body.

Déclaration d'exposition aux radiations:

Cet équipement est conforme aux limites d'exposition aux rayonnements IC établies pour un environnement non contrôlé. Cet équipement doit être installé et utilisé avec un minimum de 20 cm de distance entre la source de rayonnement et votre corps.

HOW TO RECYCLE THIS PRODUCT

This symbol on the product or its documentation indicates that it must not be disposed of with household waste.

Uncontrolled waste disposal may harm the environment or human health.

Please separate your device from other types of waste to recycle it responsibly.

This will help to foster the sustainable re-use of material resources.

We invite you to contact your retailer or inquire at your local town hall to find out where and how the drone can be recycled.



BATTERY WARNING:

1. Failure to follow all the instructions may result in serious injury, irreparable damage to the battery and may cause a fire, smoke or explosion.
2. Always check the battery's condition before charging or using it.
3. Replace the battery if it has been dropped, or in case of odor, overheating, discoloration, deformation or leakage.
4. Never use anything other than the approved charger for the battery. Always use a balancing charger for battery. It is recommended that you do not use any other charger than the one provided with the product.

< GENERAL INFORMATION >

- 5.The battery temperature must never exceed 60°C (140°F) otherwise the battery could be damaged or ignite.
6. Never charger on a flammable surface, near flammable products or inside a vehicle (perferably place the battery in a non-flammable and nonconductive container).
7. Never leave the battery unattended during the charging process. Never disassemble or modify the housing's wiring, or puncture the cells. Always ensure that the charger output voltage corresponds to the voltage of the battery. Do not short circuit the batteries.
8. Never expose the battery to moisture or direct sunlight, or store it in a place where temperatures could exceed 60°C(car in the sun, for example).
9. Always keep it out of reach of children.
10. Improper battery use may result in a fire, explosion or other hazard.
11. Non-rechargeable batteries are not to be recharged. Rechargeable batteries are only to be charged under adult supervision.
12. Different types of batteries or new and used batteries are not to be mixed.
13. Batteries are to be inserted with the correct polarity.
14. The supply terminals are not to be short-circuited. Regular examination of transformer or battery charger for any damage to their cord, plug, enclosure and other parts and they must not be used until the damage has been repaired.
- 15.The packaging has to be kept since it contains important information.
- 16.The toy is only to be connected to Class II equipment bearing the symbol.

EU RF Power(EIRP): 0dBm (2420MHz ~ 2465 MHz)



< GENERAL INFORMATION >

Caution

- 1.The max operating of the EUT is 40°C. and shouldn't be lower than 0°C.
- 2.The device complies with RF specifications when the device used at 0mm form your body.
- 3.Declaration of Conformity.

We, Xiamen Huoshiquan Import & Export CO., LTD hereby, declare that the essential requirements compliance with the Directive 2014/53/EU, the RoHS Directive 2011/65/EU and Safety Directive 2009/48/EC have been fully fulfilled on our product with indication below:

Product Name: R/C CAR

Model/Mark : DE36W/DE37/DEERC

The Statement of compliance is available at the following address:

<http://www.deerc.com/products/show.php?itemid=10>

This product can be used across EU member states.

MANUFACTURER INFORMATION

Manufactured by

Xiamen Huoshiquan Import & Export CO., LTD

Room 703.No. 813-2 Xiahe Road, Siming District, XIAMEN, China

+1(855) 777-8866



Made in China