

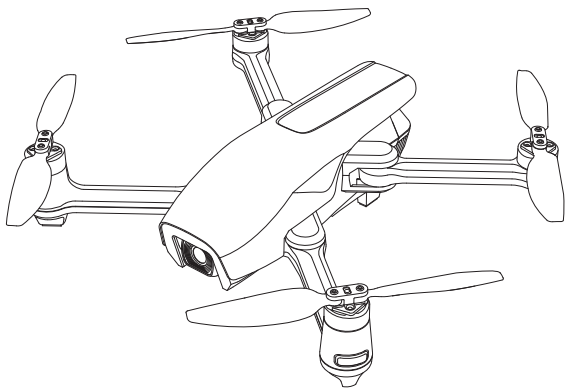



14+  
age

# Instructions For Use Gebrauchsanweisung

V4.0



HS710

 +1(855) 888-6699

 [www.holystone.com](http://www.holystone.com)

 [usa@holystone.com](mailto:usa@holystone.com) (USA) [eu@holystone.com](mailto:eu@holystone.com) (EU)  
[ca@holystone.com](mailto:ca@holystone.com) (CA)



English

01-45

Deutsch

46-86

# Contents

1.0 Disclaimer & Warning .....	01
2.0 Safety Guidelines .....	01
3.0 Maintenance .....	05
4.0 Package Contents .....	06
5.0 Drone Details .....	07
6.0 Transmitter Details	
6.1 Transmitter Functions .....	08
6.2 LCD Screen Functions .....	10
6.3 Low Battery Warning .....	10
6.4 Mode Switch .....	11
7.0 Installation	
7.1 Drone Battery .....	12
7.2 Propellers .....	13
7.3 TF Card .....	14
7.4 Preparing the Drone .....	14
7.5 Phone Holder .....	15
7.6 Transmitter Battery .....	16
7.7 Antenna .....	16
8.0 Charging .....	17
9.0 Operation Guide	
9.1 Download APP .....	18
9.2 Connect to Wi-Fi .....	18
9.3 Pairing .....	19
9.4 Calibrating the Compass .....	20
9.5 Unlocking/Locking .....	22
9.6 One Key Takeoff/Landing .....	23

10.0 Functions Details	
10.1 Camera Angle Adjustment .....	23
10.2 Return to Home .....	24
10.3 Optical Flow Positioning .....	27
11.0 APP Operation Instruction	
11.1 Operation Interface .....	29
11.2 Follow Me .....	30
11.3 Point of Interest .....	31
11.4 Headless Mode .....	32
11.5 TapFly .....	33
11.6 Take Photo/Record Video .....	34
12.0 Drone Status Indicator .....	35
13.0 Specifications .....	36
14.0 Trouble Shooting .....	38
15.0 Contact Us .....	39
16.0 General Information .....	40

## **1.0 DISCLAIMER & WARNING**

1. Please read this Disclaimer & Warning and Safety Guidelines carefully before using our product. This product is not recommended for people under the age of 14. By using this product, you hereby agree to this disclaimer and signify that you have read it fully. You agree that you are responsible for your own conduct and any damage caused while using this product, and any consequence. You agree to only use this product for its designed purposes and in accordance with the local laws, regulations and all applicable policies and guidelines that HolyStone may provide.

2. When using this product, please be sure to strictly abide by the specification requirements and safety guidelines stated in this document. Any personal injury, property damage, legal disputes and all other adverse events caused by the violation of any of the safety instructions or due to any other factor, WILL NOT be HolyStone's responsibility.

## **2.0 SAFETY GUIDELINES**

### **2.1 Check Before Use**

- ① This product is a high precision drone that integrates various electronic stability and control mechanisms. Please be sure to configure this drone carefully and correctly to ensure safe, accident-free operation.
- ② Ensure that the batteries of the drone and transmitter are clean, undamaged, and fully charged before every use.
- ③ Ensure that all the propellers are undamaged and are installed in the correct orientation.

④ Please perform a thorough check of the product before each use. Inspect the integrity of the parts, any signs of cracks and wear off on the propellers, battery power and effectiveness of the indicator, etc. If there is any problem found after checking the drone, please refrain from using it until the problem is resolved.

## 2.2 Flight Environment



+



+



**Fly in Open Areas**

**Keep in Sight**

**Fly Below  
390 feet (120 m)**



Avoid flying over, or near obstacles, crowds, high voltage power lines, trees, airports or bodies of water.

DO NOT fly near strong electromagnetic sources such as power lines and base stations as it may affect the onboard compass.



DO NOT use this drone in adverse weather conditions such as rain, snow, fog, and wind.

## 2.3 Operation Requirements

- ① DO NOT use this product to follow any moving vehicles.
- ② During the flight, turn off the motors only in case of an emergency.
- ③ When the battery runs low, return the drone back to your starting point.
- ④ DO NOT use this product if you feel tired, take medicine or feel unwell and drink alcohol.
- ⑤ Be aware of the volume of noise that the drone produces. Please ensure to keep your distance to avoid ear damage.



- ⑥ **Stay away from the rotating propellers and motors.**

- ⑦ **DO NOT fly in any spaces where drones are prohibited. Please respect people's right to privacy by not flying your drone close to others.**

## 2.4 Use of Battery

- ① Please ensure batteries are fitted in the correct orientation as shown in the instruction manual.
- ② Avoid short circuits by fitting the batteries correctly, and do not crush or squeeze the batteries as this could cause the risk of a fire or explosion.
- ③ DO NOT mix new and old batteries as this can lead to poor performance of the product.
- ④ Please dispose of used batteries carefully, do not litter, and recycle where ever possible.
- ⑤ DO NOT expose dead batteries to heat or fire or they may explode.



- ⑥ If the device is not going to be used for an extended period of time, please remove batteries to prevent potential damage to the drone from battery leakage.
- ⑦ Only use the USB charging cable that comes with the drone to charge the battery.
- ⑧ DO NOT connect the battery directly to wall outlets or car cigarette-lighter sockets as this will damage your battery since they have different voltages.
- ⑨ DO NOT attempt to disassemble or modify the battery in any way.
- ⑩ DO NOT use the battery if it gives off an odor, generates heat, becomes discolored, deformed or appears abnormal in any way. If any of these situations occur while the battery is in use or being charged, remove it from the device or charger immediately and discontinue use.
- ⑪ DO NOT pierce the battery casing with a nail or any other sharp object, break it open with a hammer, or step on it! Dispose or recycle this battery as it may cause personal injury or damage to your drone.
- ⑫ Always charge the batteries on a fireproof surface and away from combustible materials. DO NOT charge on surfaces that can catch fire, which includes wood, cloth, carpet.
- ⑬ DO NOT immerse the battery in water or get it wet.
- ⑭ DO NOT solder battery terminal in any way.
- ⑮ Keep batteries out of reach of children or pets.
- ⑯ DO NOT short-circuit the battery by connecting wires or any other metal object to the positive(+) and negative(-) terminals.



### Li-Po Battery Disposal & Recycling





Waste Lithium-polymer batteries must not be placed with household trash. Please contact local environmental or waste agency or the waste agency or the supplier of your model or your nearest Li-Po battery recycling center.

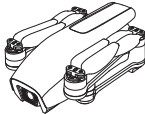
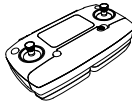
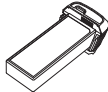

## 3.0 MAINTENANCE

- ① Clean the drone after each use with a clean, soft cloth.
- ② Avoid prolonged exposure to direct sunlight and avoid buildup of heat on the drone or batteries.
- ③ This device is not waterproof and must not be submerged or subjected to water under any circumstance. Failure to keep the device completely dry will result in failure and permanent damage to the unit. Be aware that although it might be dry where you are, droplets of rain or mist from a river or waterfall could damage your drone where it is flying.
- ④ Frequently check the charging plug and other accessories for signs of damage. If any part of the device or cables are damaged, avoid use or charging until the damaged parts are replaced.

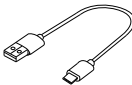
## 4.0 PACKAGE CONTENTS

 <p style="text-align: right;">× 1</p>	 <p style="text-align: right;">× 1</p>	 <p style="text-align: right;">× 1</p>
<p style="text-align: center;">Drone</p>	<p style="text-align: center;">Transmitter</p>	<p style="text-align: center;">Drone Battery</p>
 <p style="text-align: right;">× 4</p>	 <p style="text-align: right;">× 1</p>	 <p style="text-align: right;">× 1</p>
<p style="text-align: center;">Spare Propellers</p>	<p style="text-align: center;">USB Charging Cable</p>	<p style="text-align: center;">Screwdriver</p>
 <p style="text-align: right;">× 1</p>		
<p style="text-align: center;">Instructions For Use</p>		

## 5.0 DRONE DETAILS

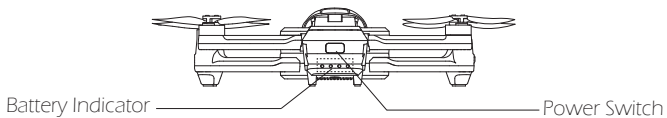
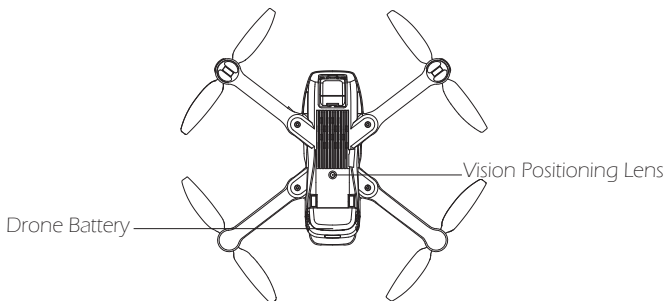
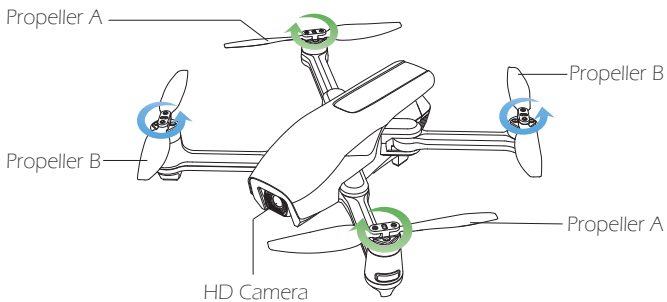

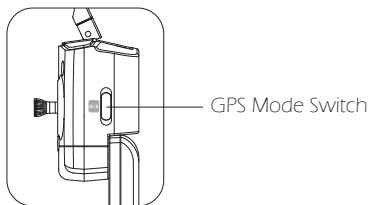
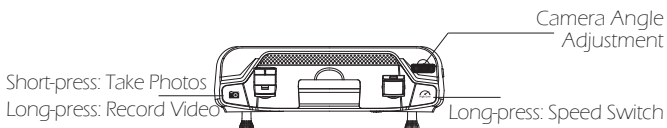
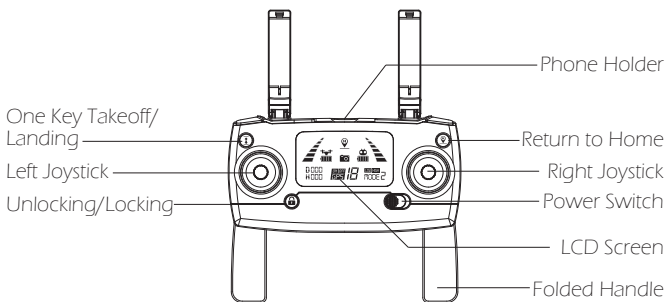

## 6.0 TRANSMITTER DETAILS

### 6.1 Transmitter Functions



### • GPS Mode Switch

After turning on the transmitter, the GPS Mode is default on. GPS mode can be turned off by sliding the GPS switch. Check the icon “” or “” on the LCD screen to confirm the GPS status.

### • Return to Home (RTH)

Press the button to start the RTH, the transmitter makes a beep sound and the drone will fly back to the recorded Home Point. Press the RTH button again to exit RTH procedure and regain control of the drone.

### • Emergency Stop

Press and hold the button “” for 3 seconds, the motor will stop immediately. Be aware that you risk breakage of the drone if it falls a large distance or hits anything at a high rate of speed.



**Attention:** The Emergency Stop function should only be used during emergency to avoid any damage or injury.



### • Photo/Video

Short press the button and the camera icon “” on the LCD screen flashes once, and the camera takes one photo.

Long press the same button, the video icon “” on the LCD screen flashes slowly, and the camera is taking video. Long press the button again the camera will stop video recording.

### • Speed Switch

Long press the button “” in the upper right corner, the LCD screen shows “”, and you will hear a beep, which means the drone is at the low speed.

Long press the button “” again, the LCD screen shows “”, and you will hear two beeps, which means the drone is at the high speed.

## 6.2 LCD Screen Functions

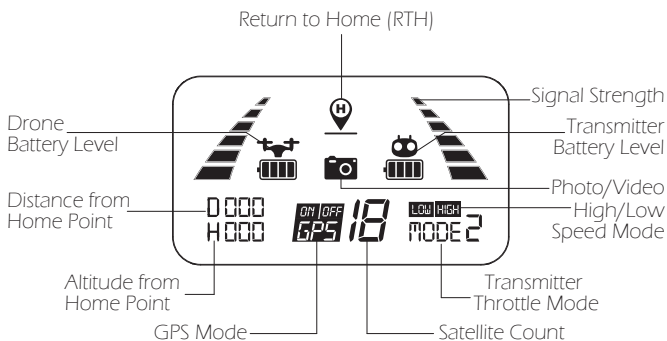

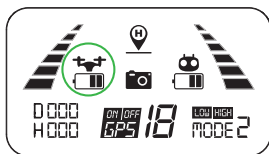

## 6.3 Low Battery Warning

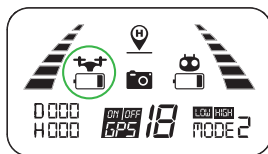

Pic. 1



Pic. 2

1. When the battery icon “” is shown on the LCD screen (Pic.1), and the red indicator lights keep flashing slowly, it means that the battery is nearly low voltage.
2. When the battery icon “” is shown on the LCD screen (Pic.2), and the red indicator lights keep flashing rapidly, it means that the battery is in low voltage.

## 6.4 Mode Switch

MODE switching is only possible before pairing. Hold the “🔒” button and then turn on the power switch button at the same time, then press the “📍” button for 3 seconds to switch the MODE. Check the icon “MODE 1” or “MODE 2” on the LCD screen to confirm MODE status.

### 6.4.1 MODE 2 (Default mode from factory)

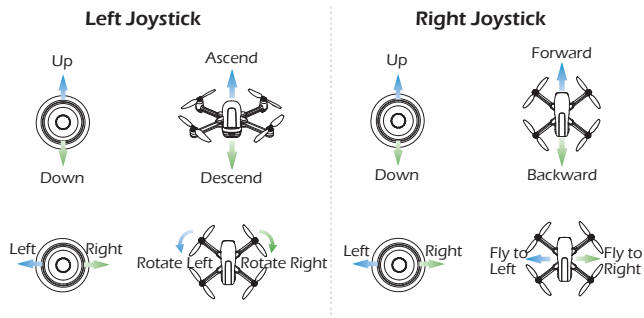

### 6.4.2 MODE 1

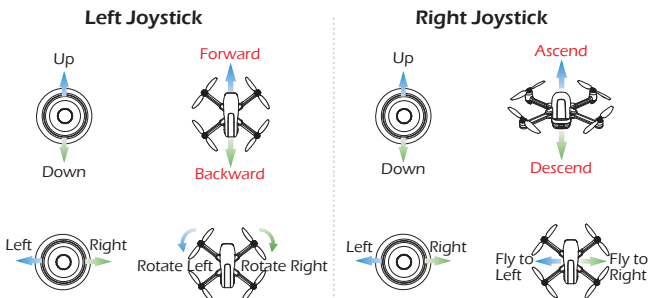



## 7.0 INSTALLATION

### 7.1 Drone Battery

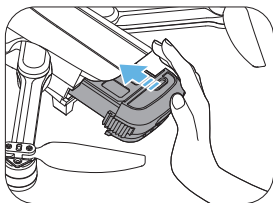

**Installation:** Push the battery into the battery compartment at the rear of the drone. Make sure that you hear a click sound indicating the battery is firmly installed.

**Attention:**

- Before installing the battery, please remove the insulation gasket from the battery.
- The battery should be installed firmly, failure to do so may affect the flight safety of your drone. The drone may crash due to a power-cut during the flight.

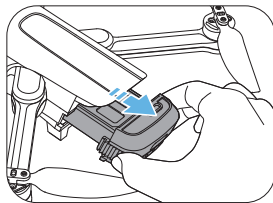

**Removal:** As shown above, press the battery lock on both sides of the battery, and pull it back to remove the battery.

## 7.2 Propellers

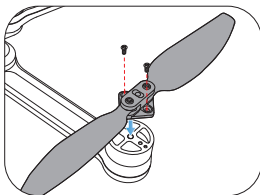
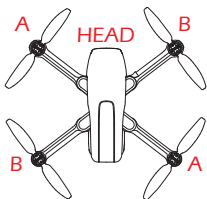

**Installation:** The drone will not fly unless the correct propeller is installed on the correct motor shaft. See illustration above. An “A” or “B” printed on the back of each propeller. Lock the propeller to the motor shaft with screws. Please rotate each screw clockwise.

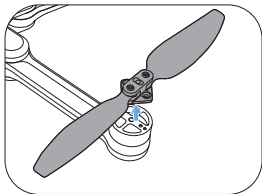
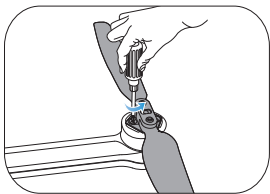

**Removal:** For propeller removal, use the screwdriver (included) to rotate the screws counterclockwise and remove propeller.

## 7.3 TF Card

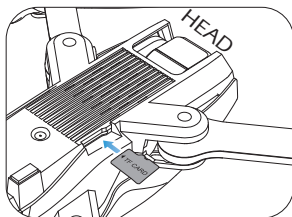

To store your photos and videos, insert the TF card (not included) into the slot as shown above before turning on the drone. The drone supports TF card up to 32 GB.

---

## 7.4 Preparing the Drone

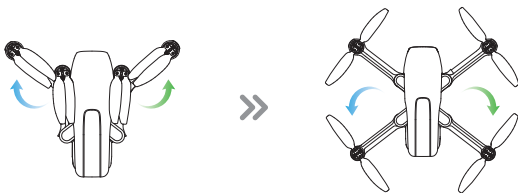

All arms of the drone are folded before the drone is packaged at the factory. First, unfold the front arms, then unfold the rear arms.

## 7.5 Phone Holder

1. Pull out the phone holder upwards completely (Pic. 3).

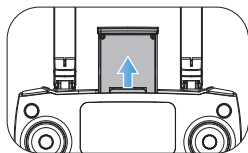

Pic. 3

2. Tilt the holder 30 degrees towards you and then you will hear a click sound (Pic. 4).

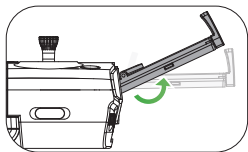

Pic. 4

3. Rotate and fix the support board in place (Pic. 5).

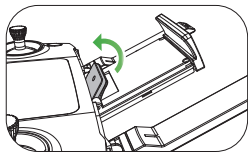

Pic. 5

4. Adjust the phone holder upward or downward according to the size of your phone (Pic. 6).

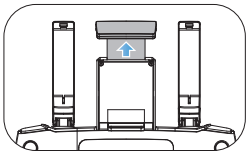

Pic. 6

## 7.6 Transmitter Battery

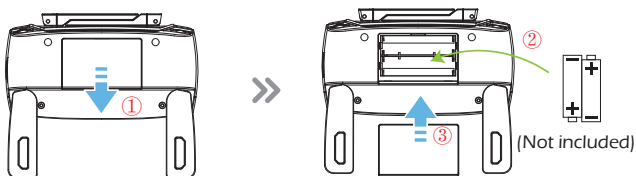

Step 1: Unfold the hand sticks and open the battery cover.

Step 2: Install 2\*AA batteries into the battery compartment according to the given polarity.

Step 3: Close the battery compartment .



- Insert batteries with correct polarity.
- Do not mix old and new batteries.
- Exhausted batteries are to be removed from the transmitter.

## 7.7 Antenna

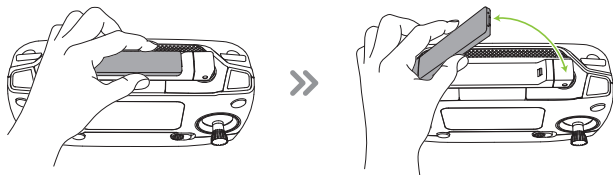

There is a buckle on the antenna, please follow the steps shown above to open the antenna.

## 8.0 CHARGING

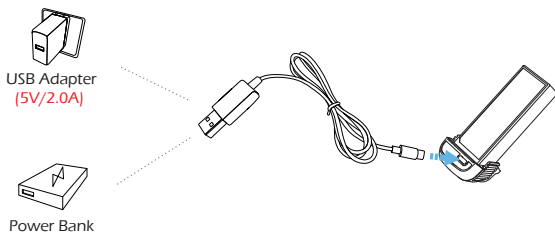

- ① Connect the Battery to the USB Charging Cable.
- ② Connect the USB Charging Cable with Power Bank or a USB Adapter (5V/2.0A) for charging.
- ③ When the battery is charging, the indicator lights on the battery will flash green.
- ④ When the battery is fully charged, all four green indicators on the battery will turn solid.
- ⑤ The charging time is about 2.5 hours.



· Before charging, please read the instruction of the **“Use of Battery”** section of the **“Safety Guidelines”** carefully!

## 9.0 OPERATION GUIDE

### 9.1 Download APP



iOS



Android APP on Google play

Scan the QR code, corresponding to either App Store™ or Google Play™ Store and download the **Ophelia GO** app for free.

Required Operating Systems: iOS 9.0 or later/Android 5.0 or later

### 9.2 Connect to Wi-Fi



Connect your phone to the drone. To check the drone's status in the **Ophelia GO** app.

- ① Open your phone's Wi-Fi settings and click Wi-Fi to search for the Wi-Fi of the drone.
- ② Select the Wi-Fi network: **HolyStoneFPV-\*\*\*\*\***.
- ③ Wait for a couple of seconds for your phone to connect to the drone's Wi-Fi. **This connection is generally represented by the Wi-Fi logo appearing on your phone's screen.**
- ④ Open the **Ophelia GO** application.

> The connection between your phone and the drone will be established automatically.



All of the operations shown in this manual are demonstrated using **MODE 2**.

## • Pre-Flight Checklist

1. Make sure the transmitter, mobile device, and the drone battery are fully charged.
2. Make sure the drone battery and the propellers are mounted securely.
3. Make sure the drone arms are unfolded.
4. Make sure the camera is functioning normally.
5. Make sure that there is nothing obstructing the motors and that they are functioning normally.

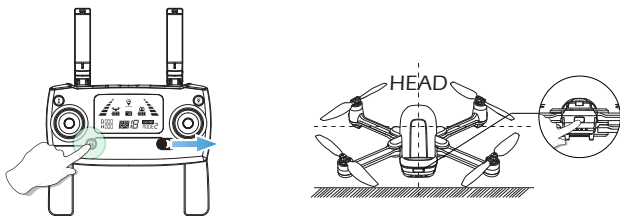
## 9.3 Pairing



- ① Simultaneously hold the “” button and slide the power switch to the right to power on the transmitter. It will beep 2 times and the signal icon “” will keep flashing.
- ② Long press the Power Switch to turn on the drone, and place it on a level surface with the head forward.
- ③ Once the transmitter sends out a long beep sound and the signal icon “” is shown on the LCD screen, which means that the drone has been successfully paired with the transmitter.



## 9.4 Calibrating the Compass

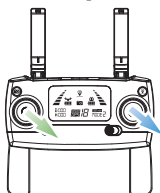

**Step 1:** As shown in the figure above, push both of the joysticks down to the bottom right at the same time to enter the compass calibration.

When the “✖” icon appears on the LCD screen in the state of slow flashing and the indicator lights flash yellow slowly, it indicates that the drone can start compass calibration.

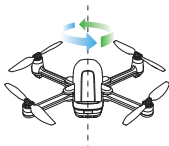

**Step 2:** Hold the drone horizontally and rotate the drone in 3 complete circles. When completed the green lights will flash.

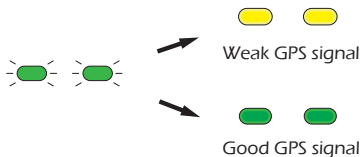
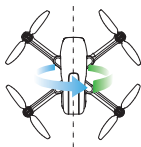

**Step 3:** Hold the drone vertically and rotate the drone in 3 complete circles. When completed the indicator lights will turn solid green and “✖” on the LCD screen changes from slow flash to disappear.

**Attention:**

- DO NOT calibrate the compass in locations where magnetic interference may occur, such as close to magnetite deposits or large metallic structures such as parking structures, steel reinforced basements, bridges, cars, or scaffolding.
- DO NOT carry objects (such as mobile phones) that contain ferromagnetic materials near the drone during calibration.

## 9.5 Unlocking/Locking

### 9.5.1 Unlocking the Motor

Please unlock the motor before take-off.

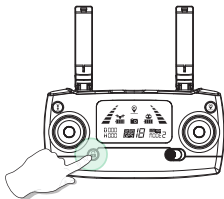

Short press the red button “”. The motors rotate and the drone is unlocked.

### 9.5.2 Locking the Motor

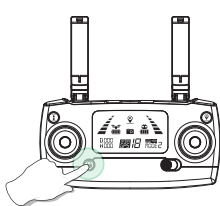

Pic. 7





Pic. 8

**Method 1:** Long press the red button “” for 3 seconds, the motors will stop rotating immediately and the drone locks. (Pic.7)

**Method 2:** After drone lands pull the throttle joystick to the bottom position and hold it for 3 seconds. The motor will stop rotating and the drone will be locked. (Pic.8)

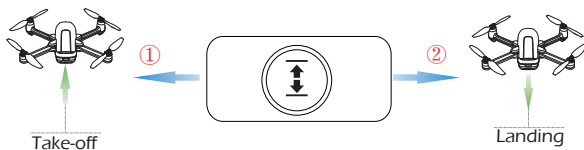
## 9.6 One Key Takeoff/Landing



- ① After unlocking the drone, short press the “

**Tip:** Before flying, make sure the GPS Mode is turned on in case the drone gets lost!

---

## 10.0 FUNCTION DETAILS

### 10.1 Camera Angle Adjustment

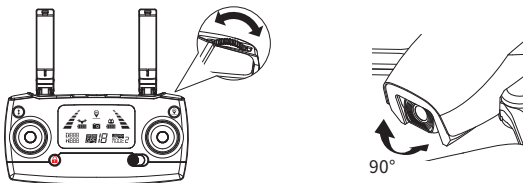

During the flight, you can dial the wheel left/right to tilt the camera up/down.  
(The gimbal has an 90° tilt range.)

## 10.2 Return to Home (RTH)

- The Return to Home function brings the drone back to the last recorded Home Point.
- The Home Point is the location at which the drone takes off or the GPS receives a signal from 7 or more satellites for the first time during the flight. The current position of the drone will be recorded as the Home Point.

---

### 10.2.1 Smart RTH

If the GPS signal is available (7 or more satellites reception) and the home point is recorded previously, press the “” button on the transmitter, then the drone will fly back to the Home Point.

Exit the RTH mode by pressing the “” button again or pushing the Throttle Joystick.

---

### 10.2.2 Failsafe RTH

If the GPS signal is available (at least 7 satellites) and the home point is recorded previously. Failsafe Return will be triggered if the transmitter signal is lost for more than 6 seconds. The drone will automatically start the return procedure and it will fly back to the last recorded Home Point. You can exit “Failsafe RTH” mode by pressing the “” button or pushing the Throttle Joystick if the transmitter signal is recovered.



- During the Failsafe Return procedure, the drone can not avoid obstacles.
- The drone cannot Return-to-Home if the GPS signal is weak (satellites number is less than 7).
- If there is no GPS signal or the transmitter signal has been lost for more than 6 seconds, the drone will not Return-to-Home but it can descend slowly until landing on the ground and locking the drone.

## 10.2.3 Low Voltage RTH

① When the drone's red indicator light flashes slowly, the “” symbol is displayed on the screen of the transmitter, the First Low Voltage RTH will be triggered. And the drone will return automatically in the following two conditions: (At this time, the drone can only fly within a safe range of the height no more than 98 feet and the distance no more than 328 feet.)

a. When the flight altitude is higher than 98 feet, the drone will fly back above the Home Point then descend automatically to 98 feet high and exit the First Low Voltage RTH.

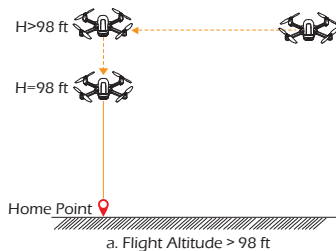

b. When the flight altitude is lower than 98 feet, the drone will elevate automatically to 98 feet high then fly back above the Home Point and exit the First Low Voltage RTH.

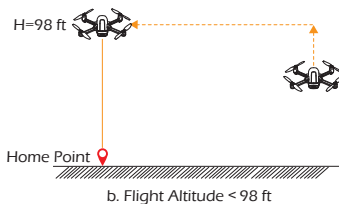

② If the drone's red indicator light begins to flash rapidly the “” symbol will be displayed on the transmitter screen and the transmitter will emit a “Di..., Di...” alert. The Second Low Voltage RTH is automatically triggered.

a. When the flight altitude is higher than or equal to 49 feet, the drone will stay in the current altitude and return above the Home Point then descend vertically.

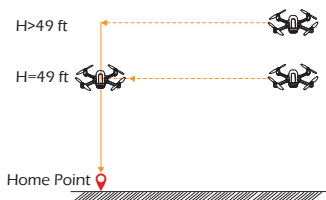

a. Flight Altitude  $\geq 49$  ft

b. When the flight altitude is lower than 49 feet, depending on the flight distance, there are two cases:

**b.1 Flight Distance  $\geq 49$  ft:** The drone will elevate automatically to 49 feet high then fly back above the Home Point and descend vertically.

**b.2 Flight Distance  $< 49$  ft:** The drone will descend vertically and directly on the spot.

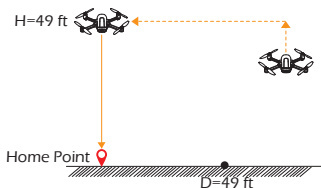

b.1 Flight Altitude  $< 49$  ft  
Flight Distance  $\geq 49$  ft

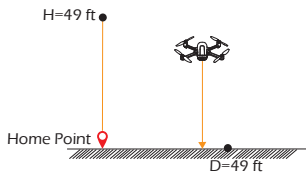

b.2 Flight Altitude  $< 49$  ft  
Flight Distance  $< 49$  ft

## 10.3 Optical Flow Positioning

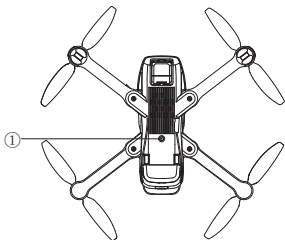

The Optical Flow Positioning System consists of a camera ① module, which acquires the position information of the drone through visual images to ensure precise positioning of the drone.

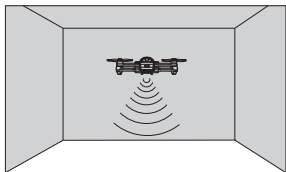

The Optical Flow Positioning System is typically used in an indoor environment when GPS is weak or unavailable. It works best when the drone altitude is less than 10 feet/3 meters.



The precision of the Optical Flow Positioning System is easily affected by the light strength and features of the surface textures. Once the image sensor is not available, your drone will switch to Gesture Mode automatically. Be cautious to operate the drone in the following situation:



1. Fly fast at an altitude below 0.5m.
  2. Fly over monochrome surfaces (like pure black, pure red, pure red and pure green).
  3. Fly over strong light reflective surfaces or surfaces prone to reflection.
  4. Fly over water or transparent object surfaces.
  5. Fly over moving object surfaces (such as crowds, swaying juggles and glass).
  6. Fly over an area where light changes dramatically and rapidly.
  7. Fly over surfaces extremely dark ( $\text{lux} < 10$ ) or extremely bright ( $\text{lux} > 10,000$ ).
  8. Fly over surfaces without clear textures.
  9. Fly over surfaces with highly repeating textures (small grid brick in the same color).
  10. Fly over surfaces that are tilting over 30 degrees (could not receive the echo of the ultrasonic wave).
  11. Flying speed should be controlled not to be too fast. When drone is 1 meter from the ground, the flying speed should not be over 5m/s. When the drone is 2 meters against the ground, the flying speed should not be over 10m/s.
- Keep sensors clean at all times.
  - The vision system is only effective when the drone is within the altitude range of 10 feet/3 meters.
  - Make sure that the light is bright enough and the surface is with clear textures so that the vision system can acquire the movement information through recognizing the ground textures.
  - The vision system may not function properly when the drone is flying over water, low light ground and surfaces without clear patterns or textures.

# 11.0 APP OPERATION INSTRUCTION

## 11.1 Operation Interface

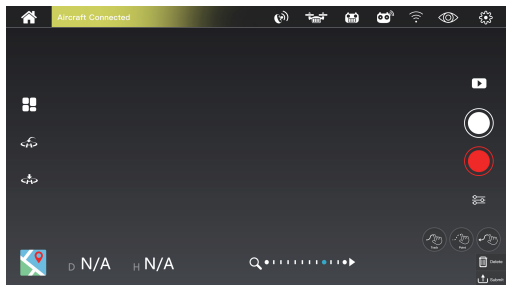

Homepage



GPS Signal



Drone  
Battery Level



Transmitter  
Battery Level



Transmitter  
Signal Strength



Wi-Fi Signal  
Strength



Hide  
On/Off

3D VR

180° Screen  
Rotation



General Settings



Follow Me



Point of  
Interest



Headless  
Mode



RTH Switch



One Key Takeoff/  
Landing



Gallery



Take Photo



Record  
Video



Camera  
Parameters



TapFly



Delete



Submit



Zoom in  
and out



Distance  
(m)



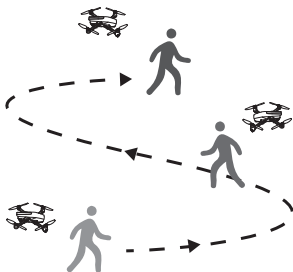

Height  
(m)

## 11.2 Follow Me



When the Follow Me function is enabled, the drone will follow the GPS in your phone to follow you wherever you go.



1. Ensure the drone's flight range is within 16~98 feet.
2. Click the “” icon first, then select the “” icon, and follow the prompt box to enter the Follow Me function — the drone will now follow the phone's coordinates.
3. To exit Follow Me Mode, simply click the “” icon on the app interface again.

### Common Issues:

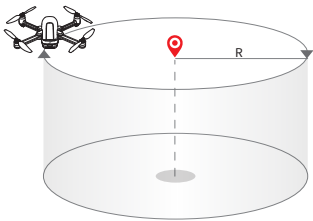

- ① The Follow Me function can only be used if the flight range is within 16~98 feet.
- ② Follow Me mode may be difficult to activate if the phone's GPS signal is too weak. This could be due to the signal loss from surrounding buildings, trees, or congestion from too many mobile phones in the area.
- ③ Use in an open area and be mindful of your surroundings. The drone is NOT equipped with obstacle avoidance.

## 11.3 Point of Interest



1. Click the “” icon first, then select the “” icon, and follow the prompt box to enter the Point of Interest function.
2. The drone will record its flight position the moment you enter this function as the point of interest. The drone will now continuously circle clockwise around the preset point. (The default radius is 16 feet.)
3. To exit Point of Interest mode, simply click the “” icon on the application interface again.

## 11.4 Headless Mode

- ① Click the “” icon first, then select the “” icon, and follow the prompt box to enter the Headless Mode.
- ② Exit the Headless Mode by clicking the “” icon again.

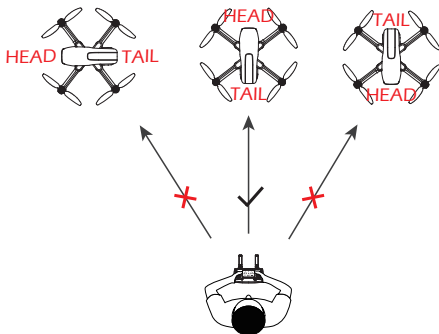

**Please make the pilot stays facing the same direction as the direction that the head of the drone faces at take-off.**

While in Headless Mode, pushing the direction joystick forward will make it fly in the direction that the head of the drone faces when it takes off.

To make sure that the pilot can tell drone's direction, during the flight, we recommend that the pilot stays facing the same direction that the drone head faces at take-off.



By doing so it is ensured that when the pilot pushes the direction joystick forward/backward, the drone will fly forward/backward toward him/her. If the pilot moves the direction joystick left/right, the drone will move left/right relative to him/her.

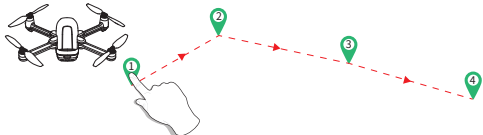

## 11.5 TapFly

It is recommended to enlarge the map if you want to use TapFly.



1. Please click on the Map first, then click the “” icon, and follow the prompt box to enter the TapFly function.

**MODE 1:** Click the “” icon on the app interface, draw a line on the screen to create a path, click “” icon to submit the route, and the drone will fly along the path.

**MODE 2:** Click the “” icon on the app interface, set any point on the screen, click “” icon to submit the route. The drone will now fly along the path according to the points connected on the map.

2. Exit the TapFly mode by clicking the “” icon again.



3. If the flight path submission fails, you can choose to re-submit or exit again.









· DO NOT fly the drone towards people, animals, or small/fine objects (e.g. tree branches and power lines) or transparent objects (e.g. glass or water).

· There may be some deviation between the expected and actual flight path.

## 11.6 Take Photo/Record Video

- ① Click the “” icon to take a photo, click once to take a photo.
- ② Click the “” icon to record the video, click once to start recording, and click again to stop recording.
- ③ Click the “” icon to enter the gallery for viewing.
- ④ Without the TF card installed, the photos and videos will be saved in app albums.
- ⑤ After installing the TF card, the photos and videos will be saved in both the app album and the TF card.
- ⑥ If you want to view the photos and videos stored in the TF card in the application, please make sure that the phone is connected to the Wi-Fi of the drone.

## 12.0 DRONE STATUS INDICATOR

Indicator Status	Meanings
 The indicator lights flash yellow rapidly.	The drone is not connected to the transmitter.
 The indicator lights turn solid yellow.	No GPS signal or weak GPS signal.
 The indicator lights turn solid green.	Good GPS signal.
 The indicator lights flash green slowly.	Compass Horizontal Calibration has completed.
 The indicator lights flash red slowly.	Entering the First Low Voltage RTH.
 The indicator lights flash red rapidly.	Entering the Second Low Voltage RTH.



## 13.0 SPECIFICATIONS

### DRONE

Model: HS710

Weight: 245g/8.64oz

Max Flight Time: 23 minutes (per battery)

Operating Temperature Range: 32° to 104°F

Size: 268 x 301 x 54 mm (Unfolded)

147 x 92 x 54 mm (Folded)

---

### DRONE BATTERY

Capacity: 1820 mAh

Voltage: 7.7 V

Battery Type: Li-Po

Energy: 14.014 Wh

Charging Temperature Range: 41° to 104°F (5° to 40°C)

Charging Time: about 2.5 hours

---

### TRANSMITTER

Operating Frequency: 2.452-2.474 GHz

Transmitter Power (EIRP): <16 dBm

Max Flight Distance: 1968 feet/600 m (outdoor and unobstructed)

Battery Type: 2×1.5V AA batteries (Not included)

Operating Temperature Range: 32° to 104°F

## CAMERA

Operating Frequency: 5.745 GHz

Max Photo Resolution: 3840×2160P

Max Video Resolution: 3840×2160P@15fps

Lens: FOV 120°

Max Transmission Distance: 984 feet/300 m (outdoor and  
unobstructed)

Photo Formats: JPEG

Video Formats: AVI/MP4

Supported TF Cards: Supports a TF Card with a capacity of up to  
32 GB (Not included)

Controllable Range: Pitch: -90° to 0°

Operating Temperature Range: 32° to 104°F

---

## USB CHARGING CABLE

Input: 5 V/2A

Rated Power: ≤10 W

## 14.0 TROUBLE SHOOTING

No.	Problem	Solution
1	The propellers spin, but the drone cannot take-off.	<ol style="list-style-type: none"><li>1. Recharge the battery.</li><li>2. Install the propellers in right orientation.</li><li>3. Replace the propellers.</li></ol>
2	The drone vibrated in flight.	The propeller is damaged. Please replace it with the new propeller.
3	The drone could not be unlocked and the rear light flashed.	The drone battery voltage is too low. Please fully charge the battery.

## 15.0 CONTACT US

Please do not hesitate to contact us if you need further support.

✉ [usa@holystone.com](mailto:usa@holystone.com) (America)  
[ca@holystone.com](mailto:ca@holystone.com) (Canada)  
[eu@holystone.com](mailto:eu@holystone.com) (Europe)

☎ +1(855) 888-6699



For online support, please scan  
this code with Live Chat

## 16.0 GENERAL INFORMATION

### FCC Statement:

Any Changes or modifications not expressly approved by the party responsible for compliance could void the user's authority to operate the equipment.

This device complies with part 15 of the FCC Rules. Operation is subject to the following two conditions:

- (1) This device may not cause harmful interference, and
- (2) This device must accept any interference received, including interference that may cause undesired operation.

NOTE: This equipment has been tested and found to comply with the limits for a Class B digital device, pursuant to Part 15 of the FCC Rules. These limits are designed to provide reasonable protection against harmful interference in a residential installation. This equipment generates uses and can radiate radio frequency energy and, if not installed and used in accordance with the instructions, may cause harmful interference to radio communications. However, there is no guarantee that interference will not occur in a particular installation. If this equipment does cause harmful interference to radio or television reception, which can be determined by turning the equipment off and on, the user is encouraged to try to correct the interference by one or more of the following measures:

- Reorient or relocate the receiving antenna.
- Increase the separation between the equipment and receiver.
- Connect the equipment into an outlet on a circuit different from that to which the receiver is connected.
- Consult the dealer or an experienced radio/TV technician for help.

WARNING: Changes or modifications not expressly approved by the party responsible for compliance could void the user's authority to operate the equipment.

#### RF Exposure

The equipment complies with FCC radiation exposure limits set forth for an uncontrolled environment. This device should be installed and operated with minimum distance 20cm between the radiator & your body. This part belongs to the drone.

RF warning for Portable device: The device has been evaluated to meet general RF exposure requirement. The device can be used in portable exposure condition without restriction. This part belongs to the transmitter.

#### IC Notice:

This device complies with Canada Industry licence-exempt RSS standard(s). Operation is subject to the following two conditions:

- (1) this device may not cause interference; and
- (2) this device must accept any interference. Including interference that may cause undesired operation of the device.

#### CAN ICES-3 (B)

##### Avis d'Industrie Canada

Le présent appareil est conforme aux CNR d'industrie Canada applicables aux appareils radio exempts de licence L'exploitation est autorisée aux deux conditions suivantes:

- 1) l'appareil ne doit pas produire de brouillage; et

2) l'utilisateur de l'appareil doit accepter brouillage radioélectrique subi même si le brouillage est susceptible d'engendrer le fonctionnement mauvais de l'appareil. Cet appareil numérique de la classe B est conforme à la norme NMB-003 du Canada.

CAN NMB-3 (B)

RF Exposure

Radiation Exposure Statement:

This equipment complies with IC radiation exposure limits set forth for an uncontrolled environment. This equipment should be installed and operated with minimum distance 20cm between the radiator & your body.

Déclaration d'exposition aux radiations:

Cet équipement est conforme aux limites d'exposition aux rayonnements IC établies pour un environnement non contrôlé. Cet équipement doit être installé et utilisé avec un minimum de 20 cm de distance entre la source de rayonnement et votre corps.

## HOW TO RECYCLE THIS PRODUCT

This symbol on the product or its documentation indicates that it must not be disposed of with household waste.

Uncontrolled waste disposal may harm the environment or human health. Please separate your device from other types of waste to recycle it responsibly.

This will help to foster the sustainable re-use of material resources.

We invite you to contact your retailer or inquire at your local town hall to find out where and how the drone can be recycled.

## BATTERY WARNING:

1. Failure to follow all the instructions may result in serious injury, irreparable damage to the battery and may cause a fire, smoke or explosion.



2. Always check the battery's condition before charging or using it.

3. Replace the battery if it has been dropped, or in case of odor, overheating, discoloration, deformation or leakage.

4. Never use anything other than the approval LiPo charger the battery. Always use a balancing charger for LiPo cells or a LiPo cell balancer. It is recommended that you do not to use any other charger than the one provided with the product.

5. The battery temperature must never exceed 60°C (140°F) otherwise the battery could be damaged or ignite.

6. Never charge battery on a flammable surface, near flammable products or inside a vehicle (preferably place the battery in a non-flammable and nonconductive container).

7. Never leave the battery unattended during the charging process. Never disassemble or modify the housing's wiring, or puncture the cells. Always ensure that the charger output voltage corresponds to the voltage of the battery. Do not short circuit the batteries.

8. Never expose the LiPo battery to moisture or direct sunlight, or store it in a place where temperatures could exceed 60°C (car in the sun, for example).

9. Always keep it out of reach of children.

10. Improper battery use may result in a fire, explosion or other hazard.



11. Non-rechargeable batteries are not allowed to be recharged. Rechargeable batteries should be charged under adults' supervision.
12. DO NOT mix different types of batteries including the new and used ones.
13. Batteries must be inserted with the correct polarity.
14. The supply terminals must not to be short-circuited. Regular examination of transformer or battery charger for any damage to their cords, plugs, enclosures and other parts must be done. If there is damage, they must not be used until the damage has been repaired.
15. The packaging has to be kept since it contains important information.
16. This toy should only be connected to the equipment with symbol Class

II. 

EU RF Power(EIRP): <16 dBm (2413MHz ~ 2461 MHz)

#### Caution

- 1.The max operating of the EUT is 45°C. and shouldn't be lower than -10°C.
- 2.The device complies with RF specifications when the device used at 0mm from your body.
- 3.Declaration of Conformity.

We, Xiamen Huoshiquan Import & Export CO., LTD hereby, declare that the essential requirements compliance with the Directive 2014/53/EU, the RoHS Directive 2011/65/EU and Safety Directive 2009/48/EC have been fully fulfilled on our product with indication below:

Product Name: REMOTE CONTROL MODEL/RADIO CONTROLLED

Model/Mark : HS710/HOLYSTONE

The Statement of compliance is available at the following address:

[http://www.holystone.com/Download/CE/HS710\\_EU\\_DOC.pdf](http://www.holystone.com/Download/CE/HS710_EU_DOC.pdf)

This product can be used across EU member states.

## MANUFACTURER INFORMATION

Manufactured by

Xiamen Huoshiquan Import & Export CO.,LTD

Address: Unit. 33, Room 806, NO. 2 Huming Road, Siming District, Xiamen,  
China

+1(855) 888-6699



**Made in China**

