



# Instructions For Use

V1.1



HS161

 [usa@holystone.com](mailto:usa@holystone.com) (USA)    [eu@holystone.com](mailto:eu@holystone.com) (EU)  
[ca@holystone.com](mailto:ca@holystone.com) (CA)    [jp@holystone.com](mailto:jp@holystone.com) (JP)

 1(855) 888-6699

[www.holystone.com](http://www.holystone.com)

# Contents

1.0 Disclaimer&Warning .....	1
2.0 Safety Guidelines .....	1
3.0 Maintenance .....	5
4.0 Package Contents .....	6
5.0 Drone’s Details .....	7
6.0 Transmitter Details .....	8
7.0 Low Battery Warning .....	8
8.0 Joystick Mode .....	9
9.0 Charging the Battery	
Drone Battery .....	10
Transmitter Battery .....	11
10.0 Installation	
Protection Guards .....	12
Drone’s Battery .....	12
11.0 Using the Application	
Download APP .....	13
Connect Wi-Fi Networks .....	13
12.0 Operation Guide	
Pairing .....	14
Calibrating the Gyro .....	15
One Key Start / Landing .....	15
13.0 Functions Details	
Trimmer .....	16
Emergency Stop .....	17
Speed Switch .....	17
Mobile Power Function .....	18
Floodlight Function .....	18
Take Photo/ Video .....	18
Optical Flow Mode .....	20
Headless Mode .....	21
14.0 Specification .....	22
15.0 Trouble Shooting .....	24
16.0 General Information .....	25

## 1.0 DISCLAIMER & WARNING

1. Please read this Disclaimer & Warning and Safety Guidelines carefully before using our product. This product is not recommended for people under the age of 14. By using this product, you hereby agree to this disclaimer and signify that you have read it fully. You agree that you are responsible for your own conduct and any damaged caused while using this product, and its consequences . You agree to use this product only for purposes that are proper and in accordance with local regulations, terms and all applicable polices and guidelines Holy Stone may make available.

2. When using this product, please be sure to strictly abide by the specification requirements and safety guidelines stated in this document. Any personal injury property damage, legal disputes and all other adverse events caused by the violation of the safety instructions or due to any other factor, WILL NOT be Holy Stone’s responsibility.

## 2.0 SAFETY GUIDELINES

### 2.1 Check Before Use

- ① This product is not a toy, but it is a high precision drone that integrates various electronic stability and control mechanisms. Please be sure to setup this drone carefully and correctly to ensure safe, accident-free operation.
- ② Please be sure that the batteries of the drone and transmitter are clean, undamaged and, fully charged.
- ③ Please be sure that all the propellers are undamaged and are installed in the correct orientation.

④ Please do a thorough check of the product before each use. Inspect the integrity of the parts, any signs of cracks and wear of the propeller, battery power and effectiveness of the indicator, etc. If after doing a complete check any issues are found, please refrain from using the product until the issue has been resolved.

## 2.2 Flight Environment

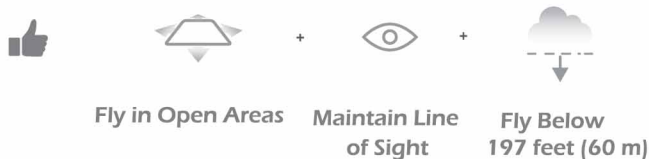

**Avoid flying over or near obstacles, crowds, high voltage power lines, trees, airport or bodies of water.**

**DO NOT fly near strong electromagnetic sources such as power lines and base stations as it may affect the onboard compass.**



**DO NOT use the drone in adverse weather conditions such as rain, snow, fog and strong wind.**

## 2.3 Operations Requirements

- ① Do not follow moving vehicles.
- ② During the flight, only turn off the motor in case of an emergency.
- ③ Please flight the drone back to you as soon as possible when the battery is running low.
- ④ This product should not be used while drinking alcohol, if you are feeling fatigued, taking medicine, or feeling any physical discomfort.
- ⑤ Beware of the noise volume the drone produces. Keep your distance to avoid ear damage.



**Stay away from the rotating propellers and motors.**

**No Fly Zone**

## 2.4 Use of Battery

- ① Please ensure batteries are fitted in the correct orientation as shown in the instruction manual.
- ② Avoid short circuits by fitting the batteries incorrectly, and do not crush or squeeze the batteries as this could carry the risk of an explosion.
- ③ Do not mix new and old batteries as this can lead to a poor performance of the product.
- ④ Dispose used batteries carefully, do not litter.
- ⑤ Please keep dead batteries away from heat and fire.
- ⑥ If the device is not going to be used for an extended period of time, remove batteries to prevent potential damage from battery leakage.

- ⑦ If the device is not going to be used for an extended period of time, remove batteries to prevent potential damage from battery leakage.
- ⑧ It is recommended to only use the USB charging cable that comes with the drone to charge the battery.
- ⑨ Don't connect the battery directly to wall outlets or car cigarette-lighter sockets.
- ⑩ Don't attempt to disassemble or modify the battery in any way.
- ⑪ Don't use the battery if it gives off an odor, generates heat, becomes discolored or deformed, or appears abnormal in any way. If the battery is in use or being charged, remove it from the device or charger immediately and discontinue use.
- ⑫ Don't pierce the battery casing with a nail or other sharp object, break it open with a hammer, or step on it!
- ⑬ Always charge the batteries in a fireproof container and away from combustible materials. Don't charge on surfaces that can catch fire. This includes: wood, cloth, carpet, or in the application's device.
- ⑭ Don't immerse the battery in water or allow it to get wet.
- ⑮ Don't solder battery terminal directly.
- ⑯ Keep battery out of reach of children or pets.
- ⑰ Don't short-circuit the battery by connecting wires or other metal object to the positive(+) and negative(-) terminals.

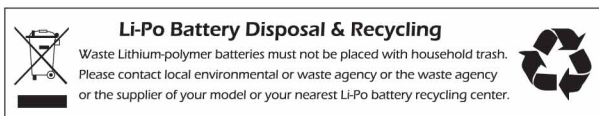

### 3.0 MAINTENANCE

1. Clean the product after each use with a clean, soft cloth.
2. Avoid prolonged exposure to direct sunlight and avoid buildup of heat on the drone.
3. This device is not waterproof and must not be submerged in water under any circumstance. Failure to maintain the device completely dry will result in the failure of the unit.
4. Check the charging plug and other accessories for signs of damage frequently. If any part of the device is damaged, refrain from flying until maintenance can be carried out.

changes or modifications not expressly approved by the party responsible for compliance could void the user's authority to operate the equipment.











This equipment has been tested and found to comply with the limits for a Class B digital device, pursuant to Part 15 of the FCC Rules. These limits are designed to provide reasonable protection against harmful interference in a residential installation. This equipment generates, uses and can radiate radio frequency energy and, if not installed and used in accordance with the instructions, may cause harmful interference to radio communications. However, there is no guarantee that interference will not occur in a particular installation.

If this equipment does cause harmful interference to radio or television reception, which can be determined by turning the equipment off and on, the user is encouraged to try to correct the interference by one or more of the following measures:

- Reorient or relocate the receiving antenna.
- Increase the separation between the equipment and receiver.
- Connect the equipment into an outlet on a circuit different from that to which the receiver is connected.
- Consult the dealer or an experienced radio/TV technician for help.

This equipment complies with FCC radiation exposure limits set forth for an uncontrolled environment. This equipment should be installed and operated with minimum distance 20cm between the radiator and your body. This transmitter must not be co-located or operating in conjunction with any other antenna or transmitter.

## 4.0 PACKAGE CONTENTS

No.	Part Name	Picture	Qty.
1	Drone		1
2	Transmitter		1
3	Drone Battery		1
4	USB Charging Cable		1
5	Propellers		4
6	Propeller Spanner		1
7	Protection Guards		4
8	8GB TF Card <i>(on the fuselage)</i>		1
9	Card Reader		1
10	Screwdriver		1
11	Instructions For Use		1

## 5.0 DRONE'S DETAILS

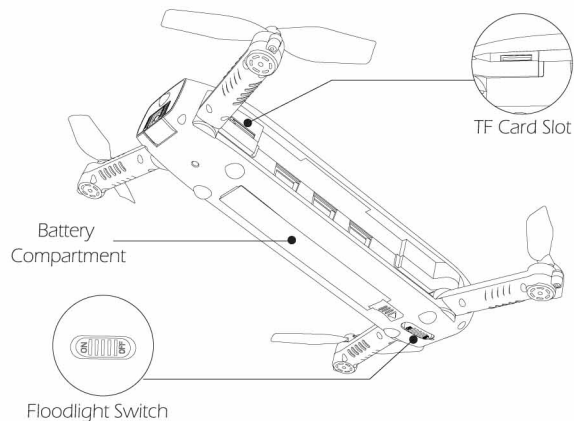
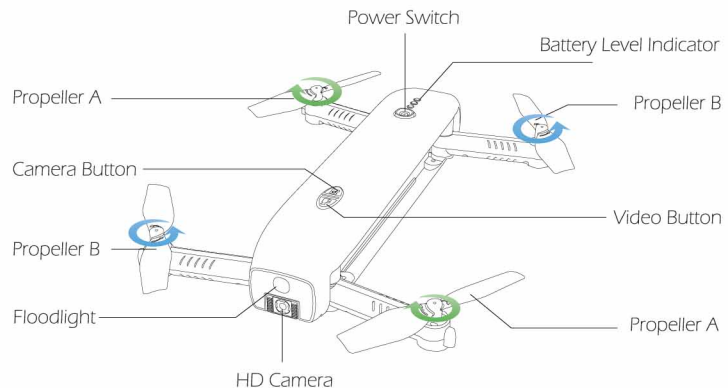

## 6.0 TRANSMITTER DETAILS

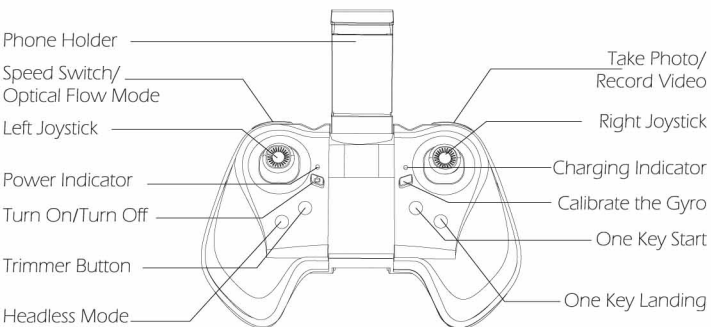

## 7.0 LOW BATTERY WARNING

**DRONE:** When the drone battery runs low, the indicator lights on the drone will blink continuously, and the transmitter will constantly beep. About 1 minute or so the drone will automatically land on low battery power.

**TRANSMITTER:** When the transmitter battery runs low, the power indicator of the transmitter will blink continuously and the transmitter will keep beeping.

## 8.0 JOYSTICK MODE

### 8.1 MODE 2 (Default Setting)

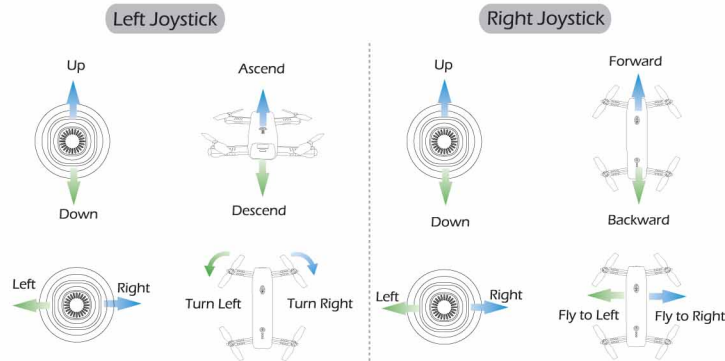

### 8.2 MODE 1

To enter MODE 1, turn on the transmitter while holding the "Speed Switch" button. **(Please do not release the "Speed Switch" button until the transmitter is powered on.)**

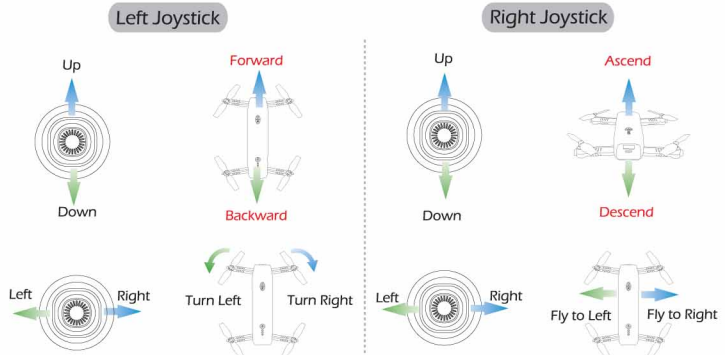

## 9.0 CHARGING THE BATTERY

Please charge the drone and the transmitter when the power is off.

### 9.1 Drone Battery

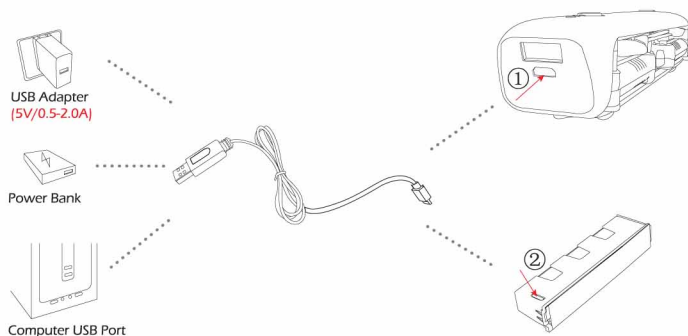

1) There are two ways to charge drone battery:

① Put the battery into the battery compartment of the drone, and connect the USB charging cable to the charging interface of the drone body.

② Remove the battery and connect the USB charging cable to the battery charging interface (the charging efficiency of this method is more efficient).

2) Plug the USB charging cable in to a USB charging port on the computer, power bank or USB adapter (5V @ 0.5 to 2.0A ).

3) The red indicator light will turn on when the battery is charging, and will turn green when the battery is fully charged.

⚠ Before charging, please check the contents of the “ Use of Battery” section of the “ Safety Guidelines” carefully!

### 9.2 Transmitter Battery

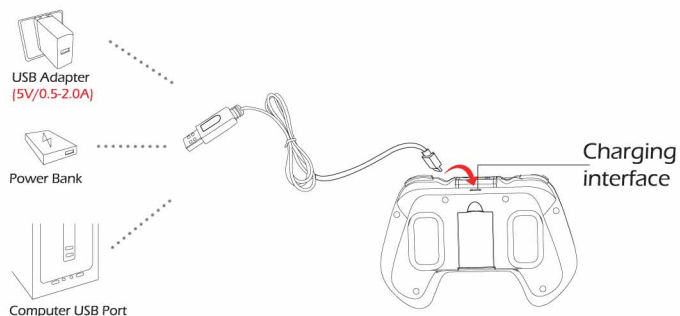

1) Connect USB charging cable and transmitter charging interface.

2) Plug the USB charging cable in to a USB charging port on the computer, power bank or USB adapter. (5V @ 0.5 to 2.0A )

3) The red indicator light on the transmitter will turn on when the battery is charging, and will turn green when the battery is fully charged.

⚠ Before charging, please check the contents of the “ Use of Battery” section of the “ Safety Guidelines” carefully!

## 10.0 INSTALLATION

### 10.1 Protection Guards

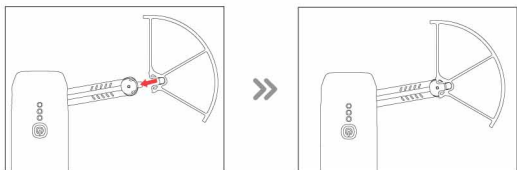

As shown in picture, install the protection guards to the motor base according to the “A/B” corresponding position.

### 10.2 Drone's Battery

**Installation:** Put the “A” side into the battery compartment, and then put the “B” side into the battery compartment to complete the installation.

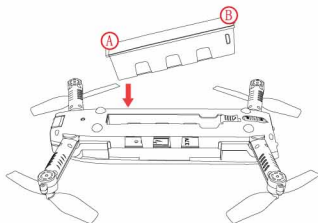

**Removal:** Turn the battery lock button to the right without releasing it, then remove the battery.

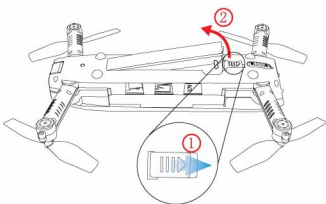

## 11.0 USING THE APPLICATION

### 11.1 Download APP



iOS



Android APP on Google play

Scan the QR code, connect to the App Store™ or Google™ Play and download the “HS Easy Fly” application for free.

Required Operating Systems: iOS 7.0 or later / Android 4.4.0 or later

### 11.2 Connect Wi-Fi Networks

Connect your smart phone to the Wi-Fi of the Drone and check the drone's status on the “HS Easy Fly” App.

- ① On your smartphone, launch a search of the available Wi-Fi networks;
- ② Select the Wi-Fi network: **HolyStoneFPV \*\*\*;**
- ③ Wait for your smartphone to connect Wi-Fi network of the drone.

This connection is generally represented by the Wi-Fi logo appearing on your smartphone's screen.

- ④ Enter the **HS Easy Fly** application.

> The connection between your smartphone and the Drone is established automatically.



## 12.0 OPERATION GUIDE

All of the following operations on this manual takes **MODE 2** for example.

### 12.1 Pairing

① Please unfold the collapsible arms before flight.

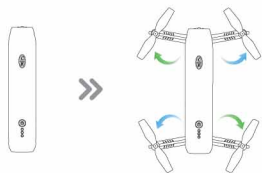

② Place the drone on a flat and level surface with the head forward and the tail towards the pilot.

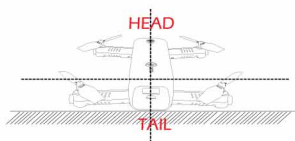

③ Power on the drone and the transmitter.

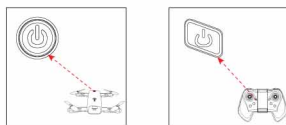

④ Push the left joystick up then down to pair the drone with the transmitter. 2 beeps will be heard from the transmitter, and the LED indicator lights on the drone will turn solid if the drone is paired successfully.

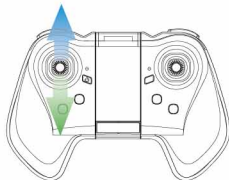

### 12.2 Calibrating the Gyro

Long press the Calibrate the Gyro button for 2 seconds to calibrate the gyroscope of drone. Once the LED lights start to flash rapidly, the gyroscope is being calibrated. When the lights turn solid, calibration is complete.

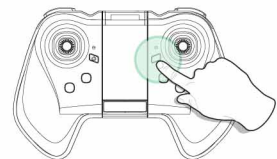

**Tips:** To ensure a stable flight, we suggest that the pilot calibrates the gyro every time after pairing the drone and after a crash.

### 12.3 One Key Start/ Landing

① After pairing / calibration, press the One Key Start button, the propellers will start spinning, indicating this drone is ready to fly, you can control using the joystick.

② When the drone is flying, press the One Key Landing button, the drone will land by itself.

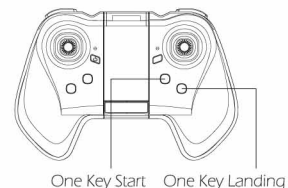

## 13.0 FUNCTIONS DETAILS

### 13.1 Trimmer Function

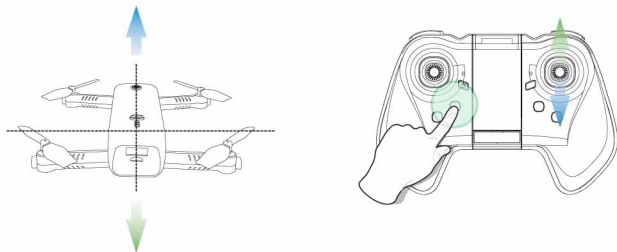

**F/B Sideward Fly Trim :** If the drone drifts forward, press the trimmer button and push the right joystick down at the same time to re-balance the drone.

If the drone drifts backward, press the trimmer button and push the right joystick up at the same time to re-balance the drone.

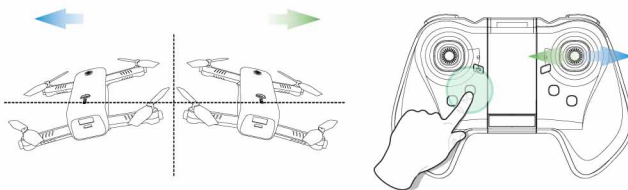

**L/R Sideward Fly Trim:** If the drone drifts left, press the trimmer button and push the right joystick right at the same time to re-balance the drone. If the drone drifts to right, press the trimmer button and push the right joystick left at the same time to re-balance the drone.

*(When you hear a long beep from the transmitter, it indicates that it has been adjusted to the limit.)*

### 13.2 Speed Switch

This drone comes with 3 speed modes (Low/ Medium/ High). Press the Speed Switch button on the upper left of the transmitter to switch the speed. Increase one speed at a time. “Di” indicates Low speed; “Di Di” indicates Medium speed and “Di Di Di” indicates High speed.

*(The Low Speed is default speed mode.)*

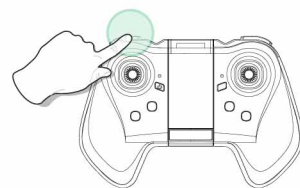

### 13.3 Emergency Stop

**!** The Emergency Stop function can be only used in case of emergency during the flight to avoid any of damage or injury.

Press the upper left and upper right button of the transmitter at the same time, the motors will stop immediately.

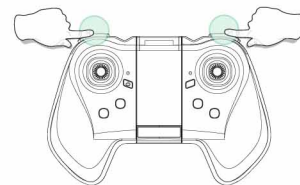

### 13.4 Mobile Power Function

When using the Mobile Power Function, connect the drone and the mobile phone with the phone charging cable (Not included), and the drone will charge the phone.

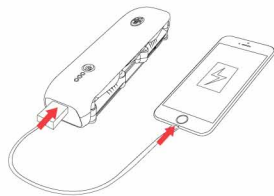

### 13.5 Floodlight Function

As shown in the figure, push the Floodlight Switch to ON, and the floodlight at the head of the drone will turn on. Push the switch to OFF to turn off the floodlight.

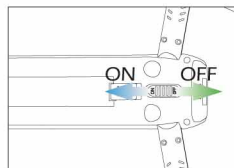

### 13.6 Take Photo / Video

**Do not take photos during the recording, which will interrupt the recording.**

#### 13.6.1 Remote Camera/Video Mode

① **Take Photo:** Short press the Photo / Video button on the transmitter to take pictures. When one beep is heard from the transmitter, this indicates the camera has successfully taken a picture.

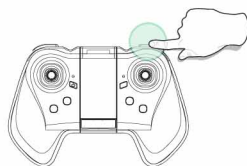

② **Record Video:** Long press the Photo / Video button on the transmitter, 2 beeps from the transmitter will be heard. This tells you that the camera has started recording video. By pressing the Photo / Video button again, 2 beeps from the transmitter indicates to exit recording.

#### 13.6.2 Handheld Camera/Video Mode

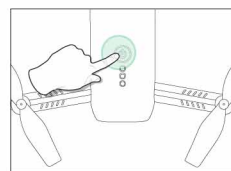

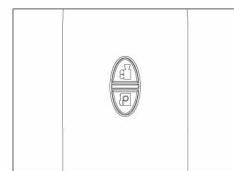

Pic.1



Pic.2

In the non-flight state, long press the Power Switch (**Pic.1**) to enter the Handheld Camera/Video Mode, and the Handheld Camera/Video Indicator (hereinafter referred to as the indicator) lights up. Long press the power switch again to exit.

① **Take Photo:** Short press the "  " button on the fuselage (**Pic.2**), the indicator flashes four times, indicating a picture has been taken.

② **Record Video:** Press the "  " button on the fuselage (**Pic.2**), the indicator keeps flashing, and the camera starts recording. Press the "  " button again to exit recording.

#### Tips:

In the non-flying state, it is necessary to install a TF card on the drone or connect the drone with the mobile phone and enter the APP.

## 13.7 Optical Flow Mode

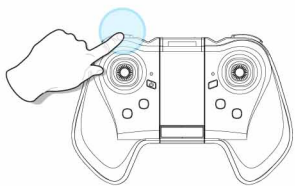

The drone is in Optical Flow Mode by default each time it is turned on. Long press the “Speed Switch” button in the upper left corner of the transmitter to exit the Optical Flow Mode, the transmitter makes a long beep and the lights on the drone flash twice. Long press again to enter.

The performance of the Optical Flow System is affected by the surface being flown over. *When affected, the drone's indicator light will keep flashing and it is recommended to exit the Optical Flow Mode.*

**⚠** Operate the drone with great caution in the following situations:

- ① In low-altitude (under 0.5m/1.5ft) rapid flight, the Optical Flow System may be unable to locate.
- ② Flying over monochrome surfaces (e.g. pure black, pure white, pure red).
- ③ Flying over a highly reflective surfaces.
- ④ Flying over water or transparent surfaces.
- ⑤ Flying over moving surfaces or objects.
- ⑥ Flying over small and fine objects (e.g. tree branches and power lines).
- ⑦ Flying in an area where the lighting changes frequently or drastically.
- ⑧ Flying over surfaces without clear patterns or texture.
- ⑨ Flying over surfaces with identical repeating patterns or textures (e.g. tiling).

## 13.8 Headless Mode

1. After pairing/ calibration, or during the flight of the drone, press the Headless Mode button on the transmitter. The indicator lights on the drone start to flash continuously, and the transmitter will beep constantly to indicate that drone is in Headless Mode.

2. Press the Headless Mode button again, and you will hear 2 beeps, the LED indicator lights on the drone will be solid which indicates the drone exits the Headless Mode.

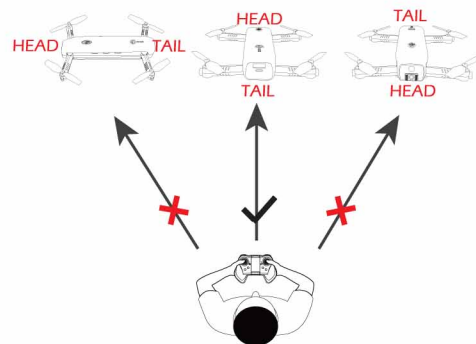

**Please make sure the pilot to stay in the same orientation as the drone head faces when the drone takes off.**

Under Headless Mode, the forward direction is the direction that the head of drone faces when the drone takes off. In order to make sure the pilot can tell drone's direction, we recommend that pilots to stay in the same orientation as the drone's head faces when the drone takes off. When the pilot pushes the direction joystick forward, the drone will fly forward. If the pilot pushes the direction joystick backward, the drone will fly towards him/her. If the pilot move the right stick left/right, the drone will move left/right relative to you.

## 14.0 SPECIFICATIONS

### • DRONE

Model: HS161

Weight: 129g/ 4.55oz

Flight Time: 9.5 minutes

Motor Model: 8620

Operating Temperature Range: 32° to 104°F (0° to 40°C)

Dimensions: 255 x 220 x 32mm

### • DRONE BATTERY

Capacity: 1000mAh

Voltage: 3.7 V

Battery Type: Li-Po Battery

Charging Temperature Range: 41° to 104°F (5° to 40°C)

Charging Time: 110 minutes (depends on charging power and remaining battery power)

### • TRANSMITTER

Operating Frequency: 2.4 GHz

Transmission Distance: 100m (outdoors and unobstructed)

Operating Temperature Range: 32° to 104°F (0° to 40°C)

Battery: Li-Po Battery 3.7V / 250mAh

Charging Method USB (5V): USB charging cable (Micro-USB)

Charging Time: 40~60 minutes (depends on charging power and remaining battery power)

### • CAMERA

Lens Angle : 55°~60°

Video/Photo Resolution: HD1920 x 1080p

Image Return Distance: 50m (outdoors and unobstructed)

Transmission frame rate: 25~30 fps

Photo: JPEG

Video: AVI

Operating Temperature Range: 32° to 104°F (0° to 40°C)

### • USB CHARGING CABLE

Voltage: 5 V

Rated Power: ≤10 W

## 15.0 TROUBLE SHOOTING

Problems	Reasons	Solutions
The indication lights of the drone are flashing and does not respond to the transmitter.	1. Communication between the drone and transmitter is not correct. 2. Battery power is low.	1. Refer to the preparation for flight and pair again. 2. Recharge the battery.
The propellers spin but the drone is unable to take off.	1. The propellers are assembled in wrong orientation. 2. The propellers are damaged.	1. Replace the propellers according to the motors. 2. Replace the propellers
The drone shakes hard-ly in flight.	The propellers are damaged.	Replace the propellers
The drone becomes out of control after crashing.	Gyro sensor lose it's balance after crashing.	Place drone on a level surface for 5-10 seconds, and recalibrate the gyro.

Please do not hesitate to contact us if you need further support.

[usa@holystone.com](mailto:usa@holystone.com) (USA)  
[ca@holystone.com](mailto:ca@holystone.com) (CA)

[eu@holystone.com](mailto:eu@holystone.com) (EU)  
[jp@holystone.com](mailto:jp@holystone.com) (JP)

1(855) 888-6699

## 16.0 GENERAL INFORMATION

FCC Notice:

This device complies with Part 15 of the FCC Rules.

Operation is subject to the following two conditions:

(1) This device may not cause harmful interference.

(2) This device must accept any interference received, including interference that may cause undesired operation.

NOTE: This equipment has been tested and found to comply with the limits for a Class B digital device, pursuant to Part 15 of the FCC Rules. These limits are designed to provide reasonable protection against harmful interference in a residential installation. This equipment generates uses and can radiate radio frequency energy and, if not installed and used in accordance with the instructions, may cause harmful interference to radio communications. However, there is no guarantee that interference will not occur in a particular installation. If this equipment does cause harmful interference to radio or television reception, which can be determined by turning the equipment off and on, the user is encouraged to try to correct the interference by one or more of the following measures:

—Reorient or relocate the receiving antenna.

—Increase the separation between the equipment and receiver.

—Connect the equipment into an outlet on a circuit different from that to which the receiver is connected.

—Consult the dealer or an experienced radio/TV technician for help.

WARNING: Changes or modifications not expressly approved by the party responsible for compliance could void the user's authority to operate the equipment.

## RF Exposure

The equipment complies with FCC radiation exposure limits set forth for an uncontrolled environment. This device should be installed and operated with minimum distance 20cm between the radiator & your body.

## IC Notice:

This device complies with Canada Industry licence-exempt RSS standard(s).

Operation is subject to the following two conditions:

- (1) this device may not cause interference; and
- (2) this device must accept any interference. Including interference that may cause undesired operation of the device.

## CAN ICES-3 (B)

### Avis d'Industrie Canada

Le présent appareil est conforme aux CNR d'industrie Canada applicables aux appareils radio exempts de licence. L'exploitation est autorisée aux deux conditions suivantes:

- 1) l'appareil ne doit pas produire de brouillage; et
  - 2) l'utilisateur de l'appareil doit accepter le brouillage radioélectrique subi même si le brouillage est susceptible d'en compromettre le fonctionnement.
- Cet appareil numérique de la classe B est conforme à la norme NMB-003 du Canada.

## CAN NMB-3 (B)

### RF Exposure

#### Radiation Exposure Statement:

This equipment complies with IC radiation exposure limits set forth for an uncontrolled environment. This equipment should be installed and operated with minimum distance 20cm between the radiator & your body.

## Déclaration d'exposition aux radiations:

Cet équipement est conforme aux limites d'exposition aux rayonnements IC établies pour un environnement non contrôlé. Cet équipement doit être installé et utilisé avec un minimum de 20 cm de distance entre la source de rayonnement et votre corps.

## HOW TO RECYCLE THIS PRODUCT

This symbol on the product or its documentation indicates that it must not be disposed of with household waste.

Uncontrolled waste disposal may harm the environment or human health.

Please separate your device from other types of waste to recycle it responsibly.

This will help to foster the sustainable re-use of material resources.

We invite you to contact your retailer or inquire at your local town hall to find out where and how the drone can be recycled.



## BATTERY WARNING:

1. Failure to follow all the instructions may result in serious injury, irreparable damage to the battery and may cause a fire, smoke or explosion.
2. Always check the battery's condition before charging or using it.
3. Replace the battery if it has been dropped, or in case of odour, overheating, discolouration, deformation or leakage.
4. Never use anything other than the approved LiPo charger to charge the battery. Always use a balancing charger for LiPo cells or a LiPo cell balancer. It is recommended that you do not use any other charger than the one provided with the product.
5. The battery temperature must never exceed 60°C(140°F) otherwise the battery could be damaged or ignite.

5. The battery temperature must never exceed 60°C(140°F) otherwise the battery could be damaged or ignite.
6. Never charger on a flammable surface, near flammable products or inside a vehicle(perferably place the battery in a non-flammable and nonconductive container).
7. Never leave the battery unattended during the charging process. Never disassemble or modify the housing's wiring, or puncture the cells. Always ensure that the charger output voltage corresponds to the voltage of the battery. Do not short circuit the batteries.
8. Never expose the LiPo battery to moisture or direct sunlight, or store it in a place where temperatures could exceed 60°C(car in the sun, for example).
9. Always keep it out of reach of children.
10. Improper battery use may result in a fire, explosion or other hazard.
11. Non-rechargeable batteries are not to be recharged. Rechargeable batteries are only to be charged under adult supervision.
12. Different types of batteries or new and used batteries are not to be mixed.
13. Batteries are to be inserted with the correct polarity.
14. The supply terminals are not to be short-circuited. Regular examination of transformer or battery charger for any damage to their cord, plug, enclosure and other parts and they must not be used until the damage has been repaired.
15. The packaging has to be kept since it contains important information.
16. The toy is only to be connected to Class II equipment bearing the symbol.



EU RF Power(EIRP): 22.75dBm (2404MHz ~ 2480 MHz)

### Caution

- 1.The max operating of the EUT is 45°C. and shouldn't be lower than -10°C
- 2.The device complies with RF specifications when the device used at 0mm from your body.
- 3.Declaration of Conformity.

We, Xiamen Huoshiquan Import & Export CO., LTD hereby, declare that the essential requirements compliance with the Directive 2014/53/EU, the RoHS Directive 2011/65/EU and Safety Directive 2009/48/EC have been fully fulfilled on our product with indication below:

Product Name: Remote control four axis series  
Model/Mark : HS161/HOLYSTONE

The Statement of compliance is available at the following address:  
[http://www.holystone.com/docs/HS161\\_EU\\_DOC.pdf](http://www.holystone.com/docs/HS161_EU_DOC.pdf)

This product can be used across EU member states.

### MANUFACTURER INFORMATION

Manufactured by  
Xiamen Huoshiquan Import & Export CO., LTD  
Room 703,No. 813-2 Xiahe Road, Siming District, XIAMEN, China  
+1(855) 888-6699



**Made in China**