

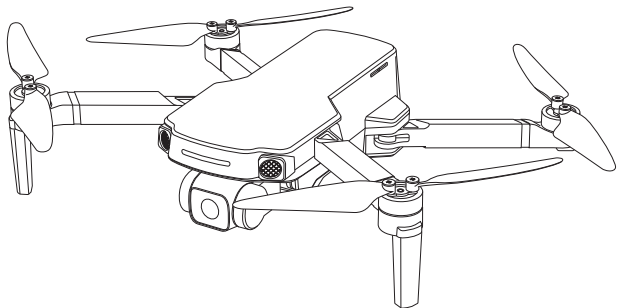



14+
ages

Instructions For Use Gebrauchsanweisung

V1.0



HS360S

 +1(855) 888-6699

 www.holystone.com

 usa@holystone.com (USA)
ca@holystone.com (CA)

eu@holystone.com (EU)

English

01-50

Deutsch

51-97

Contents

Disclaimer & Warning	01
Safety Guidelines	01
Maintenance	05
Package Contents	06
Drone Details	
Drone	07
Battery of the Drone	08
Transmitter Details	
Transmitter Functions	09
LCD-Screen	10
Joystick Mode	11
Charging	
Drone Battery	12
Transmitter	13
Pre-Flight Preparations	
Download APP	14
Camera Cover	14
Drone Battery	15
Arms	16
TF Card	16
Propeller	17
Joysticks	18
Flight	
Pairing.....	19
Connection	20
Compass Calibration	21
Unlocking the Motors	22
Takeoff/Landing	22

Flight Functions

Camera Adjustment	24
Zoom	24
Speed Switch	25
Emergency Stop	25
Photo/Video	26
GPS Return to Home	27

APP Operation Instruction

Operation Interface	30
Beginner Mode	33
Follow Me	34
TapFly	35
Point of Interest	36
Catapult	36
Spiral Up	37
One-key Ascension	37
Shooting Mode	38

Stabilization Function

Altitude-Hold Function	39
Optical Flow Positioning	39

Storage	41
---------------	----

Specifications	42
----------------------	----

Contact Us	44
------------------	----

General Information	45
---------------------------	----

DISCLAIMER & WARNING

1. Please read this Disclaimer & Warning and Safety Guidelines carefully before using our product. This product is not recommended for people under the age of 14. By using this product, you hereby agree to this disclaimer and signify that you have read it fully. You agree that you are responsible for your own conduct and any damage caused while using this product, and any consequence. You agree to only use this product for its designed purposes and in accordance with the local laws, regulations and all applicable policies and guidelines that HolyStone may provide.

2. When using this product, please be sure to strictly abide by the specification requirements and safety guidelines stated in this document. Any personal injury, property damage, legal disputes and all other adverse events caused by the violation of any of the safety instructions or due to any other factor, WILL NOT be HolyStone's responsibility.

SAFETY GUIDELINES

Check Before Use

- ① This product is a high precision drone that integrates various electronic stability and control mechanisms. Please be sure to configure this drone carefully and correctly to ensure safe, accident-free operation.
- ② Ensure that the batteries of the drone and transmitter are clean, undamaged, and fully charged before every use.
- ③ Ensure that all the propellers are undamaged and are installed in the correct orientation.

SAFETY GUIDELINES

④ Please perform a thorough check of the product before each use. Inspect the integrity of the parts, any signs of cracks and wear off on the propellers, battery power and effectiveness of the indicator, etc. If there is any problem found after checking the drone, please refrain from using it until the problem is resolved.

2.2 Flight Environment



+



+



Fly in Open Areas

**Maintain Line
of Sight**

**Fly Below
394 feet (120 m)**



Avoid flying over or near obstacles, crowds, high voltage power lines, trees, airports or bodies of water.

DO NOT fly near strong electromagnetic sources such as power lines and base stations as it may affect the onboard compass.



DO NOT use this drone in adverse weather conditions such as rain, snow, fog, and wind.

SAFETY GUIDELINES

2.3 Operation Requirements

- ① DO NOT use this product to follow any moving vehicles.
- ② During the flight, turn off the motors only in case of an emergency.
- ③ When the battery runs low, return the drone back to your starting point.
- ④ DO NOT use this product if you feel unwell, tired, or are under the influence of alcohol or drugs
- ⑤ Be aware of the volume of noise that the drone produces. Please ensure to keep your distance to avoid ear damage.



- ⑥ **Stay away from the rotating propellers and motors.**

- ⑦ **DO NOT fly in any spaces where drones are prohibited. Please respect people's right to privacy by not flying your drone close to others.**

2.4 Use of Battery

- ① Please ensure batteries are fitted in the correct orientation as shown in the instruction manual.
- ② Avoid short circuits by fitting the batteries correctly, and do not crush or squeeze the batteries as this could cause the risk of a fire or explosion.
- ③ DO NOT mix new and old batteries as this can lead to poor performance of the product.
- ④ Please dispose of used batteries carefully, do not litter, and recycle where ever possible.
- ⑤ DO NOT expose the batteries to heat or fire as this may result in an explosion.

SAFETY GUIDELINES

- ⑥ If the device is not going to be used for an extended period of time, please remove batteries to prevent potential damage to the drone from battery leakage.
- ⑦ Only use the USB charging cable that comes with the drone to charge the battery.
- ⑧ DO NOT connect the battery directly to wall outlets or car cigarette-lighter sockets as their voltages are different, and the battery can thus be damaged.
- ⑨ DO NOT attempt to disassemble or modify the battery in any way.
- ⑩ DO NOT use the battery if it gives off an odor, generates heat, becomes discolored, deformed or appears abnormal in any way. If any of these situations occurs while the battery is in use or being charged, remove it from the device or charger immediately and discontinue its use.
- ⑪ DO NOT pierce the battery casing with a nail or any other sharp object, break it open with a hammer, or step on it! Dispose or recycle the damaged battery as it may cause personal injury or damage to your drone.
- ⑫ Always charge the batteries on a fireproof surface and away from combustible materials. DO NOT charge on surfaces that can catch fire, which includes but not limited to wood, cloth, plastic and carpets..
- ⑬ DO NOT immerse the battery in water or get it wet.
- ⑭ DO NOT solder battery terminal in any way.
- ⑮ Keep batteries out of reach of children or pets.
- ⑯ DO NOT short-circuit the battery by connecting wires or any other metal object to the positive (+) and negative (-) terminals.



Li-Po Battery Disposal & Recycling













Waste Lithium-polymer batteries must not be placed with household trash. Please contact local environmental or waste agency or the waste agency or the supplier of your model or your nearest Li-Po battery recycling center.

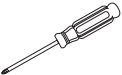

MAINTENANCE

- ① Clean the drone after each use with a clean, soft cloth.
- ② Avoid prolonged exposure to direct sunlight and avoid buildup of heat on the drone or batteries.
- ③ This device is not waterproof. DO NOT allow it to get wet or submerged in water. Failure to keep the device completely dry will result in the failure and permanent damage to the unit. Be aware that although it might be dry where you are, droplets of rain or mist from a river or waterfall could damage your drone while it is flying.
- ④ Frequently check the charging plug and other accessories for signs of damage. If any part of the device or cables are damaged, avoid use or charging until the damaged part is replaced.

PACKAGE CONTENTS

		
Drone	Transmitter	Drone Battery
		
Propeller	USB Charging Cable	Camera Cover
		
Screwdriver	Connection Cable (type-C)	Connection Cable (lightning)
		
Connection Cable (micro-USB)	Joysticks	Instructions For Use

DRONE DETAILS

Drone

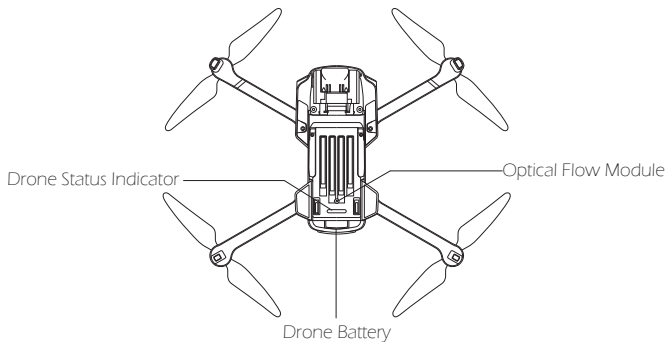
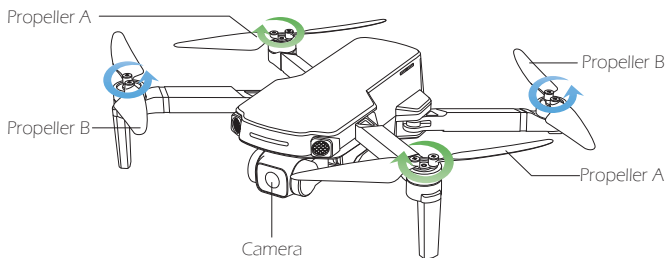

DRONE DETAILS

Battery of the Drone

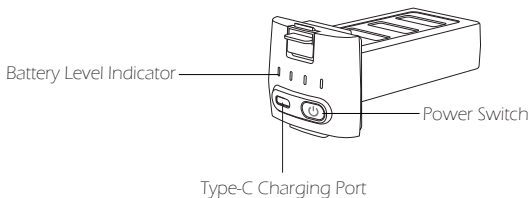

On/Off: Turn the battery on/off by pressing the power switch for 3 seconds. When the battery is on, the battery level indicators will display the current battery status. When the battery is powered off, all the indicators are out.

TRANSMITTER DETAILS

Transmitter Functions

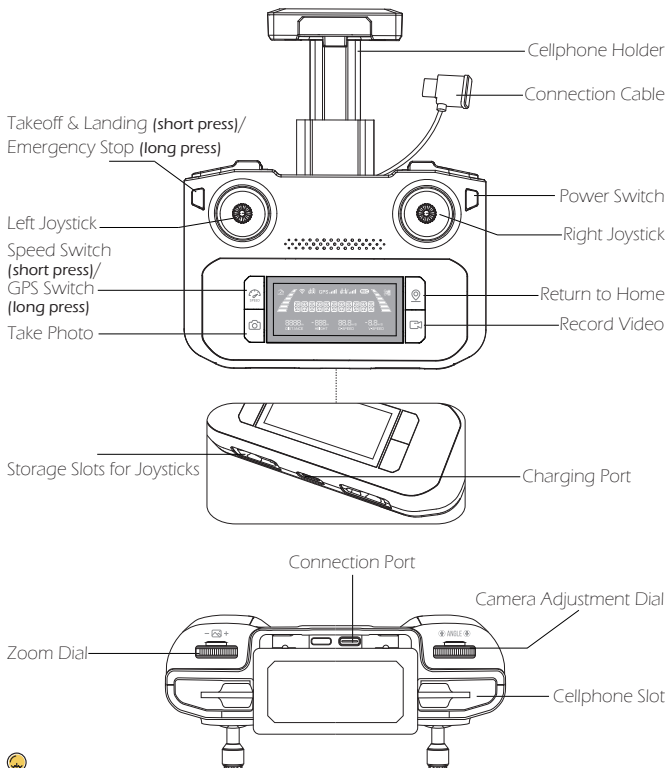

Turning On/Off: Short press the () once to check the battery status of the transmitter. Hold for 3 seconds to turn it on/off.

TRANSMITTER DETAILS

LCD-Screen

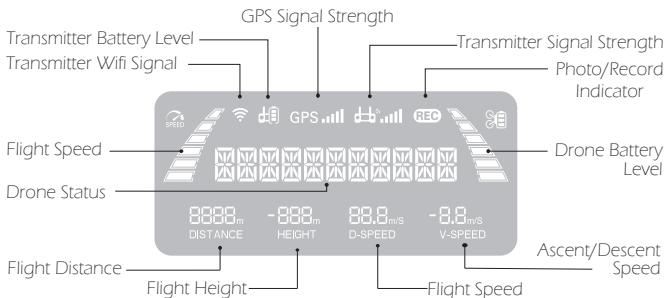



When the battery level of the transmitter is low, its icon (🔋) will start to flash. When this happens, please bring the drone down to the ground immediately and charge the transmitter.

JOYSTICK MODE

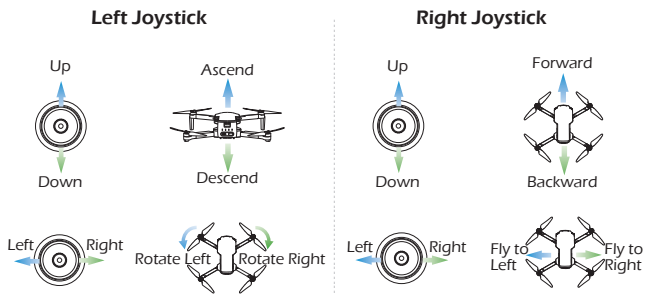
Mode 2 (Left joystick as the gas joystick)



Mode 1 (Right joystick as the gas joystick)

Hold the () button, short press the () button of the transmitter once, then hold the latter until the transmitter quickly beeps 3 times. You will see “R HAND MODE” displayed on the LCD-screen, which means the transmitter is now in Mode 1.

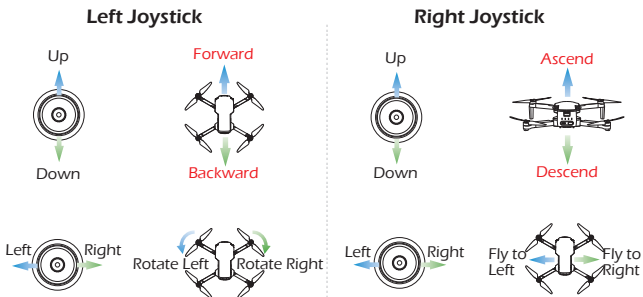

CHARGING

Drone Battery

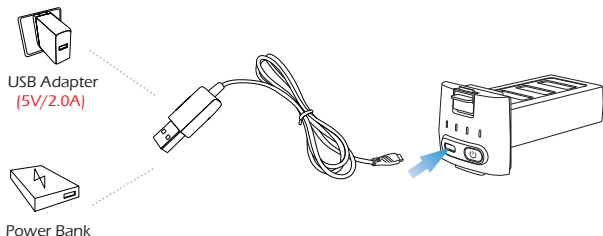

1. Insert the Type-C plug of the charging cable into the drone battery.
2. Plug the other end of the cable into a USB adapter (5V/2A) or power-bank to start charging.
3. When the battery is charging, the battery level Indicators will keep flashing. When it is fully charged, all the Indicators will be on.
4. It takes about 3 hours to fully charge a drone battery. A fully charged battery offers about 20 minutes of flight time.



- Before charging, please read the instructions in the “Use of Battery” section of the “Safety Guidelines” carefully.
- Please use the original charging cable to charge the battery.
- DO NOT charge the drone battery immediately after a flight as the temperature of the battery may be too high. Please wait until it cools down to room temperature before charging again.

CHARGING

Transmitter

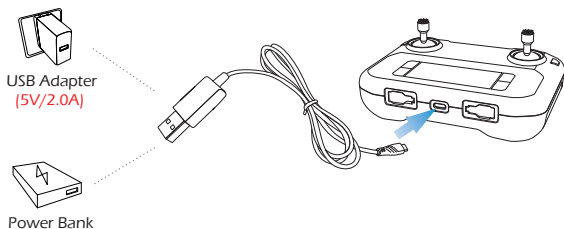

1. Insert the Type-C plug of the charging cable into the Type-C port of the transmitter.
2. Plug the other end of the cable into a USB adapter (5V/2A) or power-bank to start charging.
3. When charging, the cells in the battery level bar will light up in turn. The LCD screen displays "CHARGING."
When the charging is done, all 3 cells will light up and the LCD screen displays "CHARGE DONE."
4. It takes about 2 hours to fully charge the transmitter. A fully charged transmitter offers about 2 hours of usage time.



· Before charging, please read the instructions in the "Use of Battery" section of the "Safety Guidelines" carefully!

PRE-FLIGHT PREPARATIONS

Download APP



iOS



Android APP on Google play

The drone is equipped with a Live-Feed function. Please scan the corresponding QR-code above, and download the “HS FLY” app to use the related functions.

Required operating systems: iOS 11.0 or above/Android 5.1 or above.

Camera Cover

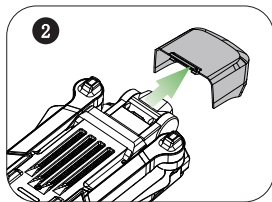
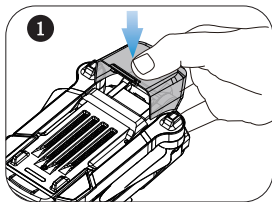

1. Loosen the buckle on the camera cover.
2. Gently pull the cover up, then pull it toward the front of the drone.



Please remove the camera cover before you turn on the drone.

PRE-FLIGHT PREPARATIONS

Drone Battery

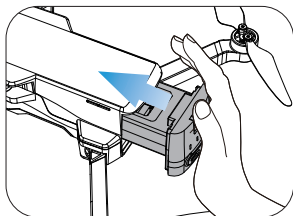

Installation: Push the battery into the fuselage. Make sure you hear a click when inserting the battery, which indicates that it is installed firmly.

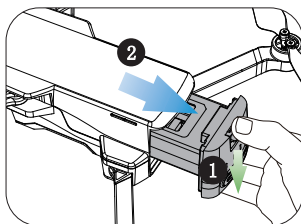

Remove: Press down on the snap and pull the battery out of the fuselage.



- Please make sure that the battery is firmly installed. Otherwise, the flight safety of your drone may be affected. The drone may crash due to a power-cut during the flight.
- Only install/remove the battery when it is powered off.

PRE-FLIGHT PREPARATIONS

Arms

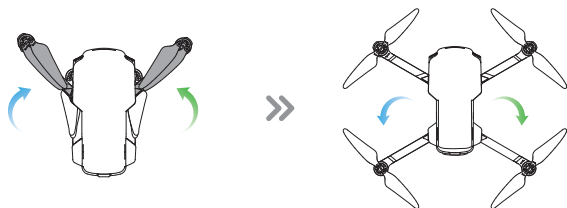

All arms of the drone are folded when it is packaged at the factory. First, unfold the front arms, then unfold the rear arms.

TF Card

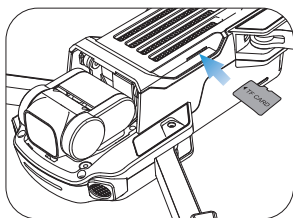

Insert a TF card (**not included**) into the TF card slot before turning on the drone. This drone supports TF card with a max storage of 128GB.

PRE-FLIGHT PREPARATIONS

Propeller

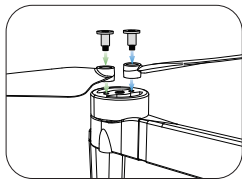
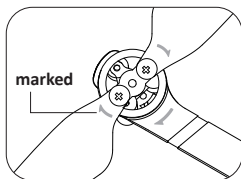

Installation: Install the marked propellers to the marked motor shafts. Use the screwdriver to tighten the two screws in place. Install then the unmarked propellers to the unmarked motor shafts.

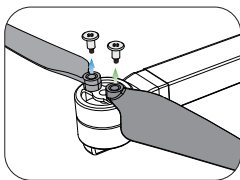
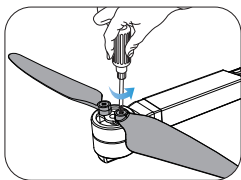

Removal: Use the screwdriver to turn the screws anti-clockwise to remove them. Then pull the propellers up.



- The marked propellers have a different spin direction than the unmarked ones. So please ensure that they are installed to the right motor shafts.
- Before each flight, check if the propellers are secure and tight.
- If the propellers become deformed or damaged, please replace them before flying again.

PRE-FLIGHT PREPARATIONS

Joysticks



Take the joysticks out of the storage slot and mount them onto the transmitter.

FLIGHT

- To avoid unnecessary loss or damage, it is strongly recommended that the pilot flies this drone in an open, outdoor area.
- All of the operations shown in this manual are demonstrated using MODE 2.

Pairing

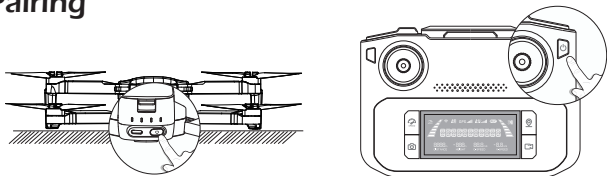

- ① **Turning on the drone:** Long press the power switch to turn on the drone. Place it on a level surface with its head pointing forward. The status LED of the drone starts to blink.
- ② **Turning on the transmitter:** Short press the power switch of the transmitter once, then hold it to turn on the transmitter.

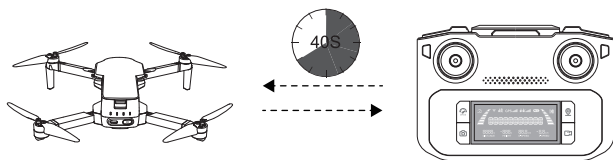

- ③ **Auto-Pairing:** It takes about 40 seconds to pair the transmitter with the drone. During the pairing, the transmitter will keep on beeping. Finally it will long beep once, indicating that the pairing is complete.

FLIGHT

Connection

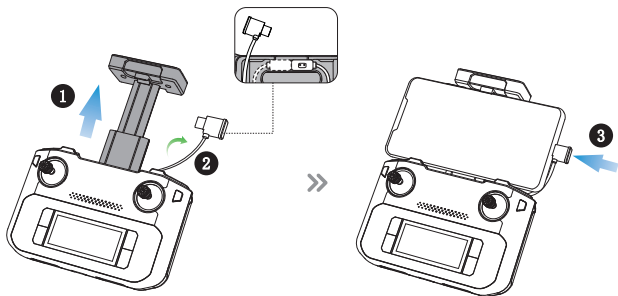

① **Cellphone Connection:** Pull the cellphone holder out. Draw out the connection cable from the transmitter. (A Type-C connection cable is pre-installed. You will also receive a micro-USB and a Lightning type connection cable.) After setting the cellphone into the holder, use the cable to connect the transmitter with the cellphone. Make sure the latter is secured by the holder.

💡 When using an Android phone, please choose "charge only" when the phone asks you to choose a connection mode. Other options may cause the connection to fail.



HS FLY App



② **App:** Run the "HS FLY" app and open up the live-feed interface.

FLIGHT

Compass Calibration

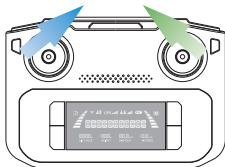

Step 1: Push both joysticks towards the inner, upper corners simultaneously to start the compass calibration. The transmitter beeps once.

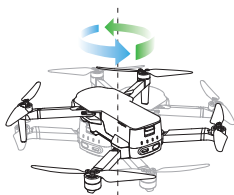

Step 2: Rotate the drone horizontally (keeping it parallel to the floor) until the transmitter beeps once.

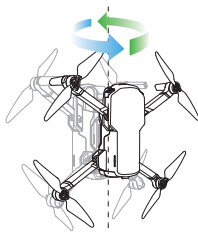

Step 3: Point the head of the drone upward and rotate it till the transmitter beeps again, and the status LED of the drone turns solid blue. The compass calibration is complete.