

9.6 Unlocking

9.6.1 Unlocking the Motor

Please unlock the motor before take-off.

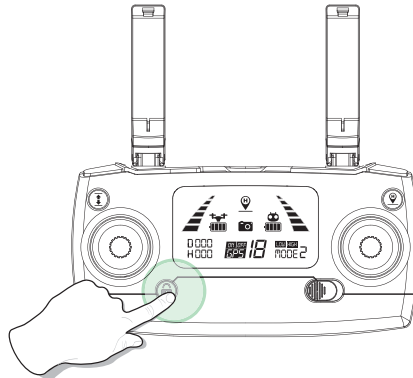

Short press the red button “  ”. The motors rotate and the drone is unlocked.

9.6.2 Locking the Motor

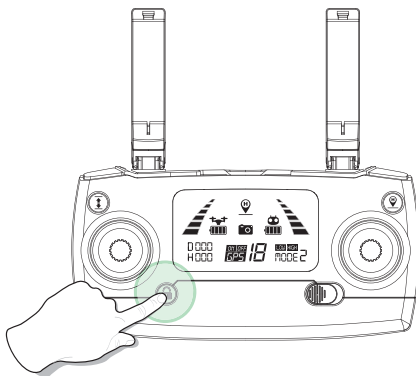

Pic. 7

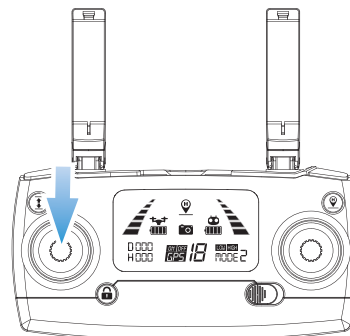



Pic. 8

Method 1: Long press the red button “  ” for 3 seconds, the motors will stop rotating immediately and the drone locks. (Pic.7)

Method 2: After drone lands pull the throttle stick to the bottom position and hold for 3 seconds. The motor will stop rotating and the drone will be locked. (Pic.8)

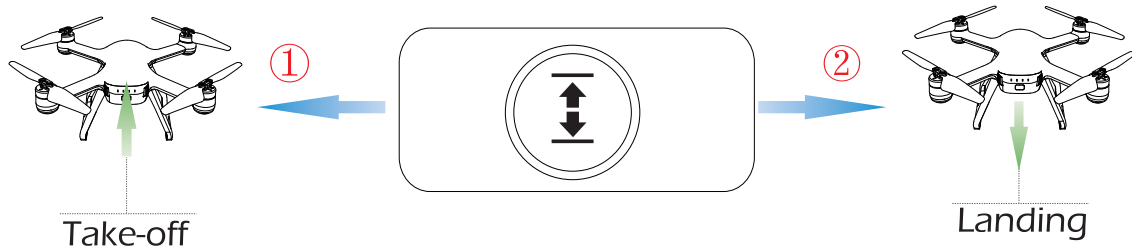
9.7 One Key Takeoff/ Landing



- ① After unlocking the drone, short press the “

Tips:

Before flying, make sure the GPS Mode is turned on in case the drone gets lost!

10.0 FUNCTION DETAILS

10.1 Camera Angle Adjustment

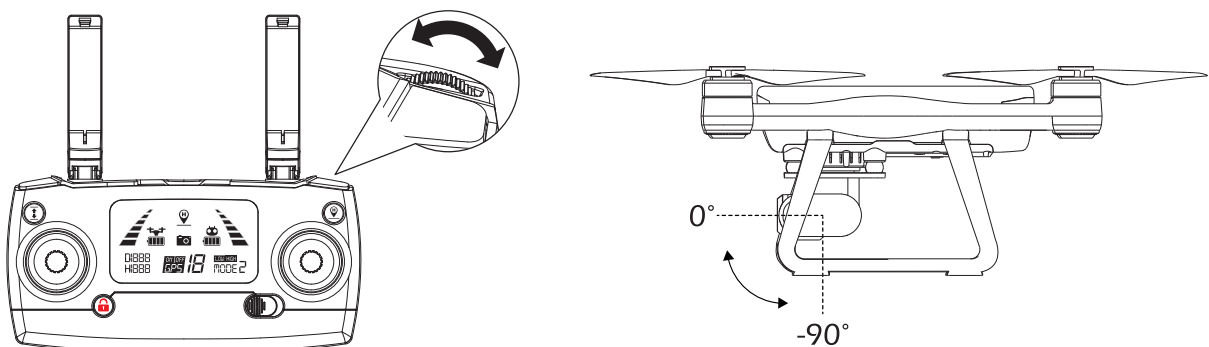

During the flight, you can dial the wheel left / right to tilt the camera up/ down.

(The gimbal has an 90° tilt range.)

10.2 Return to Home (RTH)

- The Return to Home function brings the drone back to the last recorded Home Point.
- The Home Point is the location at which the drone takes off or the GPS receives a signal from 7 or more satellites for the first time during flight. The current position of the drone will be recorded as the Home Point.

10.2.1 Smart RTH

If the GPS signal is available (7 or more satellites reception) and the home point is recorded previously, press the “” button on the transmitter, then the drone will fly back to the Home Point.

Exit the RTH mode by pressing the “” button again or pushing the Throttle Joystick .

10.2.2 Failsafe RTH

If the GPS signal is available (at least 7 satellites) and the home point is recorded previously. Failsafe Return will be triggered if the transmitter signal is lost for more than 6 seconds. The drone will automatically start the return procedure and it will fly back to the last recorded Home Point. You can exit “Failsafe RTH” mode by pressing the “Return to Home” button or pushing the Throttle Joystick if the transmitter signal is recovered.



- During the Failsafe Return procedure, the drone can not avoid obstacles.
- The drone cannot Return-to-Home if the GPS signal is weak (satellites number is less than 7).
- If there is no GPS signal or the transmitter signal has lost for more than 6 seconds, the drone will not Return-to-Home but it can descend slowly until landing on the ground and locking the drone.

10.2.3 Low Voltage RTH

① When the drone's rear lights flash slowly, the “  ” symbol is displayed on the screen of the transmitter, the First Low Voltage RTH will be triggered. And the drone will return automatically in the following two conditions: (At this time, the drone can only fly within a safe range of the height no more than 98 feet and the distance no more than 328 feet.)

a. When the flight altitude is higher than 98 feet, the drone will fly back above the Home Point then descend automatically to 98 feet high and exit the First Low Voltage RTH.

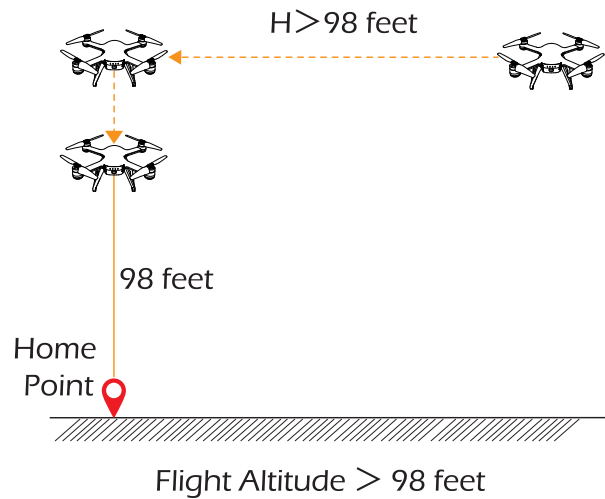

b. When the flight altitude is lower than 98 feet, the drone will elevate automatically to 98 feet high then fly back above the Home Point and exit the First Low Voltage RTH.

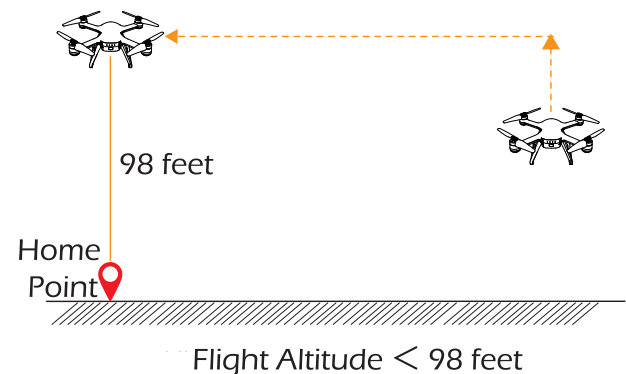

② If the drone's rear lights begin to flash rapidly the "🚁" symbol will be displayed on the transmitter screen and the transmitter will emit a "Di..., Di..." alert. The Second Low Voltage RTH is automatically triggered.

a. When the flight altitude is higher than or equal to 50 feet, the drone will stay in the current altitude and return above the Home Point then descend vertically.

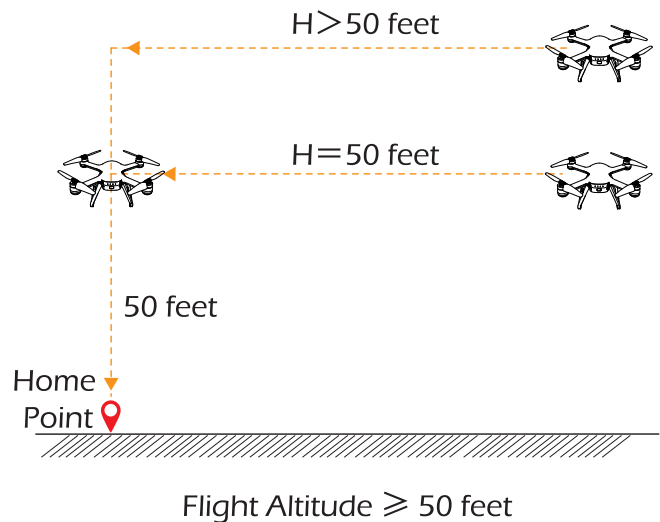

b. When the flight altitude is lower than 50 feet, the drone will elevate automatically to 50 feet high then fly back above the Home Point and descend vertically.

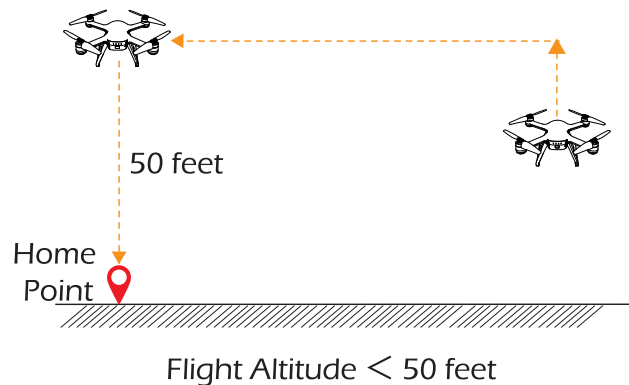

10.3 Optical Flow Positioning

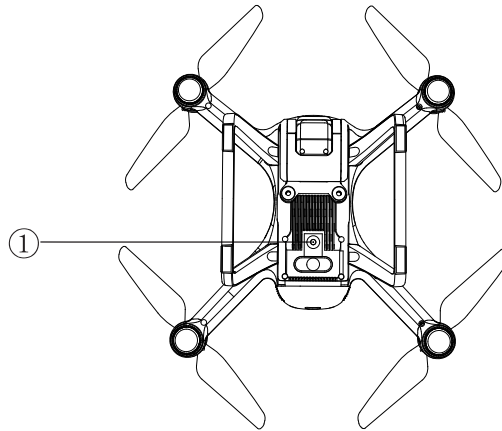

The Optical Flow Positioning System consists of a camera ① module, which acquires the position information of the drone through visual images to ensure precise positioning of the drone.

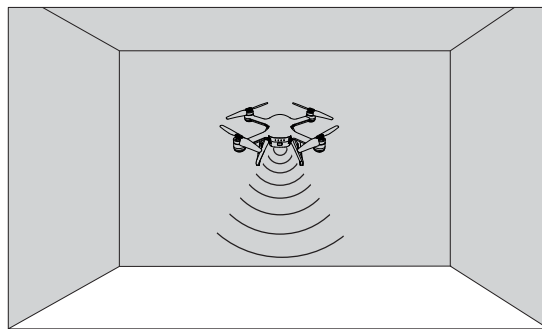

The Optical Flow Positioning System is typically used in indoor environment when GPS is weak or unavailable. It works best when the drone altitude is less than 3 meters.

When in a dark environment, you can turn on the lights by pressing the Light Switch button “” in the upper right corner of the transmitter to facilitate the image positioning function.



The precision of the Optical Flow Positioning System is easily affected by the light strength and features of the surface textures. Once the image sensor

is not available, your drone will switch to Gesture Mode automatically. Be cautious to operate the drone in the following situation:

1. Fly fast at an altitude below 0.5m.
2. Fly over monochrome surfaces (like pure black, pure red, pure red and pure green).
3. Fly over strong light reflective surfaces or surfaces prone to reflection.
4. Fly over water or transparent object surfaces.
5. Fly over moving object surfaces (such as crowds, swaying juggles and glass).
6. Fly over an area where light changes dramatically and rapidly.
7. Fly over surfaces extremely dark ($\text{lux} < 10$) or extremely bright ($\text{lux} > 10,000$).
8. Fly over surfaces without clear textures.
9. Fly over surfaces with highly repeating textures (small grid brick in the same color).
10. Fly over surfaces that are tilting over 30 degrees (could not receive the echo of the ultrasonic wave).
11. Flying speed should be controlled not to be too fast. When drone is 1 meter from the ground, the flying speed should not be over 5m/s. When the drone is 2 meter against the ground, the flying speed should not be over 10m/s.

- Keep sensors clean at all times.
- The vision system is only effective when the drone is within the altitude range of 3 meters.
- Make sure that the light is bright enough and the surfaces is with clear textures so that the vision system can acquire the movement information through recognizing the ground textures.
- The vision system may not function properly when the drone is flying over water, low light ground and surfaces without clear patterns or textures.

11.0 APP OPERATION INSTRUCTION

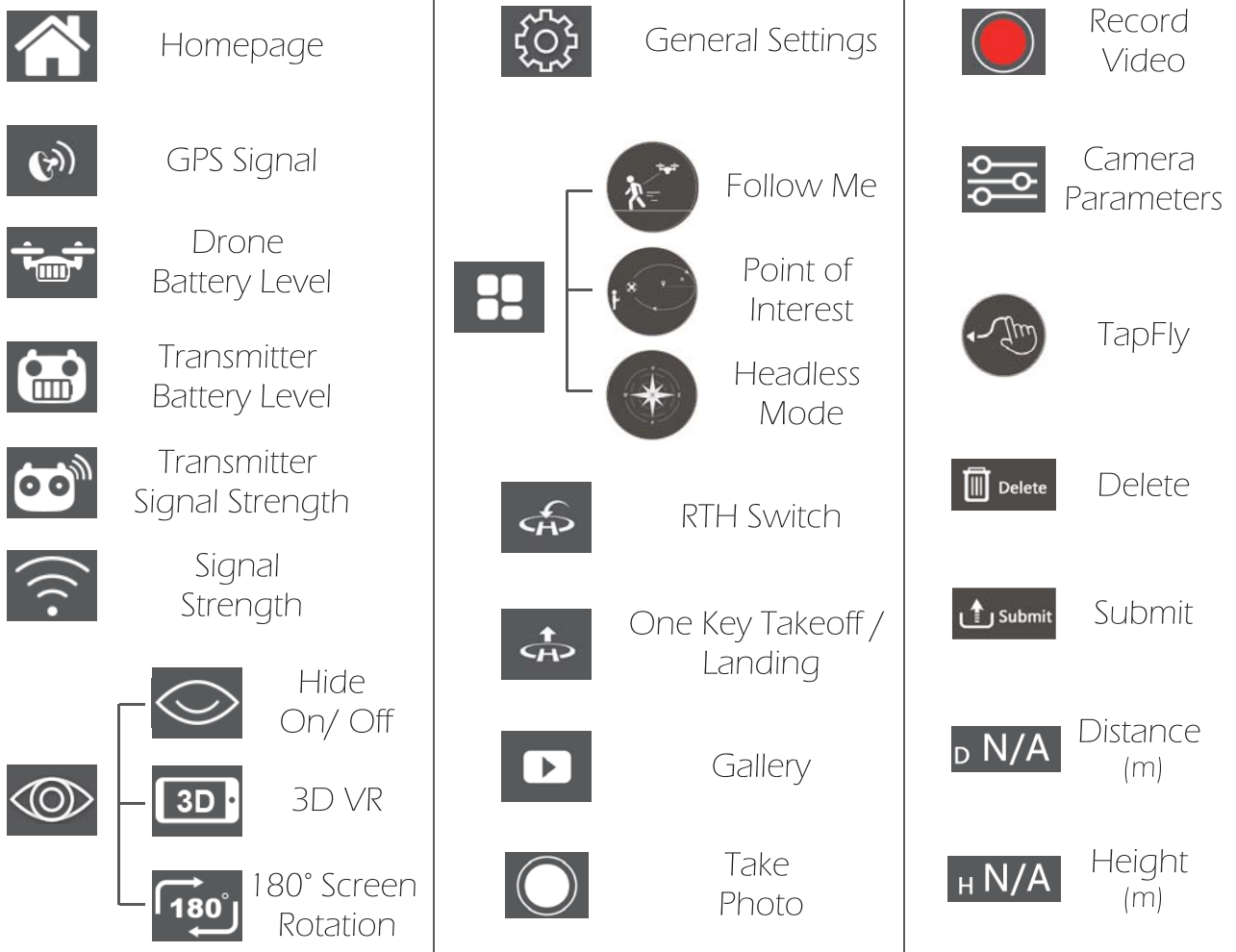
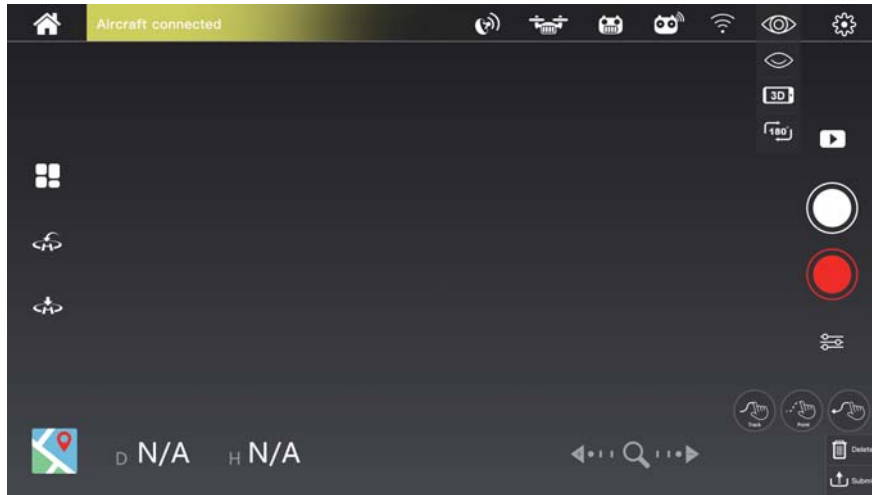

11.1 Operation Interface

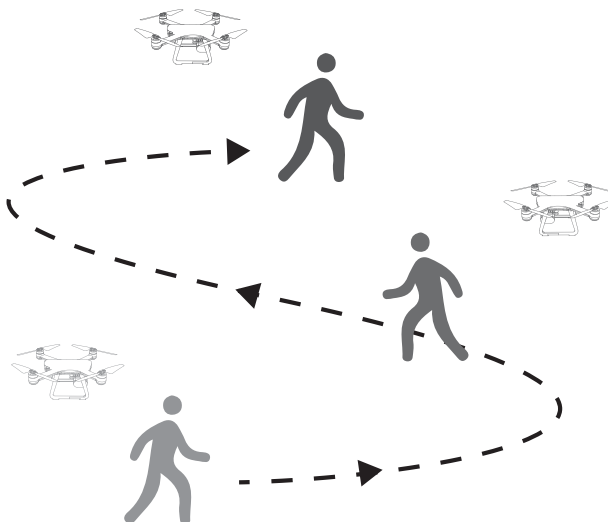

11.2 Follow Me



When the Follow Me function is enabled, the drone will follow the GPS in your smart phone to follow you wherever you go.



1. Ensure the drone's flight range is within 15~95 feet.
2. Click the “” icon first, then select the “” icon, and follow the prompt box to enter the Follow Me function — the drone will now follow the phone's coordinates.
3. To exit Follow Me Mode, simply click the “” icon on the app interface again.

Common Issues:

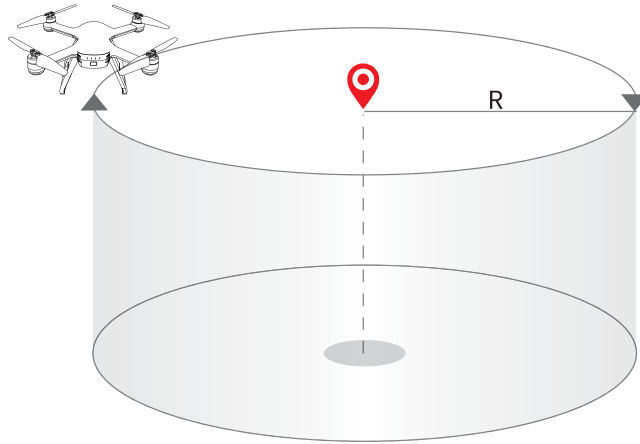

- ① The Follow Me function can only be used if the flight range is within 15~95 feet.
- ② Follow Me mode may be difficult to activate if the phone's GPS signal is too weak. This could be due to the signal loss from surrounding buildings, trees, or congestion from too many mobile phones in the area.
- ③ Use in an open area and be mindful of your surroundings. The drone is NOT equipped with obstacle avoidance.

11.3 Point of Interest



1. Click the “” icon first, then select the “” icon, and follow the prompt box to enter the Point of Interest function.
2. The drone will record its flight position the moment you enter this function as the point of interest. The drone will now continuously circle clockwise around the preset point. (The default radius is 16 feet.)
3. To exit Point of Interest mode, simply click the “” icon on the application interface again.

11.4 Headless Mode

- ① Click the “” icon first, then select the “” icon, and follow the prompt box to enter the Headless Mode.
- ② Exit the Headless Mode by clicking the “” icon again.

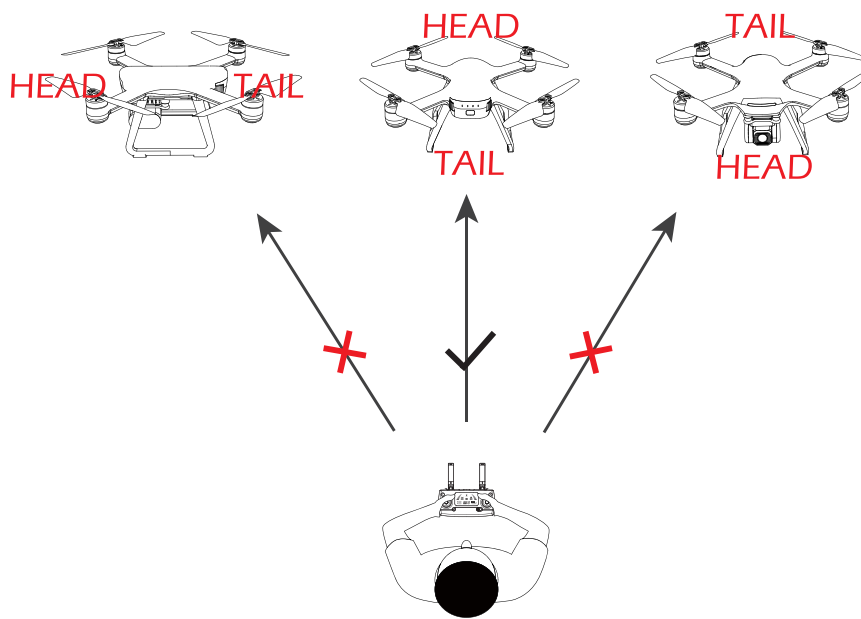

Please make the pilot stays facing the same direction as the direction that the head of the drone faces at take-off.

While in Headless Mode, pushing forward on the joystick will make it fly in the direction that the head of the drone faces at take-off.

To make sure that the pilot can tell drone's direction, we recommend that pilots stay facing the same direction that the drone head faces at take off.



By doing so it is ensured that when the pilot pushes the direction joystick forward/ backward, the drone will fly forward/ backward toward him/ her. If the pilot move the right stick left/ right, the drone will move left/ right relative to the pilot.

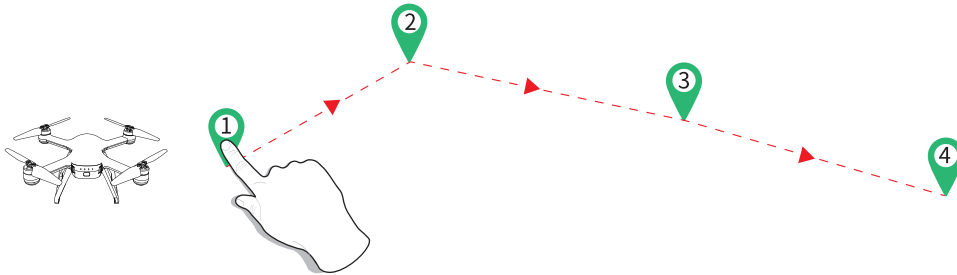

11.5 TapFly

It is recommended to enlarge the map if you want to use TapFly.



1. Please click on the Map first, then click the “” icon, and follow the prompt box to enter the TapFly function.

MODE 1: Click the “” icon on the app interface, draw a line on the screen to create a path, click “” icon to submit the route, and the drone will fly along the path.

MODE 2: Click the “” icon on the app interface, set any point on the screen, click “” icon to submit the route. The drone will now fly along the path according to the points connected on the map.

2. Exit the TapFly mode by clicking the “” icon again.



3. If the flight path submission fails, you can choose to re-submit or exit again.











- DO NOT fly the drone towards people, animals, or small/ fine objects (e.g. tree branches and power lines) or transparent objects (e.g. glass or water).

- There may be some deviation between the expected and actual flight path.

11.6 Take Photo/ Video

- ① Click the “” icon to take photo, click once to take a photo.
- ② Click the “” icon to record video, click once to start recording, and click again to stop recording.
- ③ Click the “” icon to enter the gallery for viewing.
- ④ Without the TF card installed, the photos and videos will be saved in both app albums and smartphone albums.
- ⑤ After installing the TF card, the photos and videos will be saved in both the app album and the TF card.
- ⑥ If you want to view the photos and videos stored in the TF card in the application, please make sure that the phone is connected to the Wi-Fi of the drone.

12.0 DRONE STATUS INDICATOR

Indicator Status	Meanings
 <p>Front and rear lights alternate flashing yellow.</p>	<p>The drone is not connected to the transmitter.</p>
 <p>Red, green and yellow lights flashing and alternate.</p>	<p>Drone is currently in Initialization Detection status.</p>
 <p>Front light turns solid red, rear light turns solid yellow.</p>	<p>No GPS signal or weak GPS signal.</p>
 <p>Front light turns solid red, rear light turns solid green.</p>	<p>Good GPS signal.</p>
 <p>Front and rear lights alternate flashing green.</p>	<p>Compass Horizontal Calibration has completed.</p>
 <p>Front and rear lights alternate flashing yellow.</p>	<p>Initialization Detection has completed.</p>
 <p>Front light turns solid red, rear light flashes red slowly.</p>	<p>Entering the First Low Voltage RTH.</p>
 <p>Front light turns solid red, rear light flashes red rapidly.</p>	<p>Entering the Second Low Voltage RTH.</p>

13.0 SPECIFICATIONS

DRONE

Model: HS700E

Weight: 525g / 18.51oz

Max Flight Time: 23 minutes (per battery)

Operating Temperature Range: 32° to 104°F

Size: 384 x 229 x 118 mm

DRONE BATTERY

Capacity: 2800 mAh

Voltage: 7.4 V

Battery Type: Li-Po

Energy: 20.72 Wh

Charging Temperature Range: 41° to 104°F (5° to 40°C)

Charging Time: about 5 hours

TRANSMITTER

Operating Frequency: 2.400-2.4835 GHz

Max Transmission Distance: 3277 feet / 999m (outdoor and
unobstructed)

Battery Type: 2×1.5V AA batteries (Not included)

Operating Temperature Range: 32° to 104°F

CAMERA

Operating Frequency: 5.725-5.850 GHz

Photo Resolution: 3840×2160P (stored in TF card)

1920×1080P (stored on mobile phone)

Video Resolution: 3840×2160P (stored in TF card)

1280×720P (stored on mobile phone)

Lens: FOV 130°

Max Transmission Distance: 1640 feet/500m (outdoor and unobstructed)

Live View Quality: 4K@30fps/1080P@60fps

Photo Formats: JPEG

Video Formats: AVI / MP4

Supported TF Cards: Supports a TF Card with capacity of up to

128 GB (Not included)

Controllable Range: Pitch: -90° to 0°

Operating Temperature Range: 32° to 104°F

USB CHARGING CABLE

Voltage: 5 V

Rated Power: ≤10 W

14.0 TROUBLE SHOOTING

No.	Problem	Solution
1	When the drone is powered on, the indicator light keeps flashing rapidly.	The drone is in the gyroscope calibration state. Please place the drone on an flat and level surface.
2	The drone cannot hover after takeoff and tilts to one side.	Place the drone on a flat, level surface and repeat the gyro calibration.
3	The drone vibrated in flight.	The propeller are damaged. Please replace the new propeller.
4	The drone could not be unlocked and the rear light flashed.	The drone battery voltage is too low. Please fully charge the battery.

15.0 CONTACT US

Please do not hesitate to contact us if you need further support.

✉ usa@holystone.com (America)
ca@holystone.com (Canada)
eu@holystone.com (Europe)
es@holystone.com (España)

☎ +1(855) 888-6699

16.0 GENERAL INFORMATION

FCC Statement:

Any Changes or modifications not expressly approved by the party responsible for compliance could void the user's authority to operate the equipment.

This device complies with part 15 of the FCC Rules. Operation is subject to the following two conditions:

- (1) This device may not cause harmful interference, and
- (2) This device must accept any interference received, including interference that may cause undesired operation.

NOTE: This equipment has been tested and found to comply with the limits for a Class B digital device, pursuant to Part 15 of the FCC Rules. These limits are designed to provide reasonable protection against harmful interference in a residential installation. This equipment generates uses and can radiate radio frequency energy and, if not installed and used in accordance with the instructions, may cause harmful interference to radio communications. However, there is no guarantee that interference will not occur in a particular installation. If this equipment does cause harmful interference to radio or television reception, which can be determined by turning the equipment off and on, the user is encouraged to try to correct the interference by one or more of the following measures:

- Reorient or relocate the receiving antenna.
- Increase the separation between the equipment and receiver.
- Connect the equipment into an outlet on a circuit different from that to which the receiver is connected.
- Consult the dealer or an experienced radio/TV technician for help.

WARNING: Changes or modifications not expressly approved by the party responsible for compliance could void the user's authority to operate the equipment.

RF Exposure

The equipment complies with FCC radiation exposure limits set forth for an uncontrolled environment. This device should be installed and operated with minimum distance 20cm between the radiator & your body. This part belongs to the drone.

RF warning for Portable device: The device has been evaluated to meet general RF exposure requirement. The device can be used in portable exposure condition without restriction. This part belongs to the transmitter.

IC Notice:

This device complies with Canada Industry licence-exempt RSS standard(s).

Operation is subject to the following two conditions:

- (1) this device may not cause interference; and
- (2) this device must accept any interference. Including interference that may cause undesired operation of the device.

CAN ICES-3 (B)

Avis d'Industrie Canada

Le présent appareil est conforme aux CNR d'industrie Canada applicables aux appareils radio exempts de licence L'exploitation est autorisée aux deux conditions suivantes:

- 1) l'appareil ne doit pas produire de brouillage; et

2) l'utilisateur de l'appareil doit accepter brouillage radioélectrique subi même si le brouillage est susceptible d'en compromettre le fonctionnement. mauvais fonctionnement de l'appareil. Cet appareil numérique de la classe B est conforme à la norme NMB-003 du Canada.

CAN NMB-3 (B)

RF Exposure

Radiation Exposure Statement:

This equipment complies with IC radiation exposure limits set forth for an uncontrolled environment. This equipment should be installed and operated with minimum distance 20cm between the radiator & your body.

Déclaration d'exposition aux radiations:

Cet équipement est conforme aux limites d'exposition aux rayonnements IC établies pour un environnement non contrôlé. Cet équipement doit être installé et utilisé avec un minimum de 20 cm de distance entre la source de rayonnement et votre corps.

HOW TO RECYCLE THIS PRODUCT

This symbol on the product or its documentation indicates that it must not be disposed of with household waste.

Uncontrolled waste disposal may harm the environment or human health. Please separate your device from other types of waste to recycle it responsibly.

This will help to foster the sustainable re-use of material resources.

We invite you to contact your retailer or inquire at your local town hall to find out where and how the drone can be recycled.

BATTERY WARNING:

1. Failure to follow all the instructions may result in serious injury, irreparable damage to the battery and may cause a fire, smoke or explosion.
2. Always check the battery's condition before charging or using it.
3. Replace the battery if it has been dropped, or in case of odor, overheating, discolouration, deformation or leakage.
4. Never use anything other than the approval LiPo charger the battery. Always use a balancing charger for LiPo cells or a LiPo cell balancer. It is recommended that you do not to use any other charger than the one provided with the product.
5. The battery temperature must never exceed 60°C (140°F) otherwise the battery could be damaged or ignite.
6. Never charge battery on a flammable surface, near flammable products or inside a vehicle (preferably place the battery in a non-flammable and nonconductive container).
7. Never leave the battery unattended during the charging process. Never disassemble or modify the housing's wiring, or puncture the cells. Always ensure that the charger output voltage corresponds to the voltage of the battery. Do not short circuit the batteries.
8. Never expose the LiPo battery to moisture or direct sunlight, or store it in a place where temperatures could exceed 60°C (car in the sun, for example).
9. Always keep it out of reach of children.
10. Improper battery use may result in a fire, explosion or other hazard.



11. Non-rechargeable batteries are not to be recharged. Rechargeable batteries are only to be charged under adult supervision.
12. Different types of batteries or new and used batteries are not to be mixed.
13. Batteries are to be inserted with the correct polarity.
14. The supply terminals are not to be short-circuited. Regular examination of transformer or battery charger for any damage to their cord, plug, enclosure and other parts and they must not be used until the damage has been repaired.
15. The packaging has to be kept since it contains important information.
16. The toy is only to be connected to Class II equipment bearing the symbol. 

Caution

1. The max operating of the EUT is 45°C. and shouldn't be lower than -10°C.
2. The device complies with RF specifications when the device used at 0mm from your body.
3. Declaration of Conformity.

We, Xiamen Huoshiquan Import & Export CO., LTD hereby, declare that the essential requirements compliance with the Directive 2014/53/EU, the RoHS Directive 2011/65/EU and Safety Directive 2009/48/EC have been fully fulfilled on our product with indication below:

Product Name: REMOTE CONTROL MODEL/RADIO CONTROLLED
Model/Mark : HS700E/HOLYSTONE

The Statement of compliance is available at the following address:
http://www.holystone.com/Download/CE/HS700E_EU_DOC.pdf
This product can be used across EU member states.

MANUFACTURER INFORMATION

Manufactured by
Xiamen Huoshiquan Import & Export CO.,LTD
Room 703, No. 813-2 Xiahe Road, Siming District, XIAMEN, China
+1(855) 888-6699



FAA REGISTRATION: PLEASE FOLLOW ALL FEDERAL, STATE AND LOCAL FAA LAWS. YOU MAY BE REQUIRED TO REGISTER YOURSELF AND YOUR DRONE WITH THE FAA MORE INFO CAN BE FOUND AT: [HTTPS://WWW.FAA.GOV/UAS/GETTING STARTED/](https://www.faa.gov/uas/getting-started/)

After receiving the certificate of registration, you must mark your **unique FAA registration number** on the Drone by any means, such as permanent marker, lable, engraving. This number must be readily accessible and maintained in a condition that is readable and legible upon close visual inspection

WARNING: Do **NOT** fly drone near airports or any other un-authorized areas. Follow all rules for Federal Aviation Administration (FAA) regulation summary for Small Unmanned Aircraft Systems (sUAS).

Read: Academy of Model Aeronautics (AMA) Know Before You Fly important information brochure.



Made in China

