



16+
age

Instructions For Use

Gebrauchsanweisung

V1.0

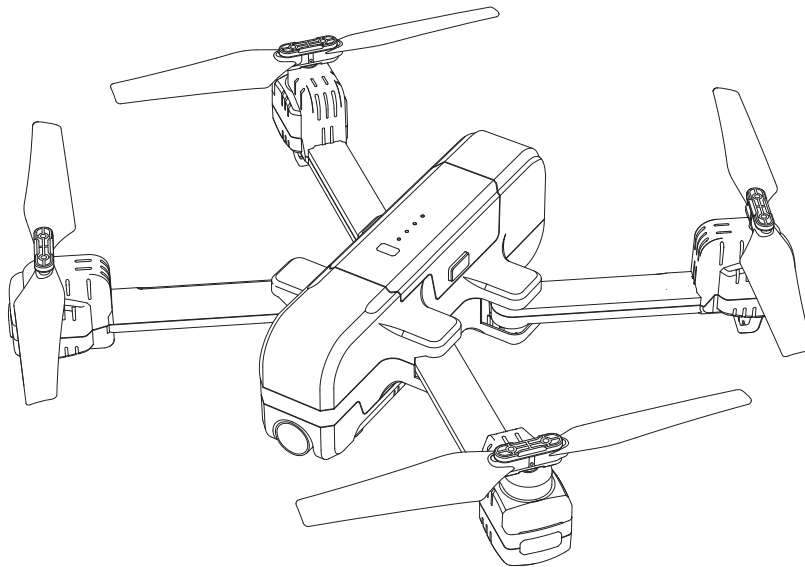

HS270



usa@holystone.com (USA)
ca@holystone.com (CA)

eu@holystone.com (EU)
jp@holystone.com (JP)

 +1(855) 888-6699

www.holystone.com

Contents

1.0 Disclaimer&Warning	01
2.0 Safety Guidelines	01
3.0 Maintenance	05
4.0 Package Contents	06
5.0 Drone's Details	07
6.0 Battery of Drone	07
7.0 Transmitter Details	08
8.0 Joystick Mode	09
9.0 Installation	
9.1 Propellers	10
9.2 Unfold the Drone	10
10.0 Charging	11
11.0 Operation Guide	
11.1 Download APP	12
11.2 Connect to WiFi	12
11.3 Paring	13
11.4 Calibrating the Compass	14
11.5 Calibrating the Gyro	15
11.6 GPS Searching	16
11.7 Unlock the Motor	17
11.8 One Key Takeoff / Landing	17
12.0 Functions Details	
12.1 Speed Switch	18
12.2 Emergency Stop	18
12.3 Trimmer Function	19
12.4 Headless Mode	20
12.5 Return to Home	21
13.0 APP Operation Instruction	
13.1 Operation Interface	22
13.2 Beginner's Mode	24
13.3 Way Point Flight	24
13.4 Follow Me	25
14.0 Specifications	26
15.0 Trouble Shooting	28
16.0 Contact Us	29
17.0 General Information	30

1.0 DISCLAIMER & WARNING

1. Please read this Disclaimer & Warning and Safety Guidelines carefully before using our product. This product is not recommended for people under the age of 16. By using this product, you hereby agree to this disclaimer and signify that you have read it fully. You agree that you are responsible for your own conduct and any damaged caused while using this product, and its consequences . You agree to use this product only for purposes that are proper and in accordance with local regulations, terms and all applicable polices and guidelines Holy Stone may make available.

2. When using this product, please be sure to strictly abide by the specification requirements and safety guidelines stated in this document. Any personal injury property damage, legal disputes and all other adverse events caused by the violation of the safety instructions or due to any other factor, WILL NOT be Holy Stone's responsibility.

2.0 SAFETY GUIDELINES

2.1 Check Before Use:

- ① This product is a high precision drone that integrates various electronic stability and control mechanisms. Please be sure to setup this drone carefully and correctly to ensure safe, accident-free operation.
- ② Please be sure that the batteries of the drone and transmitter are clean, undamaged and, fully charged.
- ③ Please be sure that all the propellers are undamaged and are installed in the correct orientation.

④ Please do a thorough check of the product before each use. Inspect the integrity of the parts, any signs of cracks and wear of the propeller, battery power and effectiveness of the indicator, etc. If after doing a complete check any issues are found, please refrain from using the product until the issue has been resolved.

2.2 Flight Environment:

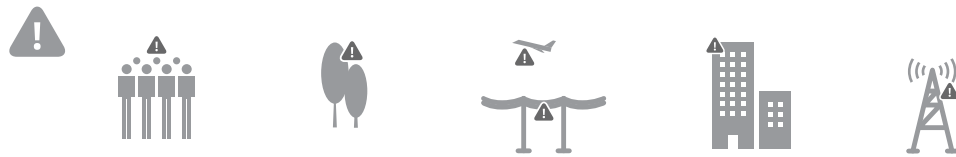
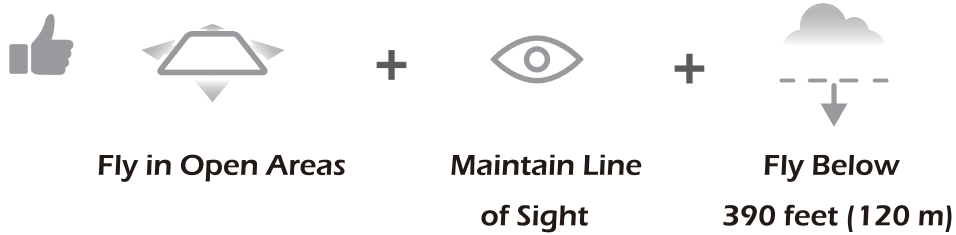

Avoid flying over or near obstacles, crowds, high voltage power lines, trees, airport or bodies of water.

DO NOT fly near strong electromagnetic sources such as power lines and base stations as it may affect the onboard compass.



Don't use this drone in adverse weather conditions such as rain, snow, fog, and wind.

2.3 Operation Requirements :

- ① Please don't use this product to follow any moving vehicles .
- ② During the flight, only turn off the motor in case of an emergency.
- ③ Please flight the drone back to you as soon as possible when the battery is running low.
- ④ This product should not be used while drinking alcohol, if you are feeling fatigued, taking medicine, or feeling any physical discomfort.
- ⑤ Beware of the noise volume the drone produces. Keep your distance to avoid ear damage.

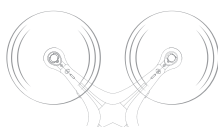



- ⑥ **Stay away from the rotating propellers and motors.**
- ⑦ **Don't fly in the No-Fly Zone.**

2.4 Use of Battery:

- ① Please ensure batteries are fitted in the correct orientation as shown in the instruction manual.
- ② Avoid short circuits by fitting the batteries incorrectly, and do not crush or squeeze the batteries as this could carry the risk of an explosion.
- ③ Do not mix new and old batteries as this can lead to a poor performance of the product.
- ④ Dispose used batteries carefully, do not litter.
- ⑤ Please keep dead batteries away from heat and fire.
- ⑥ If the device is not going to be used for an extended period of time, remove batteries to prevent potential damage from battery leakage.





- ⑦ It is recommended to only use the USB charging cable that comes with the drone to charge the battery.
- ⑧ Don't connect the battery directly to wall outlets or car cigarette-lighter sockets.
- ⑨ Don't attempt to disassemble or modify the battery in any way.
- ⑩ Don't use the battery if it gives off an odor, generates heat, becomes discolored or deformed, or appears abnormal in any way. If the battery is in use or being charged, remove it from the device or charger immediately and discontinue use.
- ⑪ Don't pierce the battery casing with a nail or other sharp object, break it open with a hammer, or step on it!
- ⑫ Always charge the batteries in a fireproof container and away from combustible materials. Don't charge on surfaces that can catch fire. This includes: wood, cloth, carpet, or in the application's device.
- ⑬ Don't immerse the battery in water or allow it to get wet.
- ⑭ Don't solder battery terminal directly.
- ⑮ Keep battery out of reach of children or pets.
- ⑯ Don't short-circuit the battery by connecting wires or other metal object to the positive(+) and negative(-) terminals.

	<p>Li-Po Battery Disposal & Recycling</p> <p>Waste Lithium-polymer batteries must not be placed with household trash. Please contact local environmental or waste agency or the waste agency or the supplier of your model or your nearest Li-Po battery recycling center.</p>	
---	---	---

3.0 MAINTENANCE

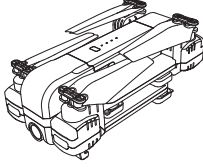
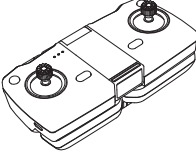
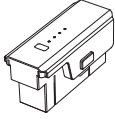
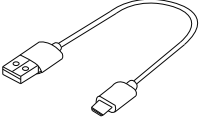
- ① Clean the product after each use with a clean, soft cloth.
- ② Avoid prolonged exposure to direct sunlight and avoid buildup of heat on the drone.
- ③ This device is not waterproof and must not be submerged in water under any circumstance. Failure to maintain the device completely dry will result in the failure of the unit.
- ④ Check the charging plug and other accessories for signs of damage frequently. If any part of the device is damaged, refrain from flying until maintenance can be carried out.

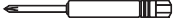
4.0 PACKAGE CONTENTS

 <p style="text-align: right;">× 1</p>	 <p style="text-align: right;">× 1</p>	 <p style="text-align: right;">× 1</p>
<p style="text-align: center;">Drone</p>	<p style="text-align: center;">Transmitter</p>	<p style="text-align: center;">Drone Battery</p>
 <p style="text-align: right;">× 1</p>	 <p style="text-align: right;">× 4</p>	 <p style="text-align: right;">× 4</p>
<p style="text-align: center;">USB Charging Cable</p>	<p style="text-align: center;">Propeller</p>	<p style="text-align: center;">Screws</p>
 <p style="text-align: right;">× 1</p>	 <p style="text-align: right;">× 1</p>	
<p style="text-align: center;">Screwdriver</p>	<p style="text-align: center;">Instructions For Use</p>	

5.0 DRONE'S DETAILS

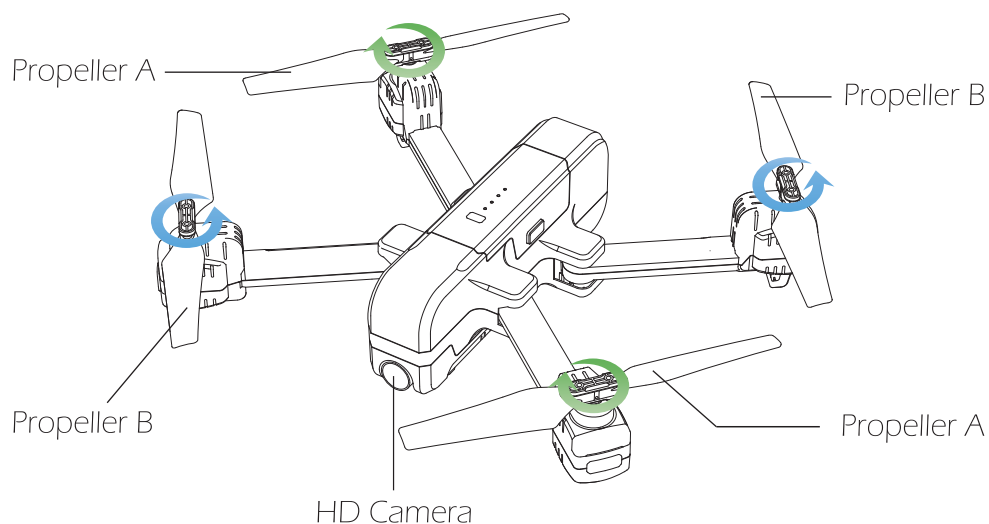

6.0 BATTERY OF DRONE

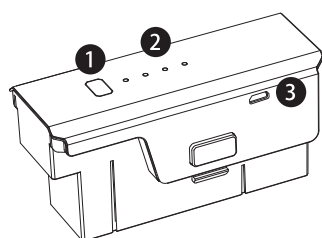

- ① Power Switch
- ② Battery Power Indicators
- ③ Micro USB Charging Port

Low Electricity High



Press and hold the Power Switch for 3 seconds to turn on, and hold the Power Switch for 3 seconds again to turn off.

Tips:

Once the battery is low, please fly the drone back as soon as possible. Otherwise, it may cause the drone loss.

7.0 TRANSMITTER DETAILS

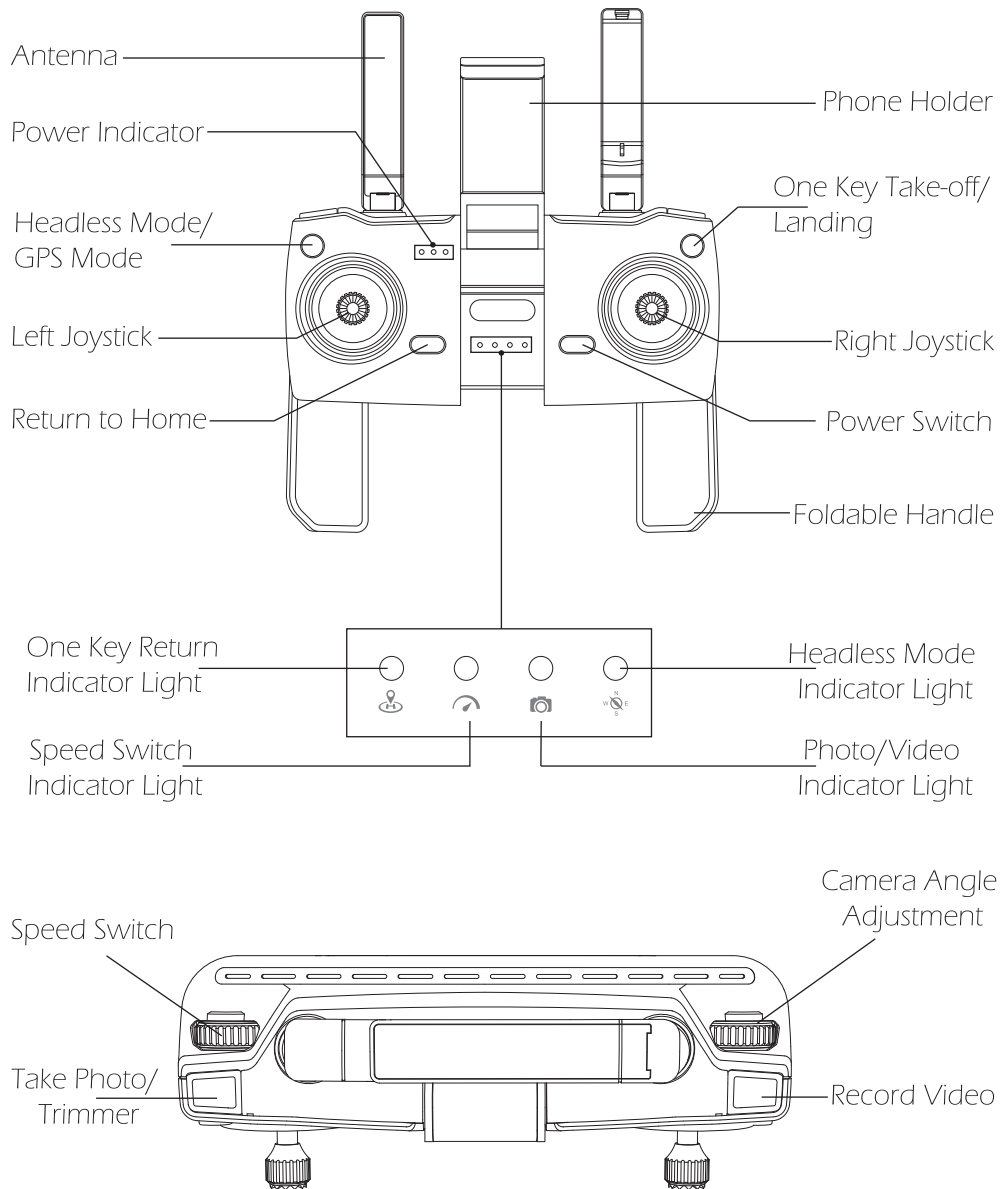

ATTENTION:

Press "  " shortly, then quickly press and hold "  " for about 2 seconds to turn off the transmitter.

8.0 JOYSTICK MODE

► 8.1 MODE 2 (Left hand throttle MODE 2 will be default setting.)

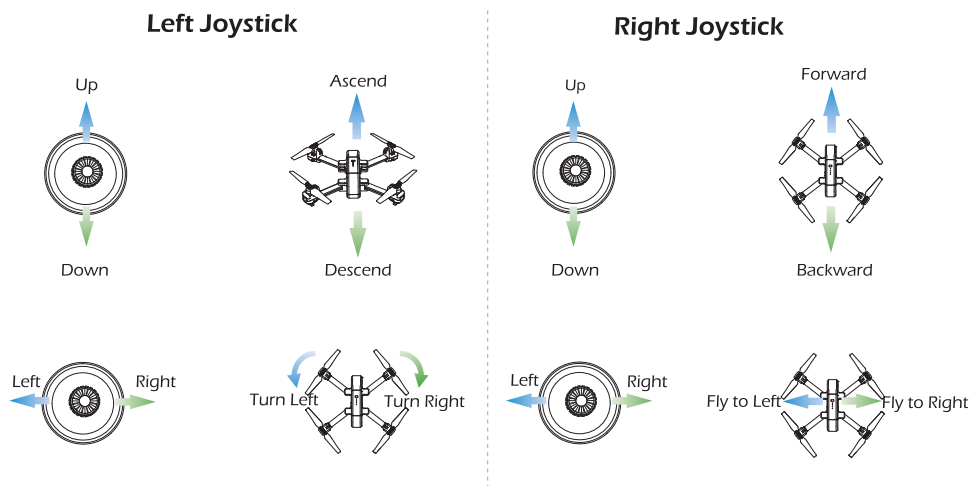

► 8.2 MODE 1

To enter MODE 1, turn on the transmitter while holding the “Take Photo/Trimmer” button. (Please do not release the “Take Photo/Trimmer” button until the transmitter is powered on.)

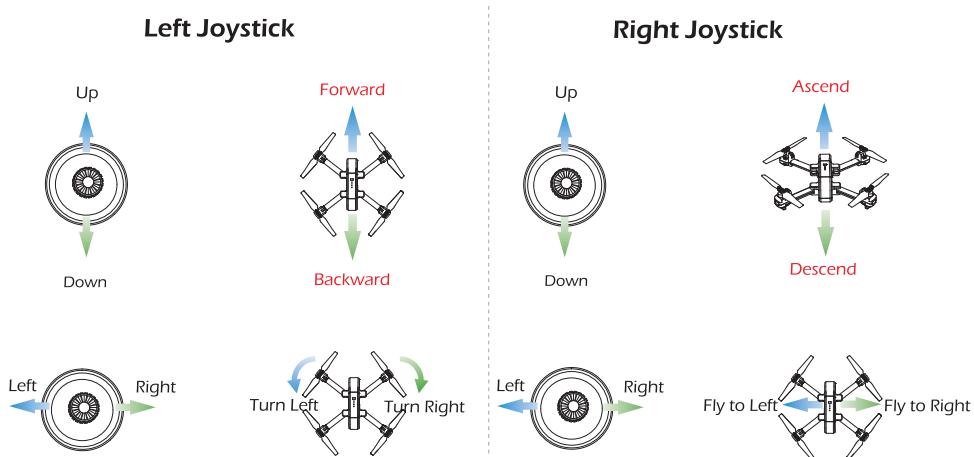

9.0 INSTALLATION

► 9.1 Propeller

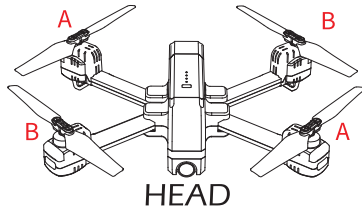

Pic 1

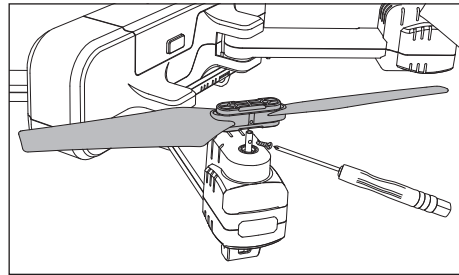

Pic 2

- ① Install the propeller on the motor shaft according to the “A/ B” corresponding position. (Pic1)
- ② Use a screwdriver to twist and tighten the screws by pressing the clockwise direction. (Pic2)

► 9.2 Unfold the Drone

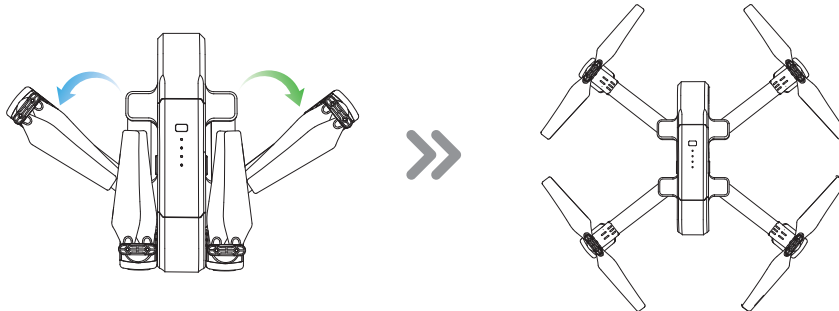

Follow the steps as below to unfold the drone.

Step 1: Unfold the rear arms.

Step2: Repeat again to unfold front arms.

10.0 CHARGING

► 10.1 Drone Battery

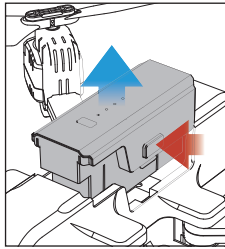

Pull out the battery from the drone.

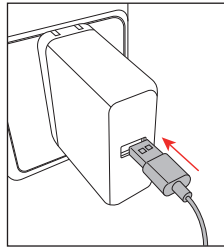

Phone adapter:
5V \equiv 1A/ 2A
(Not included)

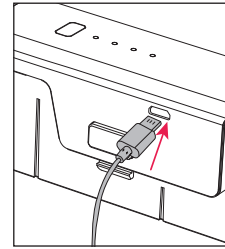

Charging time: 6h
(Depending on charging power)

Connect the battery to the USB charging cable after the battery is removed, and then connect the USB charging cable to a computer or a USB adapter.

► 10.2 Transmitter Battery

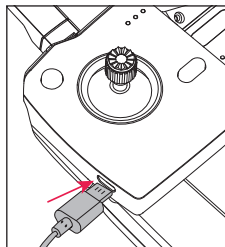

Charging time of the transmitter: about 1h

(Charging) (Fully Charged)

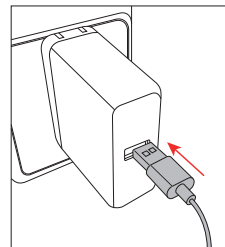

Phone adapter:
5V \equiv 1A/ 2A
(Not included)

Connect the USB charging cable with the transmitter, then, connect the USB charging cable to a computer or a USB adapter.



When the transmitter is in low power, the Power Indicator on the transmitter will blink constantly.

Before charging, please check the contents of the "Use of Battery" section of the "Safety Guidelines" carefully!

11.0 OPERATION GUIDE

► 11.1 Download APP



iOS



Android APP on Google play

Scan the QR code, connect to the App Store™ or Google™ Play and download the “HS GPS V1” application for free.

► 11.2 Connect to Wi-Fi

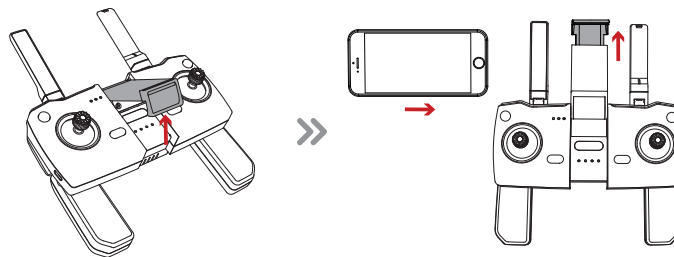

- ① As shown above, pull up the phone holder and lock the phone.
 - ② Connect your smart phone to the Wi-Fi network created by the Drone. Check the drone's status in the **HS GPS V1** App.
 - ③ Your smartphone will launch a search of the available Wi-Fi networks:
 - ④ Select the Wi-Fi network: **HolyStoneFPV_*******.
 - ⑤ Wait for several seconds until your smartphone connects to the Wi-Fi network of the drone. **This connection is generally represented by the Wi-Fi logo appearing on your smartphone's screen.**
 - ⑥ Enter the **HS GPS V1** application.
- > The connection between your smartphone and the Drone will be established automatically.

All of the following operations on this manual is under MODE 2.

► 11.3 Pairing

① Long press the Power Switch to turn on the drone.

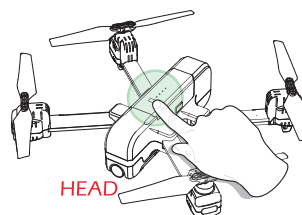

② Place the drone on a flat and level surface with the head forward and the tail towards the pilot.

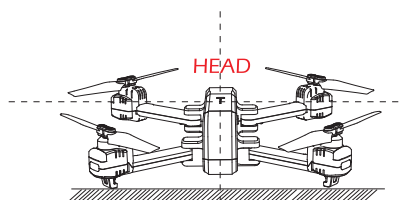

③ Press the  button to turn on the transmitter.

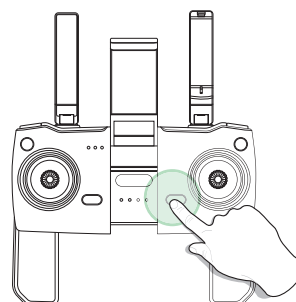

④ Push the left joystick up then down to pair the drone with the transmitter. The indicator lights on the drone will flash White in front and Blue in rear if the drone is paired successfully.

(When it is interfered, the indicator lights will flash Pink in front and Purple in rear.)

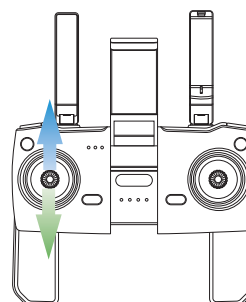

► 11.4 Calibrating the Compass

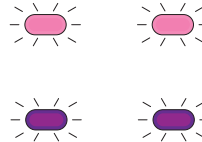
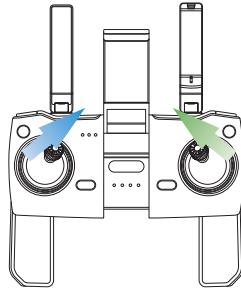

Step 1:

Simultaneously push the left stick to top right corner and the right stick to the top left corner. The front Pink lights and the rear Purple light will turn to flash quickly.

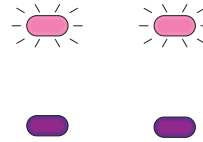
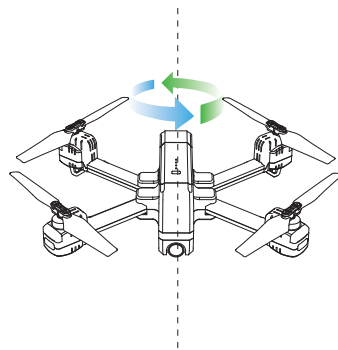

Step 2:

Hold the drone horizontally and rotate it until the rear lights turn solid Purple.

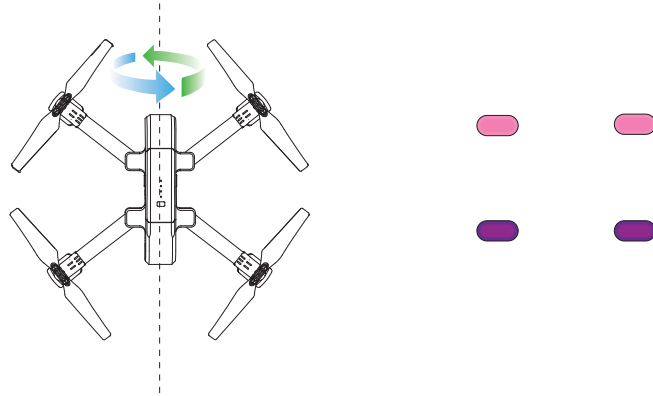

Step 3:

Hold the drone vertically and rotate it until the front Pink lights turn solid.

► 11.5 Calibrating the Gyro

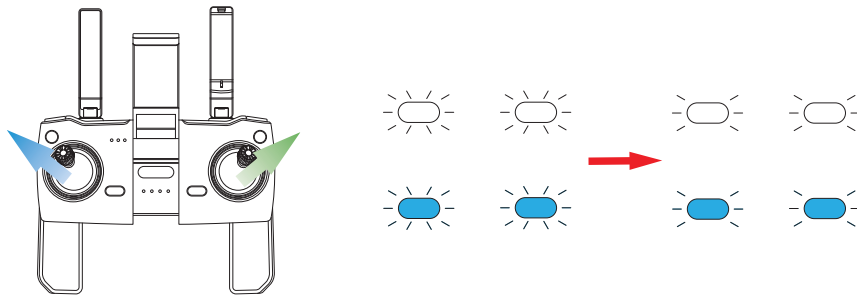

Simultaneously push the left stick to top left corner and the right stick to the top right corner. When the drone's front White indicator light and rear Blue indicator light change from quick flash to slow flash, and the camera turns once, the gyroscope calibration is completed.

Tips: To ensure a stable flight, we suggest that the pilot calibrates the gyro every time after pairing and a crash.

► 11.6 GPS Searching (**DO NOT use GPS Mode indoors**)

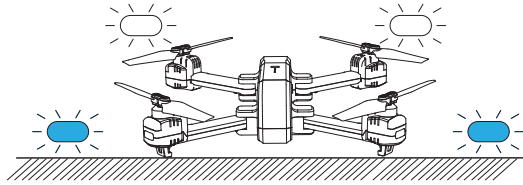

— Place the drone on a flat and dry surface where is unobstructed and lit area.

— The front White indicator light and the rear Blue indicator will flash quickly. This means the drone is searching the GPS Signal.

This process will take about one minute.

When four lights turn solid, GPS Mode is Ready (Only when the drone is connected to GPS successfully can it take off).

— Blue (rear) and White (front) lights are all solid (no blinking).

ATTENTION:

① If the LED Flight Indicators keep blinking quickly, it indicates drone is searching for GPS signals.

② If the drone keep blinking quickly after a few minutes, it indicates that the process has FAILED. Please take the drone to another place, and repeat all the Compass Calibration operations until the process is successful.

③ When flying indoors, please hold  button for 3 seconds to exit GPS Mode, and the LED lights will blink slowly. You can fly this drone when you complete the Compass Calibration operations if you exit GPS Mode.

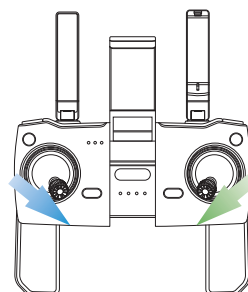

► 11.7 Unlock the Motor

Simultaneously push the left stick to lower right corner and the right stick to the lower left corner. The propellers rotate, indicating the drone is unlocked.

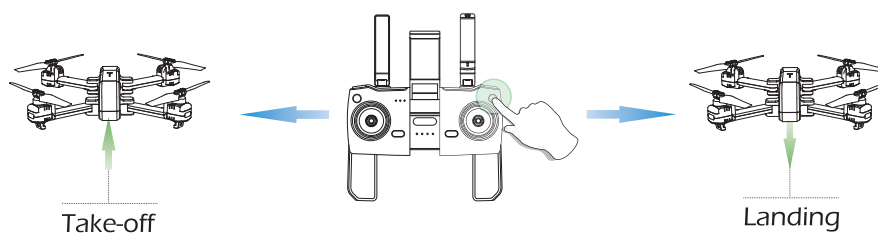

► 11.8 One Key Takeoff/ Landing



- ① Press the One Key Takeoff button (), the drone will automatically takeoff and hover at about 5 feet altitude.
- ② When the drone is flying, press the One Key Landing button (), the drone will automatically land on the ground.

12.0 FUNCTIONS DETAILS

► 12.1 Speed Switch

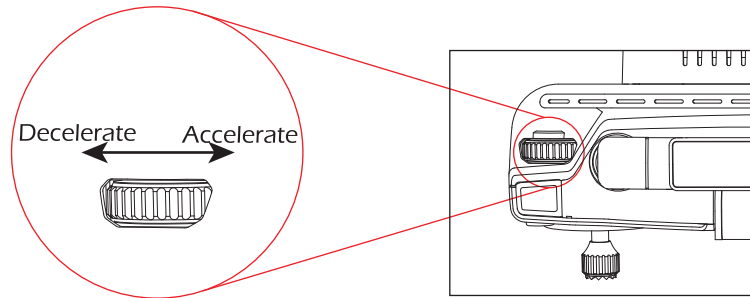

This drone comes with 3 speed modes (Low/ Medium/ High). Dial the wheel (⊖^{SPEED}⊕) to the right to accelerate. Dial to the left to decelerate.

If the Speed Indicator Light on the transmitter is turned off, it means the drone is in low speed. If the light is turned on, it means the drone is in medium speed. If the light is blinking, it means the drone is set to high speed.

(Medium Speed is default setting!)

► 12.2 Emergency Stop

 The Emergency Stop function should only be used in case of the emergency during the flight to avoid any damage or injury.

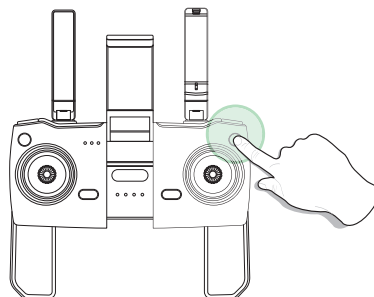

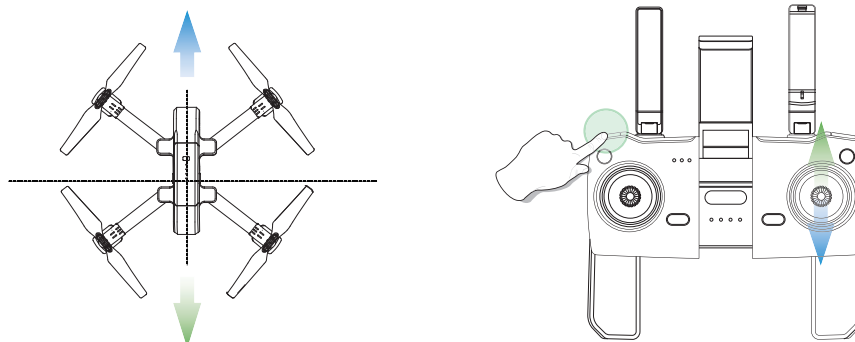

Long press One Key Takeoff / Landing button () for 2 seconds, the motors will stop immediately and the drone will fall directly.

► **12.3 Trimmer Function (Trim under NO GPS Mode)**

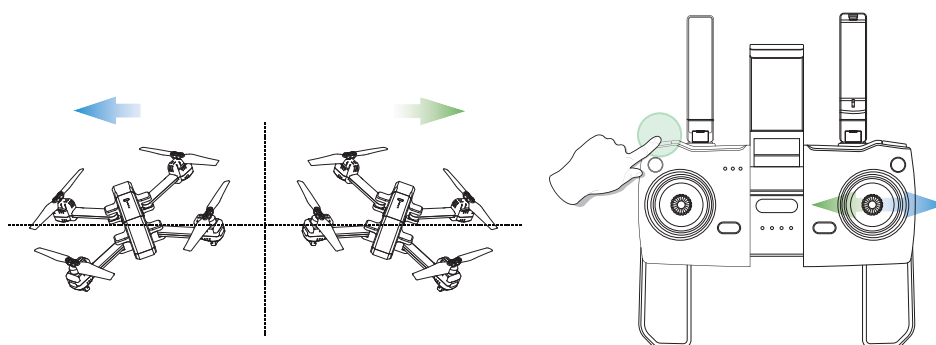

F/B Sideways Drift Trim : If the drone drifts forward, hold down the Trimmer button () and do not release it while pushing the direction joystick down to balance the drone. If the drone drifts backwards, hold down the Trimmer button and do not release it while pushing the direction joystick up to balance the drone.



L/R Sideways Dip Trim: If the drone drifts left, hold down the Trimmer button () and do not release it while pushing the direction joystick right to balance the drone. If the drone drifts right, hold down the Trimmer button and do not release it while pushing the direction joystick left to balance the drone.