

Bluetooth Headset



User Manual

User Manual

1. Welcome	3
2. Product Overview	4
2.1 Package Contents	4
2.2 Headset Overview	5
2.3 Base Overview	6
3. Use Instructions	7
3.1 9702/9712 BT Pairing with Bluetooth Device	7
3.2 9702/9712 BT Usage	8
3.3 9702/9712 BT Charging	8
4. Features	9
4.1 Headset multi-function button	9
4.2 Headset Speaker Volume Button	10
4.3 Headphone Mute Button	10
4.4 Headset LED Indicators	11
5. Technical Specifications	12
5.1 9702/9712 Bluetooth Headset	12
5.2 Headset battery	12
5.3 Charging Base	13
5.4 Product Disposal Treatment and FCC statement	13

1. Welcome

Congratulations on purchasing your new VT9712 BT Duo. We are sure you will enjoy its wide range of features, and find the headset comfortable to wear and easy to use.

9702/9712 BT headset features

- Wideband audio for exceptional sound quality.
- Volume and mute controls.
- Intuitive headset multi-function button for easy call handling.
- Busylight on headband and audio indicators.
- Advanced hearing protection with safetone™.
- Noise-cancelling microphone.

9702/9712 BT base features

- Headset recharge docking cradle.
- Connect to PC for soft Phone(Skype for Business).
- Battery charging indicators.
- Pairing indicators.

2. Product Overview
2.1 Package Contents



Headset

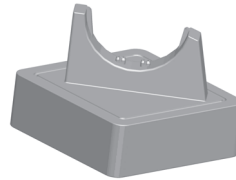

Charging base

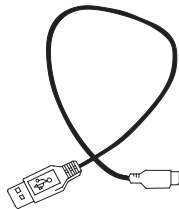

USB Cable



User Manual

2.2 Headset Overview

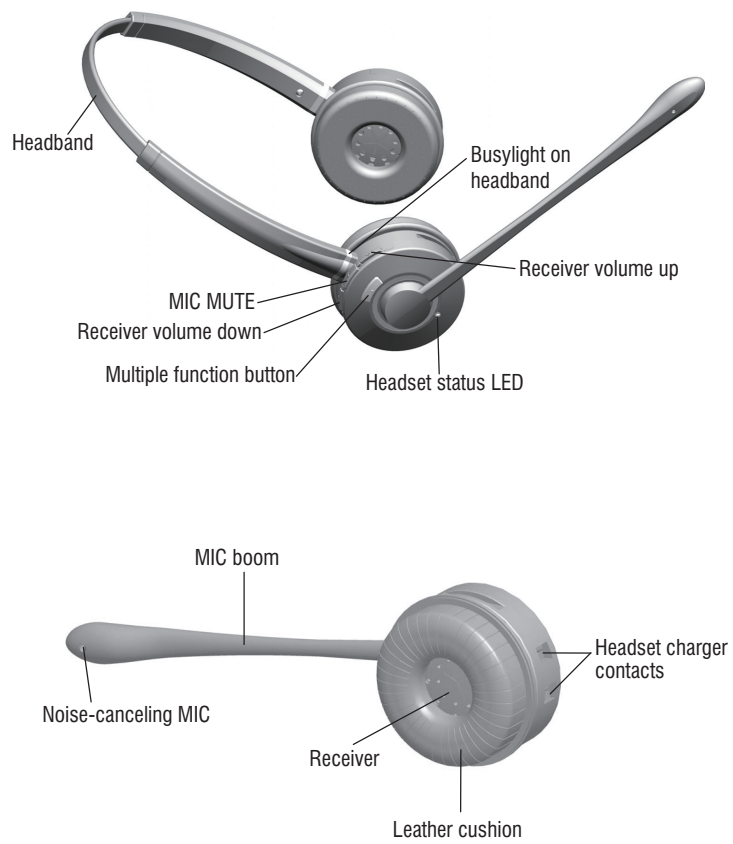

2.3 Base Overview

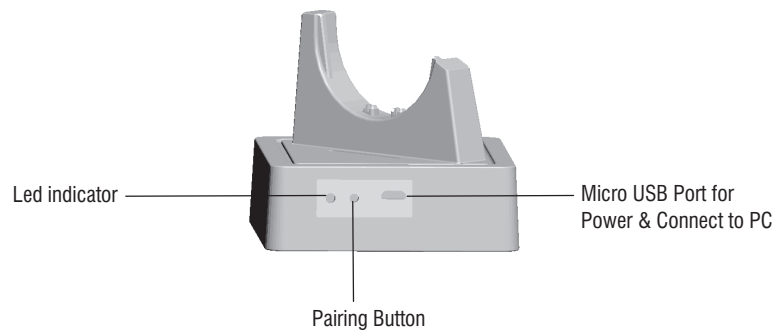
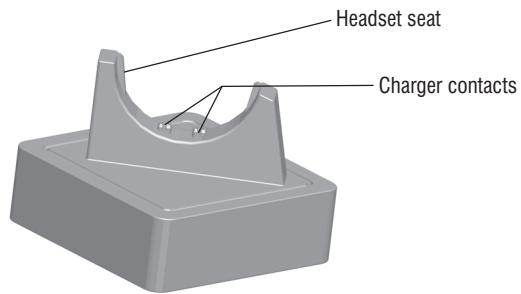

3. Use Instructions

3.1 9702/9712 BT Pairing with Bluetooth Device

1. Be sure that your smart phone/ laptop with Bluetooth function.
2. Active the Bluetooth function on your smart phone/ laptop.
3. Turn on your headset.
4. Pairing headset with your smart phone/ laptop.
 - 1) Press the multi-function button for more than 6s, the LED will flash red and blue alternately which indicates the headset is in pairing mode.
 - 2) Search Bluetooth device on your smart phone/laptops.Open "Bluetooth" menu and press "discover" or "add" to search 9702/9712 BT on your smart phone/ laptop.
 - 3) When "9702/9712 BT" showing on your Bluetooth devices list, please click it to begin the pairing. Sometimes, the PIN code "0000" is required.
 - 4) If pairing is successful, the LED will turn on blue and 9702/9712 BT icon will show on your smart phone/laptop. You can make calls or listen to music now. Next time, you don't need to do pairing again, just click 9702/9712 BT icon to make connection.
 5. If pairing fails, please turn off the headset, and repeat step 4.
 6. 9702/9712 BT can pair with two devices simultaneously. If you want to pair 9702/9712 BT with another device simultaneously, please turn off Bluetooth function on the first smart phone/laptop and power off the headset. Then repeat step2,step3,step4 with the second smart phone/laptop. After pairing successfully, reactive the Bluetooth function on the first smart phone/laptop. You will find 9702/9712 BT is pairing with two devices now.
 7. If no smart phone/laptop is paired with the 9702/9712 BT within 120S in pairing mode, the 9702/9712 BT will shut down to save power consumption automatically
 8. After getting paired with 9702/9712 BT, you can rename it on your smart phone/laptop.
Tips: Headset is using a procedure called "pairing" to connect to a Bluetooth device.

3.2 9702/9712 BT Usage

1. Answer a Call:

After smart phone/laptop successfully pairing with 9702/9712 BT, the headset will ring when a call coming, please press the multifunction key to answer it.

2. Hang up a Call:

Please short press the multifunction key to hang up a call.

3. Microphone mute and on:

During a call, short press the MUTE button will make microphone on mute status. If short press the MUTE button again, the microphone will be on.

4. Volume Adjustment:

Short click volume + key to increase the volume while short click volume - key to decrease it.

5. Busylight on headband

When connect PC or Mobile Phone the Busylight is green, if call coming the Busylight is red and flash, if you answer the call, the Busylight is red and always light on until call end. When call end Busylight is green.

3.3 9702/9712 BT Base

1. Pairing

When 9702/9712 BT headset into pairing mode, push the 9702/9712 BT Base pairing button and then the blue LED flash, it means Base into the pairing mode, 9702/9712 BT headset will connect to Base in 120s. if you want pairing 9702/9712 BT Base and another Bluetooth device (mobile phone) please see the 3.1.6.

2. The Base connected to a PC using a USB cable, and PC need Skype for business, set the Skype for business audio device for 9702/9712 BT, and then can Answer/End call use the headset with Multi-button.

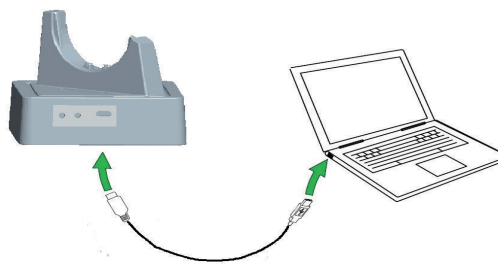

3. Charging

When 9702/9712 BT headset is charging, the red light will on. The blue light will on when it is fully charged. When take the headset off from its charger base, the headset will be in standby mode. And it is will shut down automatically to save power consumption if there is no pairing active.

4. Features

4.1 Headset multifunction button

Short or long press the Multifunctional button to answer and end a call .

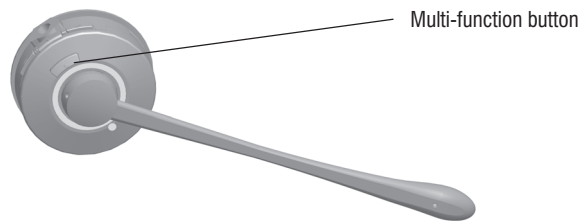

Function	Short press	Long press
Answer a call	✓	
End a call	✓	
<hr/>		
Power on		3s
Pairing		6s+
Power off		3s

4.2 Headset Speaker Volume Button

The speaker volume buttons: to adjust the headset speaker volume.

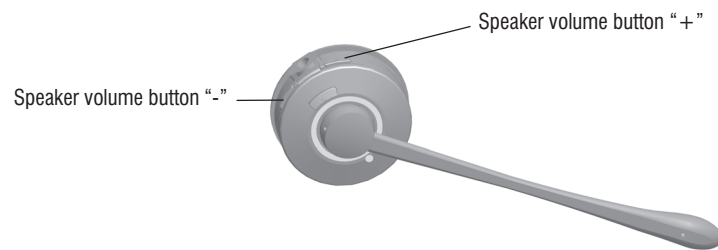

4.3 Headset Mute Button

Mute button: to make the microphone mute or on.

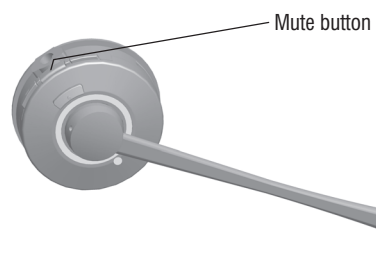

4.4 Headset LED Indicators

LED indicates call status

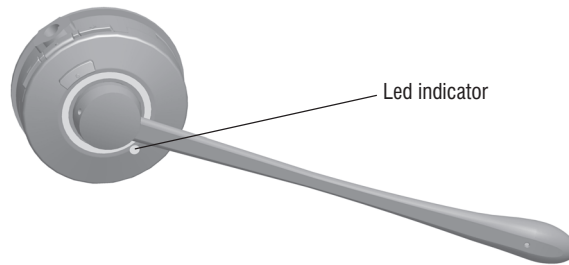

Headset status	LED status
Power on	Blue light flashes four times (300ms on, 300ms off)
Power off	Red light flashes once (2s)
Pairing mode	Blue light and red light flash alternately (red light on 750ms, blue light on 750ms)
Pairing successfully	Blue light flashes (300ms on, 8s off)
Answer a call or play music	Blue light flashes (300ms on, 8s off)
Charging	Red light on
Fully Charged	Blue light on

5. Technical Specifications

5.1 Headset

Wideband audio for exceptional sound quality.

Volume and mute controls

Advanced hearing protection with safetone™.

Bluetooth Version: V5.0 backward compatible.

Advanced Multipoints

Profile: Headset:1.2 Handsfree:1.6 A2DP

Microphone with noise cancellation

Crystal clear sound and voice(DSP)

Distance: up to 30m

Talk time:15 hours from 300mAh battery

Stand by time: 500 hours

Working environment: -10 ° C to +40 ° C; up to 95% relative humidity non-condensing.

Visual indicators: LED indicates call status, pairing status and others.

Beep: indicate volume level,microphone mute, and others.

Sound: Mic Noise canceling, the sixth generation CVC echo cancellation ,tone control.

Charging: When 9702/9712 BT docking the base.

5.2 Headset battery

Battery type: Lithium-ion polymer.

Battery capacity: 300 mA per hour standard.

Battery talking time: Up to15 hours.

Battery life: Minimum recharging 1000 times.

Battery standby time: At least 500 hours.

Operating temperature range : - 20 ° C to +60 ° C.

Battery charging time : Less than 60 minutes to charge 20%.
Less than 90 minutes to charge 50%.
Fully charged in less than 3.5 hours.

Battery storage life: Before first charging, if turn off the headset, the battery will have power for six months.

5.3 Charging Base

9702/9712 BT charging base meets the following specifications.

Port: USB port is output for charging to Bluetooth Headset.

Size : 81 mm x 81 mm x 67 mm.

Weight : 135±5g

5.4 Product Disposal Treatment and FCC statement

5.4.1 Dispose of in accordance with local regulations as headphones and recycling regulations. Never treated headset as household waste. Do not dispose of the headset in a fire, this battery may explode. If damaged, the battery may explode.

5.4.2 FCC statement:

This device complies with part 15 of the FCC Rules. Operation is subject to the following two conditions: (1) This device may not cause harmful interference, and (2) this device must accept any interference received, including interference that may cause undesired operation.

Warning: Changes or modifications not expressly approved by the party responsible for compliance could void the user's authority to operate the equipment.

Note: This equipment has been tested and found to comply with the limits for a Class B digital device, pursuant to part 15 of the FCC Rules. These limits are designed to provide reasonable protection against harmful interference in a residential installation. This equipment generates uses and can radiate radio frequency energy and, if not installed and used in accordance with the instructions, may cause harmful interference to radio communications.

However, there is no guarantee that interference will not occur in a particular installation. If this equipment does cause harmful interference to radio or television reception, which can be determined by turning the equipment off and on, the user is encouraged to try to correct the interference by one or more of the following measures:

Reorient or relocate the receiving antenna.

Increase the separation between the equipment and receiver.

Connect the equipment into an outlet on a circuit different from that to which the receiver is connected.

Consult the dealer or an experienced radio/TV technician for help.

RF Warning Statement:

This equipment complies with FCC radiation exposure limits set forth for an uncontrolled environment. this transmitter must not be co-located or operating in conjunction with any other antenna or transmitter

FC CE 