





<p align="center">IMPORTANT INFORMATION</p> <p>Safety Rules</p> <ol style="list-style-type: none"> Please follow the rules depicted in this manual closely to ensure your safety. Before using the product, we would strongly encourage you to read through this user manual. Be more wary of any edges, uneven surfaces, metal parts, accessories and its packaging so as to prevent any possible injury or damage. Keep this product out of reach of children. Take note that this product is not edible and should not be placed in your mouth. Do not modify, repair or dismantle the product. Doing so may result in electric shocks, complete breakdown of the speaker, etc. All of which, are not covered under warranty. Do not use any diluents or volatile liquid to clean the product. Keep in mind that the surface of the product should only be wiped with a clean dry cloth. Do not use this product in locations whereby there are high-temperatures or high humidity levels (For instance, bathrooms), ideally, the product should be used in a location free of dust and exposure to direct sunlight. Do not insert foreign objects, such as pins, into this product. Do not touch this product when your hands are wet as this may result in electric shocks. Turn down the volume before/while using this product as sudden loud sounds may damage it. Refrain from dropping the product as well as any collision with other objects. Do not use this product when in hazardous locations. Should any abnormal situations or problems occur while using the product, discontinue use immediately. 	<p align="center">WARRANTY AND SUPPORT</p> <p>Limited Warranty</p> <ol style="list-style-type: none"> If this product or any part thereof is proven to be defective by reason of faulty workmanship or defects in materials within 12 months of purchase, we will at our option repair or replace the product free of charge, on condition that the original invoice or sales receipt with the date of purchase, or stamp from the dealer is presented together with the defective unit. The warranty does not cover product failures which have been caused by use of accessories or other peripheral devices are not original X-mini™ branded accessories intended for use with the product. The warranty does not cover product failures caused by modifications, repairs and disassembly by any person who is not authorised by the manufacturer. Any defective unit or part shall become property of the manufacturer. The warranty does not cover any damage caused by misuse, drop, hit or neglect. <p align="center">© 2017, Xmi Pte Ltd. All rights reserved. The name "X-mini", "Capsule Speaker" and "X-mini logo" are trademarks or registered trademarks of Xmi Pte Ltd. This product is covered by patents/patents pending and are property of Xmi Pte Ltd.</p>	<p align="center">FCC STATEMENT</p> <p>X-mini™ KAI X3 Portable Speaker This device complies with Part 15 of the FCC Rules. Operation is subject to the following two conditions: (1) this device may not cause harmful interference, and (2) this device must accept any interference received, including interference that may cause undesired operation.</p> <p>Changes or modifications not expressly approved by the party responsible for compliance could void the user's authority to operate the equipment. NOTE: This equipment has been tested and found to comply with the limits for a Class B digital device, pursuant to Part 15 of the FCC Rules. These limits are designed to provide reasonable protection against harmful interference in a residential installation. This equipment generates, uses and can radiate radio frequency energy and, if not installed and used in accordance with the instructions, may cause harmful interference to radio communications. However, there is no guarantee that interference will not occur in a particular installation. If this equipment does cause harmful interference to radio or television reception, which can be determined by turning the equipment off and on, the user is encouraged to try to correct the interference by one or more of the following measures: -- Reorient or relocate the receiving antenna. -- Increase the separation between the equipment and receiver. -- Connect the equipment into an outlet on a circuit different from that to which the receiver is connected. -- Consult the dealer or an experienced radio/TV technician for help.</p> <p>RF Exposure Statement FCC RF warning statement: The device has been evaluated to meet general RF exposure requirement. The device can be used in portable exposure condition without restriction.</p>	<p align="center">DECLARATION OF CONFORMITY</p> <p>X-mini™ KAI X3 Portable Speaker</p> <p>We, Xmi Pte Ltd, declare under our sole responsibility as authorized representative that the following product</p> <p>Brand Name: X-mini™ Model Name: KAI X3 Model Number: XAM33 Is fully in conformity with the essential requirement of the European Council Directive 2004/108/EC & RoHS 2011/65/EU</p> <p>This declaration is based on the full compliance of the product with the following standards:</p> <p>EN55022:2010+AC2011 EN55024:2010 EN61000-3-2:2006+A1:2009+A2:2009 EN61000-3-3:2008</p> <p>The Bluetooth® word mark and logos are registered trademarks owned by Bluetooth SIG, Inc and any use of such marks by Xmi Pte Ltd is under license. Other trademarks and trade names are those of their respective owners.</p> 	
<p align="center">INFORMATION IMPORTANTE</p> <ol style="list-style-type: none"> Veillez bien suivre les précautions inscrites dans ce manuel afin d'assurer votre sécurité. Avant d'utiliser le ce produit, nous vous suggérons fortement de lire ce manuel d'utilisation. Faites attention aux coins, surfaces inégales, objets métalliques, accessoires et leur emballage afin d'éviter tout risque de blessure ou dommage. Garder hors de la portée des enfants. Notez que ce produit n'est pas comestible et ne devrait pas être mis dans la bouche. Ne pas modifier, réparer ou démonter ce produit. Ce faisant, vous risquez des chocs électriques, une défaillance complète du ce produit, etc. Tout ceci n'est pas couvert par la garantie. Ne pas utiliser de diluants ou liquide volatil pour nettoyer ce produit. Notez que la surface du ce produit ne devrait qu'être essuyée avec un linge sec propre. Ne pas utiliser ce produit dans des endroits où la température ou l'humidité sont élevées (exemple : la salle de bains), idéalement, il devrait être utilisé dans un endroit sans poussières et à l'abri du soleil. Ne rien insérer dans ce produit, comme des aiguilles par exemple. Ne pas toucher à ce produit lorsque vos mains sont mouillées car vous risquez de subir des chocs électriques. Baisser le volume de ce produit avant/pendant son utilisation car une montée soudaine du son pourrait l'endommager. Ne pas échapper ce produit et éviter aussi tout impact avec d'autres objets. Ne pas utiliser ce produit dans des endroits dangereux. Si des situations ou des problèmes hors du commun se produisent lors de son fonctionnement, veuillez immédiatement cesser de l'utiliser. 	<p align="center">GARANTIE ET SUPPORT</p> <ol style="list-style-type: none"> Si, dans les 12 mois suivants son achat, il y a preuve que ce produit, en tout ou en partie, soit défectueux à cause de sa fabrication ou de ses pièces, nous le réparons ou le remplaçons, à notre discrétion, sans frais de main d'œuvre ou de pièces, à condition que La facture originale ou le reçu de vente montrant la date d'achat, ou étampe de la part du fournisseur, soit présenté avec le modèle défectueux. Les bris causés par l'utilisation d'accessoires ou autres périphériques qui ne sont pas des accessoires originaux de la marque de commerce X-mini qui sont conçus pour ce produit ne sont pas couverts par la garantie. La garantie ne couvre pas les bris du produit causés par toute modifications, réparation ou démontage effectué par une personne qui n'est pas autorisée par le manufacturier. Tout produit défectueux, en tout ou en partie, devient la propriété du manufacturier. La garantie de ne couvre pas les dommages causés le ce produit est mal utilisé, échappé, frappé ou négligé. 	<p align="center">DÉCLARATION FCC POUR</p> <p>X-mini™ KAI X3 Haut-parleur Portable Cet appareil est en conformité avec le Titre 15 des Règles FCC. Son fonctionnement est soumis aux conditions suivantes : (1) cet appareil ne peut causer des interférences néfastes et (2) cet appareil doit tolérer toute interférence reçue, y compris celle pouvant entraver son bon fonctionnement.</p> <p>Les changements ou modifications non approuvés de façon explicite par la partie responsable de la conformité pourraient anéantir la capacité de l'utilisateur à faire usage de son appareil. REMARQUE : Cet appareil a été testé et jugé conforme aux limites d'un appareil numérique digital de Classe B, conformément au Titre 15 des Règles FCC. Ces limites sont conçues dans le but de fournir une protection acceptable contre les interférences dans une installation à domicile. Cet appareil génère, utilise et peut émettre de l'énergie pour les fréquences radio et, s'il n'est pas installé et utilisé conformément aux instructions, il peut causer des interférences au niveau des communications radio. Toutefois, il n'y a aucune garantie que l'interférence ne surviendra pas dans une installation donnée. Si cet appareil cause une interférence à la réception radio ou télé, interférence pouvant être déterminée lorsqu'on allume et éteint l'appareil, l'utilisateur est appelé à essayer d'y remédier en suivant une ou plusieurs des étapes ci-après : -- Réorienter ou repositionner l'antenne de réception. -- Augmenter l'espace entre l'appareil et le récepteur. -- Connecter l'appareil à une prise sur un circuit différent de celui qui alimente le récepteur. -- Solliciter l'expertise du concessionnaire ou d'un technicien radio/TV expérimenté</p> <p>Déclaration sur l'exposition aux RF Mise en garde de FCC contre les RF: L'appareil a été jugé conforme aux normes générales d'exposition aux RF. L'appareil peut être utilisé dans des conditions d'exposition des technologies portables, sans restriction.</p>	<p align="center">DÉCLARATION DE CONFORMITÉ</p> <p>X-mini™ KAI X3 Haut-parleur Portable</p> <p>Nous, Xmi Pte Ltd, déclarons sous notre responsabilité en tant que les représentants autorisés que le produit suivant</p> <p>Marque de commerce : X-mini™ Nom du modèle: KAI X3 Numéro de modèle: XAM33 est conforme aux spécifications de la directive du Conseil européen en ce qui a trait à 2004/108/EC, RoHS 2011/65/EU</p> <p>Cette déclaration est basée sur la conformité du produit selon les standards suivants :</p> <p>EN55022:2010+AC2011 EN55024:2010 EN61000-3-2:2006+A1:2009+A2:2009 EN61000-3-3:2008</p> <p>L' marque et les logos Bluetooth® sont des marques déposées appartenant à Bluetooth SIG, Inc. et toute utilisation de ces marques par Xmi Pte Ltd sous licence. Les autres marques et noms commerciaux sont ceux de leurs propriétaires respectifs.</p> 	<p align="center">ABOUT US</p> <p>Xmi Pte Ltd is a technology-driven company founded in Singapore on August 2006 by the passionate and creative people behind the X-mini™ brand of products. Its continued dedication to crafting advanced multimedia products designed to meet the dynamic lifestyles of people across the globe has placed the company at the forefront of innovation of digital lifestyle technology.</p> <p>Armed with a lineup of unique award winning products like the X-mini™ EVOLVE Speaker Headphones, Xmi Pte Ltd's philosophy is aimed at delivering superior functionality and uncompromising quality, Xmi Pte Ltd is set to push the limits of possibility and build a global brand synonymous to innovation.</p> <p align="center">X - MINI™ THE BRAND</p> <p>Multiple winner of the prestigious Red Dot Design and iF Design Awards, X-mini™ is revolutionary in the world of portable audio technology, striking the perfect balance of portability and uncompromising sound quality.</p> <p>Conceptualized, developed and commercialized in-house in Singapore, X-mini™ has continually set new industry standards in the field of portable sound.</p> <p>Our tagline Sound Beyond Size best illustrates the benefits X-mini™ products can offer, which also conveys the idea of striving to perform beyond expectations.</p>
<p align="center">ENGLISH</p> <p>TECHNICAL SPECIFICATIONS Dimensions: 78mm x 78mm x 109mm Net weight: 365g Speaker: Magnetically shielded 66mm (4Q) Loudspeaker output: 8W Frequency response: 50Hz - 18kHz Signal-to-noise: ≥ 90db Distortion: ≤ 10% Battery capacity: 2,200mAh Battery charging voltage: 5V (USB) Battery charge time: Minimum of 2.5 hours</p> <p>BLUETOOTH SPECIFICATIONS Operating frequency range: 2.4GHz - 2.48GHz Wireless range: Up to 10 metres (33 feet) Bluetooth compliant: v4.2 Bluetooth profile support: A2DP, AVRCP, HFP, HSP Bluetooth playback time: Up to 8 hours</p>	<p align="center">FRENCH</p> <p>SPECIFICATIONS TECHNIQUES Dimensions: 78mm x 78mm x 109mm Poids net: 365g Enceinte: Blindage magnétique 66mm (4Q) Puissance Haut-parleur: 8W Réponse en fréquence: 50Hz - 18kHz Rapport signal-bruit: ≥ 90dB Distortion: ≤ 10% Capacité de la batterie: 2,200mAh Voltage pour la charge: 5V (USB) Temps de recharge de la batterie: Minimum 2.5 heures</p> <p>SPECIFICATIONS BLUETOOTH Gamme de fréquences de fonctionnement: 2,4GHz - 2,48GHz Gamme sans fil: Jusqu'à 10 mètres (33 pieds) Conforme Bluetooth: v4.2 Profil Bluetooth soutien: A2DP, AVRCP, HFP, HSP Durée d'utilisation Bluetooth: Jusqu'à 8 heures</p>	<p align="center">ESPAÑOL</p> <p>ESPECIFICACIONES TÉCNICAS Dimensiones: 78mm x 78mm x 109mm Peso: 365g Altavoz: Protajido magnéticamente 66mm (4Q) Salida de Altavoz: 8W Frecuencia de Respuesta: 50Hz - 18kHz Señal de Ruido: ≥ 90dB Distorsión: ≤ 10% Batería: 2,200mAh Voltaje Carga Batería: 5V (USB) Tiempo de Carga de Batería: Mínimo 2.5 horas</p> <p>ESPECIFICACIONES BLUETOOTH Rango de frecuencia de funcionamiento: 2,4GHz - 2,48GHz Alcance inalámbrico: Hasta 10 metros (33 pies) Bluetooth Compliant: v4.2 Perfil Bluetooth apoyo: A2DP, AVRCP, HFP, HSP Tiempo Modo de Reproducción Bluetooth: Gasta 8 horas</p>	<p align="center">GERMAN</p> <p>TECHNISCHE ANGABEN Abmessungen: 78mm x 78mm x 109mm Nettogewicht: 365g Lautsprecher: Magnetsich abgeschirmt 66mm (4Q) Lautsprecher Ausgabe: 8W Frequenzbereich: 50Hz - 18kHz Rauschabstand: ≥ 90dB Verzerrung: ≤ 10% Akku Kapazität: 2,200mAh Akku Ladespannung: 5V (USB) Akku Ladezeit: Min 2.5 Stunden</p> <p>BLUETOOTH-SPEZIFIKATION Betriebsfrequenzbereich: 2,4GHz - 2,48GHz Wireless-Reichweite: Bis zu 10 Meter Bluetooth-kompatibel: v4.2 Bluetooth-Profil Unterstützung: A2DP, AVRCP, HFP, HSP Bluetooth-Wiedergabezeit: Bis zu 8 Stunden</p>	 <p align="center">www.x-mini.com</p> 



x-mini
KAI X3

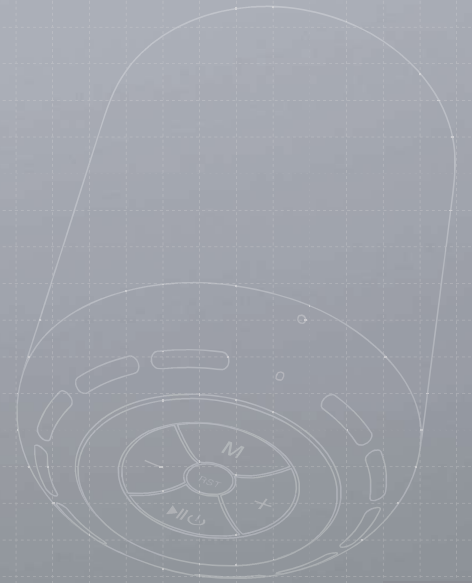
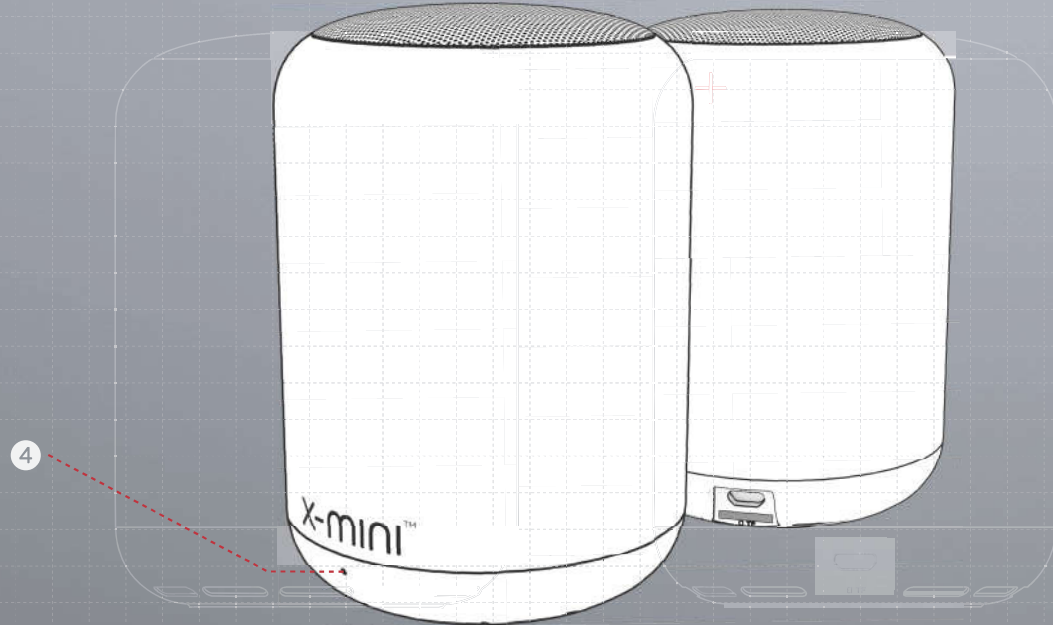
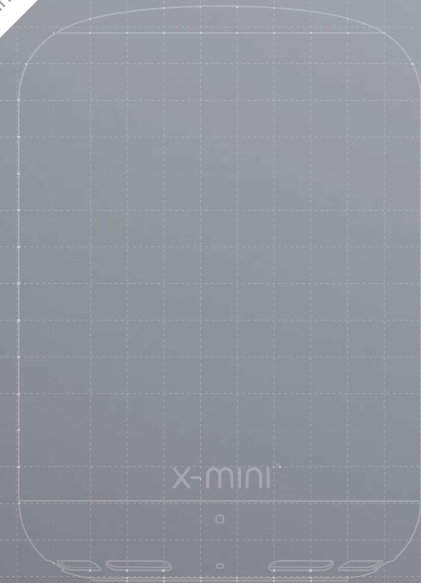
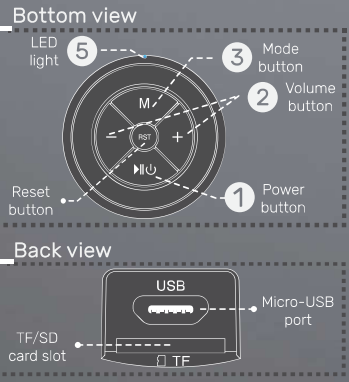

1 Power button



Pairing devices:
Press and hold power button until power on prompt is heard. Search for new Bluetooth device and select X-mini™ KAI X3. The connected prompt is heard once the speaker is paired successfully.

*If pairing is unsuccessful, switch off and on X-mini™ KAI X3 to reattempt.

Disconnecting devices:
Press and hold power button until power off prompt is heard.

2 Volume buttons

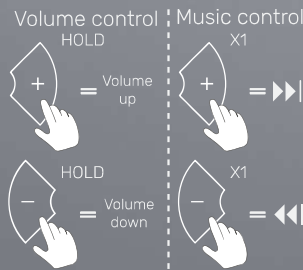

Volume control:
Press and hold + volume button to increase volume
Press and hold - volume button to decrease volume

Music control:
Press + volume button once to change to next song
Press - volume button once to change to previous song

3 Mode button

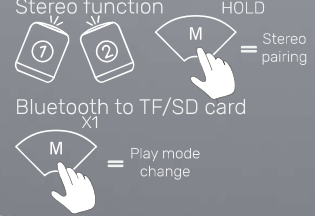

Stereo mode:
Power on two X-mini™ KAI X3s. Press and hold mode button on one X-mini™ KAI X3 (master, left side). Connected prompts are heard once the speakers are paired successfully.

*If pairing is unsuccessful, power off and on both X-mini™ KAI X3s and repeat steps to reattempt.

Disconnecting stereo mode:
Press and hold mode button on either X-mini™ KAI X3.

Mode switch:
Press mode button once to switch between Bluetooth and SD modes.

4 Microphone



Answering call:
Press power button once
End call:
Press power button twice

*Functions and indication tones may vary between devices.

5 LED light

- Power on
- Charging
- Low battery
- Connected/Incoming call
- Pairing mode
- Fully charged

*Audio output gets softer and a warning tone is heard when the battery level of the speaker is low. Recharge before use.

micro SD/TF mode:
1. Insert micro SD card before switching speaker on. Press knob to play music through SD mode.
2. Insert micro SD card after switching speaker on. Music will play automatically in SD mode.

*Support various formats in MP3, FLAC, WMA, WAV, APE. For more information, please refer to X-mini™ support.

*Use only Original micro SD cards to avoid damaging the speaker. Warranty does not cover damages resulted from use of non-Original accessories.