



xsens

MVN User Manual

**User Guide MVN, MVN BIOMECH
MVN Link, MVN Awinda**

Document MV0319P, Revision N, June 2015





Revisions

Revision	Date	By	Changes
N	June 2015	HBE	Changes made to accommodate MVN Studio 4.2 9.3 Add comments after recording 15.3 Software Activation Tool: Offline License Activation or Updating a License 15.4 Software Activation Tool: Applying an Update 15.5 RUS Utility: Rehosting a Sentinel protection key

© 2015, Xsens. All rights reserved. Information in this document is subject to change without notice. Xsens, MVN, MotionGrid, MTi, MTi-G, MTx, MTw, Awinda and KiC are registered trademarks or trademarks of Xsens Technologies B.V. and/or its parent, subsidiaries and/or affiliates in The Netherlands, the USA and/or other countries. All other trademarks are the property of their respective owners.



Table of Contents

REVISIONS	II
TABLE OF CONTENTS	III
ABBREVIATIONS AND TERMS	IX
DEFAULT FOLDERS	X
1 INTRODUCTION	1
2 CONTENT OVERVIEW	2
2.1 MVN LINK SUITCASE WITH CONTENTS	2
2.2 MOTION TRACKER (MTX).....	2
2.3 BODY PACK (BP), BATTERY PACK, AND ACCESS POINT (AP).....	3
2.4 CABLING	3
2.5 MVN AWINDA BACKPACK/SUITCASE WITH CONTENTS	4
2.6 MOTION TRACKER (MTw).....	4
2.7 AWINDA STATION.....	4
2.8 MVN AWINDA CHARGER	5
2.9 “THE SUIT”	5
2.10 MOTION TRACKERS ON THE EXTREMITIES	6
2.11 MVN ETHERNET CAMERA.....	6
2.12 SOFTWARE	6
3 GETTING STARTED	7
3.1 INSTALLATION OF SOFTWARE.....	7
3.2 SETUP HARDWARE	7
3.3 MVN STUDIO WORKFLOW OVERVIEW	7
3.4 TIPS FOR BEST PRACTICE.....	8
3.4.1 <i>Operating conditions</i>	8
3.4.2 <i>Absolute maximum ratings</i>	9
3.4.3 <i>Suit, shirt, short maintenance</i>	10
3.4.4 <i>FabriFoam Velcro Straps</i>	10
3.4.5 <i>Dynamic movements</i>	10
3.4.6 <i>Finding a magnetic “sweet spot”</i>	10
3.4.7 <i>Warming up the filters</i>	10
3.4.8 <i>CH5000 Charger Safety</i>	10
4 SOFTWARE	11
4.1 SOFTWARE INSTALLATION	11
4.2 SOFTWARE ACTIVATION.....	11
4.2.1 <i>Software License Key</i>	11
4.2.2 <i>Dongle License Key</i>	11
4.2.3 <i>Network License Key</i>	12
5 HARDWARE	13
5.1 MVN LINK	13
5.2 MOTION TRACKERS (MTX).....	13
5.3 BODY PACK (BP) AND BATTERY	14



xsens

5.4	SYNC STATION	14
5.5	BATTERY CHARGER	15
5.5.1	Using your Charger	15
5.5.2	Charging	15
5.5.3	Fuel Gauge Recalibration	15
5.5.4	What is fuel gauge recalibration and why is it needed?	16
5.5.5	BP Power on/off and status LED	17
5.5.6	BP Status LED	17
5.5.7	Setup for wired connection via Ethernet	17
5.5.8	Running a Wi-Fi Protected Setup (WPS)	17
5.6	ACCESS POINT (AP)	18
5.6.1	Positioning the Access Point	19
5.7	MVN (BIOMECH) AWINDA	20
5.7.1	Wireless Motion Trackers (MTw)	20
5.7.2	MTw LED Indications	21
5.7.3	MTw Stand-by Mode	21
5.7.4	Exiting stand-by mode	21
5.7.5	Awinda Station	22
5.7.6	Awinda Station Synchronization Ports	22
5.7.7	Awinda Station Status LED	23
5.7.8	Awinda USB Dongle	24
5.7.9	Awinda USB Dongle LED	24
5.7.10	Powering off MVN Awinda	24
5.8	MVN (ETHERNET) CAMERA	24
5.9	THE SUIT	24
5.9.1	Straps	24
5.9.2	MVN Lycra suit	26
5.9.3	Putting on the remaining Motion Trackers	27
5.9.4	Foot pads	27
5.9.5	Putting on the Body Pack and Battery Pack	27
5.9.6	Tracker locations	27
5.10	CONNECTING THE HARDWARE AND SOFTWARE	28
6	MVN STUDIO	29
6.1	STATUS BAR	30
7	WORKFLOW AND FUNCTIONALITIES IN MVN STUDIO	31
7.1	NEW SESSION	31
7.1.1	Create a New Recording Session	31
7.1.2	New Session, step-wise	31
7.2	CONFIGURE AN MVN SYSTEM	32
7.2.1	Enable/disable search for new system	32
7.2.2	System Status	32
7.2.3	Apply Changes	32
7.2.4	Configured Item	32
7.2.5	Suit Color	32
7.2.6	System Name	32
7.2.7	Expanding and Collapsing Views	33
7.2.8	View Hardware Status	33
7.2.9	Update Rate	33



xsens

7.2.10	System Status.....	33
7.2.11	Suit Configuration.....	33
7.2.12	Scenario.....	34
7.2.13	Accept Systems	34
7.2.14	Sync Settings	34
7.3	CONFIGURING THE VIDEO CAMERA	34
7.3.1	Configuration	34
7.4	DEFINE X-AXIS	35
7.5	CONFIGURING THE SYNC STATION.....	36
7.6	CONFIGURATION GROUP	36
7.7	LOADING CONFIGURATIONS USING THE LIBRARY BUTTON.....	36
7.8	HARDWARE STATUS	37
7.8.1	Relocating motion trackers.....	38
7.8.2	MVN Awinda: Changing Radio Channel	38
7.8.3	MVN Awinda: Changing Radio Channel	39
7.8.4	MVN Awinda: Reject Unused Trackers.....	39
7.8.5	MVN Awinda: Forget System	39
7.9	PROPS.....	39
7.10	NAVIGATOR.....	41
8	SETUP.....	42
8.1	BODY DIMENSIONS	42
8.1.1	Offline Body Dimensions	44
8.2	CALIBRATION	46
8.2.1	Calibration steps	46
8.2.2	N-Pose (Neutral pose)	47
8.2.3	T-pose	47
8.2.4	Expert Calibration: Hand Touch	48
8.2.5	Hands-off calibration	48
8.2.6	Calibration quality	48
9	PREVIEW AND RECORDING.....	50
9.1	PREVIEW.....	50
9.1.1	Viewport Icons	51
9.1.2	Views	52
9.1.3	Overcoming distortions	52
9.1.4	Real-time graphs	53
9.1.5	Save and Restore Layout	54
9.2	RECORDING	54
9.2.1	Note for recording for MVN Awinda Users	54
9.3	ADD COMMENTS AFTER RECORDING	55
9.4	RECOVERY OF MVN FILE AFTER SYSTEM CRASH.....	55
9.5	MARKERS.....	56
9.6	NETWORK STREAMER	57
9.7	NETWORK MONITOR.....	59
10	PLAYBACK AND EDITING	60
10.1	PLAYBACK	60
10.2	SYNCHRONIZATION WITH VIDEO	60
10.3	CONTACT POINT EDITING	61



10.3.1	Selection of samples	63
10.3.2	Contact point editing options	64
10.4	REPROCESSING	66
10.5	MULTI-PERSON EDITING	67
11	DATA ANALYSIS	68
11.1	GRAPHS.....	68
11.1.1	Parameter vs. Time	68
11.1.2	Coordination / Phase Plots (Parameter vs. Parameter)	68
11.1.3	Graph handling	69
11.1.4	Graph toolbar	69
11.1.5	Scaling Options	69
11.1.6	Zoom	69
11.1.7	Pan	70
11.1.8	Show/ Hide Legends	70
11.1.9	Show Numerical Values on Graphs	70
11.1.10	Equal axes.....	70
11.1.11	Amount and layout of graphs	70
11.2	CASCADE / TILE WINDOWS	71
11.3	LINKED VIEWS.....	71
12	SAVING AND EXPORTING	72
12.1	APPLYING (SMOOTHING) FILTERS TO EXPORTED DATA	72
12.1.1	Exporter smoothing	72
12.1.2	Output filtering: LXsolver	73
12.2	BVH	73
12.2.1	Frame skip	75
12.2.2	Overwrite first frame with T-pose	75
12.2.3	Output Presets	75
12.2.4	Output Unit.....	75
12.3	C3D.....	76
12.3.1	Points exported in C3D Exporter.....	77
12.4	FBX	78
12.5	MVNX	79
12.5.1	Importing MVNX files into Excel and MATLAB	84
12.6	EXPORT MOVIE.....	85
13	FEATURES OF MVN STUDIO	86
13.1	PLUG-INS.....	87
14	MVN ETHERNET CAMERA	88
14.1	USING THE MVN CAMERA GS650	88
14.2	CAMERA DRIVER.....	89
14.3	NETWORK CONFIGURATION.....	89
14.4	JUMBO FRAMES	89
14.5	CAMERA USAGE GUIDELINES	90
15	XSENS PERIPHERAL SOFTWARE.....	91
15.1	MAGNETIC FIELD MAPPER (MFM).....	91
15.2	FIRMWARE UPDATER.....	91



xsens

15.3	SOFTWARE ACTIVATION TOOL: OFFLINE LICENSE ACTIVATION OR UPDATING A LICENSE	91
15.3.1	Step 1: Retrieve the license information from a Sentinel protection key.....	91
15.3.2	Step 2: Send the C2V file.....	91
15.3.3	Step 3: Apply the received v2c file using the Software Activation tool.....	91
15.4	SOFTWARE ACTIVATION TOOL: APPLYING AN UPDATE	92
15.5	RUS UTILITY: REHOSTING A SENTINEL PROTECTION KEY.....	92
15.5.1	Step 1: Collect Information about the Recipient Computer	92
15.5.2	Step 2: Generate the License Transfer File.....	92
15.5.3	Step 3: Apply the License Transfer File	92
16	TROUBLESHOOT	93
17	WARRANTY AND LIABILITY	97
17.1	CUSTOMER SUPPORT.....	97
18	REGULATORY NOTICES MVN AWINDA	98
18.1	RADIO FREQUENCY EXPOSURE AND EMISSION	98
18.2	FCC STATEMENTS.....	98
18.3	DECLARATION OF CONFORMITY	100
18.3.1	CE Declaration of Conformity MTw2, Awinda Station, Awinda Dongle	100
18.3.2	FCC Declaration of Conformity MTw2	101
18.3.3	FCC Declaration of Conformity Awinda Station	102
18.3.4	FCC Declaration of Conformity Awinda Dongle	103
19	APPENDICES	104
19.1	LYCRA SUIT SIZES OVERVIEW.....	104
19.2	MAGNETIC DISTURBANCES	104
19.2.1	Show magnetic disturbance.....	104
19.2.2	Magnetic Norm	105
19.3	MVN KINEMATICS AND OUTPUT	107
19.3.1	Quaternion orientation representation	107
19.3.2	Conversions.....	107
19.4	BODY PLANES	108
19.5	COORDINATE SYSTEMS	108
19.6	ANATOMICAL MODEL.....	110
19.6.1	Definition of segment axes	110
19.6.2	Bony/anatomical landmarks.....	111
19.7	SEGMENT AXES DEFINITIONS AND ORIGIN DEFINITIONS	114
19.7.1	Spinal segments: L5, L3, T12, T8: Segments 2-5	114
19.7.2	Neck: Segment 6.....	115
19.7.3	Head: Segment 7	115
19.7.4	Shoulder: Segment 8 Right and Segment 12 Left	115
19.7.5	Upper Arm (Humerus): Segment 9 Right and Segment 13 Left	116
19.7.6	Forearm (Radius/Ulna): Segment 10 Right and Segment 14 Left	116
19.7.7	Hand: Segment 11 Right and Segment 15 Left	117
19.7.8	Upper Leg (Femur): Segment 16 Right and Segment 20 Left	117
19.7.9	Lower Leg (Tibia/Fibula): Segment 17 Right and Segment 21 Left	118
19.7.10	Foot (Calcaneus): Segment 18 Right and Segment 22 Left	119
19.7.11	Toe: Segment 19 Right and Segment 23 Left	119
19.8	JOINT ANGLES.....	119



xsens

19.8.1	Euler Extractions for the joint angles	120
19.8.2	Shoulder angle definitions	120
19.8.3	Joint angle outputs	121
19.9	XKF-HM	122
19.9.1	Height tracking	122
19.9.2	XKF-HM Settling time	122
19.10	UPDATE RATE VERSUS SAMPLE FREQUENCY	123
19.11	STRAP DOWN INTEGRATION	123
19.12	THE AWINDA PROTOCOL	123
19.12.1	Choosing a Radio Channel for MVN Awinda	124
19.13	SYSTEM SPECIFICATIONS	125
20	CONTACT POINT EDITING EXAMPLES	129
20.1.1	Example 1	129
20.1.2	Example 2	130
21	WORKING WITH DIFFERENT APPLICATIONS	131
21.1.1	Autodesk 3ds Max	131
21.1.2	Autodesk MotionBuilder	131
21.2	MOTIONBUILDER WORKFLOW	132
22	IMPORTING MVNX FILES TO OTHER PROGRAMS	134
22.1.1	Import to Microsoft Excel	134
22.1.2	Import to MATLAB	139
23	SYNCHRONIZATION WITH THIRD PARTY DEVICES	140
23.1	THE HARDWARE	140
23.1.1	Important note when receiving 5V synchronization pulses	140
23.2	SYNC IN	141
23.3	SYNC OUT	142
23.3.1	Settings in MVN Studio	143
23.4	IMPORTANT NOTICES FOR SYNC IN	143
23.4.1	Sync In Recommended Settings	144
23.5	SYNC IN WITH MVN STUDIO	144
23.6	SYNC OUT WITH MVN STUDIO	144
23.7	SYNCHRONIZATION EXAMPLES	145
23.7.1	Start and stop recording of third party devices using single pulse	145
23.7.2	Start and Stop Recording Third Party Devices with Infinite Pulse Width	145
23.7.3	Synchronizing with Noraxon EMG	146
23.8	MORE SYNCHRONIZATION EXAMPLES	151
24	REFERENCES	152



Abbreviations and Terms

API	Application Programming Interface
AP	Access Point: The method of transporting data from the body pack to the PC
BP	Body Pack, on-body controller unit for the motion trackers, connects to power and wireless transmission of data to host PC via the Access Point
.BVH	Biovision Hierarchy character animation file format
.C3D	Coordinate 3D export format
Character	Subject in 3D view
.FBX	Filmbox animation file format
IK	Inverse kinematics
MTx	Xsens Inertial and Magnetic Measurement Unit with on-body cables
MTx-STR	String of Xsens Inertial and Magnetic Measurement Units
MTw	Xsens completely wireless Inertial and Magnetic Measurement Unit
MT	Xsens Inertial and Magnetic Measurement Unit (generic reference to MTw or MTx)
MVN	MVN native file format
MVN camera (Ethernet camera)	Physical camera packaged with MVN Studio Pro for video reference data
MVN Straps	Velcro straps for attaching MTw to the body
MVN Suit	Lycra suit
MVN system	Complete MVN product (hardware and software)
.MVNA	MVN subject dimensions file
.MVNS	MVN session file
.MVNX	MVN open XML file format
SDK	Software Development Kit
Sensor	Components of the MTx, e.g. gyroscope, accelerometer
Subject	Person in the suit
The suit	MVN Straps and Lycra suit - whichever applies
Motion Tracker	MTw, MTx or MTx-STR
UDP	User Datagram Protocol (for data streaming over Local Area Network (LAN))
XKF	Xsens signal processing methods



Default Folders

Description	Files	Location
Main program	MVN Studio.exe	C:\Program Files\Xsens\MVN Studio <version>\MVN Studio
Documentation	MVN Quick Setup Sheet.pdf	C:\Program Files\Xsens\MVN Studio <version>\Documentation



1 Introduction

The Xsens MVN inertial motion capture system is an easy to use, cost efficient system for full-body human motion capture. MVN is based on Xsens' state-of-the-art miniature inertial sensors and wireless communication solutions combined with advanced sensor fusion algorithms, using assumptions of biomechanical models.

MVN is a completely portable system; it is not restricted to a studio or lab. It can be used anywhere: outside, in the office, and on the work floor. There are no limitations in measurement volume (except the wireless range).

This MVN system is a full body inertial kinematic measurement system, incorporating synchronized video data. Instant graphical output is provided, including joint angles. An additional C3D exporter has been implemented, as well as improved MVNX (XML) output, containing all of the segment information included in the Xsens MVN system as well as joint angle data, center of mass and factory calibrated sensor data.

Examples of fields of use:

- Biomechanics, sport, rehabilitation, ergonomics and human-machine interaction.
Benefit from the fully ambulant measurement system, advanced functional axes calibration, no need to palpate bony landmarks for marker placement, direct low-noise measurement of acceleration and angular velocity enabling easier internal forces/momentum calculations.
- 3D Animation.
Enjoy unprecedented ease-of-use, rich and smooth data, very short setup time, and the absence of cumbersome post-processing of markers or lost data.
- Virtual reality, training & simulation.
Benefit from the highly portable system and a price-point enabling full-body insertion of (multiple) subjects in VR for highest degree of immersion, low-latency smooth motion data.



2 Content overview

2.1 MVN Link suitcase with contents



Figure 1: Suitcase containing the MVN Link System

The MVN Link System arrives in a strong, durable and watertight case. The case has wheels and an extendable handle for easy transportation. The suitcase dimensions meet the requirements for most airline hand-luggage. The suitcase contains:

- 4 MTx String with three trackers
- 6 Motion Trackers (MTx)
- 1 Body Pack
- 1 Battery Pack
- 1 Battery charger
- 1 Access Point
- 1 Upper Body Cable
- 1 Lower Body Cable
- 1 Battery Cable
- 1 Y Cable
- Lycra suit including headband, gloves, shorts, footpads
- Straps for additional securing of trackers
- 1 Segmometer
- Quick set-up sheet

2.2 Motion Tracker (MTx)



Figure 2: Motion Tracker (MTx)



Figure 3: Motion Tracker (MTx-STR)

The MVN Link system contains two types of motion trackers; the single MTx (Figure 2) used as end trackers and the string of three MTx-STR (Figure 3). The motion trackers, MTx, and MTx-STR are the miniature inertial measurement units containing 3D linear accelerometers, 3D rate gyroscopes, 3D magnetometers, and a barometer, which measures atmospheric pressure. These trackers are placed at strategic locations on the body (fixed by the suit), to measure the motions of each body segment. The MTx trackers are positioned on the pelvis, sternum, hands, and head. The MTx-STR's are used to chain the legs (upper leg, lower leg, and feet), as well as for the upper body (shoulders, upper arms, and fore-arms). For more information about Motion Trackers, see Section 5.2.



2.3 Body Pack (BP), Battery Pack, and Access Point (AP)



Figure 4: Body Pack (BP)

Figure 4 shows the Body Pack (BP). The strings of MTx's are interconnected by the Body Pack. It delivers power from the battery pack to the connected MTx's and retrieves their data ensuring exactly synchronized samples. For more information about the Body Pack, see Section 5.3.



Figure 5: Access Point (AP)

Figure 5 shows the Access Point. The Access Point pairs with the Body Pack to handle the data traffic between the BP and the computer. This Access Point connects to the PC or laptop via Ethernet cable or wirelessly and is powered using a proprietary power adapter or laptop battery. One Access Point can connect to multiple MVN systems. For more information about the Access Point, see Section 5.6.



Figure 6 Battery Pack (Battery)

Figure 6 shows the Battery Pack, which connects to the Body Pack via the Battery Cable. The Battery Pack is a single unit made up of 3 Lithium Ion rechargeable cells, and has a typical rating of 10.8V and 2.9Ah. This Battery charges via a single bay standard smart charger and provides up to 9.5 hours of continuous recording time to the system.

2.4 Cabling

While transmission from the subject to the PC is completely wireless, there are a number of cables running through the MVN Link suit, connecting the MTx and MTx-STR's to the Body Pack. Additionally, if the user chooses, there is the option of transmitting motion data to the PC from the BP by directly using an Ethernet cable between the Body Pack and the Access Point. This is particularly useful for applications such as skiing or snowboarding, where the wearer of the suit can connect directly to a laptop carried in a backpack.



2.5 MVN Awinda backpack/suitcase with contents



Figure 7: Suitcase containing the MVN Awinda System

The MVN Awinda arrives in durable backpack with protective frame, which contains:

- 18 Wireless Motion Trackers (MTw)
- 1 Awinda Station
- 1 Awinda Dongle
- 2 Awinda Chargers
- MTw full body Velcro straps, including 3 shirts, headband, footpads, 2 pairs of gloves
- 1 Segmometer
- Quick Setup sheet

2.6 Motion Tracker (MTw)



Figure 8: Motion Tracker (MTw)

Like the MTx, the MTw is a miniature inertial measurement unit containing 3D linear accelerometers, 3D rate gyroscopes, 3D magnetometers, and a barometer. Additionally each MTw contains an internal battery. The trackers are placed at strategic locations on the body (secured by the straps), to measure motion of each body segment. For more details about the MTw, see Section 5.7.1.

2.7 Awinda Station



Figure 9: Awinda Station



Figure 10: Awinda USB Dongle

The Awinda Station or the Awinda USB Dongle controls the reception of synchronized wireless data from all wirelessly connected MTw's. See Section 5.7 for further details.



2.8 MVN Awinda Charger



Figure 11: MVN Awinda Charger

The MVN Awinda Charger is capable of charging six motion trackers. Charging from empty to full takes about one hour.

2.9 “The Suit”

Depending on the system, either a Lycra suit or a set of mounting straps are provided. The Lycra suit, has been designed for MVN Link and the straps for MVN Awinda. The generic term for either mounting type is simply “The Suit”. Each mounting system is dedicated to ensuring a good fixation to the body, to minimize skin motion artefact.

For more information about each Suit type see Section 5.9.



Figure 12: MVN Lycra suit



Figure 13: MVN Awinda Straps



2.10 Motion Trackers on the extremities

The motion trackers are secured to the extremities – the head, hands and feet, using a headband, gloves and a foot pads, as can be seen in the figures below.



Figure 14: Headband



Figure 15: Gloves



Figure 16: Foot Pads

2.11 MVN Ethernet Camera



Figure 17: MVN Ethernet Camera

The MVN Ethernet camera is the Allied GigE Ethernet camera (supplied with MVN BIOMECH). Permits capture of synchronized video with MVN data.

For more information about the MVN Camera, see Section 5.7.10.

2.12 Software

The MVN system is controlled by a software application called MVN Studio. MVN Studio is a 64-bit application for Windows 7 and 8. There are three versions of MVN Studio: MVN Studio, MVN Studio PRO, and MVN Studio BIOMECH.

Additional software packages are available for users with specific needs:

For users wishing to use the facilities offered by MVN, such as the biomechanical model and various other dedicated functionalities, for visualizing and collecting data the MVN Software Development Kit (MVN SDK) is available, where users can create their own user interface.

MVN Studio PRO comes enabled with the capabilities of a real-time streaming interface from MVN to Autodesk Motion Builder® and Maya®. Additionally, the MVN remote control and MVN time-code plug-in are enabled for users who wish to accurately measure the time over which recordings are made (for example to facilitate synchronization with other devices such as cameras and audio equipment that also accept time-code as a synchronization means).

To stream to Siemens PLM software, the Siemens Tecnomatix streamer is available with MVN Studio BIOMECH.



3 Getting started

3.1 Installation of software

Note: Do not connect your MVN System (either Access Point or Awinda Station) until software installation is complete (software installation includes installation of relevant drivers which can be finalized, when the hardware is connected).

Run the downloaded MVN Installer (mvn_studio#_setup.exe). Install with “Administrator” rights. Follow the on-screen instructions.

- See 4.1 for details.

3.2 Setup hardware

If using the MVN (BIOMECH) Link system:

- Connect the Access Point to the computer using the network cable optionally with the Ethernet-to-USB adapter. See Section 5.6.
- After the suit has been put on, connect the head, hands, and feet trackers to the MTx-STR's
- Place the Body Pack on the right and the Battery Pack on the left of the back (for more information on putting on the suit, see section 5.9 or the tutorial video (<https://tutorial.xsens.com/mvn>)).
- Connect the Battery Pack and all strings of trackers to the Body Pack
- Press the button on the Body Pack once to power on the device, a pulsing fading LED, solid LED, beep and finally blinking LED indicate the startup process. See Section 5.3.

If using the MVN (BIOMECH) Awinda system:

- Connect the Wireless Master to the computer or laptop
- Turn on the trackers by pressing the button until each LED is activated and begins to flash
- Place the straps and trackers on the body (for more information on putting on the straps, see section 5.9 or the dedicated tutorial video).

Optional if using MVN Studio BIOMECH

- Connect the power supply and network cable of the MVN Camera. See Section 5.7.10.

3.3 MVN Studio workflow overview



Run MVN Studio. See Section 6.

Start a new session. See Section 7.1.1.

For MVN Studio PRO or MVN Studio BIOMECH users requiring additional hardware (reference camera or sync), initialize this hardware at the new session stage.

Check the hardware status to make sure that all trackers that are needed for the given configuration have been detected by MVN Studio. See Section 7.8.



Calibration. See Section 8.

For this step users should be in an area free of magnetic disturbance. See Section 19.2.

- Ensure that the ‘Calibrate’ icon is active in the workflow tool bar.
- On the Body Dimensions tab enter the subject height and foot size. See section 8.1.



- Click the Calibration tab. Select N-pose **or** T-pose and follow the instructions to perform a sensor to segment calibration. Additional calibration poses are also possible if expert calibration routines are enabled. See Section 8.2.
- Pay attention to the calibration quality displayed in the Messages for Calibration window before applying the calibration to the character. See Section 8.2.6.



Preview and Record. See Section 9.

- The live character can be seen in MVN Studio viewport. See Section 9.1.
- To record a trial, click the red “Record” button. See Section 9.2.



Playback and editing. See Section 10.

- The recorded trials can be played, using familiar playback buttons. See Section 10.1.
- Contact editing is used to manually determine when contact is made between the subject and the surroundings. See Section 10.3.2.



Analysis. See Section 11.

- Graphical representation of all data, real-time and offline. Section 11.1.



Saving and Exporting. See Section 12.

MVN trials are saved directly as files with the .mvn extension. Files with this extension can be opened in MVN Studio. Data can also be exported to:

- **BVH** (BioVision Hierarchical data) embeds captured motion data in ASCII format which can be imported in many animation applications. BVH requires a strict hierarchal structure, and only relative joint angles can be exported into this file format. This will cause differences between the BVH output and the originally captured motion. See Section 12.2.
- **C3D** (Coordinate 3D) is a format used prolifically in optical systems. The format is coordinate 3D; therefore bony landmark points have been calculated and exported from MVN (virtual marker set). See Section 12.3.
- **FBX** (Filmbox) is a platform-independent 3D file format enabling access to Autodesk software (MotionBuilder, Maya or XSI). For some software packages, an FBX plug-in should be installed. FBX files exported from MVN contain position and orientation information of all 23 segments. See Section 12.4.
- **MVNX** is a human readable, XML format which can be imported to many other software programs, including MATLAB and Excel. This format contains the most information, including the sensor data, segment kinematics and joint angles, as well as the subject information needed to recreate a 3D visualization of a character. See Section 12.5.
- **Movie Exporter** is an mpeg-4 (.m4v or .avi) video export tool which contains a capture of the character’s live motion as configured in the display window.

3.4 Tips for best practice

3.4.1 Operating conditions

The recommended operating temperature of the MVN System is between -10°C and +50°C ambient temperature. If operated outside this temperature range performance may decrease or the device might be damaged. Fast transient temperature fluctuations may cause significant temperature gradients across the device. Such gradients cannot be properly modelled by temperature compensation and may



therefore decrease performance. For optimal performance the ambient temperature should remain constant as much as possible *during* the measurement.

NOTE: Never expose the motion tracker to strong magnetic fields. Xsens MT's contain the absolute possible minimum amount of ferromagnetic materials ('hard' and 'soft' magnetic materials). Nonetheless, some minor components can be magnetized permanently by exposure to strong magnetic fields. This will not damage the unit but will render the calibration of the magnetometers useless. This can typically be observed as a (large) deviation in heading. Therefore it is necessary to prevent exposure of Xsens Motion Trackers to strong magnetic fields, such as close proximity of permanent magnets, speakers, electro motors, etc.

It is best to ensure that measurements, in particular calibration steps, are conducted in an area free of magnetic distortions. To ensure a magnetically clean environment, ensure that the colored markers are green at the pelvis, hands and feet during calibration and preferably also during recordings.

The Awinda Station, Awinda USB Dongle, Awinda Chargers, Access Point, Body Pack, Battery Pack, and MT's must be kept **dry** at all times. Condensation and water may damage the internal electronics.

The MT's should be protected from electro static discharges or sources of radiation, as exposure to such sources will damage the internal electronics.

The MT's should be protected from violent handling such as drops on hard surfaces. Excessive shocks or violent handling may damage the MT's. When handling an MT at a desk, it is advised to place cushioning material on the desk.

	<p>With MVN Awinda, if it appears that data performance is less than expected, try changing the radio channel to ensure a channel is used with minimal radio interference.</p>
---	--

3.4.2 Absolute maximum ratings

Stresses above Absolute Maximum Ratings may cause permanent damage to the device.

Description	Value (MVN Link)	Value (MVN Awinda)
Shock (any axis):	100000 m/s ² (10000 g) unpowered/powered	100000 m/s ² (10000 g) unpowered/powered
Operating/Storage Temperature:	0 °C - +50 °C	0 °C - +50 °C





Stresses beyond those listed here may cause permanent damage to the device. These are stress ratings only and functional operation of the MT at these or any other conditions beyond those indicated in the specifications are not implied. Exposure to absolute maximum rating conditions for extended periods may affect device reliability.

NOTE: Drops onto hard surfaces can cause shocks of greater than 100000 m/s² (10000 g) exceeding the absolute maximum rating of the device. Care should be taken when handling to avoid damage. Drops causing shock greater than absolute maximum ratings may not destroy the device but **will** permanently alter the properties of the physical motion sensors, which may cause the device to become inaccurate.



3.4.3 Suit, shirt, short maintenance

To wash the suit, shirt, shorts **remove all cables, BP and MT's**. Follow the instructions on the label inside the suit:

- Machine wash at 30°C – 85 F 
- Do not bleach 
- Do not iron 
- Do not dry clean 
- Do not tumble dry 

For the headband and gloves, remove the MTx and use only cold hand wash.

3.4.4 FabriFoam Velcro Straps

Do not place in washing machine or dryer as this may damage the material. Hand wash in warm water. Use mild detergent if soiled. Rinse well. Gently squeeze out excess water. Air dry, foam side up, on rack or towel or hang to dry. It is best to wash regularly to keep the material clean and free of body salts, oils, etc. This will help to prolong material life.

3.4.5 Dynamic movements

The MVN Suit/Straps should provide enough fastening for most movements. However, depending on the individual anatomy and fit with the Suit/Straps it might be necessary to take additional steps to ensure that the motion tracker follow the movement of the underlying body segment as well as possible. In particular, for users who will carry out extreme movements, martial art, professional athletes or jumping from heights; it is worth considering applying the provided straps over the Lycra suit as reinforcements to make sure the motion trackers follow the movement of the underlying segment. These straps should be tightly bound tape (be careful to not block the blood circulation!) over the locations of the MT on the body. Additionally, in contact sports or other situations where there is a chance of physical impact it might be beneficial to apply some protective measures (e.g. padding) to protect the person wearing the MVN system as well as the MVN system itself.

3.4.6 Finding a magnetic “sweet spot”

In MVN Studio the icon of a magnet can be enabled to give an indication of magnetic environment. When this is enabled, glowing balls appear at the hands, feet and pelvis. Green indicates a safe magnetic environment. Subjects are advised to remain only in areas where indicators are green. If the room is mainly red, at least find an area of green for calibration. Sometimes this can mean to go outside; although often this step is not needed. See Section 19.2 for more details.

3.4.7 Warming up the filters

MVN Studio is based on Kalman filter algorithms. It is best to warm up the system, before making recordings. To warm up the system, stand still for 30 seconds after the initial calibration pose. See Section 19.9 and in particular 19.9.2 for more details.

3.4.8 CH5000 Charger Safety

- Do not expose the charger or power supply to water or liquids.
- Do not open the charger or power supply case, no user serviceable parts are inside.
- Do not cover the fan exhaust or obstruct the airflow, this will cause overheating.
- Use only the manufacturer's power supply and observe terminal polarity.
- Place the charger in a cool spot, away from external heat sources
- Caution - during recalibration the charger may become warm.



4 Software

As mentioned in Section 2.12, the MVN system is controlled by MVN Studio. The installer of the software can be downloaded from www.xsens.com/mvn-studio-download. The instructions below detail the installation procedure.

4.1 Software Installation

Note: Do not connect your MVN System (either Access Point, Awinda dongle, or Awinda Station) until software installation is complete.

Run the downloaded MVN Installer (setup.exe). Always run installation as a user with “Administrative” rights (by right clicking on icon and selecting “Run as Administrator”).

The MVN Studio installer will install:

- MVN Studio
- Documentation
- Example files
- Drivers for:
 - Xsens Access Point
 - MTw trackers
 - MVN Awinda Station and Dongle
 - MVN ethernet camera (Allied/Prosilica)
 - Dlink drivers
 - Bonjour drivers
- Software activation tool

Notes:

With Windows 7, the installer for the MVN Ethernet camera may be hidden behind the MVN installation window. If installation appears to pause, check that this is not the reason (move the installer window to one side). When starting MVN Studio for the first time, allow the Windows firewall to give permission to MVN Studio to start and connect to the internet.

Plug-ins, including: MotionBuilder plug-in, Time Code and Remote Control plug-in and MVN SDK are optional. Separate installers are available for the MVN MotionBuilder and Maya plug-ins, the Unity plug-in and the MVN SDK. The Time Code and Remote Control plug-in is part of the MVN Studio installer and is activated through licensing.

4.2 Software Activation

MVN Studio needs to be activated before use. Activation can be done by three types of license keys; Software; Dongle; Network. More information about the licensing can be found in section 15.3.

4.2.1 Software License Key

When using a software license key, license activation is necessary. The Software Activation tool can be started from Start Menu > Xsens > MVN Studio 4.x > Software Activation. Follow the on-screen instructions to start the activation, use the product key sent to you by customer service in email and ‘MVN Letter’.

4.2.2 Dongle License Key

Once MVN studio has installed and your license dongle is connected, the software will immediately recognize the license and open MVN Studio.



Extension licenses or upgrade licenses can be activated on the dongle using the Software Activation tool, which can be started from Start Menu > Xsens > MVN Studio 4.x > Software Activation.

4.2.3 Network License Key

When using a network license key, the red dongle needs to be used on a pc (server) that is running a service called 'Sentinel LDK License Manager'. This service needs to be started by running an installer, which can be downloaded from:

Xsens website: <https://www.xsens.com/mvn-studio-download/>

Look for the download 'Sentinel HASP/LDK - Windows GUI Run-time Installer'.



5 Hardware

5.1 MVN Link

The standard MVN System consists of a combination of hardware and software. The previous section described how to install the software. The following will provide an overview of the hardware, which includes the MTx's, Body Pack, Sync Station and Access Point; and how to assemble the devices into the mounting system (Lycra suit or MVN Mounting straps).

5.2 Motion Trackers (MTx)

The MTx is a complete miniature inertial measurement unit with integrated 3D rate gyroscopes measuring angular velocities 3D linear accelerometers measuring accelerations including gravitational acceleration, 3D magnetometers measuring the (earth) magnetic field, and a barometer to enable measurement of atmospheric pressure.

Two types of motion trackers are integrated in the suit, the MTx, and MTx-STR. These are identical on the inside but have different connectors, as can be seen in Figure 2 and Figure 3.



The back of the MTx displays various regulatory notices and 2D barcodes used by Xsens for quality control and tracking, as well as the MTx product code (MTx2-4A7G6) and serial number¹ (SN).

A Velcro strip is attached to the back of the MTx tracker around the sticker in order to allow for easy mounting of trackers onto the suit.

¹ Also known as Device ID.



5.3 Body Pack (BP) and Battery



Figure 18: Body pack and battery

The Body Pack (BP) interconnects multiple strings of MTx's and retrieves their data ensuring exactly synchronized samples. The collected data is transmitted by an optimized 2.4 or 5.0 GHz spread spectrum wireless link to the Access Point connected to the PC or via Ethernet cable.

On the top of the Body Pack there are 4 connectors. With Xsens facing upwards, from right to left:

- The large connector is a 5 pin connector which connects to the Battery Pack cable
- The two central connectors are 5 pin connectors to connect to the strings of trackers
- The leftmost connector is planned for future use

On the bottom of the Body Pack, there are 3 connectors:

- One Ethernet connector which can be used for cabled recordings, when the system is directly connected to the recording PC rather than transferring data via wireless signal
- A micro USB connector, supported for future use to configure the BP
- The 3rd connector supported for future use

The BP is powered by a single Battery Pack (rechargeable smart Lithium Ion battery pack). The Battery Pack has a typical operating time of 9 hours (using the wireless connection) and can be charged using the provided charger.

5.4 Sync Station



MVN Link (version 4.1 onwards) supports synchronization with third party devices using a Sync Station. The figure to the left shows the BNC connectors of the Sync Station.

Section 7.5 explains how to set up synchronization of the Sync Station and Section 23 provides more details and examples with third party systems.

Note that if synchronizing with a third party device sending 5V, it is advised to purchase (from eg Farnell) a 3.3 - 5V / 5V - 3.3V SMD level translator to prevent damage to the SyncIn ports of the Sync Station.



5.5 Battery Charger

The CH5000 is a standalone desktop smart, standard battery charger with the added ability to recalibrate the fuel gauge on smart battery packs.

5.5.1 Using your Charger

Place the charger on a flat, level surface away from sources of heat and moisture. Plug the DC connector from the power supply into the back of the charger and connect the power supply to the mains AC supply using the cable supplied.

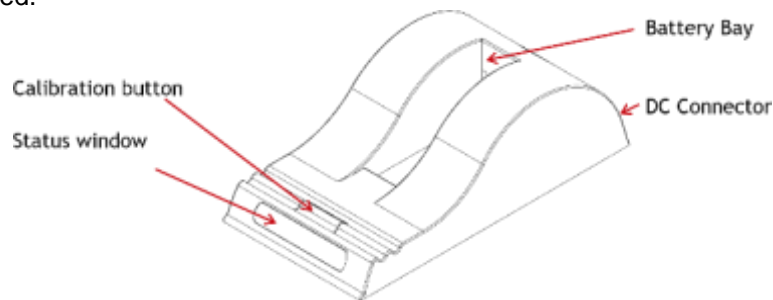

5.5.2 Charging

Place the battery into the battery bay ensuring that the 5-way connector is fully seated. The LEDs in the status window will provide status information and the charger will automatically begin charging.

LED Indication:

The status of the battery is indicated by the LEDs visible in the status window:

Green flashing	Battery charging
Green solid	Battery fully charged
Blue flashing	Battery in calibration mode
Blue solid	Battery fuel gauge calibrated
Red flashing	Battery fuel gauge needs recalibration
Red solid	Error

Recharge and recalibration Time:

The recharge time for the battery (NC2040) is 3 hrs. The time given is for a full charge from 0% to 100% state of charge.

Recalibration is 16-20 hrs. A calibration cycle will be faster if the battery is fully charged to begin with.

5.5.3 Fuel Gauge Recalibration

If fuel gauge recalibration is needed, the red LED on a calibrating charger will flash upon insertion of the battery. This provides feedback on the accuracy of the fuel gauge.

At this point you can choose to either calibrate the fuel gauge or to charge the battery. Calibration takes longer than charging and it may not be convenient to go through the calibration cycle at that moment.



To recalibrate the fuel gauge, press the button on the front of the charger. The charger will automatically begin to charge the battery if the button is not pressed.

The blue LED will flash to indicate that the battery is undergoing the recalibration cycle. During calibration the discharge resistors will be cooled by the fan. Removing the battery, or pressing the calibration button again will re-start the process from the beginning.

At the end of this procedure the blue LED will stay constant, indicating a fully calibrated fuel gauge. Warm environments can cause calibration failure - keep the charger away from direct sunlight or heat sources.

Impedance-Tracking fuel gauge recalibration is achieved by charging the battery, allowing it to rest, discharging it and allowing it to rest again as shown below:

- Charge the battery to full charge and allow it to rest for at least 5¼ hrs.
- Discharge the battery to empty and allow it to rest for 5¼ hrs
- At this point the fuel gauge is calibrated, but the battery is partially discharged and will require a recharge

The temperature during the process must remain between 10°C & 40°C.

5.5.4 What is fuel gauge recalibration and why is it needed?

As the battery ages and is used, its available capacity shrinks - so with each cycle, your device's runtime gets a little bit less.

A good rule of thumb is that Li Ion batteries lose 5% capacity per 100 cycles & 5% per year.

For more details on smart charging and recalibration go to www.inspiredenergy.com



5.5.5 BP Power on/off and status LED

Each BP has one push button with integrated LED, which controls its power state.

- Power on: Press button once, a single beep will sound and the LED will begin to blink slowly: 1 second on, 1 second off
- Power off: Press button **three times**, three beeps will sound and the LED will stop blinking.

5.5.6 BP Status LED

The status LED changes color depending on the BP state. See Table 1 for an overview.

Table 1: LED indicators on the Body Pack

LED indication	active mode
Off	Power down
Slow fading flash	Body Pack turning on
Solid	Wireless mode – searching for host
Flashing	Wireless mode – connected to host
Strobe flashing	Wireless mode – sending data

5.5.7 Setup for wired connection via Ethernet

This section refers to the wired connection between Body Pack and PC, via Ethernet cable. MVN is configured to operate in wireless transmission mode by default. However, an Ethernet connection can be made between the BP and the AP in order to directly transfer data to the PC.

Note: The Ethernet connection should be established prior to turning on the BP.

5.5.8 Running a Wi-Fi Protected Setup (WPS)

In order to establish a connection between a Body Pack and an Access point, users must conduct a Wi-Fi Protected Setup (WPS).

- After the AP is turned on, press and hold the WPS button located on the side of the unit for 2 seconds, until the connection light begins to flash (3 rapid strobes followed by a pause). From the time this flashing begins you have 2 minutes to create a connection with the body pack.
- Next, initialize the Body Pack and wait for the unit to beep and begin searching for a wireless connection. Once the BP is initialized, press and hold the power button for 2 seconds and wait for the LED to begin flashing like the AP LED.
- A successful WPS is indicated by a beep and the BP LED will return to intermittent flashing.

See the Tutorial video “WPS connection”. Click [Image](#) or [address](#) for a direct link to the tutorial.



<https://tutorial.xsens.com/video/wps-connection>

5.6 Access Point (AP)

The MVN System comes with one Access Point (AP) which handles the data traffic between the BP and the computer. The Access Point should be connected to the PC via Ethernet cable through the Ethernet port or using the supplied Ethernet to USB adapter.

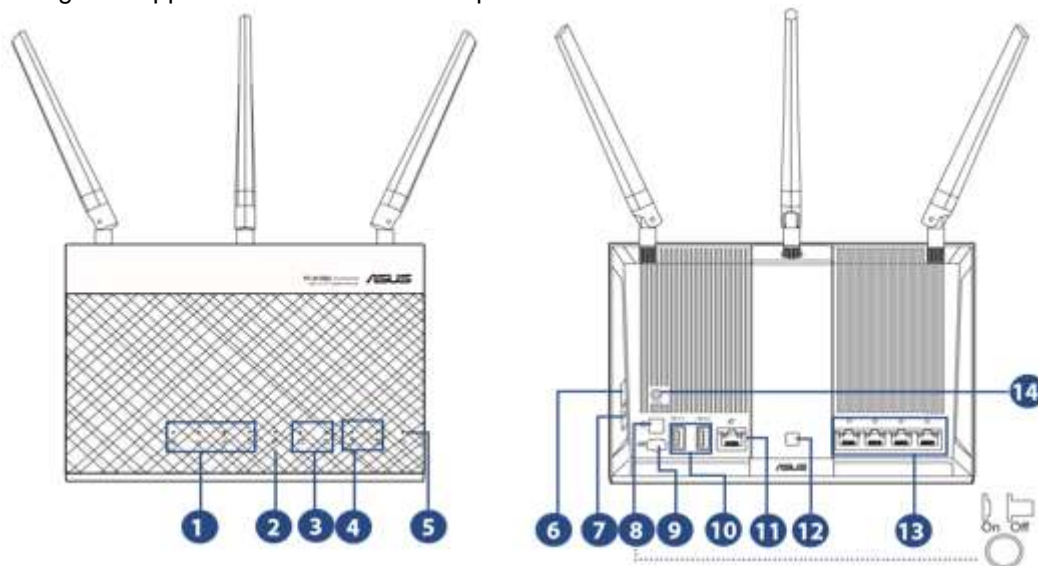

1. LAN 1~4 LED
 - Off: No power or no physical connection.
 - On: Has physical connection to a local area network (LAN).
4. 2.4GHz LED / 5GHz LED
 - a. Off: No 2.4GHz or 5GHz signal.
 - b. On: Wireless system is ready.
 - c. Flashing: Transmitting or receiving data via wireless connection.
5. Power LED
 - a. Off: No power.
 - b. On: Device is ready.
 - c. Flashing slow: Rescue mode
 - d. Flashing quick: WPS is processing.
6. WPS button
 - a. This button launches the WPS Wizard.
8. Power button



- a. Press this button to power on or off the system.
9. Power (DC-IN) port
 - a. Insert the bundled AC adapter into this port and connect your router to a power source.
12. LED On/Off button
 - a. Press this button to turn on/off the backlight LED on the panel.
13. LAN 1 ~ 4 ports
 - a. Connect network cables into these ports to establish LAN connection.
14. Reset button
 - a. This button resets or restores the system to its factory default settings

5.6.1 Positioning the Access Point

For the best wireless signal transmission between the wireless router and the network devices connected to it, ensure that you:

- Place the wireless router in a centralized area for a maximum wireless coverage for the network devices.
- Keep the device away from metal obstructions and away from direct sunlight.
- Keep the device away from 802.11g or 20MHz only Wi-Fi devices, 2.4GHz computer peripherals, Bluetooth devices, cordless phones, transformers, heavy-duty motors, fluorescent lights, microwave ovens, refrigerators, and other industrial equipment to prevent signal interference or loss.
- To ensure the best wireless signal, orient the three detachable antennas as shown in the drawing below.



Note: If the AP is connected to the computer through the supplied Ethernet to USB adapter, it will not function when a “Selective Suspend” power management feature is enabled on the PC/Laptop being used for recording. When the AP is used with “Selective Suspend” turned ON, the computer may hang during shutdown or possibly not shutdown correctly. You must therefore disable power management for the USB hub to prevent this. To do this, follow these simple steps:

From the Start Menu >Right click on Computer >Manage >Device Manager >Universal Serial Bus Converters >Right click on USB Root Hub >Properties >Power Management.

Uncheck the box “Allow the computer to turn off this device to save power.” OK your way out.

NOTE: Doing this may significantly reduce laptop battery life.



5.7 MVN (BIOMECH) Awinda

5.7.1 Wireless Motion Trackers (MTw)

The MTw provides 3D angular velocity using rate gyroscopes, 3D acceleration using accelerometers, 3D earth magnetic field using magnetometers, as well as atmospheric pressure using the barometer. Combined with Xsens algorithms, 3D drift-free orientation is provided. The MTw is an excellent measurement unit for orientation measurement of human body segments, in particular because it is also designed to maintain very high accuracy time synchronization of the individual sensor readout across a wireless network of multiple units. This is essential when measuring joint angles accurately.

The MTw is powered using a LiPo battery. The battery can be in operation for up to 6 hours, and maintain a level of charge in stand-by for approximately 90 hours when in sleep mode. It will be fully recharged after one hour docked in a wall powered Awinda Station. For more technical details on the MTw, sensor component specifications and orientation performance, see Section 19.13.



On the top of the MTw is an LED which indicates of device status.

The MTw charges via micro USB connection located on its base. Next to this is a power button used to power each MTw on and off.

The back of the MTw displays 2D barcodes used by Xsens for quality control and tracking, as well as the MTw product code (MTw2-3A7G6) and serial number² (SN).



On the side of each MTw is a label indicating the pre-defined on body position.

Velcro attached to the back of the MTw tracker allows easy fixation to the straps.

² Also known as Device ID.



5.7.2 MTw LED Indications

The following lists the LED indications of the MTw, which are a combination of the device states and the Awinda protocol states of the MTw.

State	Description
Power-up	Blinking.
Docked and fully charged	ON
Charging	Slow fade from ON to OFF as a percentage [%] of battery status. A slow cycle means an almost full battery. A quick cycle means an almost empty battery.
Scanning	Pulsating out of sync with Awinda Station (CONN LED)
Connected	Slow symmetric ON/OFF toggle in sync with Awinda Station (CONN LED).
Measuring	Fast symmetric ON/OFF toggle in sync with Awinda Station (CONN LED).
Battery Low	Quick Triple Pulses, overrides other states until charging again.
Flushing	Double pulse in sync with Awinda Station (CONN LED).
Stand-by	OFF. Blinks for 3 s, if motion has been detected, while searching for a radio connection.

5.7.3 MTw Stand-by Mode

Following a wireless connection to the Awinda Station or Dongle, the MTw enters measurement mode. If the radio of the Awinda Station or Dongle has been switched off for longer than 30 seconds the MTw will enter stand-by mode. In this mode, the MTw will shut down its power and stop the LED blinking, but monitor change in magnetic field every second. See below for exiting standby mode.

5.7.4 Exiting stand-by mode

The MTw will monitor its movement, if there is considerable movement, and there is a signal from an Awinda Station or Dongle, the MTw will become active again.

To manually bring the MTw out of stand-by mode, reactivate the radio of the Awinda Station, and move the MTw. A simple 90 degree turn or simply lifting it from the suit case to apply to the subject should be enough.



5.7.5 Awinda Station



Front view of the Awinda Station, showing the LEDs. A description of the LEDs is provided in Section 5.7.7 below. On top are docking spaces for 6 MTw's with recessed micro USB connectors. On the side is a foldable and rotatable 2.4 GHz antenna for maximum range.

The external antenna of the Awinda Station enables a wireless range indoor/outdoor: 20/50 m (60/150ft).



Back view of the Awinda Station, showing the DC power connector, the USB connector and 4 BNC sync I/O connectors for synchronization with external devices.

5.7.6 Awinda Station Synchronization Ports

On the back of the Awinda Station there are four BNC ports, two Sync In ports and two Sync Out. The ports have been configured to send (Sync Out) or receive (Sync In) TTL pulses 0-3.3V.

Note that this 3.3V is lower than some devices, which will be synchronized with the MVN System. These other devices use 5V. For this reason it is advised to separately purchase (from eg Farnell) a 3.3 - 5V / 5V - 3.3V SMD level translator. This will prevent damage to the SyncIn ports of the Awinda or Sync Station when receiving 5V pulses from third party systems. In general sending a 3.3V pulse from an Awinda or Sync Station SyncOut port is fine. Therefore unless a threshold of 5V of the third party system is required, in which case the 3.3V-5V SMD level translator will be required.

For software configuration of the synchronization channels, see Section 23.



5.7.7 Awinda Station Status LED

The Awinda Station has five LED indicators. From right to left, these indicators are:

LABEL	LED	DESCRIPTION
CHRG [CHaRGeR functionality]	OFF	When no mains power supply is connected to the Awinda Station.
		GREEN: When 12V power supply is connected (mains power supply).
STAT [STATus of the Awinda Station]	OFF	OFF: When no power supply is present and when MVN Studio is not started. Power is from mains power supply and / or USB.
		GREEN: Both USB connection present and MVN Studio running connected to driver.
		ORANGE: USB connection to host PC is present.
		RED: Only power supply connected or error has occurred, e.g., a short-circuit of an MTw.
EXT [EXTeRnal connection]	OFF	Remains off unless external connection made.
		GREEN: External connection e.g. sync port.
CONN	OFF	OFF: No wireless connection.
		GREEN slow blinking: (1 blink per second), radio switched on. When MTw connects, MTw LED and CONN LED blink synchronously. Fast blink: Measurement Mode.
DATA	OFF	OFF: No data received.
		GREEN: Measurement mode.
		ORANGE: Flushing. Flushing is the action of transferring data that has been stored on the MTw buffer, while the MTw was out of range and unable to transfer data in real-time to the Awinda Station.
		RED: Recording mode is active. This allows the remote monitoring that the host PC has initiated a recording successfully.

Note:

The power supply is needed to charge docked MTw's or to change between power off and power on, of docked MTw's. Only the power supply is needed for charging purposes (USB is not needed in this case). Power supply and USB connection are required for firmware updates or location reassignment of MTw's.

Power supply is not needed for wireless communication (e.g. measurement/recording).



5.7.8 Awinda USB Dongle



The Awinda USB dongle has the same wireless capabilities as the Awinda Station, in that it can accurately control the reception of data of up to 32 MTws.

Given that the Dongle does not have an external antenna its range is shorter than the Awinda station; indoor/outdoor 10/25m (30/75ft).

5.7.9 Awinda USB Dongle LED

The Awinda USB dongle has one white LED.

State	Description
Radio Off	LED off.
Scanning for MTw's	Pulsating LED.
Connected	Slow symmetric ON/OFF toggle (MTw blinks in sync with LED of dongle).
Measuring	Fast symmetric ON/OFF toggle (MTw blinks in sync with LED of dongle).

5.7.10 Powering off MVN Awinda

Power off the MTw's by clicking on each tracker's power button.

5.7.10.1 Power off wirelessly connected MTw's

To power off wirelessly, the system should be wirelessly connected. To power off, go to menu >Tasks >Switch Off Hardware. All MTw's will switch off. The MTw LEDs and the CONN LED of the Awinda Station will switch off.

5.8 MVN (Ethernet) Camera

The MVN Ethernet Camera is a high quality professional GigE camera with a C mount. The GigE interface enables the use of long cables (max 100 m) and standard 1 Gigabit Ethernet cards for interfacing. Currently in MVN Studio the frame rate is limited to 60 Hz, but the camera itself is capable of 120 frames per second (fps), depending on lighting conditions. The camera has a global shutter and is capable of advanced triggering and synchronization features.

5.9 The suit

The MVN system arrives with motion trackers either mounted into a Lycra suit or located in a tray with a set of accompanying MVN straps. The generic term for the straps or the Lycra suit is simply "The Suit". Below a description of how to mount the straps or suit is explained, followed by the advice for the extremities (hands, feet and head), which are the same for both systems.

5.9.1 Straps

The MVN Strap set consists of a set of patented non-latex composite material; these are often used in the medical profession, and are safe and hygienic. Additionally zip-fastened T-shirts in three sizes are provided for securing the sternum and shoulders.

Straps are provided as a standard mounting system with MVN Awinda and are useful for interchanging setups between (different sized) subjects.



Straps are suitable for a majority of the adult population and can be placed directly on the skin for the close contact, or on top of the clothing for comfort. If worn over clothing, it is advisable to wear relatively tight-fitting clothes.

The motion trackers are provided with a code indicating segment position.

'L' or 'R': left or right side of the body.

Segment: An abbreviation of the segment name.

While the straps are not labelled, the dimensions give an indication of their intended locations.

Segment	Width [cm]	Length [cm]
Pelvis	10	140
Upper Leg	10	72
Lower Leg	5	55
Upper Arm	5	55
Forearm	5	30



5.9.1.1 Putting on the Straps

Below are a few simple steps to help put on the straps. It is advised to watch the tutorial video for more detailed and visual information.

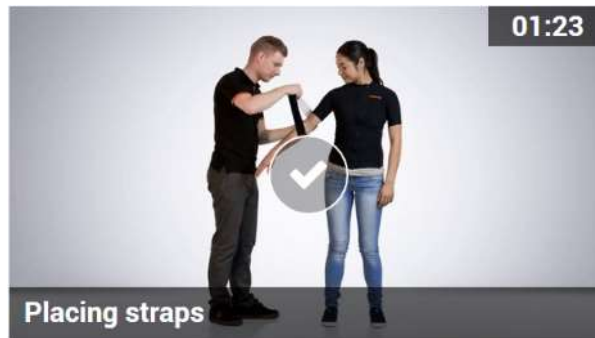

<https://tutorial.xsens.com/video/placing-straps>

- It is recommended to begin by putting on the top.
- Since the sternum and shoulder trackers are attached to Velcro patches on a zip-fastening t-shirt, it is advised to secure this garment before attaching the upper arm straps.
- For the arms, legs and pelvis: Straps should first be placed (tightly) onto the limb in question, fasten the tracker in place then wrap the remaining length of the strap tightly around the limb and fasten using the Velcro tab.
- It is necessary to have assistance for positioning the motion trackers of the shoulder blades after the zip on the vest has been secured. It is also advisable to have assistance for accurate positioning of the tracker at the pelvis, while the wearer (or second assistant) wraps the remaining length of the strap around the waist.
- Check that the Straps are fastened tightly enough to the body.
To do this, the subject wearing the straps should walk, run or perform sample movements to be measured. If the straps become loose, re-tighten them and repeat the check.
NOTE: When tightening the straps, pull the strap from the center of the length rather than at the end!



5.9.2 MVN Lycra suit

A Lycra suit is provided with the MVN Link system. The MVN Lycra Suit is available in 5 different sizes (S, M, L, XL and XXL). Before putting on a suit, ensure that the size is appropriate; refer to Table 7 in the appendix for this information. The suit must be tight fitting, therefore choose the appropriate suit size. Note that the fabric is stretchable, a medium size suit can fit to both a short muscular athlete (e.g., 1.60 m, 70 kg) and a tall slim person (e.g., 1.75 m, 65 kg).

Take care when putting on the suit; you are working with delicate materials. The subject is advised to wear closely fitting shorts and a tight shirt underneath the MVN Lycra Suit. Other clothing can be worn on top, no connection or line-of-sight is needed to the external world other than the wireless data link. Follow these steps to put on the suit:

Important:

- The zip is at the front of the Lycra suit.
- Do not pull aggressively on the material, work gradually from the feet to the neck.

5.9.2.1 Putting on the Lycra suit

Below are a few simple steps to help put on the Lycra suit. Again it is advised to watch the video on the tutorial portal for more detailed, visual information.



<https://tutorial.xsens.com/video/putting-on-lyrca-suit>

1. Unzip the zipper.
2. The subject should wear only tight shorts and t-shirt and socks at this stage.
3. Slide the legs through the lower part of the suit. Put the feet through the loops underneath the trouser legs, the zip channel should be placed in the front! A tight material is chosen for optimal attachment of the MT's, so take time to pull up the suit bit by bit until it fits comfortably.
4. When the suit is at the correct height, put one arm through the sleeve and use the other arm to pull the suit around the shoulder. Follow the same procedure for the other arm.
5. To minimize sliding of the MT's on the arms, place the thumbs through the loops at the end of the sleeves. This can also be done after putting on the gloves.
6. Zip up the zipper
7. If possible pull lightly at the suit around the shoulders and neck, so the suit can divide the stretch well, and fit comfortably.

5.9.2.2 Placing the MT's in the Lycra suit

Upon delivery, the Lycra suit will come with MTx inside already. However, for changing suit sizes or after washing, you will need to put the motion trackers back in the suit. It is advised to do this when the "empty" suit is already on the subject. The video on the tutorial portal shows how to do this best..



<https://tutorial.xsens.com/video/preparing-hardware-mvn-link>

1. Unzip all zipper channels on the suit
2. Secure each MT into the suit using the Velcro patches on both the trackers and the Lycra.
3. Connect the cables between strings of trackers.
4. Ensure that all MT's are in the approximate locations as indicated in the tutorial video.

5.9.3 Putting on the remaining Motion Trackers

When the suit has been put on, motion trackers for the head, hands and feet will remain outside of the Lycra. The head band is fitted with a Velcro patch, and gloves are fitted with a pocket for motion tracker placement. The motion trackers for the feet are secured to the shoes using foot pads, as described in section 5.9.4.

5.9.4 Foot pads

Dedicated foot pads have been made to facilitate placement of the motion trackers on the feet, these pads can be used with many different types of shoes and remain fixed to the feet, minimizing motion of the tracker on the foot and ensuring reliable motion capture data and foot contact detection.



Figure 19: Foot pads

To use, place the pads with the motion tracker attached onto the bridge of the foot, tongue of the shoe. It is best to push this a little further to the front of the foot, since when the shoes are fastened, it can slip upwards. Make sure the shoe fastening e.g. prevent the tracker from shifting within the shoe.

5.9.5 Putting on the Body Pack and Battery Pack

The Body and Battery Packs are placed into the pockets at the back of the Lycra suit. While it is not crucial, it is more comfortable if you the Body Pack is on the right and the battery on the left.

5.9.6 Tracker locations

The placement of the motion trackers onto the correct segment is very important, as each tracker has a given ID, which is used throughout the motion capturing procedure. Additionally, it is important that the motion trackers are positioned on the segment in a place where maximal range of motion and a minimal amount of skin motion artefact occurs. When wearing the Lycra suit, it is more likely that the MTx's are positioned correctly than with the Straps. Therefore please refer closely to the following information to ensure the best placement. Table 2 describes the positioning of the motion trackers.



Table 2: Description of MT locations

Location	Abbreviation	Optimal position
Foot	FOOT	Middle of bridge of foot
Lower leg	LLEG	Flat on the shin bone (medial surface of the tibia)
Upper leg	ULEG	Lateral side above knee
Pelvis	PELV	Flat on sacrum
Sternum	STERN	Flat, in the middle of the chest
Shoulder	SHOU	Scapula (shoulder blades)
Upper arm	UARM	Lateral side above elbow
Fore arm	FARM	Lateral and flat side of the wrist
Hand	HAND	Backside of hand
Head	HEAD	Any comfortable position

Watch the video on the tutorial portal for instructions on how to put place the MTw's on the straps.



<https://tutorial.xsens.com/video/preparing-hardware-mvn-awinda>

5.10 Connecting the hardware and software

To connect the hardware and software, connect to the Access Point or plug the Awinda Station into the USB port of the pc. When using the MTx, make sure that the BP is switched on. Start MVN Studio to begin working with the system.



6 MVN Studio

MVN Studio is easy-to-use software, which can be used for real-time viewing and recording. Off-line playback, analyzing and editing of previously recorded sessions are also possible with MVN Studio. Figure 20 shows a typical view of MVN Studio when a recording has been made.

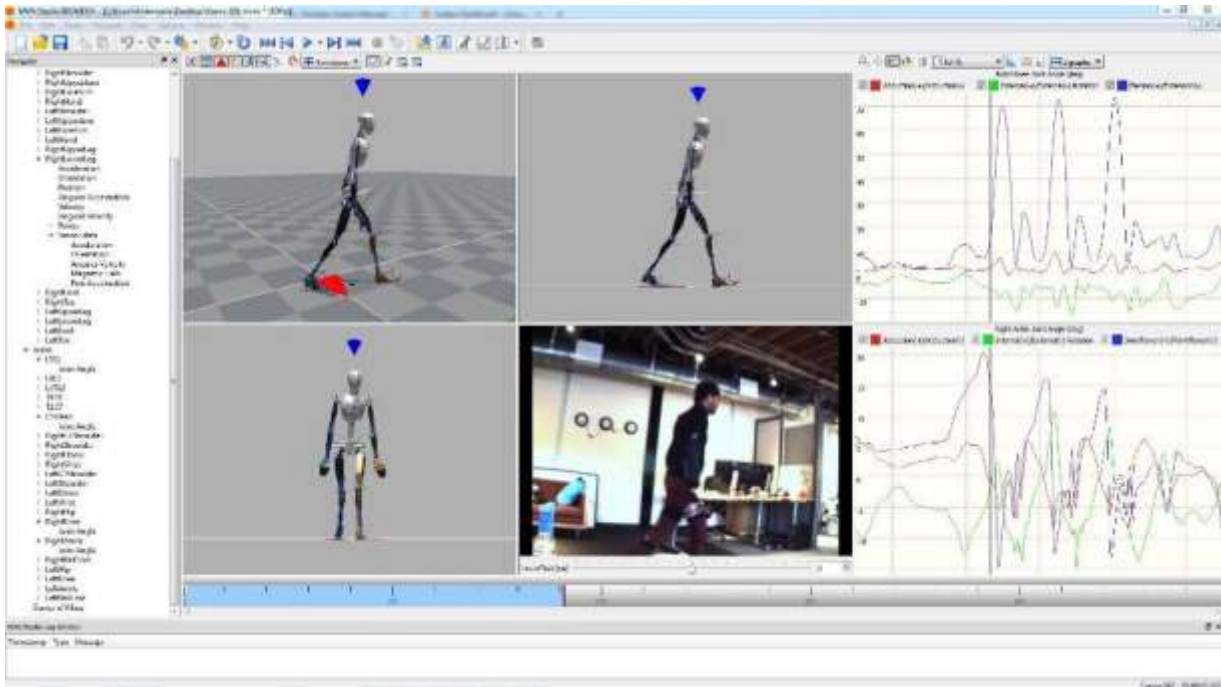

Figure 20: MVN Studio interface

The main tool bar at the top of the MVN Studio interface is displayed in Figure 21 below. Using this toolbar, much of the functionality of MVN Studio can be called.



Figure 21: Main toolbar in MVN Studio

The “Snooze toggle” is for energy saving purposes. Activate snooze to save power, for example, if MVN Studio is running, but the subject is temporarily not required to perform measurements. Note that this setting controls only the MVN Link system. It does not save power when using MVN (BIOMECH) Awinda.



6.1 Status Bar

At the bottom of the MVN Studio interface is the status bar. It is important to pay attention to the icons shown here, as they give important information about the status of the system.



Figure 22: Example of Status Bar in MVN Studio

- Frame number - Time
- Hardware status – status of wireless connection
 - Disabled
 - Searching
 - Ready
 - Sleep mode
- Power – energy levels of batteries in for the Battery Pack or MTw's³
 - Empty
 -
 -
 -
 -
 - Full
- Radio – quality of wireless connection for the BP or MTw's⁴
 - Unknown
 - Bad
 - Moderate
 - Good
- Update Rate: 60Hz, 100Hz, 120Hz, 240Hz
- See Section 19.9 for more information about sample frequency versus update rates.

³ Note that the battery indicators are also available in 'Hardware' pane. The animated battery in the status bar indicates the battery life of the MTw with the least amount of power.

⁴ Note that the signal strength indicates that of the weakest wireless link to the connected MTw network.



7 Workflow and Functionalities in MVN Studio

MVN Studio is designed for optimal flow of the steps required for recording and analyzing motion. Different workflow items become active at various stages.



Figure 23: The workflow toolbar gives the user an optimal interface setup per functionality: Hardware and Fusion Setup, preview and record, playback and editing and analysis

7.1 New session

A new session is created during the workflow stage “Hardware and Fusion Setup”. Before creating the new session, ensure that the hardware is connected and powered on.

7.1.1 Create a New Recording Session

To create a new session, click the icon or go to File >Create a new recording session. Figure 24 shows the first interface to appear.

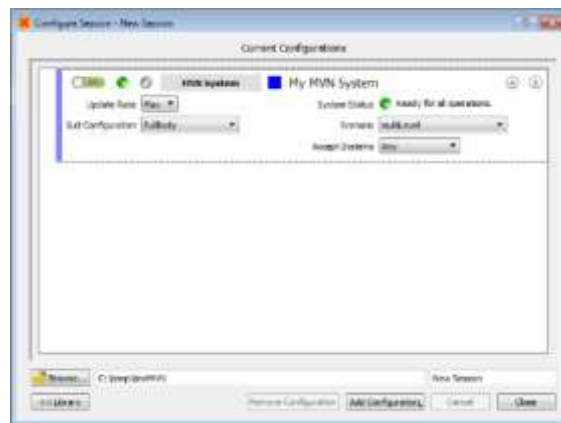

Figure 24: Configure a new session

Note that all details are default and ready for first time use. For quick start, wait for the status icon to turn green, click ‘close’ (or ‘apply’ when settings have changed). Now the live, uncalibrated character will appear on screen. Go to Section 8 for instructions to proceed.

For a more informed, step-wise approach, it is useful to read the following steps for guidance.

7.1.2 New Session, step-wise

7.1.2.1 Add Configuration

Using the ‘Add Configuration’, button a number of configurations can be selected from a drop down menu, including:

- MVN systems, see 7.2
- The Video Camera, see 7.3
- Define X-Axis, see 7.4



- Sync Station, see 7.5
- Configuration Group, see 7.6

7.2 Configure an MVN System

When the user has clicked “Add Configuration” and selected “MVN System” the following configuration window will appear. The image below shows the expanded and views and details how to modify the settings. Note that the Sync Settings dialogue is available only with an MVN BIOMECH license.

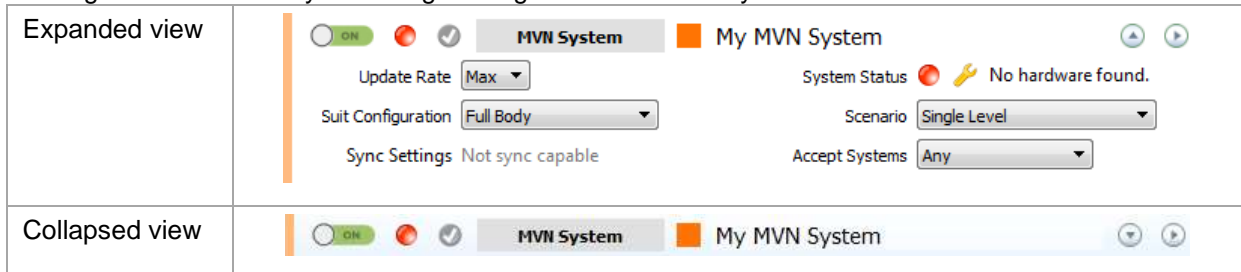

7.2.1 Enable/disable search for new system

As described above, click the button on the top left corner from OFF (red) to ON (green). While the default settings are enough to proceed with a single suit, additional changes can be made.

7.2.2 System Status

The system status appears in the top row as an icon, so that in both the expanded and collapsed views it is possible to identify the status of a given item. In accordance with traffic-light indicators, green indicates that everything is in order, while red indicates that there is a problem to be addressed. In the expanded view, the text accompanying the colored icon specifies the problem and clicking the spanner opens the hardware status window for detailed trouble shooting.

7.2.3 Apply Changes

Grey: no applied changes

Red: unapplied changes

Changes can be applied by clicking on the grey icon or by clicking on the ‘apply’ button which will also close the dialog.

7.2.4 Configured Item

This simply gives the name of the item being configured, e.g. an MVN System, Video Camera, Define X-Axis and Sync Station. This is read-only text.

7.2.5 Suit Color

Particularly useful when measuring multiple systems, it is possible to change the color of the suit, by clicking the colored square next to the configuration name. The system configured in the example session dialogue above is orange. It is replicated as read-only color on the left-hand bar, to facilitate easy identification, also in the collapsed view.

7.2.6 System Name

It is advised to change the name of the system from “My MVN System” to a more personalized name, for example the name or ID of the person wearing the system. (It can also be deleted if not needed.)



7.2.7 Expanding and Collapsing Views

On first use, one system is detected and the expanded view is enabled. It is possible (likely) that after a number of times using the system, or if many configured items are in the list this detail is no longer required. For this reason it is possible to still have an overview of the system status in a more compact view.

7.2.8 View Hardware Status

- For MVN Link this view is only needed for troubleshooting or relocating trackers. For MVN Awinda, it may be necessary to change the radio channel, which is possible in the hardware status window. See Section 7.8 for detailed information.

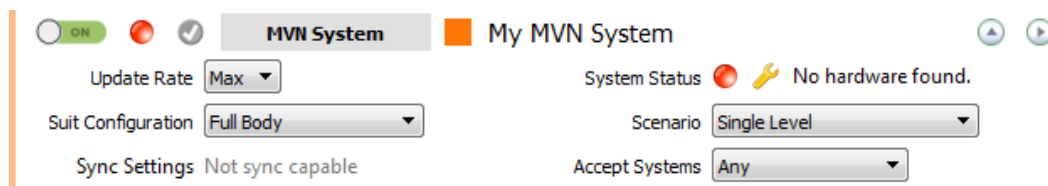

7.2.9 Update Rate

Default and maximum sample rate for MVN-link is 240Hz, this is normal for single-subject capture with PC all requirements met. When only one system is in use, it is common to use this update rate. With multi-person capture, or in situations with extremely adverse conditions for the wireless link, consider reducing the update rate to reduce the amount of data needed to be transmitted and processed.

The maximum update rate for MVN Awinda Full Body is 60Hz. This update rate ensures retransmissions of possible lost data packets can be sent to the system. For more information about update rates versus sample frequencies, please see Section 19.9.

7.2.10 System Status

For both MVN Link and MVN Awinda, this indicator represents the status of the system being connected. The color of the indicator will change from red to green when a system is successfully connected. For detailed information see Section 7.8.

7.2.11 Suit Configuration

When a connection between the PC and the live system is made, a detection phase takes place within MVN Studio to detect all necessary hardware. To ensure that MVN Studio searches for the correct hardware, ensure that the correct suit configuration is chosen. If for example full body is selected, when no hands are connected, this will result in an error when the suit is detected.



7.2.12 Scenario

Depending on the type of measurement you will carry out, select the type of scenario that will ensure the best results, and minimize post-processing. The scenarios available include:

Single Level	This scenario assumes that the subject will be walking on level terrain
Multi Level	This scenario assumes that the subject will be walking on terrain or varying height, e.g. climbing stairs.
Pelvis Fixed	This scenario assumes that the subject will remain in a seated position, e.g. in a car. This means that the pelvis will remain at a preset height. Small amount of motion of the pelvis is accepted.
Pelvis Fixed Tight	This scenario assumes that the subject will remain in a seated position, e.g. in a car. This means that the pelvis will remain at a preset height. No motion of the pelvis is accepted.
Soft Floor	This scenario is used if it can be assumed that the feet will slightly decrease in height, during the time between the feet contacting the ground and leaving it, e.g. grass, or soft carpet.

7.2.13 Accept Systems

From this drop-down menu, select the type of hardware connected to MVN Studio. This is set to “Any” as default, making it easy if only one system is connected. It is also possible to specify MVN Link or MVN Awinda.

7.2.14 Sync Settings



With MVN Awinda, the dialogue to configure the sync settings is in the MVN System configuration. To configure the Sync Station which is the method for synchronizing MVN BIOMECH Link with third party devices, the sync settings are configured via “Insert configuration” “Sync Station”.

It is worth noting that sync with MVN Awinda is tighter than with MVN Link due to the tight control of the Awinda Station over the MVN Awinda System.

Click the icon:  to configure the sync settings.

For detailed information regarding sync settings, refer to section 23.

7.3 Configuring the Video Camera

If a video camera is to be used, select “Video Camera” from the “Add Configuration” list. Note that before this can be configured, The MVN reference camera, must be plugged into the mains power supply and to the network connector of the pc or laptop in use. MVN Studio should automatically detect the camera (if not, use the command “Scan for cameras”). If using a MVN (BIOMECH) Link system, connect the camera Ethernet cable into the Access Point and connect the AP directly to the Computer via Ethernet.

7.3.1 Configuration

Changing the video configuration is effectively changing the frame rate.

MVN Studio supports VGA, video data will always be in color, with a resolution of 640 x 480.

To avoid flickering due to artificial lighting related to the mains frequency (50 Hz in Europe, 60 Hz in USA), select the appropriate frame rate (25 or 50 fps for Europe or 30 or 60 fps for USA).

Note that unless using a high performance computer with a fast HDD, it is advised that a lower frame rate is chosen (25 or 30 fps).

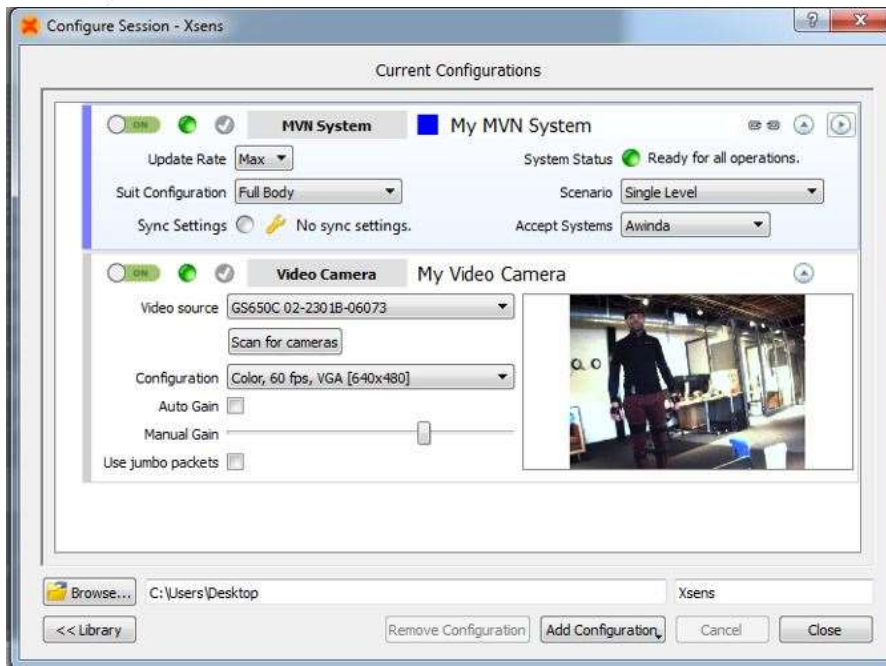
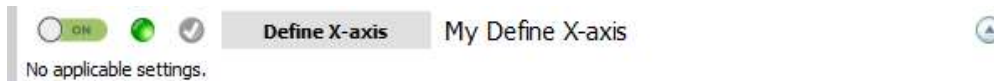

Figure 25: Example of camera configuration window

If no picture is displayed, if the image is jagged, or no camera is found, install the dedicated driver, found in C:\Program Files\Allied Vision Technologies. You may have to restart MVN Studio for the camera to be found after this is installed. If no video data is displayed, check or uncheck the Use jumbo packets option to resolve the issue. The camera needs to be connected to the dedicated ethernet port on the pc, whereas the internet connection can use the USB to Ethernet adapter.

You may select to check the Auto Gain box or manually adjust the gain of the video yourself in this window.

7.4 Define X-Axis





MVN Studio uses magnetic north as positive X-axis, inserting this configuration means that it is possible to define the X-axis, an additional calibration step will be needed, in which the direction the subject is facing defines the new X-axis. In a setup with multiple MVN systems, the first system in the list of the 'Setup pane' needs to perform the calibration.

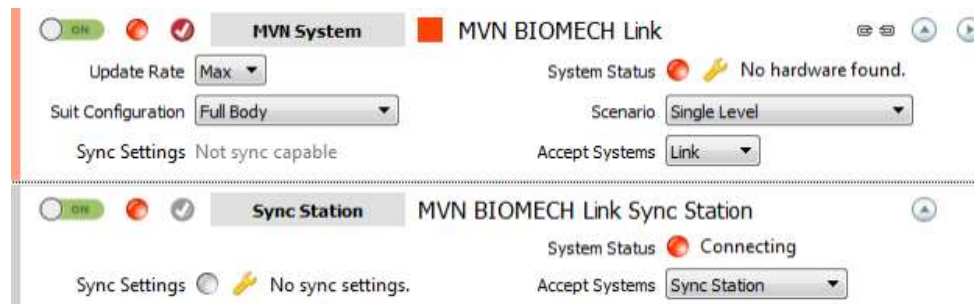

7.5 Configuring the Sync Station

The Sync Station is dedicated hardware for synchronizing between MVN BIOMECH Link and third party systems. The user will note that when MVN BIOMECH Link is selected, the text beside Sync Settings states “Not sync capable”. The Sync Station must be inserted for synchronization with MVN BIOMECH Link.



Click  to configure the sync settings. For details about each setting, refer to Section 23.

7.6 Configuration Group

It can be expected that there are multiple users of a given MVN system, or that certain users have a certain set up that is always in use. In this case, it is possible to group a set of configurations into group configuration. This can be done in a number of ways:

1. Once all configurations are in the list; select them, then right click and select “Group”.
2. Right click on the first MVN System and select ‘Group’. This configuration will then be collapsed into a Configuration Group labeled ‘New Group’. Click and drag remaining items into the group.

It is advised to rename the group from “My Configuration Group” to match the group contents. By toggling the Enable button from ‘Off’ to ‘On’ for the Configuration Group, all items in the Group will also be enabled.

7.7 Loading configurations using the Library Button

To save configurations (grouped or otherwise), open the Library pane by clicking on the icon “>>Library”, then click and drag the items into the Library.

To retrieve a saved configuration, click and drag the items (or group) from the library into the Current Configuration window.



7.8 Hardware Status

To view the Hardware Status, Select the  or  in the configuration window.

Hardware status shows a list of all trackers and masters detected by MVN Studio. The figures below show the hardware status interface and Table 3 details the meaning of the colored markers. This menu can be edited while the Configure Session window is also open, instructions for editing can be found below. When the Configure Session is not open, this interface is read-only.

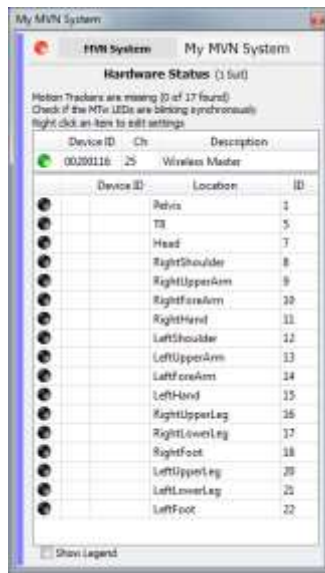

Figure 26 Hardware Status before a wireless connection has been established

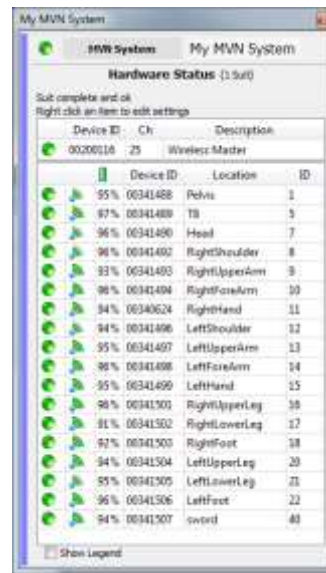









Figure 27 Hardware Status network connection is established and ready to measure

Table 3: Legend of colored markers in detected hardware screen

Icon	Legend message	Description
	Not detected	Motion tracker of a given segment is not detected
	Tracker Rejected	When a tracker is double click, indicating it is not needed, it is known as "rejected". Its icon becomes grey.
	Tracker Connected (MTw)	Motion tracker is connected to the master
	Master detected Network not locked	Wireless master is detected. Red icon has not been double clicked to secure the network.
	Connected (Master)	Green icon at the master indicates network is secured.
	MT unused	An extra motion tracker has been detected
	Duplicate	More than one motion tracker has been detected with the same location ID.



When all trackers have been detected, it may take some time (up to 30 seconds) to secure the network and for the 3D character to appear. Additionally, it may take several seconds for the battery status to display, please be patient to allow the information from each tracker to be transmitted to MVN Studio.

7.8.1 Relocating motion trackers

Each Xsens motion tracker has a unique location ID which relates them to the limb segment they should be placed on. If for some reason, a tracker has the wrong ID assigned to it, e.g. if an additional motion tracker is detected or a broken MT needs to be replaced with a spare, this can be done easily by reassigning the MT's ID to the desired position.

To assign a tracker to a different segment, drag and drop the ID to the Location, or vice versa. Alternatively, right click in the correct row and select "Update location to". To ensure that the changes are saved, go to >Tasks >Reinitialize suit(s).

Note that if two motion trackers are accidentally exchanged, for example on the hands or feet, do not use this function but reconnect the MT's to the appropriate side and wait for the hardware status to update.

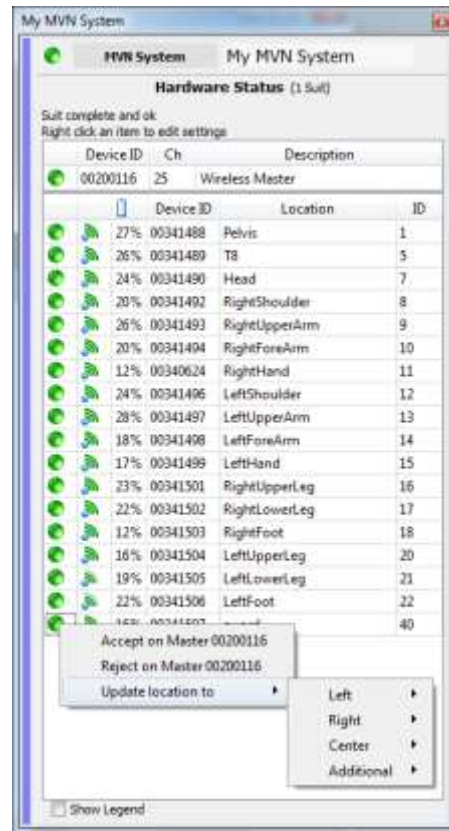

Figure 28 Relocating trackers

7.8.2 MVN Awinda: Changing Radio Channel



For MVN Awinda users, the Hardware Status is necessary in order to configure the network detection status of the system.

Figure 26 Shows a list of motion trackers expected to be found by the MVN Awinda system. The icons of these trackers are black indicating that they are expected but not yet detected. As the Awinda Station is searching for MTw's, the CONN LED of the Awinda Station, or the white LED of the Awinda USB dongle blinks rapidly. As each MTw connects, its LED will blink synchronously with that of the Awinda Station and its indicator will turn green in the Hardware Status window, see Figure 27.

When the trackers has been detected, the status of the remaining battery power (🔋) and the wireless strength (📶) of each tracker is available, see Figure 27 for an example.



7.8.3 MVN Awinda: Changing Radio Channel

	<p>In the Hardware Status window, either right click or double click the number under the letters “Ch”. A small menu appears providing the option to change radio channel, reject unused trackers or “forget” system.</p> <p>In general, when working in an environment known to have a lot of WiFi traffic, it is best to select channel 11, 15, 20 or 25. See Section 19.12.1 for background information.</p>
--	---

7.8.4 MVN Awinda: Reject Unused Trackers

	<p>Again, in the Hardware Status window, either right click or double click the number under the letters “Ch”.</p> <p>From the small menu it is possible to reject unused trackers. It is possible that the MTw is powered on, but not needed for a particular session. This is particularly useful for owners of multiple Awinda Systems where an MTw is detected by one Awinda Station but is needed at another. To remove detected trackers, either select the “reject unused trackers” or double click anywhere on the row the tracker appears in and select “Reject on Master *****”. If this was done accidentally of you want to accept a new tracker, simply double click again and select “Accept on Master *****”.</p>
--	--

7.8.5 MVN Awinda: Forget System

To explain the use of the command forget system it is first useful to understand how MVN Studio deals with connection. For single person capture, the information in the hardware status window tends to always be the same tracker/master information. However it may change depending on: different suit configurations and whether or not props are used. Additionally, some institutes may have multiple suits within radio contact of each other, each measuring one subject. For this latter usage and for the purpose of multi-person capture (multiple suits connecting to one MVN Studio instance), MVN Studio actively remembers which motion trackers have connected to which master (Awinda Station or Body Pack). The result is that when the user attempts to connect the trackers to the same master at a later time, MVN studio only allows the remembered trackers to connect. This ensures efficient connections for always using the same suit configuration and prevents unwanted connections between masters and trackers.

	<p>Again, in the Hardware Status window, either right click or double click the number under the letters “Ch”.</p> <p>If a user attempts to make a connection in an existing configuration between an Awinda Station and a tracker used for the first time the option “Forget System” should first be selected. After this command, all trackers (including previously rejected ones) can connect again.</p>
--	--

When all devices necessary for the suit configuration are detected, the 3D character will appear in the 3D viewport.

Ensure that the filename and directory are correct; then click apply to proceed. See section 8.

7.9 Props

In addition to the normal suit configuration, additional MT’s can be attached to items to be measured in a recording, for example a sword, or a walking stick. These items to be measured are called “Props” and the motion tracker (MTw or MTx) attached to them are “Prop Trackers”. A prop can be tracked by attaching a prop sensor to one of the free connectors on the hands.



The prop tracker must be configured in the menu Options >Configure Props. Here, the type of prop can be selected (crutch, sword, gun, diemaco, golf club, prop [this is simply a right-handed axis]), which can be assigned to a given suit and a given motion tracker ID.

Generally the motion tracker on the prop is detected automatically when clicking 'Apply' in the Prop Configuration window. If this does not occur, go to Tasks >Re-initialize suit(s). The prop mesh (the on-screen image of the prop sensor) can be connected to any defined point on a body segment. The prop can be rotated freely but will always follow the position of the selected point. By selecting the 'or' option, the prop tracker can be swapped between two segments, for example the right and left hand (see the example in Figure 29). MVN Studio will automatically detect the side on which the motion tracker is connected.

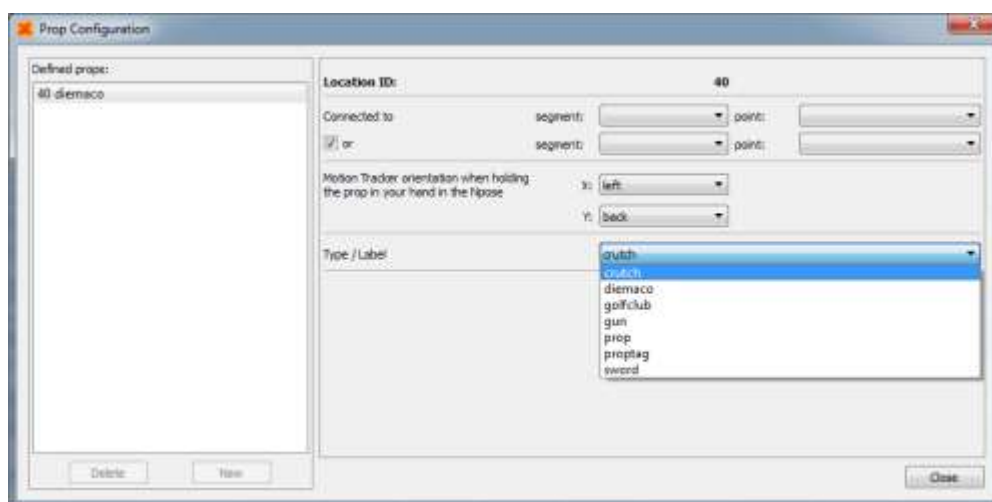

Figure 29: Prop configuration menu

The prop tracker should be mounted onto the prop such that two sides of the casing are parallel with the prop. For example, mount the prop tracker on the flat side of a sword with one axis aligned with the blade of the sword. Then, the orientation of the motion tracker can be set according to the natural orientation of the physical prop when holding it while in an N-pose.

For example, when holding a sword, the blade may point forwards. When holding a gun, the barrel will point downwards. Look at the X, Y arrows as indicated in the images below.



MTw



MTx

7.10 Navigator

When a new session has been created, suit-specific variables can be viewed in the navigator. This generally appears automatically on the left side of the window. If not, it can be found using View > Navigator. In the navigator, parameters of the suit can be seen, including the Suit ID and the color of the indicator above the head of the 3D character. While this is possible with only one system, it becomes essential when multiple systems are being recorded at once.

If recording of multiple suits has been chosen during the new recording session, MVN Studio will search for the selected number of systems. If more than one system is connected, the hardware status will have additional tabs to reflect this.



8 Setup

The setup workflow stage consists of three parts; input the subject's body dimensions, data fusion and sensor to segment calibration. The calibration procedures are only available once the MVN system is connected and the 3D Character has appeared in the view port.

When a file has been recorded this icon remains active to enable changes to body dimension inputs.

NOTE: It is not possible to save a calibration file, when a recorded file is open.

The following steps are described for single system calibration. If multi-person capture is enabled, each step should be repeated for each additional system.

8.1 Body Dimensions

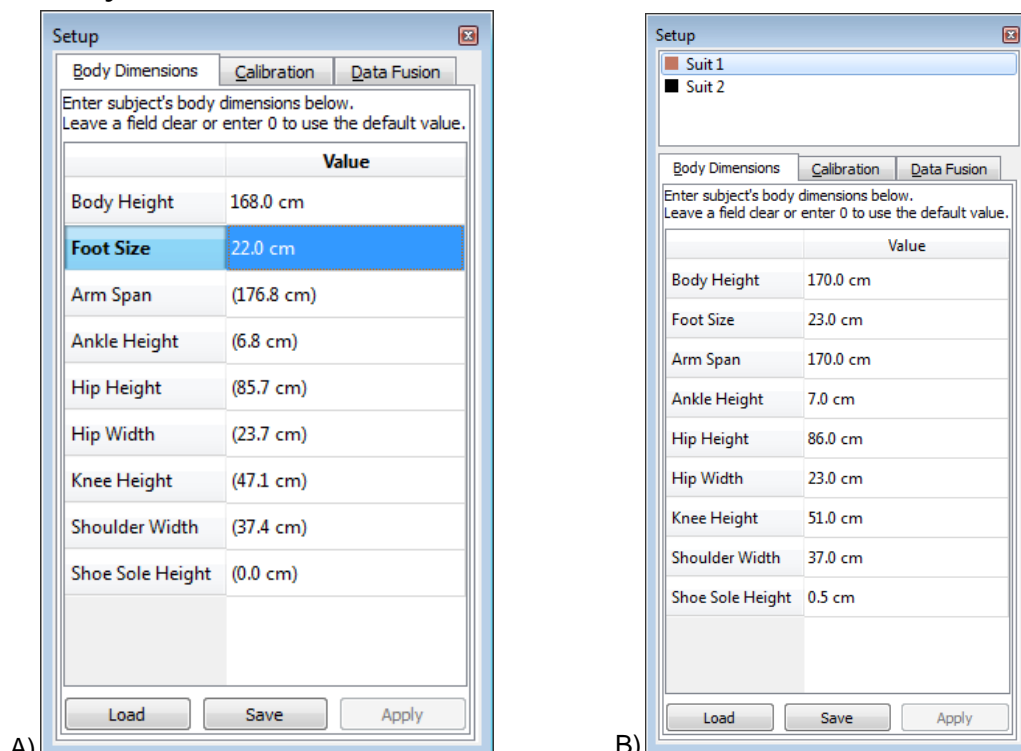

Figure 30: Input body Dimensions of test subject. A) Single subject capture B) Two subject capture

Figure 30 shows the interface for inputting the subject dimensions prior to a sensor to segment calibration. It is **necessary** to input body height and foot length (shoe length at the time of the measurement) in order for MVN Studio to calculate other segment lengths (based on an anthropometric model). **A recording cannot be performed if the user does not insert these values; instead the following error is generated:**⁵

⁵ Note that a recording can be performed without prior insertion of body dimension and without a calibration, if the feature "Allow uncalibrated recording" is enabled in the preferences menu.

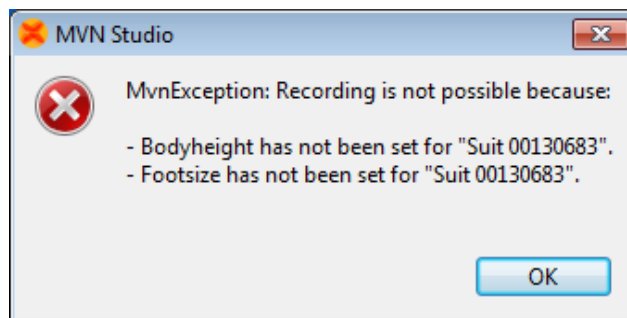

Figure 31: Error generated if recording attempted without subject height and foot length.

In addition to these basic measurements, other body segment dimensions can be adjusted for subject-specific anthropometry. The model-based values are presented between brackets, as Figure 30 shows, e.g. Knee Height (48.6). The scaling model is based on the height of the subject without shoes. The shoe sole height can be added as an offset to the feet. The height of the ankle joint will be adjusted internally and other segment dimensions, such as the leg length, will not change. If the subject and ankle height are measured with shoes on, all segment lengths will be scaled based on this length and the shoe sole thickness should not be entered. However, for improved accuracy, it is advised to measure height without shoes and insert the shoe height separately.

It is possible to provide values in either metric or imperial units. Metric units are active by default. To switch to imperial units go to: Options >Preferences >Interface >User interface >'Use imperial units (inches)'.

The specific body segment dimensions are presented in Table 4. They can be found by palpating the anatomical landmarks, presented in the figures on the next page and in the online video tutorials:



<https://tutorial.xsens.com/video/body-measurements>

Be careful! If you are not sure how to accurately measure the dimensions, do not change the default values; the calculated values are generally accurate enough.

To scale the model with these dimensions, click 'Apply'. The system will automatically update dimensions for which no user input is provided.

The subject body dimensions can be saved to your computer as an MVN Actor (.MVNA) file which then can be loaded the next time the same subject is used. After loading a subject file, it is still necessary to perform a segment calibration. It is also possible to modify body dimensions and reprocess the file with the new settings.



8.1.1 Offline Body Dimensions

In order to facilitate data collections, body dimensions can be measured and input into MVN Studio without connecting an MVN suit through the 'Offline Body Dimensions'. This feature allows users to save body dimensions as an MVNA file prior to instrumenting a subject. Later, when the system is connected, the file can be loaded again from the Body Dimensions panel.

To access the Offline Body Dimensions window, simply go to Options >Preferences >Miscellaneous >Offline Body Dimensions.

Table 4: Measurements needed for Subject Dimension Input

Dimension	Description
Body height	Ground to top of head when standing upright
Foot size	Top of shoe nose to end of the heel
Arm span	Top of right fingers to top of left fingers in T-pose
Hip height	Ground to most lateral bony prominence of greater trochanter
Knee height	Ground to lateral epicondyle on the femoral bone
Ankle height	Ground to distal tip of lateral malleolus
Hip width	Right to left anterior sup. iliac spine
Shoulder width	Right to left distal tip of acromion (acromial angle)
Shoe sole thickness	Average thickness of the sole of the used shoes. This value will add an offset to the ankle height.

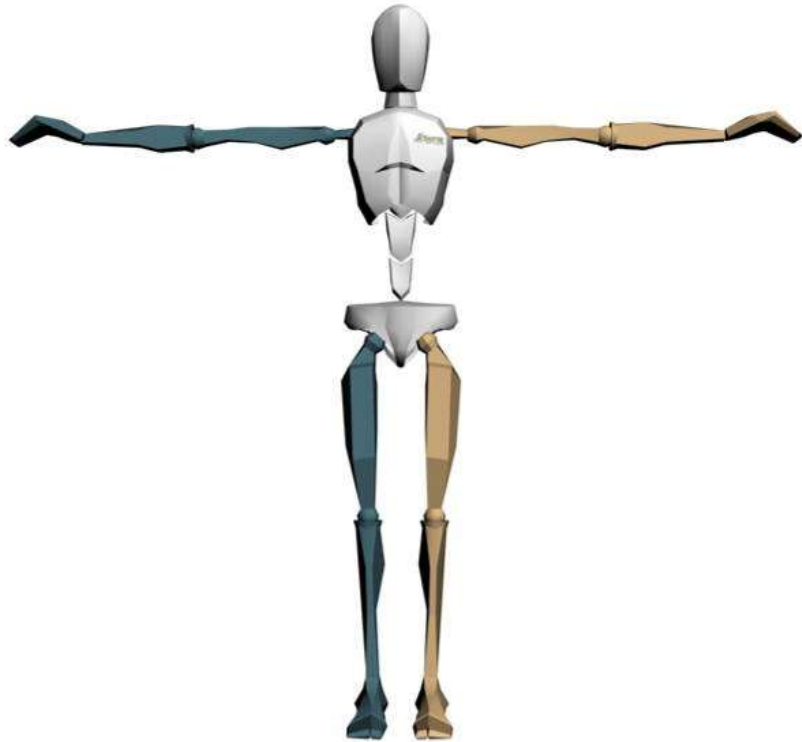

Figure 32: T-pose with body segment dimensions

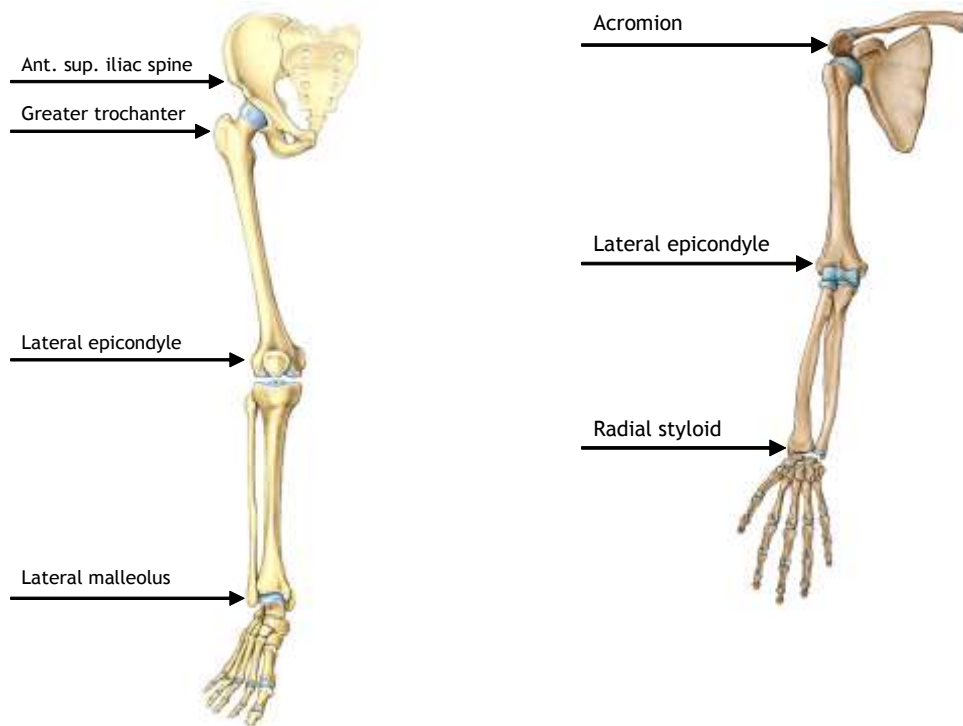

Figure 33: Anatomical landmarks on leg (left) and arm (right)



8.2 Calibration

Segment calibration is the step required to align the motion trackers to the segments of the subject.

Watch the video on the tutorial portal for instructions on how to perform the calibrations: <https://tutorial.xsens.com/video/setup-and-calibration-mvn-link>.

Creating a good calibration is of utmost importance in order to ensure accurate results. For this reason, the calibration procedure should be carried out in a magnetically-sound environment. The “Show Magnetic Disturbance” is fixed at “Always on” when the calibration tab is active.

It is advised to check the measuring area for magnetic disturbances. To do this, move around the measurement area. Areas which appear green, particularly on the feet and pelvis are good for the calibration step. If measurements are needed in areas that reveal red in the magnetic field disturbance, first calibrate in the “green” areas then move temporarily to the disturbed area. Do not remain there for longer than approximately 30 seconds.

8.2.1 Calibration steps

Please note that it is always recommended that a calibration is performed before beginning to record data using MVN Studio. However, it is possible to enable a measurement without calibration in the preferences menu (Options >Preferences >General >Recordings).

Another option in the preferences menu is “Expert calibration” in this menu. Expert calibration is intended for users who have been advised by specialists at Xsens to perform a hand-touch calibration in addition to their N or T pose. However it becomes possible to execute both N and T- Pose by enabling this. Carrying out both basic poses is strongly dissuaded. If both calibrations are carried out, a weighted average of both will be used. This is known to lead to inaccuracies in the results.

- Select a pose (N or T).
- A new image will appear in the 3D viewport which should be replicated by the subject.
- If the subject is alone, first select “Hands off calibration” and the amount of time needed to get into position. (See Section 8.2.5)
- Click “Calibrate”.
- Ensure that the subject is holding the pose.
- Click start.
- Under Messages for calibration: If the result is “good”, click “accept”. If “acceptable”, it is the user’s decision if they wish to improve this. If the result is “Poor” it is advised that the calibration is discarded and performed again following the instructions provided in the Messages area. If “Fail” results, the calibration must be repeated before proceeding. (See Section 8.2.6 for more information.)

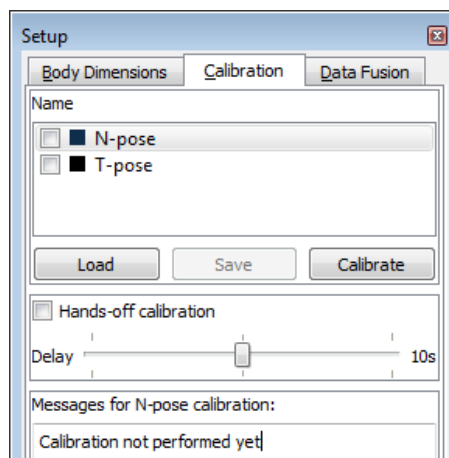

Figure 34: Segment calibration interface – new screenshot with no data fusion tab

Note that if multiple people will be measured simultaneously (multi-person capture), mark a place on the floor which does not show magnetic disturbances. This will be the origin of the session. Each person should stand on this spot **with the right heel** when performing the calibration poses.

The MVN system does not have an absolute positioning system. Therefore, the characters will show some drift over time in terms of absolute position in space with respect to the origin (defined at



calibration). For short recordings, the drift of the character is typically limited to a few cm. With multi-person capture, the characters can drift apart after a while. Usually this can be fixed in the animation package used for retargeting the motion data to a virtual character.

To reset the position of the characters in between recordings, select the character in the navigator, ask the subject to return to the marked position on the floor and select menu > Tasks > 'Move Character to Origin', or press 'Ctrl-0' (Ctrl+[Zero Key]).

8.2.2 N-Pose (Neutral pose)

The N-Pose calibration is a basic calibration. It can be performed as a stand-alone calibration or before the hand-touch. When performing the calibration, take care of the following:

- Stand upright on a horizontal surface
- Feet parallel, one foot width apart.
- Knees above feet.
- Hips above knees.
- Back straight.
- Shoulders above hips; do not pull the shoulders up.
- Arm straight alongside body (vertically), thumbs forwards. Check the correct attitude of the arms by flexing and extending the elbows. The forearms should move only in the vertical (sagittal) plane with the palms of the hands facing each other.
- Face forward.
- Do not move during the calibration procedure.



Figure 35: N-Pose

Following the calibration, if the legs of the 3D character are crossed, when the feet are together then the feet were too far apart during the calibration. Repeat the calibration procedure with the feet closer together for an improved result.

8.2.3 T-pose

The T-pose is the other basic calibration pose. This is recommended if the subject cannot hold the arms vertically near the body. When performing a calibration, take care of the following:

- Stand upright on a horizontal surface.
- Feet parallel, one foot width apart.
- Knees above feet.
- Hips above knees.
- Back straight.
- Shoulders above hips; do not pull the shoulders up.
- Arms extended horizontally, thumbs forwards. Check the correct attitude of the arms by flexing and extending the elbows. The forearms should move in the horizontal (transverse) plane.
- Face forward.
- Pay attention to symmetry, for example, keep the arms at an equal height.
- Do not overextend the elbow, since flexion/extension may be projected in other axes.
- The wrists, elbows and shoulders should all be on a single line.

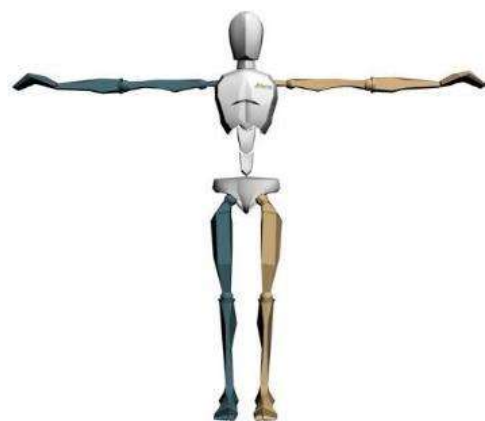

Figure 36: T-pose



8.2.4 Expert Calibration: Hand Touch

It is important for the operator to determine if the hand touch is required - in general it is not necessary.

Sometimes it is difficult to get very accurate hand data, even when the N or T pose has been carried out well. For this reason it is sometimes needed to carry out a Hand Touch calibration. Note that a good N-pose is necessary to obtain the best results.

When performing the calibration, take care of the following:

- Place the palms of the hands together.
- An example of the calibration movement is shown in the 3D view plane.
- Move the hands around slowly while keeping the hands together
- Keep elbows in the same position (10 seconds).
- Imitate the 3D character window or perform a different movement, e.g., making small circles in all directions.

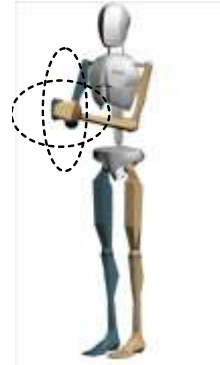

Figure 37: Hand touch calibration pose

8.2.5 Hands-off calibration

It is possible to perform a calibration without assistance. Click the 'Hands-off calibration' check box and select the delay time. This is the time needed between clicking 'Start' and getting into position. Continue the calibration by clicking the 'Calibrate' button. Following the preset time delay, the calibration recording will automatically begin.

8.2.6 Calibration quality

MVN Studio will perform several checks to determine the quality of the calibration signals. These checks include: a measure for standing still, the expected alignments of the MT's on the pelvis and hands, the homogeneity of the magnetic field, therefore the ability to measure safely in this environment.



There are four levels of calibration quality:

- good
- acceptable
- poor
- fail

Generally, a 'good' or 'acceptable' quality indication is sufficient. If the calibration result is not 'good', the reason is indicated in the text below. Read the advice provided to improve the result. If the result is "acceptable", consider repeating.

A 'poor' quality indicates that there is too much movement during the calibration or the magnetic field is disturbed. It is still possible to continue with recording, but it is better to repeat – taking into account the advice provided.



Figure 38: Example of result of calibration quality

Note that a 'good' or 'acceptable' quality indication does not necessarily mean that the actual calibration is accurate. MVN Studio can perform limited checks of the actual pose of the subject during the calibration due to a natural variation in body physique and locations of the motion trackers on the body. Therefore, always pay attention to the pose of the subject since it will influence the quality of the recording.

Calibration data can be saved. This is useful if MVN Studio closes/must be closed suddenly. When rebooting, data can be reloaded, without having to re-calibrate. To reload a calibration (including body dimensions), click 'Load'.



9 Preview and Recording

9.1 Preview

During the Preview and Recording stage of the workflow, the viewport is active.



There are a number of viewing possibilities, the 3D character in the 3D viewport and orthogonal views. Select the number of windows to view at one time. Figure 39 is an example of a four window view showing the 3D view and three different orthogonal views. To select which type to view, Right Click and select from the drop down menu, as indicated in the figure (or use the shortcut keys). The view changes only in the window where the cursor is pointing. In the 3D viewport, use the mouse to zoom (using scroll wheel) and pan (using middle mouse button) around the character. It can be viewed from any angle (change view using left mouse button) and distance.

With MVN Studio BIOMECH it is also possible to have the synchronized (live) video data. If video is enabled it automatically uses a window. Note: there is a difference between the virtual camera and the physical MVN Ethernet Camera. The camera views describe the possible viewing angles of the 3D character. The only preferences for the MVN Ethernet camera are in Options >Video Camera Settings.

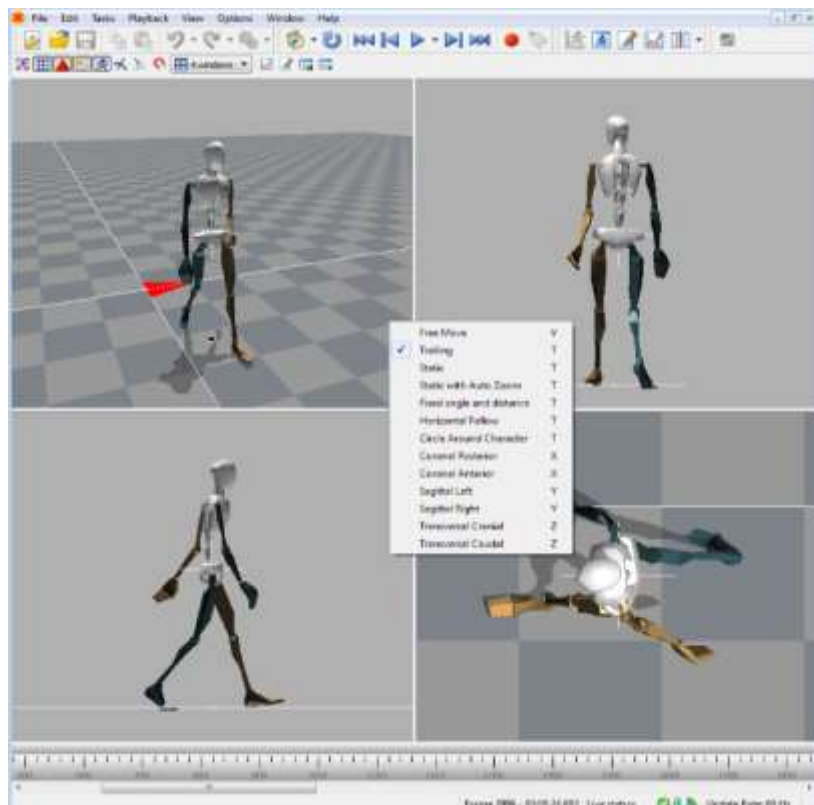















Figure 39: Example of 4 window view on the 3D view port. Top left is the 3D view. Bottom left is sagittal right. Bottom right is transversal cranial. Top right is coronal posterior.



9.1.1 Viewport Icons

The icons above the viewport can be selected to show and hide various parameters, as detailed below.

Icon	Task
	Focus on Selected Segments (short-key 'F') Note: short-key 'C' always centers on the pelvis
	Show/hide floor
	Show/hide origin
	Show/hide shadows
	Show/hide center of mass
	Show/hide biomechanical model
	Show/hide motion path (available during playback)
	Show/hide magnetic disturbances
	Amount and layout of viewports
	Show/hide graphs
	Enable/disable contact editing in current view
	Save Layout
	Restore Layout



9.1.2 Views

Right click on the screen (or use the shortcut key) to choose one of the following camera viewpoints:

Menu command (+shortcut)	Action
Free move (V)	The camera is still. The character may go out of view of the screen.
Trailing (T)	The character is always in view. The pitch of the camera is fixed. The distance of the camera to the character is fixed. The height of the camera follows the height of the pelvis. The camera heading is determined from the previous and new character position.
Static (T)	The position of the camera is fixed. The camera always looks at the character.
Static with Auto Zoom (T)	Similar principle to “Static” with the addition that the zoom is automatically adjusted to ensure that the character remains the same size
Fixed angle and distance (T)	The global heading and pitch of the camera are fixed. The height of the camera follows the height of the pelvis.
Horizontal Follow (T)	Similar to “Trailing”, but the height and angle of the camera is now adjusted to prevent the image from varying with change in pelvis height
Circle Around Character (T)	Virtual camera will slowly circle around the centered character
Coronal posterior (X)	Show the back of the character.
Coronal anterior (X)	Show the front of the character
Sagittal right (Y)	Show the right side of the MVN character in the sagittal plane
Sagittal left (Y)	Show the left side of the MVN character in the sagittal plane
Transversal cranial (Z)	Show the top of the MVN character
Transversal caudal (Z)	Show the bottom of the MVN character

The camera angle of the orthogonal views is by default defined by the movement of the pelvis. The height of the camera is also based on the pelvis; when the character is jumping the character stays within the view while the floor appears to move. This also has implications in the sagittal view; the subject may bend, while this appears as though the feet slide forward. The data is still correct (as seen in the 3D view).

9.1.3 Overcoming distortions

Information used to provide the accurate orientations are based on sensor fusion and comes together in what MVN calls a Fusion Engine. The Xsens Fusion Engine (XFE) uses data collected not only instantaneously but also built up from the history of the session. If the subject wearing the system remains in an environment that can be detrimental to the data (e.g. in a prolonged magnetically disturbing area) it may be necessary to clear the history; this will be apparent by the appearance of the character, for example segments may be unnaturally twisted with respect to others. Depending on the severity of the effect of the distortion on the character, two different types of reset are possible as detailed below.



It is important to note that when a reset is carried out, the subject should stand still in a magnetically clean environment. Depending on the rest, some time is needed to build up good history again.

Character Reset (menu > Tasks > Character Reset, or Ctrl+Alt+F): This command partially resets the filters, but keeps valuable information that was stored; the result is that the character will remain in its horizontal position, and a shorter stabilization period is required (up to 30 s).

Full Reset (menu > Tasks > Full Reset, no shortcut key): This command will completely clear the filters. This means that all previous knowledge that the system built up will be lost. The character will return to the origin and a stabilization period is required. This means that the subject should walk around slowly for about 30 seconds to a minute.

9.1.4 Real-time graphs

With an MVN BIOMECH license it is possible to view graphical representation of data even in real-time and during recording.

To do this, click the graph icon, and as with offline graphs, click and drag items from the Navigator.

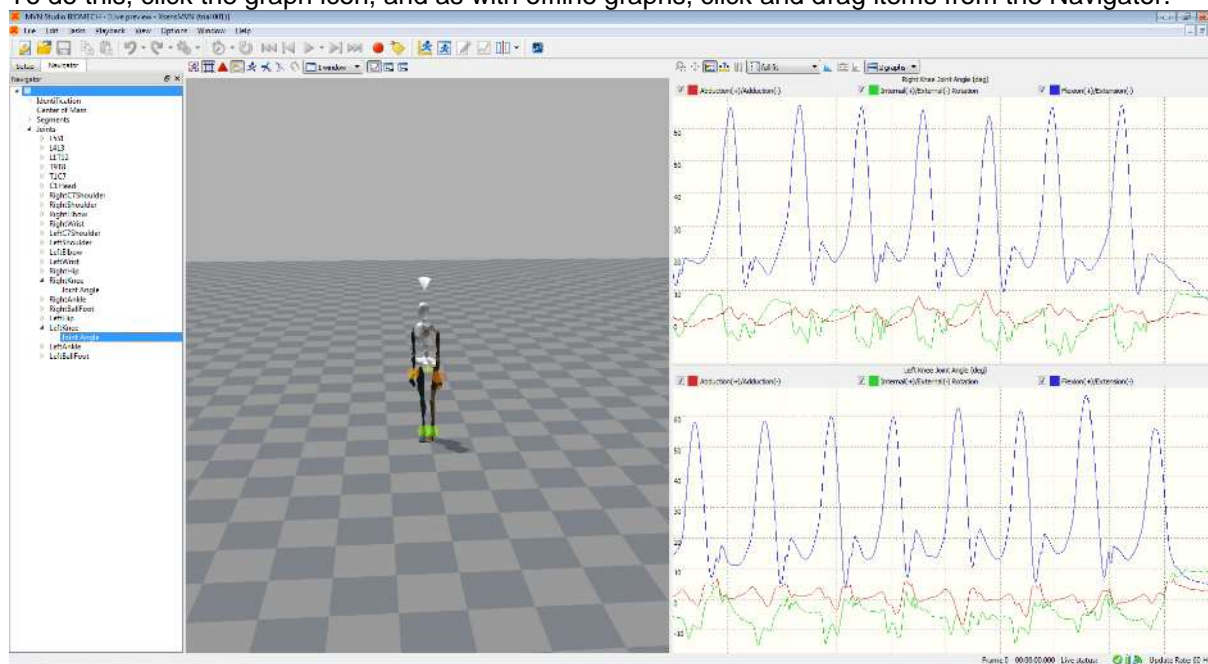

Figure 40: Real-time graphs

Figure 40 is a screenshot of MVN Studio with real-time graphs present. The key difference with this and the offline graphs is the lack of time bar.

The real-time graphs have the same functionality as offline, for more information on graphs, see Section 11.1.

Note that it is possible to zoom on the vertical axis. First ensure that “no auto-scaling is selected from the drop down menu, and then select the magnifying glass icon to zoom. However given that it is not possible to select a time window over which to observe the real-time graphical data, the recommended setting during real-time preview is “Expand to fit”, or “Full Fit”.



9.1.5 Save and Restore Layout

To the right of the graph icon are two icons indicating the possibility to save and restore layouts of the interface.

To save a layout, use the icon directly to the right of the graph icon, the layout currently in view will be saved. Give the layout a name, in the drop down menu that appears.

To use a saved layout, click the rightmost icon “Restore Layout” and select the name from the drop down menu that appears.

It is possible to delete a given layout by selecting it and clicking the delete button on the keyboard.

9.2 Recording

To record, save and export data, first make a new session (as described above) and perform a calibration.



Record button prior to clicking



Record button during recording⁶

Press the red record button to start a trial recording. Press the same button to stop recording. The short key for starting and stopping recording is ‘Ctrl+R’. All recorded and saved files will have the name of the session, appended with a trial number (e.g. session = ‘running_take’ will result in trial recordings ‘running_take-001.mvn’, ‘running_take-002.mvn’ etc.). When a recording has been made, the recorded file automatically opens. This can be disabled in Options >Preferences >General >Recordings >Automatically open MVN file after record ends.

9.2.1 Note for recording for MVN Awinda Users



When a recording is initialized in MVN Studio for MVN Awinda, the “Data” LED of the Awinda Station becomes red, to indicate recording is in progress. Note that if data packets have been missed, retransmission slots ensure that the Awinda Station can recall these and they can be retransmitted during recording (retransmissions are activated only during recording).

When recording is stopped, the “Data” LED may become temporarily orange, and the record button in MVN Studio will temporarily appear as if the recording is paused, the missed data packs are being flushed.

Note: This implies further that if the character does appear incorrect at another time, it is advised to carry out a reset (as described in Section 9.1.3) to correct this.

When opening a recorded file with flushed data it will automatically start reprocessing. This will ensure that the file contains all data, including retransmitted data from during the recording and data that was flushed from the buffer of the MTw at the end of the recording. For this reason, the recorded data is often of better quality than the real-time preview.

⁶ With MVN Awinda this button will continue even for a few seconds after recording is stopped, at this time, any samples missed during real-time recording are being flushed to the PC.



9.3 Add comments after recording

Adding comments after a recording has finished can be very useful in a later stage when you are opening the recordings. The popup dialog to add comments after a recording can be enabled or disabled (menu > Preferences > Interface > User Interface Show popup dialog for file comments after recording).

To view the comments from the open file dialog in MVN Studio or Windows Explorer, you will have to add the 'comments' column. Right click on the column header and click on 'more', now you can check the 'comments' column.

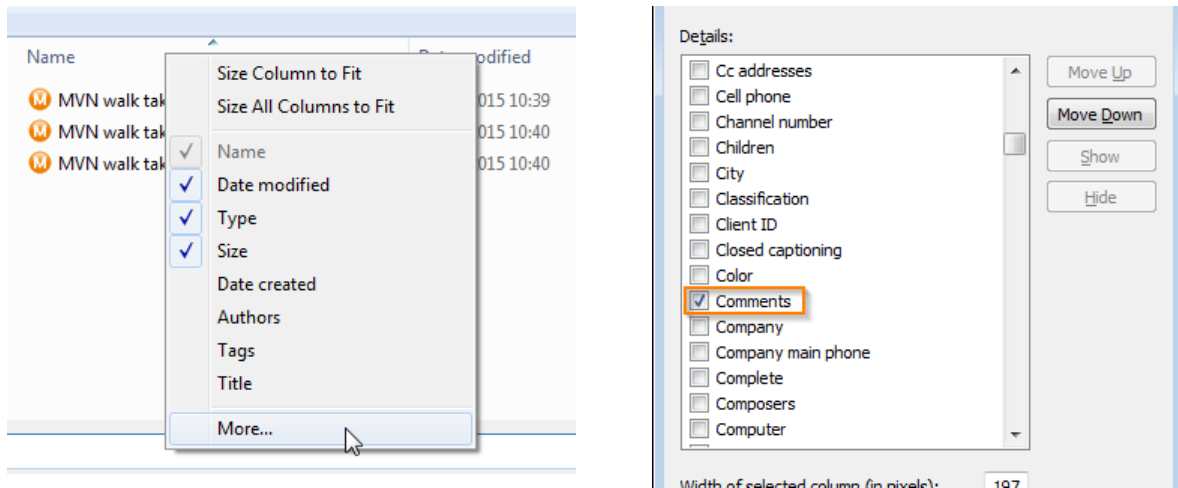

Now when you are looking for that recording that was 'perfect' you will be able to easily find it from either the open file dialog in MVN Studio or Window Explorer. When the comment contains a lot of text and is not fully visible you can hover over the text and a tooltip will display the complete text.

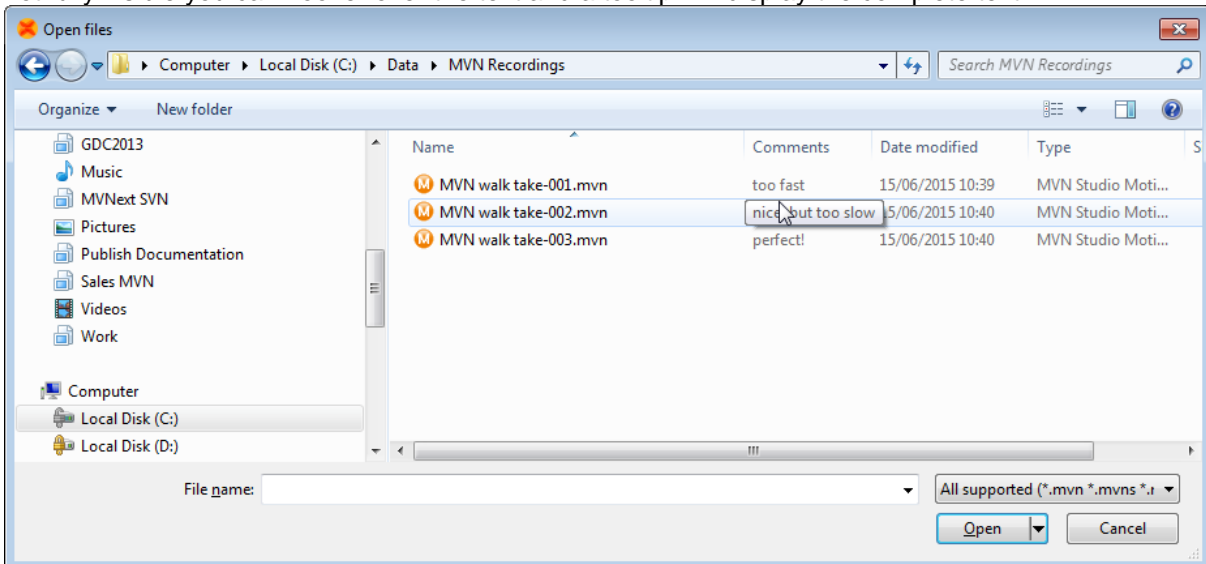

The comments in recordings can be edited in MVN Studio from the Comments pane (menu > View > Comments).

9.4 Recovery of MVN file after system crash

If MVN Studio was shut-down as a result of a system crash, the MVN file will not be properly closed and not useable. To correct this, when you try to load the corrupted MVN file in MVN Studio it will look for a



recovery file (MVR) that can be used to recover the data captured. A message will ask if you want to use a recovery file. This file has the same name and location as the corresponding MVN file but with a "MVR" extension. The file is used by MVN Studio to recover the corrupted MVN file.

9.5 Markers

During or after recording, markers can be added to the timeline to indicate events. During recording, add a marker by clicking the Add Marker icon or by using the '+' key or 'space bar'.



Add Marker

In the playback window, a marker can be added and/or edited by double-clicking the timeline at a specific frame or by using the '+' key. To add a marker directly, in the playback mode, double click on a time frame, to obtain the "Set Marker" menu shown in Figure 41. Alternatively, right click above the time frame, select "Add marker" and the same "Set Marker" menu will appear. Change the name of the marker in this menu to identify the marked event.

When the marker is set, it will become yellow. Markers can be deleted by pressing the delete button after selecting the marker, or selecting delete marker when right-clicking above the time line.

Markers are saved as default to MVNX file. See Section 12.5.

To jump between markers, either go to Playback > Jump to next/ previous marker, or use the quick keys 'PgUp' for previous and 'PgDown' for next.

Note that when multi-person capture is used, the markers are saved in each MVN file. When the MVNS file is opened, it includes these MVN files. This means that there can be a discrepancy when two different sample rates are used eg if MVN Link and MVN Awinda are used. For this reason MVNS file may appear to contain multiple markers, since they have been allocated slightly different times. Each MVN file itself will still only contain one marker.

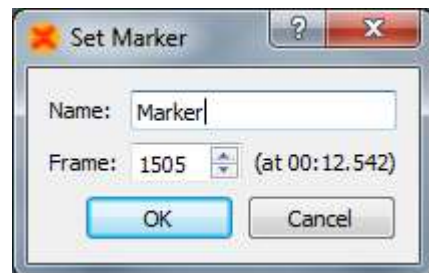

Figure 41: Set Marker Menu



9.6 Network Streamer

The network streamer sends the poses of the active window (playback or real-time), both UDP and TCP are supported by the network streamer. The UDP Protocol is unidirectional, and contrary to TCP (Transmission Control Protocol, RFC 793) it is stateless and does not require the receiver to answer incoming packets. This allows greater speed.

You can use a network monitor on another or same PC to receive this stream, or write your own receiver in another application.

Change network streaming settings in Options > Preferences > Miscellaneous > Network Streamer.

To enable streaming, activate the 'Enable network streaming' checkbox. The receiving network address can be entered in 'Destination addresses'. Use 'localhost' to send/receive on the same computer. UDP is the default protocol. To stream using TCP, it is important to specify this in the destination address, for example: `tcp://127.0.0.1:9763` or `tcp://localhost:9763`.

It is possible to stream to multiple destination addresses.

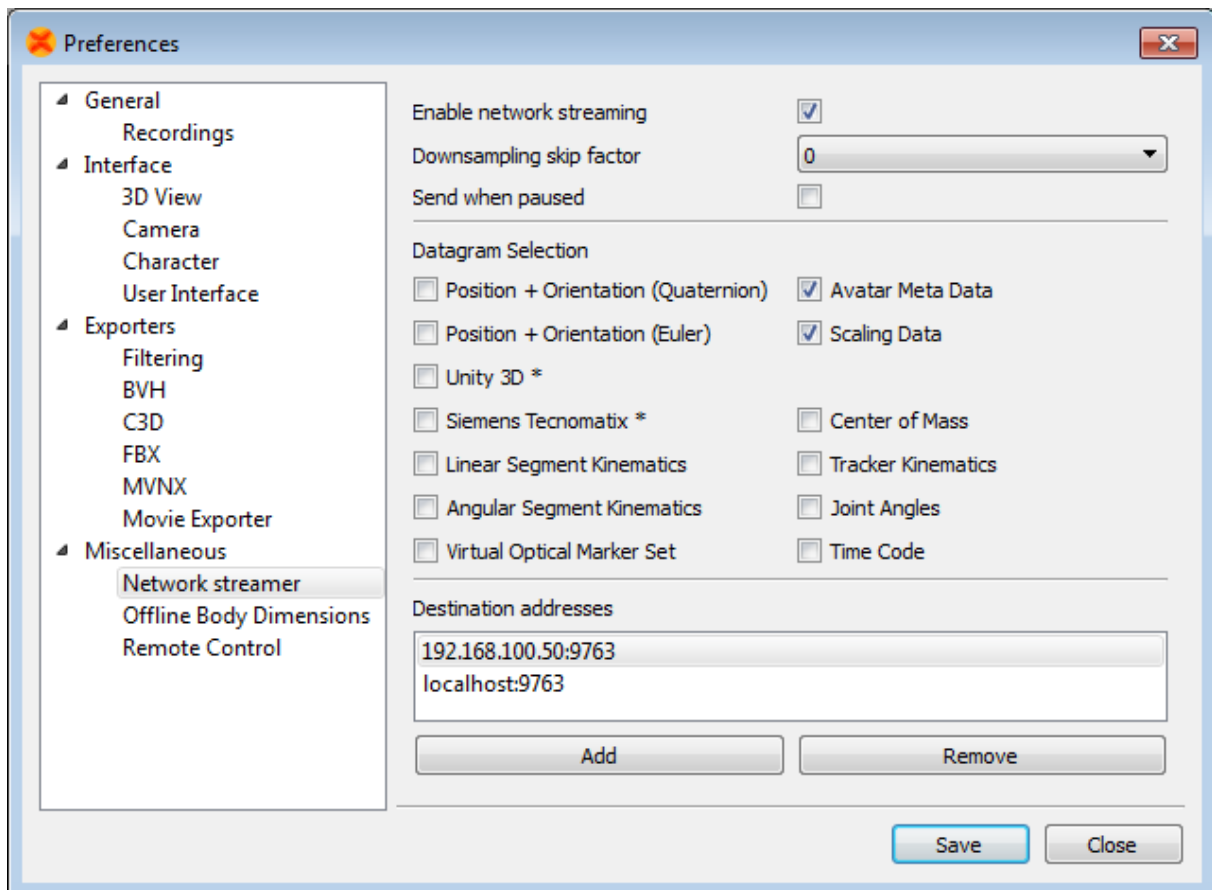

Figure 42: Network streaming preferences



Figure 42 above shows the Network Streaming preferences. The table below summarizes the functionality of each selection. Please refer to the Real-Time Network Streaming Protocol Specification for further details.

Datagram	Description
Position + Orientation (Quaternion)	Positions and orientation of each body segment, orientations in quaternion format, position units are in meters. This is the most accurate and preferred format for new application development. Use this to stream from one MVN Studio to another. Select the 'Scaling Data' for proper visualization of the character mesh.
Position + Orientation (Euler)	Position and orientation of each body segment. Orientations are Euler and position data is in meters. This is the format needed to send data to the MVN MotionBuilder Live plug-in. See the MVN MotionBuilder plug-in user manual for further details.
Avatar Meta Data	Particularly useful when streaming data during multi-person capture, when selected, this protocol streams information inserted about the character including the character as inserted in the Navigator as well as the ID of the Body Pack or Awinda Station. This feature is supported by MVN Studio as a network monitor.
Avatar Scaling data	This packet contains scaling information about the character, including the null pose definition and point definitions to scale a mesh.
Unity 3D	This setting should be selected in the network streamer for users of the Unity plugin. See the Unity plugin user manual for more details.
Siemens Tecnomatix	For MVN BIOMECH customers, it is possible to stream data in real-time to Siemens PLM software using this selection. See separate user manual for set up.
Linear Segment Kinematics	Absolute segment position, linear velocity and linear acceleration.
Angular Segment Kinematics	Absolute segment orientation, angular velocity and angular acceleration.
Virtual Optical Marker Set	This protocol streams a set of virtual optical markers. This is the virtual marker set for the 1.0 Motion Builder plug-in. This data is not supported for playback in MVN Studio.
Center of Mass	Absolute 3D position of the center of mass.
Tracker Kinematics	Absolute 3D tracker orientation (quaternions) and free acceleration. Local acceleration, angular velocity and magnetic field of the sensor components. This feature is not supported by MVN Studio as a network monitor.
Joint Angles	Data is contains point ID of the parent and child segment orientation and the joint angle in X,Y,Z.
Time Code	MVN Studio contains a clock which starts running at the start of a recording. The clock measures the elapsed time in milliseconds. When data is sampled, the current value of the clock is also sampled and stored in the datagram(s) as a 32-bit unsigned integer value representing a time code. When this option is selected a string of this Time Code is streamed (HH:MM:SS.mmm).



9.7 Network Monitor

MVN Studio also implements a Network Monitor that can receive the MVN network stream of motion data. Note that this is mean only to monitor a network stream and no further functionality is provided than viewing (i.e. no saving, recording, editing etc).

To open a network monitor in MVN Studio, go to File >Open Network Monitor or press "Ctrl+M", to obtain the menu shown in Figure 43.

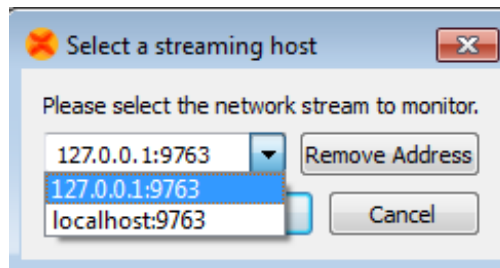

Figure 43: Select streaming host

Here, enter the IP address of the sending computer or use 'localhost' if sending and receiving on the same PC.



10 Playback and editing

When a file has been recorded, various new elements become possible, including playback of the recorded file; depending on whether or not the video was used, this will also involve synchronized video data. Furthermore, although intended for the analysis workflow stage only, graphs are available during the Playback and Editing workflow stage to help in some post-processing tasks. Graphs are described in detail in Section 11.1.

MVN files created with previous versions of MVN Studio can be played back in MVN Studio 3.0, reprocessing may be necessary to get a good performance.



Playback and editing

10.1 Playback

Playback becomes possible with a recorded trial. To play and edit recorded files, open an MVN, MVNS or MVNX file. The Playback Toolbar contains familiar playback options.

If multiple MVN, MVNS, or MVNX files are open, all files can be controlled at the same time using Global Playback options. When analyzing similar recordings, to make all files jump to the same frame, simply use the quick key 'Shift + Down'.

Icon	Task	Short Key	Global Playback Short Key
	Playback speed		
	Loop recorded data	R (toggle)	Shift + R
	Go to start	Home	Shift + Home
	Previous frame	Cursor left	Shift + Cursor left
	Play / Pause	Space bar	Shift + Space bar
	Play selection	Ctrl + Space bar	
	Next frame	Cursor right	Shift + Cursor right
	Go to end	End	Shift + End

10.2 Synchronization with video

In MVN Studio Pro, MVN data with synchronized video is available. The accuracy of the software synchronization depends heavily on the LAN connection to the camera and the wireless link quality to the MVN system. In general, the time offset between the MVN frame and the video frame is negligible, or less than 1-2 video frames.



However, if there is a larger offset between the MVN and video data, time-synchronization can be manually corrected using the sliding bar under the video. Drag the bar or use the numbers or the arrows to change the offset [ms]. The offset is applied to the whole file. Any clock skew between the camera and the MVN system is automatically estimated and corrected.

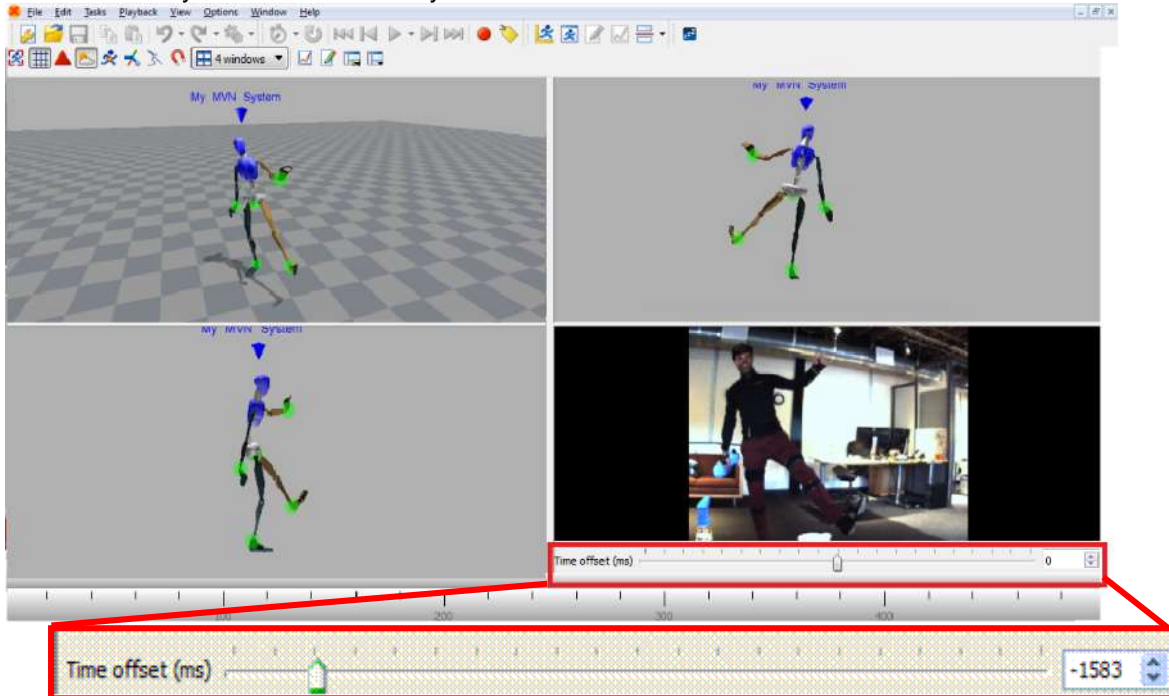

Figure 44: Video synchronization sliding bar

10.3 Contact point editing

The MVN Fusion Engine uses external contacts of the body with its surroundings to minimize position drift of the computed body model with respect to the Origin (defined by starting point). A number of points on the anatomical model have been defined that are likely to make contact with the external world. An overview of these potential contact points is given in Table 5. The detection of external contacts is based on measured kinematics of relevant body parts. In some cases, e.g., when a recording is made on different floor levels (e.g. stair climbing), it can be desirable to overrule the automatically detected contact points. Note that with MVN files recorded with earlier versions of MVN Studio, it is possible that not all points will be available. Examples of contact point editing steps are given in Section 20.

During Playback and Editing, four default bars appear above the timeline, indicating presence of contact points, advanced (floor level), position, and clipping edits (Figure 45). If there is a contact, the contact will be shown in the viewport with a large blue sphere. When hovering above the 'other contacts' bar a tool tip pops up indicating which contact point is active.

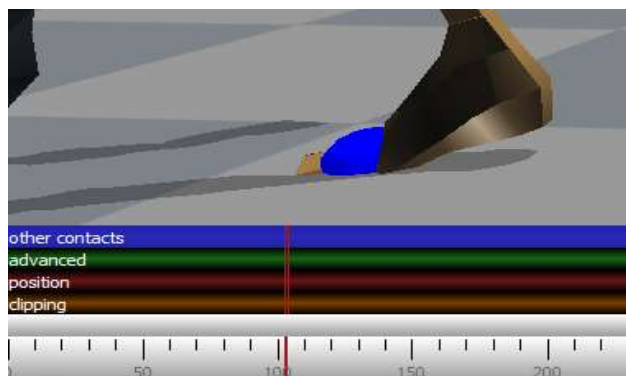

Figure 45: Contact point

Table 5: Potential contact points in MVN Studio

Contact point	Description
HeelFoot	Heel of the foot
FirstMetatarsal	Inside ball of foot
FifthMetatarsal	Outside ball of foot
PivotFoot	Center ball of foot
TibialTub	Bony elevation on upper part of the shinbone (tibia)
GreaterTrochanter	Eminence on the upper part of the femur
IschialTub	Buttock (left and right)
Sacrum	Base of the Spinal Column
Central Buttock	Buttock
PX	Bottom of sternum
T4SpinalProcess	Vertebra between shoulders
Acromion	Shoulder
Olecranon	Elbow
BallOfHand	Ball of hand
TopOfHead	Top of head

When clicking on a body segment with the left mouse button, the selected mesh will light up in red. The selected body segment shows spheres with external points of that segment. The time bar will zoom in and expand to show the detected contact points of the selected segment per frame. The colors of the spheres correspond with the coloring and labeling in the contact bar. For example, on the foot, there are four possible contact points: the heel (blue), first metatarsal (green), fifth metatarsal (red) and the pivot point on the ball of the foot (pink).

When an external point is defined as a contact, the related sphere will enlarge for the currently displayed frame. Clicking on a second segment will show the contacts of both selected segments.



To scrub, drag the time line scroll bar (↔) to the left or right. Step through the time frames using the left and right cursor or keep it pressed to move very slowly through the file, frame by frame.

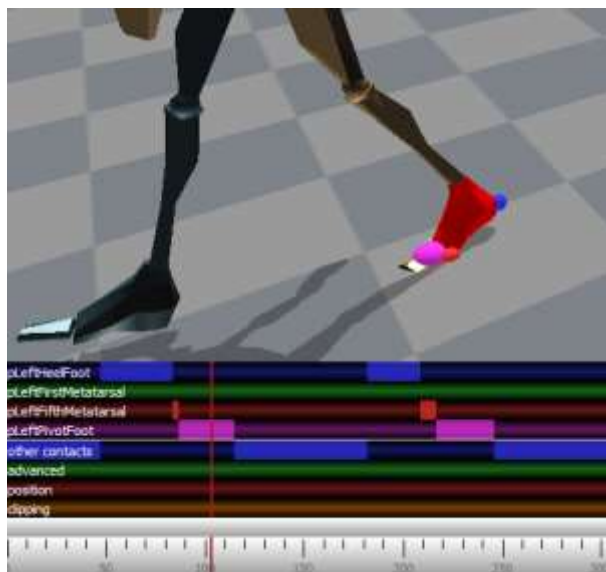

Figure 46: Contact points on the 3D viewport and the contact editing menu

10.3.1 Selection of samples

The left mouse button (and drag) will set a contact for the selected contact point. The color of the user-defined contact point will be slightly darker than the color of the original detected contact point. Only one contact point can be selected per segment. To select contact points for multiple segments, hold the shift key during selection with the left mouse button.

Note: The first contact editing action will take more time than the succeeding actions due to the caching mechanism.

The right mouse button (and drag) will show the contact point editing options for the selected frames. In the next section, these options will be explained.

To ensure that the changes are applied, click reprocess – see Section 10.3.2.7.

Undo ('Ctrl + Z') and redo ('Ctrl + Y') the performed contact point editing actions. Saving the file commits the changes and they can no longer be undone.

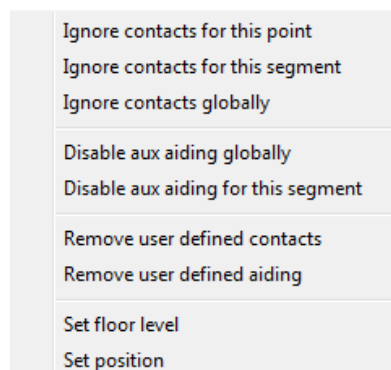

Figure 47: Right click menu in contact editing



10.3.2 Contact point editing options

10.3.2.1 Remove user-defined

Revert to the original recording for the selected samples. Remove user-defined aiding refers to the positions and floor levels set, as remove user-defined contacts refers to the contact points of the segments. Reprocess to apply changes (see Section 10.3.2.7).

10.3.2.2 Ignore contacts globally

Removes all detected contacts for all segments.

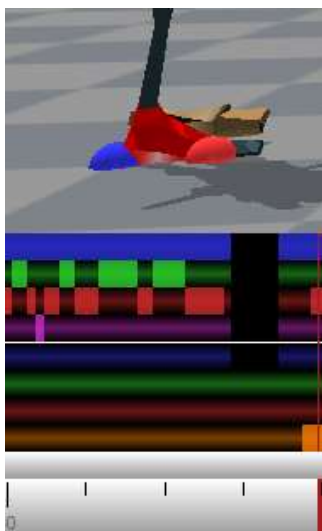

Figure 48: Example of ignore contact globally

10.3.2.3 Ignore contacts for this segment

The selected segment will not make contact for the selected samples. The MVN Fusion Engine will mark the most likely point of another segment as a contact.

10.3.2.4 Disable aux aiding

10.3.2.5 Set position

Sets the position and its uncertainty for the selected contact point. Optionally, only the height of a point can be set. Set positions can be found in the set position bar.

With the position aiding interface, it is possible to set a contact point at a desired coordinate (X, Y and Z). This can be useful in situations which are not supported by one of the user scenarios (e.g. walking stairs). Examples: (1) the starting position of a recording can be set to zero, (2) when the subject is hanging on a bar, the position of the hands can be fixed at a given height, (3) when a subject steps onto an object, the height of the contact can be 'frozen' to the height of the object, (4) when a subject jumps down from an object, the position of the foot can be set to the height of the object before jumping. Note that some situations, such as walking on an elevated surface can also be accomplished by setting the floor height.

In the contact bar, right-click the desired time frame(s) and select the option 'set position'. In the dialog, the X, Y and Z positions of the selected segment point of the current time frame are given.



Note: in MVN Studio, height is indicated by 'Z'.

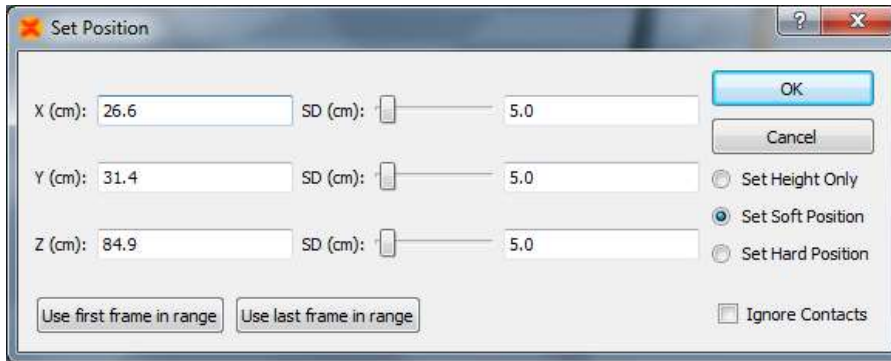

Figure 49: Set position menu during contact point editing

The SD slider sets the standard deviation, which is an indication of how much the aiding point can be trusted in combination with the computed position of the MVN Fusion Engine. This option can also be used creatively for example to create a “soft” landing on a mattress. With the ‘Force no contacts’ options, no other contacts will be detected during the selected frames. The contact bar will show a dot in the center of the edited frame and mark all other contact points dark. The ‘Absolute’ option completely overrules the computed position of the MVN Fusion Engine. The contact bar will show a ‘P’ at the selected frame. After editing the co-ordinates, click the reprocess button.

Always work chronologically when setting positions of contact points, since an edited position at frame k will influence the position at frame $k+1$ and further.

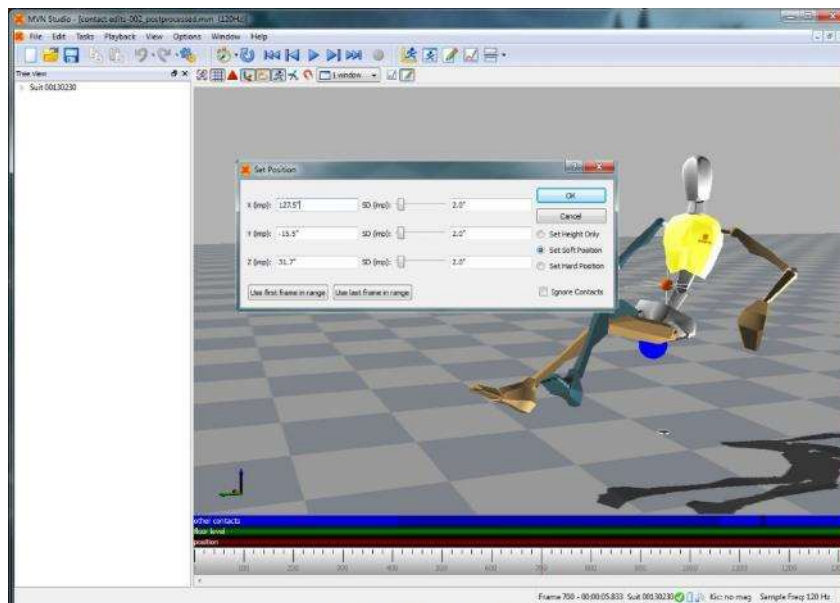

Figure 50: Example of using contact point aiding for seated position



10.3.2.6 Floor level

Sets the height of the floor. Multiple floor levels can be set in one file. The current floor level is presented in the dialog; see Figure 51 for an example.

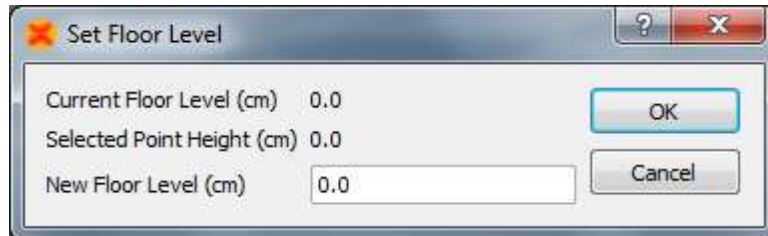

Figure 51: Set floor level menu

Right mouse click on a contact bar to set the floor height to the height of that contact. The contact detection will now be applied on the new floor height for all following samples.

Left mouse click and drag on the advanced bar allows you to set a floor height for a range of frames

10.3.2.7 Clipping

The clipping bar indicates when clipping has occurred in the data. This gives users an indication of when movement has caused sensor data to be exceeded. Data should not be trusted at these times.

10.4 Reprocessing

MVN files contain all original data and can be used to re-process the file using other settings and assumptions or with overruled external contacts, if needed. Anytime a change has been made to a file, e.g. contact points, change of fusion engine, subject dimensions or use of MVN Awinda to contain retransmitted data etc., the file must be reprocessed to ensure that the changes are implemented. It is advisable to save the reprocessed file with a new filename, to be able to return to the original values.

To enable reprocessing press 'Ctrl+Shift+P' or click the icon:



The result of clicking the above icon can be changed from 'Reprocess' to 'Auto-reprocess' by clicking on the dropdown arrow to right of the icon.

The upper bar will show the progress of the currently displayed frames when zoomed in. The lower bar will show the progress of the total file. Once the upper bar has been completed, you can continue editing frames in the current window. After the first pass, the progress bar will be green and the MVN Fusion engine will apply the edited contact points.

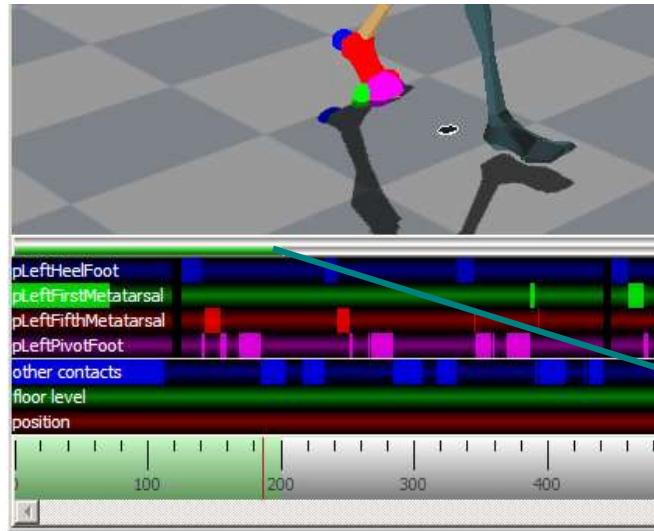

Figure 52: Contact editing reprocess bar

If many contacts have been inaccurately detected specifically on one side of the body, it is likely to be caused by inaccurate calibration. Check that the MT's of the legs and pelvis have not moved. Also check that the body dimensions are correct. If necessary, repeat a basic calibration (N or T pose).

If the lower leg protrudes through the foot during landing following a jump, the foot that pushed-off was probably detected as a contact for too long. This is remedied by removing the contacts of last few frames before the push-off.

The orthogonal view in the sagittal plane (Y) is a helpful way of determining exactly when the foot strikes the ground. It may help to remove all contacts for an interval around the expected contact frame to determine the time frame of contact.

To remove all edited contact points and let the MVN Fusion Engine detect contact points automatically, select 'Edit >Remove all user defined'. Reprocess to apply changes.

10.5 Multi-person editing

In the MVNS file, the contact and aiding points for each character can be edited separately. Click on one of the segments of the character you want to edit and follow the workflow as described in Section 10.3.

The body dimensions and scenario can also be changed in the calibration for the selected character.

For each suit, a separate export file will be generated when exporting to MVNX, BVH or FBX, C3D see Section 12.



11 Data Analysis

The final stage of the work flow is 'Data Analysis'. The major feature of the analysis stage is kinematic graphs.



11.1 Graphs

In the analysis workflow stage, a graph appears in the interface. To view a graph of a given parameter, click and drag the parameter from tree view to the graph. Two types of graphs are possible: time vs. parameter and parameter vs. parameter (Coordination [or phase] Plots).

11.1.1 Parameter vs. Time

Drag and drop a parameter with the left mouse button to create a parameter vs. time graph. Click on the colored boxes in the legend to disable/enable data in a given plane.

11.1.2 Coordination / Phase Plots (Parameter vs. Parameter)

Drag and drop a parameter with the right mouse button to the horizontal or vertical of the graph to create a parameter vs. parameter graph. Select the variable to plot from the menu. On the remaining axis, another axis of the parameter will be displayed as default. Repeat the process to plot the desired parameter on the remaining axis. See Figure 53 for an example of graph types.

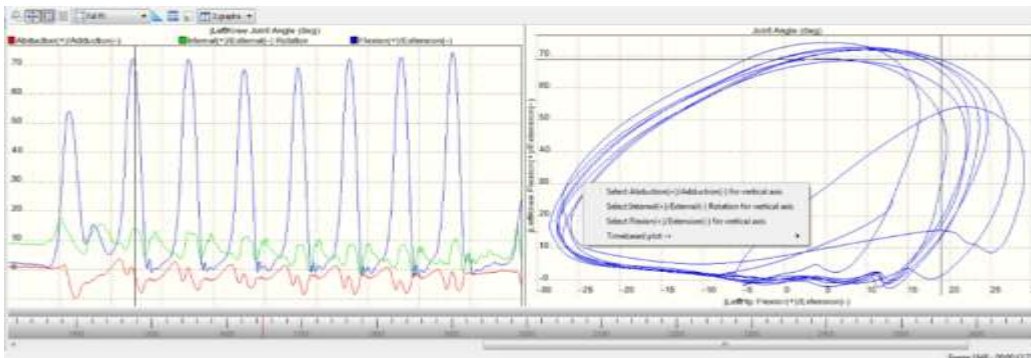

Figure 53: 2D graphs: Time vs. Parameter on the left hand side and parameter vs. parameter on the right hand side

Note that graphs show the angular velocity in degrees per second. In MVNX files, the angular velocity is exported in radians per second.



11.1.3 Graph handling

Zoom and pan in the graph using the icons in the toolbar. The time on the time vs. parameter graphs conforms to that shown in the time bar.

11.1.4 Graph toolbar

Icon	Task
	Zoom
	Pan
	Show/hide legend
	Show numerical value on graph
	Freeze graph (not yet available)
	Scaling options: Full fit, Expand to fit, No auto scaling
	Equal axes
	Show all samples (always on)
	Clear graphs (not yet available)
	Amount and layout of graphs
	Horizontal / Vertical graph view (on main tool bar but used only in combination with graphs)

11.1.5 Scaling Options

Scaling option	Functionality
No auto scaling	Y-scale will no longer be scaled
Expand to fit	Y-scale will be stretched to show all data in plot
Full fit	Y-scale will be stretched to show all data in plot

11.1.6 Zoom

To zoom, select the “No auto scaling” option. Zoom only takes place on the vertical axis. To zoom in time use the mouse wheel in the time line to zoom horizontally to a point in time.



11.1.7 Pan

To use the pan function, enable “no auto scaling”, click in the graph area with the left mouse button and drag up or down, to pan. Note that it is not possible to pan to an area with no data. When data is available beyond the limits of the vertical axis it is possible, using the cross bar to pan, and also using a purple scroll bar, which appears on the side of the graph when there is a large difference between vertical values, as Figure 54 shows.

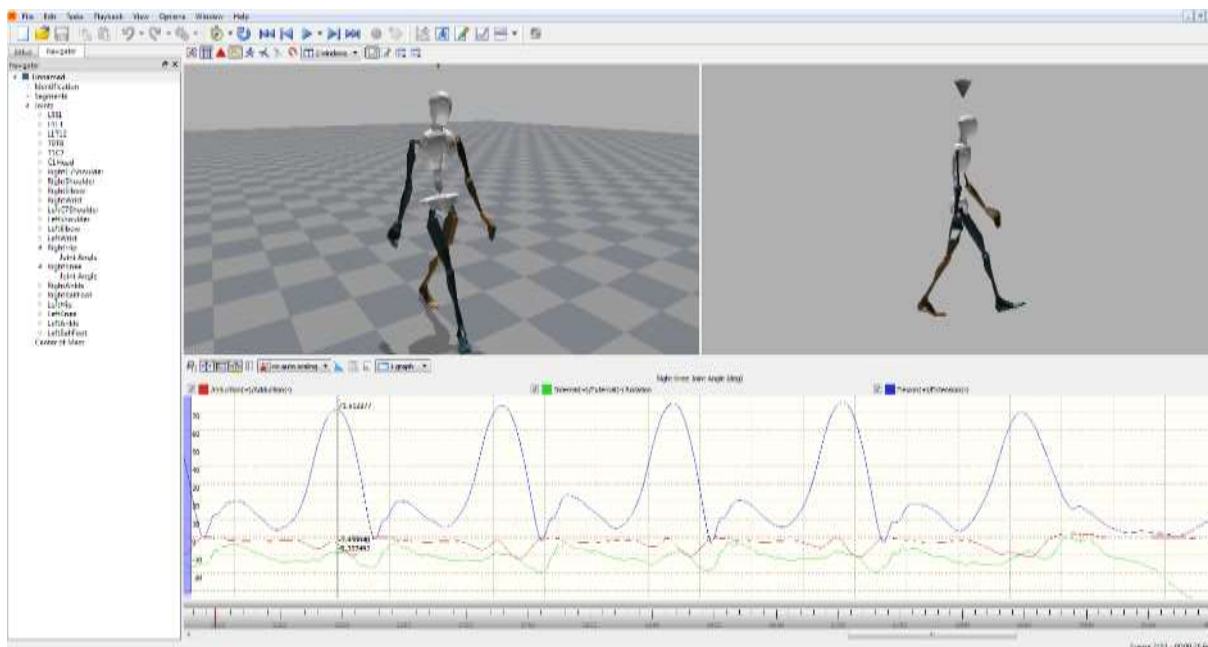

Figure 54: Pan and Numerical Values on Graphs

11.1.8 Show/ Hide Legends

Often it is already understood what the colors of the graphs represent. To save room, the legends can be hidden by toggling the Show / hide legend icon.

11.1.9 Show Numerical Values on Graphs

Using this icon, the numerical value on the graph is visible. It is possible that at times the lines intersect and the values are not clearly visible, when this happens; remove one line from view by disabling this in the tick box in the legend. In this way the value of one line at a time is made visible. See Figure 54 for an impression of how the numerical values appear in the graph.

11.1.10 Equal axes

This tool is used with the phase / coordination plots. Toggle between Equal Axes and “Full Fit” depending on the detail required.

11.1.11 Amount and layout of graphs

There are a number of pre-defined layouts available, which can be selected from the drop down menu. Additionally, there is a possibility for the user to define a custom amount and layout of the graphical representation. When “Custom” is selected, a new area appears where the user can insert the number of rows by columns to view.



11.2 Cascade / Tile windows

Multiple trials can be opened simultaneously and played and edited. Viewing a live performance is also possible in playback. Use the 'Window > Cascade / Tile' menu to select the window layout.

11.3 Linked views

When multiple windows are active, their views can be linked. Upon enabling Linked Views, the scene of all windows will be reset such that the origin faces the same direction. When the view in one window is changed, the view in the other window will change accordingly. Use 'Options > Linked Views' to toggle the linked views option.



12 Saving and Exporting

When a recording has been made, two files are created and saved automatically, one with the file extension “.mvn” and the other with the file extension “.mvns”. If synchronized video data is recorded, a movie file “.mpg” is also saved automatically.

MVN (MVN native file) is the most comprehensive format and contains all measured inertial sensor data, and all kinematic data of each segment. It is a binary proprietary format and can only be used by MVN Studio or by using the SDK. The MVN files contain all original data and can be used to re-process a recording using other settings and assumptions or with overruled external contacts. To copy a part of an MVN file to a new MVN file, select the frames and go to >Edit >Copy to MVN, press ‘Ctrl+B’ or right click the Timeline.

MVNS is the MVN session file. It contains information about the recorded trials, it is necessary to open an MVNS file if video data was recorded, or to playback and edit time-synchronized multi-person recordings.

If video data was recorded, opening the file with extension .mvn will open only the MVN data – the 3D character in the viewports. Therefore to watch synchronized video data with the MVN data, open the file with the “.mvns” extension, which will call both the .mpg and the related .mvn files.

If MVN Studio was used for multi-person capture, data of each character is saved in a separate MVN file, which is synchronized based on the internal clock of the XMs for each suit. This means that for long files, the number of frames between simultaneously recorded MVN files can differ. However, these MVN files are grouped in the MVNS file. All recordings in an MVNS file are opened in the same 3D viewport and will be played back simultaneously. In the MVNS file, all tracks have the same number of frames. The MVN files will all have the same session name with the suit number as a suffix. For example, the MVNS file ‘Skating-002.mvns’ consists of two MVN files: ‘Skating-002-suit00.mvn’ and ‘Skating-002-suit01.mvn’.

MVN (MVN and MVNX) files can be exported to C3D, FBX, BVH or MVNX format. Before exporting a file to a given format, ensure that the settings are correct. To do this, go to >Options >Preferences >Exporters. Then go to >File >Export >Export File and select the desired export format. For batch processing of all active captures, go to >File >Export >Export All Open Files. For batch processing of a complete folder, go to >File >Export >Batch export. To export only a selected portion of an MVN or MVNX file go to >File >Export >Export Selection.

There are five main exporters, BVH, C3D, FBX, MVNX, and a Movie Exporter. Each exporter has its own menu in the preferences section.

12.1 Applying (Smoothing) Filters to Exported Data

The first option to set in the exporters preferences is the filtering. This setting is used only for BVH and FBX.

12.1.1 Exporter smoothing

The highly sensitive sensor modules capture every twitch and deliver very crisp data. For some applications, more smoothed motion data is desired. Three options are available:

- No smoothing
- Light smoothing
- Heavy smoothing

The Export Smoothing Filter does not introduce a phase lag. Light smoothing is generally the recommended option.



12.1.2 Output filtering: LXsolver

The MVN fusion engine allows some laxity between joints to allow for small errors due to for example soft tissue movement. In the FBX export file, the positions and orientations of all segments as captured are exported. In BVH, only the position of the root (pelvis) is exported. The other segments are rigged, based on Euler angles with respect to the previous segment. Since the captured position of the foot can be different than the rigged position, it can result in foot slide.

The LXsolver exports the data to a form that minimizes soft tissue artefacts and joint laxity while keeping the feet at place. By default it is active on FBX and BVH and performed after the smoother.

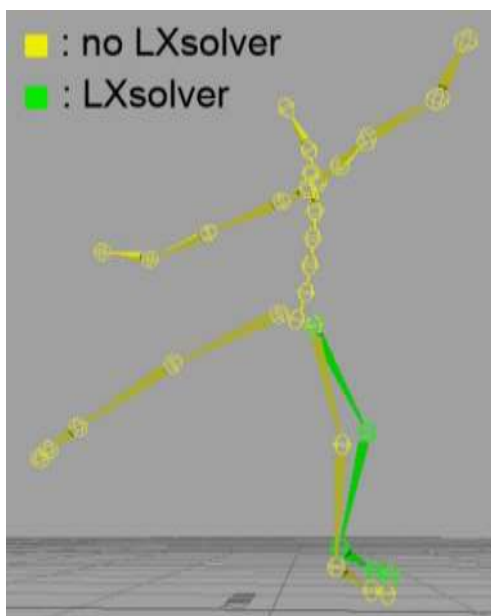

Figure 55: Comparison of MVN results with and without LXsolver

12.2 BVH

The name BVH stands for BioVision Hierarchical data, and embeds captured motion data in ASCII format which can be imported in many animation applications.

A BVH file consists of two parts, a header section which describes the hierarchy and initial pose of the skeleton; and a data section which contains the motion data. The start of the header section begins with the keyword 'HIERARCHY'. The following line starts with the keyword 'ROOT' followed by the name of the root segment of the hierarchy to be defined, usually the hips. Each segment contains a vector indicating the length and direction from the parent segment. The vector is specified by the keyword 'OFFSET' followed by the X, Y and Z values. The 'CHANNELS' keyword indicates the number of channels for this segment (usually 3 Euler angles) together with the order of rotation. On the next line, either you will find the 'JOINT' keyword or the 'End Site' keyword. The end site information ends the recursion and indicates that the current segment is an end effector (has no children). The end site definition gives the length of the preceding segment just like the offset of a child defines the length and direction of its parents segment. The world space is defined as a right handed coordinate system with the Y axis as the world up vector.



In the default BVH hierarchy, the character is in a T-pose. Use the 3ds Max exporter to write a neutral pose (arms parallel to body). Use the Poser exporter to reduce the number of chest segments from 4 to 2.

The motion section begins with the keyword 'MOTION'. This line is followed by the number of motion frames by the keyword 'Frames' and 'Frame Time', indicating the sampling rate of the data. The rest of the file contains the actual motion data; the X, Y and Z position of the root segment and Euler angles of each segment with respect to its parent segment. Each line is one sample of motion data. The numbers appear in the order of the channel specifications as the skeleton hierarchy was parsed.

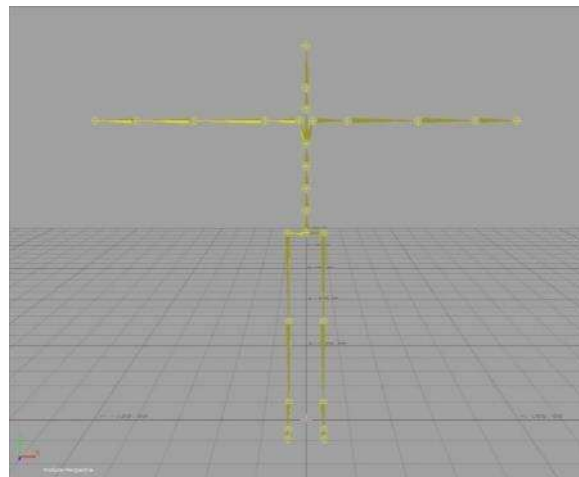
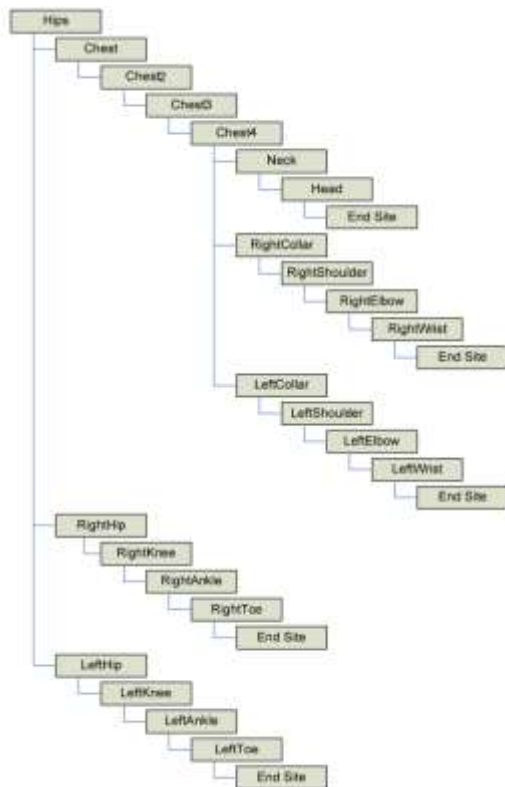

It should be noted that the BVH format is restrictive and it does not reflect the full information as captured with MVN. The numerical resolution of BVH files is limited compared to the MVN and MVNX files. The Euler angle conversion may cause round-off issues in certain poses (singularities). Since all segments are rigidly connected (which is not the case in the MVN Fusion Engine) some foot slide may occur since all errors such as mainly soft tissue artefacts are 'projected' on the feet. However, the LXsolver removes this on export, see 12.1.2. Further optimization can be done by using inversed kinematics (IK) solvers which are usually available in animation applications and which are also necessary for retargeting the motion data to different characters.

The BVH format does not support multi-person recordings. For each person a separate BVH file will be made.

Set the BVH preferences. An explanation of each option is provided below.

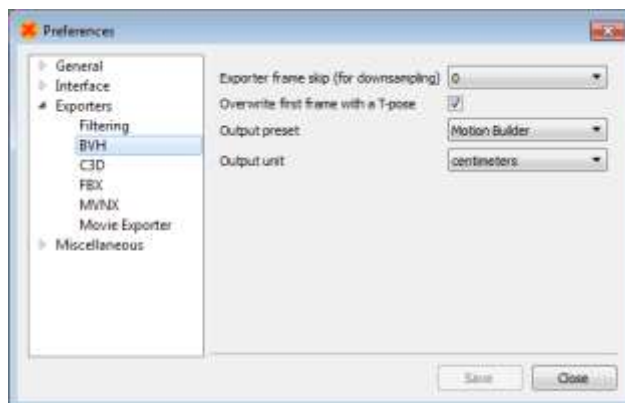

Figure 56: BVH Preferences Menu

12.2.1 Frame skip

The frame skip number (n) is used to reduce the frame rate of the output. The exporter will perform down sampling by skipping every n frames (n = 0 to 10) of the original file (after smoothing) in the output. Note that if no smoothing is specified, no smoothing will be applied when using frame skip.

The output rate is given by: original sample rate / (1 + skip factor).

For example, an MVN file recorded at 100 Hz:

frame skip = 1, output frame rate = 50 Hz

frame skip = 2, output frame rate = 33 Hz

frame skip = 3, output frame rate = 25 Hz

Or for example, an MVN file recorded at 240 Hz:

frame skip = 1, output frame rate = 120 Hz

frame skip = 2, output frame rate = 80 Hz

frame skip = 3, output frame rate = 60 Hz

So, take care when selecting your preferred motion capture update rate if you need a specific output frame rate, it can make your life easier.

12.2.2 Overwrite first frame with T-pose

To align the captured motion data with an animation model, the T-pose will actually be inserted before the first frame of the data. The position and orientation of all segments can be found in the MVNX file in the <tpose>section.

12.2.3 Output Presets

Several Output Presets are available that fit specific applications:

- Motion Builder
- 3D Studio Max
- Poser 6

12.2.4 Output Unit

Select the desired output unit that is used in the animation program.



12.3 C3D

C3D means “Coordinate 3D”; as the name suggests it is a file format designed to contain 3D coordinate data, usually in the form of bony landmarks. It has also been designed to contain analog data. The 3D and analog samples are interleaved, frame-by-frame, throughout the data in a straightforward manner.

C3D data can contain 3D, 2D, analog data or a combination. In addition, it is possible (although not very efficient) to store the results of kinematic calculations (angles, moments, accelerations etc.) within the 3D data record format. To facilitate biomechanics users, C3D is a new export format in MVN Studio 3.0 Pro. The menu in Figure 57 shows the possibilities allowed for C3D export.

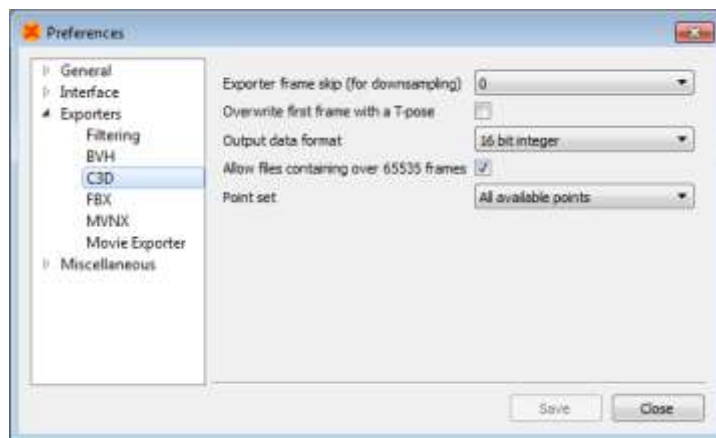

Figure 57: C3D Exporter interface in Preferences menu

There are two lists of points that can be exported, “All available points” and “External Points”. External Points are included in the “All available” selection. Section 12.3.1 is a list of the anatomical landmarks exported by C3D. Just like BVH, C3D data can be downsampled prior to exporting.

Most systems accept the 16 bit integer output format. However, when this is not the case, the single precision floating point (IEEE 754) can be chosen, which will enhance resolution (less output quantization).

In the past C3D was designed to accept no more than 65535 frames. Tick the box to allow trials longer than 65535.

A prop will be exported in C3D with tags: ‘origin’, ‘tip’ and ‘extra’.

Exported C3D data has been successfully tested in C-Motion’s Visual 3D.



Xsens

12.3.1 Points exported in C3D Exporter

For an illustration of the location of the points, see Figure 68.

1	pHipOrigin	33	pRightTopOfHand
2	pRightASI	34	pRightPinky
3	pLeftASI	35	pRightBallHand
4	pRightCSI	36	pLeftTopOfHand
5	pLeftCSI	37	pLeftPinky
6	pRightIschialTub	38	pLeftBallHand
7	pLeftIschialTub	39	pRightGreaterTrochanter
8	pSacrum	40	pRightKneeLatEpicondyle
9	pL5SpinalProcess	41	pRightKneeMedEpicondyle
10	pL3SpinalProcess	42	pRightMiddleKneeCap (or pRightPatella)
11	pT12SpinalProcess	43	pLeftGreaterTrochanter
12	pPX	44	pLeftKneeLatEpicondyle
13	pJ	45	pLeftKneeMedEpicondyle
14	pT4SpinalProcess	46	pLeftMiddleKneeCap (or pLeftPatella)
15	pT8SpinalProcess	47	pRightLatMalleolus
16	pC7SpinalProcess	48	pRightMedMalleolus
17	pTopOfHead	49	pRightTibialTub
18	pRightAuricularis	50	pLeftLatMalleolus
19	pLeftAuricularis	51	pLeftMedMalleolus
20	pBackOfHead	52	pLeftTibialTub
21	pRightAcromion	53	pRightHeelFoot
22	pLeftAcromion	54	pRightFirstMetatarsal
23	pRightArmLatEpicondyle	55	pRightFifthMetatarsal
24	pRightArmMedEpicondyle	56	pRightPivotFoot
25	pLeftArmLatEpicondyle	57	pRightHeelCenter
26	pLeftArmMedEpicondyle	58	pRightToe
27	pRightUlnarStyloid	59	pLeftHeelFoot
28	pRightRadialStyloid	60	pLeftFirstMetatarsal
29	pRightOlecranon	61	pLeftFifthMetatarsal
30	pLeftUlnarStyloid	62	pLeftPivotFoot
31	pLeftRadialStyloid	63	pLeftHeelCenter
32	pLeftOlecranon	64	pLeftToe

If props have been used in the measurement, these will also be exported in the C3D file. The parameters of the props are Extra, Origin and Tip. If more than one prop has been used, the label will be appended with “_” and the number of the prop (2 onwards). To use the point, as with the output points of the biomechanical model, use the label “Origin”. Tip and Extra are needed to calculate the orientation of the prop.



12.4 FBX

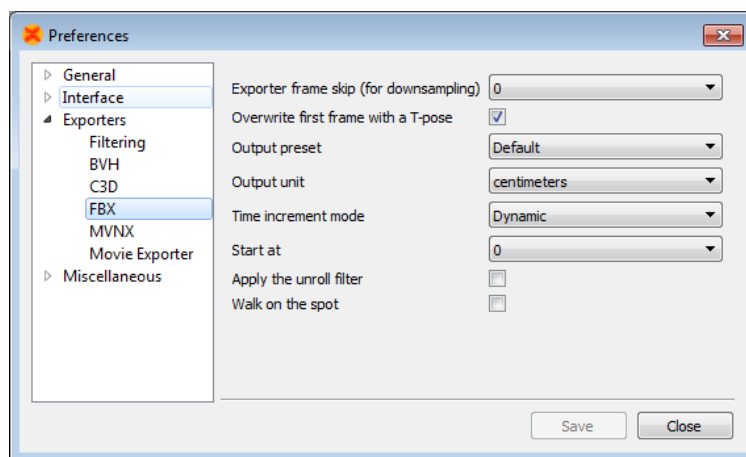

Figure 58: FBX Preferences Menu

FBX (Filmbox) is a platform-independent 3D file format which gives you access to content authored in software packages such as MotionBuilder, Maya, Unity or Softimage. For some software packages, an FBX plug-in should be installed.

FBX files contain both position and orientation information of all 23 segments. The FBX file will also contain the frame time format. Go to >Options >Preferences >Exporters >FBX ... and select the timestamp output mode. To store the appropriate time code in an FBX file, the FBX exporter plug-in must be set to "Dynamic time increments" and "Start at real start time" as seen in Figure 58. This figure also shows that many of the options for FBX are also applicable to BVH. For details, see the above descriptions for the items on the BVH menu.

Under Output preset you have the option to choose "Default" and "Skeleton". "Default" export contains position and orientation information of all 23 segments in global coordinates. "Skeleton" export contains skeleton hierarchy information in a way that is used by many common 3D software packages like MotionBuilder, Maya, Unity and Houdini.



12.5 MVNX

MVNX (MVN Open XML format) files are provided. These are XML files that can be opened in programs such as MICROSOFT EXCEL, ACCESS and MATLAB; see section 22 for help importing these files to MATLAB and EXCEL. MVNX contains as default, 3D segment and position data.

Additional values can be exported as Figure 59 shows, including:

- 3D Position, linear and angular acceleration and velocity of all 23 segments.
- 3D Joint angles of 22 joints.
- 3D Orientation, acceleration, angular velocity and magnetic field data of all 17 MT's.

Since MVN 4.0, a time code field is also available.

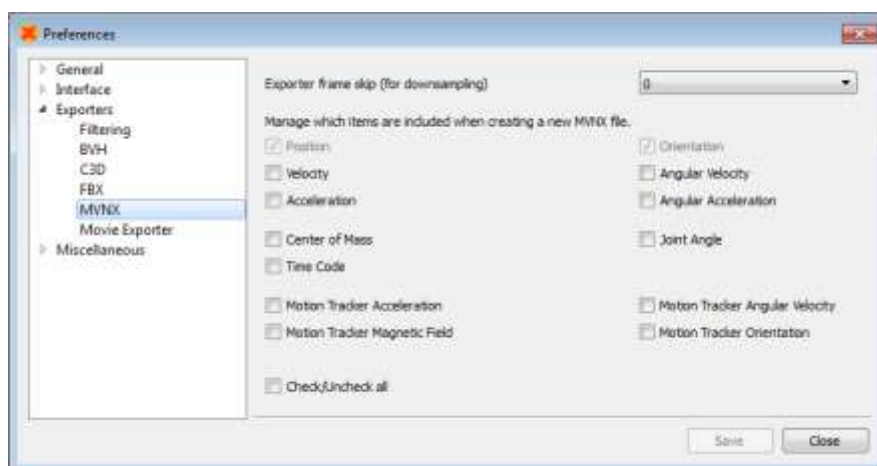

Figure 59: MVNX Preferences Menu



The entire MVNX structure is as follows:

```

<?xml version="1.0" encoding=" UTF-8"?>
<mvnx version="3">
  <mvn version=" ..." build=" ..." />
  <comment></comment>
  <subject label="Suit..." frameRate=" ..." segmentCount=" ..." recDate=" ..." originalFilename=" ..." >
    <comment></comment>
    <segments>
      <segment label=" ..." id=" ..." >
        <segmentScale>
          <offset>X Y Z </offset>
          <rotation>="r11 r12 r13 r21 r22 r23 r31 r32 r33"</rotation>
        </segmentScale>
        <points>
          <point label=" ..." >
            <pos_s>X Y Z</pos_s/>
          </point>
        etc.
      </points>
    </segment>
  etc.
</segments>
  <sensors>
    <sensor label = " ..." />
  etc.
</sensors>
  <joints>
    <joint label=" ..." >
      <connector1>...</connector1>
      <connector2>...</connector2>
    </joint>
  etc.
</joints>
  <frames segmentCount= " ..." sensorCount= " ..." jointCount= " ..." >
    <frame time= " ..." index= " ..." type = "normal" >
      <orientation>GBqseg1 GBqseg2 ...etc... GBqseg23</orientation>
      <position>Gposseg1 Gposseg1 ...etc... Gposseg23</position>
      <velocity>Gvseg1 Gvseg2 ...etc... Gvseg23 </velocity>
      <acceleration>Gaseg1 Gaseg2 ...etc... Gaseg23 </acceleration>
      <angularVelocity>Gwseg1 Gwseg2 ...etc... Gwseg23</ angularVelocity >
      <angularAcceleration>Gawseg1 Gawseg2 ...etc... Gawseg23</angularAcceleration>
      <sensorAcceleration>Sasen1 Sasen2 ...etc... Sasen17 </sensorAcceleration>
      <sensorAngularVelocity>Swsen1 Swsen2 ...etc... Swsen17</sensorAngularVelocity>
      <sensorMagneticField>Smsen1 Smsen2 ...etc... Smsen17</sensorMagneticField>
      <sensorOrientation>Gqsen1 Gqsen2 ...etc... Gqsen17</sensorOrientation>
      <jointAngle>jjnt1 jjnt2 ...etc... jjnt22</jointAngle>
      <jointAngleXZY>Jjnt1 Jjnt2 ...etc... Jjnt22</jointAngleXZY>
      <centerOfMass>GCseg1 GCseg2 ...etc... GCseg23 </centerOfMass>
      <marker>"name" </ marker >
    </frame>
  </frames>

```



```

    </frame>
etc.
</frames>
</subject>
<securityCode code= "..." />
</mvnx>

```

The MVNX file starts with the XML version number and a reference to the DTD (Document Type Definition). Then the root element “mvnx” with a reference to the XSD (XML Schema Definition) and the MVNX version. This is followed by a field “mvn”, containing the MVN Studio version and build details with which this MVNX file was produced, followed by the comments that were added to the original recording:

```

<?xml version="1.0" encoding=" UTF-8"?>
<!DOCTYPE mvnx SYSTEM "http://www.xsens.com/mvn/mvnx/schema.dtd">
<mvnx xmlns:xsi="http://www.w3.org/2001/XMLSchema-instance"
xmlns="http://www.xsens.com/mvn/mvnx" xsi:schemaLocation=http://www.xsens.com/mvn/mvnx/schema.xsd version="3">
  <mvn version="..." build="..." />
  <comment></comment>

```

The file continues with session information, including the suit label (= name of the MVN System), sample frequency used, number of segments calculated (indicating full or half body); the date that the recording took place, and the filename of the original recording on which the MVNX file is based. When creating a recorded file, a user can insert a comment. This is available in the exported MVNX: (this field usually has the same contents as the comment field after the <mvn> tag, see above)

```

<subject label=" Suit 00130268" frameRate="100 segmentCount="23" recDate="day month
year" originalFilename="DIRECTORY\FILENAME.mvn">
<comment></comment>

```

The next section contains mesh scale and labeling information for the segments. The mesh scale data is used for scaling of the visualization of the character in MVN Studio.

The section <segments> defines all positions (pos_s) of connecting joints (prefixed with a “j”) and anatomical landmarks (prefixed with a “p”) with respect to origin of that segment (in body fame B). Within each segment is:

```

<segments>
<segment label="RightUpperLeg" id="16">
  <segmentScale>
    <offset>X Y Z </offset>
    <rotation>="r11 r12 r13 r21 r22 r23 r31 r32 r33"</rotation>
  </segmentScale>
  <points>
    <point label="...">
      <pos_s>X Y Z</pos_s/>
    </point>
  etc.
  </points>
</segment>

```



The sensor data is simply a list of the names of segments measured with the MT's:

```
<sensors>
  < sensor label ="Pelvis"/>
  < sensor label ="Head"/>
  < sensor label ="RightShoulder"/>
etc.
</sensors>
```

The "joints" section is a list of the names of joints contained and the segments and connections a given joint:

```
<joints>
<joint label=" jLeftHip">
<connector1>Pelvis/jLeftHip </connector1>
<connector2>LeftUpperLeg/jLeftHip </connector2>
</joint>
etc.
</joints>
```

The frames section is opened with the segment, sensor and joint count. The data of all parameters are contained within this section, including the calibration pose data.

```
<frames segmentCount= "..." sensorCount= "..." jointCount= "...">
<frame ... >
</frame>
Etc.
</frames>
```

The frame type "tpose" and "npose" sections describe the positions and rotations of all segments during respective calibration poses. All kinematic data is expressed in the global coordinate system:

```
<frame time="0" index="-2" tc="00:00:00:00" ms="0" type="tpose">
  <orientation>...</orientation/>
  <position>...</position/>
</frame>
```

Following this, the frames are split into *time*; each frame increment is equivalent to $(\text{frame no.} / \text{update rate}) * 1000$ [ms]. So at 120Hz, frame 1 is denoted by $([1/120] * 1000) = 8.3$ [ms]. Frames measured during a normal session are denoted with type = "normal".

The *index* attribute still contains the original frame number.

The optional "tc" and "ms" attributes contain the TimeCode values, i.e. the absolute real time at which that specific frame was recorded (often used to synchronize and combine this recording with other data that was gathered at the same time).



The selection in the preferences menu determines the MVNX contents. Orientation and Position are mandatory, all others are optional and may depend on the license.

```
<frame time= "... " index="frame number" tc="15:57:47:02" ms="1418227067039" type="normal">
<orientation>GBqseg1 GBqseg2 ...etc... GBqseg23</orientation>
<position>Gposseg1 Gposseg2 ...etc... Gposseg23</position>
<velocity>Gvseg1 Gvseg2 ...etc... Gvseg23 </velocity>
<acceleration>Gaseg1 Gaseg2 ...etc... Gaseg23 </acceleration>
<angularVelocity>Gwseg1 Gwseg2 ...etc... Gwseg23</ angularVelocity >
<angularAcceleration>Gawseg1 Gawseg2 ...etc... Gawseg23</angularAcceleration>
<sensorAcceleration>Sasen1 Sasen2 ...etc... Sasen17 </sensorAcceleration>
<sensorAngularVelocity>Swsen1 Swsen2 ...etc... Swsen17</sensorAngularVelocity>
<sensorMagneticField>Smsen1 Smsen2 ...etc... Smsen17</sensorMagneticField>
<sensorOrientation>GSqsen1 GSqsen2 ...etc... GSqsen17</sensorOrientation>
<jointAngle>jjnt1 jjnt2 ...etc... jjnt22</jointAngle>
<jointAngleXZY>Jjntx1 Jjntx2 ...etc... Jjntx22</jointAngleXZY>
<centerOfMass>GCseg1 GCseg2 ...etc... GCseg23 </centerOfMass>
<marker>"name" </ marker name>
</frame>
```

For the elements represented below with a subscript “seg”, the set will contain the number of segments (segmentCount) times the number of columns of data. For a full body, this is 23 segments.

Subscript “sen” contains the number of MT’s (sensorCount) times the number of columns of data. For a full body, this is 17.

Subscript “jnt” contains the number of joints (jointCount) times the number of columns of data. For a full body, this is 22 joints.

^{G^B} q _{seg}	1x4 quaternion vector (q ₀ , q ₁ , q ₂ , q ₃) describing the orientation of the segment in the global frame.
^G pos _{seg}	1x3 position vector (x, y, z) of the origin of the segment in the global frame in [m].
^G v _{seg}	1x3 velocity vector (x, y, z) of the origin of the segment in the global frame in [m/s].
^G a _{seg}	1x3 acceleration vector (x, y, z) of the origin of the segment in the global frame in [m/s ²].
^G w _{seg}	1x3 angular velocity vector (x, y, z) of the segment in the global frame in [rad/s].
^G aw _{seg}	1x3 angular acceleration vector (x, y, z) of the origin of the segment in the global frame in [rad/s ²].
^S a _{sen}	1x3 sensor acceleration vector (x, y, z) of the sensor in [acc/s ²].
^S w _{sen}	1x3 sensor angular velocity vector (x, y, z) of the sensor in [rad/s].
^S m _{sen}	1x3 sensor magnetic field vector (x, y, z) of the sensor in [a.u.].
^{G^S} q _{sen}	1x4 sensor orientation quaternion (q ₀ , q ₁ , q ₂ , q ₃) of the sensor in the global frame in.
j _{jnt}	1x3 Euler representation of the joint angle vector (x, y, z) in [deg], calculated using the Euler sequence ZXY.
J _{jntx}	1x3 Euler representation of the joint angle vector (x, y, z) in [deg], calculated using the Euler sequence XZY. <i>Note: The joint angle using Euler sequence XZY is calculated and exported for all joints, but commonly only used for the shoulder joints, and it may depend on the movement of the shoulder if it is appropriate to use.</i>
^G C _{seg}	1x3 position of the body Center of Mass (x,y,z) in the global frame in [m].



The numbering is presented in the table below.

Number	Segment Label	Tracker	Joint
1	Pelvis	Pelvis	jL5S1
2	L5	T8	jL4L3
3	L3	Head	jL1T12
4	T12	RightShoulder	jT9T8
5	T8	RightUpperArm	jT1C7
6	Neck	RightForeArm	jC1Head
7	Head	RightHand	jRightC7Shoulder
8	Right Shoulder	LeftShoulder	jRightShoulder
9	Right Upper Arm	LeftUpperArm	jRightElbow
10	Right Forearm	LeftForeArm	jRightWrist
11	Right Hand	LeftHand	jLeftC7Shoulder
12	Left Shoulder	RightUpperLeg	jLeftShoulder
13	Left Upper Arm	RightLowerLeg	jLeftElbow
14	Left Forearm	RightFoot	jLeftWrist
15	Left Hand	LeftUpperLeg	jRightHip
16	Right Upper Leg	LeftLowerLeg	jRightKnee
17	Right Lower Leg	LeftFoot	jRightAnkle
18	Right Foot		jRightBallFoot
19	Right Toe		jLeftHip
20	Left Upper Leg		jLeftKnee
21	Left Lower Leg		jLeftAnkle
22	Left Foot		jLeftBallFoot
23	Left Toe		

12.5.1 Importing MVNX files into Excel and MATLAB

See Section 22.1.1 for a description of importing MVNX files into Microsoft Excel and Section 22.1.2 for an example of MATLAB code to import MVNX data into MATLAB.



12.6 Export Movie

Exporting movie data enables the user to export the 3D viewport of MVN Studio to either .m4v or .avi. this facilitates presenting MVN information to audiences without the need for installation of MVN Studio, Select the export format, resolution and export frame in >Options >Preferences >Exporters >Movie Exporter.

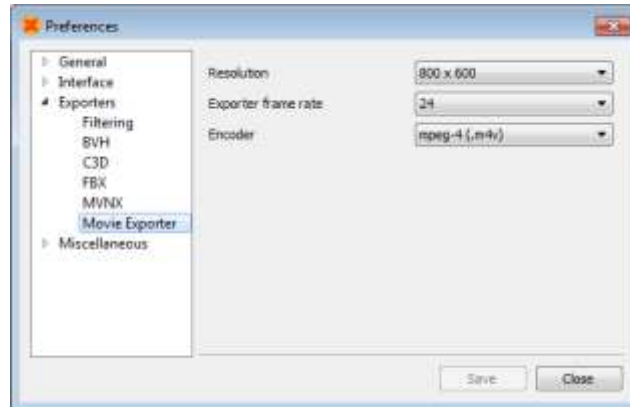



13 Features of MVN Studio

A range of additional features become available when using another license for MVN Studio PRO. These are summarized in Table 6.

Table 6: Overview of features for each possible MVN Studio license

Features	MVN Studio	MVN Studio Pro	MVN Studio BIOMECH
Multi-person	✓	✓	✓
Network Streamer (plug-ins)	✗	✓	✓
Extended Network Streamer	✗	✗	✓
Limited configurations	✓	All	All
Limited scenarios	✓	All	All
Reference camera support	✗	✓	✓
Export as movie	✗	✓	✓
Time code & remote control	✗	✓	✓
Graphs	✗	✓	✓
Real-time graphs	✗	✗	✓
Extended MVNX	✗	✗	✓
Third party synchronization	✗	✗	✓
Display biomechanical model	✗	✗	✓



13.1 Plug-ins

MVN Studio PRO and MVN Studio BIOMECH are equipped with the following plug-ins:

MVN Time Code and Remote Control Plug-in

The MVN time code and remote control plug-in is designed in case synchronization of single or multiple MVN systems with other systems is required. The data of a MVN system is time stamped during recording, so it can be lined up afterwards with data of other systems i.e. cameras, audio, etc. In a set-up with multiple MVN systems the plug-in allows you to start and stop the recording of multiple MVN systems as well as other third party devices via remote commands.

Additionally, the following plug-ins not installed with MVN Studio are downloadable from the web:

MVN MotionBuilder or Maya Live Plug-in

These plug-ins allow data recorded in MVN Studio to be streamed in real-time to an animation scene in Autodesk's Motion Builder or Maya.

Unity 3D

MVN Unity Live Plug-in is a module that gives Unity developers access to MVN motion capture data allowing artists and developers to easily view live motions in real-time on character. The plug-in supports scaled skeleton data for multiple characters.



14 MVN Ethernet Camera

MVN Studio 3.0 has the ability to record synchronized MVN and video data. This is possible using the Ethernet camera (Prosilica GS650) provided with the PRO system. The camera is a high quality professional GigE camera with a C mount. The GigE interface enables the use of long cables (max 100m) and standard 1 Gigabit Ethernet cards for interfacing. The currently supported frame rate in MVN Studio is limited, but the camera itself is capable of 120 frames per second (fps), depending on lighting conditions. The camera has a global shutter and is capable of advanced triggering and synchronization features.

14.1 Using the MVN camera GS650

The MVN camera GS650 has the following components, which you will need to know to connect to your PC.

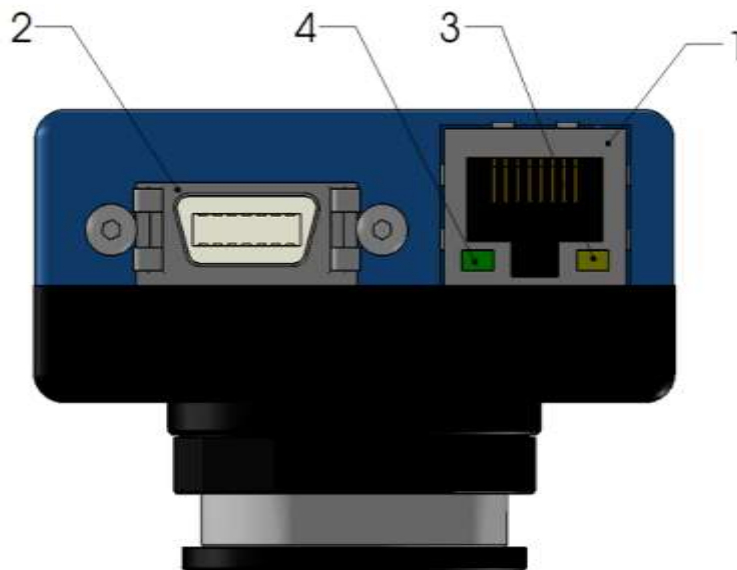

Figure 60: Interface and connections drawing of the MVN camera GS650.

1. Gigabit Ethernet interface, IEEE 802.3 1000BASE-T conformant, CAT5E or CAT6 recommended, max 100m.
2. GPIO port – Power supply
3. Status LED 1
 - a) Solid Orange, link established
 - b) Flashing Orange, data transmission, activity
4. Status LED 2
 - a) Solid Green, normal operation
 - b) Flashing, 1 Hz, booting
 - c) Flashing, 3x quickly @ 1 Hz, error

To use the MVN Camera, connect the power supply to the mains power (Slot 2 of Figure 60) and connect the network cable (Slot 1 of Figure 60) to the MVN Camera and to the network slot of the PC or laptop.



14.2 Camera driver

The camera should be available to MVN Studio when connected. The camera driver is installed together with the software. However, depending on your network card specification and the setup used, in some cases MVN Studio does not find the camera, or the performance is not as expected, re-installing the driver may solve this issue.

A dedicated driver (Prosilica GigE Filter Installer 1.20.exe) is available and can be found in folder ...\\Program Files (x86)\\Allied Vision Technologies\\

14.3 Network Configuration

There are two main methods of connecting the camera to your PC/laptop. There is also a third method, which is possible, but not recommended.

1. Connect the MVN Camera directly to the LAN-port on your PC/laptop.
2. The most advanced and recommended way of connecting the camera to your PC/laptop is to equip it with a second Ethernet-card. This way you can keep a wired LAN connection with your (corporate) network and receive the camera data directly on your PC/laptop without being routed over the LAN.
3. Connect the MVN Camera to the same LAN your PC/laptop is connected to (in your building). The data will then be routed via the LAN/switch to your PC/laptop.

The MVN camera is configured to obtain its IP-address by DHCP. In both cases the camera must be able to obtain an IP-address via a DHCP service. In the case you connect the camera directly to your PC the operating system must issue a (private) IP-address to the camera, this should happen automatically in Windows. Most LAN networks are configured to provide a DHCP service, ask your network administrator for details if you encounter any problems.

A direct connection (options 1 and 2) is faster, more robust and prone to less potential latency and connection issues.

Note that in the case that your PC/laptop has another means of accessing the LAN/internet, such as a WiFi link it is actually quite easy to opt for choice 1 or 2, with the advantages of a direct, fast connection to the camera, while still being connected to the LAN/internet.

Option 3 is not recommended, since this way of connection will not support high frame rates. However, a connection via the LAN has the advantage of having access to the services on the LAN (e.g. internet). Additionally, depending on the (security) policies implemented on the LAN it might be difficult in getting things to work without support from your network administrator. Technically, the DHCP service must give the camera an IP-address and subnet in the same range as the PC/laptop.

14.4 Jumbo Frames

The MVN camera will work with any Gigabit Ethernet network card; however it is strongly recommended that **Gigabit Ethernet components that support Jumbo Frames are used.**

A Jumbo Frame is loosely defined as a frame size greater than 1500 bytes however typical Jumbo Frames are around 9000 bytes. Frame size is the number of bytes per packet and the larger the frame size, the less the computer CPU will be loaded due to the processing of incoming packets. There are many Gigabit Ethernet cards available which will support Jumbo Frames. The following examples have been verified to work well with the camera:

- Intel PRO/1000
- D-Link DGE-550T
- SMC EZ Card 1000



Please check the Ethernet Network Card settings in the Windows Device Manager to enable support for “Jumbo Frames” and adjust it to its maximum value. The “Jumbo Frames” might also be called “Maximum Frame Size”.

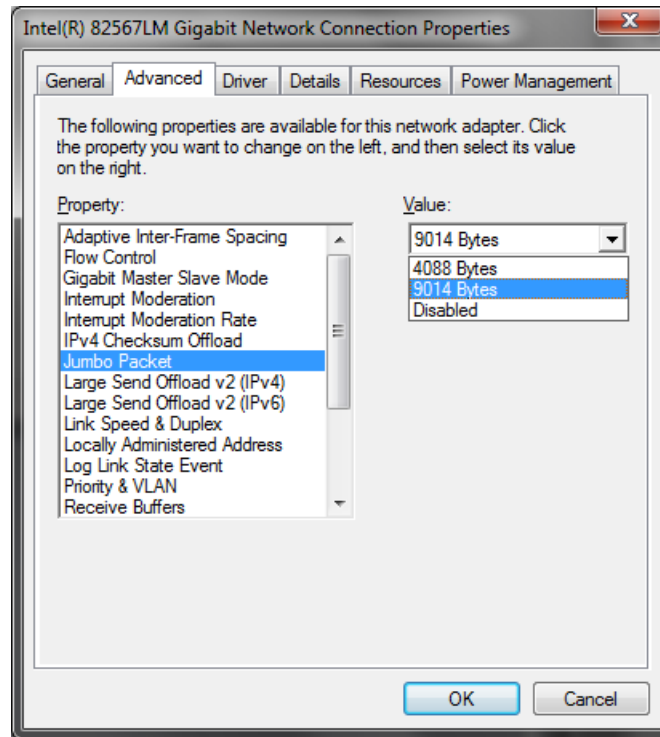

Figure 61: Screenshot illustrating setting the correct Jumbo Frame settings in the Device Manager dialogue.

14.5 Camera Usage Guidelines

Do not remove the fitted lens, this may cause the camera to become out of focus and may introduce dirt and debris in the housing destroying the CCD sensor in the camera. If you need to fit a different lens, this is done outside of warranty and on your own risk.



15 Xsens Peripheral Software

15.1 Magnetic Field Mapper (MFM)

When a motion tracker is mounted to an object that contains ferromagnetic materials, the measured (Earth) magnetic field can become distorted, causing errors in measured orientation. To correct for known magnetic disturbances, for example, an MT attached to a steel prosthesis or prop, or simply that the magnetic field has become distorted due to an event or over time, a separate software product has been developed to allow users to remap the magnetic field. This software is called Magnetic Field Mapper (MFM).

If MFM is needed, users should contact support@xsens.com for further support.

15.2 Firmware Updater

With new software releases, it can be expected that new firmware is required. For this purpose, Xsens supplies a firmware updater which can be downloaded separately from MVN Studio at <https://www.xsens.com/mvn-studio-download/>.

15.3 Software Activation Tool: Offline License Activation or Updating a License

An offline activation can be performed with the Software Activation Tool. In the offline activation process a Customer-to-Vendor (c2v) file is generated containing information on the current status of the licenses in your Sentinel protection keys. You can then send this file in order to activate license or receive a license update.

NOTE: If you are using a dongle you must connect the dongle, before performing either of the following procedures.

15.3.1 Step 1: Retrieve the license information from a Sentinel protection key

1. Launch the Software Activation tool from the start menu or help menu in MVN Studio
2. Click "Show advanced options".
3. Activating a Software License key for the first time: ensure that "Installation of a New Protection Key" is selected at the bottom of the screen. Updating an existing key or activate a dongle: ensure that "Update of existing protection key" is selected at the bottom of the screen.
4. Click "Create security key information file (C2V)"
5. Click "Next", the file is generated
6. Specify the directory where you want to store the C2V file. Enter a file name and click "Save".
7. The C2V file for the Sentinel protection key is generated and saved in the required location. The file can now be sent.

15.3.2 Step 2: Send the C2V file

1. Send the C2V file to Xsens support (support@xsens.com) requesting an offline license file.
2. You will receive a Vendor-to-Customer file (v2c) from Xsens support.

15.3.3 Step 3: Apply the received v2c file using the Software Activation tool.

1. Launch the Software Activation tool.
 2. Click "Show advanced options".
 3. Click "Apply license file (V2C)".
 4. Click "Next" and browse to the V2C files you have received to open it
- The license is activated/updated.



15.4 Software Activation Tool: Applying an Update

You can use the Software Activation tool to apply an update to the licenses stored in your Sentinel protection keys.

To update the licenses in the Sentinel protection keys:

1. Launch the Software Activation tool from the start menu or help menu in MVN Studio
2. Click "Show advanced options".
3. Click "Apply license file (V2C)".
4. Click "Next" and browse to the V2C files you have received to open it

The license is activated/updated.

15.5 RUS Utility: Rehosting a Sentinel protection key

The RUS utility can be downloaded from: <https://www.xsens.com/mvn-studio-download/>

You can use the RUS utility to transfer a Sentinel protection key from one computer (the source computer) to another (the recipient computer). This is a three-step procedure that uses the RUS utility on both computers.

15.5.1 Step 1: Collect Information about the Recipient Computer

1. On the recipient computer, launch the RUS utility
2. Click the Transfer License tab.
3. Follow the instructions labelled "Step 1" to collect information about the computer and save it to a file. Make sure that the file (or a copy of the file) is accessible on the source computer.

15.5.2 Step 2: Generate the License Transfer File

1. On the source computer, launch the RUS utility
2. Click the Transfer License tab.
3. Follow the instructions labelled "Step 2" to select the SL key to transfer, read the recipient information file, and generate a license transfer (h2h) file. Make sure that the license transfer file (or a copy of the file) is accessible on the recipient computer.

Note: After you perform this step, the SL key is no longer available on the source computer. Be sure to keep a copy of the transfer file until you have completed the transfer procedure.

15.5.3 Step 3: Apply the License Transfer File

1. On the recipient computer, in the RUS utility, click the Apply License File tab.
2. In the Update File field, click the browse button and locate the license transfer (h2h) file.
3. Click Apply Update. The SL key is installed on the recipient computer.

NOTE: To ensure the success of the transfer procedure, all the steps in the procedure should be completed within no more than a two days of the time you first start the process.



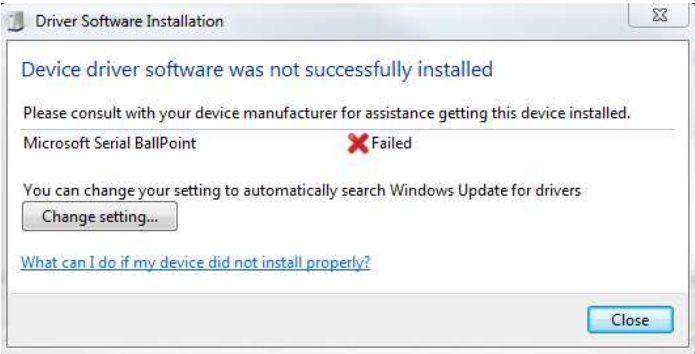

16 Troubleshoot

Problem	Solution
<p>Device driver error Awinda Station with docked MTw's results in "Driver Software Installation" error. See figure to the right displaying the pop-up warning:</p>	 <p>This is a timing issue because Xsens motion trackers send data to the PC continuously to guarantee a fast set up time. To solve, remove the tracker from the station then redock.</p>
<p>The suit does not connect.</p>	<p>Check battery levels.</p> <p>Check 'Hardware status' menu (Section 7.8).</p> <p>Check Suit configuration (Section 7.2.11)</p> <p>Ensure that only one MVN Studio is running on a given computer.</p> <p>MVN LINK: Turn on the BP off and on again (Section 5.5.5).</p> <p>Run a WPS between BP and AP</p> <p>MVN Awinda: Unplug Awinda Station from power supply and PC then reconnect re-plug.</p> <p>Power off MTws press power button for 6s. Press for 1s to turn back on.</p>
<p>MTx status remains missing ('red') in 'Hardware status' menu</p>	<p>Check if MTx is connected. Sometimes a connector can become loose after putting on the suit.</p> <p>Replace MTx and relocate sensor ID (Section 7.8.1).</p>
<p>MVN Studio does not start (Shader compilation / validation errors).</p>	<p>Use a computer with at least a DirectX 9 hardware card.</p>
<p>Limited range wireless connection</p>	<p>Turn off all other wireless equipment (Bluetooth, WiFi, etc) and scan for a WiFi channel free of other wireless signals.</p>





Problem	Solution
Live preview is active but recording is not possible	<p>Enter the subject dimensions: body height and foot size (Section 8.1).</p> <p>Perform an N-pose calibration (Section 8.2.2). Make sure to apply.</p> <p>MVN Awinda: Make sure that no Synchronization settings have been saved to the Awinda station</p>
Directly after the T-pose calibration, the axes of rotation of the subject do not correspond with 3D character.	<p>Place MT on the pelvis flat on the sacral bone with Z axis pointing away from subject.</p> <p>Magnetic field is too disturbed at calibration. Use the 'Show Magnetic Disturbance' option in the preview window to find a proper location (no red spots in 3D viewport) (Section 19.2.1).</p>
Character sticks to the ground or segments are pulled apart (wrongly detected contacts).	<p>Enter correct body dimensions of subject (Section 8.1).</p> <p>Perform new calibration pose.</p> <p>Choose suitable user scenario (default is flat ground assumption) (Section 7.2.12).</p> <p>Make sure the feet trackers are mounted rigidly.</p>
Character appears to bounce slightly when no movement is taking place.	<p>This is likely to be caused by visualization rather than data issues. Can result when tile size on the floor in MVN Studio is large.</p> <p>Verify that the character is not moving using position data (eg graphical representation) to ensure that no movement is being detected. The position data should remain unchanged.</p> <p>When this is the case, make the tile size smaller, usually 50cm is a good tile size for visualization. To do this, go to >Options >Preferences >Interface > 3D View</p>
Shadows have jerky movements, even when character remains unmoving.	<p>Visualization issue, probably caused by floor tile size being too large, meaning that the shadow is redrawn too frequently. Decrease the size of the tiles to reduce this visualization effect.</p>
Pelvis is displayed too high.	<p>MVN file is recorded with old version of MVN Studio. Make a copy of the original file and reprocess (Section 10.3.2.7).</p>
Pelvis is displayed too low.	<p>Use MVN Studio v2.0 or higher to play the MVN file.</p>
The system does not run in real-time.	<p>Close all other running application.</p> <p>Check wireless connection (maximum range and disable other wireless equipment).</p> <p>Reduce the display frame rate and/or update rate.</p>



Problem	Solution
	See Section 19.13 for the specification of the recommended computer system.
During recording, the rotations of some segments do not correspond with the 3D character.	<p>Check if MT's have not moved in the suit. Perform a new calibration.</p> <p>Move calmly for 10-20 seconds directly after calibration.</p> <p>Check for magnetic disturbance (Section 19.2).</p> <p>Stand still and perform a Character Reset (Ctrl+Alt+F).</p>
During recording, the rotations of some segments are not smooth.	<p>Check wireless connection.</p> <p>Sensors clipped. Use 'Correct sensor clipping data on reprocess' option in >Options >Preferences >General >Recordings. Reprocess file.</p> <p>Check for magnetic field disturbance (Section 19.2).</p> <p>Stand still and perform a Character Reset (Ctrl+Alt+F).</p> <p>With MVN Awinda: Change the radio channel (See 19.12.1) Verify that this is also the case with a saved and reprocessed file (which will also contain retransmitted data)</p>
Graphical performance of MVN Studio is poor; update of image is slow	Set display frame rate to the same rate as the update rate in the preferences menu.
Avatar/ system drops from MVN Studio	This may be due to network configurations. Uninstall the network driver for the active Ethernet connection (through your device manager) then reinstall.
 <p>With MVN Awinda there appears to be a large latency</p>	Change the radio channel. (See 19.12.1)
 <p>MTw LED shows dual blink pattern</p>	This does not happen often, if it does it means that the MTw has crashed. To restore to normal, switch it off, by pressing the button for 6s. Press it for 1s to turn it back on.
 <p>When connecting 2 or more MVN Awinda systems, MTw's assign to the wrong awinda station</p>	<p>Begin by connecting one Awinda station and turn on the MTw's for the system associated with this receiver. Select the system under Accepted Systems and change the Wifi Radio channel in the Hardware Status window to allow all of the MTw's to connect.</p> <p>Once the system is detected, repeat this process with the second and additional systems.</p>



xsens

Problem	Solution
 Character walks in place or is seen flying across the screen	Check to make sure that all trackers are in the correct locations
 The battery from one MTw tracker drains much faster than the other trackers	Contact support www.xsens.com/support for assistance.
MVN Studio fails to connect with suit. Error code #40	Contact support www.xsens.com/support for assistance.



17 Warranty and liability

Xsens Technologies B.V. warrants the products manufactured by it to be free from defects in material and workmanship for a period of 2 years from the date of delivery. Products not subjected to misuse will be repaired, replaced or credit issued at the sole option of Xsens Technologies B.V. Contact support: www.xsens.com/support for return material authorization (RMA) prior to returning any items for calibration, repair or exchange. The product **must be returned in its original packaging** to prevent damage during shipping.

The warranty shall not apply to products repaired or altered or removed from the original casing by others than Xsens Technologies B.V. so as, in Xsens Technologies B.V. opinion, to have adversely affected the product, products subjected to negligence, accidents or damaged by circumstances beyond Xsens Technologies B.V.'s control.

NOTE: Xsens reserves the right to make changes in its products in order to improve design, performance, or reliability.

Subject to the conditions and limitations on liability stated herein, Xsens warrants that the Product as so delivered shall materially conform to Xsens' then current specifications for the Product, for a period of one year from the date of delivery. ANY LIABILITY OF XSENS WITH RESPECT TO THE SYSTEM OR THE PERFORMANCE THEREOF UNDER ANY WARRANTY, NEGLIGENCE, STRICT LIABILITY OR OTHER THEORY WILL BE LIMITED EXCLUSIVELY TO PRODUCT REPAIR, REPLACEMENT OR, IF REPLACEMENT IS INADEQUATE AS A REMEDY OR, IN XSENS' OPINION IMPRACTICAL, TO REFUND THE PRICE PAID FOR THE PRODUCT. XSENS DOES NOT WARRANT, GUARANTEE, OR MAKE ANY REPRESENTATIONS REGARDING THE USE, OR THE RESULTS OF THE USE, OF THE PRODUCT OR WRITTEN MATERIALS IN TERMS OF CORRECTNESS, ACCURACY, RELIABILITY, OR OTHERWISE. Xsens shall have no liability for delays or failures beyond its reasonable control.

17.1 Customer Support

Xsens Technologies B.V. is glad to help you with any questions you may have about MVN or about the use of the technology for your application. Please contact Xsens Customer Support:

- by e-mail: www.xsens.com/support
- telephone: Xsens HQ +31 88 97367 00 / Xsens US office 310-481-1800

To be able to help you, please mention the 8-digit number on the Xsens Sticker, you can find this at the handle of the Suitcase or backpack.



18 Regulatory Notices MVN Awinda

18.1 Radio Frequency Exposure and Emission

The MTw2, Awinda dongle and station contains a small radio transmitter and receiver. During communication with the Awinda Master it receives and transmits radio frequency (RF) electromagnetic fields (microwaves) in the frequency range 2400 of 2500 MHz. The output power of the radio transmitter is very low. When using the system, you will be exposed to some of the transmitted RF energy. This exposure is well below the prescribed limits in all national and international RF safety standards and regulations.

Most modern electronic equipment, for example, in hospitals and cars, is shielded from RF energy. However, certain electronic equipment is not. Therefore:

Note: This equipment emits RF energy in the ISM (Industrial, Scientific and Medical) band. Please insure that all medical devices used in proximity to this device meet appropriate susceptibility specifications for this type of RF energy (CE or FCC marked).

Turn off this electronic device before entering an area with potentially explosive atmosphere. It is very rare, but any electronic device could generate sparks. Sparks in such areas could cause an explosion or fire resulting in bodily injury or even death. Areas with a potentially explosive atmosphere are often, but not always, clearly marked. They include fuelling areas, such as petrol station, below deck on boats, fuel or chemical transfer or storage facilities, and areas where the air contains chemicals or particles, such as grain, dust, or metal powders.

18.2 FCC Statements

This equipment has been tested and found to comply with the limits for a Class B digital device, pursuant to Part 15 of the FCC Rules. These limits are designed to provide reasonable protection against harmful interference in a residential installation. This equipment generates, uses and can radiate radio frequency energy and, if not installed and used in accordance with the instructions, may cause harmful interference to radio communications. However, there is no guarantee that interference will not occur in a particular installation. If this equipment does cause harmful interference to radio or television reception, which can be determined by turning the equipment off and on, the user is encouraged to try to correct the interference by one of the following measures:

- Reorient or relocate the receiving antenna.
- Increase the separation between the equipment and receiver.
- Connect the equipment into an outlet on a circuit different from that to which the receiver is connected.
- Consult the dealer or an experienced radio/TV technician for help.

FCC Caution: Any changes or modifications not expressly approved by the party responsible for compliance could void the user's authority to operate this equipment.

This device complies with Part 15 of the FCC Rules. Operation is subject to the following two conditions: (1) This device may not cause harmful interference, and (2) this device must accept any interference received, including interference that may cause undesired operation.



Radiation Exposure Statement for Awinda Station:

This equipment complies with FCC radiation exposure limits set forth for an uncontrolled environment. This equipment should be installed and operated with minimum distance 20cm between the radiator & your body.

This transmitter must not be co-located or operating in conjunction with any other antenna or transmitter.

This MVN Awinda product contains

FCC ID:	MTw2:	QILMTW2-3A7G6
	Awinda Station:	QILAW-A2
	Awinda Dongle:	QILAW-DNG2



XSENS

18.3 Declaration of Conformity

18.3.1 CE Declaration of Conformity MTw2, Awinda Station, Awinda Dongle

RF_061, Issue 04



XSENS

EC Declaration of Conformity

Hereby,

Name of manufacturer: Xsens Technologies B.V.
 Address: Pantheon 6a
 City: Enschede
 Country: The Netherlands

declares that this equipment:

Product description: Wireless Motiontracker system
 Type designation(s): MTW2-3A7G6, AW-A2, AW-DNG2
 Trademark: MVN Awinda

is in compliance with the essential requirements and other relevant provisions of Directive 1999 / 5 / EC

with reference to the following standards:

EN 300 440-2 V1.4.1
EN 301 489-1 V1.9.2
EN 301 489-17 V2.2.1
EN 60950-1: 2010

Date: May 27, 2015
 City: Enschede
 Name: Per Slycke
 Signature: 



18.3.2 FCC Declaration of Conformity MTw2

DECLARATION OF CONFORMITY (DoC)

Equipment: Wireless Awinda Sensor
Trademark(s) and Model(s): MVN Awinda MTW2-3A7G6
Manufacturer: Xsens Technologies B.V.
FCC ID in case other parts of this equipment are subject to certification: QILMTW2-3A7G6

This device complies with Part 15 of the FCC Rules.

Operation is subject to the following two conditions:

- (1) this device may not cause harmful interference, and
- (2) this device must accept any interference received, including interference that may cause undesired operation.

The following test reports are subject to this declaration:

Test report number: Issue date:
20153144305 Ver 1.00 6/8/2015

The following manufacturer/importer/entity is responsible for this declaration:

Company name: Xsens Technologies B.V.
Name/Title: Per Slycke CTO
Address: Pantheon 6a, 7521 PR Enschede, The Netherlands
Phone: +31(0)889736700
Fax: +31(0)889736701
E-mail: Per.Slycke@Xsens.com
Date: 23/06/2015
Signature: 



18.3.3 FCC Declaration of Conformity Awinda Station

DECLARATION OF CONFORMITY (DoC)

Equipment: Wireless Awinda Station
Trademark(s) and Model(s): MVN Awinda AW-A2
Manufacturer: Xsens Technologies B.V.
FCC ID in case other parts of this equipment are subject to certification: QILAW-A2

This device complies with Part 15 of the FCC Rules.

Operation is subject to the following two conditions:

- (1) **this device may not cause harmful interference, and**
- (2) **this device must accept any interference received, including interference that may cause undesired operation.**

The following test reports are subject to this declaration:

Test report number: Issue date:
20153144303 Ver 1.00 6/8/2015

The following manufacturer/importer/entity is responsible for this declaration:

Company name: Xsens Technologies B.V.
Name/Title: Per Slycke CTO
Address: Pantheon 6a, 7521 PR Enschede, The Netherlands
Phone: +31(0)889736700
Fax: +31(0)889736701
E-mail: Per.Slycke@xsens.com
Date: 23/06/2015
Signature: 



18.3.4 FCC Declaration of Conformity Awinda Dongle

DECLARATION OF CONFORMITY (DoC)

Equipment: **Wireless Awinda Dongle**
Trademark(s) and Model(s): **MVN Awinda AW-DNG2**
Manufacturer: **Xsens Technologies B.V.**
FCC ID in case other parts of this equipment are subject to certification: **QILAW-DNG2**

This device complies with Part 15 of the FCC Rules.

Operation is subject to the following two conditions:

- (1) this device may not cause harmful interference, and**
- (2) this device must accept any interference received, including interference that may cause undesired operation.**

The following test reports are subject to this declaration:

Test report number: **20153144304 Ver 1.00** Issue date: **6/8/2015**

The following manufacturer/importer/entity is responsible for this declaration:

Company name: **Xsens Technologies B.V.**
Name/Title: **Per Slycke CTO**
Address: **Pantheon 6a, 7521 PR Enschede, The Netherlands**
Phone: **+31(0)889736700**
Fax: **+31(0)889736701**
E-mail: **Per.Slycke@Xsens.com**
Date: **23/06/2015**
Signature: 



19 Appendices

19.1 Lycra suit sizes overview

Table 7 is an overview of the typical height and weight of a subject that will fit into a given suit size. While this is generally accurate, it is an indication, therefore test the suit size, to ensure that it is tight enough to keep MTx's in place during measurement while remaining relatively comfortable.

Table 7: MVN Lycra Suit sizes

Size	Body height		Weight	
S	1.55 - 1.65 cm	5'1" - 5'4" ft.	50 – 65 kg	110 – 143 lbs.
M	1.65 - 1.70 cm	5'4" - 5'6" ft.	65 – 75 kg	143 – 165 lbs.
L	1.70 - 1.80 cm	5'6" - 5'9" ft.	75 – 85 kg	165 – 187 lbs.
XL	1.80 - 1.95 cm	5'9" - 6'4" ft.	85 – 95 kg	187 – 210 lbs.
XXL	Up	Up	Up	Up

19.2 Magnetic Disturbances

A common problem with inertial and magnetic sensing is the presence of large ferromagnetic objects which may distort the detected magnetic field and change the perceived global north. MVN Studio has a few functionalities built in, which can be used to prevent magnetic disturbance from disturbing measurements. These features include the ability to view magnetic field distortion on the 3D animated character. This is available live and on a recorded file. Additionally, on a recorded file, the magnetic field can be seen graphically, or exported in the MVNX file for further checks.

19.2.1 Show magnetic disturbance

To determine the most appropriate location for your experiments or evaluate unexpected performance, visualize disturbances in the magnetic field. Magnetic field properties are visualized by circles around the hands, pelvis and feet in the 'Preview & Recording' window, at calibration stage (see Figure 62). Most unknown disturbances are usually present in the floor (iron reinforced concrete structures), for this reason, during the preview and recording stage, only the magnetic indicators at the feet are shown.

The color of the circle is a measure of the magnitude of the disturbance. The magnitude is based on average magnetic field properties (such as the strength and dip angle) of all MT's. There are three indicator colors:

- **Green:** the magnetic field at the MT is suitable to perform a calibration
- **Yellow:** the magnetic field is disturbed, if possible look for another location
- **Red:** the magnetic field is too disturbed to perform a calibration

The spheres can be switched on or off by clicking the show/hide magnetic disturbances icon.



Choose whether or not to always show or hide the magnetic disturbance indicators at >Options >Preferences >Interface >Character >Display magnetic disturbances.

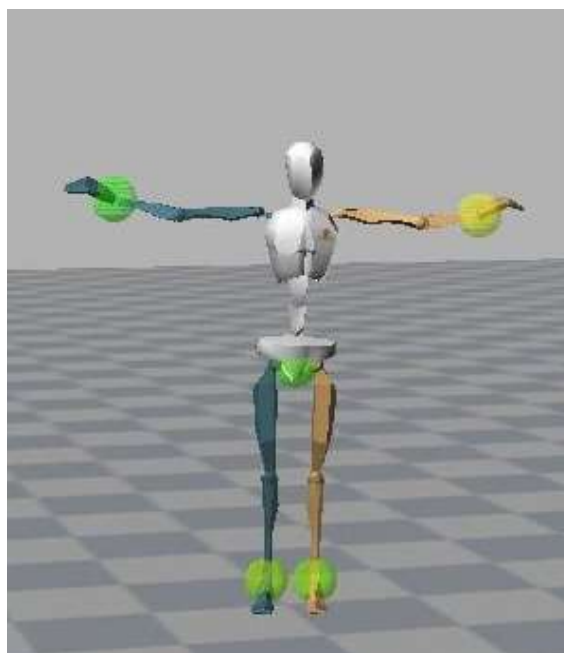

Figure 62: Show magnetic disturbances

In Figure 62, the MT on the left hand shows a warning and is probably close to a wall or an iron object. The rest of the circles are green which indicates that the magnetic field is suitable to perform a calibration. The advice is to move to a different location in such way that the red circle becomes yellow or (preferably) green.

When some circles are green and some are yellow or red, try to find a spot in the room or building where the red circles disappear. When the red circles around the feet remain at all locations, you can step onto an object to gain some distance from the floor (e.g. you can use the MVN suit case) and perform a calibration. After the calibration you can then step on to the floor and work there for quite some time before performance degrades. When all circles are red and remain red when walking around, the room or building is not suitable for capturing with MVN. This is extremely rare. Try to use another location if possible.

When a circle turns red for a short period; it indicates that the field is locally disturbed. The MVN Fusion Engine offers a high grade of rejection against temporary disturbances and you can continue with recording without worrying.

19.2.2 Magnetic Norm

Since MVN Studio 3.1.5, it has been possible to view the magnetic field norm in the graphs. This is found in > Sensor data > Magnetic Field and is represented by the black line in the graph.

Magnetic norm facilitates the finding of a magnetically sound environment needed for calibrations and preferred for measurements.

Note: Mag Field Norm is not an exported value. However it can be calculated as follows:

$$\text{Mag Field Norm} = \text{squareroot}(x^2 + y^2 + z^2)$$

The following figures and explanations show how best to use the Magnetic Field Norm data in a practical situation. The upper graph of both Figure 63 and Figure 64 is the head, and the lower graph is of the



right foot. The lower graph coincides with the colored indicators in the 3D and orthogonal views of MVN Studio, when the magnet icon is active.

As Figure 63 shows, the magnetic field indicators are green; this is represented as a line close to zero in the Mag Field Norm plots shown for the head and the right foot. This shows that the magnetic field is sound for measuring.

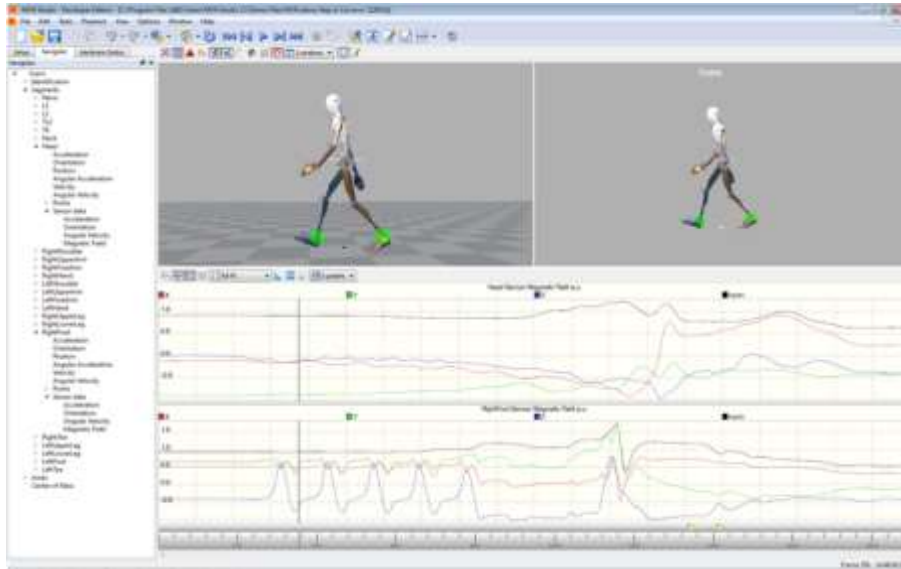

Figure 63: Mag Field Norm coincides with green Mag Field indicators. Top graph is Mag Field of the MT on the Head. Bottom graph is MT on the Right Foot.

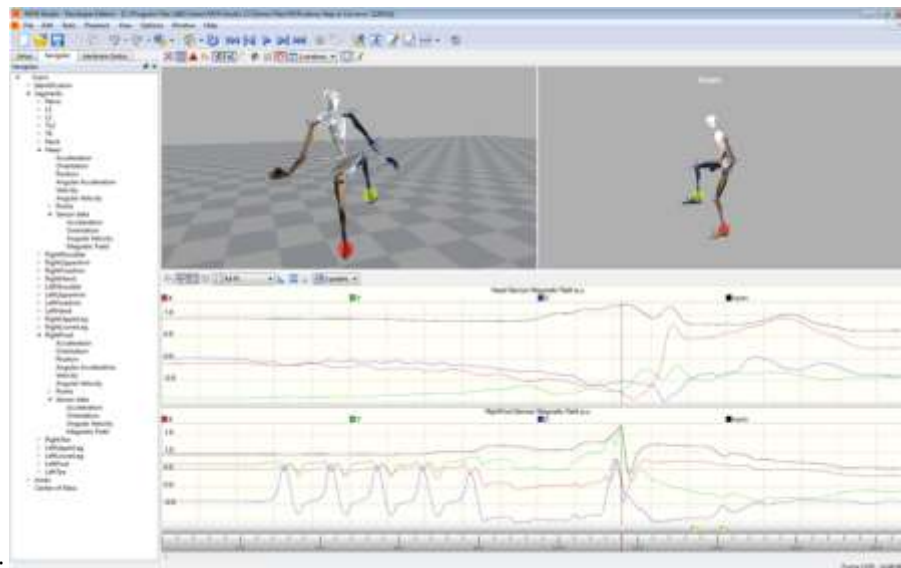

Figure 64: Mag Field Norm coinciding with red Mag Field indicators. Top graph is Mag Field of the MT on the Head. Bottom graph is MT on the Right Foot.



From the same recording, Figure 64 shows that when the subject has moved, they have approached a ferromagnetic material. This is known because the Mag Field Norm increases, in particular for the right foot, as it increases above 1.5. If this value increases further and remains high for longer than a few 30 seconds (usually less than 2 can be dealt with in the algorithms used in MVN Studio) then this area should be avoided, in particular during calibrations, but if possible, also during measurements.

19.3 MVN kinematics and output

19.3.1 Quaternion orientation representation

A unit quaternion vector can be interpreted to represent a rotation about a unit vector \mathbf{n} through an angle α .

$${}^{GB}q = \left(\cos\left(\frac{\alpha}{2}\right), \mathbf{n} \sin\left(\frac{\alpha}{2}\right) \right)$$

A unit quaternion itself has unit magnitude, and can be written in the following vector format:

$$q = (q_0, q_1, q_2, q_3)$$

$$\|q\| = 1$$

Quaternions are an efficient, non-singular description of 3D orientation and a quaternion is unique up to sign:

$$q = -q$$

An alternative representation of a quaternion is as a vector with a complex part, the real component is the first element q_0 .

The inverse ${}^{BG}q$ is defined by the complex conjugate $*$ of ${}^{GB}q$:

$${}^{GB}q^* = (q_0, -q_1, -q_2, -q_3) = {}^{BG}q$$

As defined here, ${}^{GB}q$ rotates a vector ${}^B\mathbf{x}$ in the body co-ordinate system (B) to the global reference co-ordinate system (G).

$${}^G\mathbf{x} = {}^{GB}q \otimes {}^B\mathbf{x} \otimes {}^{GB}q^* = {}^{GB}q \otimes {}^B\mathbf{x} \otimes {}^{BG}q$$

Where \otimes represents a quaternion multiplication:

$$q1 \otimes q2 = (q1_0 \cdot q2_0 - v1 \cdot v2, q1_0 \cdot v2 + q2_0 \cdot v1 + v1 \times v2)$$

with:

$$v1 = (q1_1, q1_2, q1_3)$$

$$v2 = (q2_1, q2_2, q2_3)$$

and both \cdot and \times represent the standard dot and cross product, respectively. Be aware that the order of multiplication is important. Quaternion multiplication is not commutative, meaning:

$$q1 \otimes q2 \neq q2 \otimes q1$$

19.3.2 Conversions

Quaternion to rotation matrix:



$$\mathbf{R} = \begin{bmatrix} q_0^2 + q_1^2 - q_2^2 - q_3^2 & 2q_1q_2 - 2q_0q_3 & 2q_1q_3 + 2q_0q_2 \\ 2q_1q_2 + 2q_0q_3 & q_0^2 - q_1^2 + q_2^2 - q_3^2 & 2q_2q_3 - 2q_0q_1 \\ 2q_1q_3 - 2q_0q_2 & 2q_2q_3 + 2q_0q_1 & q_0^2 - q_1^2 - q_2^2 + q_3^2 \end{bmatrix}$$

$$= \begin{bmatrix} 1 - 2q_2^2 - 2q_3^2 & 2q_1q_2 - 2q_0q_3 & 2q_1q_3 + 2q_0q_2 \\ 2q_1q_2 + 2q_0q_3 & 1 - 2q_1^2 - 2q_3^2 & 2q_2q_3 - 2q_0q_1 \\ 2q_1q_3 - 2q_0q_2 & 2q_2q_3 + 2q_0q_1 & 1 - 2q_1^2 - 2q_2^2 \end{bmatrix}$$

For further information on quaternion operations and rotations, refer to the book: *J.B. Kuipers. Quaternions and Rotation Sequences. Princeton University.*

19.4 Body planes

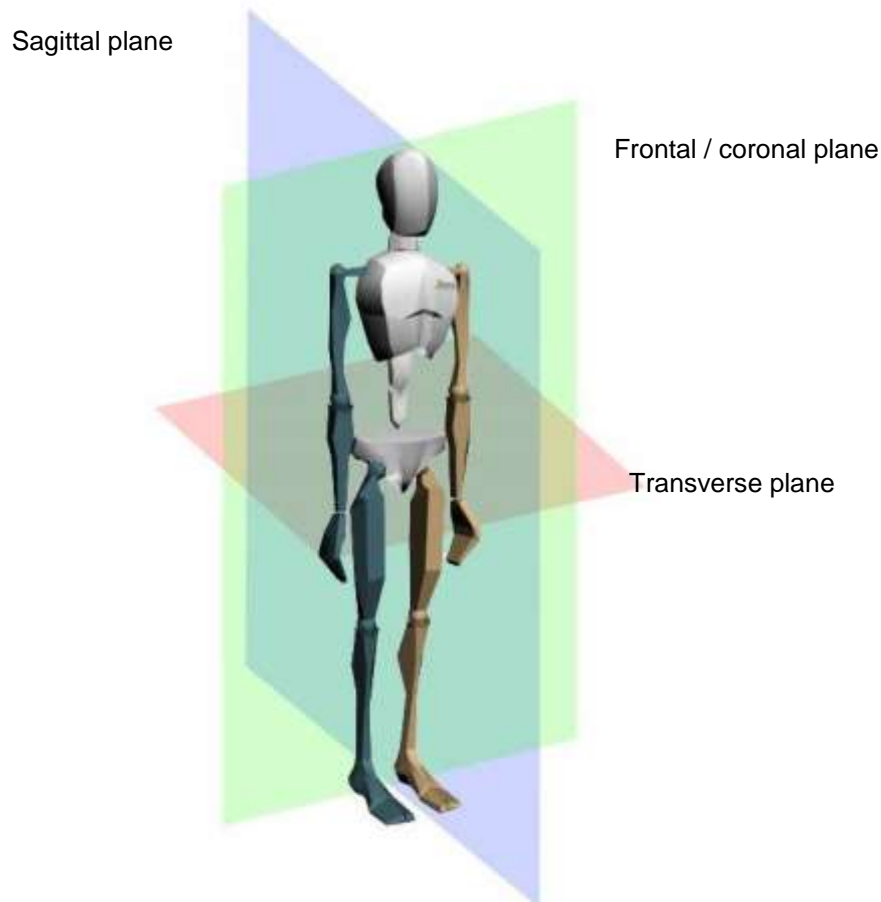

Figure 65: Body planes

19.5 Coordinate systems

The MVN Fusion Engine calculates the position and orientation, and other kinematic data of each body segment, B , with respect to an earth-fixed reference co-ordinate system, G . By default the earth-fixed reference co-ordinate system used is defined as a right handed Cartesian co-ordinate system with:



Global reference frame:

X positive when pointing to the local magnetic North (red).

Y according to right handed co-ordinates (West) (green).

Z positive when pointing up (blue).

Local coordinate frame:

Body: segments in anatomical pose:

- Origin: center of rotation (proximal)
- X forward.
- Y up, from joint to joint.
- Z pointing right.

This difference in coordinate systems will not affect results.

After the calibration procedure, the right heel of the character is set at the origin (0,0,0). This is the begin point of the red arrow in the 3D viewport (pointing in the positive X-direction).

The orientation output is represented using quaternions. The definition of the segment co-ordinate system can be found in Section 19.6. Joint origins are determined by the anatomical frame and are defined in the center of the functional axes with the directions of the X, Y and Z being related to functional movements. For example, flexion/extension of the knee is described by the rotation about the ^BZ-axis of the lower leg with respect to the upper leg; abduction/adduction is the rotation about the ^BX-axis; and endo/exo rotation is about the ^BY-axis. Note that in some studies, different anatomical and reference frames definitions are used; to compare results proper co-ordinate frame transformations must be performed.

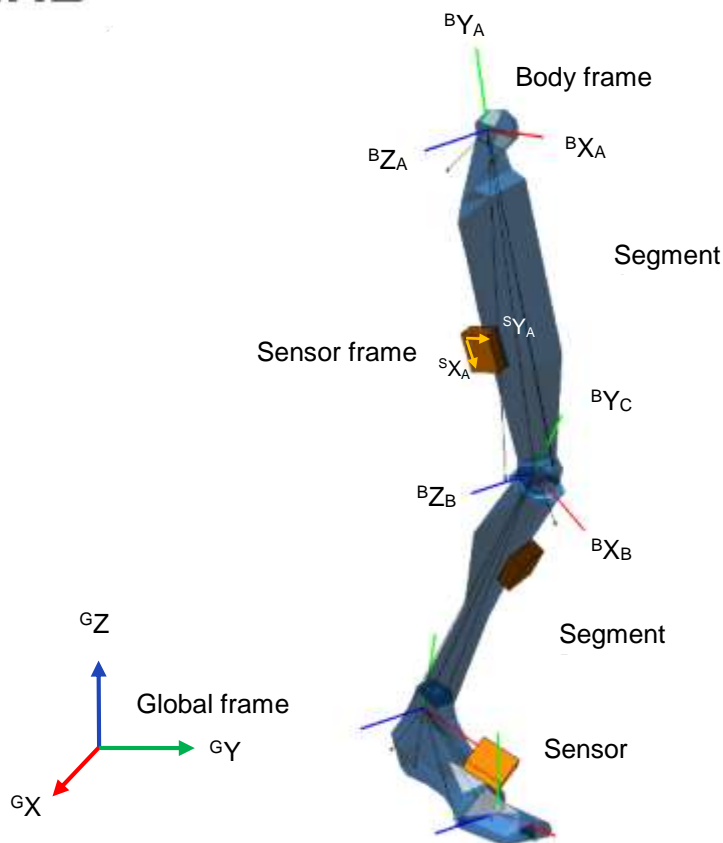

Figure 66: Global and local coordinate frames in MVN Studio

19.6 Anatomical model

19.6.1 Definition of segment axes

To describe motion capture data in clinically meaningful data, e.g. joint rotations, it is necessary to define a coordinate reference frame attached to the body segment. The ISB proposal for standardization for joint coordinate systems is currently based on positions (optical markers) of bony landmarks. For most segments on the body, the origin of the reference frame and direction of axes are described in Wu and Cavanagh (1995) ^[i] Wu et al. (2002) ^[ii] and Wu et al. (2005) ^[iii]. The MVN Fusion Engine uses the calibration poses to determine the direction of the axes of each segment. Figure 67a shows the origins of the segment axes in the neutral anatomical pose. The origin of the segment is always in the proximal joint center which is the functional rotation point. The origin is chosen such that by connecting all joint centers a character (skeleton) is formed, see Figure 67b. Their positions for the calibration poses in the global reference frame can be found in the <segments>section and <frame type="tpose/npose"> when exporting as MVNX file.



19.6.2 Bony/anatomical landmarks

The positions of bony/anatomical landmarks with respect to the joint origin of the related segment are presented in the MVNX file, see the <points>tag in the <segment>section. Segments are assumed to be rigid bodies.

Positions of anatomical landmarks in the global frame (G) can be found by rotating the vector of the landmark in the body frame (B) to the global frame and adding the global position of the origin.

$${}^G \mathbf{p}_{landmark} = {}^G \mathbf{p}_{origin} + {}^{GB} \mathbf{q} \otimes {}^B \mathbf{x} \otimes {}^{GB} \mathbf{q}^*$$

Or in rotation matrix formulation:

$${}^G \mathbf{p}_{landmark} = {}^G \mathbf{p}_{origin} + {}^{GB} \mathbf{R} \cdot {}^B \mathbf{x}$$

The rotation from body to global (${}^{GB} \mathbf{q}$) and global position of the origin (${}^G \mathbf{p}_{origin}$) are given in the MVNX file, see next section.

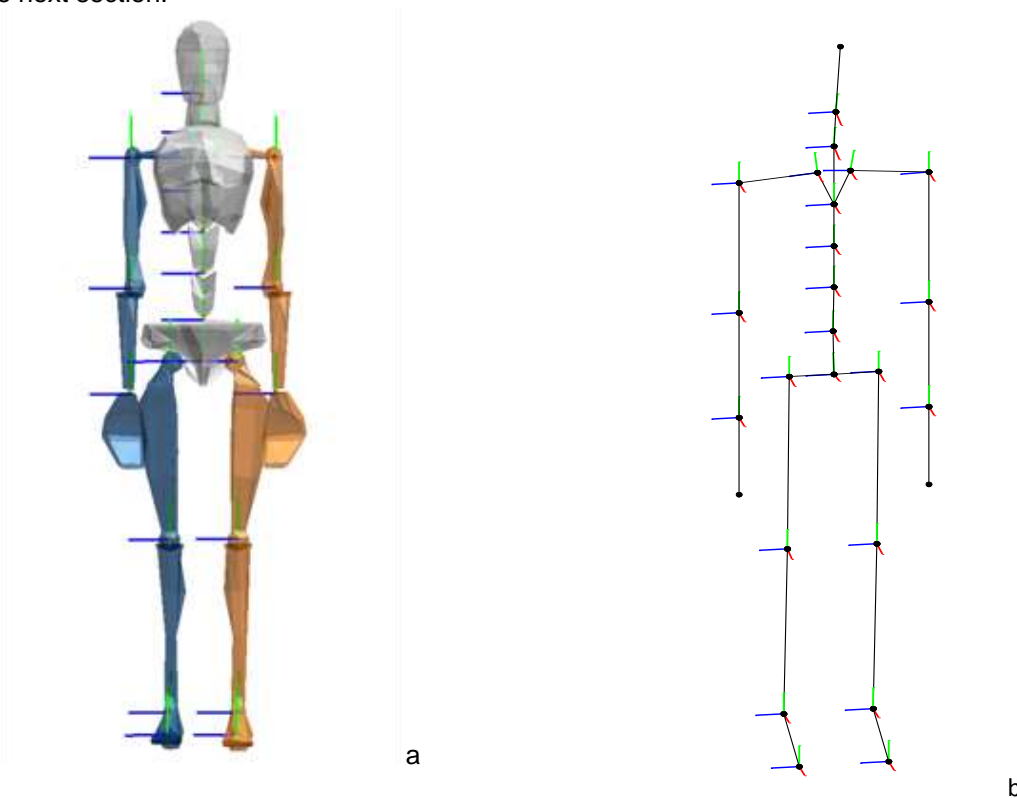
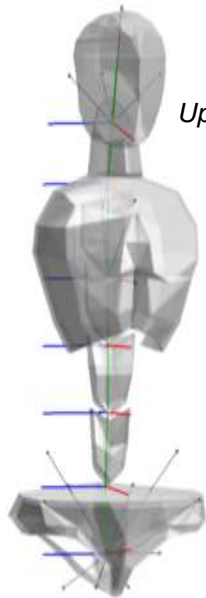

Figure 67: a) Segment coordinate system at each joint origin, as is used in MVN. b) Joint centers connected, forming a skeleton Legend: x: red, y: green, z: blue

Note that positions of anatomical landmarks are not measured directly as they are with optical measurement systems. They are computed using the measured accelerations, angular velocities and rotations in combination with the biomechanical model. Relevant points are used for the detection of contacts with the external world and as an indication for scaling of segment lengths.

The MVN character mesh (only for visualization) is an abstract representation of the human skeleton; therefore not all anatomical landmarks are exactly on the mesh. The ribcage is connected to T8 and will move accordingly.



Upper body

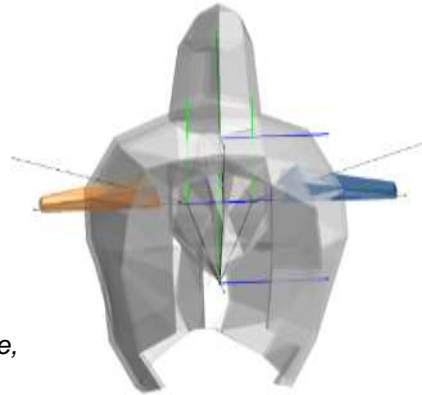

*T8, ribcage,
neck and
shoulders*

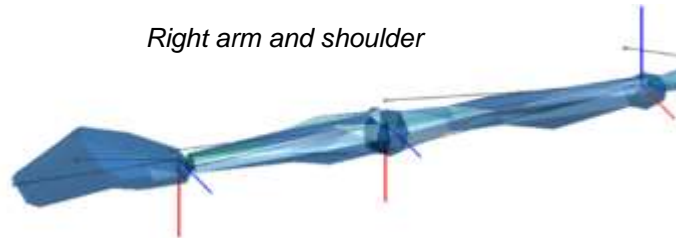

Right arm and shoulder

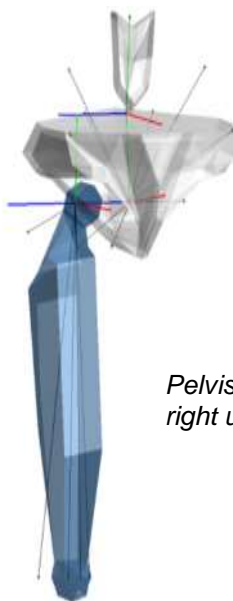

*Pelvis, L5 and
right upper leg*



*Left leg and
foot*

19.7 Segment axes definitions and Origin Definitions

Note: To ease comparison between the MVN segment co-ordinate systems with the International Society of Biomechanics recommendation, currently based on optical position tracking systems, the ISB recommendation is presented next to the MVN definition.

The MVN segment axes definition and origins have been chosen as closely as possible to the ISB recommendation where whenever possible.

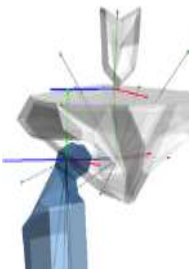
		MVN	ISB [ij]
	O	Midpoint between right and left hip center of rotation	Coincident with hip center of rotation
	X	Perpendicular to Y and Z Pointing forward	Line parallel to a line lying in the plane defined by two ASISs and midpoint of two PSIS, orthogonal to Z-axis. Pointing anteriorly.
	Y	hipOrigin to jL5S1 Pointing up	Line perp. to X and Z. Pointing cranially. (Della Croce et al. ^[iv])
Z	to jLeftHip to jRightHip Pointing right	Line parallel to a line connecting right and left ASISs. Pointing right.	

NB: Della Croce et al. ^[iv] define O as the midpoint between RASIS and LASIS

19.7.1 Spinal segments: L5, L3, T12, T8: Segments 2-5

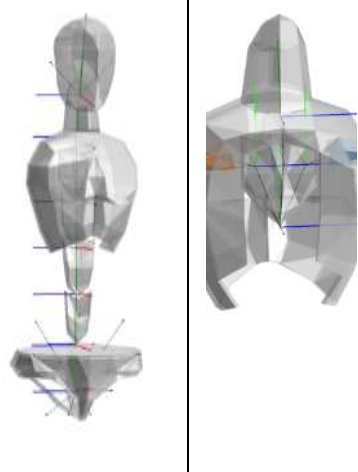
		MVN	ISB [ij]
	O	jL5S1, jL4L3, jL1T12, jT9T8	
	X	Pointing forward	Line per. Y and Z
	Y	Joint to Joint Pointing up	Line passing thru centers of vertebra's upper and lower endplates
Z	Perp. to X and Y Pointing right	Line parallel to a line joining similar landmarks on the bases and right and left pedicles	

Note: Spine segments not measured directly in MVN, they are interpolated between the MT's of the Pelvis, Sternum and Head using a model of the spine. Joint origins are the rotation points in the vertebrae.

19.7.2 Neck: Segment 6

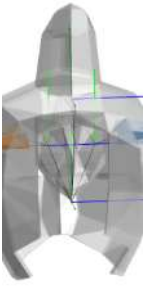
		MVN	ISB
	O	jT1C7	Not described in ISB
	X	Perp. to Y and Z Pointing forward	
	Y	jT1C7 to jC1Head	
	Z	Pointing right	

Note: The neck segment is not measured directly in MVN; it is calculated using a model of the neck.

19.7.3 Head: Segment 7

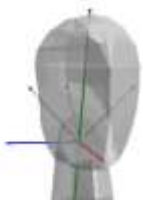
		MVN	ISB
	O	jC1Head	Not described in ISB
	X	Perp. to Y and Z	
	Y	jC1Head to TopOfHead	
	Z	Left Ear to Right Ear	

Note: Position of Ears are not measured but assumed to be on the same height.

19.7.4 Shoulder: Segment 8 Right and Segment 12 Left

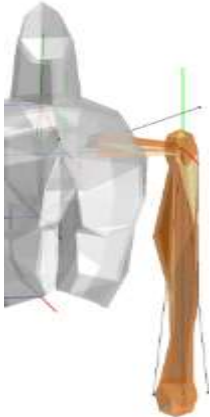
		MVN	ISB
	O	jRightC7Shoulder jLeftC7Shoulder	See Wu et al. [iii] and Šenk et al. v for range of definitions.
	X	Pointing forward	
	Y	Perp. to X and Z	
	Z	Right: jRightC7Shoulder to jRightShoulder to Left: jLeftC7Shoulder to jLeftC7	

In ISB the shoulder complex is described with the Thorax, Clavicle, Scapula and Humerus. MVN does not define the thorax segment. The thorax region is split into spine segments. The mesh of the thorax

will move with segment T8 which is measured with the MT of the sternum. MVN does not measure the clavicle and is undefined in MVN.

19.7.5 Upper Arm (Humerus): Segment 9 Right and Segment 13 Left

There are two segment coordinate systems described in ISB. The system described below is option 1.

		MVN	ISB [iii]
	O	jRightUpperArm GH jLeftUpperArm GH	GH
	X	Sagittal plane Pointing forward	Line perp. Plane EL-EM-GH Pointing forward
	Y	Right: jRightElbow to jRightShoulder Left: jLeftElbow to jLeftShoulder	Line connecting GH to mid point EL-EM Pointing to GH
	Z	Perp. to X and Y Pointing to the right	Line perp. Y and Z Pointing to the right

19.7.6 Forearm (Radius/Ulna): Segment 10 Right and Segment 14 Left

There are two segment coordinate system described in ISB. Option 1 is described here.

		MVN	ISB [iii]
	O	jRightElbow jLeftElbow	US
	X	Pointing forward	Line Perp. plane thru US-RS and midpoint EL-EM Pointing forward
	Y	Right: jRightWrist to jRightElbow Left: jLeftWrist to jLeftElbow	Line connecting GH to mid point EL-EM
Z	Perp. to X and Y Pointing right	Line perp. X and Y	

Note: The joint origin is the midpoint between the epicondyles in MVN. In the anatomical pose, the hand and forearm are orientated forward

19.7.7 Hand: Segment 11 Right and Segment 15 Left

		MVN	ISB [iii]
	O	jRightWrist jLeftWrist	ISB defines origins and axes for each: Of the 5 Metacarpals 14 phalanges
	X	Pointing forward	
	Y	Top of Hand to jRightWrist/jLeftWrist Pointing Vertical	
	Z	Perp. to X and Y Pointing right	

Note: In MVN, the joint center is the midpoint between the styloids.

No metacarpals are measured in MVN.

This description is for the anatomical pose. When the subject stands in the N-pose, X will no longer point anteriorly, but medially.

19.7.8 Upper Leg (Femur): Segment 16 Right and Segment 20 Left

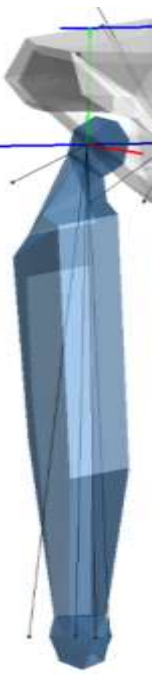
		MVN	ISB [ii]
	O	jRightHip/jLeftHip	(Only defined for use of calculating the hip joint angle): Coincident with right (or left) hip center of rotation, coincident with pelvic center O in neutral configuration
	X	Perpendicular to Y and Z Pointing forward in sagittal plane	Line perp. to Y- and x- Pointing anteriorly. (Della Croce et al. [iv])
	Y	Right: jRightKnee to jRightHip Left: jLeftKnee to jLeftHip	Line joining midpoint between medial and lateral Fes and the origin. Pointing cranially
	Z	Right: Medial to Lateral Left: Lateral to Medial Pointing right	Line perp. to Y-axis lying in plane defined by origin and two Fes. Pointing Right.



Note: In ISB and MVN, the origin is in center of hip rotation, which is the head of the femur. Della Croce^[iv]: midpoint LE and ME. In the MVN model, the lateral and medial epicondyles are on the same height.

19.7.9 Lower Leg (Tibia/Fibula): Segment 17 Right and Segment 21 Left

		MVN	ISB^[ii]
	O	jRightKnee jLeftKnee IM	IM
	X	Perp. Y and Z Pointing forwards	Line perp. to torsional plane of tibia/fibula. Pointing anteriorly
	Y	Right: jRightAnkle to jRightKnee Left: jLeftAnkle to jLeftKnee	Line perp. to X and Z
	Z	Right: Medial to Lateral Left: Lateral to Medial Pointing right	Line between MM and LM. Pointing to the right

Note: In MVN, the joint center is approx. between LC and MC which corresponds with the center of rotation of the lower leg. Same coordinate system as Della Croce^[iv], except that the origin is not in IM. In ISB, the Y axis is not along the Tibia. In the MVN model the lateral and medial epicondyles and lateral and medial malleoli are the same height.

19.7.10 Foot (Calcaneus): Segment 18 Right and Segment 22 Left

		MVN	ISB ^[ii]
	O	jRightAnkle jLeftAnkle IM	IM
	X	Sagittal plane forward	Line perp. to frontal plane of tib/fib in neutral configuration. Pointing anteriorly.
	Y	Vertical (aligned with gravity, pointing up)	Line coincident with long axis of tibia/fibula, in neutral configuration. Pointing cranially
Z	Perp. to X and Y Pointing right	Line perp. to x- and Y-	

Note: In the MVN model lateral and medial malleoli are on the same height.

19.7.11 Toe: Segment 19 Right and Segment 23 Left

The toes are not defined in ISB.

		MVN	ISB
	O	jRightToe jLeftToe	The toes are not defined in ISB.
	X	Sagittal plane forward	
	Y	Vertical (aligned with gravity)	
	Z	Perp. to X and Y	

Note: In MVN toes are not measured directly but are based on the foot kinematics and contact detection. The origin is between the metatarsals of the foot. Toes can only flex and extend, other kinematics are due to interpolation.

19.8 Joint angles

Typically, a joint rotation is defined as the orientation of a distal segment ${}^{GB_B}q$ with respect to a proximal segment ${}^{GB_A}q$:

$${}^{B_A B_B}q = {}^{GB_A}q^* \otimes {}^{GB_B}q$$

where \otimes denotes a quaternion multiplication and $*$ the complex conjugate of the quaternion (see Section 19.3.1). There are a few commonly used parameterizations of the joint rotation ${}^{B_A B_B}q$ that describe joint angles:

- the Cardan/Euler representation [Cole 1993, Woltring 1994]
- joint coordinate system [Grood & Suntay 1983]^{vi}
- helical angle [Kinzel 1972]



Note that all representations of the joint angles are based on the same quaternion or rotation matrix. The differences lie only in how the angles are extracted (represented) from this rotation. The International Society of Biomechanics (ISB) has proposed standards for rotation sequences for the lower [Wu et al, 2002ii] and upper body [Wu et al 2005iii].

19.8.1 Euler Extractions for the joint angles

In order to produce validated joint angle output, Xsens MVN works closely to the ISB and Grood and Suntay recommendations [i,ii,iii,vi]. Almost all angles follow the ISB Euler angle extractions of Z (flexion/extension), X (abduction/adduction) Y (internal/external rotation). The definitions of the origins of the segments are somewhat different, since MVN uses MT's placed on the segment, rather than markers placed on bony landmarks. The origins and coordination axes are defined above.

19.8.2 Shoulder angle definitions

For joint angle calculations, the only difference for Euler extractions between MVN and ISB is for the shoulder joint. MVN provides three different shoulder angle calculations, as can be seen in the data tree, after a session has been recorded.

The shoulder joint angles provided are:

- Angles between C7 and the shoulder segment
- Euler rotation sequence ZXY
- Euler rotation sequence XZY



19.8.3 Joint angle outputs

Below is an overview of all joints available in MVN and a short description.

	Joint Angle (Tree name)	Description (& Euler Sequence)
1	L5S1	Joint between the lumbar spine segment 5 and sacral spine 1 (ZXY)
2	L4L3	Joint between the lumbar spine segment 4 and lumbar spine segment 3 (ZXY)
3	L1T12	Joint between the lumbar spine segment 1 and thoracic spine segment 12 (ZXY)
4	C1Head	Joint between the cervical spine segment 1 and the head segment (ZXY)
Left and Right		
5	C7Shoulder	Joint between cervical spine 7 and the MVN shoulder segment
6	Shoulder ZXY	Shoulder joint angle between the MVN shoulder segment and the upper arm; calculated using the Euler sequence ZXY
7	Shoulder XZY	Shoulder joint angle between the MVN shoulder segment and the upper arm; calculated using the Euler sequence XZY
8	Elbow	Joint between the upper arm and the forearm. (ZXY)
9	Wrist	Joint between the forearm and the hand. (ZXY)
10	Hip	Joint between the pelvis and upper leg. (ZXY)
11	Knee	Joint between the upper leg and lower leg. (ZXY)
12	Ankle	Joint between the lower leg and foot. (ZXY)
13	BallFoot	Joint between the foot and the calculated toe. (ZXY)



19.9 XKF-HM

Xsens Motion tracking works on the basis of Kalman Filtering. In its simplest form, it combines the different information sources to calculate the desired parameters. This has an impact on how the systems should be used. The more historically correct data has been measured (in good magnetic environments for example and with enough physical movement of the motion trackers) the more robust the filter can be. For this reason we advise to calibrate in a magnetically sound environment (See Section 3.4.1) and to “warm-up” the filters by moving casually for a short time, to build up this history (See below for settling time details).

With MVN Studio 4.0 and onwards, Xsens has created a special filter dedicated to accurately measuring human motion. This filter is called XKF-HM (Xsens Kalman Filter for Human Movement) and is based on a number of assumptions that humans will move with varying degree of speed, high and low accelerations, while assuming that the duration of accelerations will not be longer than is humanly possible.

The XKF-HM filter works well in a variety of environments and dynamics. This means that measurements can take place of movement that is semi-static up to high dynamics as well as being possible to stay in magnetically challenging environments for longer. This has been made possible due to the improved signal pipeline.

An important aspect of using any measurement apparatus is the scale of the sensor. Often, for example with a temperature sensor (thermometer!) when the range is exceeded, the sensor either breaks or simply can no longer measure outside of the defined range. With Xsens sensors, when the data exceeds the limits there is a potential of this influencing the calculated orientation and could last more than a few sample frames due to the history build up. However with the new algorithms this is completely prevented. Clipping is of course possible, when the range of the component is exceeded. However, the influence of this clipping is negligible. For the component itself, when the movement is back in range the measurement continues as normal and the calculated orientation returns to an accurate state immediately. It is also possible to observe when clipping occurred during recording, so that if this data is required it can be ignored. Furthermore in future releases this will be possible to reprocess and will have no effect (since both historical and future data are known in a recorded file).

Other remarks: Some amount of correction for the changing magnetic field is present in the new XKF, this is due to three things: the improved signal pipeline mentioned above, a new model that is used for modelling magnetic field behavior and compensation and that there is also some recalibration of the magnetic field taking place in this algorithm. This means that when a new magnetic environment is present, the filter understands that this is new and temporary and can compensate for this for a longer time.

19.9.1 Height tracking

Due to the many improvements, from signal processing to how data is handled in MVN Studio including foot contact detection, it is now possible to track height changes of a subject e.g. walking upstairs or up a steep slope while wearing the system. Please note that height changes due to e.g. changing floor level in an elevator will not be detected, since there is no relative change in motion of the body segments, in this case, it will appear that the subject stands still and continues on a level plane.

19.9.2 XKF-HM Settling time

Settling time is the time needed for the filters to “warm up”. When they are warmed up, information like gyroscope and magnetometer biases can be estimated and uncertainties minimized.

Tests have shown that the best practice for achieving a good settling time is to remain still for 30 seconds after the initial calibration (N or T pose).



If a reset is required during measurements, it is also advised that the subject stands still when the reset is enabled and remains still for 30 seconds thereafter. In these 30 seconds, the gyroscope biases are estimated and the uncertainties minimized.

If there are issues regarding problematic magnetic field distortions follow the instructions below:

1. Configure the system (see section 7.1).
2. Move all motion trackers in smooth 3D, circular motions. This can be done with hardware
 1. In the suitcase or rucksack, for approximately 3 minutes.
 2. On the subject for approximately 6 minutes.
3. Perform a basic calibration (N or T pose).
4. Stand still for 30 seconds.

19.10 Update Rate versus Sample Frequency

Since MVN Studio 4.0, Xsens refers to the term “update rate” rather than sample frequency. This is an intentional change in terminology since the data is sampled in a different way than in the past.

Normal, digital systems using some form of recording relies on sampling of this data. Since data is sampled, this implies some degree of data loss at those time instances that no sampling took place. Sampling must take place a measurable time, some amount of times over a given time frame. This is known as the sampling frequency. Most systems operate at a given sample frequency.

The intentional difference in terminology is needed to highlight that data from new Xsens motion trackers (MTx and MTw) undergoes a mathematical method called Strap Down Integration. This ensures that no loss of accuracy is experienced, even though the data is transmitted to the PC at lower update rates. Update rates as low as 20 or 30Hz still provides very accurate data.

19.11 Strap Down Integration

Strap down integration (SDI) is a method used to compute an orientation/position change given an angular velocity and linear acceleration of a rigid body. Angular velocity and acceleration data in the MTx and MTw is sampled at a very high frequency (1000Hz) to maintain accuracy under very dynamic conditions such as vibrations and impacts. The sampling frequency is too high to be transmitted wirelessly, and would typically present a computational load that is too high on the receiving host device (e.g. PC). Therefore the data that has been sampled at a high frequency is digitally filtered and down-sampled to 600 Hz and calibrated using the individual device calibration⁷ values on the embedded microprocessor (MCU) of the MTw. Based on this data the MTx and MTw further calculates velocity increments and orientation increments using an SDI algorithm. The main advantage of using the SDI algorithm is that full 3D tracking accuracy can be maintained even if the output update rate from the MTx and MTw is lower (<100 Hz). An additional advantage is that the MTx and MTw can continue to track the 3D motion internally when facing transient data loss in the RF transmission and immediately report the full 3D velocity and orientation increment as soon as the RF link is restored, without the need to re-transmit all the data that was lost which would a) cause a large delay during real-time tracking b) use a lot of precious RF bandwidth and consume unnecessary power. The specific use of SDI data in combination with such a specialized RF protocol, Xsens has named the Awinda protocol⁸.

19.12 The Awinda Protocol

The Awinda protocol is the wireless protocol that controls the data stream from the MTws to the Awinda Station or Awinda Dongle. This wireless protocol provides accurate time synchronization of up to 32

⁷ The devices are calibrated at the factory by Xsens and is a highly sophisticated process compensating for component errors that are not stochastic (i.e. they can be modeled). Compensation models include bias, gain, misalignment, g sensitivity, temperature effects, etc.

⁸ Patents pending.



MTw's across the wireless network to within 10 microseconds, achieving 'wired like' system performance. The Awinda protocol is developed such that no data is ever lost. If individual packets are missed, there is some room to contain data temporarily. This buffered data is then retransmitted. If these packets become lost (for example if the subject wearing the hardware is outside of the radio transmission range and for a prolonged period – meaning the buffer becomes full) then it is still possible to retrace the missing data due to the use of SDI. Retransmitted data is used during reprocessing, for this reason Awinda data can appear better – smoother and more accurate after reprocessing.

19.12.1 Choosing a Radio Channel for MVN Awinda

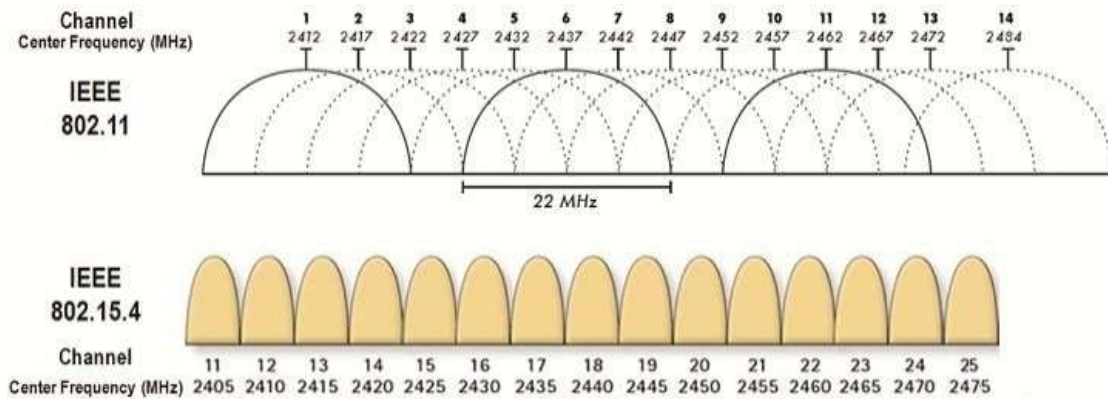

Figure 69: Overview of channels operating around 2.4GHz; for ease of channel selection

Figure 69 provides an overview of the allowed channels for operating MVN Awinda. The Awinda protocol is based on the IEEE 802.15.4, around 2.4 GHz. The bottom row of the figure shows the channels on the 2.4GHz, the top row shows how WiFi channels use the spectrum. This should indicate to the user that the best channels to use when you know which channel WiFi is on. When in an environment where WiFi is also expected to be in prevalent use, but you are not sure which channels, try Channels 11, 15, 20 or 25. Bluetooth uses the entire spectrum around 2.4 GHz, but will (try to) avoid channels in use by other systems including Awinda channels.



XSENS

19.13 System Specifications

Recommended computer system	
Operating system	Windows 7/8 (64 bit)
Processor	Quad core or higher (2.7 GHz or faster)
Hard drive	SSD 256 GB or more
Memory	8 GB RAM (64-bit)
Graphics card	Hardware acceleration for DirectX 11 Dedicated memory 512 MB or more
Network card	Gigabit Ethernet, support for jumbo frames (9014 Bytes)
USB ports	USB 2.0 (1 per MVN Awinda system, 1 per license dongle)
MVN System	
Number of trackers per suit configuration:	
Full body	17 inertial motion trackers
Extra prop /backup	1 inertial motion tracker
Optional extra trackers:	2 inertial motion trackers
MVN Camera	Prosilica GS650
MVN Mounting Straps	Fabrifoam with Velcro closure
Full body Lycra suit:	Light weight revolutionary stretch fabric with exterior zippered channels for trackers and wires
Sizes:	Straps one size fits all, with 3 sizes of vests (s-m, m-l, l-xl). Suit: S, M, L (standard), XL, XXL
Accessories:	2 gloves with tracker pocket 1 head band with tracker pocket 2 foot pads with Velcro patch Pair of shorts (MVN Link)
MVN Link on body cabling:	1 cable connects Body Pack to Battery Back, all remaining strings of trackers connect to Body Pack.
Data control units:	1 Body Pack
Power (BP)	
Battery	rechargeable smart Lithium Ion battery pack
Power adapter (incl.)	EU/US/UK Power adapter 110-240VAC/12VDC 1A
Operating time (typical)	9.5 hours
Battery charger (included)	battery charger with ability to recalibrate fuel gauge on battery packs



Xsens

Communication			
Interface	Wireless (WiFi or Awinda Protocol)		
Wireless range radius (max)	MVN	Awinda Station	Awinda dongle
Outdoor	150 meter (492 ft.)	~50m (164 ft.)	~20m
Indoor open space	150 meter (492 ft.)	~20m ()	~10m
Indoor office	50 meter (164 ft.)	~20m ()	~10m
Wireless receiver units:	MVN Link	MVN Awinda	
Number of Wireless Receivers	1 Access Point	1 Awinda Station or Awinda Dongle	
RF technology	WiFi 2.4GHz, 5.0 GHz	IEEE 802.15.4 PHY 2.4GHz	
Interface	Ethernet	USB 1.1 or 2.0	
Power	Battery	USB (station additionally mains power supply)	
Physical			
Dimensions MTx	36 x 24.5 x 10mm		
Dimensions BP	160 x 72.5 x 25 mm		
Dimensions MTw	47 x 30 x 13 mm		
Dimensions Awinda Station	148x104x61.9 mm		
Dimensions Awinda Dongle	45x20.4x10 mm		
Dimensions MVN suitcase	559 x 351 x 229 mm (22 x 13 x 9 inches) Flight case with wheels & extendable handle. Durable & watertight		
Weight MTx	10 g		
Weight BP	150 g		
Weight MTw	16g		
Weight Awinda Station	233g		
Weight Awinda dongle	8g		
Weight MVN Suit(no trackers)	485 g		
Weight MVN Straps(no trackers)	153 g		
Weight total on-body system (with batteries and cables)	1130 g	MVN Awinda: 525 g	
Shipping weight	10 kg	5.5 kg	
Operation environment	0 – +50 deg Celsius, non-wet		



Tracker Performance	
Static accuracy (Roll/Pitch)	0.2 deg
Static Accuracy (Heading)	0.5 deg
Dynamic Accuracy	1 deg RMS
Accelerometer range	MTx: $\pm 160 \text{ m/s}^2$ (16 g) MTw: $\pm 160 \text{ m/s}^2$ (16g)
Gyroscope range	$\pm 2000 \text{ deg/s}$
MVN Performance	
MVN human model	MVN uses a 23 segment biomechanical model with 22 joints. Each joint is specified by statistical parameters for 6DOF joint laxity. An advanced spine and shoulder model is used that computes the kinematics of the spine and shoulder blades.
System Calibration	
General	Flexible calibration scheme with instant feedback regarding the expected accuracy. Calibration can be done without assistance from a second person.
Minimum calibration time	10 seconds. Basic calibration needs only subject length, foot length.
Advanced calibration	10 – 30 seconds per additional step. Advanced subject specific calibration determines tracker alignment and/or subject specific dimensions. Calibration procedures for subjects with limited range of motion are possible.
MVN Fusion Engine	
Output	Full kinematics of each segment (position, velocity, acceleration, orientation, angular velocity and angular acceleration). MVN Studio PRO additionally provides joint angle and CoM. All at preset sample frequency (max 210Hz). Double integration of body segment accelerations allows for jumping/running (permanent floor contact is not needed).



MVN Fusion Engine	
3D translation capture	~1% error in traveled distance (without external aiding). Advanced external contact model detects body-world contacts, to enable crawling, sitting, cartwheel etc. Various friction models (slippage etc.) are possible. ⁹ Seamless fusion with aiding technologies possible, e.g. 3D position from optical/GPS, or 2D image correspondences. ⁹
Magnetic environment Local, permanent disturbances	Full immunity to any magnetic distortions of knee and ankle joint. Full immunity to temporary magnetic disturbances (duration <30 seconds). Visual warning of disturbed environment. High degree of immunity, performance will depend on motion and environment.
Soft tissue artifacts	Minimized to ~2 degrees RMS using redundancy in measurement and biomechanical constraints.
Multiple person capture	Up to four person capturing on one pc
MVN Studio Software	
Functionality	Easy and quick calibration Real time preview of motion capture Simultaneous recording and viewing of motion capture data Replaying and editing of previously recorded motion data
Supported export formats	.BVH -Biovision Hierarchical Data .C3D -Coordinate 3D data .FBX – FiLMBOX .MVNX – MVN Open XML format
Sample Frequency	60 – 240 Hz (default 240 Hz)
Wireless Update Rate	20-60Hz Depending on suit configuration
Data rate	37 MB/min @ 60 Hz 74 MB/min @ 120 Hz 158 MB/min @ 240 Hz
Legal Notice	
Warranty	2 Years
MVN and Xsens are trademarks of Xsens Technologies B.V.	
Patents Pending	
www.xsens.com	

⁹ Some features are only available in SDK, ask for possibilities.



20 Contact point editing examples

The following section illustrates how to use the contact editing toolbar.

20.1.1 Example 1

In the originally recorded MVN file, a contact on the mid foot has been wrongly detected. The result is an unlikely position of the foot segment with respect to the lower leg and a discontinuity in the position of the total character. Removing this contact will improve the data.

- Click on the foot segment. Step forwards and backwards in time to identify the wrongly detected or missing contacts.
- Select the identified time frames by clicking the left mouse button. The selected frames will be highlighted. By manually defining a contact point, all other contact points of that frame will be removed including contact points of segments other than selected.
- To add contact points without removing existing points, hold the shift button when releasing the mouse button. This option should not be used excessively, but maybe useful to optimize discrepancies when two segments make contact at the same time frame.
- If a wrong frame or contact point is selected, you can undo this by a click on the right mouse button and select 'Remove user-defined'.
- To remove all contact points such that no segment has contact, click and drag the right mouse button on the desired frames and select 'Force no detection'. The contact bar will then show a black band.

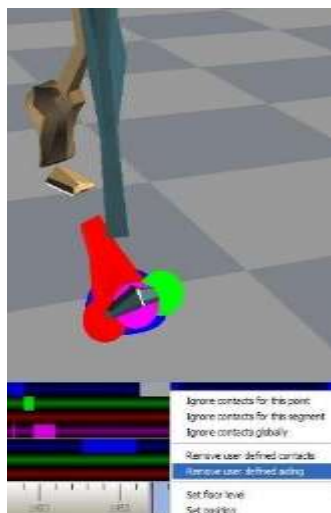
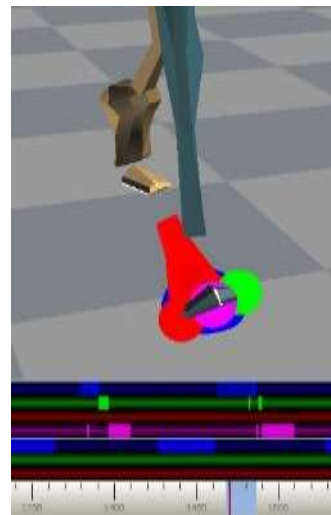



- After editing the contact points, press the reprocess button or 'Ctrl+Shift+P'. The MVN Fusion Engine will now re-compute all kinematics using the original inertial sensor data taking the overruled contact points into account.



20.1.2 Example 2

- In the originally recorded MVN file, the foot is already on the ground but the contact is detected too late. The result is that the character seems to stick at a wrong contact and the foot slides back.
- Click on the foot segment. Step forwards and backwards in time to identify the frames and possible contact points. In this case, the heel (red sphere) is the most likely contact point to have contact with the ground.
- In the contact bar, select the frames of the heel (upper bar) with the left mouse button. The selected frames will be highlighted.

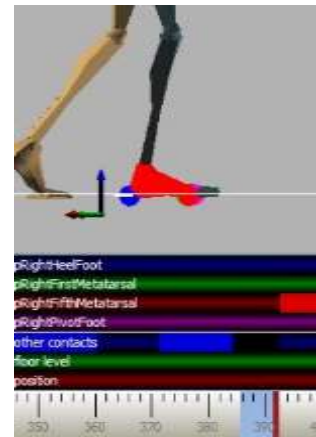

- After editing the contact points, press the reprocess button. The MVN Fusion Engine will now re-compute all kinematics based on the overruled contact points.
- Verify the modified contacts. The red sphere should be enlarged during the selected frames and foot slide should no longer occur during these frames.

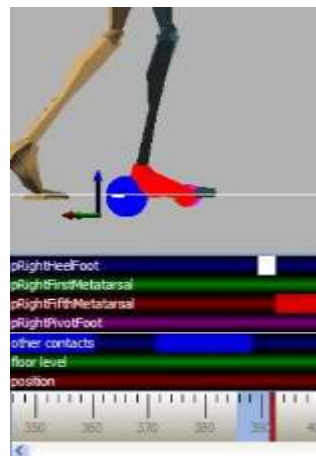



21 Working with different applications

21.1.1 Autodesk 3ds Max

In 3ds Max, a Biped system provides direct input of BVH files, including key-frame reduction and footstep extraction. Choose the 3ds Max output format when exporting to BVH. The exporter will apply a neutral pose hierarchy instead of the T-pose hierarchy. The neutral pose for the Biped places the figure upright along the +Z axis, facing forward along the -Y axis, left hand on the +X axis. Hands are oriented with palms against the outside thighs, with thumbs to the front side; fingers and thumb of each hand outstretched (open) facing down along the -Z axis. Legs are together and straight at the knees. When all joint rotation values are set to zero for the first frame of the BVH file, the results displayed at frame zero in Biped should match the default position of the Biped exactly.

A Biped has built-in anthropomorphic constraints which require that *elbows* and *knees* are one degree-of-freedom hinge joints. The axis of rotation of the hinge should ideally always be perpendicular to the arm's shoulder-elbow-wrist triangle and the leg's hip-knee-ankle triangle. If the hinge joint constraint is violated, biped's converter must decide whether to satisfy the orientation data or satisfy the elbow/knee positioning based solely on the point locations.



In the Conversion Parameters Dialogue Box, if the 'Angle' radio button is selected (recommended), the limb's triangle attempts to match the hinge to the Euler matrix axes. This may deviate from the position posture. If the 'Point' radio button is selected, the limb's triangle matches the positions of the actual points. This may deviate from the specified Euler angles. However, in both cases, the limb always moves to hit the IK position of the wrist or ankle, so if Euler angles are given that are not aligned with the natural hinge joint, the axis is projected to the nearest axis that satisfies the wrist/ankle IK constraint (that is, one axis must be normal to the line joining the arm's shoulder-wrist or the leg's hip-ankle).

21.1.2 Autodesk MotionBuilder

Autodesk MotionBuilder is a powerful animation package which features many tools for forward and inverse kinematic manipulation and retargeting. Use the following steps to drive your model in MotionBuilder.

1. Import the BVH motion file into the MotionBuilder.
2. On the first frame of the motion set the BVH skeleton reference into the T-Pose.
3. Characterize the BVH skeleton with the MVN character template.
The MVN character template 'MVN BVH Character.fbx' can be found in the folder:
%AppData%\Xsens\External\MotionBuilder\Templates\MVN.
4. Import the character model you want to animate.
5. In the control rig of the imported model choose as input 'Character Input' (MVN BVH).
6. Play the animation and plot to character.

Poser 6

Choose the Poser BVH exporter format when exporting to BVH. The exporter will rename certain labels and combine the chest channels since Poser can only handle 1 abdomen and 1 chest channel. Load the model you want to animate into Poser. Import BVH data and choose the options arms aligned with X-axis, and Scale Automatically.



Poser 7 note:

There is a known issue in Poser 7 regarding figure orientation. It will introduce an odd twist in the orientation of the segments. Please contact Poser support for information about an update.

21.2 MotionBuilder workflow

To import FBX in MotionBuilder, the MVN script called MKMVN01.py (which can be found in %AppData%\Xsens\External\MotionBuilder\Templates\MVN) should be copied to one of the following folders:

Windows 7 64-bit, MotionBuilder 64-bit installed:

- C:\Program Files\Autodesk\MotionBuilder 2014\bin\config\Scripts
- C:\Program Files\Autodesk\MotionBuilder 2015\bin\config\Scripts

1. Load the template file 'MVN FBX import.fbx'. In the Viewer window, nulls represent the joint positions and rotations of the skeleton.

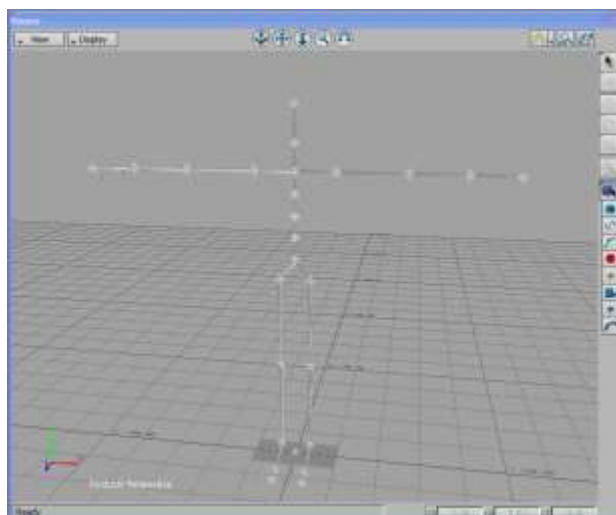

2. Import the motion data >'Import & Merge'. Select the 'Import Scaling' option.

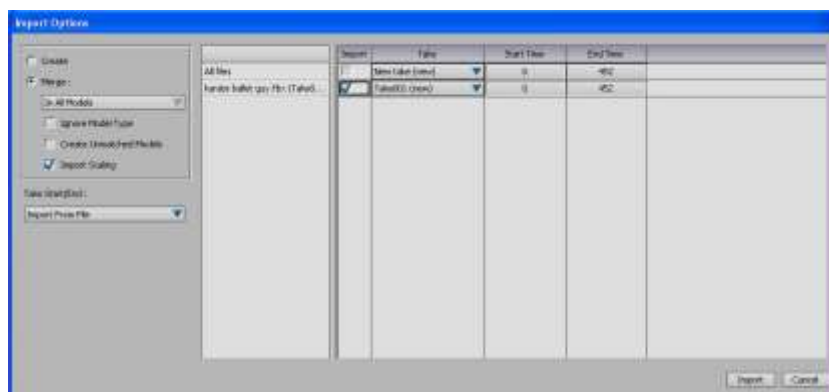

3. Plot the animation to the control rig – this can be done by pressing function key 'F10' which runs the MVN script. A filter is applied to eliminate gimbal lock.

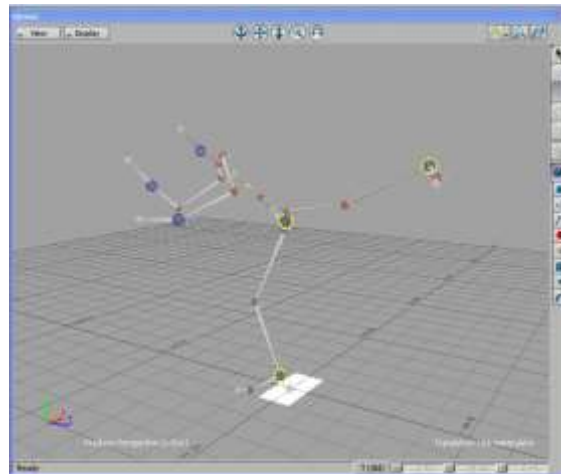

4. The skeleton is a character in MotionBuilder and the control rig contains the captured motion. You can now simply merge another character in the scene and transfer the animation by using the character input option of MotionBuilder. You can also save the animation in the character controls.

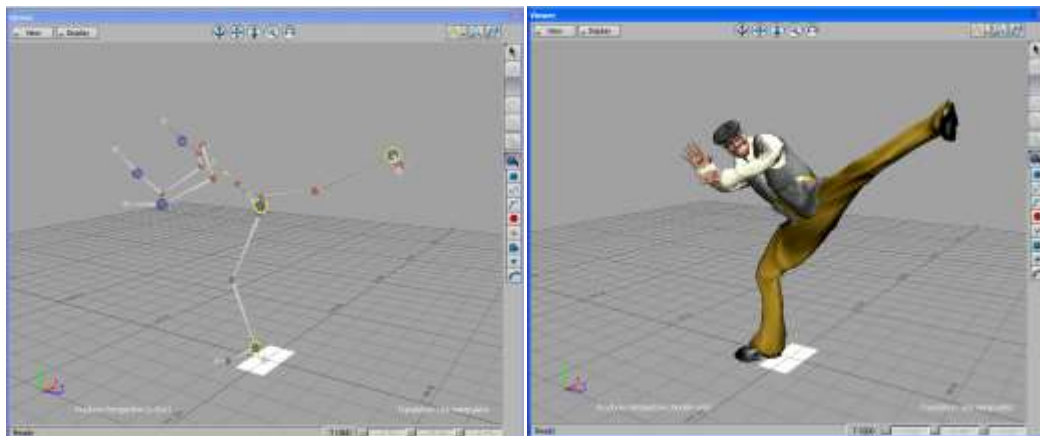



22 Importing MVNX files to other programs

22.1.1 Import to Microsoft Excel

File and open the MVNX file.

It is likely that the following warning is generated. Click YES.



Next the following menu will pop up:

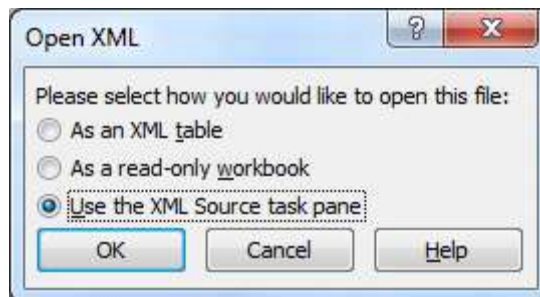

As in this example, select the XML source pane option.

Another warning message appears:

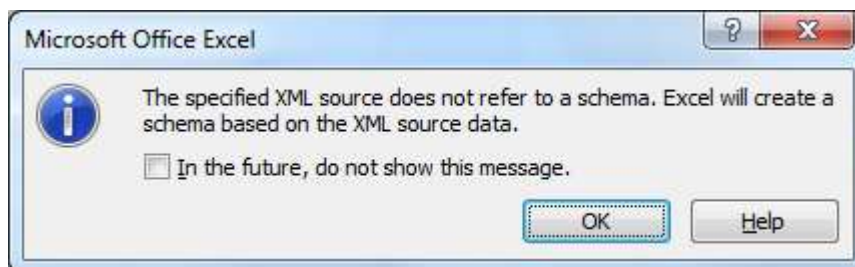

Click OK.

The window will now look like:

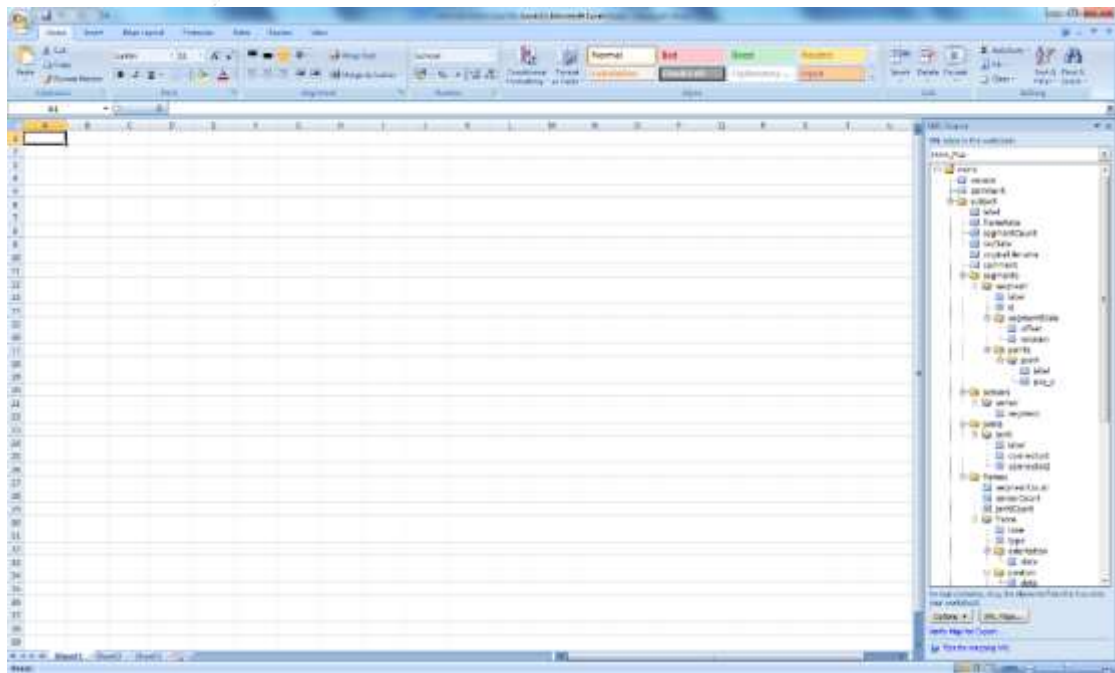

The information of use is in the panel on the right hand side. This data contains all of the data that was exported. To view data, select the data of choice e.g., joint angles from the list of parameters (sensors, segments, points, frames). Go to frames, joints angle and drag that label to e.g. Cell A1. A title box will appear. To view data, click refresh:

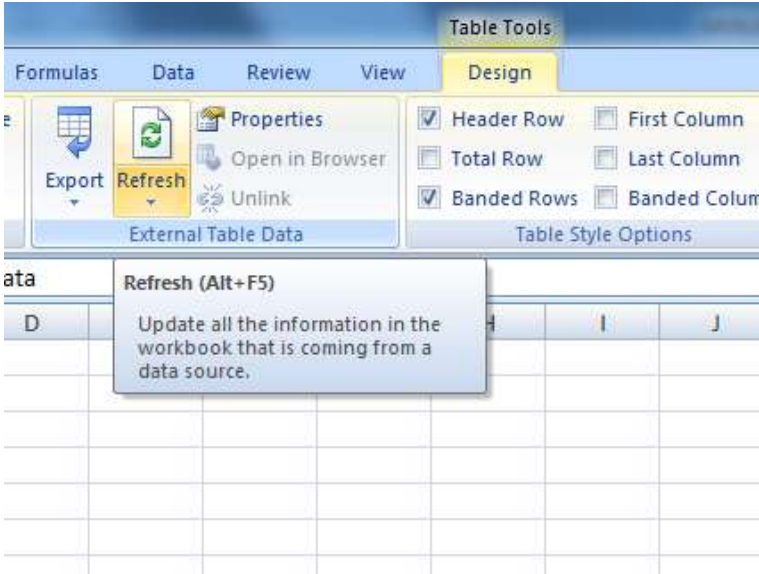

It is clear that data is present, but it is still not defined.

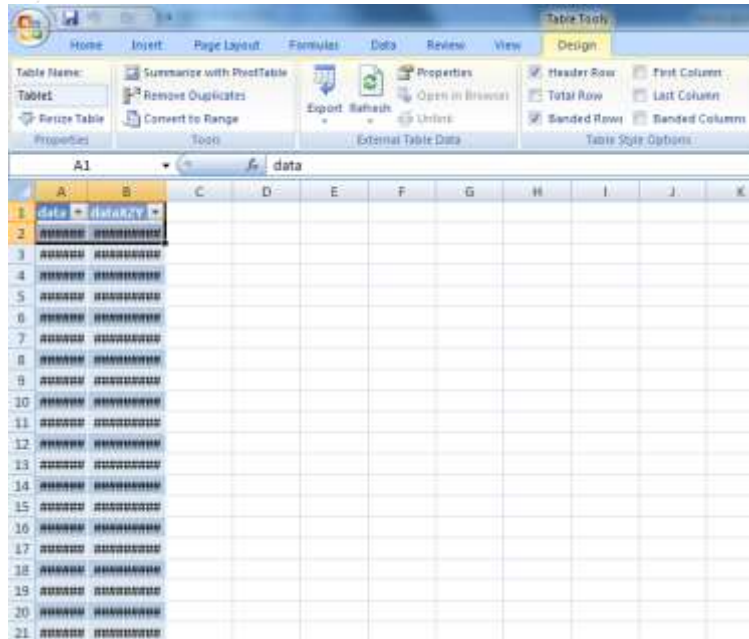



To work with the data, go to the data menu (Data Tab in Excel 2007). Select “Text to Columns”.

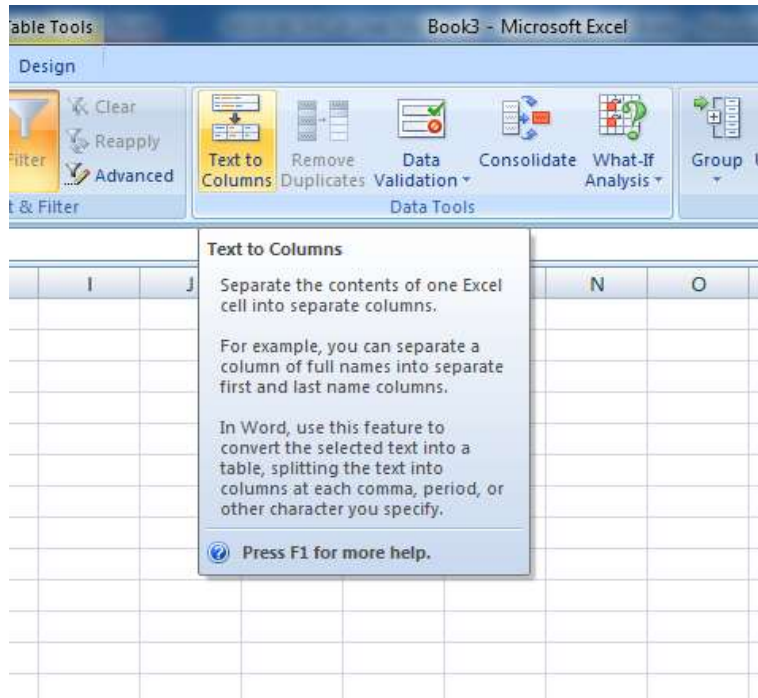

The data is delimited.

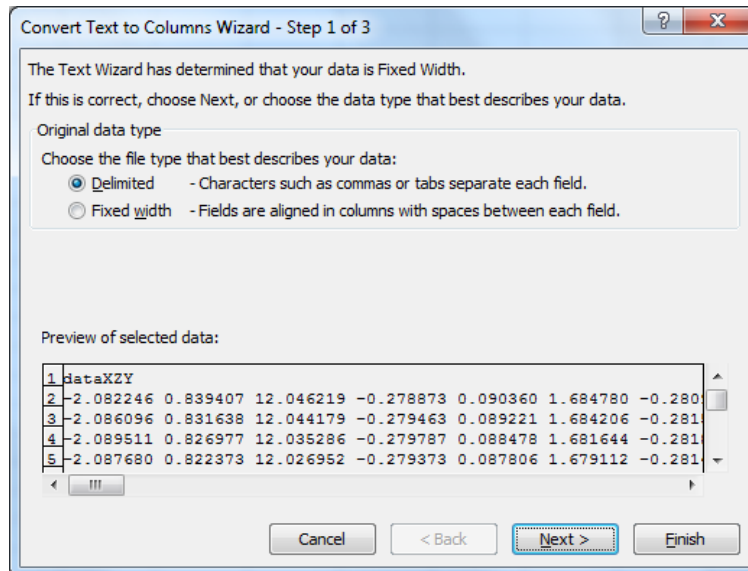



Using Tab and Space.

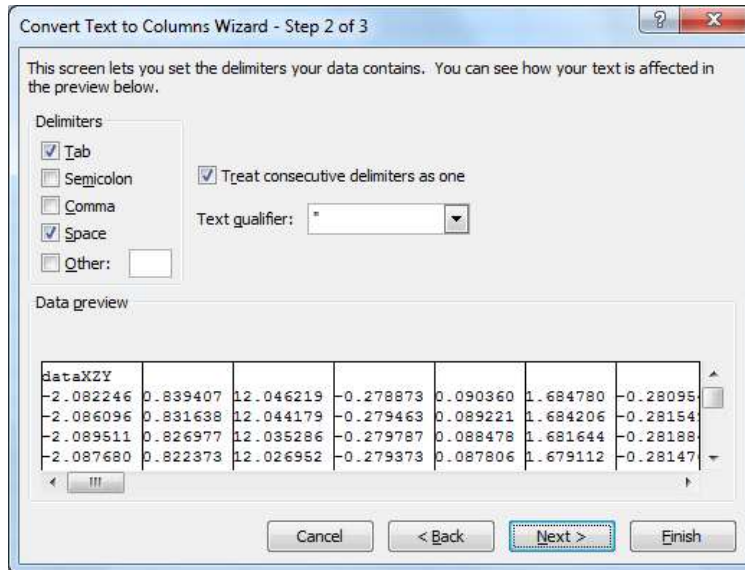

The list of labels is also contained in the right panel, click and drag the parameter labels to the worksheet. See Section 12.5, for the details of the MVNX structure.

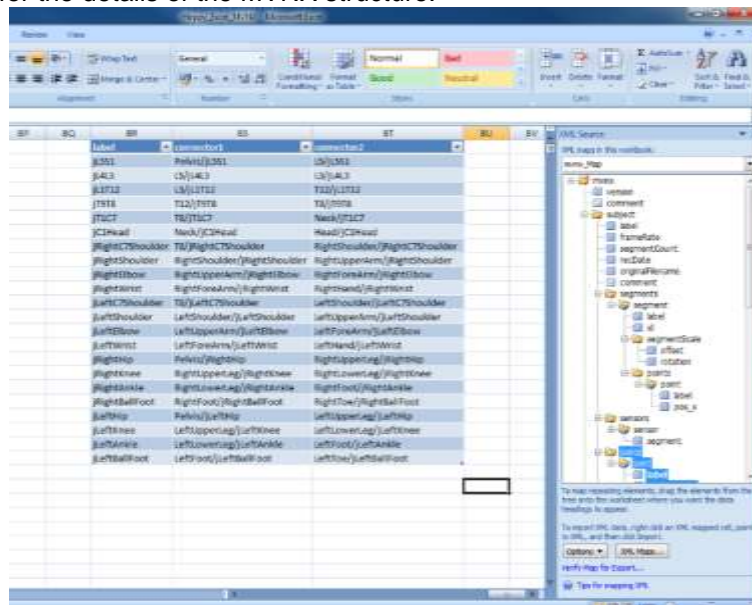



22.1.2 Import to MATLAB

Import MVNX files using the MATLAB files in the MATLAB Installer of MVN Studio. Below is a copy of the information stored in "main_mvnx.m". This file intended simply as an example. The user is expected to expand upon this for their own use, depending on data they have exported to mvnx.

The example code contains:

main_mvnx.m and load_mvnx.m. The file main_mvnx is detailed below. It calls the function load_mvnx.m, which is based on the MATLAB function for reading XML files.

Example code to read the file:

main_mvnx.m

```
tree = load_mvnx(filename);
% read some basic data from the file
mvnxVersion = tree;
fileComments = tree.subject.comment;
%read some basic properties of the subject;
frameRate = tree.subject.frameRate;
suitLabel = tree.subject.label;
originalFilename = tree.subject.originalFilename;
recDate = tree.subject.recDate;
segmentCount = tree.subject.segmentCount;
%retrieve sensor labels
%creates a struct with sensor data
sensorData = tree.subject.sensors.sensor;
%retrieve segment labels
%creates a struct with segment definitions
segmentData = tree.subject.segments.segment;
%retrieve the data frames from the subject
nSamples = length(tree.subject.frames.frame);
%pre allocate
%pre allocate some memory for the position of Segment1
p_Segment1 = zeros(nSamples,3);
%read the data from the structure e.g. segment 1
for i=[1:nSamples]
    p_Segment1(i,:)=tree.subject.frames.frame(i).position(1:3);
end
%Plot
plot(p_Segment1)
figure
plot3(p_Segment1(:,1),p_Segment1(:,2),p_Segment1(:,3));
```



23 Synchronization with Third Party Devices

23.1 The Hardware

MVN BIOMECH Awinda uses the Awinda Station for synchronization.

From MVN Studio 4.1 and onwards, a Sync Station is provided with MVN BIOMECH for synchronization purposes. Details on initializing the synchronization of MVN are provided in Section 7.2.14. The purpose of this section is to provide some in-depth information about the synchronization possibilities.

The Awinda Station was originally created as a wireless master to control the Xsens MTw kit. The Awinda Station and Sync Station were created specifically for the biomechanics market, where synchronization with third party devices is an essential aspect of biomechanics research. For this reason these Stations are equipped with 4 BNC connectors, two for receiving TTL pulses (Sync IN) and two for sending TTL pulses (Sync OUT).

The hardware clock of the Awinda Station is very accurate. As an indication of the clock accuracy, the error in the Awinda Station's clock has a maximum of 1 μ s every second (1 ppm). Therefore, in general, the recommended scenario is that users relying on very tightly coupled synchronization use MVN BIOMECH Awinda, and use it with the Sync Out settings.

With MVN BIOMECH Link, there is additional hardware making synchronization possible, this is software synchronization. It is essential that the user understands that software controlled synchronization can lead to undefinable latencies between button click in the software and reception of this signal.

Note that to synchronize with third party devices, BNC connectors are required at the Awinda Station or Sync Station side. Since there are a multitude of system-specific connectors for third party systems, Xsens does not provide the cables or connectors. Please contact the respective third party providers or user manuals for details their hardware requirements.

23.1.1 Important note when receiving 5V synchronization pulses

On the back of the Awinda and Sync Stations are four BNC ports, two Sync In ports and two Sync Out.

The ports have been configured to send (Sync Out) or receive (Sync In) TTL pulses 0-3.3V.

This 3.3V is lower than the voltage sent by some devices, which will be synchronized with the MVN System. These other devices are based on 5V TTL levels. For this reason it is advised to separately purchase (from eg Farnell) a 3.3 - 5V / 5V - 3.3V SMD level translator. This will prevent damage to the SyncIn ports of the Awinda or Sync Station when receiving 5V pulses from third party systems. In general sending a 3.3V pulse from an Awinda or Sync Station SyncOut port is fine. Therefore unless a threshold of 5V of the third party system is required, in which case the 3.3V-5V SMD level translator will be required.



23.2 Sync In

Sync In means that a third party device sends a control signal to the Awinda Station. The Awinda Station can detect polarity changes on the input lines. This trigger may be a rising or falling edge as illustrated in the following figures:

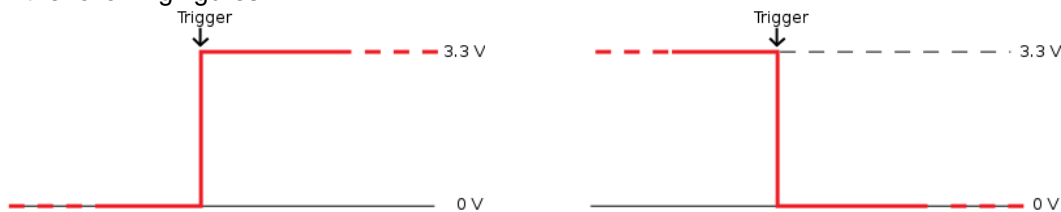

When a trigger is detected on one of the input lines, the Awinda Station can be configured to perform a certain action. Combinations of any of the following are possible on each Sync In port:

Sync Type	Description
Start Recording	External system sends a start recording trigger. On the Awinda Station, this will be the next frame.
Stop Recording	External system sends a stop recording trigger.

A number of parameters can be set for each action:

Parameter	Description
Sync Line	The sync line to activate.
Pulse Polarity	Rising or falling edge, or rising and falling.
Trigger Once	It is not recommended to select Trigger once if more than one recording using synchronization of multiple systems will be made. This is a failsafe option in the case third party systems send pulses throughout recordings.
Skip First	The number of initial occurrences of the sync trigger to skip. This is useful if a well-defined delay is expected, or if the external signal sends the same signal to generate both a start and stop recording. Take for example the command to start recording and stop recording, one signal sent to the Awinda Station can generate two different commands. Therefore if both start and stop are on the same sync line, skip first should be 1 for stop recording, ensuring that the second trigger, not the first, causes recording to stop.
Skip Factor	The number of occurrences of the sync trigger to skip in between trigger signals. In the same way that was described in Skip First (above), skip factor, for start and stop recording on one sync line should be set to 1, to ensure that the first trigger starts the recording and the second stops etc.

NOTE: If the user selects Sync In but selects a function from the drop-down menu that is only available as Sync out (namely, settings other than start or stop recording), the software will automatically change the sync channel to Out 1.

Therefore care is required when matching sync in or out with the functions available.



23.3 Sync Out

Sync Out is the command that enables the Xsens system to send a trigger pulse for synchronization purposes. A control signal is sent via the Awinda/Sync Station, from MVN Studio to the third party hardware.

Sync Type	Description
Start Recording	Upon clicking the record button in MVN Studio, the Awinda Station starts the recording and consequently sends a start recording trigger to the third party system.
Stop Recording	Upon clicking the record button in MVN Studio, the Awinda Station stops recording and sends a stop recording trigger to the third party system.
Go to Operational	The default polarity of the output line is always low. However, for input triggers that assume high polarity, the polarity of the line must be set high beforehand. This becomes possible, using 'Go to operational'. When 'Go to Operational' is selected on the same line as the assumed high polarity, the polarity is changed to high, preparing the system for sync.
Interval Transition Measurement	A frame / or interval transition at the Station can be used to give a signal to the external system, indicating the end of the strap-down integration interval over which data is calculated. Selecting this option, the frame transition is sent from the moment that "Start Measuring" is selected.
Interval Transition Recording	See Frame transition Measurement Selecting this option, the frame transition is sent from the moment that a recording is started. This is a very useful option to implement, to ensure that during a recording, the clocks of the synchronized systems are known, ensuring that any drift can be compensated for.

A number of parameters can be set for each action:

Parameter	Description
Sync Line	The sync line to activate.
Pulse Polarity	Positive pulse (where the polarity is initially low [0V] and goes high [3.3V]). Negative pulse (where polarity is initially high [3.3V] and goes low [0V]).
Trigger Once	It is not advised to select Trigger once, if more than one recording using synchronization of multiple systems will be made.
Skip First	Number of initial sync pulses to skip. This command is useful if a well-defined delay is expected between the Xsens and the third party system. It may also be needed if the third party, like the Xsens system uses the same pulse properties to trigger different actions. See description provided above for Sync In.
Skip Factor	Number of sync pulses, between the sync pulses delivered, to skip. See Sync In Table description.
Pulse Width	Some systems wait for a signal of a minimum pulse width before generating the desired synchronization action. The Awinda / Sync Station can send a pulse with a duration of up to 99ms to a third party system. It is not recommended to send a signal longer than a frame width. Specify 0 ms to generate an infinite pulse width.



23.3.1 Settings in MVN Studio

Once the spanner  has been clicked, a new menu appears:

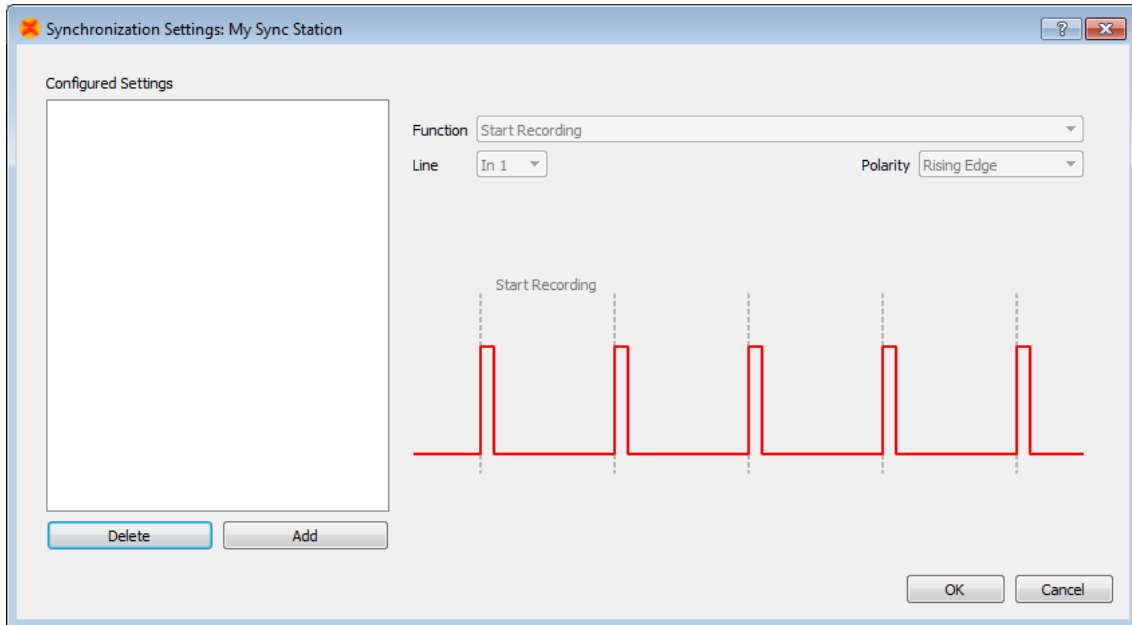
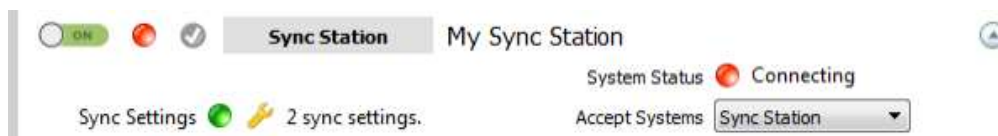

Figure 70: Sync settings window in MVN Studio

To add a synchronization type, click “Add”, all settings become available, to be set manually or using the drop down menus.

Note that the Awinda/Sync Station can accept both rising and falling edges. The Pulse Polarity should be chosen depending on the requirements of the third party device. Also, check with third party systems what the threshold of the Pulse Width must be before entering a pulse width. Some example settings are provided in Section 23.7.

When all desired parameters have been set, click “OK”. This closes the sync settings window. Now in the Session Configuration interface, the number of settings is displayed, indicating to the user that sync is set and if the system is enabled, sync will be enforced. Below shows the result when start and stop recording on line Sync In 1 have been set.



This is an important point to note: The Configured Sync Settings are saved in the configured system. Therefore when a given configuration is enabled the sync settings of this enabled configuration are used.

23.4 Important Notices for Sync In

When the Awinda Station is configured to start recording upon receipt of a trigger, it initializes recording at the start of the following frame. The Awinda Station cannot trigger a start recording command between



frames since data received in a given frame is measured in the previous one. Therefore, delaying the recording in this way ensures that data is not recorded prior to the external trigger indication.

In the same way, recording should not be stopped between frames, since data received in a given frame was measured during the previous frame. Therefore, the Awinda Station stops recording immediately after the current frame.

23.4.1 Sync In Recommended Settings

Note that the preferences menu includes “Skip first” and “Skip Factor”. The definitions of these have been provided above; however for practical use consider the following:

When the Awinda Station is triggered to start and stop a recording, on one line, it will blindly receive 3.3 V pulses on that line. Since all pulses are the same, the Station requires further instructions about what to do with each pulse. In the software, a translation has been put in place to carry out a certain action with each pulse.

Therefore, to start a recording, one must give an initial pulse. The second pulse, should indicate a stop recording, therefore the skip factor in “Start Recording” should be set to 1. In Stop Recording, the first pulse should not trigger a stop (it was just used to Start Recording); so a Skip First of 1 must be input, and to ensure that every other pulse thereafter stops the recording, a Skip Factor of 1 must be input.

This means that Start Recording is commanded on pulse 1, 3, 5 etc and stop recording on 2, 4, 6 etc.

23.5 Sync In with MVN Studio

When Sync In is in use, after configuration, and when ready to record, users should click Record, to prepare the system for the external trigger. The record icon changes from the normal red dot to one with the pause symbol overlaid. When recording has been triggered by the external system, the record button will indicate as such (most right icon shown below):



Record button prior to depression



Record button when depressed and waiting for Sync In signal



Record button during recording (and temporarily during flushing)

23.6 Sync Out with MVN Studio

When the parameters have been set for MVN Studio to control the start and stop of recordings, each time the record button in MVN Studio is depressed, a TTL pulse will be sent to the specified Sync Line. The receiving system must be configured to take the specified action.

Of course, ensure that the BNC connector is connected to the correct Sync Out line(s).



23.7 Synchronization Examples

23.7.1 Start and stop recording of third party devices using single pulse

Third party device starting and stopping recording of Xsens system, on Line 1 of the Sync In port.

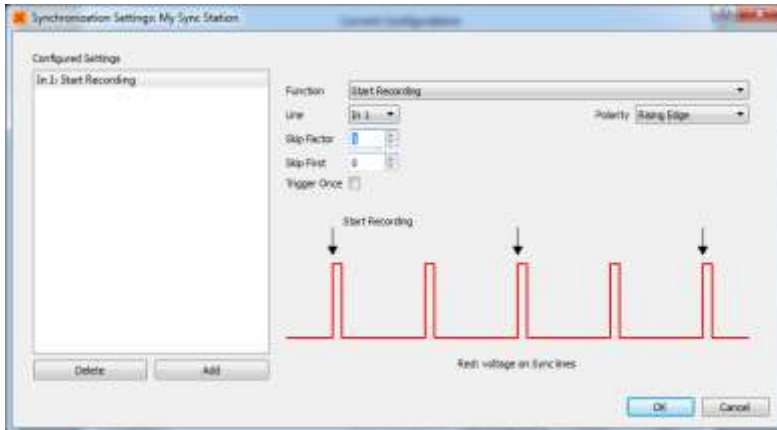

Click "Add"
 Select Sync Type Start Recording
 Select Sync Line: In 1
 Pulse Polarity: Rising Edge¹⁰
 Skip First = 0
 Skip Factor = 1 (so that every other pulse will start a recording in MVN Studio)
 Trigger Once: Unchecked¹¹

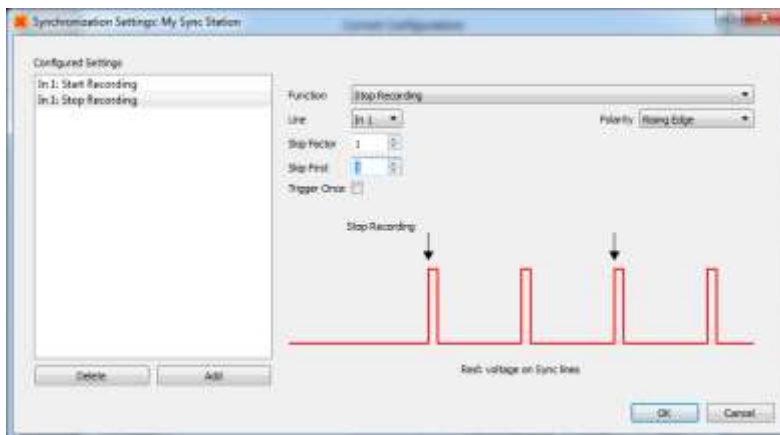

Click "Add"
 Select Sync Type Stop Recording
 Select Sync Line: In 1
 Pulse Polarity: Rising Edge
 Skip First = 1 (first trigger starts recording, so it should not also send a signal to stop - or this causes confusion for Awinda Station)
 Skip Factor = 1 (so that every other pulse will stop a recording in MVN Studio)
 Trigger Once: Unchecked

The above example indicates how to allow a signal of 3.3V enter the Sync In 1 port, of the Awinda Station. The first upward going pulse (and subsequent odd numbered pulses), received on the Awinda Station, will start recording (Polarity = rising edge). The second upward going pulse (and subsequent even numbered pulses), received on the Awinda Station, will stop recording.

23.7.2 Start and Stop Recording Third Party Devices with Infinite Pulse Width

It is of course also possible, to configure that for example the upward rising edge causes the start of recording and the negative direction edge causes stop recording, this may be useful in the event that a third party devices needs to be active high to record data.

To do this, the following settings should be input:

¹⁰ Note that this setting depends on the signal from third party system.

¹¹ To ensure that a series of recordings can be made.

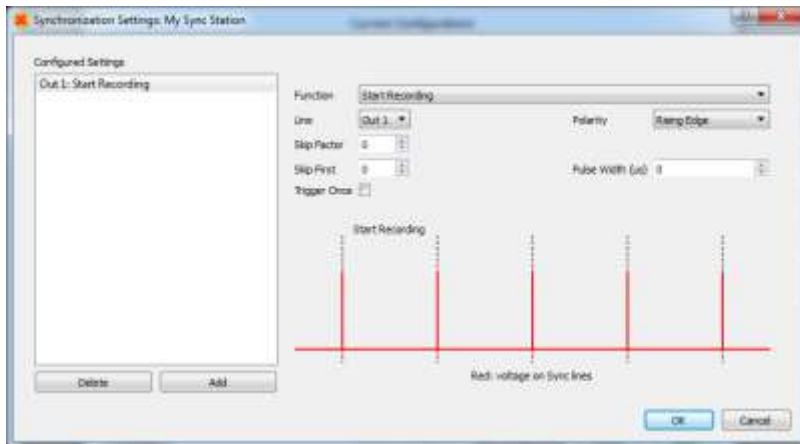

Click "Add"
 Sync Type: Start Recording
 Sync Line: Out 1
 Pulse Polarity: Rising Edge
 Pulse Width = 0 μ s¹²
 Skip first = 0
 Skip factor = 0
 Trigger Once: Uncheck

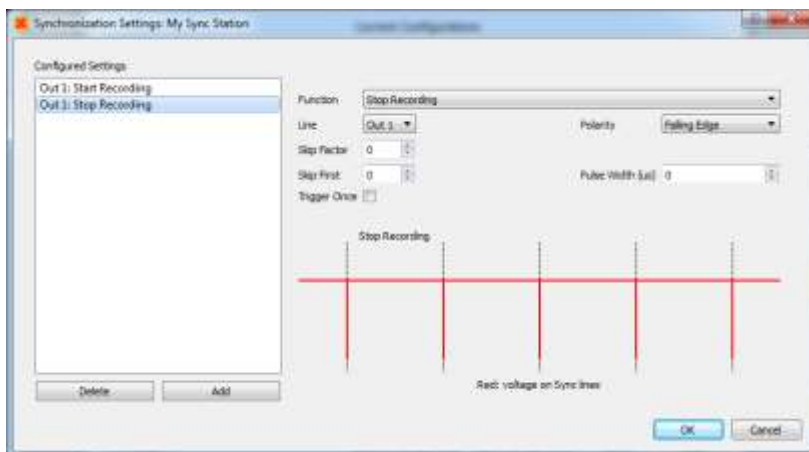

Click "Add"
 Sync Type: Stop Recording
 Sync Line: Out 3
 Pulse Polarity: Falling Edge
 Pulse Width = 0 μ s¹²
 Skip first = 0
 Skip factor = 0
 Trigger Once: Uncheck

Note:

Stop recording time may not be on the last sample recorded.

In any synchronization situation, there should only be one master. It is necessary to elect a master, either an Awinda Station, or a third party device.

23.7.3 Synchronizing with Noraxon EMG

Synchronization was successfully tested between MT Manager, for the MTw Development Kit and Noraxon TeleMyo system. While we assume that the results will be just as successful with MVN, this has not yet been tested.

The steps described below describe how to make it possible for the Awinda Station to send a synchronization signal (Xsens is Sync Out and Noraxon is Sync In) and how to receive the synchronization signal (Noraxon is Sync Out, Xsens Sync In).

Of course, care must be taken when placing the EMG electrodes with the straps or suit of MVN.

¹² Note that MVN Studio 4.1 use the unit microseconds for pulsewidth. For current users, all previous millisecond units used should be multiplied by 1000.



23.7.3.1 Awinda Station Sends Sync Signal (Noraxon Receives Sync Signal)

Hardware requirements:

Noraxon Hardware	Xsens Hardware
Wireless EMG transmitters 1 TeleMyo DTS (plus antenna)	MVN System Awinda Station

Both systems of course also need related cables to connect to each other (with BNC connectors at each end) and a USB cable to connect to the PC.

In addition to the normal MTw hardware setup, also connect the BNC connector from the TeleMyo DTS to Sync Out 1 on the Awinda Station. Connect the USB connection between the TeleMyo DTS and the PC. When switched on, the DTS will display “USB ready”.

23.7.3.2 Software Setup in MVN Studio

There is no fixed order for configuring MVN Studio in terms of Synchronization configuration. This can be done before or after a new recording session.

Synchronization on Sync Out Line 1:

Sync Out	
Select Start Recording Select Out 1 Polarity: Rising Edge Pulse width = 10 ms Trigger Once: Uncheck Skip first = 0 Skip factor = 0	Select Stop Recording Select Out 1 Polarity: Rising Edge Pulse width = 10 ms Trigger Once: Uncheck Skip First = 0 Skip Factor = 0

23.7.3.3 Software Setup Noraxon MyoResearch Software:

The example given below is for is gait analysis, measuring the medial gastrocnemius, tibialis anterior, semitendinosus and the rectus femoris. For an 8-Channel EMG system, Channel 9 is selected as the synchronization line in the Noraxon MyoResearch Software. If a 16 channel system is in use, this is the 17th channel.

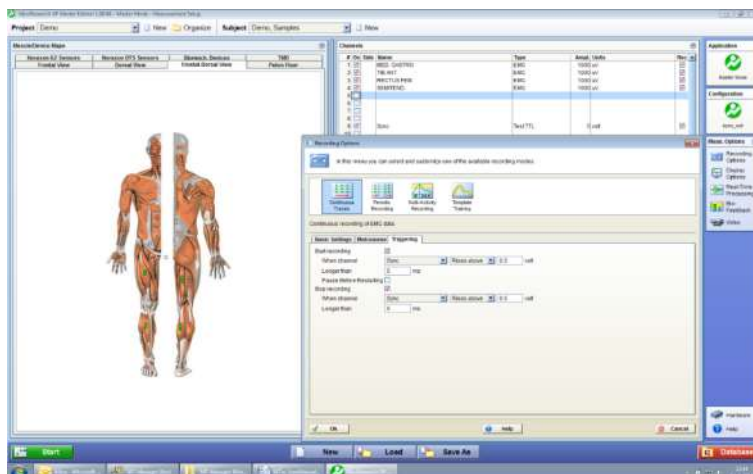

Return to the main menu, under >Measuring Options, go to >Recording Options, then >Triggering tab.

Check the check box beside “Start Recording”;



- Go to the drop down menu beside “When Channel”, select “Sync”;
- Select Rises Above (ensure that this is also the direction indicated on the mini-receiver);
 - Input e.g. 0.5V
 - Longer than 5ms
- Repeat settings for Stop Recording.
 Navigate further through the software.

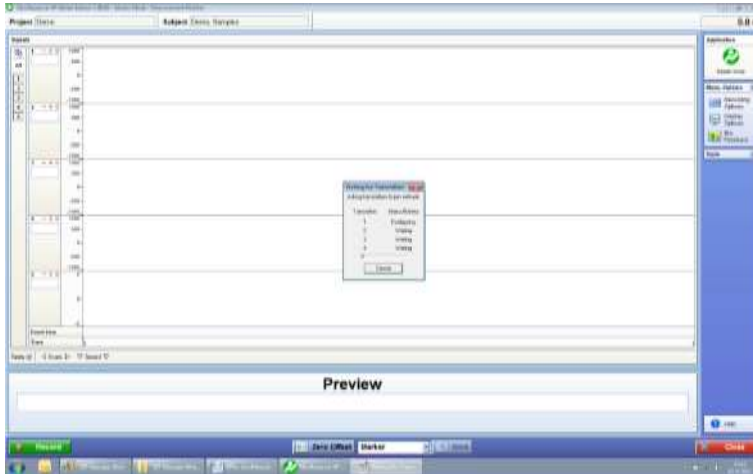

The Noraxon software initializes the EMG signals.

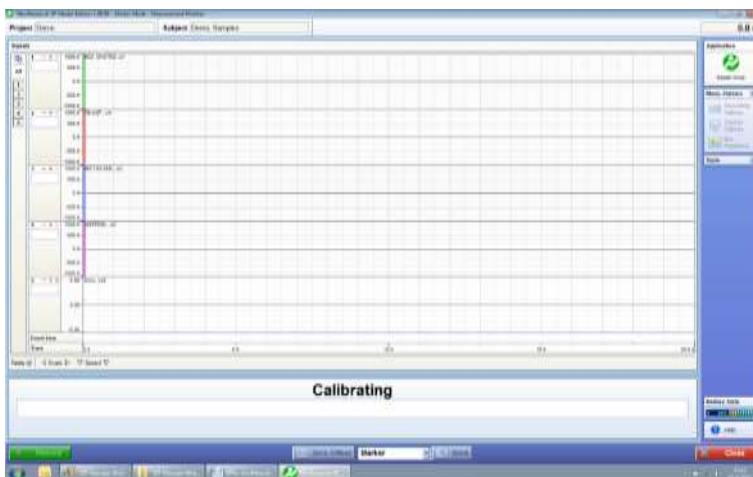

When this screen is reached, click record, on the bottom left hand side of the screen on the Noraxon software.

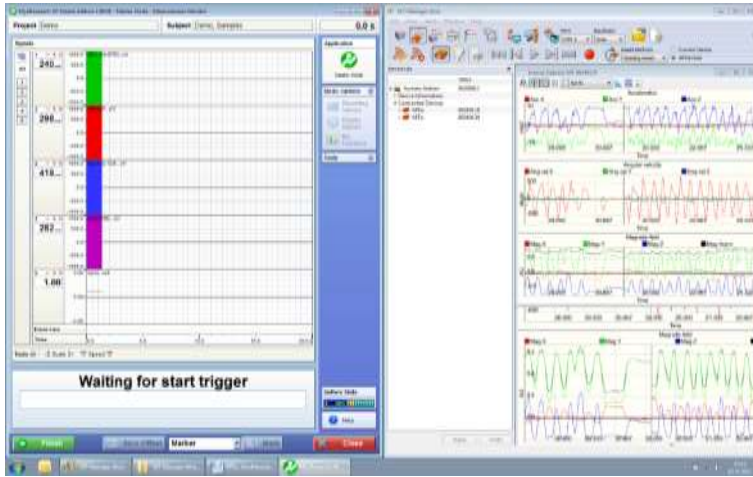

The software indicates that it is waiting for the trigger.

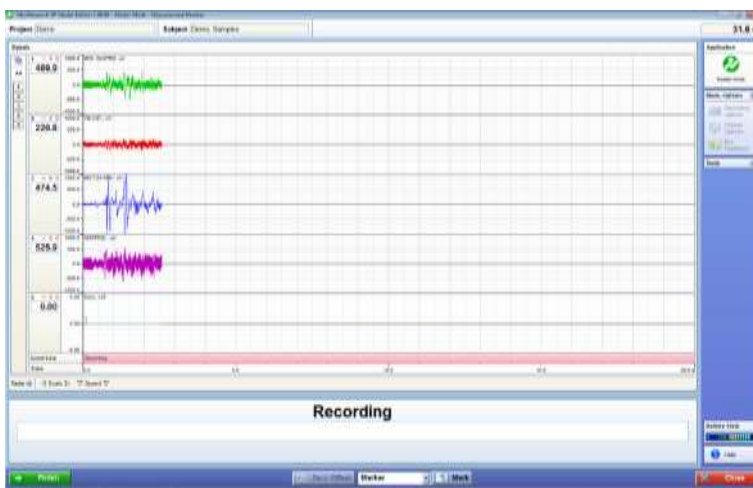

Press Record in MVN Studio, and the Noraxon software indicates that recording has started.



Repressing record in MVN Studio will stop the recording on both systems, where Noraxon will again indicate waiting for start trigger.

23.7.3.4 Awinda Station Receives Sync Signal (Noraxon Sends Sync Signal)

For the Xsens system to send the synchronization commands, the mini-receiver from Noraxon is not needed.



Hardware requirements:

Noraxon Hardware	Xsens Hardware
Wireless EMG transmitters 1 TeleMyo DTS (plus antenna) 1 TeleMyo mini-receiver (plus antenna)	MVN System Awinda Station

Both systems of course also need related cables to connect to each other (with BNC connectors at each end) and a USB cable to connect to the PC.

In addition to the normal MTw hardware setup, set up the hardware of the Noraxon system as follows:
 USB port of TeleMyo mini-receiver to USB of PC.
 Connect jack connector to Sync Out port of TeleMyo mini-receiver to BNC connection Sync In 1 of Awinda Station.
 Manual trigger pulse, jack connector to Sync In port of TeleMyo mini-receiver.
 Connect the external antenna to the TeleMyo DTS.
 When successfully connected and switched on, the TeleMyo DTS will display “WiFi ready”.

23.7.3.5 Software Setup: MVN Studio

Sync In	
Select Start Recording Select In 1 Polarity: Rising Edge Trigger Once: Uncheck Skip first = 0 Skip factor = 1	Select Stop Recording Select In 1 Polarity: Rising Edge Trigger Once: Uncheck Skip First = 1 Skip Factor = 1

To initialize recording, ensure that the MVN System has been correctly initialized (body dimensions and well calibrated). MVN Studio will wait for a signal from the Awinda Station to start a recording.

23.7.3.6 Software Setup: Noraxon MyoResearch Software:

Based on the output settings described for MVN Studio, the settings for Noraxon MyoResearch software can remain the same. The difference is that instead of the trigger pulse coming from the record button in MVN Studio, this now comes from the manual button connected to the mini-receiver. Additionally, the mini-receiver should be set up as follows:
 Go to the hardware menu;
 Select the TeleMyo mini-receiver from the list of icons;
 Select: settings;
 Select: Configure;
 Ensure that the wireless sync is “External Pulse” and Input Range is $\pm 5V$



The rest of the software setup is as described in Section 23.7.3.6. However, instead of clicking Record in MVN Studio, press the hardware trigger from Noraxon to generate a manual trigger to both systems.

23.8 More Synchronization Examples

Visit the [Xsens website for synchronization examples](#) of Xsens tried and tested with a number of third party hardware systems. While these examples are currently on the MTw page, the parameters have also been proven for MVN.

EMG	Pressure Mats	Optical Systems
Noraxon Delsys Cometa Wave	GAITRite	<ul style="list-style-type: none"> Vicon



24 References

- i Wu G, Cavanagh PR (1995). ISB recommendations for standardization in the reporting of kinematic data. J. Biomech. 28: 1257-261
- ii Wu G., Siegler, S., Allard, P., Kirtley, C., Leardini, A., Rosenbaum, D., Whittle, M., D’Lima, D., Cristofolini, L., Witte, H., Schmid, O., Stokes, I., (2002). ISB recommendation on definitions of joint coordinate system of various joints for the reporting of human joint motion—part I: ankle, hip, and spine. J. Biomech 35:543–548
- iii Wu G, van der Helm FC, Veeger HEJ, Makhsous M, van Roy P, Anglin C, Nagels J, Karduna A, Mc Quade K, Wang X, Werner FW, Buchholz B (2005) ISB recommendation on definitions of joint coordinate systems of various joints for the reporting of human joint motion—part II: shoulder, elbow, wrist and hand. J Biomech 38:981–992
- iv Della Croce U, Leardini A, Chiari L, Della Croce A. (2005) Human movement analysis using stereophotogrammetry. Part 4: assessment of anatomical landmark misplacement and its effects on joint kinematics; Gait & posture; vol. 21, no2, pp. 226-237
- v Šenk M, Cheze L. (2006) Rotation sequence as an important factor in shoulder kinematics. Clinical Biomechanics 21 S3 S8
- vi Grood, E.S., Suntay, W.J., (1983). A joint coordinate system for the clinical description of three-dimensional motions: application to the knee. J. Biomechanical Engineering 105:136-144