

English

User's Manual

(Outdoor MD IP Camera Series)

Firmware V0.95



Please read this manual carefully before you attempt to install this product and retain it for your future reference.

Contents

Main Features	5
Physical Description	8
Installation	12
Hardware Installation.....	12
Outdoor IP Camera Connecting Guide.....	14
Network Camera with PoE Function.....	15
Camera setup installation & Usage	16
Assigning an IP address to the Camera with Camera Setup.....	19
Network Camera Screen and Setup Window.....	21
Viewing the camera from your mobile phone	25
Network Camera Setting Interface.....	26
Camera.....	28
Camera Setup	28
Stream Setup	29
OSD Setup	32
Night Vision Setup (IR IPCAM)	33
Network	34
Wireless Setup.....	34
TCP/IP Setup	36
PPPoE Setup.....	38
DDNS Setup.....	39
UPNP Setup.....	40
Alarm	43
Motion Detection.....	43
Schedule Setup	45
Alarm Management.....	46
Periodic Sending	48
Buffer Management.....	50
Alarm Server	51
FTP Server.....	51
e-Mail Server	52
HTTP Server	53
Storage.....	54
Record on Alarm	55
Snapshot on Alarm.....	56
Continuous Record.....	57
Snapshot at Interval.....	58
FTP Sending	59
Browse Storage.....	60
Format SD Card.....	61
Tools.....	62
System Identity	62
User Management	63
Date & Time.....	64
Backup or Reset	65
Firmware Upgrade	66
SPEEDREAD YOUR NETWORK CAMERA.....	67
Wizard	67
System	68
Support	68
Reboot	68
ADVANCED SETTINGS.....	69
Port Forwarding.....	69
Proxy Server Setting.....	70
Reset the camera.....	71
CONNECTED DIRECTLY TO A COMPUTER	72
DEFAULT SETTINGS.....	73
SPECIFICATIONS	77
TROUBLESHOOTING	78
GLOSSARY OF TERMS.....	79

INTRODUCTION

Thank you for your interest and support in our product and purchasing this outdoor camera. The camera can be accessed remotely, and controlled from any PC/laptop over the Intranet or Internet via web browser. The user-friendly installation procedure and intuitive web-based interface offer easy integration with your LAN environment or WiFi system. Meanwhile, the IP66-rated integrated housing shields the camera from dust and water, allowing it to be applied in the harsh weather conditions of outdoor environments. The camera also comes with a lot of useful alarm tool for notice user any situation. We feel confident that you will be pleased with the quality and features of this product.

Notice

This product may cause interferences with other wireless equipment that operates at 2.4GHz ISM band. Please turn off one of the equipments to eliminate the interference.

Product Assurance

This camera will emit electromagnetic wave, just like other wireless products, but its transmitting power is less than other wireless products such as mobile phones. The 2.4GHz wireless camera meets wireless frequency security standards and recommended indexes while working. These standards and indexes are certificated by academic organization and represent the cogitative research of the scientific workers who continuously explore and annotate the involved fields. So we believe that our products are safe for customers.

Approval Information

All our products meet the requirements of approval FCC or CE, and are granted the FCC or CE certification. They are authorized to bear FCC or CE mark.

FCC

This equipment has been tested and found to comply with the limits for a Class B digital device, pursuant to Part 15 of the FCC rules. These limits are designed to provide reasonable protection against harmful interference in a residential installation. This equipment generates, uses and can radiate radio frequency energy and, if not installed and used in accordance with the instructions, may cause harmful interference to radio communications. However, there is no guarantee that interference will not occur in a particular installation. If this equipment does cause harmful interference to radio or television reception, which can be determined by turning the equipment off and on, the user is encouraged to try to correct the interference by one or more of the following measures: -Reorient or relocate the receiving antenna. -Increase the separation between the equipment and the receiver. -Connect the equipment into an outlet on a circuit different from that to which the receiver is connected. -Consult the dealer or an experienced radio/TV technician for help.

This device complies with Part 15 of the FCC Rules. Operation is subject to the following two conditions:
(1) This device may not cause harmful interference, and
(2) this device must accept any interference received, including interference that may cause undesired operation
Changes and modification not expressly approved by the manufacturer or registrant of this equipment can void your authority to operate this equipment under Federal Communications Commissions rules.

CE

This product complies with standards including Low Voltage Device Directive 73/23/EEC; EMC Directive 89/336/EEC and R&TTE Directive 1999/5/EC. It passed the subject tests by the authority concerned and is authorized to bear CE mark.

Restrictions

1. DO NOT use this product to violate one's privacy. Monitoring one's activities without consent is illegal and this product is not designed and manufactured for such purpose.
2. DO NOT put this product near any medical equipment. Radio waves might potentially cause breakdown of electrical medical equipment.
3. This product should be placed at least 1 foot away from any heart pacemaker. Radio waves might potentially influence heart pacemaker.
4. DO NOT use this product for any illegal activities. **It is the user's responsibility to ensure that the usage of this camera is of a legal nature.**

Maintenance

1. Ensure that the camera and its power source have sufficient ventilation;
2. Do not shake, strike or drop the product;
3. Keep the camera dry and dustless and avoid exposing it to direct sunlight;
4. Do not place the product near any magnetic objects;
5. Avoid putting the product in places where there is constant temperature and humidity change;
6. Keep the product away from heat sources;
7. Do not use the camera near aggressive chemicals;
8. Do not use this camera near water;
9. Do not use the camera in the places which are enclosed by metal. The surrounding metal may shield the electromagnetic waves, and result in failure of signal reception;
10. Please obey the local government's environment protection policy;
11. Please turn off the power when left unused;
12. Do not disassemble or attempt to repair the camera; doing so might cause damage to the product.

Main Features

Easy Installation

The camera comes with built-in Wireless (IEEE802.11b/g) capability and a Web Server, therefore there is no need to install a driver. The setup CD-ROM includes the Camera Setup software, User Manual and Quick Installation Guide.

With industry standard automatic configuration-UPnP(Universal Plug and Play), your PC will discover and connect to your camera automatically. Once connected, using a simple Web browser you can see what the camera sees from anywhere in the world!

The camera can be either wall-mounted or ceiling-mounted using the supplied stand. It can also be placed on a desktop using the supplied stand, thus providing a flexible installation solution.

PoE Function

The Network Camera is with POE function, which allows it to be powered via a single Ethernet cable. you do not need to use the power plug.but your switch/router must be support PoE.

802.11b/g/n Wireless LAN Connection Available

The camera is designed to not only work with your existing wired network but also with standard 802.11b/g wireless devices, allowing the flexibility to operate the camera wirelessly. The camera utilizes SSID filtering, powerful 64/128 bit WEP and new security standard WPA encryption to protect you from illegal intrusion.

3GPP Mobile Surveillance

The camera provides the ability to view the cameras monitored through your mobile phone as a live video stream, it supports the telecommunications standard of 3GPP streaming format. All 3G enabled mobile devices and most 2G phones that support the streaming standard of 3GPP are compatible.

Simultaneous High-Speed MPEG-4 and Motion JPEG

The camera allows live the MPEG-4 and Motion JPEG streams simultaneously. The camera features MPEG4 compression which compresses the video to make transmission faster and more efficient. The MPEG4 and MJPEG image can be transmitted at 30 frames per second.

Simultaneous HTTP and RTSP streaming

The camera support HTTP and RTSP/RTP/RTCP protocol, and provide multiple HTTP and RTSP streams simultaneously.

Audio Transmission

The camera comes with a built-in microphone for audio monitoring as well as video monitoring. Sound captured by the camera is transmitted to the client's PC.

Snapshot and Recording

You can capture a still image of the camera view on your PC and save the image as JPG or BMP format file. You also can record the video and audio captured by the camera on your PC and save as an ASF format file.

Motion Detection Function

The camera can detect changes in the image being monitored. Once a change occurs it will send an email to up to 3 email addresses with a video file or snapshot attached. The video file or snapshot can also be uploaded to an FTP server. In addition the camera can be configured to send images at regular intervals.

OSD Function

OSD (On Screen Display) function can display system name, date and time, and user-defined on screen.

Authentication

An authentication window requires you to enter the user ID and password. Password security can prevent unregistered users from accessing your camera. Users can select Basic Authentication method or Digest Access Authentication method.

Multi-Client Access

The camera allows up to 16 users to view the video simultaneously. Please note that it is possible that as the number of simultaneously connected users to camera increases, the overall motion performance will decrease.

Infrared Night Vision (IR-CUT)

The camera built-in IR-Cut which is prevent the image to happen color cast during daytime ,it can be switching and filter infrared light in day/night.

The camera utilizes 12 infrared LED to provide high light in darks environment .when the environment is dark, the LED will be opened automatically due to a photosensitive component, and the moving images will be changed to Black and White. Users can monitor clearly the things within 15 meters distance. Users also can select open or close the infrared LED manually, and select whether change the images to black and white or color automatically.

Adapter

This product conforms with the authenticated AC adapter. The adapter is marked with one or more of the following:



UL Mark

American power supply authentication



SAA Mark

Australia power supply authentication



CE Mark

European Union power supply authentication



PSE Mark

Japan power supply authentication



GS Mark

German power supply authentication



CCC Mark

China power supply authentication

Note: When using the power adapter, make sure the rating voltage on it is compatible with that of the device to avoid potential damages resulting from incorrect usage of power supply.

PC System Requirements

The PC (Personal Computer) and the network must meet the following technical specifications for camera to work properly.

1. Processor: Intel Pentium III, 1GHz or Higher (Pentium IV, 2 GHz or Higher recommended)
2. RAM: 256 MB or more
3. Color Monitor: Suggest at least 1024x768 and the latest driver for the Display Adapter
4. OS (Operating System): Windows XP/Vista/7, MAC OS, Linux, Android, iPhone OS, Windows Mobile, BlackBerry OS
5. Web Browser: Microsoft IE, Safari, Mozilla Firefox, Google Chrome and most other browsers
6. Network Protocol: TCP/IP network protocol installed
7. Interface: 10/100 Mbps Ethernet® card/Wireless Network card for your network connection
8. Other: CD-ROM Drive

Physical Description

Front panel

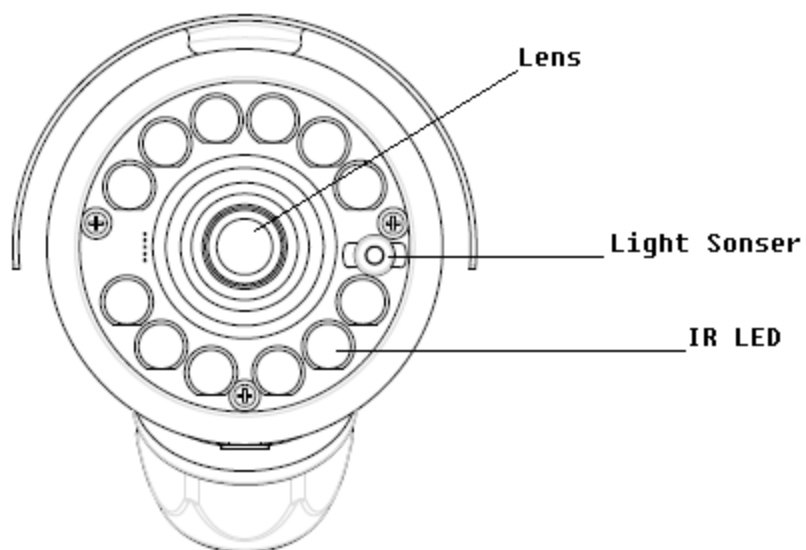

Connectors

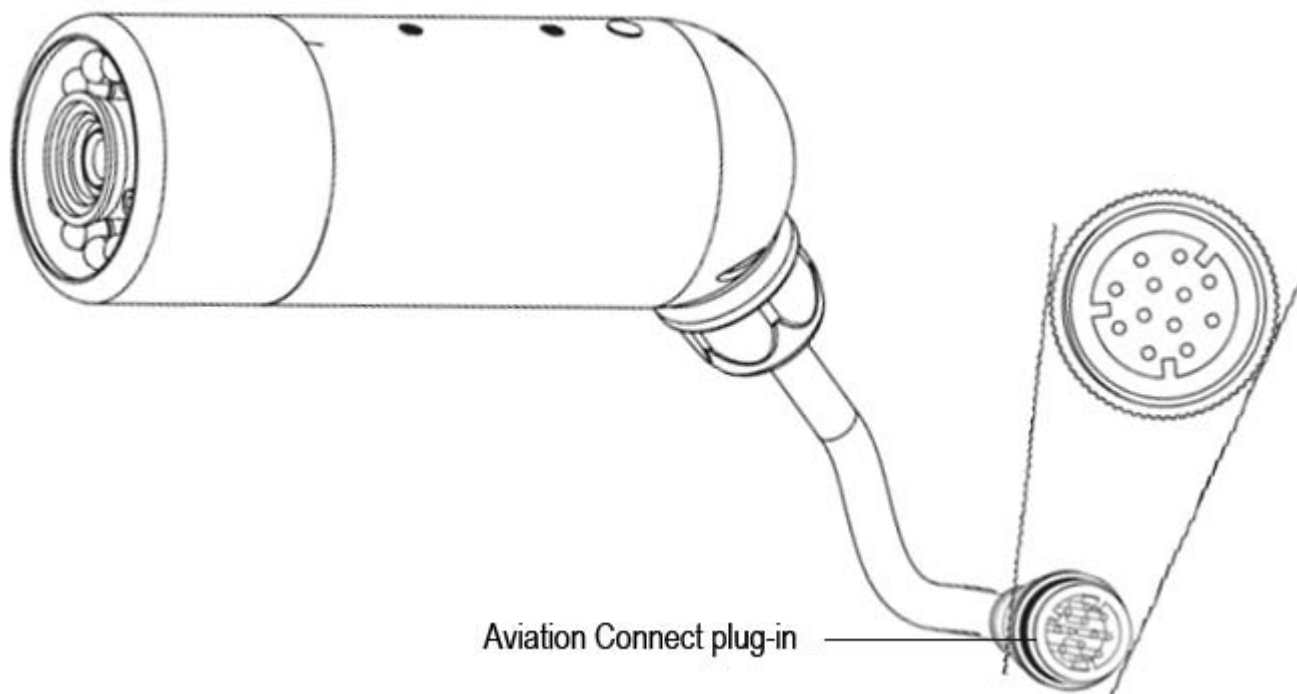

Adapter Box

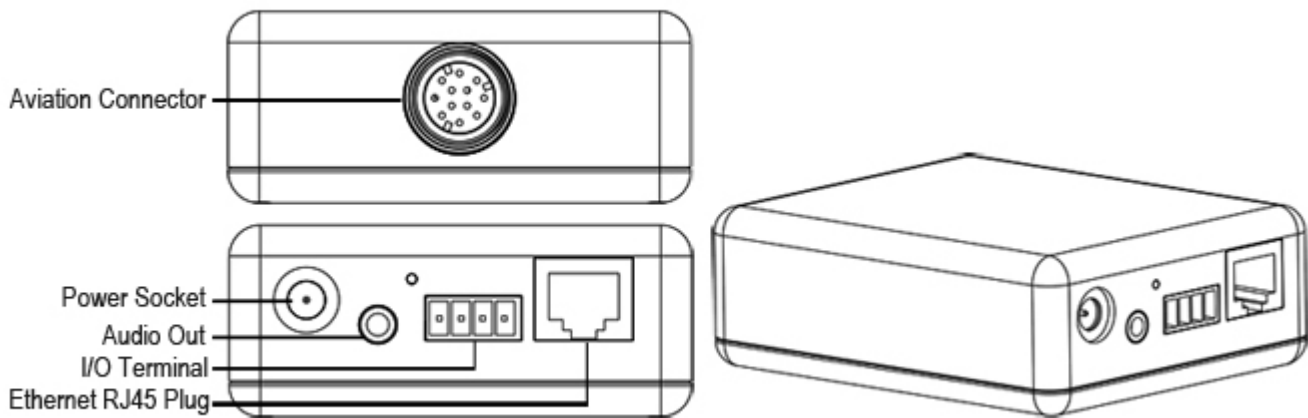

General I/O Terminal Block

This Network Camera provides a general I/O terminal block which is used to connect external input / output devices. The pin definitions are described below.

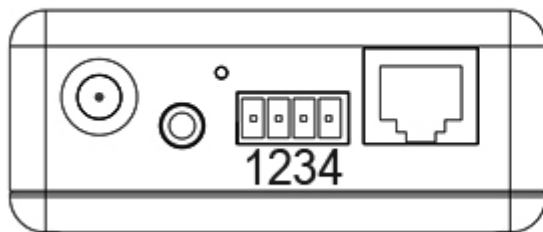

- 4- GND: Ground
- 3- DI: Digital Input
- 2- DO: Digital Output
- 1- 12V: Power, 12V DC

Pin No.	Pin Name	Function	Description
4	GND	Ground	This is a signal ground use for DI and DO
3	DI	Digital Input	Connect to GND to activate or deactivate by software setting
2	DO	Digital Output	With a maximum load of 1A and maximum voltage of 60V DV, this output has an open-collector NPN Darlington transistor with the emitter to the GND pin. If used with an external relay, a diode must be connected in parallel with the load, for protection against voltage transients.
1	12V	Power +12V	12VDC \pm 10%, max. 0.4A

DI/DO Diagram

Please refer to the following illustration for the connection method.

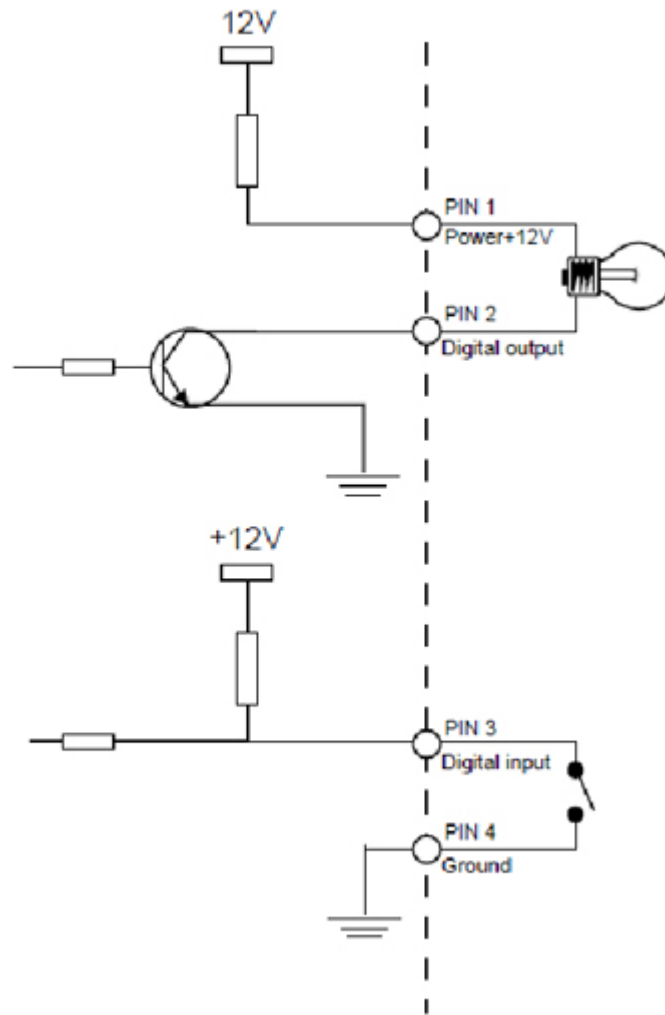

Status LED

The LED indicates the status of the Network Camera.

- 1) Green LED - Power is being supplied to the Network Camera.
- 2) Blinking Orange LED – IP camera has been connected and data is present.

Hardware Reset

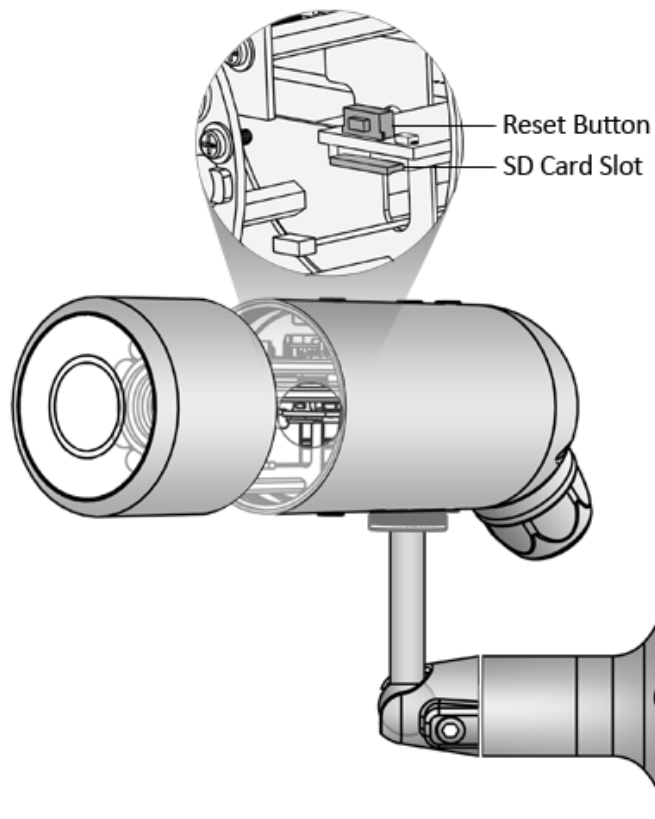

The **Reset** button is used to restore the factory default settings. Sometimes resetting the system can return the camera to normal operation.

Restore - Press and release the reset button with a paper clip or thin object. The LED light will be out, after few seconds it will relight again. (**Note:** that all settings will be restored to factory default)

Installation

Hardware Installation

Follow the steps below to install the Network Camera:

1. Open the lens cover.
2. Secure the Network Camera to the supplied camera stand as the illustration shows.
3. Secure the Network Camera to the wall/ceiling by the supplied camera stand.

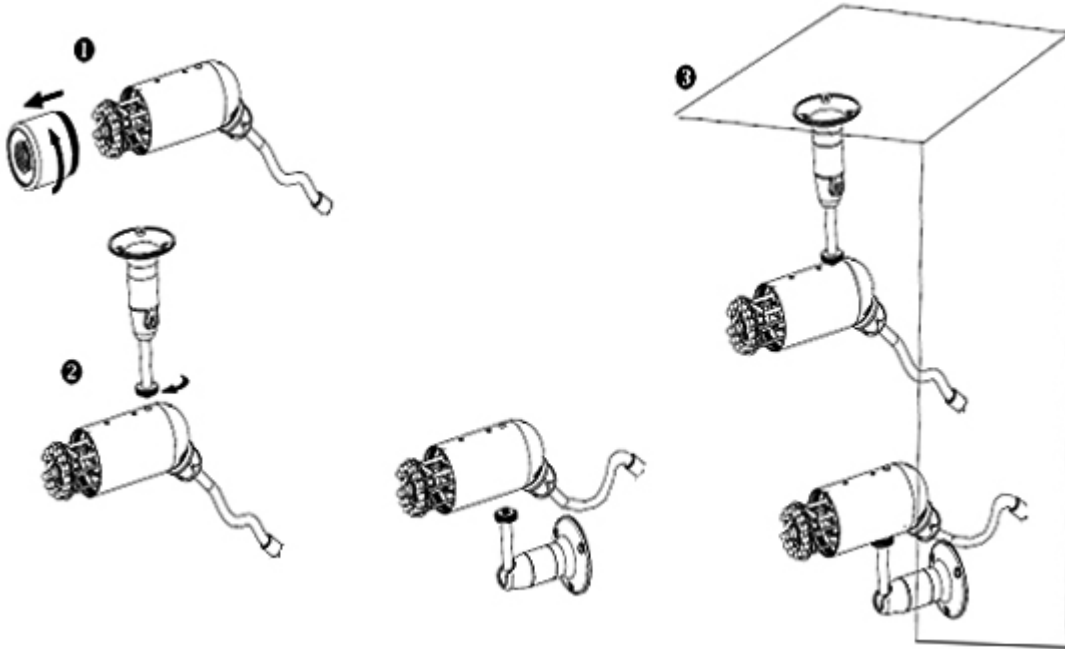

4. Open the lens cover and insert "SD card" then tighten the lens cover.

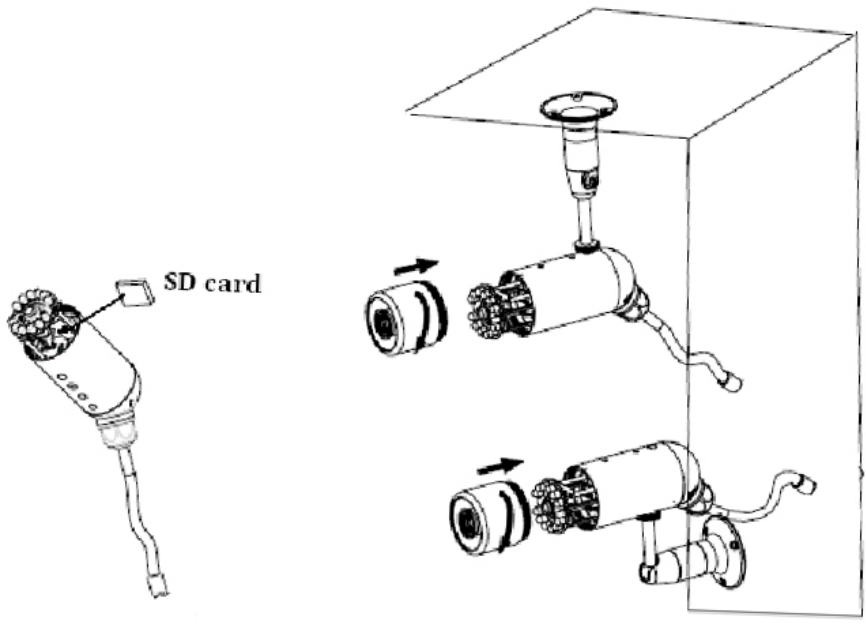

Note

If you want to use the supplied sun shield for outdoor environments, please follow the steps below to install:

1. Attach the supplied sun shield to the Network Camera and slide it to the desired position.
2. Fix the sun shield with supplied screws and washers. (Please use different screws for ceiling mount.)
3. Secure the Network Camera to the wall/ceiling by the supplied camera stand.

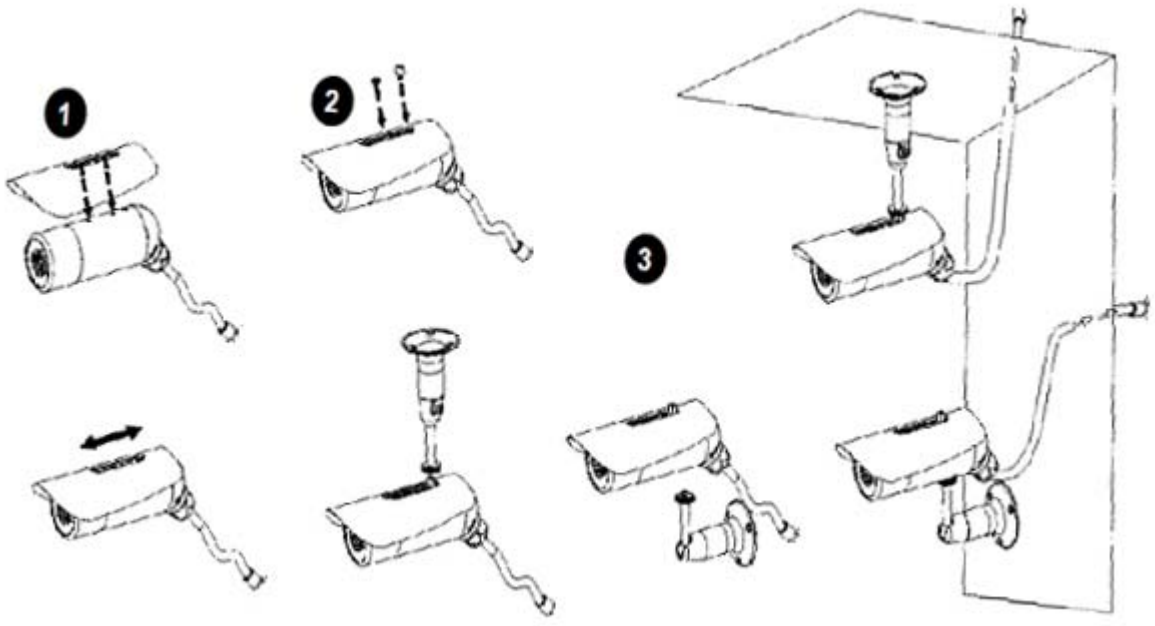

Outdoor IP Camera Connecting Guide

For initial setup, you need to connect the IP Camera directly to your router, switch or computer via a network cable. **You cannot connect wirelessly to the camera without first setting it up via a network cable.**

You should connect the Camera into your internet router (normally supplied by your broadband provider), a switch box or hub (that is connected to your computers network) or directly to your computer (gives limited viewing options, so this is not recommended).

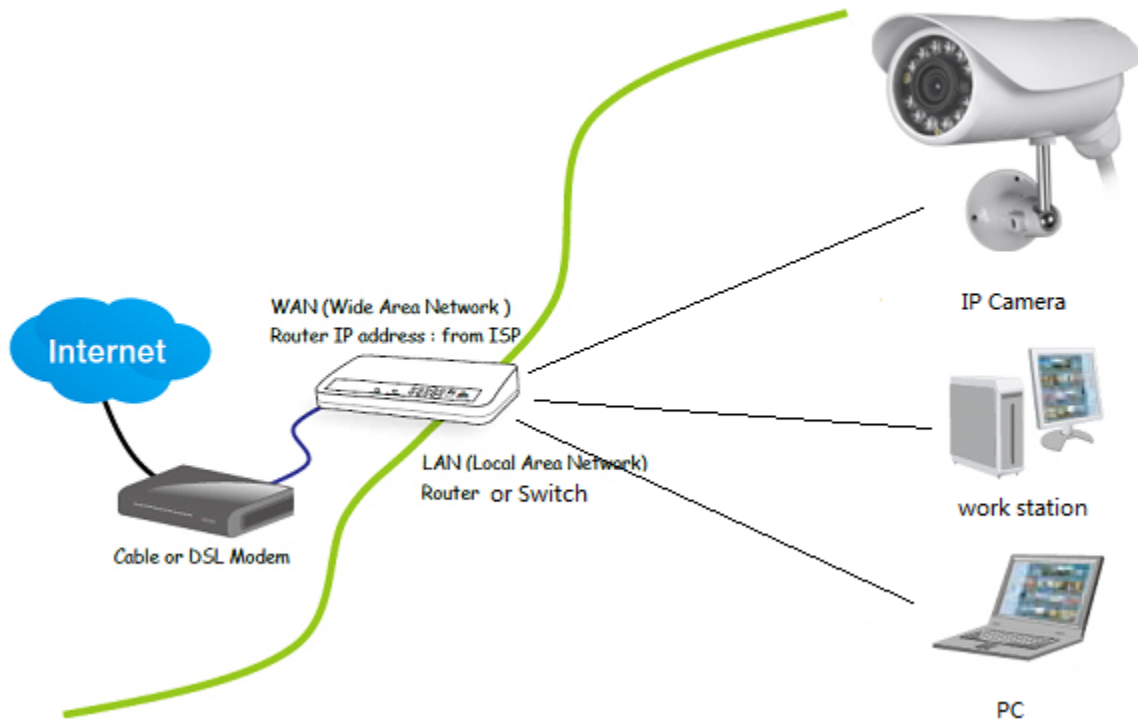

Connection via a Router/Switch

1. Using the standard Ethernet network cable, plug this in to the network connection socket on the IP Camera at one end, and plug the other end in to a spare port on your router/switch.
2. Using the Power Adaptor (supplied), plug one end in to the Power Connection socket on the IP Camera. Plug the other end in to an electrical socket and turn the power on.
3. The Connectivity Status indicator on the front of the camera will light up. Your router/switch will then begin to communicate with the camera.

Connection directly to a computer

Choose this connection for testing the IP Camera to avoid any interference from other equipment, please refer to Chapter [Connected Directly to a Computer](#) for details.

Network Camera with PoE Function

1. When using a PoE-enabled switch

The Network Camera is PoE-compliant, which allows it to be powered via a single Ethernet cable. If your switch/router supports PoE, refer to the following illustration to connect the Network Camera to a PoE-enabled switch/router.

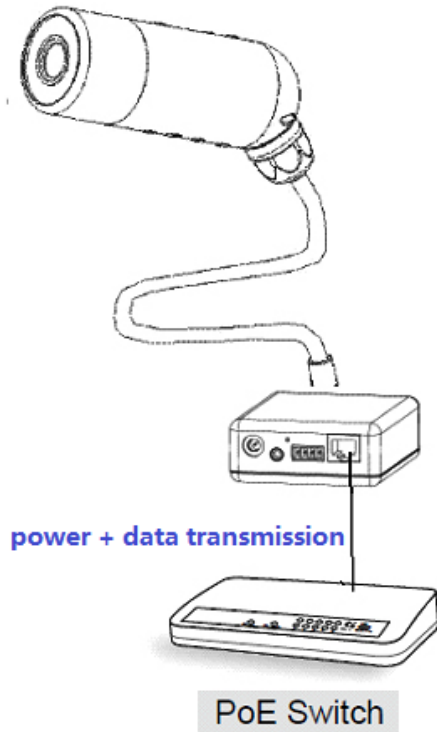

2. When using a non-PoE switch

If your switch/router does not support PoE, use a PoE power injector (optional) to connect between the Network Camera and a non-PoE switch/router.

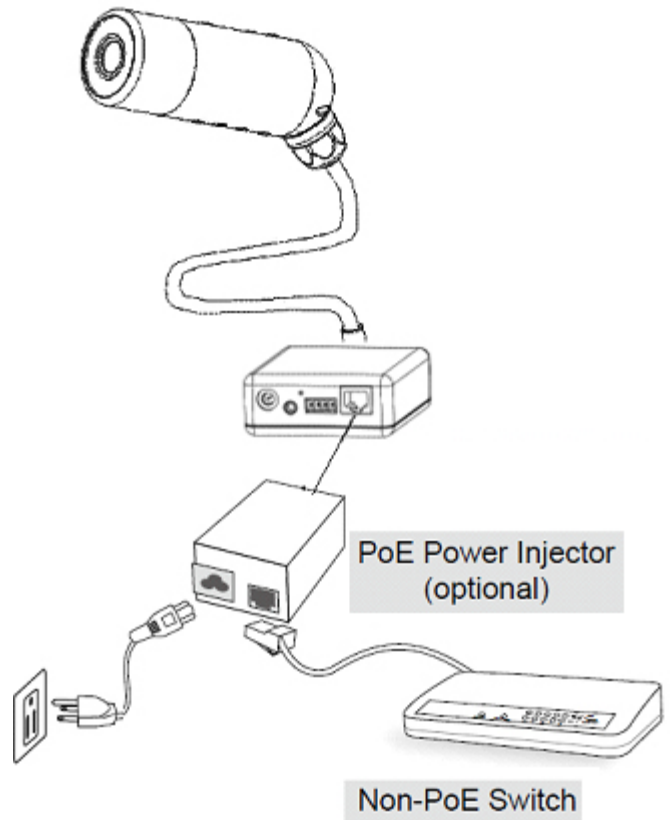

Camera setup installation & Usage

The camera Setup utility can easily and quickly detect cameras connected to your local network and list them on the Camera Setup window, also you can use the camera Setup utility to assign an IP address to each camera.

1. Insert the Installation CD into your CD-ROM drive and the installation screen should appear automatically (See *image below*). If it does not, click “Start” then “Run”. In the text field enter “D:\autorun.exe” (if “D:” is the letter of your CD-ROM Drive)

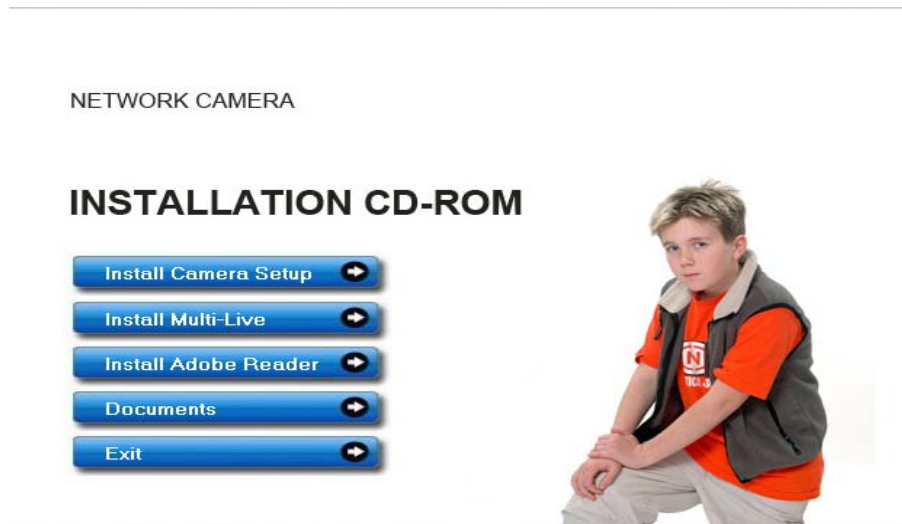

2. Click on “Install Camera Setup” and the following screen will be displayed.

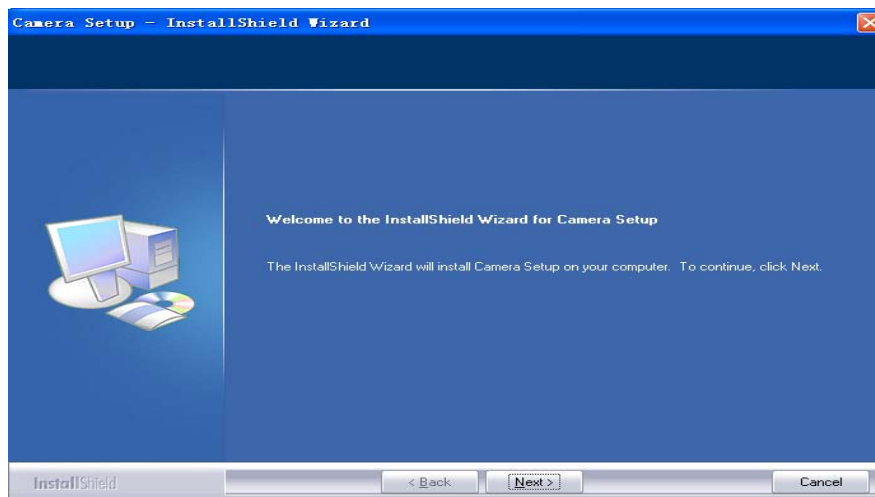

3. If you want to change the default folder click “Change” to replace otherwise click “Next”

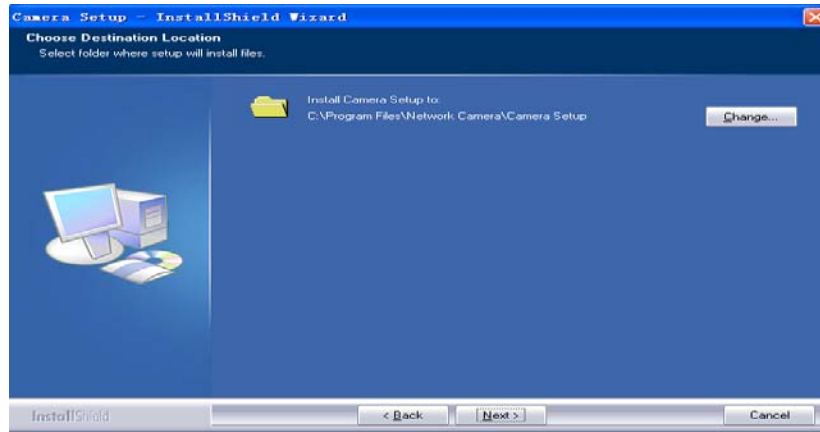

4. Click **Install** to install **Camera Setup**.

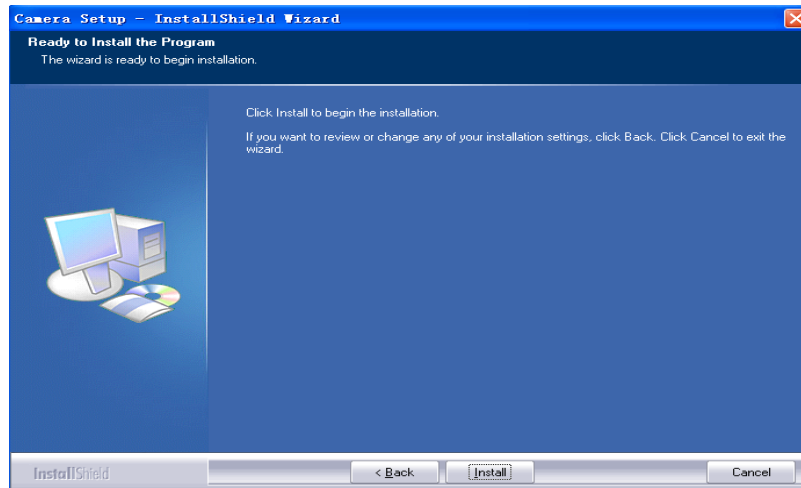

5. Click **Finish** to end the installation. You should now find a icon  on the desktop.

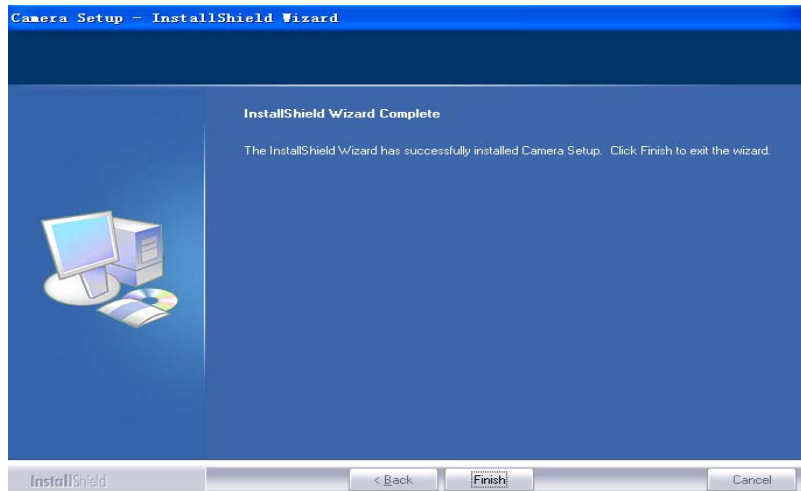

6. Double-click the Camera Setup icon  on the Desktop to launch the program. The Camera Setup utility should automatically find your camera if it is correctly connected (See image below).

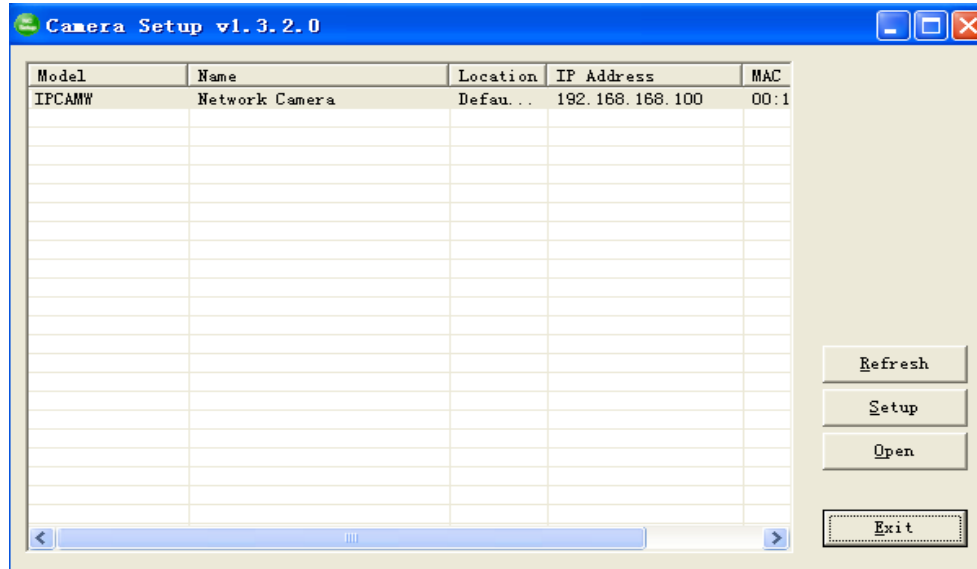

- [Refresh]** Click **Refresh** to search for cameras on the local network.
 - [Setup]** Select the required camera and click **Setup** to configure the network settings for the camera.
 - [Open]** Select the required camera and click **Open** to access the camera via a web browser.
 - [Exit]** Click **Exit** to exit the Camera Setup window.
- Note:** Select and double click one of the cameras from the Device list, to open the camera view via the web browser.

Assigning an IP address to the Camera with Camera Setup

1. Launch Camera Setup program to detect cameras on the local network.
2. Click on “Setup” button and the following setup interface will pop up.

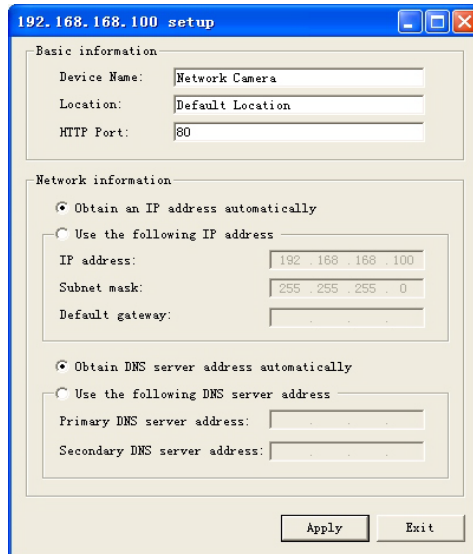

The screenshot shows a window titled "192.168.168.100 setup" with a blue title bar. The window is divided into two main sections: "Basic information" and "Network information".

Basic information:

- Device Name: Network Camera
- Location: Default Location
- HTTP Port: 80

Network information:

- Obtain an IP address automatically
- Use the following IP address
 - IP address: 192 . 168 . 168 . 100
 - Subnet mask: 255 . 255 . 255 . 0
 - Default gateway:
- Obtain DNS server address automatically
- Use the following DNS server address
 - Primary DNS server address:
 - Secondary DNS server address:

At the bottom of the window are two buttons: "Apply" and "Exit".

3. Enter a unique name for the camera, the location (optional) and leave the default port number as 80. “Obtain an IP address automatically” and “Obtain DNS server address automatically” are selected by default, if you are confident enough to enter your own settings, you can do so by selecting “Use the following IP address” and follow the guidelines on the next page. If however you wish to leave the default settings please skip to **NETWORK CAMERA SCREEN AND SETUP WINDOW**.

4. To obtain the IP addresses specific to your network, click “Start” then “Run” and type “cmd” in the text box and click “Ok”. This will bring up the MS-DOS prompt and in this window type “ipconfig/all” and press enter. A screen similar to the one below will be displayed.

```
C:\WINDOWS\system32\cmd.exe
C:\>ipconfig/all

Windows IP Configuration

    Host Name . . . . . : OFFICE
    Primary Dns Suffix . . . . . :
    Node Type . . . . . : Unknown
    IP Routing Enabled. . . . . : No
    WINS Proxy Enabled. . . . . : No

Ethernet adapter Local Area Connection:

    Connection-specific DNS Suffix . :
    Description . . . . . : Intel(R) 82562U 10/100 Network Connection
    Physical Address. . . . . : 00-19-D1-63-3D-50
    Dhcp Enabled. . . . . : Yes
    Autoconfiguration Enabled . . . . : Yes
    IP Address. . . . . : 192.198.1.52
    Subnet Mask . . . . . : 255.255.255.0
    Default Gateway . . . . . : 192.198.1.1
    DHCP Server . . . . . : 10.10.10.1
    DNS Servers . . . . . : 194.106.56.6
                           194.106.33.42
    Lease Obtained. . . . . : 31 May 2007 17:01:18
    Lease Expires . . . . . : 31 May 2007 19:01:18

C:\>
```

5. Take note of the following:

- i) IP Address
- ii) Subnet Mask
- iii) Default Gateway
- iv) DNS Servers (Both numbers with the first being the primary DNS server and the second being the secondary DNS server)

6. Enter the details noted in step 5 into the relevant fields.

Note: The default IP address of the camera is 192.168.168.100. This can be changed to any IP address on your IP range. For example if the IP address of your PC is 192.198.1.52 then the IP address of your camera should be unique and on the same subnet, i.e. 192.198.1.X where X is any number between 1 and 255 except 52. Ensure the IP address you chose is not the same as other network devices on your network as this will result in conflict and may cause the device to not to work properly.

7. Once you've entered all the details click "Apply" then "Exit".

Network Camera Screen and Setup Window

Review Images from the Network Camera

You can select one of the three ways to review pictures from the camera.

1. Input the assigned IP address (or URL) of the camera on the Web Browser. Take 192.168. 168.100 as example. You will see the home page.



Notes:

Through this welcome page, you could choose to click on the item **Enter** to access the picture viewing interface or the item **Setting** to access the system setting interface. The below dialog will appear. Input the correct username (the default is **admin**, in lowercase) and password (the default is **admin**, in lowercase). You are allowed to enter the picture viewing interface or the system setting interface.



The general users assigned by the administrator are not allowed to enter the system setting interface. They can only be permitted to enter the picture viewing interface.



IPCAMW
(192.168.168.100)

2. If your OS is Windows XP, click **[My Network Places]**, double click the icon
You will see the home page.

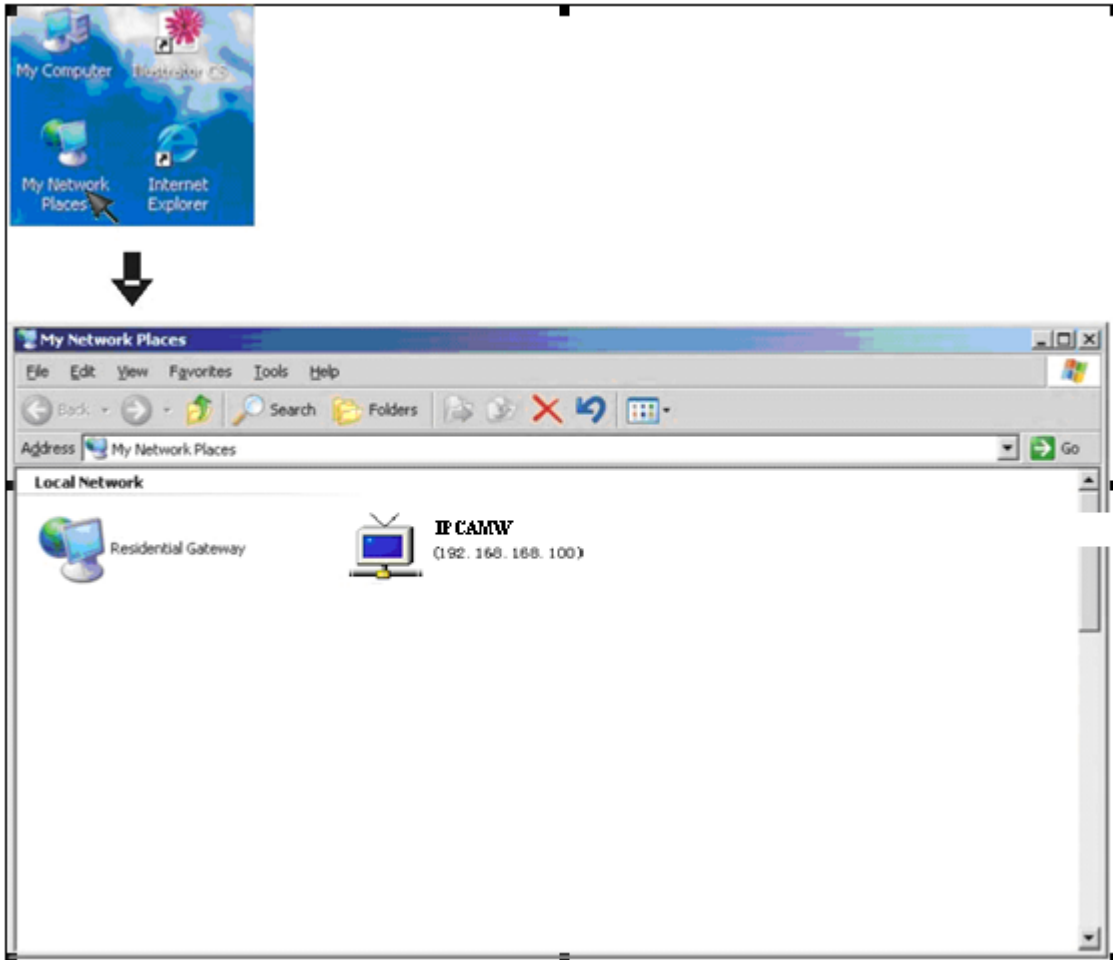

3. Run the **Camera Setup** and double-click the relevant camera item.

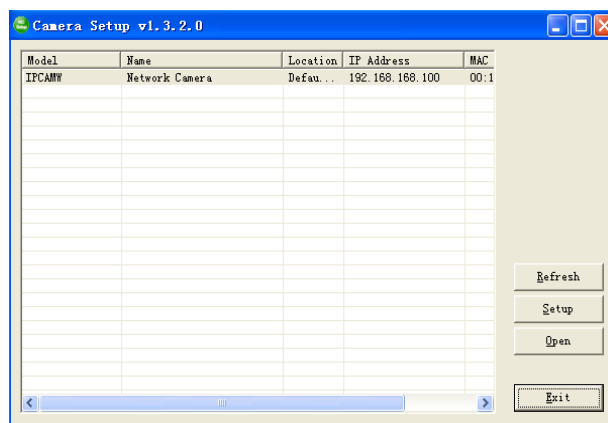

Click **Enter**, you will see the screen.

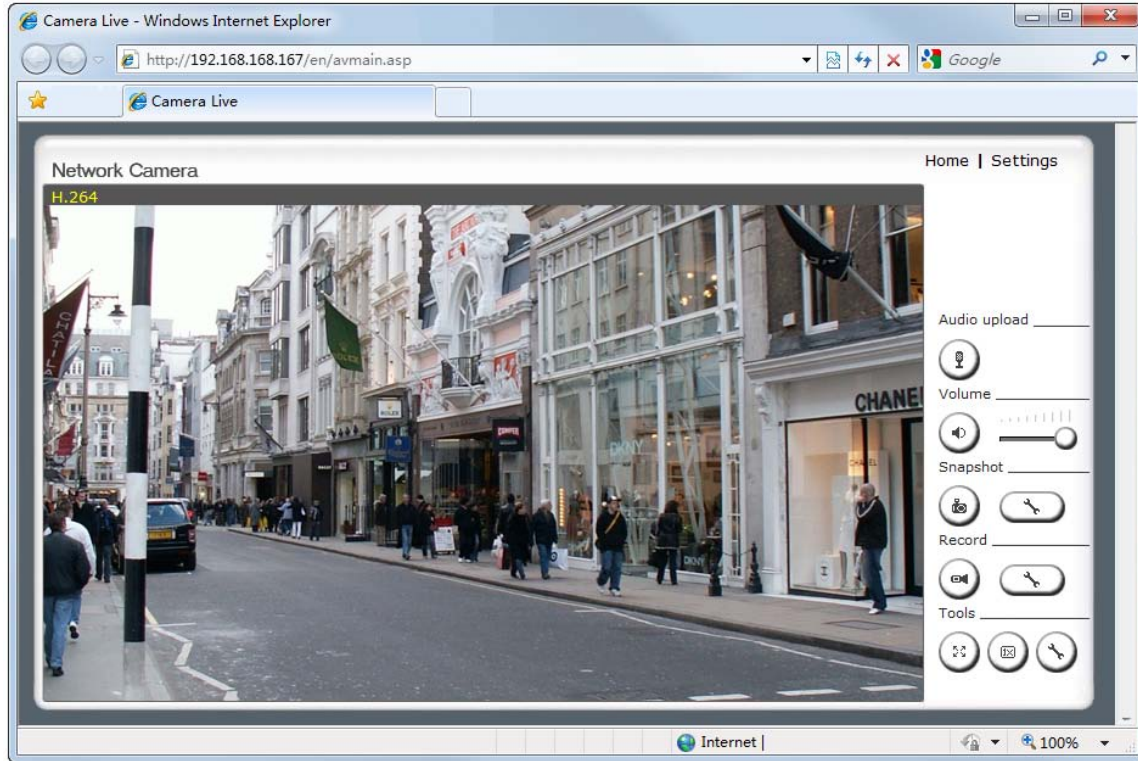

Audio upload _____



[Audio Upload]



Press and release to start sending audio from your computer's microphone to the camera speakers. Press and release to stop sending audio.

Volume _____



[Volume]



1. Click the **Mute** button to mute the audio.



2. Slide the **Slide block** horizontally to adjust volume.



Snapshot _____



[Snapshot]



1. Press the **Snapshot** button to capture a still image of the camera view.



2. Press this button To change default Snapshot path, The file is automatically assigned the data & time of the snapshot.

[Record]

Record



1. Press the **Record** button  to record video and audio.

2. Recording Config. Click this button  to set the recording parameters, you can set record path, video file size and select whether to start recording automatically when motion is detected and the length of the recording in seconds.

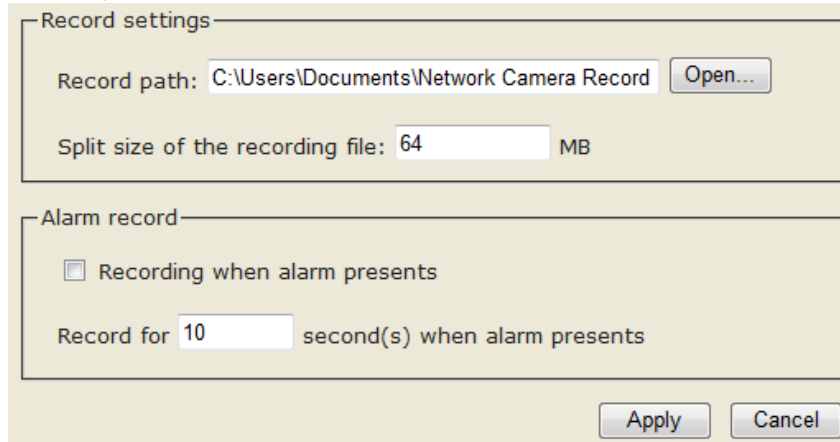

Record settings

Record path: C:\Users\Documents\Network Camera Record

Split size of the recording file: 64 MB

Alarm record

Recording when alarm presents

Record for 10 second(s) when alarm presents

[Tools]

Tools

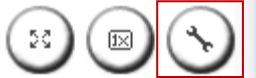

1. For **Full Screen mode** click this button , Press **Esc** to exit. It could also achieve same function by double click the **Image Field**.

2. For Fill up the **Image field** click this button .

3. This button  for **Stream Type, Video Codec Settings**.

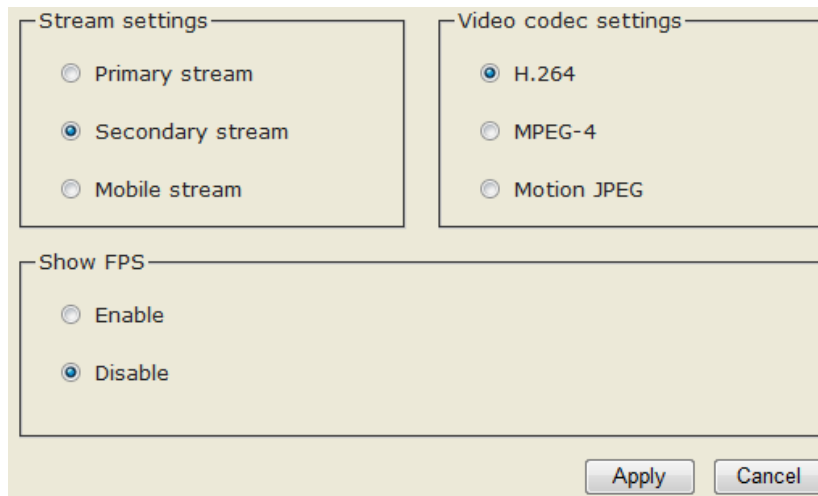

Stream settings

Primary stream

Secondary stream

Mobile stream

Video codec settings

H.264

MPEG-4

Motion JPEG

Show FPS

Enable

Disable

Viewing the camera from your mobile phone

The camera provides the ability to view the cameras monitored through your mobile phone as a live video stream, it supports the telecommunications standard of 3GPP streaming format. All 3G enabled mobile devices and most 2G phones that support the streaming standard of 3GPP are compatible. Otherwise, you also can view the pictures even if your phone is not 3GPP compatible.

For example, if camera's external IP address is 202.96.135.206 and external port is 8151, then type **http://202.96.135.206:8151/mobile** in your Internet browser address bar of mobile phone, the login screen will appear:

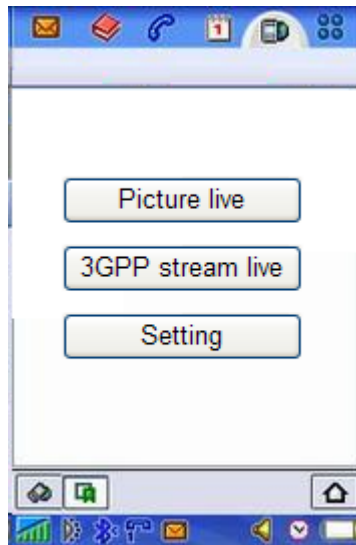

To click the "Picture live" button if your mobile phone is not 3GPP standard, then you can view the pictures which will refresh every 3 seconds.

To click the "3GPP stream live" if your mobile phone support 3GPP standard, and the following screen will appear:

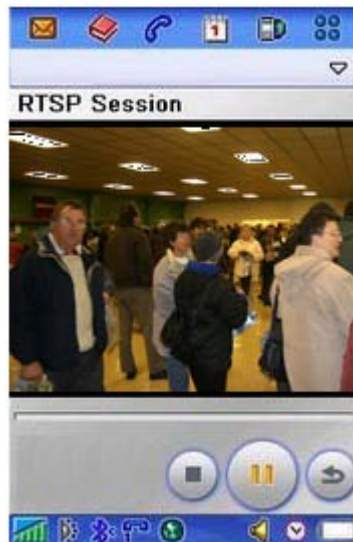

Note: You have to click "Setting" button, make sure that the Mobile stream is enabled and the RTSP authentication is disabled before you view the 3GPP stream live.

Network Camera Setting Interface

1. Click on **settings** from the home page. When connecting the camera for the first time or after resetting it to its default settings, the setup interface start page below will load. It is recommend that you change the **admin** password in order to avoid unauthorized access to the camera. To do this follow the instructions by clicking on the underlined link "here" to access administrator password editing page.

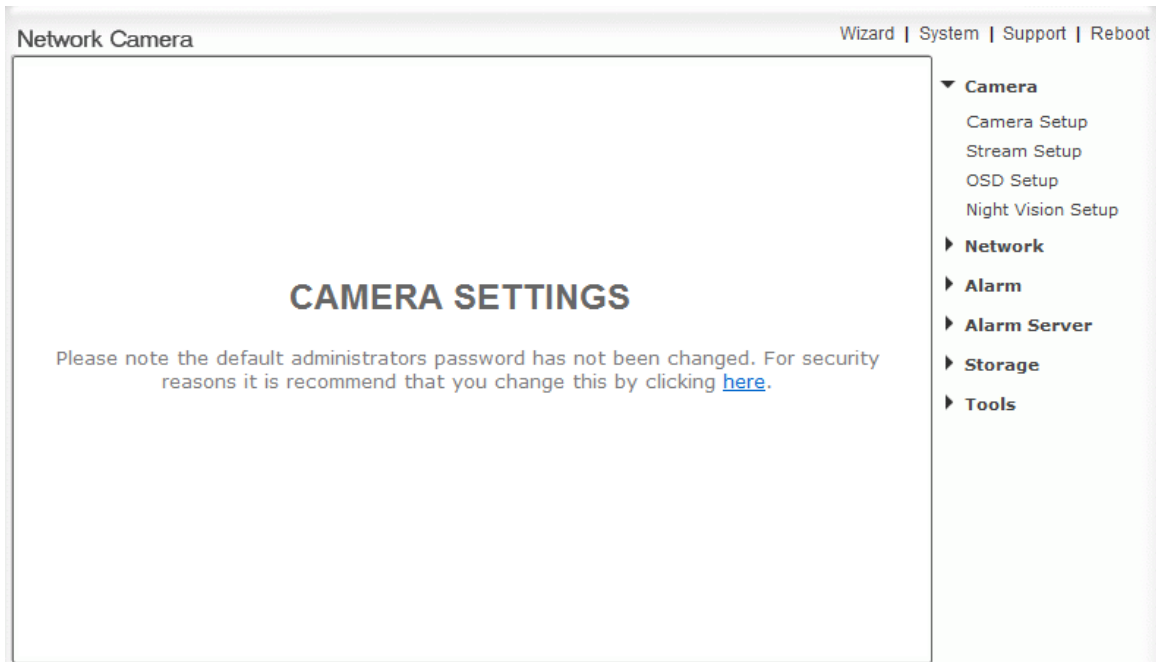

2. Type the password in both fields then click **Save**. Please take note of the password. If you forget the password, the camera will have to be reset to its default settings in order to gain access to the settings page and this will also reset all other settings you may have changed.

Edit user

User name:

Password:

Re-type password:

3. You are required to re-login with the changed password.



After successful login, the following page will appear.

*** User modified successfully!**

Camera user list

No.	User name	Group
1	admin	Administrators

Add

Camera

▼ Camera

- Camera Setup
- Stream Setup
- OSD Setup
- Night Vision Setup

Camera Setup

From the home page click **settings** and enter the administrator user name and password. Click on **Camera Setup** under the title **Camera** to change the image and audio parameters of the camera.

Camera setup

Camera:

- Light frequency: 50Hz ▾
- Image mirror: On Off
- Image flip vertical: On Off
- Moonlight mode: Auto On Off
- Power LED light: On Off
- Show FPS in ActiveX: On Off

Microphone:

- Enable Disable
- Volume: 10 ▾
- G.726 bit rate: 16 ▾ kbps
- AMR bit rate: 5.9 ▾ kbps

Apply

[Light frequency] Two options: 50Hz & 60Hz. Set according to the mains frequency in the country of use. For UK this would be 50Hz.

[Image mirror] Image can be flipped from left to right.

[Image flip vertical] Image can be flipped up and down.

[Moonlight mode] Turn **On/OFF** the brightness setting according to the light intensity of the area being monitored manually. **[Auto]** automatic enhance ambient brightness when it is necessary.

[Power LED light] Turn on/off the power & network LED indicator of camera.

[Show FPS in ActiveX]Show FPS On/Off in ActiveX control.

[Microphone] Turn on/off the built-in microphone.

[Mic volume] Adjusts the volume of the microphone from 0~14 where 0 is the lowest.

[Audio bit rate] Four options: 16, 24, 32, 40(kbps). Determines the quality of the audio being transmitted.

[AMR bit rate] Eight options will Determines the quality of the audio being transmitted.

Click **Apply** to confirm your settings.

Note: If the camera is inversely installed, images flip horizontally and images flip vertically should be turned on at the same time.

Stream Setup

The camera supports three streams: primary stream, secondary stream and mobile stream.

Stream setup

Primary stream:

Preset:	Please choose bandwidth status... ▾
Image size:	1280x720 ▾
Frame rate:	30 ▾ fps
MPEG4 bit rate:	2048 ▾ kbps
MJPEG quality:	50 (20-100)
Snapshot quality:	90 (20-100)
Audio:	<input checked="" type="radio"/> Enable <input type="radio"/> Disable
RTSP authentication:	<input type="radio"/> Enable <input checked="" type="radio"/> Disable

Secondary stream:

	<input checked="" type="radio"/> Enable <input type="radio"/> Disable
Preset:	Please choose bandwidth status... ▾
Image size:	640x352 ▾
Frame rate:	10 ▾ fps
MPEG4 bit rate:	120 ▾ kbps
MJPEG quality:	50 (20-100)
Snapshot quality:	90 (20-100)
Audio:	<input checked="" type="radio"/> Enable <input type="radio"/> Disable
RTSP authentication:	<input checked="" type="radio"/> Enable <input type="radio"/> Disable

Mobile stream:

	<input checked="" type="radio"/> Enable <input type="radio"/> Disable
Preset:	Please choose mobile bandwidth... ▾
Image size:	176x144 ▾
Frame rate:	6 ▾ fps
MPEG4 bit rate:	30 ▾ kbps
Snapshot quality:	70 (20-100)
Audio:	<input checked="" type="radio"/> Enable <input type="radio"/> Disable
RTSP authentication:	<input type="radio"/> Enable (For PC) <input type="radio"/> Alternate (For Windows Mobile) <input checked="" type="radio"/> Disable (For other mobiles)

Apply

[Image size] Three image resolutions available: 1280 x 720, 640 x 352, 320 x 176.

[Frame rate] Twelve options: 1/2/3/4/5/6/8/10/15/20/25/30 frames per second (fps).

[MPEG4 bit rate] Select MPEG4 bit rate. Eight options: 64, 128, 256, 512, 768, 1024, 1536, 2048 (kbps).

[MJPEG quality] Type in MJPEG video quality value (20 – 100), 20 is low quality, 100 is high quality.

[Snapshot quality] Type snapshot quality. (20 – 100), 20 is low quality, 100 is high quality.

The above five settings determine the image quality, however higher bit rates require greater bandwidth. Please select the appropriate settings according to your connection speed and network traffic. If you are experiencing jerky video it may be necessary to decrease the bit rate.

[Audio] Enable or disable audio.

[RTSP authentication] Enable or disable RTSP authentication.

You can use Mobile phone to play the mobile stream from camera, but generally Mobile phone do not support authentication, so we have to disable the RTSP authentication.

A stream list page will be shown after clicking the stream name such as "Primary stream".

[Primary stream] cannot be disabled.

A sample of primary stream list as below:

Primary stream list

Intranet stream URL	
RTSP MPEG4 stream:	rtsp://192.168.168.134/live_mpeg4.sdp
RTSP MJPEG stream:	rtsp://192.168.168.134/live_mjpeg.sdp
HTTP MPEG4 stream:	http://192.168.168.134/stream.av
HTTP MJPEG stream:	http://192.168.168.134/stream.jpg
HTTP snapshot image:	http://192.168.168.134/snapshot.jpg
Internet stream URL	
RTSP MPEG4 stream:	rtsp://61.144.213.228:8155/live_mpeg4.sdp
RTSP MJPEG stream:	rtsp://61.144.213.228:8155/live_mjpeg.sdp
HTTP MPEG4 stream:	http://61.144.213.228:8155/stream.av
HTTP MJPEG stream:	http://61.144.213.228:8155/stream.jpg
HTTP snapshot image:	http://61.144.213.228:8155/snapshot.jpg

Close

You can use RealPlayer, VLC Player or QuickTime Player to play the live stream from camera in Intranet or Internet.

[Secondary stream] Enable or disable secondary stream.

[Mobile stream] Enable or disable Mobile stream.

You can use mobile phone, Realplayer and QuickTime Player to play the live stream from camera. The size of video is 176 x 144.

Click **Apply** to confirm your setting.

OSD Setup

This function can display system name, date and time, or use-defined on screen.

On Screen Display Setup

OSD display:

Enable Disable

Transparent:

Enable Disable

- Display date and time
- Display system name
- Display the text below
- Display the text below with date and time

Camera

Apply

[OSD] Enable or disable OSD function.

[Transparent] Users can select whether change OSD to transparent or not.

[Display date and time] OSD is date and time of camera.

[Display system name] OSD is system name of camera.

[Display the text below] OSD is user-defined text.

[Display the text below with date and time] OSD is user-defined text with date and time of camera.

Click **Apply** to confirm your settings.

Night Vision Setup (IR IPCAM)

Only IR IPCAM have infrared LED, which can be opened automatically when camera check dark environment.

Night Vision setup

Infrared LED control: Auto On Off
Black and white mode: Auto On Off

Apply

[Infrared LED control] When the environment is dark, the LED will be opened automatically due to a photosensitive component. Users also can select open or close the infrared LED manually.

[Black and white mode] When the environment is dark, the moving images will be changed to Black and White automatically. Users also can select whether change the images to black and white or color manually.

Click **Apply** to confirm your settings.

Network

▼ Network

- Wireless Setup
- TCP/IP Setup
- PPPoE Setup
- DDNS Setup
- UPNP Setup

Wireless Setup

The camera corresponds to the wireless system based on IEEE802.11b/g. Encryption establishes the security to prevent unauthorized users to access the wireless data communication.

Wireless setup

Wireless: Enable Disable

SSID:

Mode: ▼
(select Infrastructure mode if using wireless router.)

Security mode: ▼

[SSID] Type the ID of the wireless network you want to connect to using up to 32 ASC II characters or click **Search** to search for available networks.

[Wireless] Enable or Disable the wireless function

[Mode] Infrastructure mode and Adhoc mode

Adhoc Mode: Select **Adhoc** mode when the camera is directly connected to your computer.

Infrastructure Mode: Select **Infrastructure** mode when the camera is connected via an access point or router.

Wireless setup

SSID:

Mode:
(select Infrastructure mode if using wireless router.)

Security mode:

Authentication:

WEP key type:

WEP key Index:

WEP key:

Re-type WEP key:

When select **Adhoc** mode. See figure above.

[Security mode] WEP64bit or WEP 128bit

[Authentication] Select WEP authentication mode.

[WEP Key type] Select the WEP key type. Either in hexadecimal or ASC II characters.

[WEP key Index] Specify up to 4 WEP keys.

[WEP Key] Type the password.

[Re-type WEP Key] Re-confirm the password.

Wireless setup

SSID:

Mode:
(select Infrastructure mode if using wireless router.)

Security mode:

Encryption type:

WPA key:

Re-type WPA key:

When select **Infrastructure** mode. See figure above.

[Security mode] Security mode is not only WEP64bit or WEP128bit but also WPA-PSK or WPA2-PSK.

[Encryption type] TKIP and AES.

[WPA key] Type 8-63 characters as password.

[Re-type WPA key] Re-confirm the password.

Click **Apply** to save changes.

Click **Test** to test whether connection is successful.

SSID list

	SSID	Mode	Signal	Encryption
<input checked="" type="radio"/>	netgear	Infrastructure		On
<input type="radio"/>	ip3	Infrastructure		On
<input type="radio"/>	dlink	Infrastructure		On
<input type="radio"/>	linksys2	Infrastructure		On

When click **search** ,see figure above.

[SSID] select the network name you searched .

[Mode] Infrastructure mode and Adhoc mode

[signal]It show out the strength of signal

[Encryption] on and off.

Note: These settings have to match those of your access point or router. Please consult your access point or router manual on how to verify or modify these settings.

TCP/IP Setup

The camera is set up to obtain the IP address automatically (DHCP) by default. Should you may wish to assign the IP address manually, use the **TCP/IP Setup** page to enter the address details.

TCP/IP Setup

- Obtain an IP address automatically(DHCP)
- Use the following IP address

- Obtain DNS Server address automatically
- Use the following DNS server address

HTTP/RTSP port:

RTP port range:

--

HTTP/RTSP Authentication method:

- Use Basic Authentication
- Use Digest Access Authentication

Obtain an IP address automatically (DHCP):

If your network supports a DHCP server (e.g. router) select this option to have the IP address is assigned automatically.

If you select **Obtain an IP address automatically** you should select **Obtain a DNS Server address automatically**.

Use the following IP address:

Select this option when a fixed IP is required.

[IP address] Type the IP address of your camera.

[Subnet mask] Type the subnet mask.

[Default gateway] Type the default gateway.

Obtain DNS Server address automatically:

If your network supports a DHCP server (e.g. router) select this option to have the DNS Server address is assigned automatically.

Use the following DNS server address:

[Primary DNS IP address] Type the IP address of the primary DNS server.

[Secondary DNS IP address] Type the IP address of the secondary DNS server, if necessary.

[HTTP/RTSP port]

The default HTTP port number is 80, it is also be used as RTSP port.

[RTP port range] It is for UPnP port forwarding, 1 camera actually use 2 RTP ports, one for video, the other for audio. (See UPnP setup)

[HTTP/RTSP Authentication method] Select Basic Authentication or Digest Access Authentication.

PPPoE Setup

The camera can be installed without a PC on the network. Some XDSL services use PPPoE (Point-to-Point Protocol over Ethernet).

PPPoE setup

PPPoE dial-up:

Enable Disable

Service name:

User name:

Password:

Re-type password:

Apply

[PPPoE dial-up] Enable or disable PPPoE connection.

[Service name] Either an ISP name or a class of services that is configured on the PPPoE server. This field may be left empty.

[User name] Type the user name.

[Password] Type the password.

[Re-type password] Re-confirm the password.

Click **Apply** to confirm your settings.

DDNS Setup

Dynamic DNS (DDNS) is simply a way of using a static hostname to connect to a dynamic IP address. When connected to your ISP, you are assigned a temporary IP address. DDNS services keep track of your IP address and route your **Domain name** to that address when you wish to connect to the camera from a remote location.

DDNS setup

DDNS: Enable Disable

Service provider: [Register](#)

Host name:

User name:

Password:

Re-type password:

[DDNS] Enable or disable DDNS connection.

How to add DDNS

1. **Enable** the Dynamic DNS function.
 2. Select your preferred DDNS service provider from the list then click **Register**.
 3. Enter the **Host Name** details and password supplied by your DDNS service provider when you registered.
 4. Click **Apply** to confirm your settings.
- e.g.

* Dynamic DNS setup successfully!

DDNS setup

DDNS: Enable Disable

Service provider: [Register](#)

Host name:

User name:

Password:

Re-type password:

UPNP Setup

The camera supports UPnP which is enabled by default. This function requires a Windows XP/Vista operating system. It is a quick way to discover the camera on your network. Please make sure that the UPnP function is enabled on your PC.

UPNP setup

UPNP:	<input checked="" type="radio"/> Enable <input type="radio"/> Disable
Gateway HTTP/RTSP port forwarding:	<input checked="" type="radio"/> Enable <input type="radio"/> Disable
External HTTP/RTSP port range:	<input type="text" value="8150"/> -- <input type="text" value="8350"/>
Gateway RTP port forwarding:	<input checked="" type="radio"/> Enable <input type="radio"/> Disable
External RTP port range:	<input type="text" value="30000"/> -- <input type="text" value="30200"/>

Note: RTP port range can't be changed here, you should change it in TCP/IP setup page.

Apply

[UPnP] Enable or disable the UPnP function.

[Gateway HTTP/RTSP port forwarding] Enable or disable this function.

[External HTTP/RTSP port range] Using this port, automatically adds a port forwarding rule to a router via UPnP protocol. Please note that not all routers support this function. Refer to your router manual for further details.

If set port range is 8150~8350, camera will ask router to add a port forwarding rule automatically. In this rule, the internal port is camera default port 80, the external port is 8150, IP address is camera's IP. Use this setting, users can visit the camera from Internet through the router with this URL <http://routeripaddress:8150>.

If there are several cameras in Local Network, the first one which first be opened will use 8150 as external port, and second one will use 8151, third one use 8152, etc. Every camera will remember its port, it will preferentially use this port in next power on.

[Gateway RTP port forwarding] Enable this function, users can use mobile phone , RealPlayer or QuickTime Player to visit the camera from Internet through the router.

[External RTP port range] 30000—30200 default. (See TCP/IP setup)

Click **Apply** to confirm your setting.

Click **System** at the top right of **Settings** page to show the **System information**. See figure below.

System	
Model:	IPCAMW
System up time:	0 Days 16:55:10
BIOS/Loader version:	2.1 (build 0001)
Firmware version:	3.20 (build 20090722)
ActiveX Control version:	1,2,3,1
MAC address:	00:0d:f0:5b:0b:e3 (000DF05B0BE3)
Wireless	
Status:	connected
SSID:	linksys2
Signal:	
Mode:	infrastructure
Channel:	channel 11, 2.4620GHz
Security mode:	WPA-PSK
IP mode:	Dynamic
IP address:	192.168.168.188
Subnet mask:	255.255.255.0
Default gateway:	192.168.168.254
Ethernet	
Status:	No connection
PPPoE	
Status:	No connection
DNS Server	
Primary DNS IP address:	202.96.128.166
Secondary DNS IP address:	192.168.168.254
DDNS	
Status:	Disable
UPNP port forwarding	
Status:	Success
Gateway external IP address:	119.122.167.202
Gateway external port:	8153
Internet URL:	http://119.122.167.202:8153
Internet Connection	
Status:	connected
SD card	
Status:	Inside
Total:	1872 MBytes
Used:	0 MBytes
Available:	1872 MBytes
Current users	
admin	192.168.168.96

If DDNS setup successfully and go into effect, **Internet URL** will show DDNS host name instead. See figure below for example.

UPNP	
Status:	Success
Gateway external IP address:	121.35.132.14
Gateway external port:	8150
Internet URL:	http://mywireless.3322.org:8150

Alarm

▼ Alarm

- Motion Detection
- Schedule Setup
- Alarm Management
- Periodic Sending
- Buffer Management

Motion Detection

Motion Detection can trigger an alarm that sends images or video feed via e-mail or FTP (File Transfer Protocol). You can set up to four different Motion Detection windows.

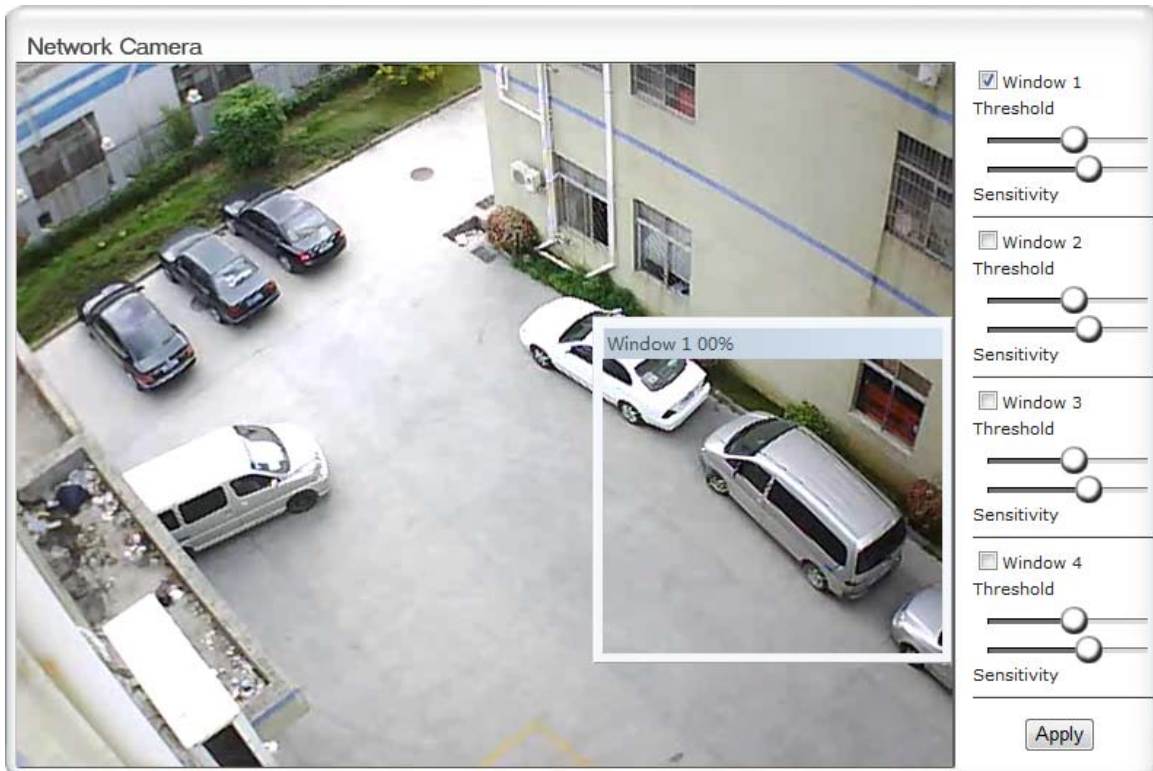

[Window] Check this box to enable the window.

[Threshold] Set the threshold bar to the amount of motion required to trigger the alarm.

[Sensitivity] Set the measurable difference between two sequential images that would indicate motion.

Click **Apply** to confirm your setting.



1. Check the window box to enable this window

2. The percentage figure shows the range of image variation, The alarm will only be triggered when the percentage reaches certain value.

Note:

1. When you enable, disable, relocate or resize a window click Apply to for the new settings to be enable.

2. Only the checked window area will trigger the alarm.

3. Moving the Threshold bar to the left or the Sensitivity bar to the right will increase the sensitivity of when the alarm is triggered.

4. To resize a window simply drag one of its corners.

5. To move a window click and drag on the top bar of the window (windows name).

Schedule Setup

Alarm Sending, Periodical Sending and **Buffer Sending** sends images via e-mail or FTP according to schedule setup.

Schedule setup

<input type="checkbox"/> Every day	Always ▾	Start time	0	:	0	End time	24	:	0
<input type="checkbox"/> Sunday	Range ▾	Start time	0	:	0	End time	24	:	0
<input type="checkbox"/> Monday	Range ▾	Start time	0	:	0	End time	24	:	0
<input type="checkbox"/> Tuesday	Range ▾	Start time	0	:	0	End time	24	:	0
<input type="checkbox"/> Wednesday	Range ▾	Start time	0	:	0	End time	24	:	0
<input type="checkbox"/> Thursday	Range ▾	Start time	0	:	0	End time	24	:	0
<input type="checkbox"/> Friday	Range ▾	Start time	0	:	0	End time	24	:	0
<input type="checkbox"/> Saturday	Range ▾	Start time	0	:	0	End time	24	:	0

Apply

[Every day] Select every day or not.

[Sunday ~ Saturday] Select Sunday ~ Saturday or not.

[Always] Enable in any time.

[Range] Enable between start time and end time.

[Except] Enable except start time to end time.

Click **Apply** to confirm your setting.

Alarm Management

Motion Detection can trigger an alarm that sends images via FTP or e-mail and send URL via HTTP.

Alarm Management setup

- Alarm mode: Arm Disarm
- FTP alarm management: Enable Disable
- e-Mail alarm management: Enable Disable
- HTTP event alarm management: Enable Disable

Apply

[Alarm mode] Enable or disable all alarm.

[FTP alarm sending] Enable or disable FTP alarm sending function.

[e-Mail alarm sending] Enable or disable e-Mail alarm sending function.

[HTTP event alarm sending] Enable or disable HTTP event alarm function.

- FTP alarm management: Enable Disable
- Trigger time: seconds (1-20)
- Trigger FPS: Images/sec (1-5)
- FTP server ID:
- Remote path:
- Snapshot from:
- Image file name:
- Suffix of file name: Date time S/N None
- Effective period: Always Schedule
- Alarm interval time: Seconds (0-86400 0:not limit)

[Trigger time] How many seconds does camera keep snapshot the images after get a motion alarm.

[Trigger FPS] How many images does camera snapshot every second after get a motion alarm.

[FTP server ID] Select one FTP server, click **Setting** to set FTP server.

[Remote path] Path where to save the image file on the FTP server.

[Snapshot from] Select source stream that snapshot from.

[Image file name] Type image file name.

[Suffix of file name] Select suffix of file name.

[Effective period] Select Effective period. If select schedule, click **Setting** to set schedule.

[Alarm interval time] Scope: 0-86400 sec, when the alarm time remains at 0 second, no alarm trigger

restricted. Otherwise, the triggering interval will just be the setting alarm time. Alarm within the time will not be triggered.

e-Mail alarm management: Enable Disable

Trigger time: seconds (1-20)

Trigger FPS: Images/sec (1-5)

e-Mail server ID:

File attachment: On Off

Snapshot from:

Image file name:

Suffix of file name: Date time Sequence number

Effective period: Always Schedule

Alarm interval time: Seconds (0-86400
0:Continuous)

[Trigger time] How many seconds does camera keep snapshot the images after get a motion alarm.

[Trigger FPS] How many images does camera snapshot every second after get a motion alarm.

[e-Mail server ID] Select one e-Mail server, click **Setting** to set e-Mail server.

[File attachment] Switch file attachment on or off.

[Snapshot from] Select source stream that snapshot from.

[Image file name] Type image file name.

[Suffix of file name] Select suffix of file name.

[Effective period] Select Effective period. If select schedule, click **Setting** to set schedule.

[Alarm interval time] Scope: 0-86400 secs, when the alarm time remains at 0 second, no alarm trigger restricted. Otherwise, the triggering interval will just be the setting alarm time. Alarm within the time will not be triggered.

HTTP event alarm management: Enable Disable

HTTP server ID:

Sending URL:

Use MAC address as URL suffix

Effective period: Always Schedule

[HTTP server ID] Select HTTP server ID, click **Setting** to set HTTP server.

[Sending URL] Type URL which will be sent to HTTP server.

[Use MAC address as URL suffix] Enable or disable this function.

[Effective period] Select effective period. If select schedule, click **Setting** to set schedule.

Click **Apply** to confirm your setting.

Periodic Sending

The camera can send images via FTP or e-mail and send URL via HTTP periodically.

Periodic sending setup

FTP periodic sending: Enable Disable

e-Mail periodic sending: Enable Disable

HTTP periodic sending: Enable Disable

Apply

[FTP periodic sending] Enable or disable FTP upload periodically.

[e-Mail periodic sending] Enable or disable e-Mail upload periodically.

[HTTP periodic sending] Enable or disable HTTP upload periodically.

FTP periodic sending: Enable Disable

Interval time: H M S mS
(MIN: 200 msec. MAX: 24 hour)

FTP server ID:

Remote path:

Snapshot from:

Image file name:

Suffix of file name: Date time SN None

Effective period: Always Schedule

[Interval time] Type the interval at which you want to send the images periodically.

[FTP server ID] Select one FTP server, click **Setting** to set FTP server.

[Remote path] Path where to save the image file on the FTP server.

[Snapshot from] Select stream that snapshot from.

[Image file name] Type image file name.

[Suffix of file name] Select suffix of file name.

[Effective period] Select Effective period. If select schedule, click **Setting** to set schedule.

e-Mail periodic sending: Enable Disable

Interval time: H M S mS
(MIN: 200 msec. MAX: 24 hour)

e-Mail server ID:

File attachment: On Off

Snapshot from:

Image file name:

Suffix of file name: Date time Sequence number

Effective period: Always Schedule

[Interval time] Type the interval at which you want to send the images periodically.
[e-Mail server ID] Select one e-Mail server, click **Setting** to set e-Mail server.
[File attachment] switch file attachment on or off.
[Snapshot from] Select stream that snapshot from.
[Image file name] Type image file name.
[Suffix of file name] Select suffix of file name.
[Effective period] Select Effective period. If select schedule, click **Setting** to set schedule.

HTTP periodic sending: Enable Disable

Interval time: H M S mS
(MIN: 200 msec. MAX: 24 hour)

HTTP server ID:

Sending URL:

Use MAC address as URL suffix

Effective period: Always Schedule

[Interval time] Type the interval at which you want to send the URL periodically.
[HTTP server ID] Select HTTP server ID, click **Setting** to set HTTP server.
[Sending URL] Type URL which can be sent to HTTP server..
[Use MAC address as URL suffix] Enable or disable this function.
[Effective period] Set Effective period. If select schedule, click **Setting** to set schedule.

Click **Apply** to confirm your setting.

Note:
The notifications use the camera's internal clock. Please make sure the camera's Date and Time are correct.

Buffer Management

The camera can be configured to send images via FTP when the **Motion Detection** alarm is triggered.

Note: This function just can be used when SD card does not plug in the SD slot of cameras.

Image buffer management setup

Image buffer:	<input checked="" type="radio"/> Enable <input type="radio"/> Disable
Buffer time:	<input type="text" value="20"/> Seconds (1-20)
Buffer FPS:	<input type="text" value="4"/> Images/sec (1-10) (The number of buffer images: 1 - 80)
Snapshot from:	<input type="text" value="Primary stream"/> <input type="button" value="v"/>
Image file name:	<input type="text"/>
Suffix of file name:	<input checked="" type="radio"/> Date time <input type="radio"/> Sequence number
FTP automatic sending:	<input type="radio"/> Enable <input checked="" type="radio"/> Disable
FTP server ID:	<input type="text" value="1"/> <input type="button" value="Setting"/>
Remote path:	<input type="text"/>
Estimate sending time:	<input type="text" value="100"/> Seconds (1 - 9999)
Effective period:	<input checked="" type="radio"/> Always <input type="radio"/> Schedule <input type="text" value="1"/> <input type="button" value="Setting"/>

[Image buffer] Enable or disable this function. Click **Browse** to preview images.

[Buffer time] Type buffer time.

[Buffer FPS] Type buffer FPS.

[Snapshot from] Select stream that snapshot from.

[Image file name] Type image file name.

[Suffix of file name] Select suffix of file name.

[FTP automatic sending] Enable or disable this function.

[FTP server ID] Select one FTP server, click **Setting** to set FTP server.

[Remote path] Path where to save the image file on the FTP server.

[Estimate sending time] Type estimate time that all buffer images send completed.

[Effective period] Select Effective period. If select schedule, click **Setting** to set schedule.

Click **Apply** to confirm your setting.

Alarm Server

▼ Alarm Server

FTP Server

e-Mail Server

HTTP Server

FTP Server

FTP Server setup

FTP server ID:

FTP server name:

FTP server port:

Anonymous: Yes No

User name:

Password:

Re-type password:

Passive mode: On Off

Keep alive: Seconds (0-99999 0:always keep alive)

Apply

[FTP server ID] Select FTP server ID.

[FTP server name] Type the name or IP address of the FTP server.

[FTP server port] The default port number is 21.

[Anonymous] Enable or disable anonymous login.

[User name] Type your user name.

[Password] Type your password.

[Re-type password] Re-type your password.

[Passive mode] Switch passive mode on or off.

[Keep alive] Type the time which keep alive with FTP server.

Click **Apply** to confirm your settings.

e-Mail Server

e-Mail Server setup

e-Mail server ID:	1 ▼
SMTP server name:	<input type="text"/>
SMTP server port:	25
Secure SSL connection:	<input type="radio"/> Yes <input checked="" type="radio"/> No
Authentication:	<input checked="" type="radio"/> Yes <input type="radio"/> No
User name:	<input type="text"/>
Password:	<input type="password"/>
Re-type password:	<input type="password"/>
Sender mail address:	<input type="text"/>
Receiver mail address:	<input type="text"/> <input type="text"/> <input type="text"/>
Subject:	Warning from Network Camera
Message:	<input type="text"/>

[e-Mail server ID] Select e-Mail server ID.

[SMTP server name] Type the name or IP address of the SMTP server you want to use for sending the e-Mails. Please note that networks do not allow e-mail relaying. Check with your system administrator for more details.

[SMTP server port] The default value is 25.

[Secure SSL connection] Select whether use SSL connection.

[Authentication] Select the authentication required by the SMTP server.

[User name] & [Password] Type the user name and password of the e-Mail account you wish to use. This field is required if your SMTP server requires authentication.

[Re-type password] Re-type the password.

[Sender e-mail address] Type the e-mail address of the account you are using to send the e-Mail.

[Receiver e-mail address] Type the recipients' e-mail addresses (Up to 3 address can be entered).

[Subject] Subject of the e-mail, entering a relevant subject will help identify the alarm better.

[Message] Type the text you wish to appear in the e-mail.

Click **Apply** to confirm your settings.

HTTP Server

HTTP Server setup

HTTP server ID:	<input type="text" value="1"/>
HTTP server name:	<input type="text"/>
HTTP server port:	<input type="text" value="80"/>
Authorization:	<input type="radio"/> Yes <input checked="" type="radio"/> No
User name:	<input type="text"/>
Password:	<input type="password"/>
Re-type password:	<input type="password"/>

[HTTP server ID] Select HTTP server ID.

[HTTP server name] Type the HTTP server name.

[HTTP server port] Type the HTTP server port.

[Authentication] Select the authentication required by the HTTP server.

[User name] Type the user name.

[Password] Type the password.

[Re-type password] Re-confirm the password.

Click **Apply** to confirm your settings.

Storage

▼ Storage

- Storage Setup
- Record on Alarm
- Snapshot on Alarm
- Continuous Record
- Snapshot at Interval
- FTP Sending
- Browse Storage
- Format SD Card

Storage setup

Select storage destination to NAS or SD card.

Storage setup

Storage:	<input checked="" type="radio"/> Enable <input type="radio"/> Disable
Store to:	<input checked="" type="radio"/> NAS <input type="radio"/> SD card
NAS remote path:	<input type="text"/> (Example: //192.168.168.50/ipcam_files)
Authorization:	<input type="radio"/> Yes <input checked="" type="radio"/> No
User name:	<input type="text"/>
Password:	<input type="text"/>
Re-type password:	<input type="text"/>

Apply

[Storage] Enable or Disable the storage function.

[Store to] When select storage destination for videotape and photograph, NAS (network attached storage) or SD card can be used. While choosing NAS, SMB/CIFS should be used as File transmission protocol.

[NAS remote path] Appoint NAS remote link address and shared folders.

[Authorization] Identity authentication of accessing shared folders in NAS.

[User name] Type the user name.

[Password] Type the password.

[Re-type password] Re-confirm the password.

Click **Apply** to confirm your settings.

Note: PC could serve as NAS as long as the PC support SMB/CIFS protocol and set shared folders.

Record on Alarm

Record on alarm setup

Alarm mode: Arm Disarm

Record on alarm: Enable Disable

[Alarm mode] Enable or disable all alarm.

[Record on alarm] Enable or disable alarm recording function.

Click **Apply** to confirm your settings.

Record on alarm: Enable Disable

Record time: seconds (5-86400)

Record from:

Record file name:

Suffix of file name: Date time
 Sequence number
 Date time & record time length

Split time of record file: Seconds (10-86400)

Effective period: Always Schedule

[Record time] how many seconds does camera keep recording after a motion alarm.

[Record from] Select source stream that record from.

[Record file name] Type record file name.

[Suffix of file name] Select suffix of file name.

[Split time of record file] How many seconds does every recording file save video and audio.

[Effective period] Select Effective period. If select schedule, click **Setting** to set schedule

Snapshot on Alarm

Snapshot on alarm setup

Alarm mode: Arm Disarm

Snapshot on alarm: Enable Disable

[Alarm mode] Enable or disable all alarm.

[Snapshot on alarm] Enable or disable alarm snapshot function.

Click **Apply** to confirm your settings.

Snapshot on alarm: Enable Disable

Trigger time: seconds (1-20)

Trigger FPS: Images/sec (1-5)

Snapshot from:

Image file name:

Suffix of file name: Date time Sequence number

Effective period: Always Schedule

[Trigger time] How many seconds does camera keep snapshot the images after get a motion alarm.

[Trigger FPS] How many images does camera snapshot every second after get a motion alarm.

[Snapshot from] Select source stream that snapshot from.

[Image file name] Type image file name.

[Suffix of file name] Select suffix of file name.

[Effective period] Select Effective period. If select schedule, click **Setting** to set schedule.

Click **Apply** to confirm your settings.

Continuous Record

Continuous record setup

Continuous record: Enable Disable

[continuous record] Enable or disable continuous recording function.

Click **Apply** to confirm your settings.

Continuous record: Enable Disable

Record from:

Record file name:

Suffix of file name: Date time
 Sequence number
 Date time & record time length

Split time of record file: Seconds (10-86400)

Record period time: Always Schedule

[Record from] Select source stream that record from.

[Record file name] Type record file name.

[Suffix of file name] Select suffix of file name.

[Split time of record file] How many seconds does every recording file save video and audio.

[Record period time] Select record period time. If select schedule, click **Setting** to set schedule.

Click **Apply** to confirm your settings.

Snapshot at Interval

Snapshot at interval setup

Snapshot at interval:

Enable Disable

Browse...

Apply

[Snapshot at interval] enable or disable interval snapshot function

Snapshot at interval:

Enable Disable

Browse...

Interval time:

0 H 1 M 0 S 0 mS
(MIN: 200 msec. MAX: 24 hour)

Snapshot from:

Primary stream

Image file name:

P

Suffix of file name:

Date time Sequence number

Effective period:

Always Schedule 1

Setting

Apply

[Interval time] Type the interval at which you want to save snapshot to SD card periodically.

[Snapshot from] Select stream that snapshot from.

[Image file name] Type image file name.

[Suffix of file name] Select suffix of file name.

[Effective period] Select Effective period. If select schedule, click **Setting** to set schedule.

Click **Apply** to confirm your settings.

FTP Sending

This function is used for sending the files to FTP server.

Notice: when users visit the video, uploading will automatically interrupt, and will restart when users stop visit the video.

SD File FTP Sending

SD File FTP Sending: Enable Disable

Apply

SD File FTP Sending: Enable Disable

FTP server ID: 1

Remote path:

Sending period: Always Schedule

File period: All files Schedule 1

FTP upload baudwidth: 64 kb/sec (1-999999)

Apply

[FTP server ID] Select one FTP server, click **Setting** to set FTP server.

[Remote path] Path where to save the file on the FTP server.

[Sending period] Select sending period. If select schedule, click **Setting** to set schedule.

[File period] Select the files which creation time is in period to sending. If select schedule, click **Setting** to set schedule.

[FTP upload bandwidth] Evaluate the uploading speed of FTP sending files.

Click **Apply** to confirm your settings.

Browse Storage

When click **Browse** and see figure below, you can browse, download, and delete the snapshot and recording files in it,

Network Camera

Alarm record

<input type="checkbox"/>	File name	Size(bytes)
<input type="checkbox"/>	M_2009-07-23_03-47-03.mov	1803298
<input type="checkbox"/>	M_2009-07-23_03-47-22.mov	3434094
<input type="checkbox"/>	M_2009-07-23_03-47-46.mov	2158734
<input type="checkbox"/>	M_2009-07-23_03-48-10.mov	520948

Folder

- Record on Alarm
- Snapshot on Alarm
- Continuous record
- Snapshot at interval

Format SD Card

To format SD card, all files will be lost after format.

SD card format

SD card	
Status:	Inside
Total:	1872 MBytes
Used:	0 MBytes
Available:	1872 MBytes

Format

Tools

▼ Tools

- System Identity
- User Management
- Date & Time
- Backup or Reset
- Firmware Upgrade

System Identity

System identity

System Name:	<input type="text" value="Network Camera"/>
System Contact:	<input type="text" value="Default Contact"/>
System Location:	<input type="text" value="Default Location"/>

[System Name] Type a name to easily identify the camera.

[System Contact] Type the contact name of the administrator of the camera.

[System Location] Type the location of the camera.

***TIP:** The information you fill in can be displayed on the camera. It can help to distinguish different Network Cameras in the network. See figure below.*

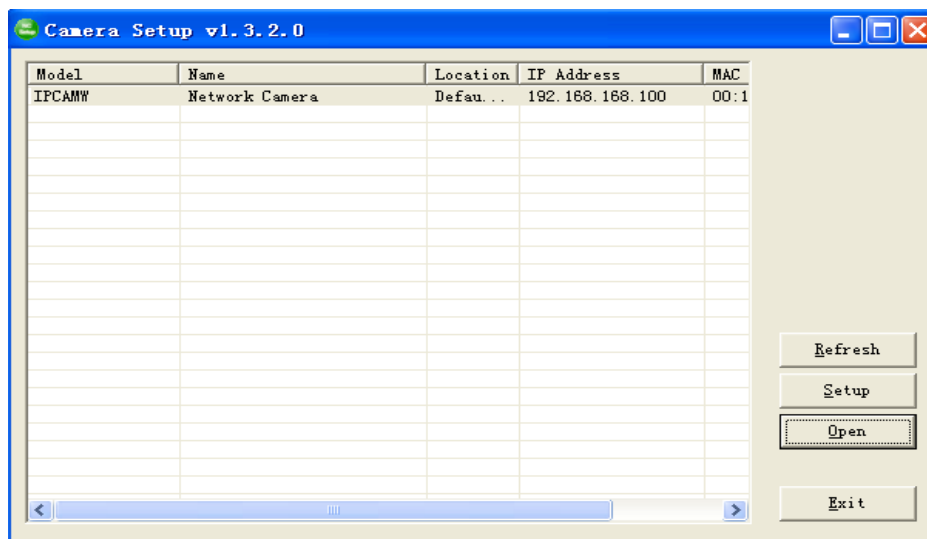

User Management

Camera user list

No.	User name	Group
1	admin	Administrators

Add

[Add] Up to 64 users (including the admin) can **created**

Note:

1. A maximum of 16 users are allowed to access the camera simultaneously.
2. As the number of simultaneously users increase, the overall performance will decrease. This is dependant on the Network bandwidth.

Adding users

1. Click **Add** on the **Camera User List** page.
2. Enter the User name, Password and re-confirm the password then click **Add**.

Add user

User name:

Password:

Re-type password:

To edit a user's password, click on the user name then enter the new password for that user twice and click **Save**. To delete a user, click on the user name then click **Delete**.

Date & Time

System time setting

Current device time: Time zone: GMT

Proposed device time:

Select to change the time zone for the device location:



Daylight saving time

Date and time format:

yy/mm/dd hh:mm:ss
 mm/dd/yy hh:mm:ss
 dd/mm/yy hh:mm:ss

Auto time setting (SNTP) Enable Disable

Time server

e.g. time.nist.gov;ns.arc.nasa.gov

[Current device time] Internal time for camera.

[Proposed device time] PC system time. On clicking **Apply** the internal time of the camera will be changed to this time.

[Select to change the time zone for the device location] choose proper time zone.

[Daylight saving time] Daylight Saving Time (or summertime as it is called in many countries) is a way of getting more light out of the day by advancing clocks by one hour during the summer.

[Date and time format] Select date and time format.

[Auto time setting(SNTP)] Enable or disable this function.

[Time server] Type one SNTP server name in the box.

Click **Apply** to confirm your settings.

Note:

1. If the SNTP server is not found the camera's time will be synchronized with the PC time.
2. The **camera** has a built-in RTC(Real-time Clock) that keeps track of the time even when power is disconnected.

Backup or Reset

Backup or reset settings

Click **Reset** to erase the camera's configuration and restore the factory defaults.

Reset

Click **Backup** to save the camera's configuration to a file.

Backup

Restore the camera's configuration from a previously backed-up file.

Restore

 浏览...

[Reset] Click **Reset** to initialize the camera to default factory setting. All users and settings will be lost, requiring you to reconfigure the camera.

[Backup] Click **Backup** to backup the current configuration of the camera for future reference.

[Browse...] Click **Browse...** to search for a backup configuration you wish to upload to the camera, then click **Restore**.

Note:

Do not turn off the power during the Reset, Backup or Restore functions since this might corrupt the camera's firmware

Tip:

The camera can also be reset to the default settings by pressing the reset switch on the side of the camera.

Firmware Upgrade

From time to time a new firmware may be released. In order to upgrade your camera's firmware you first need to download this firmware from Network Camera Technical Support Site.

1. Click **Continue**.

Firmware upgrade

Warning:

Upgrading the camera to a new firmware will erase your current configuration.

Current firmware version is: 2.28 (build 20080905)

To proceed click continue.

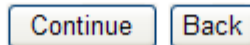

2. Click **Browse...** to search for the newest Firmware you downloaded, and then click **Upgrade**.

Firmware upgrade

Upgrade Firmware (path and file name)

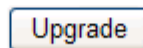
3. Click **Reboot** when the upgrade terminates.

IMPORTANT:

* Do not unplug or power off the camera while the upgrade is in progress.

SPEEDREAD YOUR NETWORK CAMERA

Wizard

In order to facilitate the setup of the camera there is a **Wizard** that helps non technical users setup the camera easily. Click on Wizard at the top of the window to launch the wizard.

Wizard | System | Support | Reboot

The Quick setup interface will pop up. Follow the simple instructions on the screen and enter the required details, clicking next to proceed to the **Next** page.

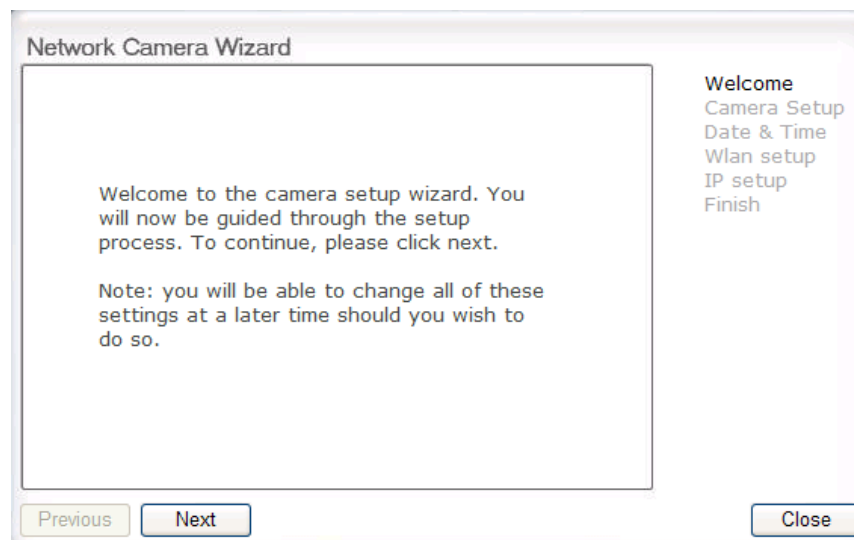

System

Click **System** to see over system information about your camera. The data of the software activity of the camera and recorded in this. It includes data that are useful when a problem occurs.

Wizard | System | Support | Reboot

Support

Click **Support** to see the support information

Wizard | System | Support | Reboot

Reboot

Click **Reboot** to restart the camera. Rebooting the camera will retain all the settings and configurations.

Wizard | System | Support | Reboot

Reboot camera

Reboot now?

Reboot

ADVANCED SETTINGS

Port Forwarding

The UPnP Setup of camera show a method of Port Forwarding (see page 40 for details), but some routers maybe can't support UPnP Port Forwarding, therefore, users need to configure Port Forwarding manually.

Firewall security features built into the router may prevent users from accessing the camera over the Internet. The router connects to the Internet over a series of "ports". The default ports used by the camera are usually blocked from access over the Internet, therefore, these ports need to be made accessible. This is achieved using the Port Forwarding function on the router. The ports used by the camera must be opened through the router for remote access to your camera. Check your router's user manual for specific instructions on how to open and route ports on you router.

Important: Some ISPs block access to port 80 and other commonly used Internet ports. Check with your ISP in order to open the appropriate ports. If your ISP does not pass traffic on port 80, you will need to change the camera's default port number from 80 to a different number such as 9000.

Viewing Your Camera

To access the camera from a computer on your local network, simply enter the IP Address of the Camera followed by a colon and the camera's port number. It is not necessary to enter the colon and port number if you are using the camera's default port 80.

To access the camera from the internet, type the external IP Address of the router, followed by a colon, and the port number of your camera (e.g., [Http://210.118.166.68:9000](http://210.118.166.68:9000)).

Proxy Server Setting

A proxy server may prevent you from connecting to the camera in some corporate environments. The web browser can set up the IP address communication without using a proxy server. Consult your ISP or network administrator for further details.

Note: A proxy server is generally used to maintain security on a network when connected to the internet. The proxy server may cause lack of image quality and delays in refresh intervals. Consult your ISP or network administrator for further details.

1. Start **Internet Explorer**.
2. Select **[Tools] → [Internet Options...] → [Connections] tab** and click **[LAN Settings]**. Verify that the **Use a proxy server** check box is not checked. When checked, click **[Advanced...]**.

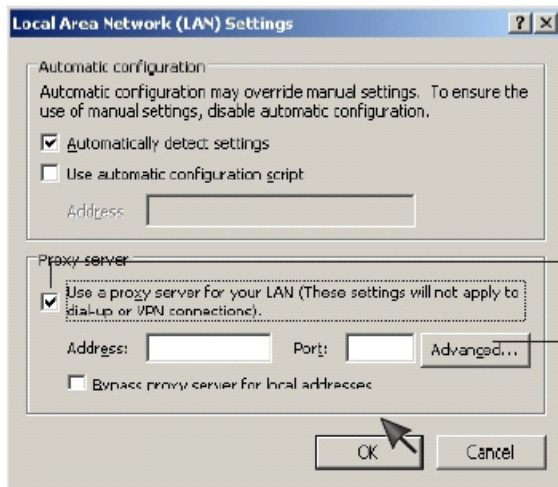

Verify that the check box is not checked

When checked, click **[Advanced...]**

When not checked, click **[Cancel]**. Your proxy server settings should not cause any problems.

3. Enter the IP address of your camera into the **Do not use proxy server for addresses beginning with** data field.

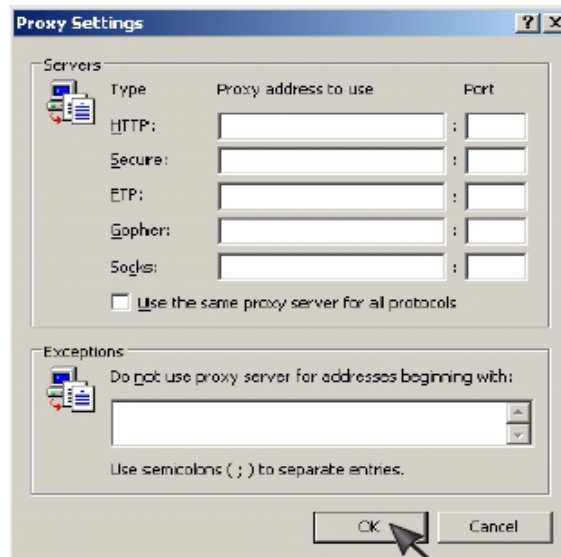

4. Click **[OK]** on all of the opened windows.

Reset the camera

There are two ways to reset the camera back to its factory defaults:

1. Press the **Reset** button on the side of the camera through the pin hole.
2. Through the camera setup under the heading **Backup or Reset** (see page 65 for details)

CONNECTED DIRECTLY TO A COMPUTER

You can also connect the IP Cam directly to a computer. **Please note that in this mode you will not be able to view your IP Cam from anywhere else apart from the computer you are currently using.**

Connect one end of the network cable in to the IP Cam Network Connection socket, and plug the other end in to a spare network port on your computer.

Connect the included power adapter to the power port on the camera and the other end into an electrical socket. Do not turn the power on at this time.

You must then assign your computer an IP address so it can talk easily to the camera.

For Windows system:

1. Open the Control Panel and double click on "Network Connections" then right click on your "Local Area Network" connection, and click Properties. Be sure to select the Network icon that corresponds to where you have plugged the IP Cam in to – so this would not be listed as a Wireless, WiFi or Bluetooth Network.
2. Select "Internet Protocol (TCP/IP)" then click Properties.
3. Take note of your current TCP/IP Settings and then click on "Use the following IP settings"
4. in the "IP Address" Field type in the number 192.168.168.20
5. in the "Subnet Mask" type in 255.255.255.0
6. Leave "Default Gateway" setting blank (The camera will automatically assign itself this IP address when no DHCP server is present)
7. Leave DNS server settings blank.
8. Click "OK" then "Close" to apply these settings.
9. Turn the power on to the IP Cam.

The Connectivity Status indicator on the front of the camera will light up.

10. Double-click the Camera Setup icon on the Desktop to launch the program.



11. The Camera Setup utility should automatically find your camera if is correctly connected (See image below).

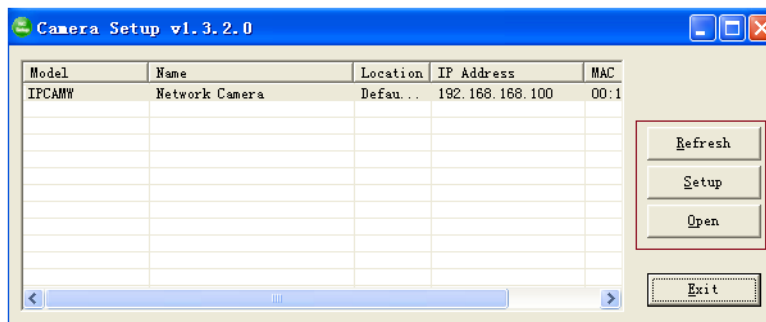

DEFAULT SETTINGS

Camera

Camera Setup	
Privacy mode	Off
Moonlight mode	Off
Image rotation	Off
Light frequency	60Hz
Microphone	Enable
Mic Volume	10
Audio Bit Rate	G. 726 (16kbps)
Stream Setup	
Primary stream	Enable
Image size	640 x 480
Frame rate	30fps
MPEG4 bit rate	2048kbps
MJPEG quality	50
Snapshot quality	90
Audio	Enable
RTSP authentication	Enable
Secondary stream	Disable
Image size	320 x 240
Frame rate	30fps
MPEG4 bit rate	512kbps
MJPEG quality	50
Snapshot quality	90
Audio	Enable
RTSP authentication	Enable
Mobile stream	Enable
Image size	176 x 144
Frame rate	10fps
MPEG4 bit rate	64kbps
Snapshot quality	70
Audio	Disable
RTSP authentication	Enable
OSD Setup	
OSD	Disable
Transparent	Enable
Display	Display date and time
Night Vision Setup	
Infrared LED control	Auto
Black and white mode	Auto

Network

Wireless Setup	
SSID	Wirelessnc
Mode	Adhoc
Security mode	Off
TCP/IP Setup	
IP address	192.168.168.100

Subnet Mask	255.255.255.0
Default Gateway	Blank
Primary DNS IP Address	Blank
Secondary DNS IP Address	Blank
HTTP Port	80
RTSP port	554
RTP port range	30000—30200
Authentication method	Basic
PPPoE Setup	
PPPoE Dial-up	Disable
Service Name	Blank
User Name	Blank
Password	Blank
Re-type Password	Blank
DDNS Setup	
DNS	Disable
Service provider	dtdns.com
Host name	Blank
User name	Blank
Password	Blank
Re-type password	Blank
UPnP Setup	
UPnP	Enable
Gateway HTTP/RTSP port forwarding	Enable
External HTTP/RTSP port range	8150--8350
Gateway RTP port forwarding	Enable
External RTP port range	30000--30200

Alarm

Motion Detection	
Window 1	Blank
Window 2	Blank
Window 3	Blank
Window 4	Blank
Schedule Setup	
Every day	Always
Alarm Sending	
Alarm mode	Arm
FTP alarm sending	Disable
Trigger time	5
Trigger FPS	1
FTP server ID	1
Remote path	Blank
Snapshot from	Primary stream
Image file name	M
Suffix of file name	Date time
Effective period	Always
e-Mail alarm sending	Disable
Trigger time	1
Trigger FPS	1
e-Mail server ID	1
File attachment	On

Snapshot from	Primary stream
Image file name	M
Suffix of file name	Date time
Effective period	Always
HTTP event alarm sending	Disable
HTTP server ID	1
Sending URL	Blank
Use MAC address as URL suffix	Disable
Effective period	Always
Periodical Sending	
FTP periodical sending	Disable
Interval time	0H 1M 0S 0mS
FTP server ID	1
Remote path	Blank
Snapshot from	Primary stream
Image file name	P
Suffix of file name	Date time
Effective period	Always
e-Mail periodical sending	Disable
Interval time	0H 1M 0S 0mS
e-Mail server ID	1
File attachment	On
Snapshot from	Primary stream
Image file name	P
Suffix of file name	Date time
Effective period	Always
HTTP periodical sending	Disable
Interval time	0H 1M 0S 0mS
HTTP server ID	1
Sending URL	Blank
Use MAC address as URL suffix	Disable
Effective period	Always
Buffer Sending	
Image buffer	Disable
Buffer time	20
Buffer FPS	4
Snapshot from	Primary stream
Image file name	Blank
Suffix of file name	Date time
FTP buffer sending	Disable
FTP server ID	1
Remote path	Blank
Estimate sending time	100
Effective period	Always

Alarm Server

FTP Server	
FTP server ID	1
FTP Server Name	Blank

FTP Server Port	21
Anonymous	No
User Name	Blank
Password	Blank
Re-type Password	Blank
Passive Mode	On
Keep alive	3600
e-Mail Server	
e-Mail server ID	1
SMTP Server Name	Blank
SMTP Server Port	25
Secure SSL connection	No
Authentication	Yes
User Name	Blank
Password	Blank
Re-type Password	Blank
Sender E-Mail Address	Blank
Receiver E-Mail Address	Blank
	Blank
	Blank
Subject	Warning from Network Camera
Message	Blank
HTTP Server	
HTTP server ID	1
HTTP server name	Blank
HTTP server port	80
Authorization	No
User Name	Blank
Password	Blank
Re-type Password	Blank

Tools

System Identity	
System Name	Network Camera
System Contact	Default Contact
System Location	Default Location
User Management	
1	Admin/Administrators
Date & Time	
Current Device Time	Current PC Time
Time Zone	GMT
Proposed Device Time	Current PC Time
Daylight saving time	Disable
Date and time format	dd/mm/yy hh:mm:ss
Auto Time Setting (SNTP)	Enable
Time Server	Time.nist.gov
Misc Setup	
LED Control	On
Show FPS in Active Control	Off

SPECIFICATIONS

Camera	
Image device	1/4" CMOS
Pixels	HD720P
White Balance	Auto
Exposure mode	Auto
Gain	Auto
Viewing angle	Horizontal:64°, Vertical:36°
Focal length	f=2.8mm
Aperture	F2.0
Min. illumination	0.5 Lux
Infrared LED	12
Night Vision Distance	15m
IR cut filter	Yes
Network	
Image compression	H.264, MPEG-4, MJPEG
Image resolution	1280x720(HD720P), 640x360, 320x180
Max. frame rate	30fps @1280x720
Audio compression	AAC - LC, AMR - NB, G.726
Simultaneous viewers	16
Authentication	ID/Password, Administrator/General User (Up to 64)
Network protocols	TCP,UDP,IP,ARP,ICMP,DHCP,DNS,HTTP,FTP,SMTP,NTP,PPPoE,UPnP,DDNS
Stream type	RTSP/RTP/RTCP, 3GPP, ASF, HTTP
Network connection	Ethernet (10BASE-T/100BASE-TX)
Wireless LAN	
Wireless technology	IEEE802.11b/g/n
Frequency	2.412-2.462GHz
Transmission speed	150Mbps/54Mbps/22Mbps/11Mbps/5.5Mbps/2Mbps/1Mbps (Auto Switch)
Security	WEP (64/128 bit), WPA-PSK(AES/TKIP), WPA2-PSK(AES/TKIP)
External Port	
Built-in microphone	Electret Condenser Microphone
Audio output (2 way audio)	Yes
SD slot	Yes
Digital I/O	1 input, 1 output
General	
Power requirements	DC 12V
Power consumption	3.5W
Power over Ethernet (POE)	Yes
Operating temperature	-5 to +45 °C (+22 to +113 °F)
Storage temperature	-20 to +60 °C (-4 to +140 °F)
Operating humidity	20~80%RH(Non-condensing)
Storage humidity	20~95%RH(Non-condensing)

Dimensions(W x D x H)	70mm x 70mm x 190mm
Weight	700g(Main Body)
Supplied accessories	AC adaptor (x1), CD-ROM(x1 setup program and user manual), Stand(x1), Sun shard(x1)
PC system requirements	
Operating system	Windows XP/Vista/7, MAC OS, Linux, Android, iPhone OS, Windows Mobile, BlackBerry OS
Processor	Intel Pentium III, 1GHz or Higher
Memory	256MB RAM Minimum
Web browser	Microsoft IE, Safari, Mozilla Firefox, Google Chrome and most other browsers

TROUBLESHOOTING

If the Network Camera is not working properly, these suggestions might help you identify the problem. If the problem persist check the support pages on Network Camera Technical Support Site.

Problem	Cause and Remedy
Forget the IP address of network camera.	<ol style="list-style-type: none"> 1. Use Camera Setup. 2. Use UPNP (for XP/Vista OS) 3. PPPoE IP Notification can send e-mail to your mailbox 4. Reset your Network to default IP address
Forget the password to access the setting interface.	Initialize the network camera by pressing the RESET button. Note that all configuration settings will be lost.
Wireless communication does not work.	<ol style="list-style-type: none"> 1. Signal strength is weak. Relocate the camera or remove the obstacle around it. 2. Make sure the SSID and Encryption settings are identical. 3. Check for any interference from other equipment.
The picture viewing interface does not appear.	<ol style="list-style-type: none"> 1. Check that your internet explorer settings allow you to download and install ActiveX controls. 2. Maximum 16 users are allowed to access the camera simultaneously through network. 3. Network traffic may prevent the viewing interface from appearing quickly. Wait for a while.
The color of the picture is strange.	Confirm the color setting of PC is 16 bits or more.
The unreadable characters are displayed.	Set the Encoding or the Character Set of the selected language on the web browser.

GLOSSARY OF TERMS

- 1. Network Camera:** A stand-alone device which allows users to view live, full motion video from anywhere on a computer network, even over the Internet, using a standard web browser.
- 2. JPEG:** A standard image format, used widely for photographs, also known as JPG.
- 3. IEEE 802.11b/g:** The specifications developed by the IEEE for wireless network technology. It provides 11 Mbps transmission in the 2.4GHz band usage.
- 4. WEP:** Wireless Equivalent Privacy. A security protocol for wireless network defined in the IEEE 802.11b/g standard. WEP aims to provide security by encrypting data over radio waves so that it is protected as it is transmitted from one end point to another.
- 5. AdHoc Mode:** A wireless network system in which devices communicate directly with each other, without the use of a wireless router.
- 6. Infrastructure Mode:** One of the wireless network system in which devices communicate with each other by first going through the wireless router.
- 7. IP Address:** The unique 32 bit number assigned to each computer connected to the Internet. IP numbers are used by the TCP/IP protocol to route packets of data to their destinations.
- 8. TCP/IP:** The collection of "protocols" underlying the functioning of the Internet. Each computer connected to the Internet is identified by a unique IP Address.
- 9. SMTP:** Simple Mail Transfer Protocol.
- 10. FTP:** File Transfer Protocol. Network cameras equipped with an embedded operating system, such as Linux, can use FTP to send images to a website.
- 11. DHCP:** Dynamic Host Configuration Protocol is a set of rules used by communications devices such as a computer, router or network adapter to allow the device to request and obtain an IP address from a server which has a list of addresses available for assignment.
- 12 UPnP:** Universal Plug and Play is an architecture for pervasive peer-to-peer network connectivity of intelligent appliances and wireless devices.
- 13. DDNS:** DDNS is a method of keeping a domain name linked to a dynamic IP address with your Network Camera. You can set up your DDNS service and the device will automatically update your DDNS server each time it alter a different IP address.
- 14. Time server:** A time server consists of a computer networking device that reads the actual time from a reference clock and distributes this information to its clients using a computer network.
- 15. WPA:** Wi-Fi Protected Access (WPA and WPA2) is a class of systems to secure wireless (Wi-Fi) computer networks. WPA implements the majority of the IEEE 802.11i standard, and was intended as an intermediate measure to take the place of WEP while 802.11i was prepared.

EU Environmental Protection

Waste electrical products should not be disposed of with household waste. Please recycle where facilities exist. Check with your Local Authority or retailer for recycling advice.



Warning

This device complies with Part 15 of the FCC Rules. Operation is subject to the following two conditions:

(1) this device may not cause harmful interference, and (2) this device must accept any interference received, including interference that may cause undesired operation.

NOTE 1: Any changes or modifications to this unit not expressly approved by the party responsible for compliance could void the user's authority to operate the equipment.