

Yealink

IP Conference Phone

CP920

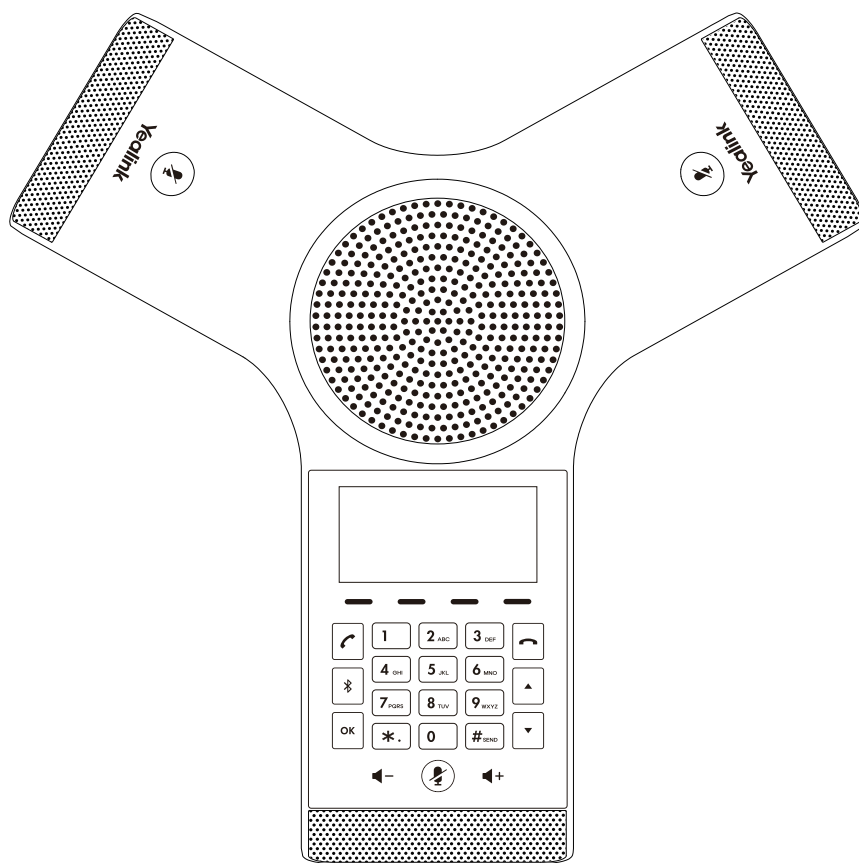

English | 简体中文

Quick Start Guide (V81.1)

FCC Statement

This device is compliant with Part 15 of the FCC Rules. Operation is subject to the following two conditions:

1. This device may not cause harmful interference, and
2. This device must accept any interference received, including interference that may cause undesired operation.

Note: This equipment has been tested and found to comply with the limits for a Class B digital device, pursuant to part 15 of the FCC Rules. These limits are designed to provide reasonable protection against harmful interference in a residential installation. This equipment generates, uses and can radiate radio frequency energy and, if not installed and used in accordance with the instructions, may cause harmful interference to radio communications. However, there is no guarantee that interference will not occur in a particular installation. If this equipment does cause harmful interference to radio or television reception, which can be determined by turning the equipment off and on, the user is encouraged to try to correct the interference by one or more of the following measures:

1. Reorient or relocate the receiving antenna.
2. Increase the separation between the equipment and receiver.
3. Connect the equipment into an outlet on a circuit different from that to which the receiver is connected.
4. Consult the dealer or an experienced radio/TV technician for help.

This equipment must be installed and operated in accordance with provided instructions and the antenna(s) used for this transmitter must be installed to provide a separation distance of at least 20 cm from all persons and must not be co-located or operating in conjunction with any other antenna or transmitter. End-users and installers must be provided with antenna installation instructions and transmitter operating conditions for satisfying RF exposure compliance.

FCC Caution: Any changes or modifications not expressly approved by the party responsible for compliance could void the user's authority to operate this equipment.

Canada Statement

This device complies with Industry Canada's licence-exempt RSSs. Operation is subject to the following two conditions:

(1) This device may not cause interference; and (2) This device must accept any interference, including interference that may cause undesired operation of the device.

Le présent appareil est conforme aux CNR d'Industrie Canada

applicables aux appareils radio exempts de licence. L'exploitation est autorisée aux deux conditions suivantes :

(1) l'appareil ne doit pas produire de brouillage;

(2) l'utilisateur de l'appareil doit accepter tout brouillage radioélectrique subi, même si le brouillage est susceptible d'en compromettre le fonctionnement.

The device meets the exemption from the routine evaluation limits in section 2.5 of RSS 102 and compliance with RSS-102 RF exposure, users can obtain Canadian information on RF exposure and compliance.

Le dispositif rencontre l'exemption des limites courantes d'évaluation dans la section 2.5 de RSS 102 et la conformité à l'exposition de RSS-102 rf, utilisateurs peut obtenir l'information canadienne sur l'exposition et la conformité de rf.

This transmitter must not be co-located or operating in conjunction with any other antenna or transmitter. This equipment should be installed and operated with a minimum distance of 20 centimeters between the radiator and your body.

Cet émetteur ne doit pas être Co-placé ou ne fonctionnant en même temps qu'aucune autre antenne ou émetteur. Cet équipement devrait être installé et actionné avec une distance minimum de 20 centimètres entre le radiateur et votre corps.

Table of Contents

English	1
简体中文.....	7

Packaging Contents

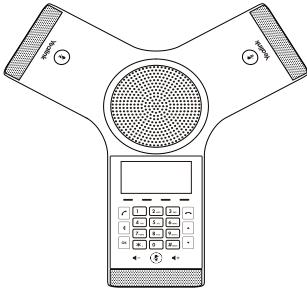

IP Phone

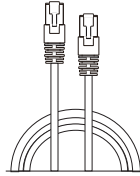

7.5m
Ethernet Cable

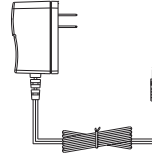

2.5m
Power Adapter

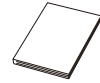

Quick Start Guide

Note: We recommend that you use the accessories provided or approved by Yealink. The use of unapproved third-party accessories may result in reduced performance.

Assembling the Phone

1. Connect the power and wired network.

You have two options for network and power connections. Your system administrator will advise you which one to use.

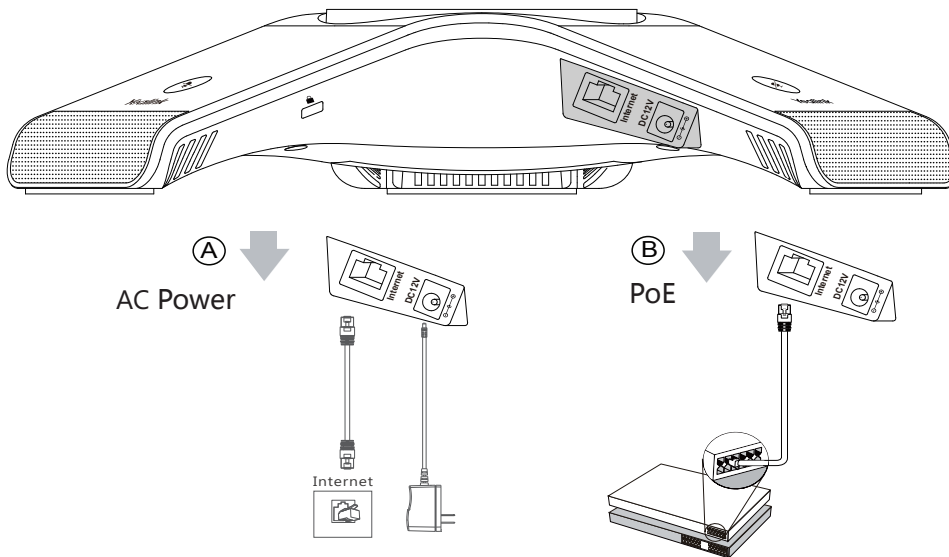

You can also connect to the wireless network after startup. Refer to **Wireless Network Connection** mentioned below in **Configuring Your Phone** for more information.

Note: The IP phone should be used with Yealink original power adapter(12V/1A) only. If inline power (PoE) is provided, you don't need to connect the power adapter. Make sure the hub/switch is PoE-compliant.

2. Connect the optional USB flash drive.

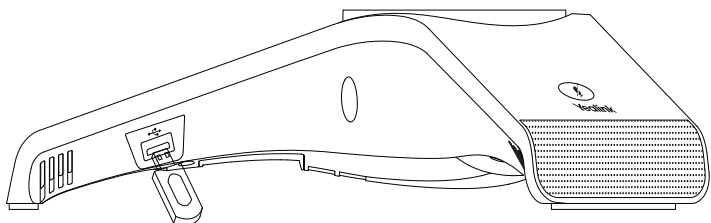

Startup

After the IP phone is connected to the network and supplied with power, it automatically begins the initialization process. After startup, the phone is ready for use. You can configure the phone via web user interface or phone user interface.

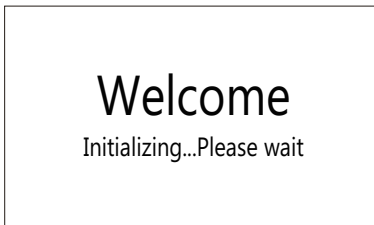

Hardware Component Instructions

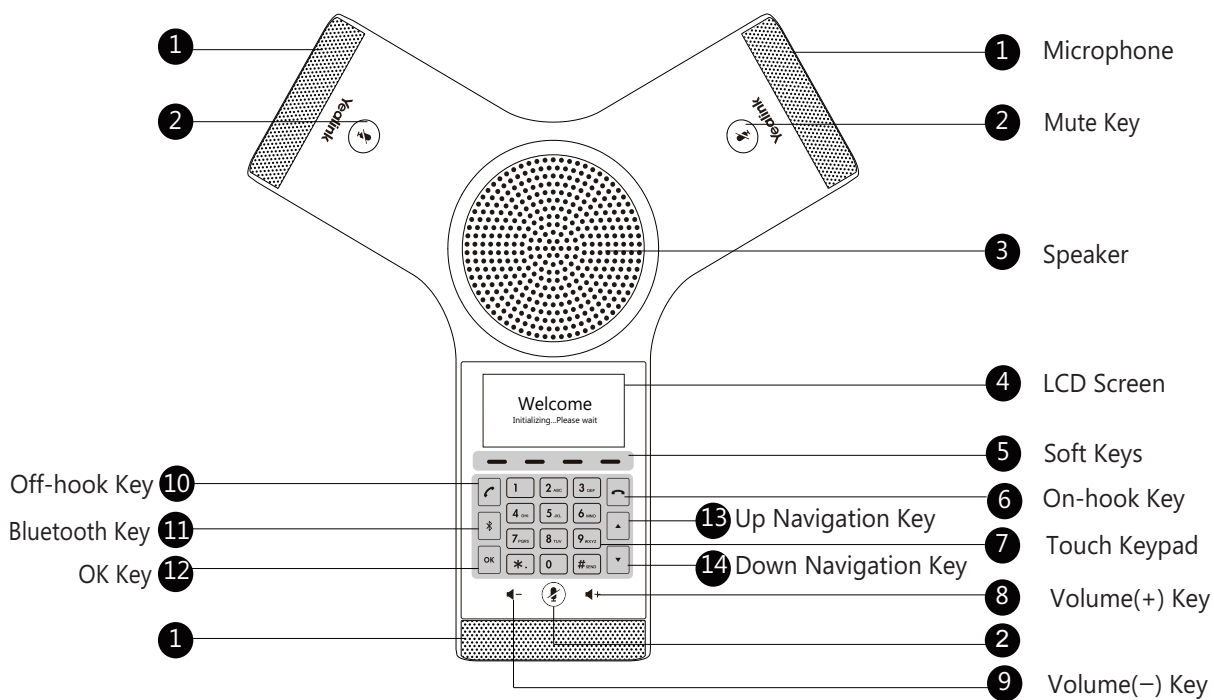

Configuring Your Phone

Configuring via web user interface

Accessing the web user interface:

1. Tap **OK** to obtain the IP address of the phone.
2. Open a web browser on your computer, enter the IP address into the address bar (e.g., "http://192.168.0.10" or "192.168.0.10"), and then press **Enter**.
3. Enter the user name (default: admin) and password (default: admin) in the login page and click **Confirm**.

Network Settings: Click on **Network->Basic->IPv4 Config**.

You can configure the network settings in the following ways:

DHCP: By default, the phone attempts to contact a DHCP server in your network to obtain its valid network settings, for example, IP address, subnet mask, gateway address and DNS address.

Static IP Address: If the phone cannot contact a DHCP server for any reason, you need to configure IP.

Note: The IP phone also supports IPv6, but IPv6 is disabled by default.
The wrong network settings may result in inaccessibility of your phone and may have an impact on the network performance. Contact your system administrator for more information.

Account Settings: Click on **Account->Register**.

Parameters of the account:

Register Status:	It shows the register status of the current account.
Line Active:	You can select Enabled/Disabled to enable/disable the account.
Label:	It is shown on the LCD screen to identify the account.
Display Name:	It is shown as Caller ID when placing a call.
Register Name:	It is an authenticated ID for authentication provided by ITSP (required).
User Name:	It is provided by ITSP for registration (required).
Password:	It is provided by ITSP for registration (required).
Server Host:	It is provided by ITSP for registration (required).

Register status icons on the LCD screen:



Registered

No Service Register Failed(Registering)

Note: Check with your system administrator if any error appears during the registration process or a specific configuration is required for your registration.

Configuring via phone user interface

Network Settings:

1. Tap **Menu** soft key, select **Settings->Advanced Settings**(default password: admin) -> **Network->WAN Port/VLAN/Webserver Type/802.1x/VPN/LLDP/CDP/NAT** to configure the network.

Wireless Network Connection:

1. Tap the soft key **Menu**, select **Settings ->Basic Settings** .
2. Select **Wi-Fi**.
3. Tap the **Switch** soft key to turn **Wi-Fi** on.
4. Tap the **Save** soft key.

The phone will automatically search for available wireless networks in your area.

5. Select an available wireless network from the list of **Available Networks**.
6. If the network is secure, enter its password in the **Password** field.
7. Tap the **Connect** soft key to connect to the wireless network.



Account Settings:

Tap **Settings**->**Advanced** (default password: admin) ->**Accounts** to configure the account.



Basic Call Features

Placing a Call**do one of the following:**

- Tap .

Enter the phone number, and then tap , ,  or the **Send** soft key.

- Enter the phone number.

Tap , ,  or the **Send** soft key.

Answering a Call

Tap ,  or the **Answer** soft key.

Ending a Call

Tap  or the **EndCall** soft key.

Call Mute and Unmute**To mute a call:**

Tap , the mute key LED illuminates solid red.

To unmute a call:

Tap  again to unmute the call. The mute key LED illuminates solid green.

Call Hold and Resume**To hold a call:**

Tap the **Hold** soft key during a call.

To resume a call:

Tap the **Resume** soft key during a call.

Local Conference

You can host a five-way conference with up to four parties.

To initiate a conference:

1. Tap the **Conf** soft key during a call.
2. Enter the number of the second party, and then tap the **Send** soft key.

You can also select a contact from **Directory** to join into a conference.

3. Repeat the step 2 to join more members.

The members are added to the conference after answering.

To manage the individual participant:

Tap  or  to select desired participant, do the following:

- Tap the **Far Mute** soft key to mute the participant. The muted participant can hear everyone, but no one can hear the muted participant.
- Tap the **Remove** soft key to remove the participant from the conference.
- Tap the **Split All** soft key to split the participants from the conference.

Call Recording

You can record audio calls in the phone itself or onto a USB flash drive (if connected).

To record audio calls:

1. Tap the **More** soft key, and then tap the **Start REC** soft key during a call.
2. Tap the **Pause REC** soft key to pause recording, tap the **Re REC** soft key to resume recording.
3. Tap the **Stop REC** soft key to stop recording . The record file will be saved.

If you end a call or conference during recording, the record file will be saved automatically.

Note: This feature is not available by default .For more information ,contact your administrator.

Call Forward

You can forward an incoming call to a contact, or forward all incoming calls to a contact.

To forward an incoming call to a contact:

1. Tap the **Forward** soft key from the Incoming Call screen.
2. Enter the number you want to forward to.
You can also select a contact from **Directory** .The call is forwarded to the contact directly.
3. Tap the **Send** soft key.

To forward all incoming calls to a contact:

1. Tap the **Menu** soft key, select **Features**.
2. Select **Call Forward** .
3. Select the desired forwarding type:
 - Always Forward**----Incoming calls are forwarded unconditionally.
 - Busy Forward**----Incoming calls are forwarded when the phone is busy.
 - No Answer Forward**----Incoming calls are forwarded if not answered after a period of time.
4. Turn on the desired forwarding type.
5. Enter the number you want to forward to in the **Forward To** field.
6. If you select **No Answer Forward**, select the **After Ring Time** field to select a desired ring time to wait before forwarding.
7. Tap the **Save** soft key to accept the change.



Call Transfer

You can transfer a call in the following ways:



Blind Transfer

1. Tap the **Transfer** soft key during a call. The call is placed on hold.
2. Enter the number you want to transfer to. You can also select a contact you want to transfer to from **Directory**.
3. Tap the **Transfer** soft key.

Semi-Attended Transfer

1. Tap the **Transfer** soft key during a call. The call is placed on hold.
2. Enter the number you want to transfer to.
3. Tap  ,  or  .
4. Tap the **Transfer** soft key when you hear the ring-back tone.

Attended Transfer

1. Tap the **Transfer** soft key during a call. The call is placed on hold.
2. Enter the number you want to transfer to.
3. Tap  ,  or  .
4. Tap the **Transfer** soft key when the second party answer.

Customizing Your Phone

Local Directory

To add a contact:

1. Tap the **Directory** soft key from the Idle screen.
2. Select **Local Directory**, then enter **All Contacts**.
3. Tap the **Add** soft key to add a contact.
4. Enter a unique contact name in the **Name** field and contact numbers in the corresponding fields.
5. Tap the **Save** soft key to accept the change.

To edit a contact:

1. Tap the **Directory** soft key from the Idle screen.
2. Select **Local Directory**, then enter **All Contacts**.
3. Select the desired contact, tap the **Option** soft key and then select **Detail**.
4. Edit the contact information.
5. Tap the **Save** soft key to accept the change.

To delete a contact:

1. Tap the **Directory** soft key, then select **Local Directory**->**All Contacts**.
2. Select the desired contact, tap the **Option** soft key and then select **Delete**.
3. Tap **OK** when the LCD screen prompts "Delete selected item?".

Note: You can add contacts from call history easily. For more information, refer to **Call History**.

Call History

1. Tap the **History** soft key from the idle screen.
2. Enter **All Calls**, and then select the desired call history entry.
3. Select an entry from the list, you can do the following:

- Tap the **Send** soft key to call the entry.
- Tap the **Delete** soft key to delete the entry from the list.

If you tap the **Option** soft key, you can also do the following:

- Select **Detail** to view detailed information about the entry.
- Select **Add to Contact** to add the entry to the local directory.
- Select **Add to Blacklist** to add the entry to the blacklist.
- Select **Delete All** to delete all entries from the list.

Volume Adjustment.

- Tap ◀-or ▶+ during a call to adjust the receiver volume.
- Tap ◀-or ▶+ when the phone is idle or ringing to adjust the ringer volume.
- Tap ◀-or ▶+ to adjust the media volume in the corresponding screen.

包装清单

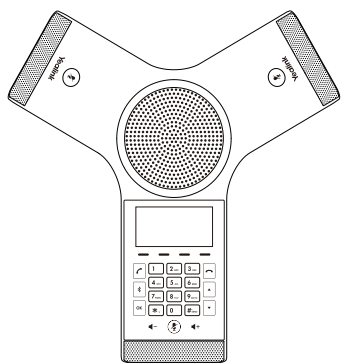

IP会议电话

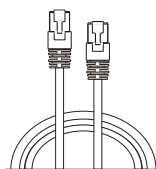

7.5米以太网线

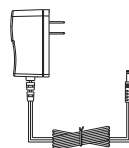

2.5m线长电源适配器



快速入门指南

说明：我们推荐使用由Yealink提供或经Yealink认可的配件，使用未经认可的第三方配件可能会导致性能的下降。

安装电话

1. 连接电源和网线：

话机支持两种供电方式。请根据实际情况选择以下任意一种方式：

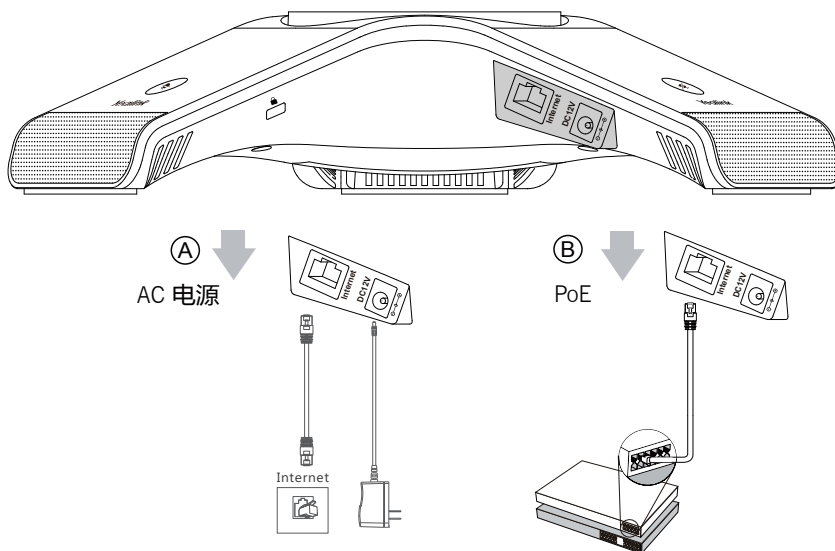

话机也支持连接到无线网络（Wi-Fi）。想要了解更多信息，请参考[配置话机](#)章节中的[无线网络连接](#)。

说明：我们要求使用Yealink原装电源(12V/1A)，使用第三方电源可能会导致话机损坏。

如果电源线或网线外包装表皮出现破损，请立即更换。

2. 连接U盘（可选）：

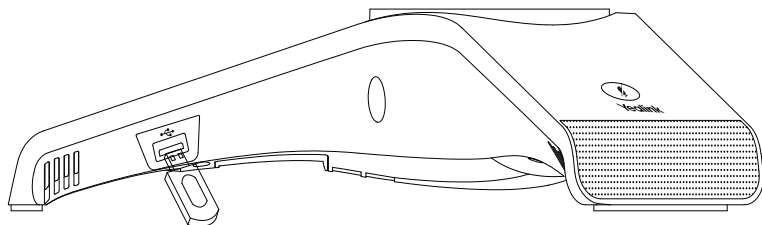

启动

在话机连接上网络和电源后，话机自动启动。启动完成后，话机能正常使用。你可以通过Web界或话机界面配置话机。

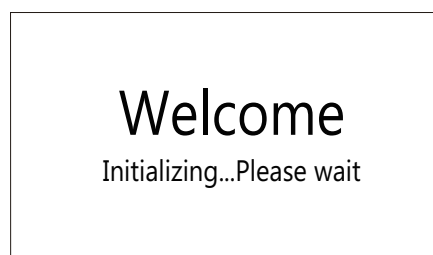

硬件介绍

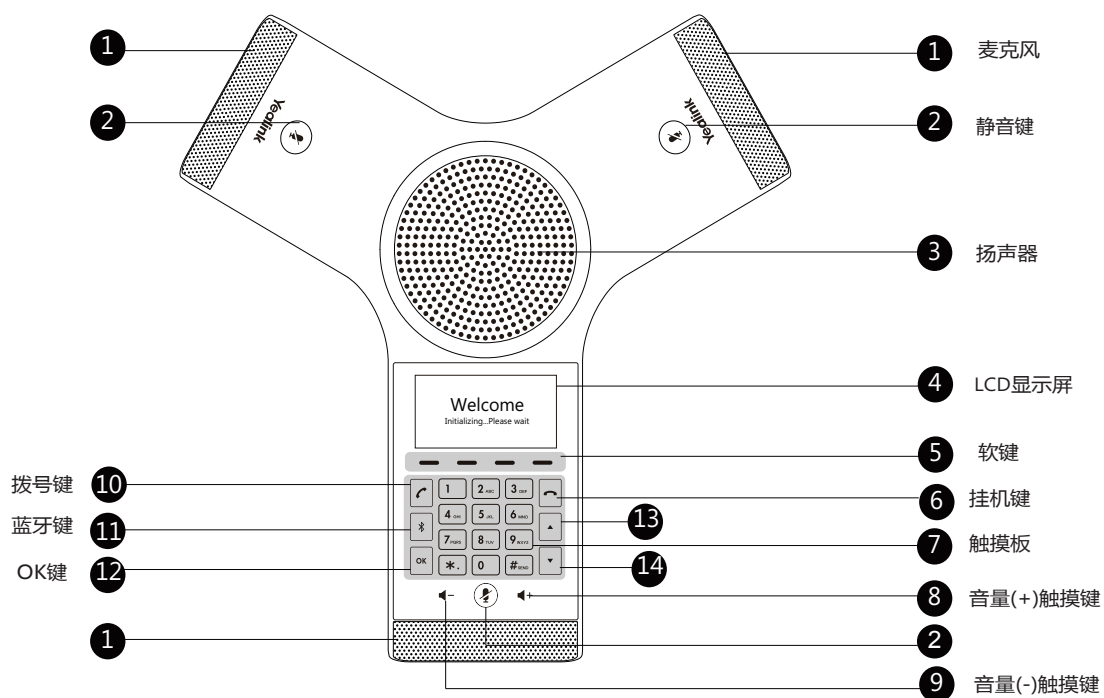

配置话机

通过Web界面配置话机

访问Web界面：

- 1.在话机空闲时，按**OK**查看话机的IP地址。
- 2.打开电脑上的网页浏览器，在地址栏里输入话机的IP地址。
(例如：http://192.168.0.10或192.168.0.10)，按 **Enter**键。
- 3.在登录界面的用户名输入框中输入管理员用户名“admin”，密码输入框中输入管理员密码“admin”，
点击**提交**。

网络配置：点击**网络配置**->**基础**->**IPv4配置**。

你可以通过以下方式配置网络：

DHCP：话机默认通过DHCP服务器获取网络配置。例如：IP地址、子网掩码、网关和DNS服务器。

静态IP地址：如果话机无法通过DHCP服务器获取网络配置，你需要手动配置IP地址、子网掩码、网关、首选DNS服务器和备选DNS服务器。

说明：话机的网络配置也支持IPv6协议，但IPv6默认是关闭的。
错误的网络设置会导致网络不可用，也可能对网络的性能造成影响。请咨询你的系统管理员了解更多信息。

账号配置：点击**账号**->**注册**。

账号参数：

- 注册状态： 显示当前账号的注册状态。
- 线路激活： 启用/禁用账号。
- 标签： 显示在显示屏上的账号标签。
- 显示名称： 呼出号码时，显示在对方话机上的名称。
- 注册名称： 由网络技术服务提供商提供 (必填)。
- 用户名称： 由网络技术服务提供商提供 (必填)。
- 密码： 由网络技术服务提供商提供 (必填)。
- SIP服务器： 由网络技术服务提供商提供 (必填)。

话机LCD显示屏显示账号注册状态的图标：



说明：如果注册失败，请咨询你的系统管理员。

通过话机界面配置话机

网络配置：

在话机空闲时，按**设置**->**高级设置**（默认密码：admin）->**网络**->**WAN端口/VLAN/网络服务器**
/802.1x/VPN/LLDP/CDP/NAT。

无线网络连接：

1. 在空闲界面上，按**菜单**，在**设置**中选择**基础设置**。
2. 选择**无线网络**。
3. 打开**无线网络**开关。
话机将自动搜索附近可用的Wi-Fi。
4. 从可用的网络列表中，选择一个Wi-Fi。

5. 如果要连接一个加密的网络，在**密码**区域中输入密码。

6. 按**连接**。

账号配置：

在话机空闲时，按**设置**->**高级设置**（默认密码：admin）->**账号**。

基本功能

拨打电话

使用下面的任意一种方式拨打：

- 按 。

输入号码，然后按 , ,  或**发送**软键。

- 输入号码。

按 , ,  或**发送**软键。

接听电话

按**应答**。

结束通话

按**挂断**。

静音或取消静音

开启通话静音：

在通话中，按触摸屏上的 。静音键的LED灯红色常亮。

取消通话静音：

再次按触摸屏上的 。静音键的LED灯绿色常亮。

通话保持和恢复

通话保持：

在通话中，按**保持**。

恢复通话：

按**恢复**。

会议

话机最多支持五方会议。

创建会议：

1. 在通话中，按**会议**。

2. 输入第二个成员的号码，按**发送**。

你也可以从**话簿**中选择联系人加入会议。

4. 重复步骤3，添加更多成员。

成员接听来电后，自动加入会议。

会议成员管理：

按相应成员，可以进行以下操作：

- 按**禁言**禁止该成员发言。该成员可以听到会议内容，但是其他成员无法听到该成员的声音。
- 按**移除**将该成员移除。
- 按**拆分所有**将会议拆分成多路独立的通话。

通话录音

你可以录制音频通话，然后将录音文件保存在话机或U盘上。

录制音频通话：

1. 在通话中，按**更多**，然后选择**开始录音**。
2. 按**暂停录音**录音暂停，按**恢复录音**录音恢复。
3. 按**停止录音**录音结束，录音文件自动保存。

如果你结束通话，录音将在通话结束时自动保存。

呼叫转移

你可以转移当前来电，或转移所有来电。

转移当前来电：

1. 在来电界面，按**转移**。
2. 输入你希望转移到的号码。

你也可以从**话簿**中选择一个联系人。来电将直接转移到该联系人。

3. 按**转移**。

转移所有来电：

1. 按**菜单**软键进入**设置**。
2. 在功能区域中选择**呼叫转移**。
3. 选择呼叫转移的类型：

无条件转移----话机的所有来电，将被无条件自动转移到预先指定的号码。

遇忙转移-----当话机忙时，来电将被转移到预先指定的号码。

无应答转移----当话机在指定的响铃时间内无应答时，来电将被转移到预先指定的号码。

4. 打开相应的开关。
5. 输入你希望转移到的号码。
6. 如果选择**无应答转移**，在**响铃时长**区域选择转移前等待的响铃时间。
7. 按**保存**保存操作。

通话转接

你可以使用下述三种方式将通话转接到另一方：

盲转

1. 在通话中，按**转接**。当前的通话被保持。
2. 输入你要转接到的号码。你也可以从**话簿**中选择要转接到的联系人。
3. 按**转接**。

半咨询转

1. 在通话中，按**转接**。当前的通话被保持。
2. 输入你要转接到的号码。
3. 按**发送**。
4. 在听到回铃音后，按**转接**。

咨询转

1. 在通话中，按**转接**。当前的通话被保持。
2. 输入你要转接到的号码。
3. 按**发送**。
4. 在对方接听来电并进行咨询后，按**转接**。

自定义话机

联系人

添加联系人：

1. 在空闲界面，按**话簿**。
2. 按**本地联系人**进入**所有联系人**。
3. 按**添加**添加联系人。
4. 在**姓名**区域输入联系人姓名，在相应的区域输入联系人号码。
5. 按**保存**操作。

编辑联系人：

1. 在空闲界面，按**话簿**。
2. 按**本地联系人**进入**所有联系人**。
3. 选择需要的联系人，按**选项**操作进入**详情**。
4. 编辑联系人信息。
5. 按**保存**操作。

删除联系人：

1. 在空闲界面，按**话簿**，选择**本地联系人**中的**所有联系人**。
2. 按联系人后的**选项**，然后按**删除**。
3. 显示屏弹出“**删除选中条目？**”，按**确定**删除联系人。

说明：你可以从**话单**中添加联系人。了解更多信息，请参考**话单**章节。

话单

1. 在空闲界面，按**话单**。
2. 进入**所有通话**，然后选择相应的通话记录列表。
3. 从所有通话中选择对应的记录，你可以进行如下操作：
 - 按**呼叫**拨打电话。
 - 按**删除**删除选中的条目。

如果你按**选项**，你可以进行如下操作：

- 按**详情**查看记录的具体信息。
- 按**添加到联系人**将条目添加到本地通讯录中。
- 按**添加黑名单**添加条目到黑名单。
- 按**全部删除**删除所有记录。

音量调节

- 在通话中，按 **◀**-或 **▶**+ 调节接收音量。
- 在话机空闲或响铃时，按 **◀**-或 **▶**+ 调节响铃的音量。
- 在媒体播放界面，按 **◀**-或 **▶**+ 调节媒体播放的音量。

About Yealink

Yealink (Stock Code: 300628) is a global leading unified communication (UC) terminal solution provider that primarily offers video conferencing systems and voice communication solutions. Founded in 2001, Yealink leverages its independent research and development and innovation to pursue its core mission: "Easy collaboration, high productivity." The company's high-quality UC terminal solutions enhance the work efficiency and competitive advantages of its customers in over 100 countries. Yealink is the world's second-largest SIP phone provider and is number one in the China market.

Technical Support

Visit Yealink WIKI (<http://support.yealink.com/>) for the latest firmware, guides, FAQ, Product documents, and more. For better service, we sincerely recommend you to use Yealink Ticketing system (<https://ticket.yealink.com>) to submit all your technical issues.

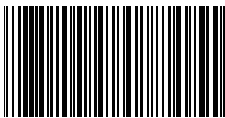

CP920-EN+CN

YEALINK(XIAMEN) NETWORK TECHNOLOGY CO.,LTD.
Web: www.yealink.com
Addr: 309, 3th Floor, No.16, Yun Ding North Road, Huli
District, Xiamen City, Fujian, P.R. China
Copyright©2017 YEALINK(XIAMEN) NETWORK
TECHNOLOGY CO.,LTD.All rights reserved.