

# USERS MANUAL

VHF Transceiver  
**XM-1000 / XM-1200**  
UHF Transceiver  
**XM-4000 / XM-4200**



\* Version #1 (2011-05-16)

**YEONHWA M Tech Co., Ltd**

3F Yukyoung B/D, 544-6, Gasan-dong, Geumcheon-gu, Seoul, 153-803, Korea

# **Table of Contents**

1. Safety / Warnings
2. Feature
3. Appearance of XM Series Mobile Radio
4. Controls & keys
5. Menu Description
6. Terminal Description
7. Specification

# 1. Safety / Warnings

## Notices

 <p>WARNING</p>	<ul style="list-style-type: none"><li>◆ Government law restricts the operation of unlicensed radio transmitters within government controlled territories.</li><li>◆ Illegal operation is punishable by fine or imprisonment or both.</li><li>◆ Refer service to qualified technicians only.</li></ul>
--------------------------------------------------------------------------------------------------	-------------------------------------------------------------------------------------------------------------------------------------------------------------------------------------------------------------------------------------------------------------------------------------------------------

 <p>WARNING</p>	<ul style="list-style-type: none"><li>◆ <b>EXPLOSIVE ATMOSPHERES (GASES, DUST, FUMES, etc.)</b></li></ul> <p>Shut OFF the transceiver while refueling or while parked in gasoline service stations.</p> <p>Do not carry spare fuel containers in the trunk of your vehicle if your transceiver is mounted in the trunk area</p>
--------------------------------------------------------------------------------------------------	---------------------------------------------------------------------------------------------------------------------------------------------------------------------------------------------------------------------------------------------------------------------------------------------------------------------------------

 <p>WARNING</p>	<ul style="list-style-type: none"><li>◆ <b>INJURY FROM RADIO FREQUENCY TRANSMISSIONS</b></li></ul> <p>Do not operate your transceiver when somebody is either touching the antenna or standing within two to three feet of it, to avoid the possibility of radio frequency burns or related physical injury.</p>
---------------------------------------------------------------------------------------------------	------------------------------------------------------------------------------------------------------------------------------------------------------------------------------------------------------------------------------------------------------------------------------------------------------------------

## Precautions

Please read carefully the following precautions to prevent fire, personal injury, or transceiver damage:

 <p>Caution</p>	<ul style="list-style-type: none"><li>● Do not attempt to configure your transceiver while driving, it is dangerous.</li><li>● This transceiver is designed for a 13.8V DC power supply. Don't use a 24V battery including over DC 16V supply to power on the transceiver.</li><li>● Do not put the transceiver in excessively dusty, humid or wet areas, nor unstable surfaces.</li><li>● Do not modify the transceiver for any reason.</li><li>● Please keep it away from interferential devices (such as TV, generator, Medical devices etc.)</li><li>● Do not expose the transceiver to long periods of direct sunlight nor place it close to heating appliances.</li><li>● If an abnormal odor or smoke is detected coming from the transceiver, turn OFF the power immediately. Contact an Any tone service station or your dealer.</li></ul>
----------------------------------------------------------------------------------------------------	-----------------------------------------------------------------------------------------------------------------------------------------------------------------------------------------------------------------------------------------------------------------------------------------------------------------------------------------------------------------------------------------------------------------------------------------------------------------------------------------------------------------------------------------------------------------------------------------------------------------------------------------------------------------------------------------------------------------------------------------------------------------------------------------------------------------------------------------------------

 <p>Caut i on</p>	<ul style="list-style-type: none"> <li>● Do not transmit with high output power for extended periods; the transceiver may overheat.</li> <li>● Do not operate the transceiver when vehicle engine is stopped. The vehicle engine may not be started due to low battery.</li> <li>● Do not use incompatible accessories from other manufactures. It could result in damage and or malfunction to the accessory and or to the radio.</li> </ul>
----------------------------------------------------------------------------------------------------	-----------------------------------------------------------------------------------------------------------------------------------------------------------------------------------------------------------------------------------------------------------------------------------------------------------------------------------------------------------------------------------------------------------------------------------------------

## PREPARATION

 <p>WARNING</p>	<p>Various electronic equipment in your vehicle may malfunction if they are not properly protected form the radio frequency energy which is present while transmitting. Typical examples include electronic fuel injection, anti-skid braking and cruise control. If your vehicle contains such equipment, consult the dealer for the make of vehicle and enlist his/her aid in determining if they will perform normally while transmitting</p>
--------------------------------------------------------------------------------------------------	--------------------------------------------------------------------------------------------------------------------------------------------------------------------------------------------------------------------------------------------------------------------------------------------------------------------------------------------------------------------------------------------------------------------------------------------------

## Power Cable Connection

 <p>Caut i on</p>	<p>The transceiver operates in 12V negative ground system only! Check the battery polarity and voltage of vehicle before installing the transceiver.</p>
------------------------------------------------------------------------------------------------------	----------------------------------------------------------------------------------------------------------------------------------------------------------

1. Check for an existing hole, conveniently located in the firewall, where the power cable can be passed through.
  - If no hole exists, use a circle cutter to drill a hole, then install a rubber grommet
2. Run the power cable though the firewall and into the engine compartment.
3. Connect the red lead to the (+) battery terminal and the black lead to the negative (-) battery terminal
  - Place the fuse as close to the battery as possible
4. Coil the surplus cable and secure it with a retaining band.
  - Be sure to leave enough slack in the cables so the transceiver can be removed for servicing while keeping the power applied.

## **RADIO FREQUENCY ENERGY SAFETY INFORMATION**

Your radio generates RF electromagnetic energy during transmit mode. This radio is designed for and classified as “Occupational Use Only”, meaning it must be used only during the course of employment by individuals aware of the hazards, and the ways to minimize such hazards. This radio is NOT intended for use by the “General Population” in an uncontrolled environment.

This radio has been tested and complies with the FCC RF exposure limits for “Occupational Use Only”. In addition, your XRADIO radio complies with the following Standards and Guidelines with regard to RF energy and electromagnetic energy levels and evaluation of such levels for exposure to humans:

- FCC OET Bulletin 65 Edition 97-01 Supplement C, Evaluating Compliance with FCC Guidelines for Human Exposure to Radio Frequency Electromagnetic Fields.

- American National Standards Institute (C95.1-1992), IEEE Standard for Safety Levels with Respect to Human Exposure to Radio Frequency Electromagnetic Fields, 3 kHz to 300 GHz.

- American National Standards Institute (C95.3-1992), IEEE Recommended Practice for the Measurement of Potentially Hazardous Electromagnetic Fields– RF and Microwave.

- The following accessories are authorized for use with this product. Use of accessories other than those (listed in the instruction) specified may result in RF exposure levels exceeding the FCC requirements for wireless RF exposure. To ensure that your exposure to RF electromagnetic energy is within the FCC allowable limits for occupational use, always adhere to the following guidelines:

- DO NOT operate the radio without a proper antenna attached, as this may damaged the radio and may also cause you to exceed FCC RF exposure limits. A proper antenna is the antenna supplied with this radio by the manufacturer or antenna specifically authorized by the manufacturer for use with this radio.

- DO NOT transmits for more than 50% of total radio use time (“50%duty cycle”). Transmitting more than 50% of the time can cause FCC RF exposure compliance requirements to be exceeded. The radio is transmitting when the “TX indicator” lights red. You can cause the radio to transmit by pressing the “PTT” switch.

- ALWAYS keep the antenna at least 45 cm away from the body when transmitting to ensure FCC RF exposure compliance requirements are not exceeded. The information listed above provides the user with the information needed to make him or her aware of RF exposure, and what to do to as-sure that this radio operates with the FCC RF exposure limits of this radio. Electromagnetic Interference/Compatibility During transmissions, your XRADIO radio generates RF energy that can possibly cause interference with other devices or systems. To avoid such interference, turn off the radio in areas where signs are posted to do so. DO NOT

operate the transmitter in areas that are sensitive to electromagnetic radiation such as hospitals, aircraft, and blasting sites. Occupational/Controlled Use The radio transmitter is used in situations in which persons are exposed as consequence of their employment provided those persons are fully aware of the potential for exposure and can exercise control over their exposure.

FCC Notice Cautions. Changes or Modifications not expressly approved by the party responsible for compliance could void the user's authority to operate the equipment.

## Installing the transceiver



For passenger safety, install the transceiver securely using the supplied mounting bracket and screw set, so the transceiver will not break loose in the event of a collision.

1. Mark the position of the hole in the dash, using the mounting bracket as a template. Using a 4.2mm(5/32 inch) drill bit, drill the holes, then attach the mounting bracket using the supplied screws.
  - Mount the transceiver within easy reach of the user and where there is sufficient space at the rear of the transceiver for cable connections.
2. Connect the antenna and the supplied power cable to the transceiver.
3. Slide the transceiver into the mounting bracket and secure it using the supplied hex-headed screws.
4. Mount the microphone hanger in a location where it will be within easy reach of the user.
  - The microphone and microphone cable should be mounted in a place where they will not interfere with the safe operation of the vehicle.



When replacing the fuse in the DC power cable, be sure to replace it with a fuse of the same value. Never replace a fuse with one that is rated with a higher value.

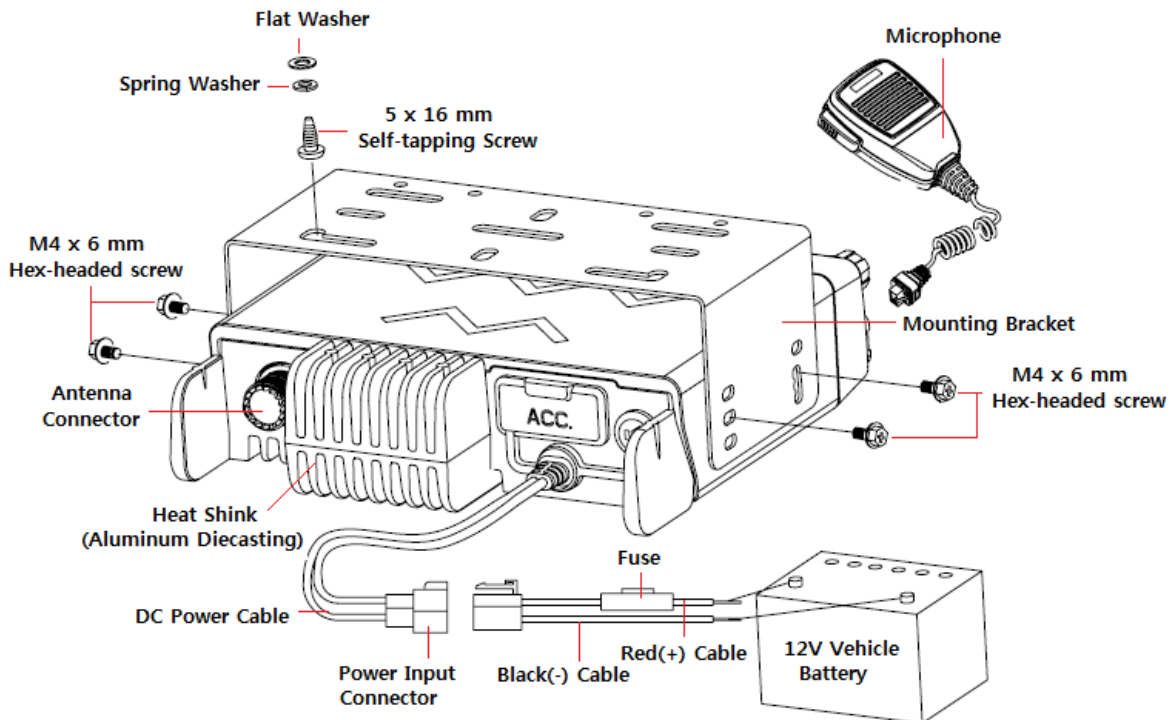

## Connecting Microphone

1. Insert the microphone plug into jack on the front panel of the transceiver.
  - Be sure the tab on the microphone plug is facing the left hand side.
2. Mount the microphone on the microphone hanger where it will be within easy reach of the user
3. To remove the microphone plug, press the tab on the connector while pulling the plug out of the transceiver jack

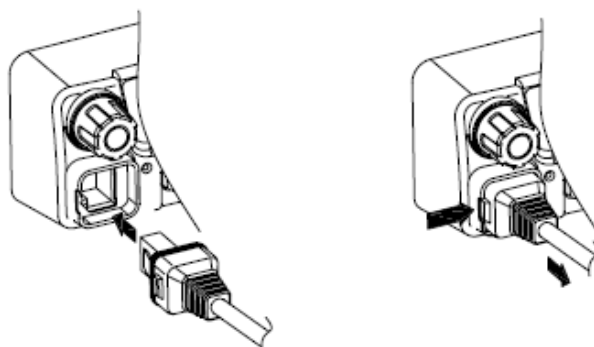

Figure 1-2) Installation and Removing the Microphone

## Supplied Accessories

Carefully unpack the transceiver. We recommend the you identify the items listed below before discarding the packing. If any item are missing or have been damaged during shipment, file a claim the carrier immediately.

### DC power cable

- 15A Fuse(XM-1000, XM-1200, XM-4000, XM-4200) ----- 1

Mounting Bracket ----- 1

### Screw set

- 5 x 16 mm self-tapping screw ----- 4
- Hex-headed screw with washer ----- 4
- Spring washer ----- 4
- Flat washer ----- 4

### Microphone(with cable)

- ACC 708 ----- 1

Microphone hanger(with 4 x16 mm self-tapping screws) ----- 1

Instruction manual ----- 1



## 2. Feature

The XM series Mobile Radio is developed to be user-friendly and compact design, to have various features and to use at the Distribution / industrial / public areas for the safety & convenience of users.

The followings are the main features of the XM Series Mobile Radio.

- 128 x 32 Dots Graphic LCD
- 512 Channels and 32 Groups are selectable.
- Channel spacing: 12.5KHz
- Wide Band Coverage (VHF : 136~174MHz, UHF : 400~470, 450~520MHz)
- Call guard squelch of standardized CTCSS / DCS
- Identification origination(2 Tone and 5 Tone)
- Built-in Scramble (Inversion Type)
- Built-in Compander (Compressor and Expander)
- GPS Data communication(Optional)
- Normal scanning / Priority scanning
- BCL (Busy Channel Lock)/BCLO (Busy Channel Lock Out)
- 40W(UHF)/50W(VHF) Power Switchable
- Selectable Squelch Level (0~10)
- Time-Out Timer (TOT)
- Standard DTMF Encode and DTMF Decoder with ANI Function
- Programmable Home Channel Function
- Emergency & Built-in Emergency Microphone
- Talk Around
- Internal or External Speaker
- Remote Radio Stun / Revive (Use 5 tone)
- Ignition Function / Horn Alert / Public Address
- 4W Front-Mounted Speaker
- Heavy-Duty Microphone
- Various Parameters and PC downloading methods
- Built-in D-SUB15 Accessory Connector
- PC Program Tuning

## 4. Appearance of XM Series Mobile Radio



Figure 4-1) Appearance XM-Series

### Supplied Accessories

#### Item Part Number Quantity

ACC-810N : Programming Software(Narrow Band Only – United States Only)

ACC-820NW : Programming Software(Narrow and Wide Band – Outside the USA)

Acc-8025 : PC Programming Cable(USB)

ACC-708 : Mobile Microphone

## 5. Controls & keys

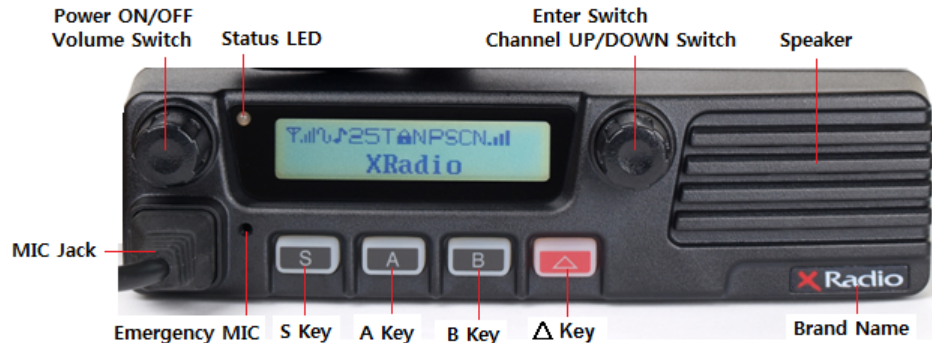

Figure 5-1) XM-1000 / XM-4000 Front panel

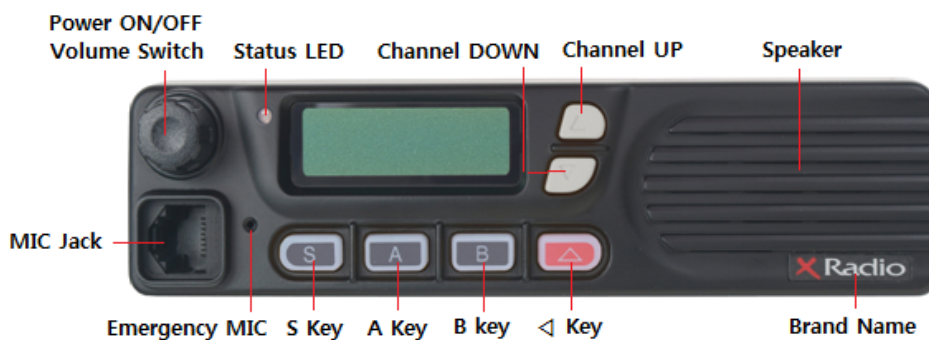
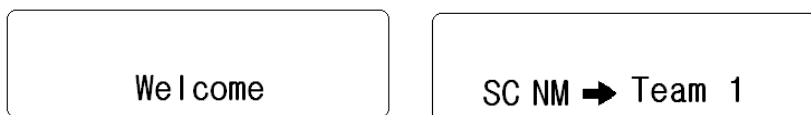

Figure 5-2) XM-1200 / XM-4200 Front panel

### Power ON/OFF Volume switch

Press and hold the knob over 2 seconds to turn the mobile radio on and off.



Rotate to adjust the volume level from 1 to 16. Turn it clockwise to increases the volume and counterclockwise to decreases the volume.

When the knob is pushed less 2 seconds, Squelch can be changed.

## Display

It is a 125x 36 Graphic type. Each icon indicates related operation.

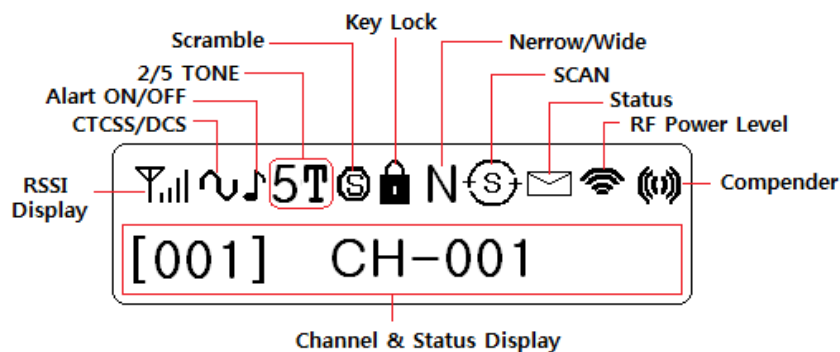

Figure 5-2) XM-Series LCD indicator

## Selector

Rotate to select a channel. Clockwise increase the channel and counterclockwise decrease the channel.

Press to select a group if the group is set.

Press and hold to enter a menu mode over 2 seconds.

## Microphone Jack

Insert the microphone plug into this jack.

## S Key

Press the key to activate its programmable function. The default setting is RF power / Selcall.

## A Key

Press the key to activate its programmable function. The default setting is Key tone/Menu.

## B Key

Press the key to activate its programmable function. The default setting is TX inhibit/Scan.

## △ Key

Press the key to activate its programmable function. The default setting is Monitor..

## TX/Busy LED

The TX LED lights green while transmitting.

## PTT switch

To send the signal, press and hold the switch, and then speak into the microphone.

Release to receive.

## 4.1 Programmable key functions

Keys can be programmed with the functions listed below. The key can only be programmed with functions, depending on your use intention. Each key has two functions to be programmed, as long press and short press. Please contact your dealer for further details on the functions.

Channel up	Talk around on/off
Channel down	Fast Channel Mode
Monitor on/off	BCL on/off
Key lock on/off	Scramble on/off
Scan Mode	Compander on/off
Selcall mode	TX inhibit on/off
TX power change	Key Tone on/off
Emergency	TX Alert on/off
DTMF on/off	GPS on/off
Horn Alert on/off	Menu
Public Address on/off	

The function can be selected only when GPS is installed.

## 4.2 Basic operations

### Power on/off

Press and hold the volume knob to turn the radio on.

If the radio is protected with password. "PASSWORD INPUT" will appear on the display when the power is on. To unlock the radio, enter the correct password.

1. Choose a number by rotating the selector
2. Press the selector to input the number
3. Repeat steps 1 and 2 to enter the whole password.

If no key is pressed within 10 seconds, the radio will return to the password protect state.

4. Press the selector to complete the entry over 1 seconds.

Press and hold the volume for approximately 2 seconds to turn the radio off.

## Volume adjustment

Rotate the volume knob clockwise to increase the volume and counterclockwise to decrease the volume. Maximum increment is 16 levels.

## Channel selection / Group selection

Choose the wanted channel/group using the selector if it is programmed with group.

To select a group, push the selector and move to the wanted group. And then push the selector at the wanted group as setting.

## Transmitting

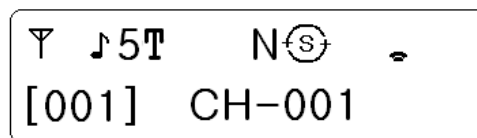

1. Choose the wanted group and a channel.
2. Press and hold the PTT switch, then speak into the microphone.

For best sound quality at the receiving radio, hold the microphone approximately 5~10cm from your mouth.

3. Release the PTT to receive.
4. When you communication is completed, return the microphone to its hanger.

## Receiving

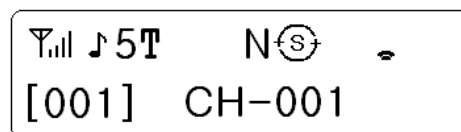

1. Select the wanted group and channel
2. When a call is received, LED becomes green and re-adjust the volume as necessary.

The user should not press the PTT during the reception.

If 2/5 tones are programmed as close mode, without any matched tones, the radio doesn't work normally. As it were, sending and receiving signals are prohibited until the matched tone is received.

## Scan

To activate the Scan function, press the “B” key( at default setting ) or the key programmed as Scan over 2 seconds.

The “ ” icon and “ ” icon between Channel No. and Frequency appears on the display. To stop the Scan, press and hold the “B” key ( at default setting ) over 2 seconds or push the scan programmed key.

## Normal scan

The scan is processed in the sequence of channels to be programmed. While the signal is being received, if you want to return the scan without listening the call, press the “S” button. If you delete the channel of receiving signal in the scan list during the receiving signal, press the button “A”.

## Priority scan

The priority scan is shown as “P-“ on the LCD. The priority scan is to check a receiving status between each scan channels as the procedure like P, S1, P, S2, P, S3. The priority channel is scanned periodically while the normal scan is checked. So, the priority is received priority to other signals. During the status of receiving signal, the channel can be moved to next scan channel by up/down button. Furthermore, the channel of receiving signal can be deleted from the list of scan temporarily. When the priority is received, the channel can not be changed or deleted.

## Key lock

During call waiting, if the key programmed as key lock is pressed, the “ ” icon is shown on the display. And the selector operation is halted and all keys except monitor function don't work.

## 4.3 Advanced operations

### Selcall

\*At programmed selcall, paging between individuals or groups can be available with 5 tones.

\*Maximum 200 IDs' can be memorized in the list.

\*To escape selcall model, press and hold the selector over 2 seconds.

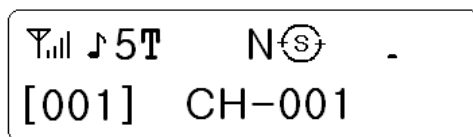

No selcall operation

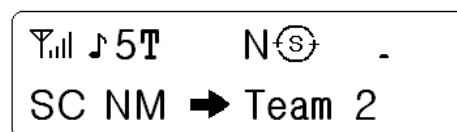

Selcall operation

### 1) Call on selcall

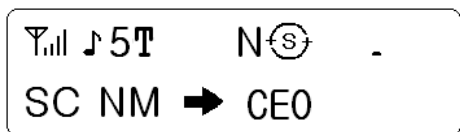

ID selection

At call waiting, press the “S” key over 2 seconds at default setting or the key programmed as selcall. Rotate the selector to select the selcall channel you want to call.

If you want to call “ID: A” in the list, select “A” by the selector.

And then push the selector to send the selcall signal to the radio you want to call.

If the program is set as sending caller’s ID altogether, the receiving radio is shown the caller’s ID on the display.

### Communication on the selcall

At selcall working, to select the channel of the party you want to talk.

Push the PTT button, and then caller’s ID is transmitted preferentially.

### Emergency

When one of buttons is programmed as emergency, the emergency function can be activated.

When a button programmed as emergency is pressed over 2 seconds, the alert signal is repeatedly transmitted in normal mode. When a radio is in 5 tone setting mode, the alert is transmitted with 5 tones.

### Fast Channel

Press a button programmed as Fast channel.

Rotate the selector to change channels.

Only channels programmed as Fast channel with ICON “F” is shown in the display.

This function is activated when some channels in the channel list are selected as Fast channel by programmer and a button is pre-programmed as fast channel setting.

### Stun/Revive

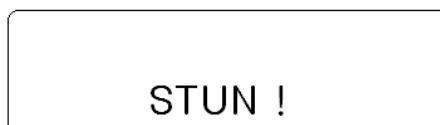

Stun status



When Stun/Revive function is programmed with selcal ID, stunning a radio or reviving a radio can be activated by remote control.

When a radio programmed with Stun ID receives Stun ID from a control radio, all buttons of the programmed radio is locked and out of control. At this status, only PTT works for sending alert sounds. The matter what the power is reset, the stun status is continued until it receives Revive ID.

### Scramble/Descramble

This function is used for preventing eavesdropping.

### BCL/BCLO

This function is to limit sending signals to avoid interrupting others' communication when many radio users are at same channel.

When the PTT is pushed, alert sounds with message shown on the display.

### TOT

This function is to prohibit a radio from occupying one channel for a long time.

The alert sounds when the time programmed as sending signal is over.

If the penalty time is programmed, the signal can be sent after the time passes.

### 2 Tone

When 2 tone is matched between caller and receiver in the status of programmed 2 tone, normal communication is performed.

### Horn Alert

This function is to alert people away from vehicle through external speaker when certain calls are received.

### Public Address

This function is to route sounds from microphone to an external speaker or similar external equipment.

### Talk Around

When communication through repeaters is performed, this function is to allow communication among radios directly if a repeater is out of range or out of order.

## 5. Menu Description

To enter into the menu, press and hold the right knob for 2 seconds. The menu is consisted of 10 main menus and total 29 sub-menus. So, if the menu is set according to circumstance and purpose of use, the radio can be utilized conveniently. The main menu has the list such as SCAN, ID ANI, Message, Pro. Message, Utility, Vehicle, Sound/Tone, RPT/Talk Ad, GPS, Software Ver.. And it is selected by the rotation of right knob. And execute it by pushing the knob.

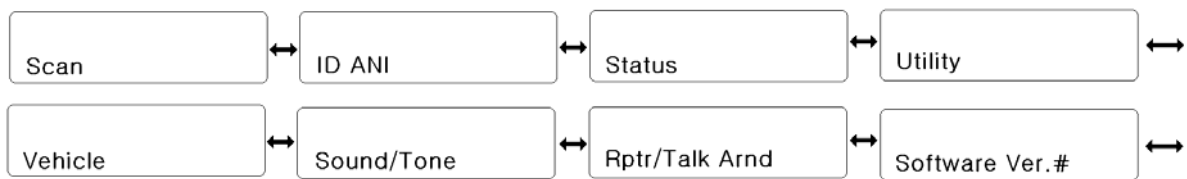

Main menu procedure

### 5.1 SCAN setting

It has 3 sub-menus (List, Priority Use, Priority List). The selection is performed by rotating the right knob and the activation is by pushing the knob.

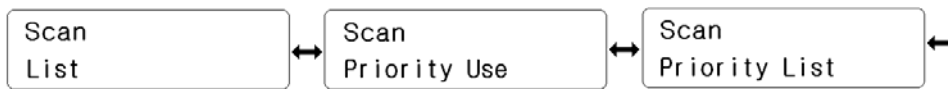

Scan sub-menu procedure

#### 1) List

- ① The channel list of group and whether the channel is in the scan or not are displayed as Yes or No. To move among channels, rotate the right knob.

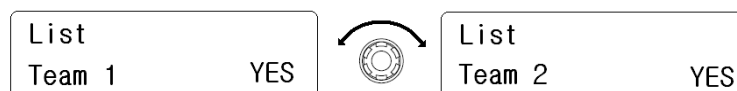

- ② Press the right knob to select Yes or No.

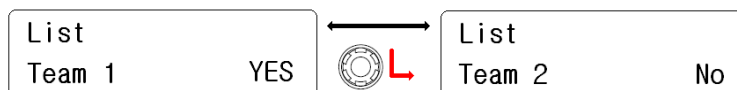

- ③ To go to upper rank, press the red button.

#### 2) Priority Use

- ① Rotate the right knob(Encoder) to change Yes/No.

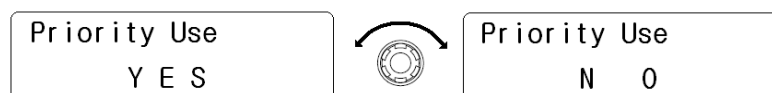

- ② Push the right knob(Encoder) to set, Back to upper menu.

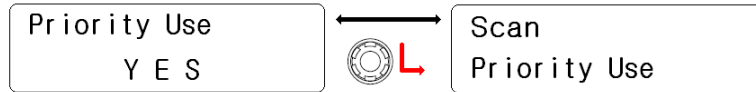

- ③ To go to upper menu, press the Red button.

### 3) Priority List

- ① The channel list in the group and whether the channel is set as priority or not are displayed as the sign of Yes or No. To change channel in the list, rotate the right knob.

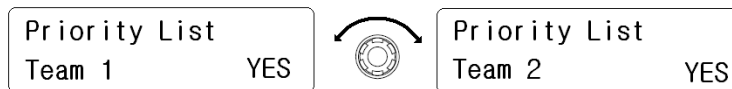

- ② Rotate the right knob(Encoder) to change Yes/No.

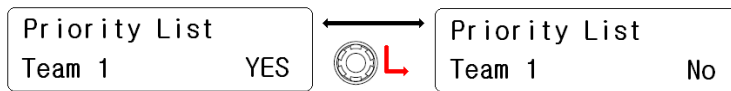

- ③ To go to upper menu, press the Red button.

## 5.2 ID ANI setting

It has two kinds of sub-menu as DTMF & Selcall. With the right knob, select one of them. And set it by pushing the knob.

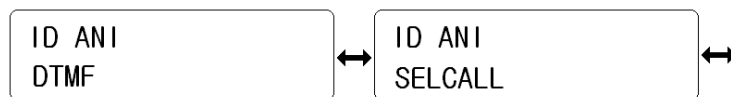

### 1) DTMF

- ① Rotate the right knob( Encoder) to select Yes or No.



- ② Press the knob to set, back to upper rank.

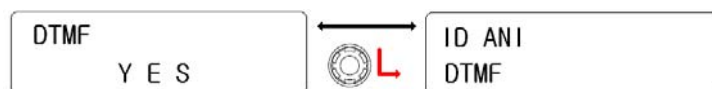

- ③ To move back to upper menu, press the red button.

## 2) SELCALL

- ① Rotate the right knob(Encoder) to select Yes or No.

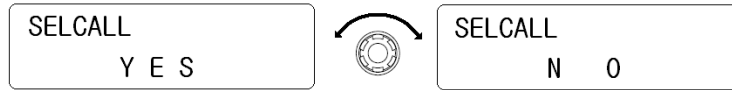

- ② Press the knob to set, back to upper rank.

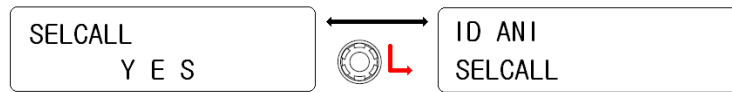

- ③ To move back to upper menu, press the red button.

## 5.3 Status setting

It is consisted of two kinds like “Send” or “Receive Check”. Pre-programmed Status is sent to the ID to be wanted receiving. And the receiving message can be checked. (Refer to menu table)

### 1) Send

- ① Display pre-programmed Status. Rotate the right knob(Encoder) to select a status to be sent, press the right knob(Encoder) to set.



- ② Rotate the right knob(Encoder) to select the ID which you wanted to send the status. And then press the right knob(encode) to set.

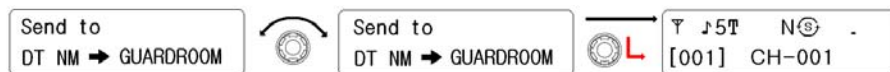

- ③ After Automatically getting out of the menu, the radio send the status, a receiver's ID and a sender's ID orderly.

### 2) Receive Check

- ① Rotate the right knob to select the received status for reading. And then press the right know to check the sender's ID.

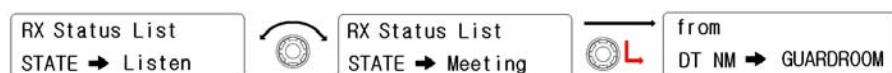

- ② To remove the received status, press the “S” button.



- ③ To erase all of the received status, press the “A” button and select Yes.



## 5.4 Utility setting

There are six sub-menus (RF Power, Lone Worker, Scramble, Lcd Contrast, Big Font, Password). Selection is done by the right knob(encoder) and press it to activate the function.

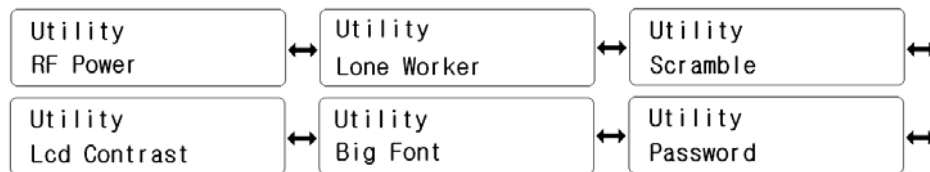

### 1) Lone Worker

- ① Rotate the right knob(Encode) to select. And press it to set.

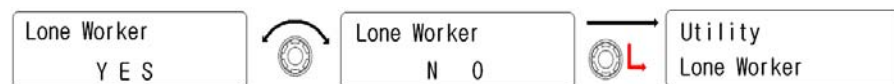

- ② To be back to upper menu, press the red button.

### 2) Scramble

- ① Rotate the right knob(Encode) to select. And press it to set.

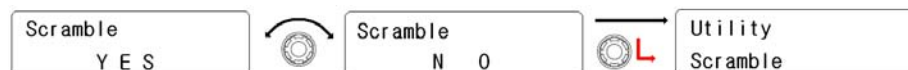

- ② To be back to upper menu, press the red button.

### 3) Lcd Contrast

- ① Rotate the right knob(Encode) to select one of 20 steps. And

then press it to set



- ② To be back to upper menu, press the red button.

#### 4) Big Fong

- ① Rotate the right knob(Encoder) to select one of them such as “Name, Number, Normal”. And then press it to set.

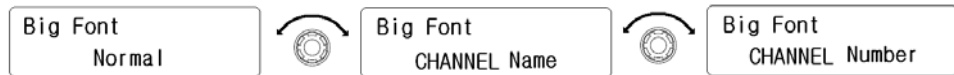

- ② To be back to upper menu, press the red button.

#### 5) Password

- ① When a Password is pre-programmed, "PASSWORD INPUT" is displayed on the LCD. And input the password. So, below No.2 step will be processed.

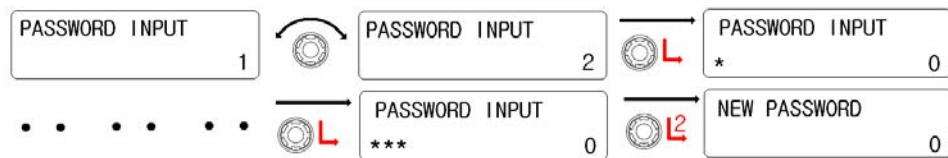

- ② When a password is not programmed, "NEW PASSWORD" is shown on the LCD. So, input new password.

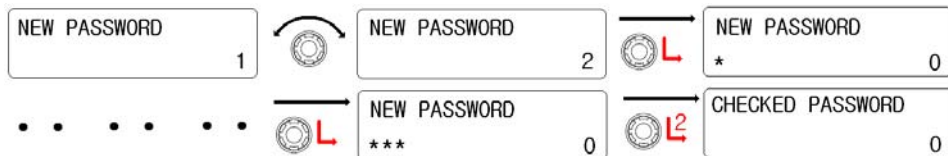

- ③ When "CHECKED PASSWORD" is shown, input new password one again.

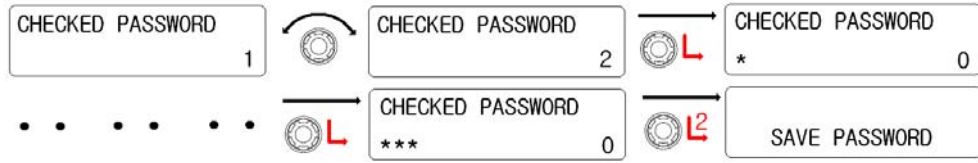

### 5.5 Vehicle setting

It has two kinds.(Horn Alert, Public AD). Rotate the right knob( Encoder ) to select one of them. And then press the right knob to activate it.

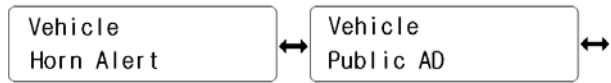

#### 1) Horn Alert

- ① Rotate the right knob( Encoder) to select “Yes”. And then press the right knob(Encoder) to activate it.

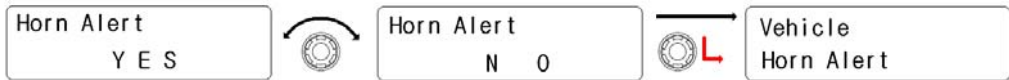

- ② To be back to upper menu, press the red button.

#### 2) Public AD

- ① Rotate the right knob( Encoder) to select “Yes”. And then press the right knob(Encoder) to activate it.

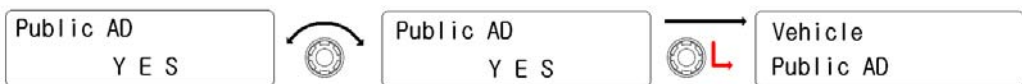

- ② To be back to upper menu, press the red button.

### 5.6 Sound/Tone

There are 7 kinds of sub-menu. (ID Sound, Comapnder, Key Tone, Speaker, Name Tone, MSG Tone, Call Tone) Selection is done by the right knob(Encoder). Activation is by pressing the right knob.

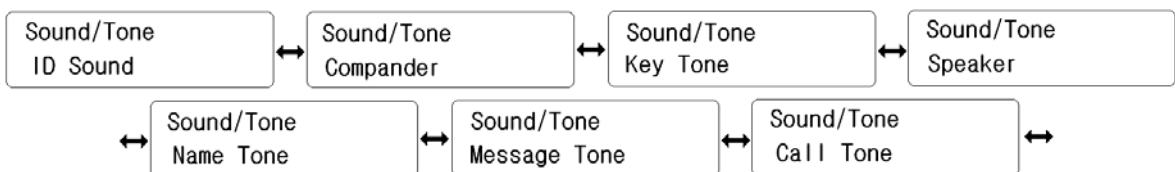

### 1) ID Sound

- ① Rotate the right knob( Encoder) to select “Yes”. And then press the right knob(Encoder) to activate it.

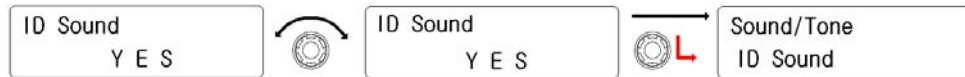

- ② To be back to upper menu, press the red button.

### 2) Comander

- ① Rotate the right knob( Encoder) to select “Yes”. And then press the right knob(Encoder) to activate it.

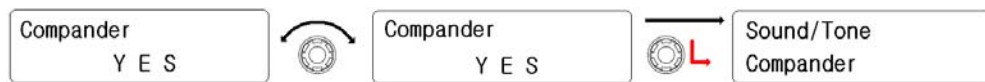

- ② To be back to upper menu, press the red button.

### 3) Key Tone

- ① Rotate the right knob( Encoder) to select “Yes”. And then press the right knob(Encoder) to activate it.



- ② To be back to upper menu, press the red button.

### 4) Speaker

- ① Rotate the right knob( Encoder) to select one of them(Front, Back, Both). And then press the right knob(Encoder) to activate it.

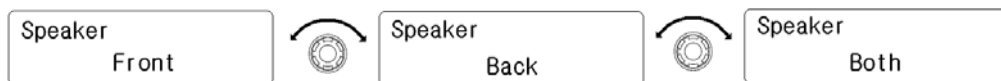

- ② To be back to upper menu, press the red button.

### 5) Name Tone

- ① Rotate the right knob(Encoder) to select preferred tone. And then press it to set.

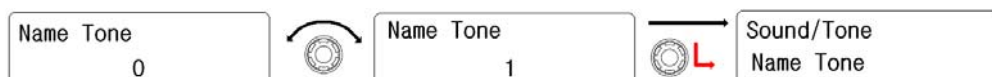

- ② To be back to upper menu, press the red button.

### 6) Message Tone

- ① Rotate the right knob(Encoder) to select preferred tone. And



then press it to set.

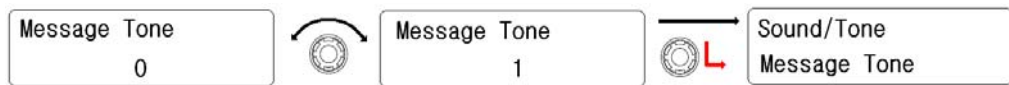

② To be back to upper menu, press the red button.

#### 7) Call Tone

① Rotate the right knob(Encoder) to select preferred tone. And then press it to set.

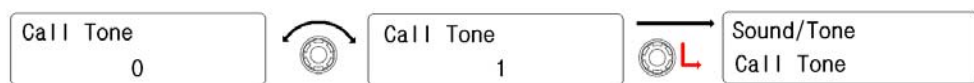

② To be back to upper menu, press the red button.

### 5.7 Repeater/Talk Around

It is consisted of 2 kinds sub-menus.(Repeater, Talk Around). Selection is done by the right knob(Encoder). Setting is by pressing the right knob.

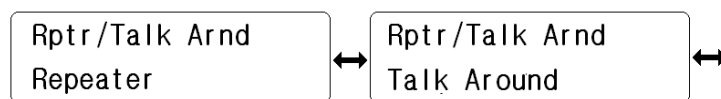

#### 1) Repeater

① Rotate the right knob( Encoder) to select "Yes". And then press the right knob(Encoder) to activate it.

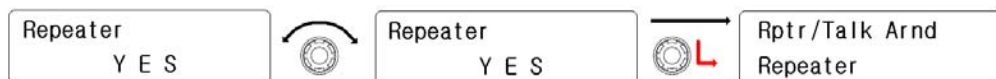

② To be back to upper menu, press the red button.

#### 2) Talk Around

① Rotate the right knob( Encoder) to select "Yes". And then press the right knob(Encoder) to activate it.

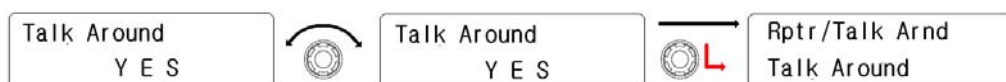

- ② To be back to upper menu, press the red button.

## 5.8 GPS setting

It is consisted of 4 kinds sub-menus.( Method, Interval, Sync Slots, Slot No). Selection is done by the right knob(Encoder). Setting is by pressing the right knob.

To send your location data, you must first install a GPS unit onto the transceiver. Press the key programmed as send the GPS data to transmit your location data. Ask your dealer for details.

## 5.9 Software version

It shows the version of Front & Main's firmware.

F/W Version  
Main Ver : ##.##

F/W Version  
Front Ver : ##.##

## 6. Terminal Description

### ACC(D-SUB 15 Pin Connector)

Pin NO	Pin Name	Description	Specification	I/O	Remake
1	DC+13.6V	DC Power Output	13.8±15%	O	
2	IGN	Ignition Signal Input	Power ON : ↑ 8V Power OFF : ↓ 6V	I	
3	EXT_SPK	Loudspeaker Output	4Ω, 4Watt	O	
4	AF_OUT	Audio Output	500mV	O	
5	EXT_MIC	Audio Input	5kΩ	I	
6	TXD/FCN1	TX Serial Data	3.3V TTL	O	
7	RXD/FCN2	RX Serial Data	3.3V TTL	I	
8	FCN3	Programmable	High Impedance	I/O	
9	FCN4	Programmable	High Impedance	I/O	
10	FCN5	Programmable	High Impedance	I/O	
11	FCN6	Programmable	High Impedance	I/O	
12	DC+5V	DC Power Supply	DC+5V Max 100mA	O	
13	HR1	Horn Alert Signal Output	Max 3A	O	
14	HR2	Horn Alert Signal Output	Max 3A	O	

		Output			
15	GND	Ground	Ground	-	

### Microphone Jack

Pin NO	Pin Name	Description	Specification	I/O	Remake
1	MBL	Backlight of Microphone	-	O	
2	DC+13.6V	DC Power Output	13.8±15%	O	
3	GND	Ground	Ground	-	
4	PTT/TXD0	PTT/PC Serial Data	3.3V TTL	I	
5	ME	MIC Ground	MIC Ground	-	
6	MIC	MIC Signal Input	600Ω	I	
7	HOOK/RXD0	HOOK/PC Serial Data	3.3V TTL	I	
8	DM	MIC Data Detection	High Impedance	I/O	

### Speaker Jack(3.5mm Phone Jack) 4Watt/4Ω

Pin NO	Pin Name	Description	Specification	I/O	Remake
1	SPO	External Speaker Output	4Watt/4Ω	O	
2	GND	Ground	Ground	O	

### DC Input Power Connector

Pin NO	Pin Name	Description	Specification	I/O	Remake
Red	DC+13.6V	DC Power Output	13.8±15%	I	
Black	GND	Ground	Ground	I	

### Antenna Connector

Impedance is 50

## 7. Specification

### 7.1 XM-1000 / XM-4200

#### General

Frequency Range	VHF: 136 ~ 174 MHz
Frequency Stability	±1.5PPM (-30 to +60°C)
Programmable Channels	256 Channels/32 Group
Channel Spacing	Dual Channel Spacing 12.5 KHz
Dimensions	103mm (H)×52mm (W)×32mm (D)
Weight	1.1Kg
Power Source	DC +13.8 ±15%
Current Drain (maximum)	Receive mode, rated audio out – 1A (Audio Max) Transmit mode – 11A Standby mode – 300mA

#### Receiver

Sensitivity	0.25uV 12 dB SINAD
Squelch Sensitivity	0.22uV 10dB SINAD
Selectivity	70dB
Spurious and Harmonic Rejection	75dB
FM Hum and Noise	40dB
Audio Output Power	4 Watt across an 8-ohm load
Audio Distortion	Less than 3% at rated output
Audio Response	+1, -3 dB from 6dB per octave de-emphasis Characteristic from 300 ~ 3000Hz
IF Frequencies	21.4MHz and 455KHz
Input Impedance	50 ohms

#### Transmitter

RF Power Output	50Watt
-----------------	--------

Spurious and Harmonic	70dB
FM Hum and Noise	40dB
Audio Distortion	3% maximum with 1KHz modulation
Audio Frequency Response	+1, -3dB from 6dB per octave pre-emphasis Characteristic from 300 ~ 3000Hz
Output Impedance	50ohms

## 7.2 XM-4000 / XM-4200

### General

Frequency Range	XM-4000A / XM-4200A : 400 ~ 475 MHz XM-4000B / XM-4200B : 450 ~ 520 MHz
Frequency Stability	±1.5PPM (-30 to +60°C)
Programmable Channels	256 Channels/32 Group
Channel Spacing	Dual Channel Spacing 12.5KHz
Dimensions	103mm (H)×52mm (W)×32mm (D)
Weight	1.,1 Kg
Power Source	DC +13.8 ±15%
Current Drain (maximum)	Receive mode, rated audio out – 1A(Audio Max) Transmit mode – 11A Standby mode - 300mA

### Receiver

Sensitivity	0.25uV 12 dB SINAD
Squelch Sensitivity	0.22uV 10dB SINAD
Selectivity	70dB
Spurious and Harmonic Rejection	75dB
FM Hum and Noise	40dB
Audio Output Power	1 Watt across an 16-ohm load
Audio Distortion	Less than 3% at rated output
Audio Response	+1, -3 dB from 6dB per octave de-emphasis Characteristic from 300 ~ 3000Hz
IF Frequencies	45.3MHz and 455KHz
Input Impedance	50 ohms

## Transmitter

RF Power Output	40Watt
Spurious and Harmonic	70dB
FM Hum and Noise	40dB
Audio Distortion	3% maximum with 1KHz modulation
Audio Frequency Response	+1, -3dB from 6dB per octave pre-emphasis Characteristic from 300 ~ 3000Hz
Output Impedance	50 ohms

 **Radio**