

# User Manual



---

## Key points :

---

This manual includes security measures and correct operating methods. For personal safety, please make sure to read this manual before using. Thank you!

- ◆ The machine adopts capacitive touch screen, you can just touch it by finger or click with capacitive pen for operation. (Never use the sharp objects to click the screen, or the touch screen may be damaged).
- ◆ Do not put the device at any high temperature, high humidity or dusty place.
- ◆ Do not drop or crash the device to prevent the violent impacting between the display and the capacitive touch screen. Or the customers have to take the consequence by themselves.
- ◆ Please choose the suitable volume and never make the too loud volume .If you feel uncomfortable please turn down the volume or stop to use the device soon.
- ◆ Please charge if you meet those situations as below:
  - A、 Low battery on the battery icon.
  - B、 The system turns off automatically.
  - C、 The keys do not work.
  - D、 “  ” is battery charging.



【Note】 :Don't use the different type charger or it may make the device burned . We assume no liability for the damage.

Please contact with our agent if you need the original adaptor.

- ◆ In the charging process, the device may be warning up a little (not too hot), this is normal phenomenon, but it won't effect the use.
- ◆ Do not disconnect the device while formatting, downloading or uploading, or it may make the error.
- ◆ Our company won't bear the duty for the loss of the memory erasing on account of the damage, repair or some other reason.  
Please operate the device according to the user manual rightly and backup the important data in time.
- ◆ Do not dismantle this device by yourself, and do not polish it with alcohol, dilution, or benzene.
- ◆ Do not use this device where electronics is forbidden, such as on the airplane.
- ◆ Do not use this device while walking and driving, avoiding traffic accident.
- ◆ USB is for transferring data but also for charging.
- ◆ Virus can damage this device. So please use proper computer antivirus and keep it updated.
- ◆ For any support needed for this device please contact the company or the authorized distributor. Any unauthorized dismantling of the device will make the warranty null and void.

We reserve the right to keep the change of the products, the specification and design is subject to change without notice!

## Device description

- ① Touch screen: You can click and drag in the touch screen.
- ★② Camera: You can take photos and videos etc..
- ③ POWER:
  - Turn on/off the device by long pressing this button.
    - When the power indicator is on, press the power key, the device will turn on. (It will take some time)
    - Press for 3 seconds when it is off. The system would indicate MID Option. Click “Power off” to shut it down. Press the return key to stay.
  - Press the Power key for a short time, you can shut /start the screen.
- ④  : Earphone jack: 3.5mm standard earphone jack.
- ⑤  : Mini USB, Mini-5pin connector.
- ⑥  : DC jack: Connect the power cable to charge to the device.
- ⑦ Volume+: Turn up the volume.
- ⑧ Volume-: Turn down the volume.
- ⑨ Micro SD/TF card: SD/TF card slot
- ⑩ RESET: Reset the device .

**【TIPS】:** 1. When the battery is low, it will power off automatically.

2. Shutdown illegally, when you restart, device would scan and repair the disk. The screen will stay at the progress bar for a long time .

3. Definition of “Press”:

Short Press: Press the button less than 2 seconds.

Long Press: Press the button more than 3 seconds.

**If there is no special explanation, “Press” means Short Press.**

**【Note】:** The pictures in the user manual are just for your reference, about the “★” item, please according to the real products.

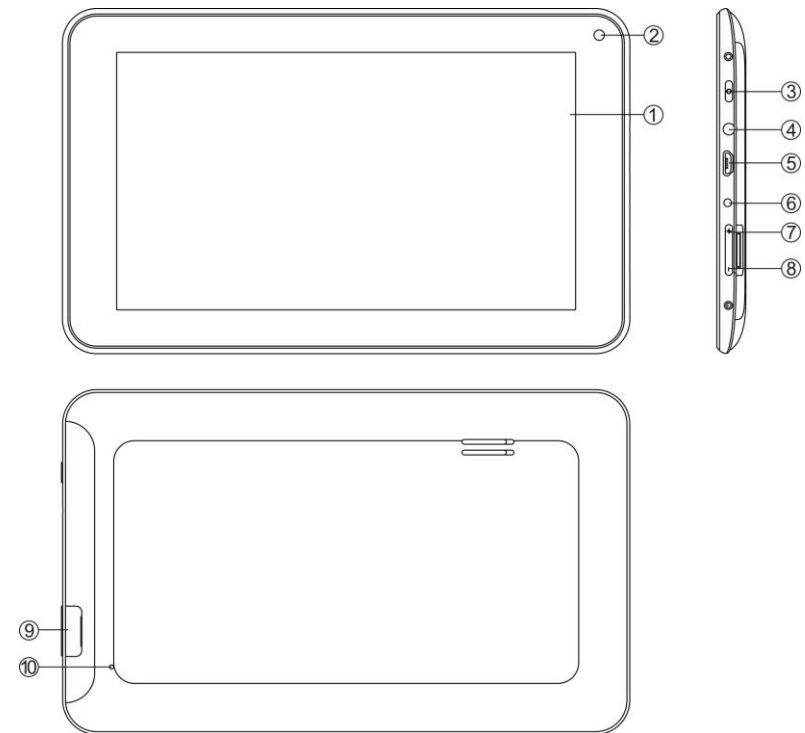

## Setting up for the first time

### ◆ Charging your device:

For first-time use, you need to charge the device for ten hours.

After that you can recharge the device as needed.

Connect the DC-in jack to your device and plug the AC adapter into any AC outlet.

#### 【TIPS】:

1. This device adopts built-in polymer battery. Only the specified charger should be used.
2. It is normal for the device's surface to become warm during charging or long periods of use. All devices are factory tested before release.
3. If you do not use this set for a long time, please charge/release it once one month to avoid deep discharge. The damage caused by battery over-consuming is not included in the warranty.

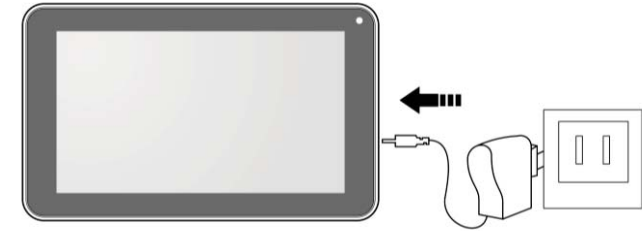

### ◆ Connecting to a PC:

- You can connect with PC by USB cable attached with the device.

You can transfer your personal data to the PC.

- Connect the PC and the device, it will change to the USB mode, in this state, realize the files transfer function between the PC and the device.

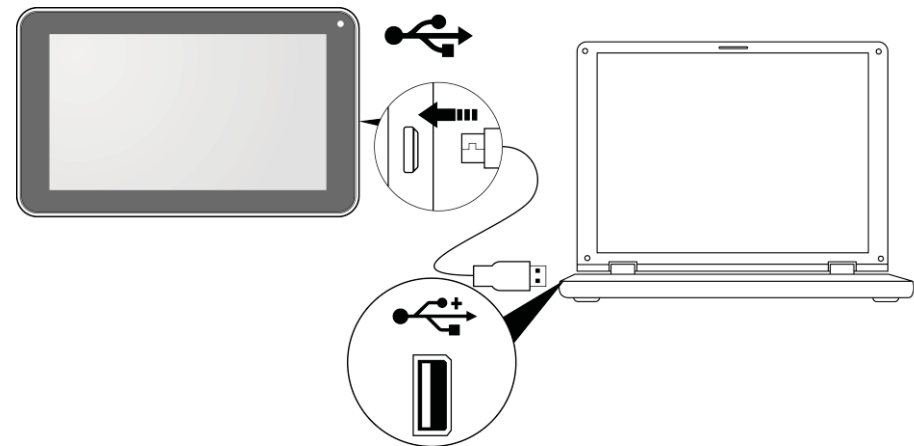

**◆ Connecting a USB device:**

- USB devices are supported, such as a keyboard, through the USB port.
- View media files on USB storage with installed photo, music or video applications.

**【Caution】** : Before removing this USB storage, make sure your device is not accessing data from the USB storage.

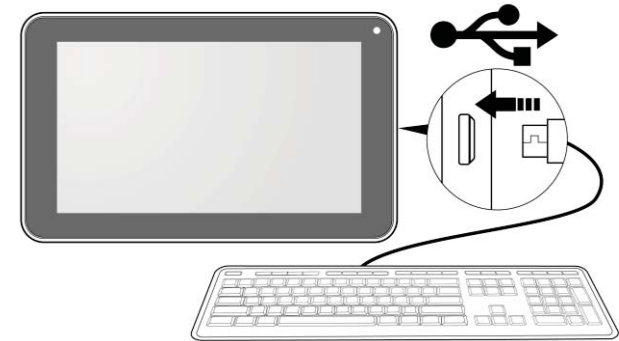
**◆ Inserting the MicroSD/TF card :**

You may install a Micro SD/TF card to expand your device's storage space.

1. Turn off the device by pressing and holding the power button.
2. Insert the Micro SD/TF card as shown.

**【Note】** : Ensure that the Micro SD/TF card is inserted all the way into the card slot.

**【Caution】** : Before removing this card, make sure your device is not accessing data on the card.

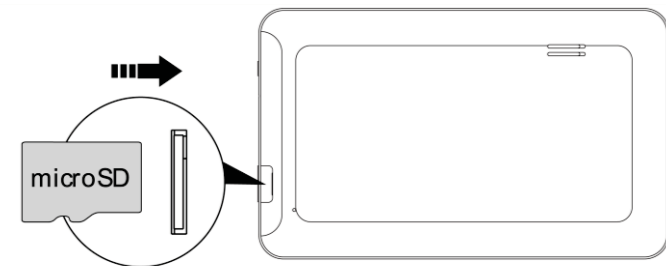

◆ **Resetting the device:**

You may have to perform a reset if your device fails to respond when buttons are pressed or the screen is tapped.

If your device does not respond to screen input.

To reset your device use a small thin object (such as a paperclip) to press the recessed reset button.

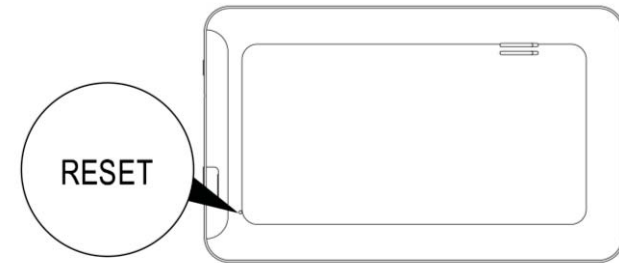

◆ **Connecting to the Network:**

1. Wi-Fi wireless setup:

Enter the setting interface, and turn on the Wi-Fi item.

The device will automatically search any accessible nearby wireless networks.

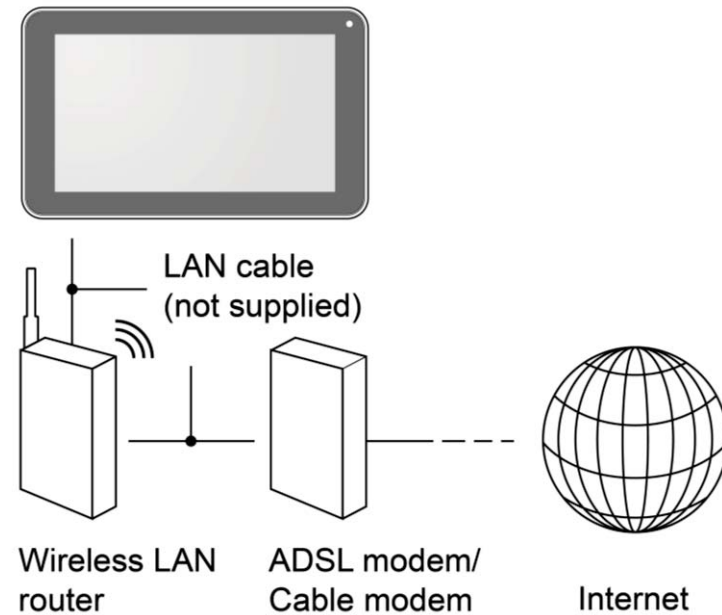

## Commonly used settings

Press the setup icon to enter the setting.

◆ **Wi-Fi:** Click ON or OFF to open or close Wi-Fi.

When open Wi-Fi , the system will scan the wifi signal around automatically.

Meanwhile, users could add network manually as well.

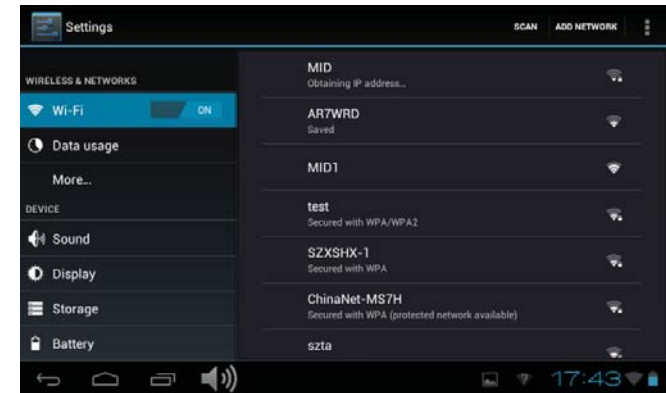

**More...:**

**1. VPN:** The user can preset the 3G operators information.

**2. Portable hotspot:** You must connect the cable to network (by RJ45 connector) then you can enter the option to open or close the “Portable Wi-Fi hotspot”, you can also take this device as a Wi-Fi Router.

**3. Mobile networks:**

**Connect a USB 3G Dongle setting :** To insert a USB 3G dongle, the device will connect the Internet automatically. A 3G icon will be displayed on the screen. (Please make sure the 3G SIM card is matching with the 3G dongle well)

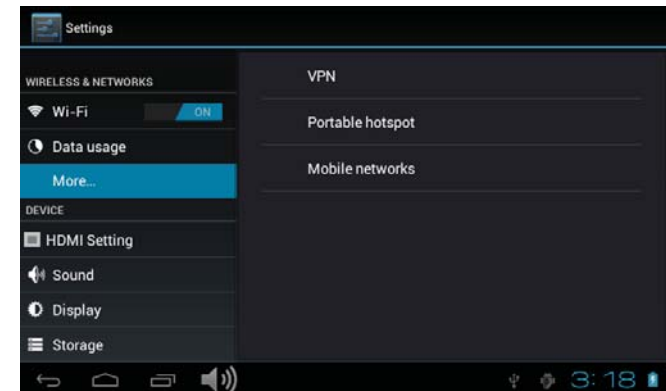

**【Remark1】** : After turning on “Portable Wi-Fi hotspot” , Wi-Fi will close automatically.

**【Remark2】** : When you use 3G to connect internet , you must shut off Wi-Fi first.

◆ **Display:**

**Rotate screen setting:**

Enter setting menu : Display → Auto-rotate screen , you can open /close the screen autorotation function.

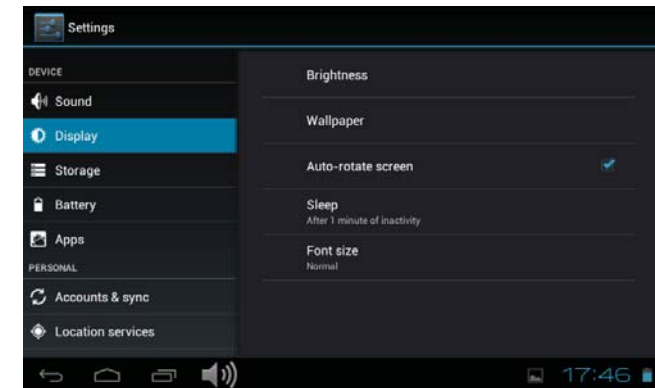

◆ **Language & input:**

1. Language: Users can choose OSD Languages.
2. KEYBOARD & INPUT METHODS: select language method.  
【Remark】 : In this state ,users can switch the input method .

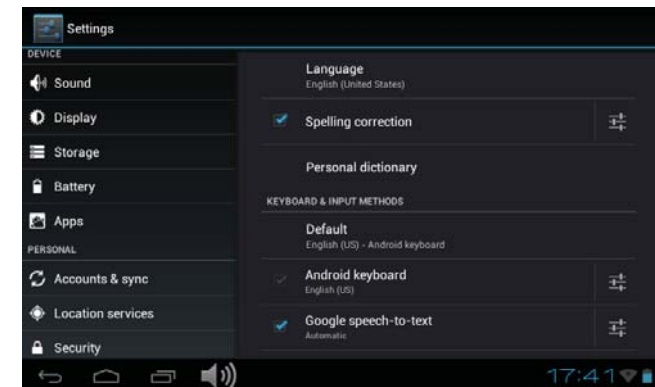

- ◆ **Date & time:** when the internet is connected , turn on “Automatic date & time” , the device can obtain the real date and time from the internet.

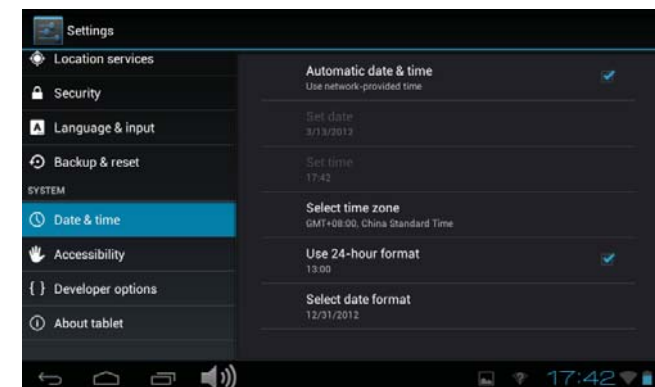



## Trouble shooting

---

- **Can not power on:**

- Connect the power cable to charge to the device, after a while and then check again.
- If it still can not power on, please contact with our distributor or service centre.

- **Serious noise:**

- Check if the music file is damaged.
- If the music files are damaged, it may cause serious noise and jumping sound.

- **Can not download or copy:**

- Check if it is connecting correctly between the device and PC.
- Check the spare space of the memory.
- Check the USB cable.

- **USB connect is fail:**

- Make sure that the USB device is securely connected to the USB jack.
- Check if the USB device or a cable is damaged.
- If the USB device is connected via a USB hub, connect the USB device directly to the device.

- **Cannot connect the device to the wireless LAN router:**

- Check if the wireless LAN router is on.
- Depending on the surrounding environment, such as the wall material, radio wave receiving condition, or obstacles between the device and the wireless LAN router, the communication distance may be shortened. Move the device and the wireless LAN router closer to each other.
- Devices that use a 2.4GHz frequency band, such as a microwave, Bluetooth, or digital cordless device, may interrupt the communication. Move the device away from such devices, or turn off such devices.

**Product Specification**

OS	Google Android 4.2
CPU	Dual Core 1.0G
System RAM	1G DDRIII
Memory	8GB NAND Flash
LCD	7" 800*480 LED-backlit panel
Touch Panel	Multi-point Capacitive touch screen
WIFI	802.11 b/g/n
Ethernet LAN	Yes (USB dongle )
3G	3G USB dongle
Gravity	3D gravity sensor
Music format	MP3,WMA,FLAC,AAC,OGG,WAV,APE
Video format	VP8,RMVB,RM,MOV,MPG,MP4,AVI,3GP,DAT, FLV,MKV,...etc.
Picture format	JPEG, BMP, GIF,PNG

Specifications are for reference, to prevail in kind

Remark : 3G USB dongle and 3G SIM card are not included in the package of this Tablet.

## **FCC ID: LU7-TS100**

This device complies with Part 15 of the FCC Rules. Operation is subject to the following two conditions: (1) this device may not cause harmful interference, and (2) this device must accept any interference received, including interference that may cause undesired operation.

Changes or modifications not expressly approved by the party responsible for compliance could void the user's authority to operate the equipment.

NOTE: This equipment has been tested and found to comply with the limits for a Class B digital device, pursuant to Part 15 of the FCC Rules. These limits are designed to provide reasonable protection against harmful interference in a residential installation. This equipment generates, uses and can radiate radio frequency energy and, if not installed and used in accordance with the instructions, may cause harmful interference to radio communications. However, there is no guarantee that interference will not occur in a particular installation. If this equipment does cause harmful interference to radio or television reception, which can be determined by turning the equipment off and on, the user is encouraged to try to correct the interference by one or more of the following measures:

- Reorient or relocate the receiving antenna.
- Increase the separation between the equipment and receiver.
- Connect the equipment into an outlet on a circuit different from that to which the receiver is connected.
- Consult the dealer or an experienced radio/TV technician for help.