

YONGNUO
DIGITAL

SPEEDLITE TRANSMITTER

YN-E3-RT



User Manual
用户手册

Contents

Introduction	1
Nomenclature.	2-4
Preparation Before Use	5-6
Wireless Flash Shooting.	7
Wireless Settings	8-9
ETTL:Fully Automatic Wireless Flash Shooting	10-14
M: Wireless Multiple Flash Shooting with Manual Flash Output.	15-16
MULI: Stroboscopic Flash	17
Gr: Shooting with a Different Flash Mode for Each Group.	18-19
Remote Release from a Slave Unit/Linked Shooting	20-21
Transmitter Control from Camera's Menu Screen	22-23
C.Fn:Transmitter Custom Function Settings.	24-27
Reference	28-29
Troubleshooting Guide	30-31
Specifications.	32-33

Read this instruction manual while also referring to the instruction manuals of your camera and Speedlite.

Before using the transmitter, read this instruction manual and the instruction manuals of your camera and Speedlite to familiarize yourself with the operations.

Introduction

The YONGNUO Speedlite Transmitter YN-E3-RT is a transmitter for wireless flash shooting. It can control up to 5 groups (15 units) of Speedlites that have a wireless multiple flash shooting function using radio transmission. The transmitter also has dust and water resistance equivalent to EOS-1D series cameras.

- **Two-way 2.4G radio communication, fully compatible with ST-E3-RT/600EX-RT**

- 15 Physical Channels, 1 Auto Channel, Up to 10,000 customizable photographer ID

- **Transmission Range: 100M**

- Multi YN-E3-RT can share slave flashes

- Display group/charge status of slave flashes

- **Firmware can be upgraded via USB**

- High resolution Dot-Matrix LCD, Backlight for LCD/keys

- Fast lock mechanism

- **Built-in AF assist beam emitter**, buzzer

- Remote shutter release, Linked Shot (Need extra shutter cable for cameras released before 2012)

- **Flash Mode: E TTL/M/Multi/GR 4 flash modes**

- A/B/C/D/E 5 groups

- Supports 1st Curtain, **2nd Curtain (Only in M mode)**, High speed Sync

- Supports E TTL Ratio, Flash Exposure Compensation, Flash Exposure Lock, Flash Exposure Bracket, Modeling Flash

- 9 Custom Functions

- Settings saved automatically

Nomenclature

※The protective flim can be torn out.

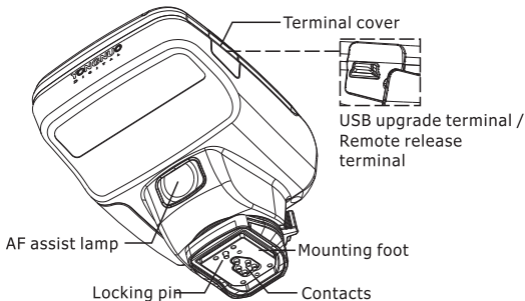
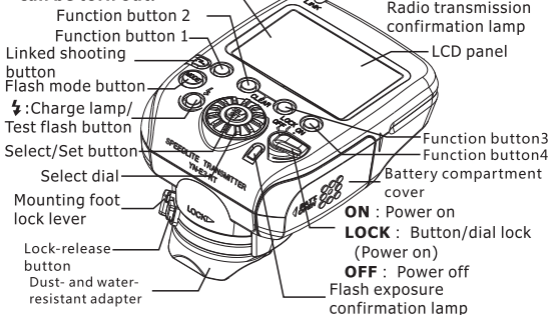

Nomenclature

E-TTL (II) Autoflash

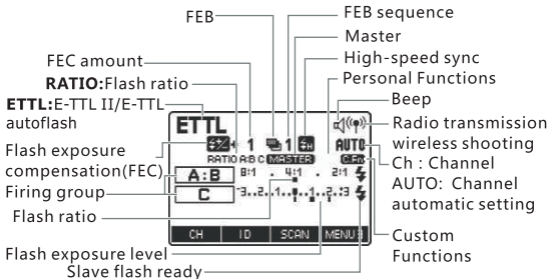

Manual flash

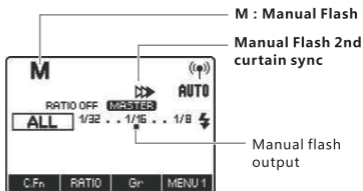

- The display will show only the settings currently applied.
- The functions displayed above function buttons 1 to 4, change according to the setting's status.
- When a button or dial is operated, the LCD panel illuminates.

Nomenclature

Multi(stroboscopic) flash

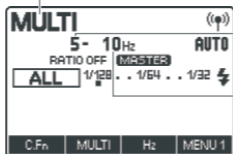

MULTI:

Multi flash

Number of flashes

Flash frequency

Group firing

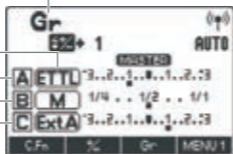

Gr : Group flash

Flash mode

Firing group

Linked shooting

LINKED SHOT:
Linked shooting

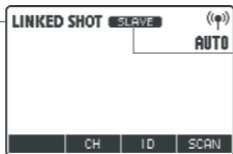

SLAVE

SLAVE

MASTER

MASTER

Preparation Before Use

1. Install two AA/LR6 batteries.

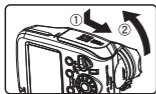

1. Open the cover: Slide the cover down as shown and open the battery compartment cover.

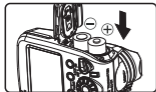

2. Install two AA batteries: Install two AA batteries according to the + and - marks, rechargeable batteries of 1.2V can be used.



3. Close the battery: Close the battery Compartment cover and slide it up.

- **Remove the batteries when the product is not used for long time. Please replace the both two batteries at the same time.**
- **When  is displayed, replace the batteries with new ones.**

2. Attaching and Detaching the Transmitter

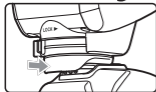

1. Attach the transmitter.

Slip the transmitter's mounting foot all the way into the camera's hot shoe.

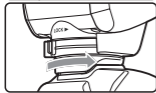

2. Secure the transmitter.

On the mounting foot, slide the lock lever to the right. When the lock lever clicks in place, it will be locked.



3. Detach the transmitter.

While pressing the lock-release button, slide the lock lever to the left and detach the transmitter.

- **Before attaching or detaching the transmitter, be sure to turn the transmitter power off.**

Preparation Before Use

3. Turning on the Power: Set the power switch to <ON>.

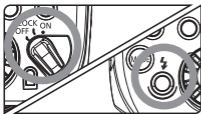

- The LCD panel illuminates.
- The charge lamp lights when the wireless shooting (slave) is ready.
- During wireless shooting, press the transmitter's charge lamp (test flash button) to fire a test flash.

About Auto Power Off

To save battery power, the power will turn off automatically after 5 min. of idle use. To turn on the transmitter again, press the camera's shutter button halfway, or press the test flash button (charge lamp).

About the Lock Function

By setting the power switch to <LOCK>, you can disable flash's button and dial operations. Use this to prevent the transmitter function settings from being accidentally changed after you set them.

If you operate a button or dial, <LOCKED> is displayed on the LCD panel .

About the LCD Panel Illumination

When a button or dial is operated, the LCD panel illuminates in green for 12 sec. When setting a function, the illumination continues until the setting is complete.

- **The transmitter settings are stored even when the power is turned off.**
- **You can fire a test flash even when the power switch is set to the <LOCK> position. Also, when a button or dial is operated, the LCD panel illuminates.**

Wireless Flash Shooting

Using a transmitter and a Speedlite compatible with radio transmission wireless shooting makes it easy to shoot with advanced wireless multiple flash lighting, in the same way as normal **E-TTL II/E-TTL** autoflash shooting.

The system is designed so that the settings of the transmitter attached to the camera (master) are automatically reflected on the Speedlite that is wirelessly controlled (slave). Therefore, you do not need to operate the slave unit while shooting.

The basic relative positions and operating range are as shown in the figure. You can then perform wireless **E-TTL II/E-TTL** autoflash shooting just by setting the master unit to **<ETTL>**.

Positioning and Operation Range

(Example of wireless flash shooting)

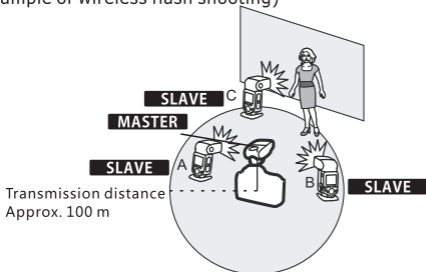

- Before shooting, perform a test flash (p.10) and test shooting.
- The transmission distance may be shorter depending on the conditions such as the positioning of slave units, the surrounding environment and weather conditions.

Wireless Settings

To avoid interference, Set the same channel and ID for both the master unit and slave unit.



Set a flash that is compatible with radio transmission wireless flash shooting as the slave unit. **For the slave unit settings, see the flash's instruction manual.**

Setting the Master Unit Transmission Channel / Wireless Radio ID.



1. Display < MENU3 >.

• Press function button 4 to display < MENU3 >.

2. Set a channel.

• Press function button 1 < CH >.
• Turn <  > to select "AUTO" or a channel from Ch. 1 to 15, and press the <  > button.

3. Set a wireless radio ID.

• Press function button 2 < ID >.
• Turn <  > to select the position(digit) or number to set, and press the <  > button.
• Press function button 4 <  > to return to the shooting-ready state.

➢ When transmission between the master unit and slave unit is established, the < LINK > lamp is lit in green. (Refer to page 26)

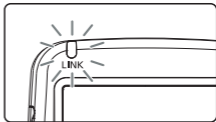
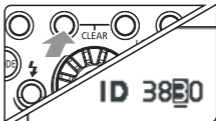
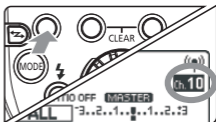

Wireless Settings

• Scanning the Master Unit Transmission Channels to Set

You can scan the radio reception status and set the master unit's transmission channel automatically or manually. When the channel is set to "AUTO", the channel with the best reception signal is automatically set. When setting the channel manually, you can set the transmission channel again while referring to the scan results.

Scanning while "AUTO" is set

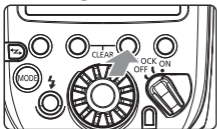

Run the scan.

- Press function button 4 to display < **MENU3** >.
- Press function button 3 < **SCAN** >.
- The channel is reset to one with a good reception signal.

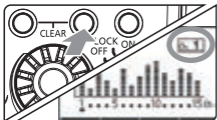

Scanning while Ch. 1 to 15 is set



1.Run the scan.

- Press function button 4 to display < **MENU3** >.
- Press function button 3 < **SCAN** >.
- The radio reception status is displayed in a graph.
- The higher the peak of the channel in the graph, the better the radio reception signal.

2.Set a channel.

- Turn <  > to select a channel from Ch1 to 15.
- Press the <  > button to set the channel and return to the shooting ready state.

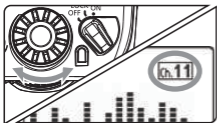

ETTL:Fully Automatic Wireless Flash Shooting

1. Set the flash as the slave unit A, B or C. The flash will not fire if it is set to D or E.

2. Set the same channel and ID of the master unit and slave unit .(p.8)

3. Position the camera and the flash.(p.7)

4. Press the <MODE> button on the master unit and set the flash mode to <ETTL>.

- The slave unit is set automatically to <ETTL> during shooting via the control from the master unit.

5. Check the transmission status and that the flash is ready.

- Check that the <LINK> lamp is lit in green.

- Check that the <⚡> slave flash-ready icon is lit on the master unit's LCD panel.

- When the recycling of all the flash units is completed, the master unit's charge lamp lights.

6. Check the operation.

- Press the master unit's test flash button (charge lamp). The slave unit flashes.

7. Take the picture.

- If a standard flash exposure was obtained, the flash exposure confirmation lamp lights for 3 sec.

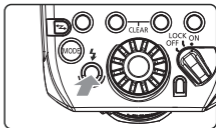
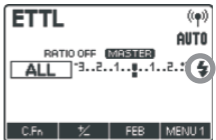
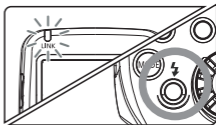
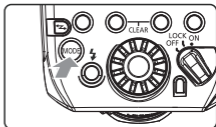
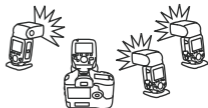

ETTL:Fully Automatic Wireless Flash Shooting

Support 1/3-stop increments to set FEC/FEB within ± 3 .

FEC (Flash Exposure Compensation)

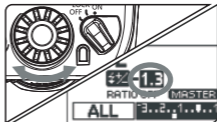
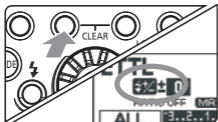

1. Press function button 4 to display **< MENU1 >**. Press function button 2 **< +/- >**. **< +/- >** is displayed and the FEC amount is highlighted.
2. Turn **< [wheel] >** to set the flash exposure compensation amount, and press **< [wheel] >**. The FEC amount is set.
 - **To cancel FEC, return the amount to "±0".**

FEB (Flash Exposure Bracketing)

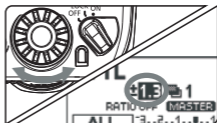
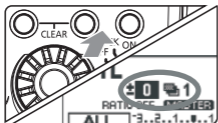

1. Press function button 4 to display **< MENU1 >**. Press function button 3 **< FEB >**. **< [FEB icon] >** is displayed and the FEB level display is highlighted.
2. Turn **< [wheel] >** to set the FEB level, and press **< [wheel] >**. The FEB level is set.
 - **When used together with flash exposure compensation, FEB shooting is performed based on the flash exposure compensation amount.**

ETTL:Fully Automatic Wireless Flash Shooting ■

High-speed Sync

With the high-speed sync function, the flash can synchronize with all shutter speeds. This is convenient when you want to use aperture-priority AE for fill-flash portraits of a subject.

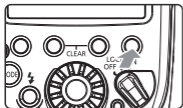

1.Display < MENU4 >.

Press function button 4 to display < MENU4 >.



2.Display < ⚡H >.

- Press function button 2 < SYNC > to display < ⚡H >.
- Check that < ⚡H > is lit in the viewfinder.

FEL : FE Lock

FE (Flash Exposure) lock locks the correct flash exposure setting for any part of the scene.

Perform FE lock by operating the camera. For the operations, see the camera and flash's instruction manual.

About Master Units

You can use two or more master units (master units + slave units =maximum of 16 units). By preparing multiple cameras with master units attached, you can shoot by changing cameras while keeping the same lighting (slave units).

Note that when using two or more master units, the color of the <LINK> lamp varies depending on the order in which the power was turned on. The first master (main master) is green and the second and subsequent masters (sub-masters) are orange.

ETTL: Wireless Multiple Flash Shooting with Flash Ratio

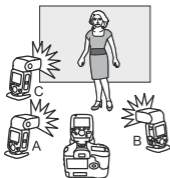

The exposure is controlled automatically so that the total flash output of firing groups results in the standard exposure.

1. Set the firing group of the slave units.

- Operate and set the slave units one by one.

2. Press the master unit's function button 4 to display



< **MENU2** >.

3. Press function button 2

< **RATIO** > and set to < **A:B** > or < **A:BC** >.

4. Set the flash ratio. Press function button 3

- Press function button 3 < **A:B** > or < **C** >.

- Turn <  > to set the flash ratio or the flash exposure, and press the <  > button.

- Press function button 4 <  > to return to the shooting-ready state.

5. Take the picture.

The slave units flash at the set flash ratio.

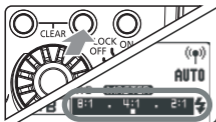
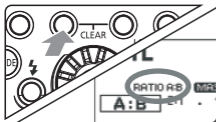
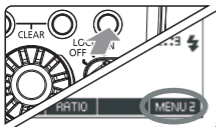

ETTL: Wireless Multiple Flash Shooting with Flash Ratio

Slave Group Control

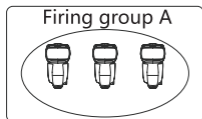

If you need more flash output or wish to perform more sophisticated lighting, you can increase the number of slave units.

Simply set an additional slave unit to the firing group (A, B or C) whose flash output you want to increase. You can increase the number of slave units up to 15 units in total.

For example, if you set a firing group with three slave units to <A>, the three units are controlled as a single firing group A with a large flash output.

- To fire the three firing groups A, B and C at the same time, set <A:B:C>. With the < A:B > setting, firing group C does not fire.
- If you shoot with firing group C pointing directly toward the main subject, overexposure may result.
- The flash ratio of 8:1 to 1:1 to 1:8 is equivalent to 3:1 to 1:1 to 1:3 (1/2-stop increments) when converted to number of stops.
- The details of the flash ratio settings are as follows.

8:1 ● 4:1 ● 2:1 ● 1:1 ● 1:2 ● 1:4 ● 1:8
 | | | | | | |
5.6:1 2.8:1 1.4:1 1:1.4 1:2.8 1:5.6

Modeling Flash

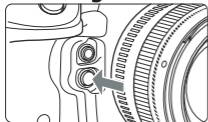

Modeling Flash from a Master Unit

- Press the depth-of-field preview button on the camera.
- The flash fires continuously for 1 sec.

M: Wireless Multiple Flash Shooting with Manual Flash Output

This describes wireless (multiple flash) shooting using manual flash. You can shoot with a different flash output setting for each slave unit (firing group). Set all parameters on the master unit.

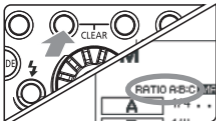

1. Set the flash mode to <M>.

2. Set the number of firing groups.

- While <MENU1> is displayed, press function button 2 <RATIO> and set the groups to fire.

- The setting changes as follows each time you press the button:

ALL (<RATIO OFF>) →

A/B (<RATIO A:B>) →

A/B/C (<RATIO A:B:C>)

3. Select a firing group.

- Press function button 3 <Gr> ,

- turn <⊙> and select the group for which you want to set the flash output.

4. Set the flash output.

- Press function button 3 <*/> .

- Turn <⊙> to set the flash output, and press the <⊙> button.

- Repeat steps 3 and 4 to set the flash output of all groups.

5. Take the picture.

- Each group fires at the set flash output.

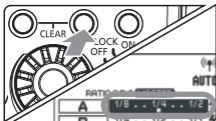
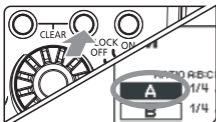

- When ALL <RATIO OFF> is set, set A, B or C as the firing group for the slave units. The flash will not fire if it is set to D or E.

- To fire multiple slave units with the same flash output, select ALL <RATIO OFF> in step 2.