

**YOUNG CHANG**

*Music Systems*

**KC10C**

**USER'S  
MANUAL**

**HDC** YOUNG CHANG  
MUSIC

**FCC Warning:**

This equipment has been tested and found to comply with the limits for a Class B digital device, pursuant to part 15 of the FCC Rules. These limits are designed to provide reasonable protection against harmful interference in a residential installation. This equipment generates, uses and can radiate radio frequency energy and, if not installed and used in accordance with the instructions, may cause harmful interference to radio communications. However, there is no guarantee that interference will not occur in a particular installation. If this equipment does cause harmful interference to radio or television reception, which can be determined by turning the equipment off and on, the user is encouraged to try to correct the interference by one or more of the following measures:

- o Reorient or relocate the receiving antenna.
- o Increase the separation between the equipment and receiver.
- o Connect the equipment into an outlet on a circuit different from that to which the receiver is connected.
- o Consult the dealer or an experienced radio/TV technician for help.

Caution: Any changes or modifications to this device not explicitly approved by manufacturer could void your authority to operate this equipment.

This device complies with part 15 of the FCC Rules. Operation is subject to the following two conditions:

(1) This device may not cause harmful interference, and (2) this device must accept any interference received, including interference that may cause undesired operation.

The device has been evaluated to meet general RF exposure requirement. The device can be used in portable exposure condition without restriction.



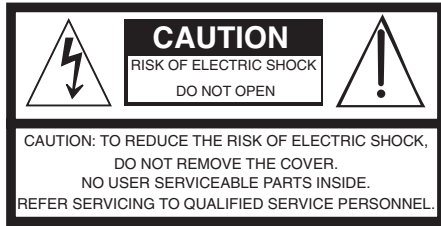

The lightning flash with the arrowhead symbol, within an equilateral triangle is intended to alert the user to the presence of uninsulated "dangerous voltage" within the product's enclosure that may be of sufficient magnitude to constitute a risk of electric shock to persons.



The exclamation point within an equilateral triangle is intended to alert the user to the presence of important operating and maintenance (servicing) instructions in the literature accompanying the product.

## IMPORTANT SAFETY & INSTALLATION INSTRUCTIONS

### INSTRUCTIONS PERTAINING TO THE RISK OF FIRE ELECTRIC SHOCK , OR INJURY TO PERSONS

**WARNING:** When using electric products, basic precautions should always be followed, including the following:

1. Read all the Safety and Installation Instructions and Explanation of Graphic Symbols before using the product.
2. This product must be grounded. If it should malfunction or break down, grounding provides a path of least resistance for electric current to reduce the risk of electric shock. This product is equipped with a power supply cord having an equipment-grounding conductor and a grounding plug. The plug must be plugged into an appropriate outlet which is properly installed and grounded in accordance with all local codes and ordinances.  
**DANGER:** Improper connection of the equipment-grounding conductor can result in a risk of electric shock. Do not modify the plug provided with the product – if it will not fit the outlet, have a proper outlet installed by a qualified electrician. Do not use an adaptor which defeats the function of the equipment-grounding conductor. If you are in doubt as to whether the product is properly grounded, check with a qualified serviceman or electrician.
3. Do not use this product near water  $\text{D}$  for example, near a bathtub, washbowl, kitchen sink, in a wet basement, or near a swimming pool, or the like.
4. This product should only be used with a stand or cart that is recommended by the manufacturer.
5. This product, either alone or in combination with an amplifier and speakers or headphones, may be capable of producing sound levels that could cause permanent hearing loss. Do not operate for a long period of time at a high volume level or a level that is uncomfortable. If you experience any hearing loss or ringing in the ears, you should consult an audiologist.
6. This product should be located so that its location or position does not interfere with its proper ventilation.
7. The product should be located away from heat sources such as radiators, heat registers, or other products that produce heat.
8. The product should be connected to a power supply only of the type described in the operating instructions or as marked on the product.
9. This product may be equipped with a polarized line plug (one blade wider than the other). This is a safety feature. If you are unable to insert the plug into the outlet, contact an electrician to replace your obsolete outlet. Do not defeat the safety purpose of the plug.
10. The power supply cord of the product should be unplugged from the outlet when left unused for a long period of time. When unplugging the power supply cord, do not pull on the cord, but grasp it by the plug.
11. Care should be taken so that objects do not fall and liquids are not spilled into the enclosure through openings.
12. The product should be serviced by qualified service personnel when:
  - A. The power supply cord or the plug has been damaged;
  - B. Objects have fallen, or liquid has been spilled into the product;
  - C. The product has been exposed to rain;
  - D. The product does not appear to be operating normally or exhibits a marked change in performance;
  - E. The product has been dropped, or the enclosure damaged.
13. Do not attempt to service the product beyond that described in the user maintenance instructions. All other servicing should be referred to qualified service personnel.
14. **WARNING:** Do not place objects on the product's power supply cord, or place the product in a position where anyone could trip over, walk on, or roll anything over cords of any type. Do not allow the product to rest on or be installed over cords of any type. Improper installations of this type create the possibility of a fire hazard and/or personal injury.

## RADIO AND TELEVISION INTERFERENCE

**WARNING:** Changes or modifications to the instrument not expressly approved by Young Chang could void your authority to operate the instrument.

**IMPORTANT:** When connecting this product to accessories and/or other equipment use only high quality shielded cables.

**NOTE:** This instrument has been tested and found to comply with the limits for a Class B digital device, pursuant to Part 15 of the FCC Rules. These limits are designed to provide reasonable protection against harmful interference in a residential installation. This instrument generates, uses, and can radiate radio frequency energy and, if not installed and used in accordance with the instructions, may cause harmful interference to radio communications. However, there is no guarantee that interference will not occur in a particular installation. If this instrument does cause harmful interference to radio or television reception, which can be determined by turning the instrument off and on, the user is encouraged to try to correct the interference by one or more of the following measures:

- Reorient or relocate the receiving antenna.
- Increase the separation between the instrument and the receiver.
- Connect the instrument into an outlet on a circuit other than the one to which the receiver is connected.
- If necessary consult your dealer or an experienced radio/television technician for additional suggestions.

The normal function of this product may be disturbed by strong electro magnetic interference. If so, simply reset the product to resume normal operation by following the instruction manual. In case the function could not resume, please use the product in another location.

### NOTICE

This apparatus does not exceed the Class B limits for radio noise emissions from digital apparatus set out in the Radio Interference Regulations of the Canadian Department of Communications.

### AVIS

Le présent appareil numérique n'émet pas de bruits radioélectriques dépassant les limites applicables aux appareils numériques de la class B prescrites dans le Règlement sur le brouillage radioélectrique édicté par le ministère des Communications du Canada.

## SAVE THESE INSTRUCTIONS

## IMPORTANT SAFETY INSTRUCTIONS

- 1) Read these instructions.
- 2) Keep these instructions.
- 3) Heed all warnings.
- 4) Follow all instructions.
- 5) Do not use this apparatus near water.
- 6) Clean only with dry cloth.
- 7) Do not block any of the ventilation openings. Install in accordance with the manufacturer's instructions.
- 8) Do not install near any heat sources such as radiators, heat registers, stoves, or other apparatus (including amplifiers) that produce heat. Allow adequate ventilation for the power adapter. Do not hide it under a carpet or behind a curtain or place it in an enclosed space where heat buildup can occur. Do not defeat the safety purpose of the polarized or grounding-type plug. A polarized plug has two blades with one wider than the other. A grounding type plug has two blades and a third grounding prong. The wide blade or the third prong are provided for your safety. If the provided plug does not fit into your outlet, consult an electrician for replacement of the obsolete outlet.
- 9) Protect the power cord from being walked on or pinched, particularly at plugs, convenience receptacles, and the point where they exit from the apparatus.
- 10) Only use attachments/accessories specified by the manufacturer.
- 11) Use only with a cart, stand, tripod, bracket, or table specified by the manufacturer, or sold with the apparatus. When a cart is used, use caution when moving the cart/apparatus combination to avoid injury from tip-over.
- 12) Unplug this apparatus during lightning storms or when unused for long periods of time.
- 13) Refer all servicing to qualified service personnel. Servicing is required when the apparatus has been damaged in any way, such as power-supply cord or plug is damaged, liquid has been spilled or objects have fallen into the apparatus, the apparatus has been exposed to rain or moisture, does not operate normally, or has been dropped.



**Warning:** To reduce the risk of fire or electric shock, do not expose this apparatus to rain or moisture. Do not expose this equipment to dripping or splashing and ensure that no objects filled with liquids, such as vases, are placed on the equipment.

To completely disconnect this equipment from the AC Mains, disconnect the power supply cord plug from the AC receptacle.

Congratulations on your purchase of a KC10C.

You'll find it easy to learn, but it is equipped with sensitive components inside of it.

Be sure to read the manual carefully as you continue to familiarize yourself with the features and functions of the KC10C.

Thank you.

## Contents

---

<b>1. Power supply and Precautions</b>	4
<b>2. Getting Started</b>	6
<b>3. Basic Operations</b>	8
<b>4. Using Bluetooth</b>	9
<b>5. The Rear Panel</b>	10
<b>6. Connecting to External Sound Systems</b>	11
<b>7. Connecting to USB</b>	11
<b>8. Demo Songs</b>	12
<b>9. Troubleshooting</b>	13
<b>10. Specification</b>	13

# 1. Power supply and Precautions

## Power supply

---

KC10C runs on AC 100-240 Volts 60 Hz/DC15V 3A.

### Power supply

If the power outlet is not the standard above, it is recommended you use an appropriate adaptor.

**Warning -** For perfect operation and security, please read the manual carefully and keep it for future reference.

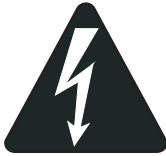

- 1) To reduce the risk of fire or electric shock, do not expose this apparatus to rain or moisture.
- 2) Please connect the designated AC adaptor to an AC outlet of the correct voltage
- 3) This product should only be used with a standard voltage, if not, please use an appropriate adaptor that is recommended by the manufacturer.
- 4) When you replace a fuse, only use a proper one.
- 5) Please open and close the keyboard cover carefully not to catch/trap hands or fingers.

### Caution



- 1) Avoid a severe shock to reduce the risk of a trouble
- 2) Protect the keyboard and switches when they are moved
- 3) Ensure the volume to the minimum level before turn on the keyboard
- 4) Do not open inside. This product contains precision parts inside, so unnecessary touch could cause a breakdown or an accident.
- 5) Turn off the power after use.
- 6) Unplug this apparatus when unused for long periods of time.
- 7) Do not apply excess force to the buttons and switches.

## Installation Site and Precautions

---

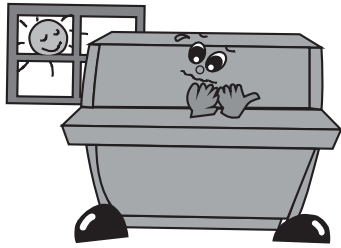

- Avoid direct sunlight
- Avoid extreme temperature or humidity.
- Avoid excessive dusty or dirty location.
- Do not place near any heat sources such as radiators, heat registers, stoves, or other apparatus (including amplifiers) that produce heat.



- Do not place objects, such as vases, glasses, and coffee cups, on the product.

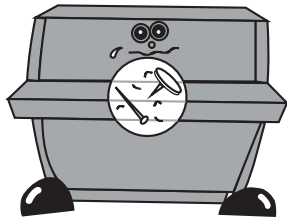

- Do not let paper, metallic, or other objects into the instrument.

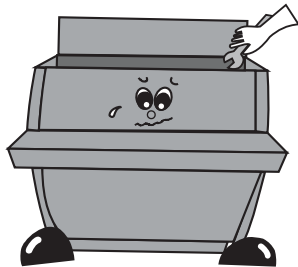

- Do not open inside personally. When repair is needed, please contact the Young Chang A/S center.

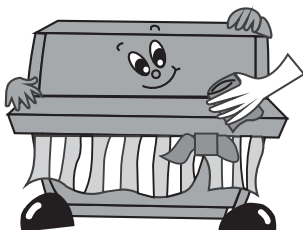

- Clean only with a soft, dry cloth. Do not use paint thinners, solvents, cleaning fluids, or chemical-impregnated wiping cloths

## 2. Getting Started

Thank for your purchase of a KC10C.

KC-10U is a new digital piano based on the latest technology.

This product contains a high definition German grand piano recorded by the engineers of Young Chang Music. You can also use USB and Bluetooth more interestingly.

Be sure to keep the manual on hand as you continue to familiarize yourself with the features and functions of the KC10C.

### Main Features

---

- High Definition German Grand Piano
- 88 Grand Hammer-Action Keys
- 100W, 4WAY Digital Sound System
- Connection to PC/Mobile by USB-AUDIO Function
- Playing Smartphone's music by Bluetooth

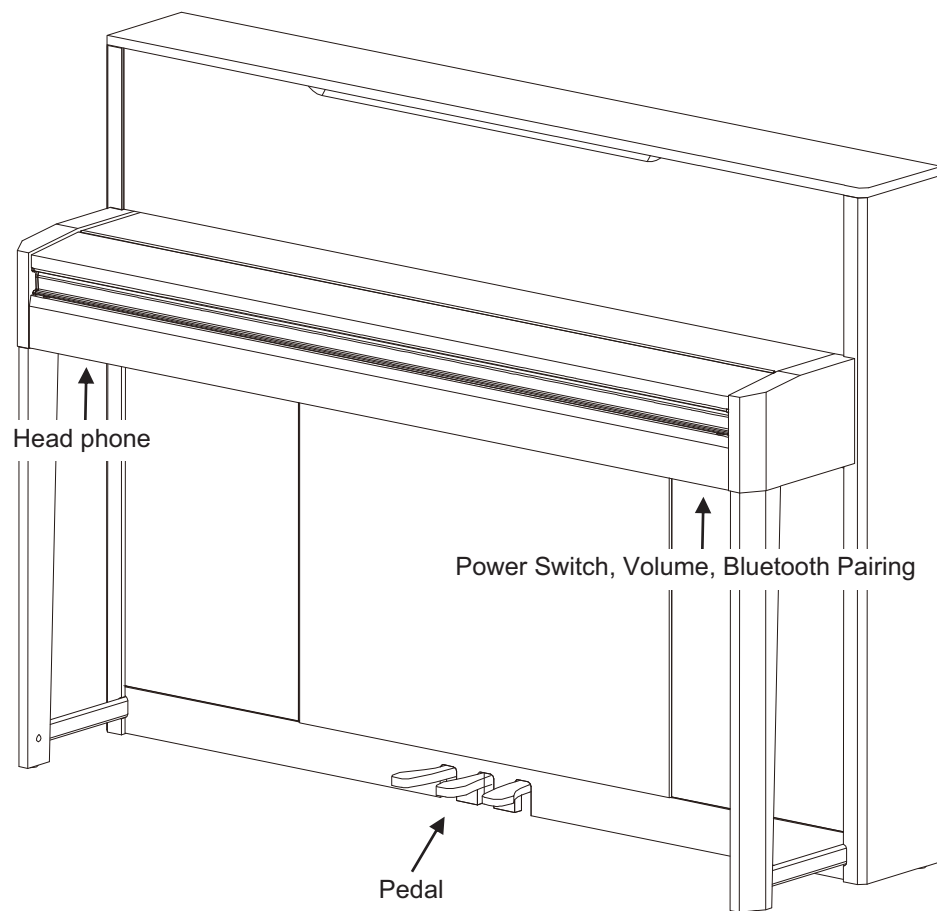



## Pedal

---

KC10C contains three functional pedals: Sustain, Sostenuto, Sof. It also works the same way with Grand Piano.

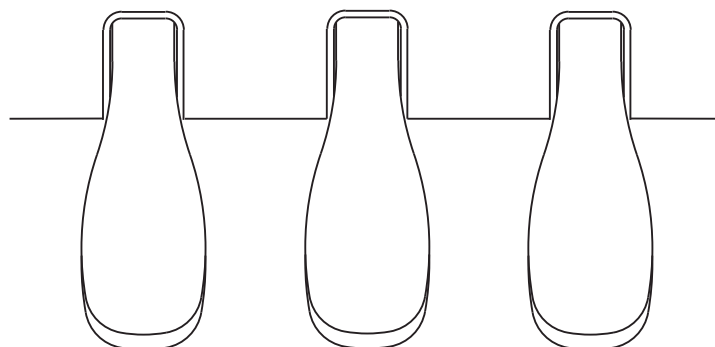

Soft Pedal    Sostenuto Pedal    Sustain Pedal

**Soft Pedal**    When the soft pedal is pressed, all notes played on the keyboard will have a softer effect.

**Sostenuto Pedal**    When the sostenuto pedal is pressed, the notes played before you step on the pedal would have a sustain effect.

**Sustain Pedal**    When the sustain pedal is pressed, notes sustain longer.  
Releasing the pedal immediately stops any sustained notes.

## Power Supply

---

\* When you finish all setting up, plug the power cable into the appropriate outlet.

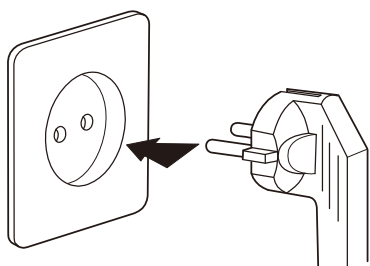

※ AC Plug is offered as a plug type suitable for a purchased location.

### 3. Basic Operations

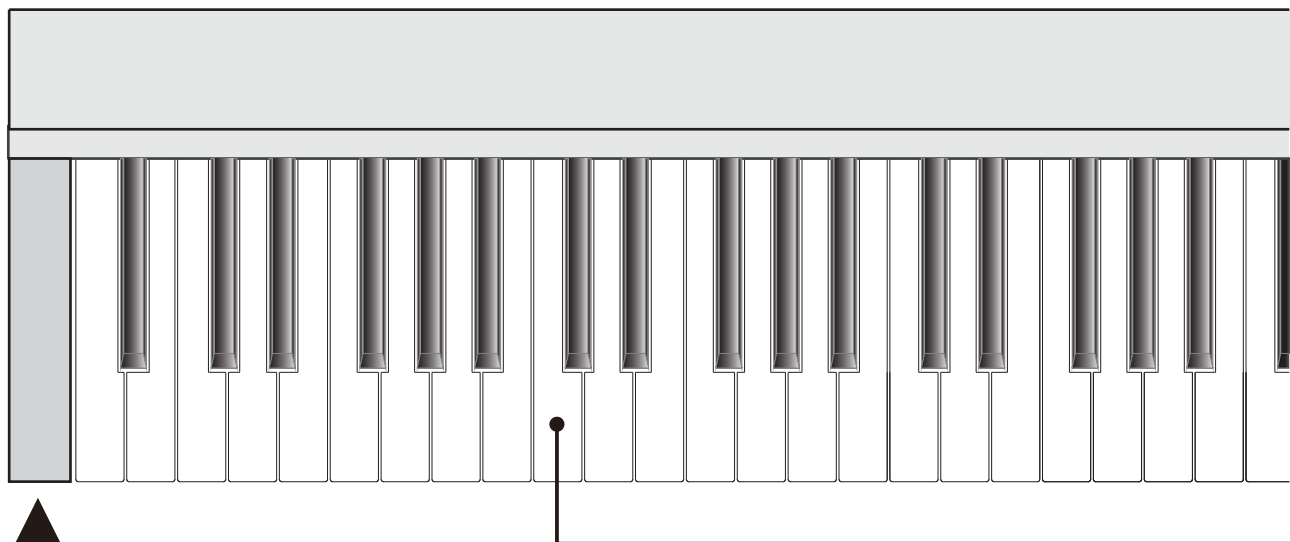

\* Selecting Operations: Press and hold the "Soft Pedal" and "Sustain Pedal" simultaneously, then select a function key you desire.

The bottom left of keyboard



#### \* Headphone Jack

The headphone jack is located on the bottom left of keyboard.

You will need a 1/4-inch stereo jack in order to use headphones and can use two headphones simultaneously.

The internal speaker system is automatically shut off when the headphone is plugged into Headphone jacks.

Two sets of standard stereo headphones can be plugged in here for private practice or late-night playing. You can control the volume by using the Volume slider.

#### Caution

To avoid the risk of hearing loss when using headphones, please do not play the piano with a high volume level for a long time.

#### \* Master Volume

Rotate the Volume slider clockwise, the volume increases and vice versa.

#### \* Power Switch

KC10C runs on AC 100-240 Volts 60 Hz.

If your power outlet is not the standard above, it is recommended you use an appropriate adaptor.

#### \* Selecting Functions

Press and hold the "Soft Pedal" and "Sustain Pedal" simultaneously, then select a function key you desire. For details on available functions, see the keyboard figure and check the information below.

\* Demo Song : There are select 50 demo songs.

\* Chorus (Stereo Effect) - Piano sound can be played in three-dimensions as if it sings in chorus.

\* Reverb (Resonance Effect) - This function changes the configuration of the effect to simulate a wide array of room types.

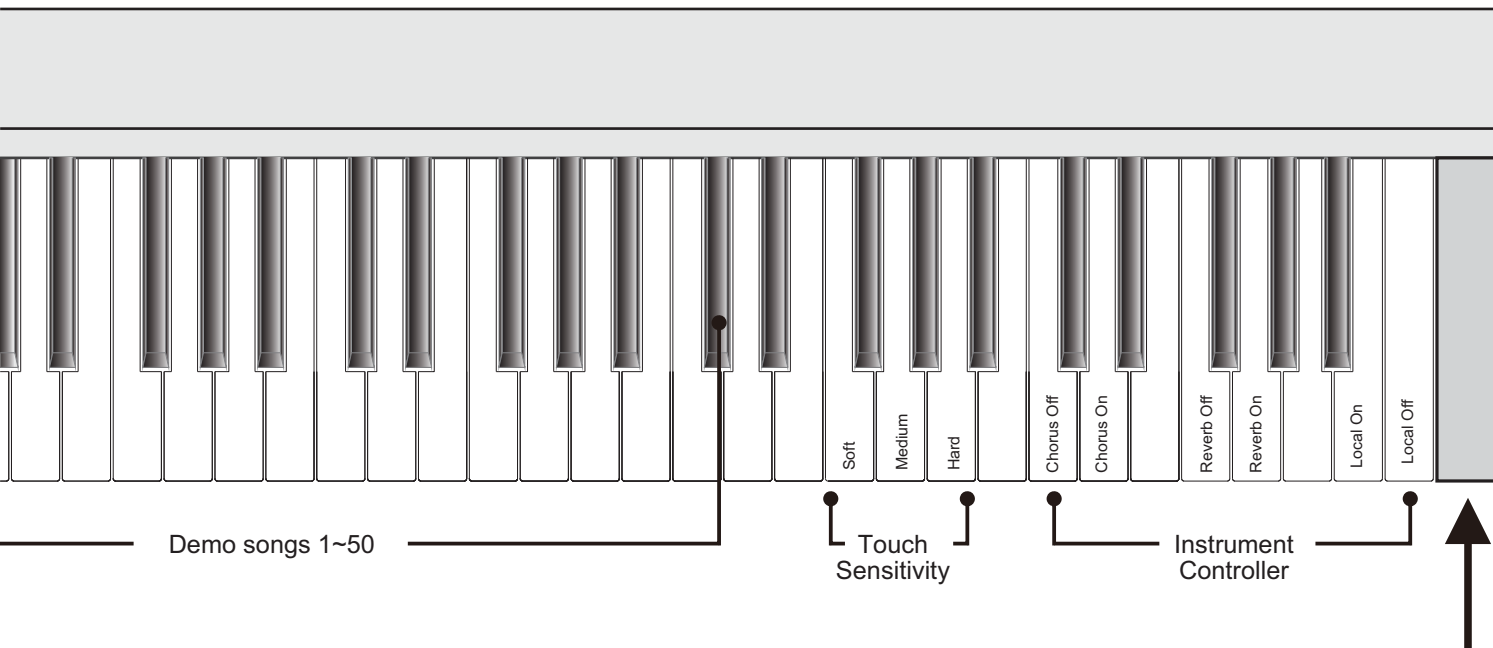

- \* Touch Sensitivity : These keys can control the touch sensitivity of the keyboard.
- \* Local ON/OFF : When “Local” is Off, only the source through USB-MIDI cannot be played. This function is useful when you use software instruments on your computer.

## 4. Using Bluetooth

KC-10U contains a function which is able listen to music by connecting smart devices wirelessly. Familiarize yourself with the following information to enjoy the latest feature.

### Pairing with Bluetooth Audio Device and Connection

To connect a smart device with KC-10U, pairing is needed.

1. Activate Bluetooth on your smart device, then press the pairing button located on the bottom right of your keyboard. Instantly, your instrument makes a sound and the LED next to the pairing button will start to blink.
2. Select 'SM-BT AUDIO' on Bluetooth setting page to connect with your instrument.
3. If the connection is successful, the LED will stop blinking.

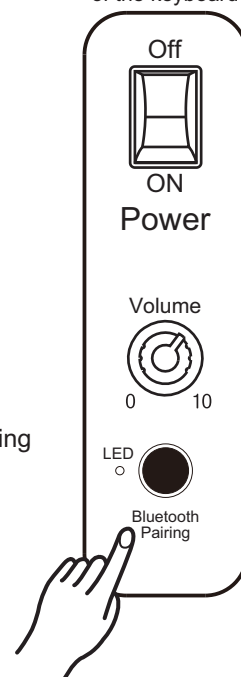

### Listening to music

You can hear the music through the speaker after the connection with smart device. Now you can enjoy every sound from your device.

## 5. The Rear Panel

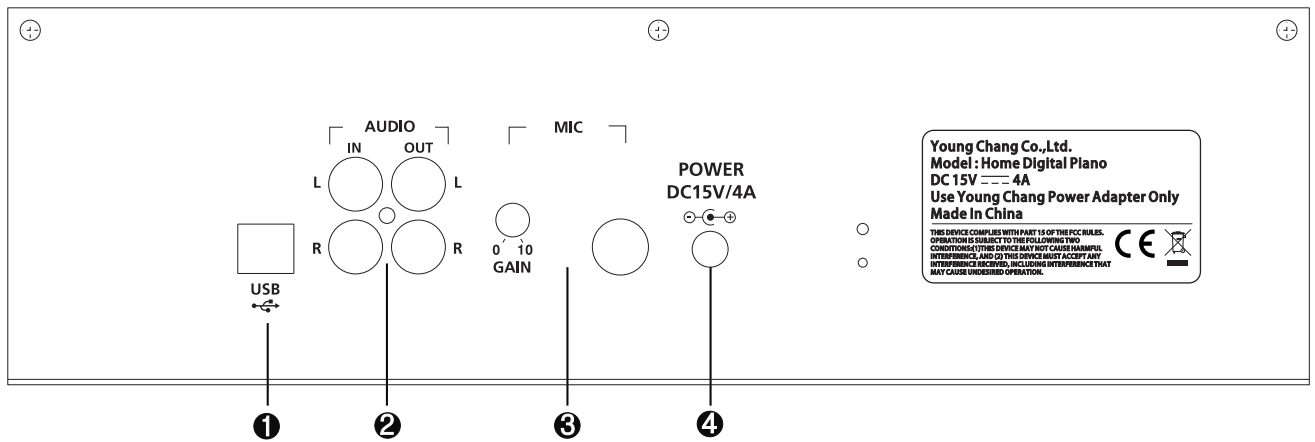

### 1. USB-MIDI, USB-AUDIO

If you connect your computer or mobile into USB port, you can execute MIDI device and sound card function. MIDI (short for Musical Instrument Digital Interface) allows a wide variety of electronic musical instruments, computers and other related devices to connect and communicate with one another.

### 2. AUDIO IN / OUT

- \* AUDIO IN : Connect the audio output of an MP3/CD player or other audio Source to the stereo AUDIO IN jack on the rear panel. You will be able to hear the music through the speaker of your keyboard.
- \* AUDIO OUT : AUDIO OUT jack delivers the output of the instrument for connection to a keyboard amplifier, audio system.

### 3. MIC Volume

This can control MIC Volume.

### 4. MIC Jack

Connect your MIC into the MIC port.

### 5. Power Cord

Connect the AC adaptor to the power supply cord.

## 6. Connecting to External Sound Systems

### Connecting to Your Audio System

---

You can transmit the audio signal of the piano to a keyboard amplifier, stereo sound system, mixing console or tape recorder or you can also hear audio signals from CD, MP3, PC via your instrument.

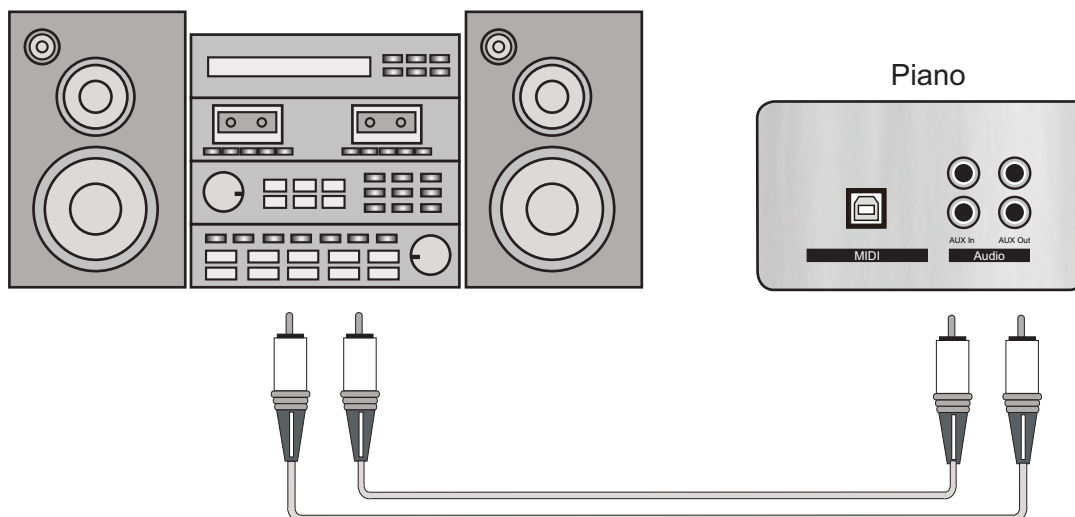

## 7. Connecting to USB

### Extended Operation by Connecting to Computer or Smart Device

---

You can enlarge the range of use on your instrument by connecting a PC to the USB terminal.

The Function of USB-MIDI and USB-AUDIO is offered, you can utilize it when you compose and arrange music or when you edit and record music.

There is no need to install any device driver when you connect (Plug and Play) and you can assign your device on Programme Sound/MIDI Setting page.

Be aware that additional programmes are not offered.

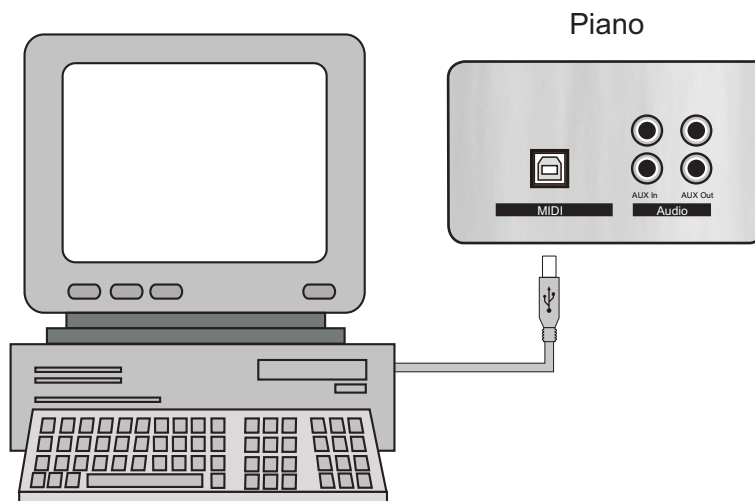

## 8. Demo Song List

No.	Song Name	Composer
1	Prelude I	J.S.Bach
2	Invention No.4	J.S.Bach
3	Invention No.8	J.S.Bach
4	Prelude II	J.S.Bach
5	Aria Goldberg	J.S.Bach
6	Fuga II	J.S.Bach
7	Sonatine Op.36	M.Clementi
8	Klavierstück	W.A.Mozart
9	Piano Sonate	W.A.Mozart
10	Rondo in D	W.A.Mozart
11	Piano Sonate K.3	W.A.Mozart
12	Piano Sonate K.5	W.A.Mozart
13	Minuet in G	L.V.Beethoven
14	Bagatelle No. 25	L.V.Beethoven
15	Sonatine Op.55	Fr. Kuhlau
16	March Militaire	F.P.Schubert
17	Moments Musicaux	F.P.Schubert
18	Impromptu No. 2	F.P.Schubert
19	Impromptu No. 4	F.P.Schubert
20	La Ch evaleresque	J.F.Burgmuller
21	Without words	J.L.F.Mendelssohn
22	Venetianisches	J.L.F.Mendelssohn
23	Sostenuto G#2	F.F.Chopin
24	Valse KK	F.F.Chopin
25	5 Mazurkas	F.F.Chopin

No.	Song Name	Composer
26	Valse Op.69 No.2	F.F.Chopin
27	Grande Valse	F.F.Chopin
28	Valse Op.64 No.2	F.F.Chopin
29	Nocturne No.2	F.F.Chopin
30	Valse Op.64 No.1	F.F.Chopin
31	Preludes in Db	F.F.Chopin
32	Fantaisie-Improm	F.F.Chopin
33	Traumerei	R.Schumann
34	Fröhlicher landmann	R.Schumann
35	Von Fremden Land	R.Schumann
36	Liebestraum #3	F.Lisz
37	Dolly's Dreaming	T.Oesten
38	Frühlingsstimmen	J.Strauss
39	The Swan	Saint-Saëns
40	Blumenlied	G.Lange
41	Valsette	F.Borowski
42	Old French Air	P.I.Tchaikovsky
43	Mazurka	P.I.Tchaikovsky
44	Polka	P.I.Tchaikovsky
45	Barcarolle	P.I.Tchaikovsky
46	Humoreska	A.Dvorak
47	Suite Peer Gynt	E.Grieg
48	Suite Bergamasque	C.A.Debussey
49	Reverie	C.A.Debussey
50	Arabesque	C.A.Debussey

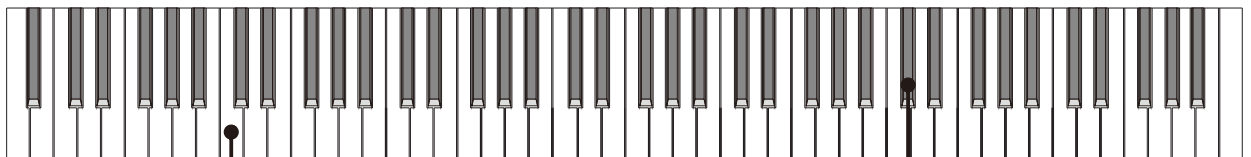

Demo songs 1~50

\* Selecting a Demo Song: Press and hold the "Soft Pedal" and "Sustain Pedal" simultaneously, then select a demo song you desire.

## 9. Troubleshooting

Check if one of the following might be the issue.

Problem	Cause	Solution
No sound is produced when the keys are played.	<ol style="list-style-type: none"> <li>1. The master volume is set in the minimal level</li> <li>2. Headphone is connected</li> </ol>	<ol style="list-style-type: none"> <li>1. Make sure the volume is set to an appropriate level</li> <li>2. Disconnect the headphones from the jack</li> </ol>
Sometime the speaker produce noise	<ol style="list-style-type: none"> <li>1. A noise neighboring electrical appliances</li> <li>2. A noise neighboring bulbs or neon signs</li> </ol>	<ol style="list-style-type: none"> <li>1. Use an another outlet from the outlet used for the appliance</li> <li>2. Put your instrument far from the bulbs or the neon signs</li> </ol>
No sound when an amplifier is connected	<ol style="list-style-type: none"> <li>1. The master volume is set in the minimal level</li> <li>2. The extension cord is faulty</li> </ol>	<ol style="list-style-type: none"> <li>1. Make sure the volume is set to an appropriate level</li> <li>2. Replace it with the new</li> </ol>

Please contact us If the problems continue

## 10. Specification

Standard	KC10C
Keyboard	88 hammer keys (A0~C8)
Voice Type	Stereo PCM
Appearance	Upright
Exterior color	Ebony and Ivory Polish
Tone	High Definition German Grand Piano
Demo songs	50 Demo songs
Pedal	Soft Pedal, Sostenuto Pedal, Sustain Pedal
Additional Function	Reverb (Resonance Effect), Chorus (Stereo Effect), USB, MIDI, AUDIO, Bluetooth
Generating Capacity	25W x 4, 4ways (Stereo)
Power Consumption	100W
Speaker	4 WAY Speakers 6ohm
Dimensions	143.3 x 42.2 x 105.6 (W x D x H)
Weight	100Kg - There can be a slight difference in weight.

**YOUNG CHANG**

*Music Systems*

