

"BH-2" Bluetooth® Head Set

When the optional BU-1 Bluetooth® Adapter Unit is installed in the Transceiver*, you may use the optional BH-2 Bluetooth® Headset as a wireless link to send and receive audio to the Transceiver*.

* Check with your Vertex Standard Dealer or Catalog for applicable models.

Controls & Connections

- ① **Microphone**
- ② **POWER switch**
- ③ **VOLUME (-) switch**
Press this switch while pressing and holding the PTT switch, to decrease the microphone gain.
- ④ **VOLUME (+) switch**
Press this switch while pressing and holding the PTT switch, to increase the microphone gain.
- ⑤ **LED Indicator**
Blinking Blue: When the BH-2 Bluetooth® Headset is correctly recognized by the transceiver.
Blinking Red: When the BH-2 Bluetooth® Headset is not correctly recognized by the transceiver.
Blinking Red/Blue: Battery Voltage is Low.
- ⑥ **PTT switch**
Press this key to transmit. Release this key to return to receive (Depends on transceiver settings).
- ⑦ **SPEAKER**
- ⑧ **Earhook**
You can wear the BH-2 on your left or right ear.

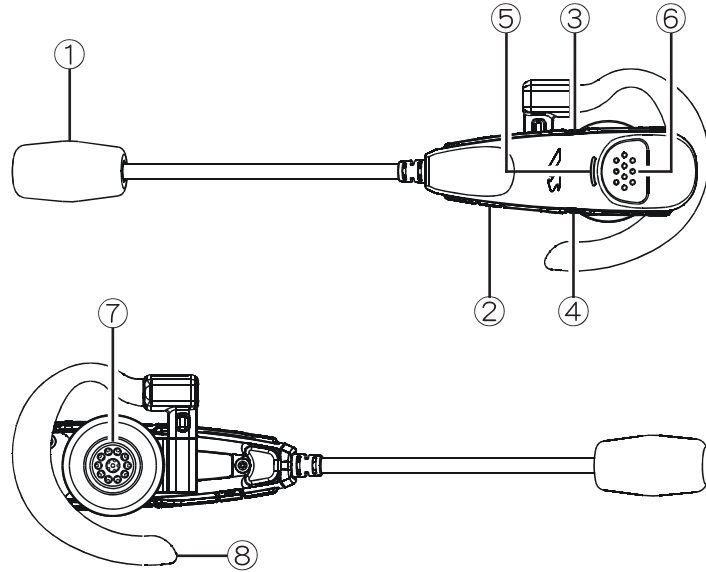

BH-2 is not designed to attach to a motorcycle helmet. Specifications are subject to change without notice.

Pairing

Before you can use your BH-2 for the first time, the BH-2 and the transceiver must be paired. Refer to the Transceiver's Operating Manual for Pairing instructions.

○ Please bring the BH-2 and the Transceiver close together when doing Pairing.

1. Make sure that the BH-2 is off.
2. Press and hold the POWER switch for five seconds, until the LED indicator blinks red/blue alternately.

When the BH-2 is correctly recognized (Requires a 20 to 30 seconds) by the transceiver, the LED indicator will blink blue.

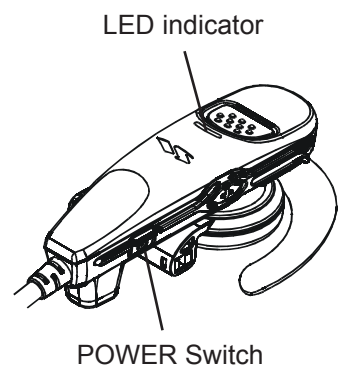

Turning ON and OFF

To turn the BH-2 ON

Press and hold the POWER switch for three seconds, until the BH-2's LED indicator glows red, and the beeper sounds a high pitch tone.

When the BH-2 is correctly recognized by the transceiver, the LED indicator will blink blue.

○ When the BH-2 is not correctly recognized by the transceiver, the LED indicator will blink red.

To turn the BH-2 OFF

Press and hold the POWER switch for five seconds, until the BH-2's red LED indicator blinks rapidly, the beeper sounds two brief tones, and the BH-2 turns off.

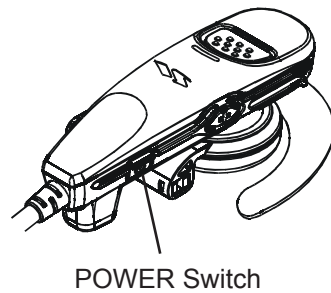

Effective Communications Range

The communications range between the BH-2 and the Transceiver is around 10m (33 ft).

Obstacles between the BH-2 and the Transceiver may decrease the communications distance.

When you move out of range, the beeper sounds a low pitch tone. When you move back into range, the beeper sounds a high pitch tone.

Wearing the BH-2

1. Open the earhook.
2. Loop the earhook over your ear.
3. Press the BH-2 to your ear.
4. Adjust the flexible boom microphone by bending the boom towards your mouth.

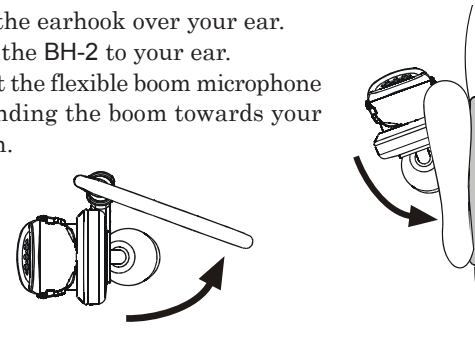

For more comfort when wearing the BH-2, affix the supplied sponge on the speaker and press the supplied sponge ball onto the earhook, and adjust as necessary.

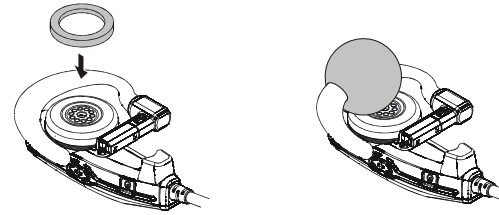

The BH-2 comes ready to fit the left ear. You may change the BH-2 to fit the right ear in the following procedure.

1. Remove the Earhook by pushing it out with a pointed object.
2. Insert the Earhook from the other side.

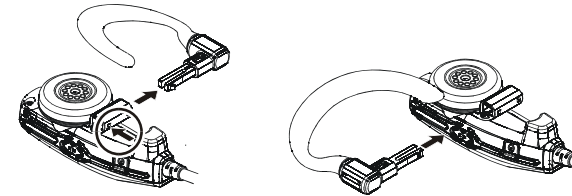

Operation

Transmission

Press the PTT switch to transmit, and release the switch to return to receive (Depends on transceiver settings).

Adjusting the Volume level

Adjust the receiver audio level, using the VOLUME (-) or (+) switch. When the audio level reaches the maximum or minimum, the beeper sounds two brief tones.

VOLUME (+): Adjusts the receiver audio level upward.
VOLUME (-): Adjusts the receiver audio level downward.

Microphone Gain Setting

Press and hold the PTT switch, while using the VOLUME (+) or (-) switch to select a comfortable Microphone gain level (Five steps). When the microphone gain reaches the maximum or minimum, the beeper sounds a high pitch tone.

VOLUME (+): Sets the MIC gain upward.
VOLUME (-): Sets the MIC gain downward.

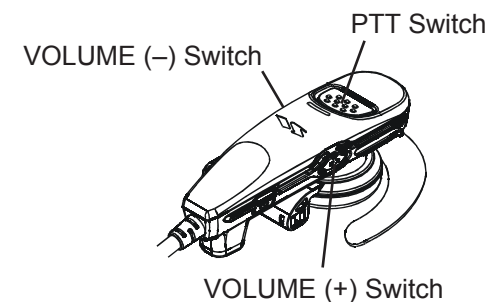

Battery

When the battery voltage becomes low, the BH-2's LED indicator will blink red/blue alternately, and the beeper sounds a low pitch tone.

If the battery has never been used, or its charge is depleted, it may be charged by connecting to the Charger Sleeve* or Charger Cradle*, as shown in the illustration.

Please refer to the transceiver's manual for installation of the Charger Sleeve.

* Check with your Vertex Standard Dealer or Catalog for applicable models.

1. Insert the BH-2 into the Charger Sleeve or Charger Cradle.

Note: The BH-2 is automatically set to "sleep" mode, when it is inserted into the Charger Sleeve or Charger Cradle.

When it is disconnected from the Charger Sleeve or Charger Cradle, the BH-2 will be active again.

2. If the BH-2 is inserted correctly, the LED indicator will glow Red. A fully discharged battery will be charged completely in 3 hours. When charging is finished, the LED indicator will glow blue.

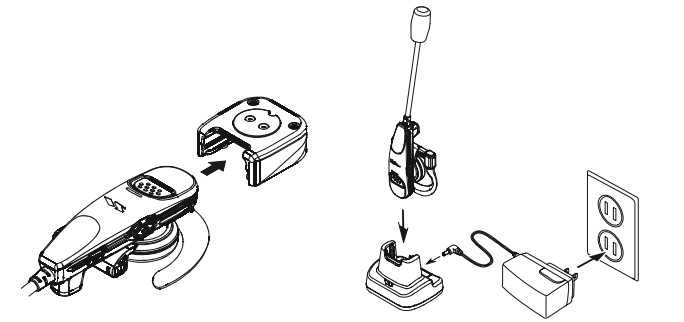

Example: Use the "CAB-1"

Example: Use the "CD-40"

Battery saver

If there has been no signal or key button activity for 20 seconds, the Battery Save automatically puts the BH-2 in "sleep" mode, to conserve battery life.

When a signal is received or the PTT key is pressed the BH-2 will be active again.

Refer to the Transceiver's Manual for Battery saver instructions.

Specifications

Bluetooth specification	Ver1.2
Bluetooth profiles	HSP
Radio Frequency	2402 MHz - 2480 MHz
Modulation method	GFSK
Transmitter output power	0 dBm Class 2
Receiver sensitivity	<-80 dBm
Distance (open area)	32 ft (10 meters)
Audio format	SBC
Audio frequency range	100 Hz - 20 kHz
Power supply	Rechargeable Lithium-Polymer
Battery life	6 hours
Button/Switch	Power On/Off, Volume Up/Down, PTT
LED indicators	Power on: Flash blue twice Unlink: Flash red Link: Flash blue Pairing: Red and Blue blinking Battery low: Flash red and blue Power off: Flash red 3 times
Operating temperature	32 °F to 104 °F (0 °C to 40 °C)
Operating humidity	5 - 90 %
Certification	FCC, CE, BQB

Replacement Parts

Ear hook	S8002323	Speaker sponge	S8002324
Ear hook sponge	S8002325	Wind Screen	S8002322

VERTEX STANDARD CO., LTD.



E A F 4 4 U 7 6 0