

 **Vertex Standard**

VX-4200 *SERIES*

OPERATING MANUAL

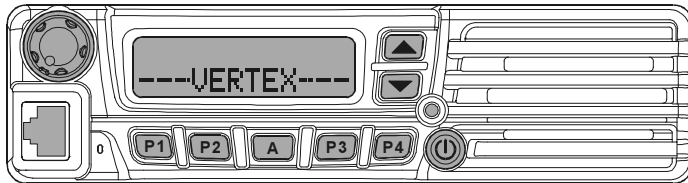

VERTEX STANDARD CO., LTD.

4-8-8 Nakameguro, Meguro-Ku, Tokyo 153-8644, Japan

VERTEX STANDARD

US Headquarters

10900 Walker Street, Cypress, CA 90630, U.S.A.

YAESU EUROPE B.V.

P.O. Box 75525, 1118 ZN Schiphol, The Netherlands

YAESU UK LTD.

Unit 12, Sun Valley Business Park, Winnall Close
Winchester, Hampshire, SO23 0LB, U.K.

VERTEX STANDARD HK LTD.

Unit 5, 20/F., Seaview Centre, 139-141 Hoi Bun Road,
Kwun Tong, Kowloon, Hong Kong

Congratulations!

You now have at your fingertips a valuable communications tool: a VERTEX STANDARD two-way radio! Rugged, reliable and easy to use, your VERTEX STANDARD radio will keep you in constant touch with your colleagues for years to come, with negligible maintenance downtime.

Please take a few minutes to read this manual carefully. The information presented here will allow you to derive maximum performance from your radio, in case questions arise later on.

We're glad you joined the VERTEX STANDARD team. Call on us anytime, because communications is our business. Let us help you get your message across.

NOTICE !

There are no owner-serviceable parts inside the transceiver. All service jobs must be referred to an authorized VERTEX STANDARD Service Representative. Consult your Authorized VERTEX STANDARD Dealer for installation of optional accessories.

SAFETY/WARNING INFORMATION

WARNING - DO NOT operate the VX-4200 radio when any person(s) (bystanders) outside the vehicle are within the distances shown in the chart at the bottom of this section.

Safety Training information:

Antennas used for this transmitter must not exceed an antenna gain of 0 dBd. The radio must be used in vehicle-mount configurations with a maximum operating duty factor not exceeding 50%, in typical Push-to-Talk configurations.

This radio is restricted to occupational use, work related operations only where the radio operator must have the knowledge to control the exposure conditions of its passengers and bystanders by maintaining the minimum separation distance shown below.

Failure to observe these restrictions will result in exceeding the FCC RF exposure limits.

Antenna Installation:

For rear deck trunk installation, the antenna must be located at least the following distance away from rear-seat passengers in order to comply with the FCC RF exposure requirements.

For roof top installations, the antenna must be placed in the center of the roof.

Unsafe Radiation Distance

VX-4204	VX-4207
1.97 Feet (0.60 m)	2.82 Feet (0.86 m)

INTRODUCTION

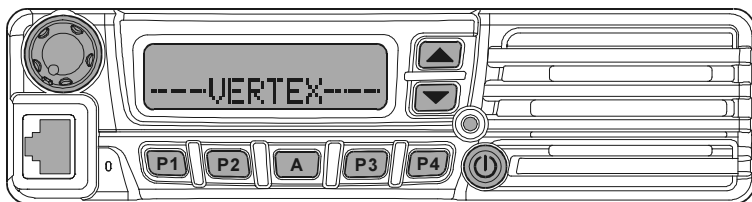

The **VX-4200** Series are full-featured FM transceiver designed for flexible mobile and base station business communications in the VHF or UHF Land Mobile bands. These transceiver are designed for reliable business communications in a wide variety of applications with a wide range of operating capability provided by their leading-edge design.

The 501-channel memories can each be programmed with a 12-character channel name.

Important channel frequency data is stored in EEPROM and flash memory on the CPU, and is easily programmable by dealers using a personal computer and the VERTEX STANDARD **VPL-1** Programming Cable and **CE59** Software.

The pages which follow will detail the many advanced features provided on the **VX-4200** Series transceiver. After reading this manual, you may wish to consult with your Network Administrator regarding precise details of the configuration of this equipment for use in your application

For North American Users Regarding 406 MHz Guard Band

The U.S. Coast Guard and National Oceanographic and Atmospheric Administration have requested the cooperation of the U.S. Federal Communications Commission in preserving the integrity of the protected frequency range 406.0 to 406.1 MHz, which is reserved for use by distress beacons. Do not attempt to program this apparatus, under any circumstances, for operation in the frequency range 406.0 - 406.1 MHz if the apparatus is to be used in or near North America.

CONTROLS & CONNECTORS

Front Panel

Important! - All buttons located on the Front Panel are Programmable Function (PF) Buttons, configured according to your network requirements and programmed by your VERTEX STANDARD dealer. The instructions below describe a typically-configured radio.

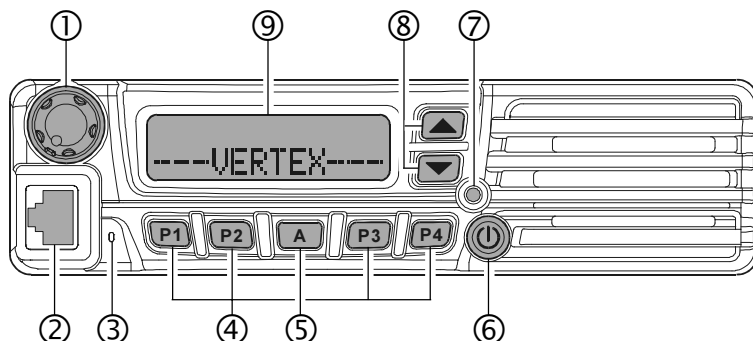

① VOL Knob

Turn this control clockwise to increase the volume.

② Microphone Jack

Connect the microphone plug to this jack.

③ Emergency Microphone

The emergency microphone is located behind this small slit. When the emergency feature is activated, this microphone is enabled.

④ [P1] - [P1] Buttons (Programmable Function Buttons)

These buttons can be set up for special applications, such as High/Low power selection, Monitor, Talk-Around, etc., as determined by your network requirements and programmed by your VERTEX STANDARD dealer.

⑤ [A] Button (Programmable Function Button)

This button can be set up for special applications, such as High/Low power selection, Monitor, Talk-Around, etc., as determined by your network requirements and programmed by your VERTEX STANDARD dealer.

CONTROLS & CONNECTORS

⑥ (POWER) Button

Press and hold in this button for 2 seconds to toggle the transceiver's power "on" and "off."

⑦ BUSY/TX Indicator

Indicates transceiver's Transmit/Receive Status

- Steady Red: Transmitting in progress
- Steady Green: Signaling Off
- Blinking Green: Busy Channel/Squelch Off

⑧ [▼]/[▲] Buttons (Programmable Function Buttons)

Pressing either button changes the current channel (and displayed channel number or name). Holding in either button for more than 1.5 second causes the radio to begin stepping (repeatedly) upward or downward through the channels.

⑨ LCD (Liquid Crystal Display)

The display includes a 3-character numeric section showing Channel Group number or certain status indications (see below), a 12-character alpha-numeric section showing Channel name tags/identity information and error messages, and an upper icon row displaying feature status.

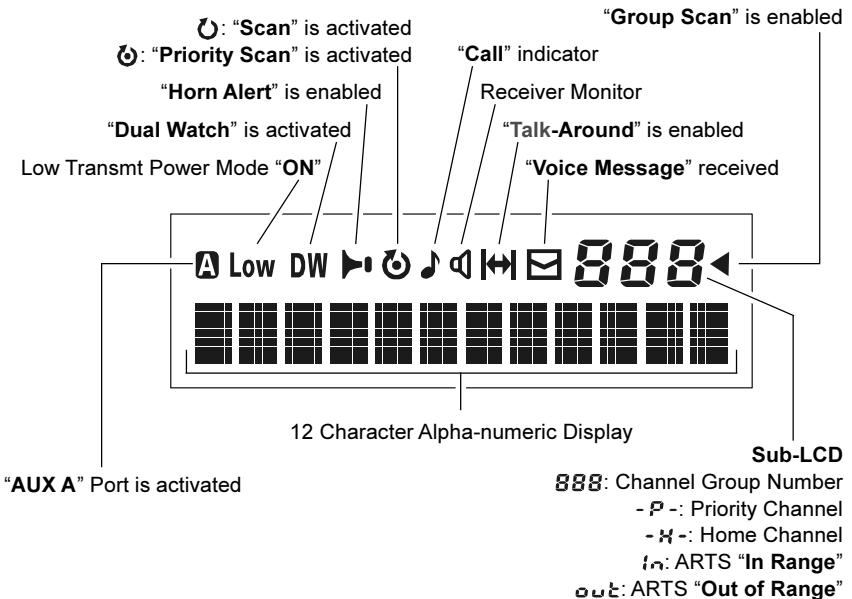

CONTROLS & CONNECTORS

Rear Panel

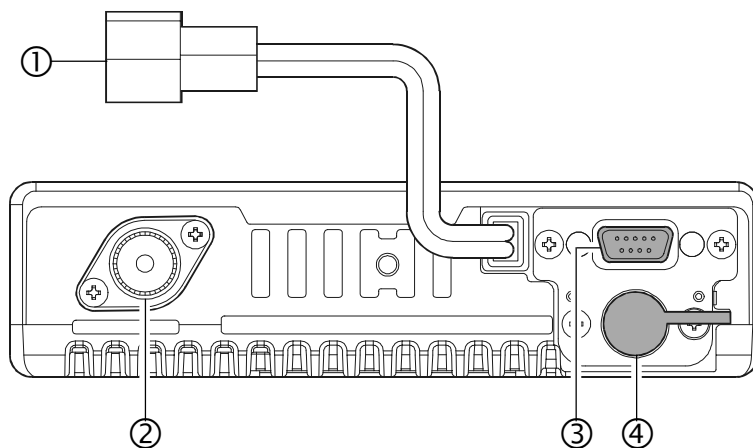

① 13.6V DC Cable Pigtail with Connector

The supplied DC power cable must be connected to this 2-pin connector. Use only the supplied fused cable, extended if necessary, for power connection.

② Antenna Socket

The 50-Ohm coaxial feedline to the antenna must be connected here, using a type-M (PL-259) plug.

③ D-Sub 15-Pin Accessory Connector

External TX audio line input, PTT (Push To Talk), Squelch, and external RX audio line output signals may be obtained from this connector for use with accessories such as data transmission/reception modems, and external Channel control input etc.

④ External Speaker Jack

An external loudspeaker may be connected to this 2-contact, 3.5-mm mini-phone jack.

Caution: Do not connect either wire of this line to ground, and be certain that the speaker has adequate capability to handle the audio output (12 W) from the radio.

BASIC OPERATION OF THE TRANSCEIVER

Important! - Before turning on the radio the first time, confirm that the power connections have been made correctly and that a proper antenna is connected to the antenna jack.

Switching Power ON/OFF

- Press and hold in the **⊕ (POWER)** button for 2 seconds to turn the radio on. The display will become illuminated.
- Press the [**▼**]/[**▲**] button to choose the desired operating channel. A channel name will appear on the display. If you want to select an operating channel from a different group, press the PF (Programmable Function) button which is programmed to the Group Up/Down feature to select the group you want before selecting the operating channel. See page 7 for more information on the Programmable Function keys.

Setting the Volume

- Turn the **VOL** knob clockwise to increase the volume, and counterclockwise to decrease it.

Transmitting

- To transmit, monitor the channel and make sure it is clear.
THIS IS AN FCC REQUIREMENT!
- Press the PF button which is programmed to the Monitor feature to listen for channel activity.
- When receiving a call, transmit only after the incoming call ends. The radio cannot receive a call and transmit simultaneously.
- Press the **PTT** switch.
- If the channel is clear, the **BUSY/TX** indicator will glow red. The radio is now transmitting. While holding in the **PTT** switch, speak across the face of the microphone in a clear and normal voice. For best transmission, hold the microphone about 1-1/2 to 2 inches away from your mouth. Release the **PTT** switch to receive.
- If the Busy Channel Lockout feature has been programmed on a channel, the radio will not transmit when a carrier is present. Instead, the radio will generate a short beep three times and indicate “* ERROR *” on the display. Release the **PTT** switch and wait for the channel to be clear of activity.
- If CTCSS or Digital Coded Squelch (DCS) Lockout has been programmed on a channel, the radio can transmit only when there is no carrier being received or when the carrier being received includes the correct CTCSS tone or DCS code.

BASIC OPERATION OF THE TRANSCEIVER

Automatic Time-Out Timer

If the selected channel has been programmed for automatic time-out, you must limit the length of each transmission. While transmitting, a beep will sound 10 seconds before time-out. Another beep will sound just before the deadline; the red “**TX**” indicator will disappear and transmission will cease soon thereafter. To resume transmitting, you must release the **PTT** switch and wait for the “penalty timer” to expire (if you press the **PTT** switch before this timer expires, the timer restarts, and you will have to wait another “penalty” period)

Key Lock

In order to prevent accidental frequency change or inadvertent transmission, various aspects of the **VX-4200**'s keys, and **PTT** switch, may be locked out. The precise lockout configuration may be configured using the “User Set” (Menu) mode. See page 16 for detail.

To activate the Locking feature, press and hold in the [**P4**] key while turning the radio on. To disable the Locking feature, repeat this power-on procedure.

ADVANCED OPERATION

Programmable Function (PF) Buttons

The **VX-4200** Series includes seven Programmable Function (PF) Buttons. The PF button functions can be customized, via programming by your VERTEX STANDARD dealer, to meet your communications/network requirements. Some features may require the purchase and installation of optional internal accessories. The possible PF button programming features are illustrated below, and these functions are explained on the pages to follow.

For further details, contact your VERTEX STANDARD dealer. For future reference, check the box next to the function that has been assigned to each PF button on your particular radio, and keep it handy.

Function	PF Button					Function	PF Button				
	A	P1	P2	P3	P4		A	P1	P2	P3	P4
MONI						Code Up					
SQL						Code Down					
DIMMER						Code SET					
Channel Up						Status Up					
Channel Down						Status Down					
Group Up						Status SET					
Group Down						Status Check					
SCAN						Speed Dial					
DW (Dual Watch)						HOME					
Follow-Me SCAN						Selectable Tone					
Follow-Me DW						Horn Alert					
LOW						Public Address					
TA (Talk Around)						EXT. ACC1					
TX SAVE Disable						EXT. ACC2					
Encryption Disable [※]						Direct CH#1					
Emergency						Direct CH#2					
CALL/RESET						Direct CH#3					
CALL 1						Direct CH#4					
CALL 2						REC/PLAY [※]					
CALL 3						AF Min Vr					
CALL 4						SET					
CALL 5											

※: Requires optional unit

ADVANCED OPERATION

Description of Operating Functions

MONITOR (MONI)

Press the assigned programmable key to cancel CTCSS- and DCS-controlled squelch; the **BUSY/TX** indicator will glow green. Press and hold in this button for 1.5 seconds to hear background noise (unmute the audio); the **BUSY/TX** indicator will blink green.

SQUELCH (SQL)

You can manually adjust the squelch level using this function:

- Press the assigned programmable key. A tone will sound, and the current squelch level appears on the display.
- Press the [▼]/[▲] button to select the desired squelch level.
- Press this key again. A tone will sound, and the display will revert to the normal channel indication.

DIMMER

Press the assigned programmable key to select the brightness level of the display and key backlight. Available selections are four levels.

CHANNEL UP/DOWN

Press the assigned programmable key (generally the [▼]/[▲] button) to select a different channel within the current group.

GROUP UP/DOWN

Press the assigned programmable key to select a different group of channels. Once the desired Group is reached, press the Channel Up/Down key (generally the [▼]/[▲] button) to select the desired channel within the selected Group.

You may wish to have the Scanner pass through more than one Group during the scanning process (normally, scanning is performed within the current group only). **To include the current Group in the scanning loop**, press and hold in the assigned programmable key for one second. **To remove a Group from Group Scan**, press and hold in the assigned programmable key again for one second.

Multi-Group Scanning is only possible if you are using the “User Scan” list. **To edit the User Scan list**, press and hold the assigned programmable key for one second to delete the current Memory Group from the Scanning. Alternatively, press and hold the assigned programmable key for one second to delete the Current Memory chan-

ADVANCED OPERATION

nel from the Scanning. When you delete a Group or channel, “-SCAN Skip-” will appear on the LCD for one second after pressing the assigned programmable key. To restore a particular channel to your scanning list, press and hold in the assigned programmable key again for one second; “-SCAN Stop-” will appear on the LCD for one second after pressing the assigned programmable key.

CHANNEL SCAN (SCAN)

The Scanning feature is used to monitor multiple channels programmed into the transceiver. While scanning, the transceiver will check each channel for the presence of a signal, and will stop on a channel if a signal is present.

To activate scanning:

- Press the assigned programmable key to activate scanning on the current group.
- The scanner will search the programmed channels, looking for active ones; it will pause each time it finds a channel on which someone is speaking.
- Press the assigned programmable key again to disable scanning. Operation will revert to the programmed revert channel or activate the Group scanning when Multi-Group Scanning is enabled.

Note: Your dealer may have programmed your radio to stay on one of the following channels if you press the **PTT** switch during the scanning pause:

- Current channel (“Talk Back”)
- “Last Busy” channel
- “Priority” channel
- “Home” channel
- “Scan Start” channel

DUAL WATCH (DW)

The Dual Watch feature is similar to the SCAN feature, except that only two channels are monitored:

- The current operating channel; and
- The Priority channel.

To activate Dual Watch:

- Press the assigned programmable key.
- The scanner will search the two channels; it will pause each time it finds a channel on which someone is speaking.

To stop Dual Watch:

- Press the assigned programmable key.
- Operation will revert to the “Dual Watch Start” channel.

ADVANCED OPERATION

FOLLOW-ME SCAN

“Follow-Me” Scan feature checks a User-assigned Priority Channel regularly as you scan the other channels. Thus, if only Channels 1, 3, and 5 (of the 8 available channels) are designated for “Scanning,” the user may nonetheless assign Channel 2 as the “User-assigned” Priority Channel via the “Follow-Me” feature.

To activate “Follow-Me” scanning, first select the channel you want to designate as the “User-Assigned Priority Channel” and press the assigned programmable key. Then press the Channel Up/Down key (generally the [▼]/[▲] button) to recall to the “Scanning Start” channel which has been programmed by your dealer to activate the scanner. When the scanner stops on an “Active” channel, the User-assigned Priority Channel will automatically be checked every few seconds; if activity is found on the User-assigned Priority Channel, the radio will switch between it and the Dealer-Assigned Priority Channel, if any.

FOLLOW-ME DUAL WATCH (DW)

To set up a “Dual Watch” frequency pair using the “Follow-Me” feature, select a channel using the Channel Up/Down key (generally the [▼]/[▲] button). Now press the assigned programmable key; pressing the assigned programmable key locks the current channel as the User-assigned Priority Channel. Now press the Channel Up/Down key to select another channel (not the “Scanning Start” channel). Your radio will now switch back-and-forth between the currently-selected channel and the User-assigned Priority Channel.

During “Follow-Me” scanning (after you have pressed the key), you can set up the “Dual Watch” feature by pressing the Channel Up/Down key to another channel. The radio will then scan back and forth between the original User-assigned Priority Channel and the newly-selected channel.

The Priority Channel you have assigned (before pressing the key) will be retained in memory until you change it.

LOW POWER (LOW)

Press the assigned programmable key to set the radio’s transmitter to the “Low Power” mode, thus extending battery life. Press the key again to return to “High Power” operation when in difficult terrain.

When the radio’s transmitter is set to “Low Power” mode, the “**Low**” icon will be indicated on the display.

ADVANCED OPERATION

TALK AROUND (TA)

Press the assigned programmable key to activate the Talk Around feature when you are operating on duplex channel systems (separate receive and transmit frequencies, utilizing a “repeater” station). The Talk Around feature allows you to bypass the repeater station and talk directly to a station that is nearby. This feature has no effect when you are operating on “simplex” channels, where the receive and transmit frequencies are already the same.

When the “TA” function is activated, the “” icon will be indicated on the display.

Note that your dealer may have mode provision for “Talk Around” channels by programming “repeater” and “Talk Around” frequencies on two adjacent channels. If so, the key may be used for one of the other Pre-Programmed Functions.

ENCRYPTION DISABLE (OPTION)

When the Voice Scrambler feature is enabled, press the assigned programmable key to toggle the voice encryption on and off.

EMERGENCY

The **VX-4200** series include an “Emergency” feature which may be useful if you have someone monitoring on the same frequency as your transceiver’s channel.

Press the assigned programmable key to initiate an emergency call. For further details contact your VERTEX STANDARD dealer.

CALL/RESET

This feature, if enabled, allows the user to change the 3-digit Page Call code, used to call other similarly-equipped stations. Press the assigned programmable key, followed by the three digits representing the Page Call code of the station you wish to call. Three tones will be heard after the last key is pressed (the new code will now be transmitted).

The receiver squelch of the other station will be opened, and you can begin communication.

CALL 1 TO CALL 5

Press the assigned programmable key to send a 5-Tone sequential burst which is pre-defined.

ADVANCED OPERATION

CODE UP/DOWN

Press the assigned programmable key to select a 5-Tone encode code from pre-defined encode list.

CODE SET

Press the assigned programmable key to change the 5-Tone encoding digit. To change the tones, select the desired digit using the [P1]/[P2] keys, then change the number using the [▼]/[▲] keys.

STATUS UP/DOWN

Press the assigned programmable key to select a 5-Tone status code from the pre-defined status list.

STATUS SET

Press the assigned programmable key to change the 5-Tone status code. To change the status code, select the desired digit of the status code using the [P1]/[P2] keys, then change the number using the [▼]/[▲] keys.

STATUS CHECK

Press the assigned programmable key to check the 5-Tone receive status code. When you press this key, the LCD display will indicate the “message” corresponding to the receive status condition per the pre-defined status list.

SPEED DIAL

Your Dealer may have pre-programmed Auto-Dial telephone number memories into your radio.

To dial a number, press the assigned programmable key, then press the microphone’s numbered key corresponding to the Auto-Dial memory number list provided by your Dealer. The DTMF tones sent during the dialing sequence will be heard in the speaker.

HOME CHANNEL (HOME)

Press the assigned programmable key to recall the pre-defined Home group/channel. When you recall the Home group/channel, the “-H-” icon will appear on the LCD.

SELECTABLE TONE

Press the assigned programmable key to select a sub-audible tone (CTCSS/DCS) from the pre-defined tone table. You can operate the indicated sub-audible tone in Selectable Tone mode.

ADVANCED OPERATION

HORN ALERT

Press the assigned programmable key to turn the Horn Alert function “ON” or “OFF.” If you receive a call from the base station with 2-Tone, 5-Tone or DTMF signaling, horn alert will be activated and your vehicles horn will sound.

When you turn the Horn Alert “ON,” a tone will sound and the “” icon appears will appear on the display.

PUBLIC ADDRESS

Press the assigned programmable key to use the transceiver as a PA amplifier. When you enable this function, a tone sounds and “Public ADRS” will appear on the display. The public address can be used even while scanning and receiving a call.

EXT. ACC1

Press the assigned programmable key to toggle output port on “1” “on” and “off.”

EXT. ACC2

Press the assigned programmable key to toggle output port on “2” “on” and “off.”

DIRECT CH#1 TO DIRECT CH#4

Press the assigned programmable key to recall the Dealer pre-programmed channel directly.



REC/PLAY (VOICE STORAGE: OPTION)

This function, which requires the optional Voice Storage Unit, allows you to record and play back incoming receiver audio.

Recording:

Press the assigned Rec/Play programmable key for more than 1.5 seconds to toggle the recording feature “on” and “off.” If the incoming signal is being heard through the speaker when the recording feature is set to “on,” the received audio will be recorded. The last 2 minutes of incoming audio will be stored on a first-in, first-out basis.

Playback:

Press the assigned Rec/Play key *momentarily* to start playback. During playback, pressing then [] key lets you jump forward 8 seconds, while pressing the [] key lets you go back 8 seconds. To stop playback before the stored message is complete, press the [] key.

ADVANCED OPERATION

AF MIN VR

Press the assigned programmable key to reduce the audio output to the (lower) level programmed by your Dealer.

SET

Press the assigned programmable key to activate the “User Set” (Menu) Mode.

ADVANCED OPERATION

ARTS (Auto Range Transpond System)

This system is designed to inform you when you and another ARTS-equipped station are within communication range.

During ARTS operation, when the radio receives an incoming ARTS signal, a short beep will sound, and **“In”** (“In Service”) will be displayed on the sub-LCD. If you move out of range for more than two minutes, your radio senses that no signal has been received; a short triple-beep will sound, and **“Out”** (“Out of Service”) will be displayed on the Sub-LCD. If you subsequently move back into communication range, as soon as the other station transmits, a short beep will sound and **“In”** will be displayed again on the Sub-LCD.

DTMF Paging System

This system allows paging and selective calling, using DTMF tone sequences.

When your radio is paged by a station bearing a tone sequence which matches yours, your radio’s squelch will open and the alert will sound. The three-digit code of the station which paged you will be displayed on your radio’s LCD.

USER SET MODE

The **VX-4200** Series includes a “User Set” (Menu) Mode which allows the user to define or configure various settings, such as Squelch, Display contrast, etc. To activate the “User Set” (Menu) Mode:

- Press the programmable key assigned to the “**SET**” function.
- Select the User Set Mode item you wish to change using the [**P1**]/[**P2**] keys, then use the [**▼**]/[**▲**] keys to adjust the setting of the selected item.
- Press the [**P1**] or [**P2**] key to store the new configuration.
- Press [**A**] key to exit to normal operation.

DISPLAY	DESCRIPTION
1 SQL	Sets the Squelch Level.
2 SCN List	Select the “User” or “Dealer” Scan List.
3 BEEP	Enables/Disables the Key Beeper.
4 BELL	Enables/Disables the Bell function. (alert tone activated by incoming subaudible CTCSS/DCS tone)
5 Lighting	Enables/Disables the BUSY/TX LED.
6 Lock	Set the Control Key Lockout Configuration (Key/PTT/Key+PTT).
7 Group	Select the desired Channel Group.
8 SCAN	Engages/Disengages Scanning (same as the programmable [SCAN] key).
9 DW	Engages/Disengages Dual Watch (same as the programmable [DW] key).
10 TA	Engages/Disengages Talk Around (same as the programmable [TA] key).
11 Encrypt	Enables/Disables the disabling the Encryption Unit temporarily. ENB: Enables the disabling the Encryption Unit. DIS: Disables the disabling the Encryption Unit.
12 AF MinVR	Sets the minimum Audio Volume level.
13 Beep VR	Sets the Beep Volume level.
14 Contrast	Sets the LCD Contrast level.
15 Dimmer	Sets the brightness of the backlighting of the key and LCD.
16 REC Mode	Select the Recording mode. ONE: Enables one-shot recording of audio for 120 seconds, with playback from beginning of the message. ROL: Enables rolling recording so long as the receiver is passing audio, with playback of the last 120 seconds recorded.
17 Play Mode	Set the priority system audio during recorder playback. PLY: The recorded audio is higher priority than the received signals audio. SIG: The received signal’s audio is higher priority than the playback audio.

Notes:

Menu items “16 REC Mode” and “17 PlayMode” will appear only when the optional Voice Storage Unit is installed.

When Menu item “11 Encrypt” is set to “DIS” without having the optional Voice Scrambler Unit installed, the encryption function will never be activated.

OPTIONAL ACCESSORIES

FVP-25	Encryption/DTMF Pager Unit
FVP-35	Encryption Unit
DVS-5	Voice Storage Unit
VTP-50	VX-Trunk Unit
FP-1023A	External Power Supply
MLS-100	Mobile Loudspeaker (12 W Peak Power)
LF-1	Line Filter
MH-700D	DTMF Back-lit Microphone
MH-25A8J	Microphone
MD-11A8J	Desktop Microphone
VPL-1	Programming Kit

Availability of accessories may vary; some accessories are supplied standard per local requirements, others may be unavailable in some regions.

Check with your VERTEX STANDARD Dealer for changes to this list.

Part 15.21: Changes or modifications to this device not expressly approved by Vertex Standard could void the user's authorization to operate this device.



Copyright 2003
VERTEX STANDARD CO., LTD.
All rights reserved.

No portion of this manual
may be reproduced
without the permission of
VERTEX STANDARD CO., LTD.

Printed in Japan

0308p-CE

