

***YAESU***

***The radio***

**C4FM FDMA 144/430 MHz**  
**DUAL BAND DIGITAL TRANSCEIVER**

***FT1DR***

**OPERATING MANUAL**

**YAESU MUSEN CO., LTD.**

Tennozu Parkside Building  
2-5-8 Higashi-Shinagawa, Shinagawa-ku, Tokyo 140-0002 Japan

**YAESU USA**

6125 Phyllis Drive, Cypress, CA 90630, U.S.A.

**YAESU UK LTD.**

Unit 12, Sun Valley Business Park, Winnall Close  
Winchester, Hampshire, SO23 0LB, U.K.

**YAESU HK LTD.**

Unit 1306-1308, 13F., Millennium City 2, 378 Kwun Tong Road,  
Kwun Tong, Kowloon, Hong Kong

## Contents

<b>Before Reading This Manual</b> .....	<b>2</b>	Recalling a Memory Channel.....	41
Introduction.....	4	Recalling the Home Channel .....	42
Features of FT1DR .....	4	Returning to the Previous Frequency.....	42
How to Read This Manual.....	5	Deleting the Memory Channel .....	42
Checking Bundled Items.....	5	Restoring the Deleted Memory Channel .....	43
Safety Precautions (Be Sure to Read) .....	6	Using Memory Banks .....	43
Names and Functions of Controls .....	12	Registering a Memory Channel in a Memory Bank.....	44
<b>Basic Operation</b> .....	<b>15</b>	Recalling a Memory Bank.....	44
Preparation .....	15	Canceling Memory Channel Registration in a Memory Bank .....	45
Installing the Antenna.....	15	Convenient Special Banks .....	45
Attaching the Supplied Belt Clip/Protective Cap .....	15	Registering Your Favorite Special Memory Channels in a Memory Bank.....	45
Attaching the Protective Cap.....	15	Recalling a Special Bank to Listen to the JR Railway Radio.....	46
Installing the Belt Clip.....	15	Recalling a Special Bank to Listen to the International VHF (Marine) Radio .....	46
Attaching a Hand Strap.....	16	<b>Scanning Function</b> .....	<b>48</b>
How to Use the Battery Case (FBA-39) (Option) .....	16	Using the Scanning Function.....	48
Installing/Removing the Battery Pack.....	17	VFO Scan .....	48
Installing the Battery Pack.....	17	Canceling Scanning .....	49
Removing the Battery Pack.....	17	Skipping a Frequency You Do Not Want Scan (Skip Search Memory) .....	49
Charging the Battery Pack.....	18	Specifying the Frequency You Do Not Want to Scan .....	50
Connecting an External Power Supply for Use in Vehicle .....	20	Deleting a Frequency Saved in the Skip Search Memory .....	50
Connecting to an External Power Supply Using a Power Cable .....	21	Selecting a Reception Method When Scanning Stops .....	51
Communication.....	23	Memory Scanning.....	51
Turning on the Power.....	23	Specifying a Skip/Selected Memory Channel .....	53
Adjusting the Volume Level.....	24	Scanning Only the Selected Memory Channel .....	54
Selecting an Operating Band.....	25	Scanning a Memory Bank.....	54
Selecting a Frequency Band.....	27	Memory Bank Link Scan .....	55
Tuning in to a Frequency.....	28	Programmable Memory Scan (PMS).....	56
Performing Communication .....	29	Writing into a Programmable Memory.....	56
Listening to the Radio.....	30	Performing Programmable Memory Scan.....	56
Listening to an AM or FM Broadcast.....	30	Using the Search Function.....	57
To deactivate the radio function .....	31	Spectrum Scope   Searching for a Signal	
To scan through the radio band.....	31	Using a Signal Strength Graph .....	57
Switching between AM Antennas.....	31	<b>Using the GPS Function</b> .....	<b>58</b>
Miscellaneous Settings.....	32	What is GPS?.....	58
Setting the Date and Time .....	32	Activating the GPS Function.....	58
Setting the Time Signal.....	33	Method of Positioning by GPS.....	59
Muting Audio .....	33	Explanation of GPS Screen and Operation.....	61
Changing the Transmission Power Level.....	34	BACK TRACK Function.....	62
Adjusting the Squelch Level.....	35	Causing the FT1DR to Memorize the Current Point.....	62
Changing the Frequency Step Manually.....	35	Using the BACK TRACK Function.....	63
Changing the Mode Manually .....	36	Description of the BACK TRACK Function Screen .....	63
Locking keys or switches .....	37		
Restoring to Defaults (All Reset).....	37		
<b>Repeater Operation</b> .....	<b>38</b>		
Repeater Operation .....	38		
Communicating Via the Repeater .....	38		
<b>Using the Memory</b> .....	<b>39</b>		
A Wide Variety of Memory Functions.....	39		
Writing into the Memory.....	40		
Split Memory.....	41		

**Useful Functions ..... 64**

Dual Reception (DW) Functions..... 64

    Dial Dual Reception

    VFO mode → Priority memory channel ..... 64

    Memory Dual Reception

    Memory channel → Priority memory channel ..... 65

    Home Channel Dual Reception

    Home channel → Priority memory channel ..... 65

Using the DTMF Function..... 66

    Confirming the Entered DTMF Code by the

    Sound ..... 67

    Sending the Registered DTMF Code..... 67

    Sending a DTMF Code Manually..... 68

**Communicating with a Specific Remote Station ..... 69**

Using the Tone Squelch Function ..... 69

    Selecting a Tone Frequency..... 70

    Selecting a DCS Code ..... 71

    Searching for the Frequency of the DCS Used

    by the Remote Station..... 72

Notification of Call from the Remote Station by

Vibration of the Vibrator ..... 73

    Selecting a Vibrator Operation Mode ..... 73

Notification of Call from a Remote Station by the

Bell Bell Function ..... 74

    Changing the Number of Times the Bell

    Rings ..... 75

Calling Only a Specific Station New Pager

Function ..... 75

    Flow of Operation to Use the Pager Function

    ..... 76

    Setting the Code of Your Station ..... 76

    Turning on the New Pager Function..... 77

    Calling a Specific Station ..... 77

    Being Called by the Remote Station

    (Standby Operation)..... 78

**Functions Used As Needed ..... 79**

Set Mode ..... 79

    Selecting Set Mode Items..... 79

    Resetting the Set Mode Items..... 79

Set Mode Item List ..... 80

**FT1DR Specifications..... 87**

## Introduction

### Features of FT1DR





- Digital communication (C4FM (Quaternary FSK), FDMA system)..... 000
- External power supply terminal..... 000
- Reception on two different bands + Reception on two identical bands (V+V/U+U). 000
- Independent switching keys for A-band and B-band and TX/BUSY display ..... 000
- Wide-band reception over the range of 500 kHz to 999.900 MHz ..... 000
- Waterproofing design 20 conforming to IPX5, which protects the FT1DR from rain and splashes..... 000
- Independent side keys, a full keyboard for easy entry of data, and a tilted main dial. .... 000
- Easy-to-see dot matrix display..... 000
- Ready for WiRES-II and WiRES-X connection (realized by the incorporated 64-channel WiRES-II access memory).....Refer to CD-ROM.
- Large-capacity 1327 ch memory and twenty-four 100 ch memory banks ..... 000
- Display of a memory tag comprising up to 16 one-byte characters ..... 000
- Special banks for easy reception ..... 000  
 Just by selecting preset frequencies, you can receive AM/FM, shortwave broadcast, international VHF radios with ease. .... 000
- A wide variety of scan functions..... 000
- Built-in GPS unit allowing display of your current location and heading information ..... 000
- Ready for APRS® communication through use of world standard 1200/ 9600bps AX25 modem (B-band only)..... See CD-ROM.
- High-resolution spectrum scope function for ±50 channels ..... 000
- A variety of individual calling functions such as tone squelch (CTCSS) and DCS functions ..... 000
- Vibrator for informing you of signal reception in addition to the bell ..... 000
- New pager function for calling only specific stations..... 000
- Illumination by white LED for easy viewing of the LCD outdoors ..... 000
- Built-in temperature sensor..... 000
- Battery save function for prolonging the operating time of the battery..... 000
- Data terminal for data communication with external equipment or firmware update ..... 000
- Build-in bar antenna for AM reception ..... 000
- Ready for micro SD ..... 000
- Snapshot function (an optional camera microphone MH-85A11U is required) ..... See CD-ROM.

## How to Read This Manual

Typical explanatory expressions used in this manual are as follows:

Press the  key briefly.

Press and hold the  key for over 1 second.

 →  ... (Press the  key, and then press the  key.)

While pressing the  key, turn the  knob.

### Precaution



...Explains notes to follow during operation.

### Hint



...Explains operating suggestions or useful hints.

## Checking Bundled Items

Main unit



Antenna

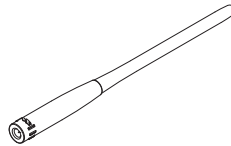

Battery pack (FNB-101LI)

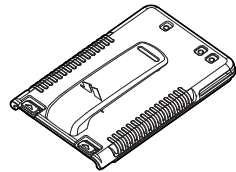

Battery charger (PA-48)

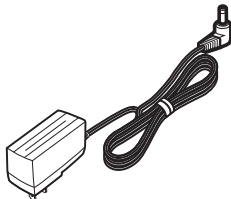

Belt clip

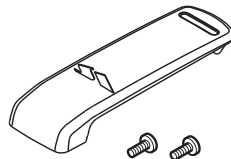

Protective plate for battery pack



- Operating Instruction (this manual)
- Warranty

### Notes

- Make sure that the name of the shop from which you purchased the product and the date of purchase are indicated on the warranty card.
- If any item is missing, contact the shop from which you purchased the product.

**Safety Precautions (Be Sure to Read)**

**Be sure to read the safety precautions to use this product safely.**

We are not liable for failures and other problems caused due to misuse or use of this product by you or a third party as well as the damages caused through use of this product by you or a third party except in the case where we are ordered to pay for damages under the laws.



**Types and Meanings of Symbols**



 **DANGER** Indicates an imminently hazardous situation which, if not avoided, could result in death or serious injury.

 **WARNING** Indicates a potentially hazardous situation which, if not avoided, could result in death or serious injury.

 **CAUTION** Indicates a potentially hazardous situation which, if not avoided, may result in minor or moderate injury or only property damage.

**Types and Meanings of Legends**

 Indicates a prohibited item not to be done in order to use this product safely. For example,  indicates that the product should not be disassembled.

 Indicates an obliged item to be done in order to use this product safely. For example,  indicates that the power plug should be removed.

|||||  **DANGER** |||||

 **Do not use this product in "an area where use of it is prohibited", e.g., inside the hospital, airplane, or train."**  
This product can affect electronic or medical devices.

 **Do not use this product while riding a bicycle or driving a car. Accidents can result.**  
Be sure to stop the bicycle or car at a safe place before using this product.

**Those who are carrying a medical device such as a cardiac pacemaker should not perform transmission near it. When performing transmission, use an external antenna and keep away from the external antenna as far as possible.**  
The radio wave emitted from this product can cause the medical device to malfunction and result in an accident.

 **Do not use this product or the battery charger in a place where inflammable gas is generated.**  
A fire or explosion can occur.

Before Reading This Manual

**Safety Precautions (Be Sure to Read)**

 **Do not perform transmission in a crowded place for the safety of the persons carrying a medical device such as a cardiac pacemaker.**  
The radio wave emitted from this product can cause the medical device to malfunction and result in an accident.

 **Do not touch the liquid leaking from the battery pack with bare hands.**  
The liquid that has stuck to your skin or entered in your eye can cause chemical burn. In such a case, consult the doctor immediately.

 **Do not solder or short-circuit the terminal of the battery pack.**  
A fire, leak, overheating, explosion, or ignition can result.  
Do not carry the battery pack together with a necklace or hair pin. A short circuit can result.

 **If it starts thundering when the external antenna is used, immediately turn off this product and disconnect the external antenna from it.**  
A fire, electrical shock, failure can result.

|||||  **WARNING** |||||

 **Do not use this product at a voltage other than the specified power supply voltage.**  
A fire or electric shock can result.

 **Do not use the battery pack for any model other than the specified mode.**  
A fire, leak, overheating, explosion, or ignition can result.

 **This product has a waterproof structure and conforms to "IPX5" when the included antenna and battery pack are installed and rubber caps are securely attached to the MIC/SP jack, EXTDC IN jack, DATA terminal, and micro SD slot. If this product gets wet, wipe it with a dry cloth, etc. without leaving it as it is.**  
Leaving this product in a wet condition can degrade its performance, shorten its life, or cause a failure or electrical shock.

 **Do not perform transmission for a long period.**  
The main body can overheat, resulting in a failure or burn.

 **Do not disassemble or make any alteration to this product.**  
An injury, electric shock, or failure can result.

 **Do not handle the battery pack or charger with wet hands. Do not insert or remove the power plug with wet hands.**  
An injury, leak, fire, or failure can result.

 **If smoke or strange odor is emitted from the main body, battery pack, or battery charger, immediately turn off this product, remove the battery pack, and remove the power plug from the outlet.**  
A fire, leak, overheating, damage, ignition, or failure can result. Contact the shop from which you purchased this product or our Amateur Customer Support.

 **Do not use the battery pack which is externally damaged or deformed.**  
A fire, leak, hating, explosion, or ignition can result.

 **Do not use any battery charger which is not specified by us.**  
A fire or failure can result.

 **Keep the terminals of the battery pack clean.**  
If stained, a fire, leak, overheating, explosion, or ignition can result.

## Safety Precautions (Be Sure to Read)



If charging of the battery pack cannot be completed after lapse of the specified time, immediately remove the power plug of the battery charger from the outlet.

A fire, leak, overheating, explosion, or ignition can result.



## CAUTION



**Do not dangle or throw this product by holding its antenna.**

This product can hit and injure someone. In addition, doing so can result in a main body failure or damage.



**Do not use this product in a crowded place.**

The antenna can hit someone, resulting in an injury.



**Do not place this product in a place subject to direct sunlight or near a heater.**

This product can deform or discolor.



**Do not place this product in a humid or dusty place.**

A fire or failure can result.



**During transmission, keep the antenna away from you as far as possible.**

Long-time exposure to electromagnetic waves can have a negative impact on your health.



**Do not clean the case with thinner or benzene.**

Use a soft, dry cloth to clean the case.



**If you do not use this product for a long period, turn it off and remove the battery pack for safety.**



**Do not give a strong shock to or throw this product.**

A failure can result.



**Keep magnetic cards and video tape away from this product.**

The data recorded on cash cards or video tape can be erased.



**Do not use the earpiece microphone, earphones, or headphones at an extremely high volume level.**

Hearing impairment can result.



**Keep this product out of reach of children.**

An injury, etc. can result.



**Install the hand strap and belt click securely.**

If they are installed improperly, they can fall down, resulting in an injury or damage.



**Do not place a heavy thing on the power cord of the battery charger.**

The battery cord can be damaged, resulting in a fire or electric shock.



**Do not use the included battery charger to charge any battery pack which is not specified by us.**

A fire can result.



**Do not perform transmission near the TV or radio.**

Radio disturbance can occur in this product, TV, or radio.



**Do not use any products other than the options specified by us.**

A failure can result.



**When the battery charger is not in use, remove its power plug from the outlet**



## Safety Precautions (Be Sure to Read)

**Charge the battery pack within the temperature range from 5°C to 35°C.**



Charging the battery pack outside this temperature range can cause leak, overheating, decrease in performance, or reduction in service life can result.

**When unplugging the power cord of the battery charger, be sure to hold the power plug.**



Pulling the power cord can damage it and cause a fire or electronic shock.



**Before discarding the worn battery pack, affix tape or the like to its terminals.**

**When using this product in a hybrid or fuel-saving car, be sure to check with the automobile manufacturer if the it can be used in that car.**



Noise generated by an onboard electrical device (inverter, etc.) can disable normal reception by this product.

## Safety Precautions (Be Sure to Read)

### About Waterproofing Feature Conforming to IPX5

When the included antenna and battery pack are installed and the MIC/SP jack, EXT DC IN jack, DATA terminal, and micro SD slot are securely covered with rubber caps, this product can withstand continuous 30-minute immersion in water at depth of 1 m. To ensure this waterproofing feature, be sure to check the following points before use.

○ **Check for damages, deterioration, and dirt.**

Antenna rubber, key switch rubber, MIC/SP jack, EXT DC IN jack, DATA terminal, micro SD slot rubber cap, and battery pack joint.

○ **Cleaning**

When this product is contaminated with seawater, sand, or dirt, rinse with fresh water, and then wipe with a dry cloth immediately.

○ **Recommended maintenance interval**

It is recommended that you ask for maintenance of this product when one year has passed since purchase or previous maintenance or when any damage or deterioration is found. Note that the maintenance service is subject to fees.

○ **Do not immerse this product in the following liquids:**

Sea, pool, hot spring, water containing soap, detergent, or bath additive, alcohol, or chemicals

○ **Do not leave this product for a long time in the following places:**

Bathroom, kitchen, or humid place

○ **Other precautions**

Since this product is not totally waterproof, it cannot be used in water.

If you are informed that the radio waves emitted from your amateur station are interfering with reception by the TV, radio, etc., of a neighbor, you should stop emitting the radio waves and check whether any problem of interference and its degree if it exists.

## Names and Functions of Controls

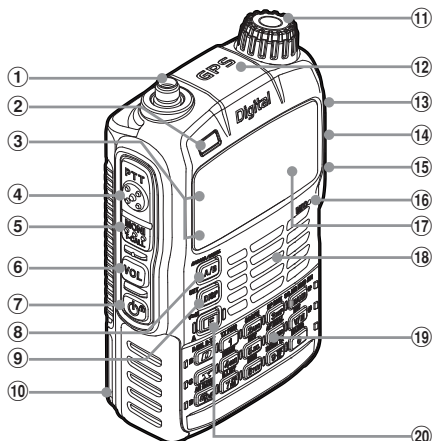

















①	<b>Antenna terminal (SMA)*</b>
②	<b>Flashlight (White LED)</b> • This LED can be used as a small flashlight in a dark place.
③	<b>A-band BUSY/TX lamp</b> <b>B-band BUSY/TX lamp</b> These lamps glow green during reception, and glow red during transmission.
④	<b>PTT switch</b> • Press and hold the  switch during transmission.
⑤	<b>MONI T.CALC switch</b> • Press and hold the  switch to deactivate the squelch function. • While pressing the  key and  switch, turn the  knob to adjust the squelch level.
⑥	<b>VOL switch</b> While pressing the  key, turn the  knob to adjust the volume level.
⑦	<b>Power switch</b> • Press and hold the  switch over 1 second to turn on the FT-D1. • Press and hold the  switch over 1 second again to turn off the FT-D1. • Press the  switch briefly to lock keys.
⑧	<b>MONODUAL (A/B) key (switching between operating bands)</b> • Pressing the  key briefly toggles between A-band and B-band. • Press and hold the  key over 1 second to change the Dual Band Reception mode to the Mono Band Reception mode. • While operating the FT-D1 in the Mono Band Reception mode, press the  key and then press the  key briefly to enlarge the display.

⑨	<b>SET (DISP) key</b> • Pressing the  key switches among display modes (frequency → APRS → and GPS). • Press the hold the  key over 1 second to call the Set mode.
⑩	<b>Battery pack*</b>
⑪	<b>DIAL knob</b> Turn this knob to change frequencies or select a memory channel.
⑫	<b>GPS antenna</b>
⑬	<b>MIC/SP jack*</b> Connect a speaker microphone or earpiece microphone to this jack. It is not waterproofed when an external microphone is connected. Do not connect any product which is not specified by us. A failure can result.
⑭	<b>EXT DC IN jack*</b> • Connect an external power supply adapter with a cigarette lighter plug (E-DC-5B) or an external power cable (E-DC-6) to this jack. • When charging the battery pack, connect the battery charger (PA-48) to this jack. Do not connect any product which is not specified by us. A failure can result.
⑮	<b>DATA terminal*</b> • Use this terminal when using a clone function or updating the firmware. • Connect the optional camera-equipped microphone (MH-85A11U). • For how to update the firmware, access our home page.
⑯	<b>Microphone</b>
⑰	<b>Display</b> This LCD displays reception frequencies and various settings.
⑱	<b>Speaker</b>
⑲	<b>15 keys</b> These keys are used to specify reception/transmission frequencies and select functions.
⑳	<b>V.M (V.M) switch</b> • Press the  key briefly to activate function keys. • Press and hold the  key over 1 second to write a frequency in the memory.

\* When the included antenna and battery pack are installed and the MIC/SP jack, EXT DC IN jack, DATA terminal, and micro SD slot are securely covered with rubber caps, the FT-D1 can deliver the waterproofing performance conforming to IPX5 (See page 10).

## Names and Functions of Controls

Key	When pressed briefly		When pressed and held over 1 second	When a key is pressed after the  switch is pressed
	When entering a frequency or calling a memory CH	When inputting a tag		
 DSEL D.TX	Switches between radio wave types.	Moves the cursor to the left.	Selects SD card data.	Sends the selected SD card data.
 WiRES-X	Turns on/off the WiRES-X function.	—	—	—
 AR DATA	Turns on/off the GSM function.	—	Manipulates member data.	—
 TX PWR	Number “1”	Number “1”	—	Switches between transmission power levels.
 SCOPE	Number “2”	Number “2” or letter “A”, “B”, “C”, “a”, “b”, or “c”	—	Selects the spectrum cope function.
 SP BNK	Number “3”	Number “3” or letter “D”, “E”, or “F”, “d”, “e”, or “f”	—	Selects the special bank function.
 HOME	Number “4”	Number “4” or letter “G”, “H”, or “I”, “g”, “h”, or “i”	—	Selects the home channel.
 REV	Number “5”	Number “5” or letter “J”, “K”, or “L”, “j”, “k”, or “l”	—	Selects a reversal function.
 AF DUAL	Number “6”	Number “6” or letter “M”, “N”, or “O”, “m”, “n”, or “o”	—	Selects the AF DUAL function.
 S. LIST	Number “7”	Number “7” or letter “P”, “Q”, “R”, or “S”, “p”, “q”, “r”, or “s”	—	Displays a station list.
 MSG	Number “8”	Number “8” or letter “T”, “U”, or “V”, “t”, “u”, or “v”	—	Displays a digital list.
 BCON TX	Number “9”	Number “9” or letter “W”, “X”, “Y”, or “Z”, “w”, “x”, “y”, or “z”	—	Selects a beacon text.
 RADIO	Number “0”	Number “0”	—	Receives the AM/FM radio band.
 SC.MD BAND DN	Increases the frequency.	Moves the cursor to the right.	Selects the scan function.	Decreases the frequency.
 DW	Switches between the VFO mode and Memory mode.	Switches between letter types.	—	Selects the dual watch function.

Before Reading This Manual

## Names and Functions of Controls

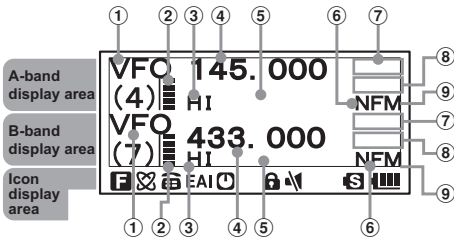

- ① Displays choice of the VFO mode or MR (memory) mode.
- ② Displays a sound volume bar graph.
- ③ Displays a transmission power level icon.
- ④ Displays an operating frequency.
- ⑤ S meter: Displays the radio wave strength in 9 steps.  
PO meter: Displays the transmission power level in 4 steps.  
H I: High power (5 W) ⑤  
L 3: LOW 3 power (2.5 W) ③  
L 2: LOW 2 power (1 W) ②  
L 1: LOW 1 power (0.05 W) ①
- ⑥ Displays the operating mode (radio wave type).

- ⑦ Displays a squelch type (See page 136).  
**TN:** Stays lit when the tone encoder function is active.
- TSQ:** Stays lit when the tone squelch function is active.
- DCS:** Stays lit when the DCS function is active.
- RTN:** Stays lit when the reverse tone function is active.
- PAG:** Stays lit when the pager is active.
- MSG:** Stays on when the message function is active.  
Displays the APRS baud rate (See page 71).
- ⑧ Displays a shift direction during repeater operation. (See page 30)
  - Minus shift
  - Plus shift
  - Split operation
  - is displayed when the bell alarm function is active (See page 140).
- ⑨ Displayed when the vibrator function is active.  
Solid line (—):  
BUSY vibrator function (See page 139)  
Dashed line:  
SIGNALING vibrator function (See page 139)  
Short dashed line (----):  
APRS MSG vibrator function (See page 96)

## Icons

Icon	Description
	Lights when a function key is pressed.
	Stays lit during internet communication such as WiRES (See page 31).
	Stays lit when the DTMF function is active (See page 36, 130).
	Stays lit when the APO function is active (See page 150).
	Stays lit when the LOCK function is active (See page 29).
	Stays lit when the MUTE function is active (See page 27).
	Stays lit when a micro SD memory card is inserted.

Icon	Description
H I	Displays the transmission power level (See page 27). H I: High power (5W) L 3: LOW 3 power (2.5W) L 2: LOW 2 power (1W) L 1: LOW 1 power (0.05W)
	Displays the battery charge level. : Enough battery power : Low battery power : Poor battery power. : Charge battery. : Charge battery immediately (blink).

## Preparation

### Installing the Antenna

- 1 Align the antenna with the antenna terminal on the main unit.  
**Note** Be sure to hold the thick root of the antenna when installing it.
- 2 Turn the antenna clockwise until it is secured.

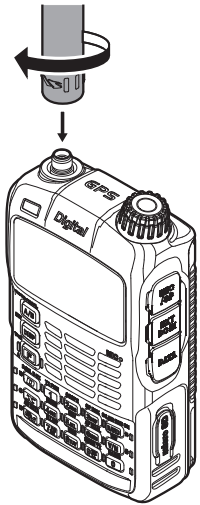

#### Precaution

- Do not hold the upper part of the antenna when installing or removing it. Breaking of wire can occur inside the antenna.
- Do not transmit without installing the antenna. The transmitter circuit can be damaged.
- When using an detachable antenna other than the supplied one or any other external antenna, ensure that its SWR is adjusted to 1.5 or lower.

### Attaching the Supplied Belt Clip/Protective Cap

#### Attaching the Protective Cap

- 1 Attaching the Protective Cap  
 If you do not use the belt clip, attach the protective cap to the belt clip attaching opening.

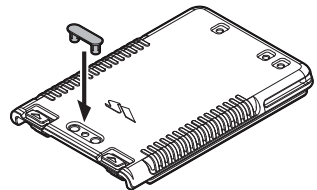

#### Installing the Belt Clip

- 1 Turn over the battery pack.
- 2 Install the belt clip using the supplied screws (two).

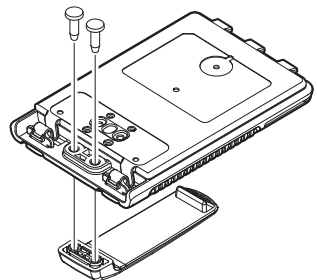

#### Precaution

- Be sure to use the supplied screws when installing the belt clip. Using any other screws can result in injury, damage to parts, and other troubles.
- Be sure to install the protective cap when the belt clip is not used.

## Preparation

### Attaching a Hand Strap

If you attach a hand strap to the FT1DR, its string which is inserted in and secured to the strap hole in the transceiver must have a diameter of 1 mm.

\* The hand strap does not come with the FT1DR.

- 1 Remove the battery pack.
- 2 Attach the hand strap.

### Precaution

Use a hand strap which can stand the weight of the FT1DR.  
If you use a hand strap which is not strong enough, the hand strap can break and the FT1DR can fall down, resulting in injury, damage to parts, and other troubles.

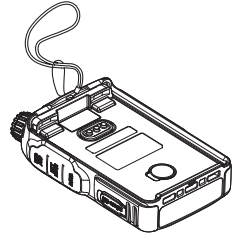

### How to Use the Battery Case (FBA-39) (Option)

The optional battery case (FBA-39) allows three AA Alkaline batteries to be used as a power supply.

### Hint

When the battery case (FBA-39) is used, you can select a power output level from:  
Low Power (L1): 0.05 W  
Low Power (L2): 1W  
Note that Low Power (L3) and High Power are not available.

- 1 Open the cover.  
Lift up the lower right corner indicated by the hand pointer in the illustration.
- 2 Put alkaline batteries in the battery case.  
**Note** Use three alkaline batteries. Pay attention to polarities (+ and -) of the alkaline batteries.
- 3 Close the cover.  
Push hard four corners of the cover to close it tightly.

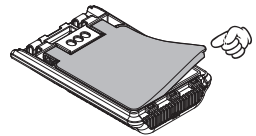

### Hint

When the batteries become weak,  is displayed on the LCD. When the batteries become far weaker,  blinks on the LCD.

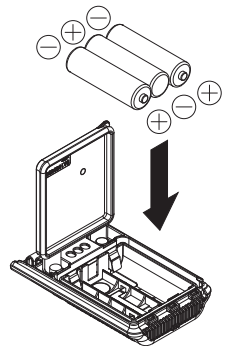



### Precaution

- Manganese batteries cannot be used. Rechargeable AA batteries cannot be used, either.
- Do not use new batteries along with old batteries. The life of new batteries can decrease.
- If you do not use the FT1DR for a long period, remove the batteries from the battery case.
- If the terminal or electrode of the battery case is dirty, the FT1DR can malfunction due to poor contact, resulting in overheating or explosion. If the terminal or electrode gets dirty, clean it using a dry cloth or cotton swab.

## Installing/Removing the Battery Pack

### Installing the Battery Pack

- 1 Insert the bottom tabs of the battery in the slots at the bottom of the FT1DR.
- 2 Push in the lock knobs until they click.

### Precaution

When you use the FT1DR for the first time after purchase or you have not used it for a long period, charge the battery pack before use.

Lock knobs

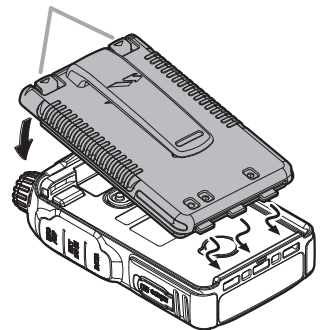

### Removing the Battery Pack

- 1 While pushing down the lock knobs, remove the battery pack.  
Push down the lock knobs in the direction of the arrow shown in the illustration.

Push down the lock knobs in the direction of the arrow.

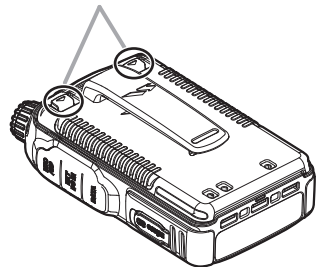

### Precaution

When releasing the lock knobs, be careful not to hurt your fingers and nails.

## Preparation

### Charging the Battery Pack

#### Precaution

- The battery pack is rechargeable about 300 times. However, improper use such as overcharge or over-discharge can shorten its life.
- The battery pack is a consumable item. Recharging the battery pack repeatedly will gradually shorten the time until its power becomes low.
- If the FT1DR is not used for a long period with the battery pack installed, deterioration of the battery pack can accelerate.
- If you do not use the FT1DR for a long period, be sure to store it with the battery pack removed. Even if you do not use the FT1DR for a long period, install the battery pack biannually and recharge the battery pack about 50%.
- Storing the battery pack in a high-temperature place can deteriorate it faster than usual. Store the battery pack in a place where the ambient temperature is  $-20^{\circ}\text{C}$  to  $+50^{\circ}\text{C}$ .
- Do not drop or give a strong shock to the battery pack. It can break.

#### Hints

- The battery pack contains lithium-ion batteries that can be recharged for repetitive use.
- The FT1DR can be used with either of the following battery packs:
  - (1) Accessory: FNB-101L (1 7.4 V, 1100 mAh)
  - (2) Option: FNB-102L (1 7.4 V, 1800 mAh)
- When the battery pack is recharged, its output voltage (about 8 V) becomes higher than the specified value (7.4 V). This is not a failure.

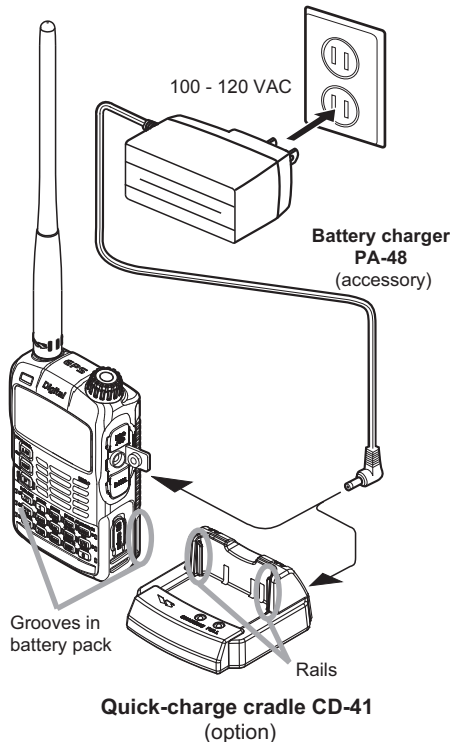

## Preparation

- 1 Install the battery pack.
- 2 Turn off the FT1DR.
- 3 Insert the plug of the battery charger (PA-48A) in the EXT DC IN jack of the FT1DR.

Charging starts.

The  lamp glows red and "CHARGING" is displayed on the LCD.

The charge level is indicated by a bar graph.

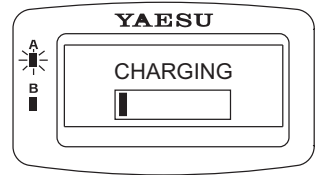

It takes about 5 hours to charge the battery pack fully.

When charging is completed, "COMPLETE" is displayed on the LCD and the  lamp glows green.

**Supplement** • It takes about 8 hours to charge the FNB-102LI (option).

- The optional quick-charge cradle (CD-41) requires about 2.5 hours to charge the supplied battery pack (about 4 hours to charge the optional battery pack FNB-102LI).

Place the FT1DR on the cradle with the rails of the cradle fit in the grooves in the battery pack.

When charging the battery pack using the cradle, the LED on the cradle indicate the state of charging.

During charging: Red glow → Fast blink → Slow blink

Completion of charging: Green glow



- 4 Remove the plug of the battery charger from the jack of the FT1DR.

### Precaution

- Neither transmission nor reception can be performed while charging the battery pack using the supplied battery charger.
- During charging, noise may be generated in the nearby TV or radio.  
Charge the battery pack with the battery charger away from the TV or radio as far as possible.
- If "BATTERY NOT INSTALLED" is displayed on the LCD and the battery pack cannot be charged after lapse of 11 or more hours, stop charging the battery pack immediately.  
If the same message is displayed again, the battery pack is presumably at the end of its life or defective.  
If so, replace the battery pack with a new one.
- While charging the battery pack, protect the FT1DR from splash of water.
- Charge the battery pack in a place where the ambient temperature is +5°C to +35°C.
- If the terminal or electrode of the battery case is dirty, the FT1DR can malfunction due to poor contact, resulting in overheating or explosion. If the terminal or electrode gets dirty, clean it using a dry cloth or cotton swab.

### Hints

- The battery charger may become hot during charging. This is not a failure.
- If  flashes, the battery pack charge is depleted. Charge it immediately.

## Preparation

### Approximate Operating Hours and Remaining Charge Level Indication

Approximate hours during which the fully charged battery pack or three new AA alkaline batteries can operate the FT1DR are as follows:

Band		Battery pack FNB-101LI	Battery pack FNB-102LI	Batter case FBA-39	Icon
Amateur radio band	144 MHz band	Approx. 5.0 hours	Approx. 8.5 hours	Approx. 17 hours	: Full battery power : Enough battery power : Low battery power : Poor battery power Charge battery. : Charge battery immediately. (Blink)
	430 MHz band	Approx. 5.0 hours	Approx. 8.0 hours	Approx. 16 hours	

**Remarks** Approximate hours are estimated assuming that the FT1DR is operated under the following conditions. Hours during which the FT1DR can be used actually vary depending on use conditions, ambient temperature, etc.

- The GPS function is deactivated.
- With an amateur radio band selected, a sequence in which high-power transmission is performed for 6 seconds, reception is performed for 6 seconds, and the standby operation is performed for 48 seconds is repeated.

### Connecting an External Power Supply for Use in Vehicle

The optional external power supply adapter with a cigarette lighter plug (E-DC-5B) allows the FT1DR to be used in a vehicle.

- 1 Turn off the FT1DR.
- 2 Insert the plug of the external power supply adapter with a cigarette lighter plug (E-DC-5B) in the EXT DC IN jack of the FT1DR.
- 3 Insert the cigarette lighter plug of the external power supply adapter with a cigarette lighter plug (E-DC-5B) in the cigarette lighter socket of the vehicle.

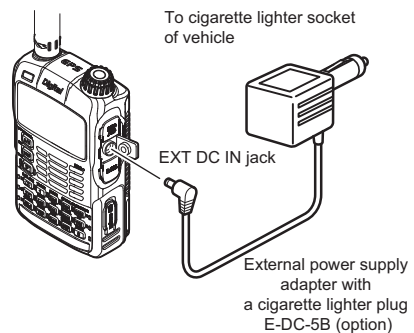

### Precaution

- The E-DC-5B is compatible with a 12 VDC cigarette lighter socket.  
Do not connect the E-DC-5B to the 24 VDC cigarette lighter socket.
- Use the FT1DR at the minimum required transmission power level to prevent overheating.
- Do not perform continuous transmission for a prolonged period. The FT1DR can overheat, resulting in a failure or burn.
- If you operate the FT1DR for 7 hours or longer, it is recommended that you remove the battery pack and install the optional battery case (FBA-39).
- Recharging the fully-charged battery pack repeatedly can shorten its life. Be extremely careful not to do so when you operate the FT1DR using an external power supply.
- While charging the battery pack, protect the FT1DR from splash of water.
- Charge the battery pack in a place where the ambient temperature is +5°C to +35°C.
- If the terminal or electrode of the battery case is dirty, the FT1DR can malfunction due to poor contact, resulting in overheating or rupture. If the terminal or electrode gets dirty, clean it using a dry cloth or cotton swab.

### Hints

- The external power supply requires about 5 hours to charge the battery pack (about 8 hours to charge the optional battery pack FNB-102LI). If the battery pack is charged with the FT1DR powered, the charging time increases slightly.
- When the battery pack has been charged fully, charging stops automatically.
- The external power supply can be used with the battery case installed.
- If you connect the FT1DR to the external power supply with it turned off, "CONNECTED TO EXTERNAL POWER" is displayed on the LCD, and about 20 seconds later "BATTERY NOT INSTALLED" is displayed.

## Connecting to an External Power Supply Using a Power Cable

The optional power cable (E-DC-6) allows the FT1DR to be connected to an external power supply.

- 1 Turn off the FT1DR.
- 2 Connect the optional external power supply cable (E-DC-6) to an external power supply.

**Remarks** • Connect the red/black wire or white/black wire to the positive (+) terminal of the external power supply, and connect the black wire to the negative (-) terminal.

- Set the voltage of the external power supply to 12-14 V.

- 3 Insert the plug of the external power supply in the EXT DC IN jack of the FT1DR.

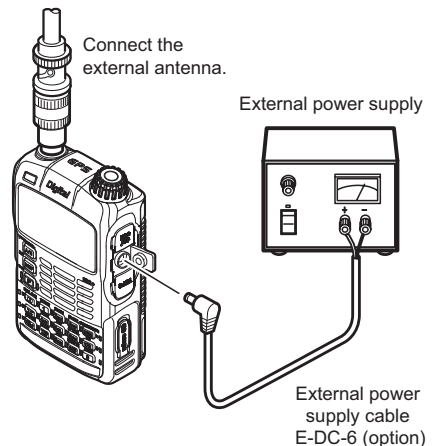

## Preparation

### Precautions

- When you use the FT1DR with the external power supply cable (E-DC-6) connected to an external power supply, pay attention to the following:
  - The power supply voltage must be 12 V to 14 V.  
If the voltage exceeds 14 V, the high voltage protection function is activated to disable high-power transmission. L3 (2.5 W) is selected automatically to reduce the transmission power.  
If the voltage exceeds 16 V, failures such as damage to the electric circuits of the FT1DR can result. Take extra care.
  - Connect the red/black wire or white/black wire of the external power supply cable (E-DC-6) to the positive (+) terminal of the external power supply, and connect the black wire to the negative (-) terminal.
  - Use an external power supply having sufficient current capacity (3 A or more).
  - If the supplied antenna remains installed, the external power supply can malfunction, resulting in a failure. If you use an external power supply, remove the supplied antenna and connect an external antenna. Place the external power supply sufficiently away from the FT1DR.
- Use the FT1DR at the minimum required transmission power level to prevent overheating.
- Do not continue transmission for a prolonged period. The FT1DR can overheat, resulting in a failure or burn.
- If you operate the FT1DR for 7 hours or longer, it is recommended that you remove the battery pack and install the optional battery case (FBA-39).
- Recharging the fully-charged battery pack repeatedly can shorten its life. Be extremely careful not to do so when you operate the FT1DR using an external power supply.
- While charging the battery pack, protect the FT1DR from splash of water.
- Charge the battery pack in a place where the ambient temperature is +5°C to +35°C.
- If the terminal or electrode of the battery case is dirty, the FT1DR can malfunction due to poor contact, resulting in overheating or explosion. If the terminal or electrode gets dirty, clean it using a dry cloth or cotton swab.

### Hints

- The external power supply requires about 5 hours to charge the battery pack (about 8 hours to charge the optional battery pack FNB-102LI). If the battery pack is charged with the FT1DR powered, the charging time increases slightly.
- The external power supply can be used with the battery case installed.  
In this case, "BATTERY NOT INSTALLED" is displayed on the LCD of the FT1DR; however, the FT1DR can be used, without any problem, with the battery case installed.
- If you connect the FT1DR to the external power supply with it turned off, "CONNECTED TO EXTERNAL POWER" is displayed on the LCD, and about 20 seconds later "BATTERY NOT INSTALLED" is displayed.

# Communication

Let's try communication using the FT1DR in the analog communication mode. Follow the procedure below.

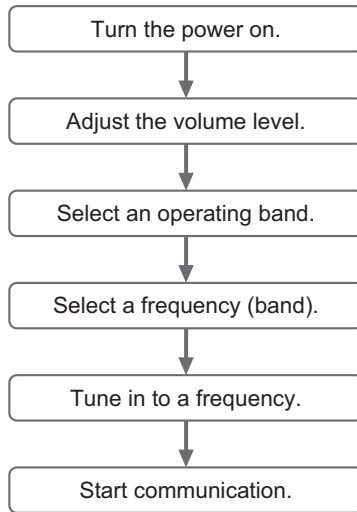

## Turning on the Power

- 1 Press and hold the  switch over 1 second.

An opening message is displayed, and then two frequencies (A-band frequency and B-band frequency) are displayed at the same time.

**Hints** You can change the information such as the power supply voltage and the opening message displayed at power-on. Press and hold the  key over 1 second to select the Set mode, and then select "1 DISPLAY" → "7 OPENING MESSAGE".

In addition, you can cause the FT1DR to display the reception frequency immediately without displaying the opening message (See page 154).





### ● Turning off the Power

To turn off the power, press and hold the  switch over 1 second.

Communication

## Adjusting the Volume Level

The FT1DR allows the volume level to be adjusted for the A-band and B-band separately.

- 1 Press the  key to select a band for which you want to adjust the volume level. Pressing the  key toggles between the A-band and B-band.
- 2 While pressing the  key, turn the  knob to adjust the volume level. The volume bar graph moves up/down while blinking.

**Supplement** If no sound is heard from the speaker, press the  key and then adjust the volume level while listening to white noise.

- 3 Release the  key. The Volume Level Adjustment mode is canceled.

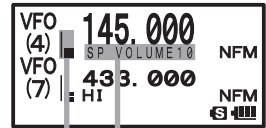
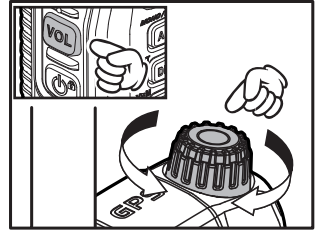

Volume bar graph blinks.

One of SP VOLUME 0 to SP VOLUME 32 is displayed.



## Selecting an Operating Band

The frequency displayed on the LCD in large letters is called an operating band.  
 Each operating band allows you change the frequency and perform transmission.

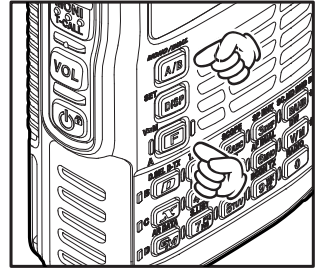

Pressing the <sup>MONO/DUAL</sup>(A/B) key briefly toggles between the information for A-band and the information for B-band.

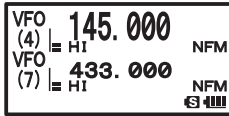
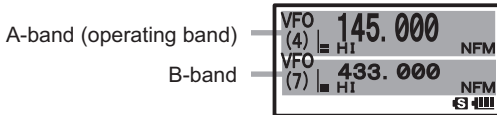

Press and hold the <sup>MONO/DUAL</sup>(A/B) key for about 1 second.

Press the <sup>MONO/DUAL</sup>(A/B) key briefly.

Press and hold the <sup>MONO/DUAL</sup>(A/B) key for about 1 second.

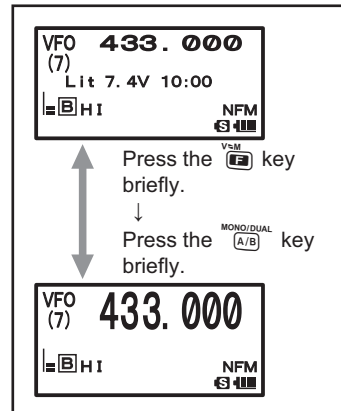
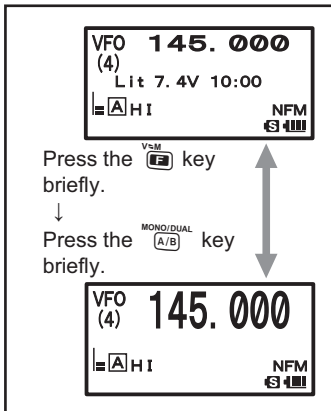

**Communication**

**Hints**

- The A-band allows you to perform communication using the following amateur radio bands.  
 144 MHz band, 430 MHz band  
 The A-band also allows you to perform reception using the following radio bands:  
 AIR band, INFO band (1), INFO band (2)
- The B-band allows you to perform communication using the following amateur radio bands.  
 144 MHz band, 430 MHz band  
 The B-band also allows you to perform reception using the following radio bands:  
 AIR band, INFO band (1)
- The number (1-9) corresponding to the selected frequency band is displayed on the LCD.  
 For the relationship between the numbers and frequency bands, see the following table:

**Reception frequencies of A-band and B-band**

Frequency band No.	A-band	B-band
(1)	1.8 MHz to 30 MHz (SW band)	--
(2)	30 MHz to 76 MHz (50 MHz band)	--
(3)	108 MHz to 137 MHz (AIR band)	108MHz to 137MHz (AIR band)
(4)	137 MHz to 174 MHz (144 MHz band)	137 MHz to 174 MHz (144 MHz band)
(5)	174 MHz to 222 MHz	174 MHz to 222 MHz
(6)	222 MHz to 420 MHz (INFO band (1))	222 MHz to 420 MHz (INFO band (1))
(7)	420 MHz to 470 MHz (430 MHz band)	420 MHz to 470 MHz (430 MHz band)
(8)	470 MHz to 770 MHz	470 MHz to 770 MHz
(9)	770 MHz to 999 MHz (INFO band (2))	--



- The A-band and B-band can be received at the same time.  
 You can receive an amateur radio frequency while listening to the AIR band, or receive two amateur radio frequencies on the same frequency band at the same time (V+V/U+U: Dual frequency reception on the same band).
- The sub-band operation function allows you to change the sub-band to the operating band during dual reception (See page 29).

**Communication**



## Selecting a Frequency Band

The FT1DR allows you to select a frequency band for the A-band and a frequency band for the B-band separately.

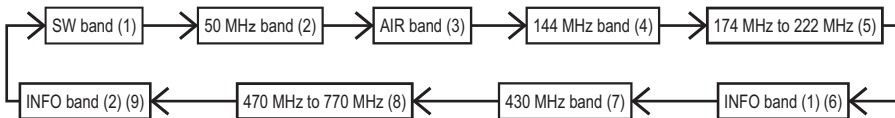

### ● Setting a Frequency Band for the A-band

- 1 Press the  key.  
 Select the A-band.
- 2 Press the  key briefly.  
 Select a frequency band.





**Hint** Pressing the  key briefly and then pressing the  briefly changes frequency bands in the reverse order.

### ● Selecting a Frequency Band for the B-band

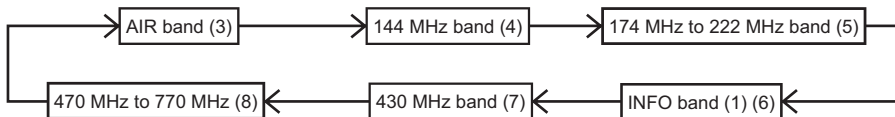
- 1 Press the  key.  
 Select the B-band.
- 2 Press the  key briefly.  
 Select a frequency band.



**Hint** Pressing the  key briefly and then pressing the  briefly changes frequency bands in the reverse order.



### Precaution

- Digital communication can be performed only on the A-band.  
 Digital communication cannot be performed on the B-band.

Basic Operation

## Communication

### Hints

- The number (one of 1-9) corresponding to the selected frequency band is displayed on the LCD. For the relationship between the numbers and the frequency bands, see the table shown on page 23.
- By default, the following frequencies are set.  
A-band: 145.000 MHz B-band: 433.000MHz
- By default, the Auto mode is selected such that it is switched to the mode ideal for the selected frequency band.  
You can change modes by pressing and holding the  key over 1 second and then selecting "2 TX/RX" → "1 MODE" → "5RX MODE" (See page 29).
- For the relationship between frequency bands and reception frequencies, see the table on page 11.
- Pressing the  key and then pressing the  key allows you to call the home channel of each frequency band (See page 40).

## Tuning in to a Frequency

Tune in to your desired frequency using either of the following methods:



- (1) Turn the  knob to tune in to your desired frequency.
- (2) Enter a frequency directly using numeric keys.

### ● Turning the knob to Tune in to a Desired Frequency

- 1 Select the VFO mode.
- 2 Turn the  knob to tune in to your desired frequency.

Clockwise turn: The frequency increases.

Counterclockwise turn: The frequency decreases.

**Hints** Pressing the  key briefly and turning the  knob allows you to set frequencies in steps of 1 MHz.

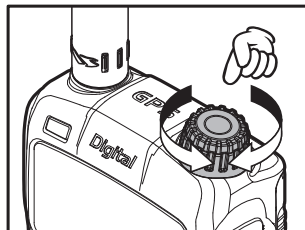

### ● Entering a Desired Frequency Directly Using Numeric Keys

- 1 Press the  key.  
The VOF mode is selected, allowing you to select a frequency.
- 2 Enter your desired frequency using numeric keys.

Example: To enter 145.520 MHz, press the following keys:



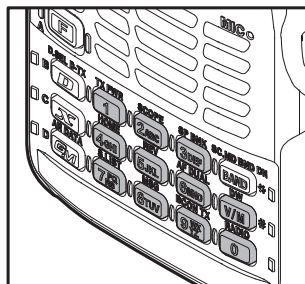

 →  →  →  → 

Example: To enter 430.000 MHz, press the following keys:



 →  → 



## Hints

- By default, the Auto Step mode is selected such that the frequency step ideal for the reception frequency is automatically selected.  
 You can change frequency steps manually using the  knob (See page 28).
- If you enter a wrong digit when entering a frequency using numeric keys, you can cancel it by pressing the  switch.
- By default, turning the  knob beyond the selected frequency band causes the FT1DR to change the selected frequency band to another frequency band.  
 To prevent this, press and hold the  key over 1 second to select the Set mode and then select "7 CONFIG" → "22 VFO MODE" → "BAND". The FT1DR can display frequencies on the same frequency band repeatedly even if you turn the  knob beyond the selected frequency band.

## Performing Communication







- 1 While pressing the  switch, speak into the microphone.  
 When speaking into the microphone, keep it about 5 cm away from your mouth.
- 2 Release the  switch.  
 The FT1DR returns to the Receive mode.

## Precaution

- Use the FT1DR at the minimum required transmission power level.  
 Doing so prevents the FT1DR from overheating and saves battery power, increasing the operating time.
- Do not continue transmission for a prolonged period. The FT1DR can overheat, resulting in a failure or burn.
- If transmission is continued for a long period, the FT1DR overheats and the overheat protection function is activated. As a result, Low Power is automatically selected as the power output level. If transmission is continued with the overheat protection function held active, the FT1DR is forcibly returned to the Receive mode.  
 If you touch the FT1DR immediately after the overheat protection function has become active, you can get burnt. Wait for the temperature inside the FT1DR to drop sufficiently before resuming transmission.
- Do not perform transmission without installing the antenna. The transmitter circuit can be damaged.

## Communication

### Hints

- In the NFM mode, you can transmit on the 144 MHz band or the 430 MHz amateur bands.
- Even when you are performing reception in the AM mode, pressing the  switch allows you to perform transmission in the NFM mode.
- Pressing the  key and the pressing the  key allows you to change the transmission power level.  
Pressing the  key displays **F** on the LCD. Pressing the  key toggles between transmission power levels.  
The icon corresponding to the transmission power level and a PO meter are displayed on the LCD. The current power level is displayed, for about 2 seconds, in the area where a frequency is displayed.  
Transmission power is different between the battery pack and the battery case.  
For more details, see "Changing the Transmission Power Level" on page 27.
- If the  switch is pressed when a band other than the amateur radio band is selected, an alarm tone (beep) is issued and "ERROR" is displayed on the LCD, disabling transmission.
- Pressing the  key over 1 second to change the Set mode allows you to use the FT1DR more conveniently.  
Selecting "7 CONFIG" → "2 BCLO" prohibits transmission during reception of a signal.

## Listening to the Radio

### Listening to an AM or FM Broadcast

The FT1DR allows you to receive AM (medium wave band) and FM broadcasts on the A-band.



The FT1DR incorporates an antenna dedicated to the AM broadcast (medium wave band).

Turn around the FT1DR body to adjust the AM broadcast (medium wave band) receiving sensitivity.

The FM broadcast is received via the supplied antenna installed at the top of the FD-D1.

1 Press the  key.

Select the A-band as an operating band.

2 Press the  key briefly, and then press the  key.

The Radio Function mode is selected.

3 Press the  key.

Pressing the  key toggles between AM and FM broadcasts.

AM broadcast (middle wave band) (A) ↔ FM broadcast (F)

During reception of the AM broadcast (middle wave band), (A) is displayed on the LCD.



During reception of the FM broadcast, (F) is displayed on the LCD.

4 Turn the  knob to tune in to your desired frequency.

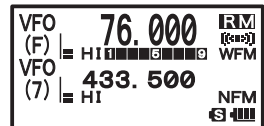

Tune in to the frequency of your desired broadcast station.



### To deactivate the radio function

- 1 Press the  key briefly, and then press the  key.  
 The Radio Function mode is canceled.

### To scan through the radio band

- 1 Select the A-band as an operating band.  
 Press and hold the  key over 1 second.  
 If a signal is received during scanning, a beep sound is issued and scanning stops to receive the broadcast corresponding to the received signal.  
 Five seconds later, scanning will resume.  
 While the broadcast is being received after stop of scanning, the decimal point blinks.  
 Pressing the  key allows you to stop scanning.

### Precaution







- When the MIC/SP jack is used, protect the FT1DR from splash of water.

### Hints

- Frequencies of the broadcast stations you listen to frequently can be stored in the memory (P.39).
- The AF-DUAL function allows you to monitor amateur band frequencies and memory channels while listening to a radio broadcast. When a signal is received in an amateur band, the radio broadcast audio is muted automatically so that you can perform communication hearing only the amateur band audio (See page 121).

## Switching between AM Antennas

You can switch between AM antennas while listening to an AM broadcast.  
 Switch between antennas according to the use conditions.  
 During normal use, you need not switch between AM antennas.

- 1 Press and hold the  key over 1 second.  
 The Set mode is selected.
- 2 Turn the  knob to select "2 TX/RX".
- 3 Press the  key briefly.
- 4 Turn the  knob to select "1 MODE".
- 5 Press the  key briefly.
- 6 Turn the  knob to select "1 ANTENNA AM".
- 7 Press the  key briefly.



## Listening to the Radio

- 8 Turn the  knob to switch to the desired antenna.









Display	Operation
BAR & EXT. ANTENNA	Switches between the whip antenna provided at the top of the FT1DR and the built-in bar antenna to receive AM broadcasts.
BAR ANTENNA	When the AM broadcast is received, the whip antenna is automatically switched to the built-in bar antenna. Turn around the FT1DR body to adjust the AM broadcast (middle wave band) receiving sensitivity.

- 9 Press the  key over 1 second.  
The Set mode is canceled.

## Miscellaneous Settings

### Setting the Date and Time

The FT1DR incorporates a clock. The clock is used not only to display the time but also turn on/off the FT1DR at the specified time (timer function). Set the clock before using the FT1DR for the first time.

- Press the  key over 1 second.  
The Set mode is selected.
- Turn the  knob to select "7 CONFIG".
- Press the  key briefly.
- Turn the  knob to select "19 DATE & TIME ADJ".
- Press the  key briefly.
- Turn the  knob to set the year.
- Press the  key.  
The cursor moves to the month.
- Turn the  knob to set the month.
- Repeat steps 5 and 6 to set the day, day of week, hour, and minute.

Pressing the  key moves the cursor to the setting item shown on the left.

**Remarks** The hour is displayed according to the 24-hour clock.

Next, set the time signal alarm.







If you do not want to set the time signal alarm, proceed to step 3 described in "Setting the Time Signal Alarm".

92	TIME SET
93	TONE FREQUENCY
94	TONE-SRCH MUTE
95	TONE-SERCH SPEED



## Setting the Time Signal

Set the time signal (a time signal tone is issued at 00 minute of each hour) as required.

- 1 Press the  key.  
 The cursor moves to "--".
- 2 Turn the  knob to select "TIME SIGNAL".  
 Selecting "TIME SIGNAL" allows you to hear a time signal tone (beep) at 00 minute of each hour.  
 If you do not want to hear the time signal tone, leave "--" as it is.
- 3 Press the  key.  
 The cursor moves to "SET".
- 4 Press the  key briefly.  
 The setting is determined.
- 5 Press the  key over 1 second.
- 6 Press the  key over 1 second again.  
 The Set mode is canceled.



**Remarks** When "MONOBAND RECEPTION" is selected, the current time is displayed on the LCD.

### Hints





- The accuracy of the clock is 30 seconds/month. However, it may vary depending on the use conditions such as the temperature.
- The FT1DR incorporates a rechargeable lithium battery dedicated to the clock. Normally, the FT1DR is powered from the battery pack. When the battery pack is detached or runs out, the lithium battery starts operating automatically. The lithium battery can operate the clock for about 2 months.
- When you use the FT1DR for the first time or by attaching the battery pack which has been detached for a long period, the accuracy of the clock may be poor. In such a case, detach the battery pack temporarily, reattach it, and then adjust the time.
- When the FT1DR is operating in "Mono" band, the current time is displayed on the LCD. However, when display of double-size characters or dual display is selected, the current time is not displayed on the LCD.
- The calendar covers all dates from January 1, 2000 through December 31, 2099.
- Setting the APRS Set mode "17 GPS TIME SET" to AUTO will display the exact time automatically.
- The timer function allows you to turn off the FT1DR automatically (See page 149).  
 Also, you can turn on the power at the specified time (See page 149).

## Muting Audio

If it is hard to hear the sound of the A-band and the sound of the B-band at the same time, you can mute the sound of the operating band which is not selected now.

- 1 Press the  key over 1 second.  
 The Set mode is selected.
- 2 Turn the  knob to select "2 TX/RA".
- 3 Press the  key briefly.

## Miscellaneous Settings

- 4 Turn the  knob to select "3 AUDIO".
- 5 Press the  key briefly.
- 6 Turn the  knob to select "2 MUTE".
- 7 Press the  key briefly.
- 8 Turn the  knob to select a muting level.



**Remarks** You can select one of the following four muting levels:

- MUTE 30%
- MUTE 50%
- MUTE 100%
- OFF





The larger the value, the smaller the sound.

To deactivate the muting function, select OFF.

- 9 Press the  key over 1 second.
- 10 Press the  key over 1 second again.

The Set mode is canceled.

**Remarks** When the muting function is activated, the  icon is displayed on the LCD.

When the muting function is being performed (sound is being muted actually), the  icon blinks on the LCD.

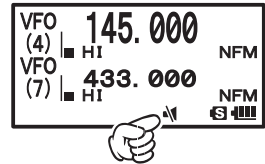

### Hint

- When no signal is received on the operating band even if the muting function is activated, sound is not muted.

## Changing the Transmission Power Level

The maximum transmission power of the FT1DR is 5 W. When communicating with a friend in the immediate area or you want to suppress battery power consumption, you can lower the transmission power. For power supply types and transmission power levels, see the table shown below.

- 1 Press the  key briefly, and then press the  key briefly.

**F** is displayed on the LCD.

Select your desired transmission power level while **F** is displayed. The icon and PO meter which correspond to the selected transmission power level appear.

The current power level is displayed, for about 2 seconds, in the area where a frequency is displayed.

Example: HIGH POWER





Battery type	H (High power)	L3	L2	L1
Battery pack	5W	2.5W	1W	0.05W
External power supply (13.8 VDC)				
Battery case (alkaline batteries)			1W	0.05W

**Hints**

- You can set a transmission power level separately for the A-band and B-band.
- Use the FT1DR at the minimum required transmission power level to suppress battery power consumption.
- By default, "HI (High power)" is selected.

**Adjusting the Squelch Level**

You can mute the raspy noise heard when no signal is being received. The squelch level can be adjusted separately for two broadcasts (NFM and AM) received on the A-band and B-band. When the squelch level is increased, the noise is more liable to disappear but, in some cases, it becomes difficult to receive weak signals. Adjust the squelch level as required.

- 1 Press the  key.  
 Select the target operating band.
- 2 Press the  key briefly, and then press the  key.
- 3 Turn the  knob to adjust the squelch level.

**Remarks** • The squelch level can be adjusted within the range from 0 to 15.  
 • Default: LEVEL 1







- 4 Press the  key.  
 The Squelch Level Adjustment mode is canceled.

**Hint**

While the  key is held pressed, the squelch function can be deactivated for both the A-band and B-band.

**Changing the Frequency Step Manually**

By default, "AUTO (Step)" is selected so that the optimum frequency step is automatically selected according to the received frequency. You can change this frequency step manually.



- 1 Press the  key over 1 second.  
 The Set mode is selected.
- 2 Turn the  knob to select "7 CONFIG".
- 3 Press the  key briefly.
- 4 Turn the  knob to select "18 STEP".
- 5 Press the  key briefly.
- 6 Turn the  knob to select your desired frequency step.

**Remarks** Selectable frequency steps are as follows:  
 · AUTO · 5 KHz · 6.25 KHz  
 · (8.33 KHz) · 10 KHz · 12.5 KHz  
 · 15 KHz · 20 KHz · 25 KHz  
 · 50 KHz · 100KHz

It is recommended that AUTO be selected normally.  
 Default: AUTO



## Miscellaneous Settings









- 7 Press the  key over 1 second.
- 8 Press the  key over 1 second again.  
The Frequency Step Setting mode is canceled.

### Hints

- For the AIR band (108 MHz to 136.991 MHz), the frequency step “8.33 kHz” can be selected.
- For bands covering 250MHz to 300MHz and bands covering 580 MHz or higher frequencies, frequency steps “5 kHz”, “6.25 kHz”, and “15 kHz” cannot be selected.

## Changing the Mode Manually

By default, “AUTO (Auto Mode)” is selected so that the optimum mode (radio wave type) is automatically selected according to the selected band (frequency band). You can change this mode manually.

- 1 Press the  key over 1 second.  
The Set mode is selected.
- 2 Turn the  knob to select “2 TX/RX”.
- 3 Press the  key briefly.
- 4 Turn the  knob to select “1 MODE”.
- 5 Press the  key briefly.
- 6 Turn the  knob to select “5 RX MODE”.
- 7 Press the  key briefly.
- 8 Turn the  knob to select your desired mode.

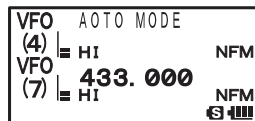

It is recommended that AUTO be selected normally.



Display	Operation
AUTO	The optimum mode is automatically selected according to the frequency band.
NFM	Only the selected band is switched to the NFM (FM mode).
AM	Only the selected band is switched to the AM mode.

- 9 Press the  key over 1 second three times.  
The Set mode is canceled.

### Hint

- Even if the AM mode is selected on an amateur band, 144 MHz band or 430 MHz band, transmission takes place in the FM mode.

## Locking keys or switches

To prevent accidental frequency change during operation, keys and switches other than the PTT switch,  key,  key,  switch, and dial knob can be locked.

- 1 Press the  key briefly.

 is displayed on the LCD.

**Remarks** To release the lock, press the  key briefly gain.

 disappears from the LCD.

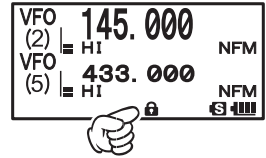

### Hint

- You can also lock the dial knob and PTT switch by selecting the Set mode "46 LOCK".

## Restoring to Defaults (All Reset)

You can restore all settings and memory contents of the FT1DR to defaults.

- 1 While pressing the  ,  , and  keys, press the  switch.

The FT1DR is turned on, followed by beep.

When you hear the beep, release the keys.

- 2 When "ALL RESET PUSH F KEY!" appears on the LCD, press the  key.

Beep is issued again.

**Remarks** To cancel the All Reset function, press a key or switch other than .

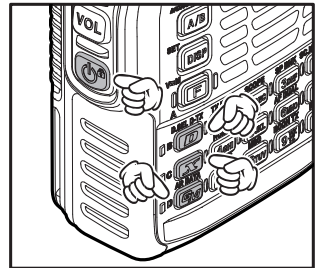

### Precaution

When the All Reset function is performed, all data stored in the memory is deleted. Be sure to record it on paper, etc. before performing the All Reset Function.

### Hint

Also, you can restore only the settings configured in the Set mode to defaults (See page 168).

## Repeater Operation

### Communicating Via the Repeater

The FT1DR supports an ARS (Automatic Repeater Shift) function which allows you to perform communication automatically just by setting the reception frequency to the repeater frequency.

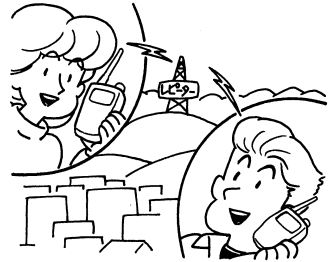



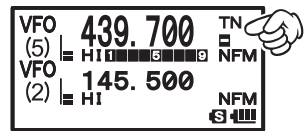

- 1 Set the reception frequency to the repeater frequency.  
“TN ■” is displayed in the upper right corner of the LCD.



- 2 While pressing the  switch, perform transmission.

#### Hints

- Pressing the  key, and then pressing the  key. This produces the “reverse” state where the transmission frequency and the reception frequency are temporarily reversed, allowing you to check whether you can communicate with the remote station directly.
  - In the “reverse” state, ■ blinks on the LCD.
  - Press the  key, and then press the  key again. This cancels the “reverse” state.
  - Press and hold the  key over 1 second to change the Set mode. This allows you to use the repeater more conveniently.
- “7 CONFIG” → “14 RPT ARS” You can deactivate the ARS function.  
 “7 CONFIG” → “15 RPT SHIFT” You can set the repeater shift direction.  
 “7 CONFIG” → “16 RPT SHIFT FREQ” You can change the repeater shift step.

## A Wide Variety of Memory Functions

The FT1DR provides the following various types of memory channels in addition to the regular memory channels (memory numbers 1 to 900).

- “Home channels” which can be recalled on each frequency band with one touch of a key. (See page 40)
- “Special banks” such as a international VHF (marine) radios (57 channels).
- 99 (901 to 999) “skip search memory channels” that allow you to skip unwanted frequencies during VFO scanning (See page 57)
- 50 sets of “memory channels (L01/U01 to L50/U50) for programmable memory scanning (PMS)” (See page 62)

An operating frequency, operation mode (type of radio), and other operational information can be stored for each regular memory channel, home channel, or PMS memory channel.

- Operating frequency
- Repeater information
- Memory skip information
- Operation mode
- Tone information
- Transmission power
- Memory tag
- DCS information

Memory channels can be sorted out with them assigned to memory banks according to the intended use. The FT1DR allows you to use 24 types of memory banks. A maximum of 100 memory channels can be assigned to each memory bank.

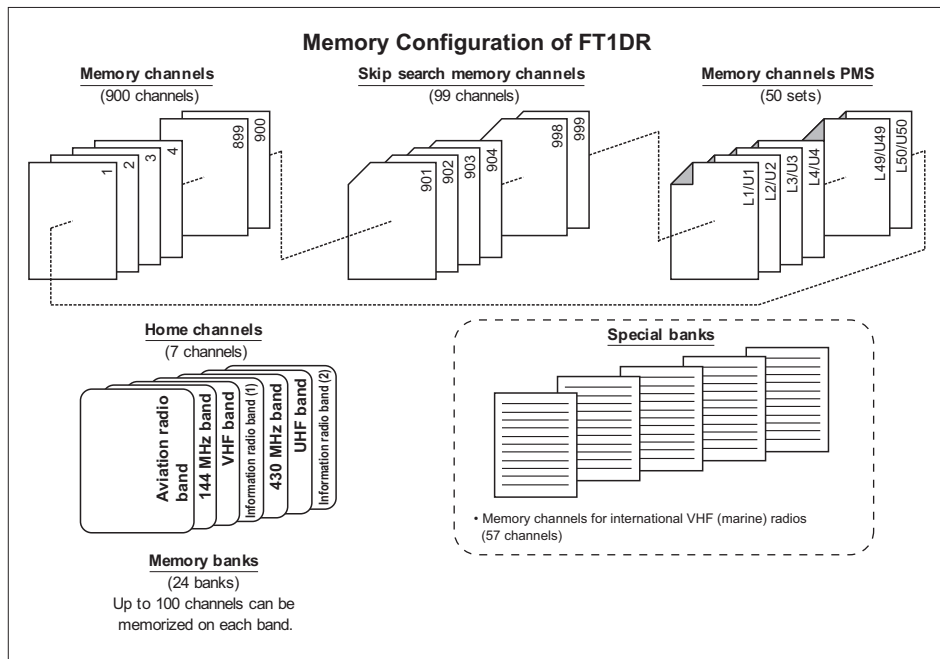



## A Wide Variety of Memory Functions

### Writing into the Memory

#### Precaution

The stored data can be erased due to wrong operation, static electricity, or electrical noise. Also, it can be erased in the case of a failure or repair. Be sure to write it down on paper or the like.



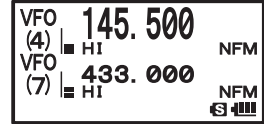

The FT1DR allows you to use 900 channels (memory channel numbers 1 to 900).

- 1 Select the VFO mode.
- 2 Turn the  knob to select a frequency.  
Select the frequency you want to write into the memory.
- 3 Press the  key more than 1 second.



The Memory Write mode is selected, and the number of the memory channel next to the memory channel for which you stored a frequency last blinks.

#### Remarks

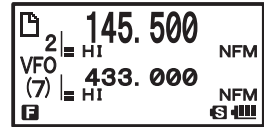

- To cancel the memory write operation, press the  switch.
- To store a frequency with a memory channel specified, turn the  knob to select the memory channel  
 [The specified channel is unregistered]  icon is displayed, and the memory channel blinks.  
 [The specified channel is registered]  icon is displayed, and "OVERWRITE OK?" is displayed on the LCD.
- Pressing the  key allows you to skip channels quickly in steps of 100 channels.



- 4 Press the  key briefly.

The memory write operation is completed, and the registered frequency is displayed on the LCD.

#### Hints

- By default, 145.000MHz was registered to memory channel 1. It can be changed to another frequency, but cannot be deleted.
- The frequency which has previously been registered to a memory channel can be overwritten with a new frequency.  
When you intend to write a new frequency into the memory, an unregistered memory channel is displayed.
- To display the lowest unregistered memory number when you start writing into the memory, press the  key more than 1 second to select the Set mode, and then select "3 MEMORY" → "6 MEMORY WRITE".
- To inhibit writing into all memories, press the  key more than 1 second, and then select "3 MEMORY" → "4 MEMORY PROTECT".





## A Wide Variety of Memory Functions

### Split Memory

Two different frequencies, one for reception and other for transmission, can be registered to a memory channel.

- 1 Write a reception frequency into the memory.

**Remarks** Write the reception frequency with reference to "Writing Data into Memories" above.

- 2 Select a transmission frequency in the VFO mode.
- 3 Press the  key more than 1 second.
- 4 Turn the  knob to select a channel number.

Select the channel number of which you registered a reception frequency.

- 5 While pressing the  switch, press the  key briefly.

When you recall the memory channel of which you registered two different frequencies, one for reception and the other for transmission, the  icon is displayed on the LCD.

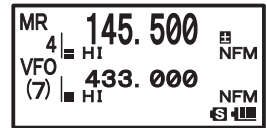

### Recalling a Memory Channel

Recall a registered memory channel in the following procedure:



- 1 Press the  key.



The Memory mode is selected, and the memory channel you used last is displayed on the LCD.

- 2 Turn the  knob to select a memory channel.

Select the memory channel to use next.

**Remarks** • You can directly recall a memory channel using numeric keys.

To recall memory channel 15:   





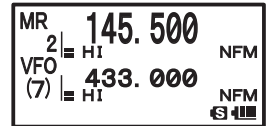

• Pressing the  key briefly and turning the  knob allows you to skip channels quickly in step of 10 channels.

- 3 Press the  key.

The Memory mode is canceled, and the frequency selected in the VFO mode is displayed.



### Hints

- Unregistered memory channels are skipped.
- By default, the priority memory channel used as the priority channel for the dual receive function was set to the memory channel 1. "P" is displayed at the upper right of the memory channel number (See page 128).
- The memory content can be transferred to the VFO of the operating band in the following procedure: Press the  key for 1 second. → Press the  key. → "OVERWRITE OK?" is displayed. → Press the  key.
- Selecting the Memory Only mode in the following procedure allows you to use only memory channels.  
While pressing the  key, press the  key.  
To cancel the Memory Only mode, press the  key again while pressing the  key (See page 155).

## A Wide Variety of Memory Functions

### Recalling the Home Channel

- 1 Press the  key briefly.

The home channel of the currently selected frequency band is displayed on the LCD.

- Hints**
- For the relationship between the frequency bands and the home channel frequencies, see the table on the next page.
  - Selecting a frequency by turning the  key allows you to return to the VFO mode.

### Returning to the Previous Frequency





- 1 Press the  key briefly.

The frequency used before recalling the home channel is displayed on the LCD.



Frequency band	Frequency	Frequency band	Frequency
Shortwave band [1]	1.800 MHz	Information radio (1) [6]	380.000 MHz
50 MHz [2]	51.000 MHz	430 MHz band [7]	433.000 MHz
Aviation radio [3]	108.000 MHz	470 to 770 MHz band [8]	481.750 MHz
144 MHz band [4]	145.000 MHz	Information radio (2) [9]	860.000 MHz
174 to 222 MHz band [5]	175.750 MHz	—	—

### Changing a Home Channel Frequency

You can change a default home channel frequency.

- 1 Select the VFO mode.
- 2 Turn the  knob to select a frequency.  
Select a frequency to change.
- 3 Press the  key more than 1 second.  
The Write mode is selected.
- 4 Press the  key briefly.  
“OVERWRITE OK?” is displayed on the LCD for about 5 seconds.
- 5 Press the  key briefly.  
When the new frequency has been written, the home channel frequency of the selected frequency band is changed.

### Deleting the Memory Channel

- 1 Select the Memory mode.
- 2 Press the  key more than 1 second.
- 3 Turn the  key to select the memory channel to delete.
- 4 Press the  key briefly.  
“CLRAR OK?” is displayed on the LCD for about 3 seconds.

**Remarks** Pressing the  key allows you to cancel the memory channel deletion operation.

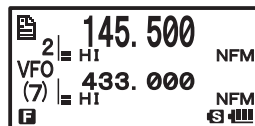

## A Wide Variety of Memory Functions

- 5** Press the  key briefly.  
 The memory channel is deleted.

**Remarks** To delete other memory channels, repeat steps 2-5.

### Precaution



- Memory channel 1 cannot be deleted.

### Hint

The memory channel specified as a priority memory channel cannot be deleted. Before deleting it, specify another memory channel as a priority memory.

## Restoring the Deleted Memory Channel

You can restore a deleted memory channel.

- Select the Memory mode.  
 The memory channel used last is displayed.
- Press the  key more than 1 second.
- Turn the  knob to select the memory channel to restore.
- Press the  key briefly.  
 The deleted memory channel is restored.

## Using Memory Banks



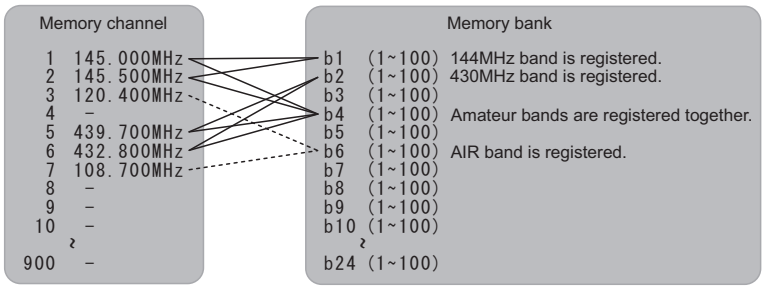

Registered memory channels can be sorted out according to the intended use. The FT1DR allows you to use 24 types of banks. A maximum of 100 memory channels can be assigned to each memory bank.

One memory channel can be registered in two or more memory banks. If the memory channel registered in the memory bank is changed or updated, the content of the corresponding memory channel in the memory bank is automatically changed or updated.







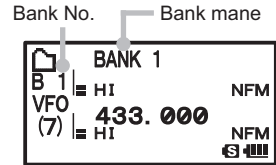
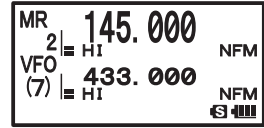

## Using Memory Banks

### Registering a Memory Channel in a Memory Bank









- 1 Select the Memory mode.
- 2 Turn the  knob to select a memory channel.  
Select the memory channel to register in a memory bank.
- 3 Press the  key more than 1 second.  
The Memory Write mode is selected.
- 4 Turn the  knob to select a memory bank number.  
Select the number (B1 to B24) of the memory bank to register the memory channel.
- 5 Press the  key briefly.  
The memory channel is registered in the memory bank.



### Hints

- When registering preset memory channels of the special bank in a memory bank, see “Registering Your Favorite Special Memory Channels in a Memory Bank” on page 48.
  - When selecting a memory bank using the  knob, the memory channel, skip search memory channel, and programmable memory channel are also displayed on the LCD. They are repeatedly displayed on the LCD in the following order:  
1 ⇄ 2 ⇄ 3 ⇄ ... L50 ⇄ U50 ⇄ BANK1 ⇄ BANK2 ⇄ ... BANK24 ⇄ 1 ⇄ 2...
- When the displayed number is close to “1”, turning the  knob counterclockwise will display memory banks. When the displayed number is close to “U50”, turning the  knob clockwise will display memory banks.
- Pressing the  key briefly displays memory banks quickly in steps of 100 memory channels. If the bank name was changed, the changed bank name is displayed.
  - The  icon is displayed for a memory bank in which no memory channel is registered, and the  icon is displayed for a memory bank in which at least one memory channel is registered.

### Recalling a Memory Bank

- 1 Select the Memory mode.
  - 2 Press the  key.  
Pressing the  key toggles between the memory channel number and bank number.
  - 3 Press the  key, and then press the  key.
  - 4 Turn the  knob to select a memory bank.  
Select a memory bank.
  - 5 Press the  key briefly.  
The memory bank to be used is determined.
  - 6 Turn the  knob to select a memory channel.  
Select a memory channel in the memory bank.
- Remarks**
- To select another memory bank, repeat steps 3-5.
  - To return to the Regular Memory mode, press the  key briefly.

Bank No. Memory channel number

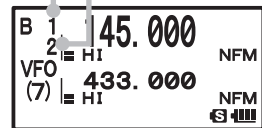

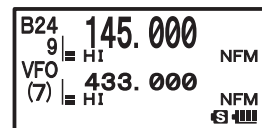
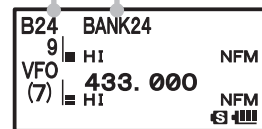

Bank No. Bank name



## Using Memory Banks

### Canceling Memory Channel Registration in a Memory Bank

- 1 Recall the memory bank subject to cancellation of memory channel registration.  
 By referring to “Recalling a Memory Bank”, recall the memory bank in which the memory channel subject to cancellation is registered.
- 2 Turn the  knob to select a memory channel.  
 Select a memory channel subject to cancellation.
- 3 Press the  key more than 1 second, and then press the  key.  
 Registration of memory channel in the memory bank is cancelled, returning to the memory bank display state. If no other memory channel is registered in the memory bank, the memory bank having the lowest bank number is displayed.





## Convenient Special Banks

Frequencies of international VHF (marine) radios (57 channels), are preset in the special bank memories, and these channels can be selected in advance from region to region.

- **International VHF (marine) radio preset memory “SP2 International VHF”** .....Page 51  
 Frequencies (57 channels) used for international VHF (marine) radios are assigned to the dedicated special bank.
- **World broadcast preset memory “SP5 Shortwave Broadcasts”** .....Page 00  
 You can listen to major broadcasts around the world (total 89 channels).

### Registering Your Favorite Special Memory Channels in a Memory Bank

You can register your favorite special memory channel in a memory bank.

- 1 Turn the  knob to select a special memory channel.  
 Select your favorite special memory channel.
- 2 Press the  key more than 1 second.  
 The Memory Bank Write mode is selected.  
 The **F** icon blinks on the display.  
**Remarks** To cancel registration, press the  key.
- 3 Turn the  knob to select a memory bank number.  
 Select the memory bank in which you want to register your favorite special memory channel.
- 4 Press the  key briefly.  
 The special memory channel is registered in the memory bank, and the frequency is displayed on the LCD.

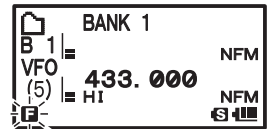

Using the Memory

## Convenient Special Banks

### Recalling a Special Bank to Listen to the International VHF (Marine) Radio

The frequencies (57 channel) used for the international VHF (marine) radio are registered in the dedicated special bank.

- 1 Press the <sup>MONO/DUAL</sup>  
 key.  
Set the A-band to the operating band.
- 2 Press the <sup>V-M</sup>  
 key briefly, and then press the <sup>SP BNK</sup>  
 key.  
The Special Bank mode is selected.
- 3 Press the <sup>SC, MD BAND DN</sup>  
 key.  
Select "INTERNATIONAL VHF".
- 4 Turn the knob to select a channel.  
Select the channel of your favorite international VHF.

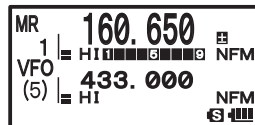

**Remarks** To cancel reception of the international VHF, press the <sup>SP BNK</sup>  
 key.

#### Precaution

Article 59 of the Radio Law stipulates that radio communication with a specific remote party shall not be intercepted, and its existence or contents shall not be leaked or used surreptitiously. By law, leak or surreptitious use of other people's conversation is prohibited.

#### Hints

- The special bank cannot be rewritten with the data of another frequency.
- To scan special bank channels toward higher channel numbers, press the <sup>SC, MD BAND DN</sup>  
 key more than 1 second, and then release it. Turning the knob one click counterclockwise will scan channels toward lower channel numbers. If a signal is received during scanning, the current frequency is held for 5 seconds with scanning suspended.
- The operation to perform when scanning stops can be set following the procedure described in the "Reception Method When Scanning Stops" on page 57.
- You can register your favorite international VHF (marine) radio in a memory bank following the procedure described in "Registering Your Favorite Special Memory Channels in a Memory Bank" on page 48.







**Convenient Special Banks**

**Frequencies of International VHF (Marine) radios Registered in Special Bank**

Channel No.	Frequency (MHz)		Channel No.	Frequency (MHz)	
1	156.050	160.650*	15	156.750	
2	156.100	160.700*	16	156.800	
3	156.150	160.750*	17	156.850	
4	156.200	160.800*	18	156.900	161.500*
5	156.250	160.850*	19	156.950	161.550*
6	156.300		20	157.000	161.600*
7	156.350	160.950*	21	157.050	161.650*
8	156.400		22	157.100	161.700*
9	156.450		23	157.150	161.750*
10	156.500		24	157.200	161.800*
11	156.550		25	157.250	161.850*
12	156.600		26	157.300	161.900*
13	156.650		27	157.350	161.950*
14	156.700		28	157.400	162.000*

Channel No.	Frequency (MHz)		Channel No.	Frequency (MHz)	
60	156.025	160.625*	74	156.725	
61	156.075	160.675*	75	156.775	
62	156.125	160.725*	76	156.825	
63	156.175	160.775*	77	156.875	
64	156.225	160.825*	78	156.955	161.550*
65	156.275	160.875*	79	156.975	161.575*
66	156.325	160.925*	80	157.025	161.625*
67	156.375		81	157.075	161.675*
68	156.425		82	157.125	161.725*
69	156.475		83	157.175	161.775*
70	156.525		84	157.225	161.825*
71	156.575		85	157.275	161.875*
72	156.625		86	157.325	161.925*
73	156.675		87	157.375	161.975*
—	—		88	157.425	162.025*

**Remarks**

\* is the frequency of the base station. For example, if channel 1 is selected, the base station frequency 160.650 MHz and the  icon are displayed. Pressing the  key briefly and then pressing the  key briefly displays the Ship Station frequency 160.650 MHz is displayed and the  icon blinks. The base station frequency minus 4.6 MHz equals the Ship Station frequency, and duplex operation starts. To return to the base station frequency, press the  key briefly, and then press the  key briefly.



Using the Memory

## Using the Scanning Function

The FT-1DR supports the following four scan modes:

- (1) VFO Scan
- (2) Memory Scan
- (3) Programmable Memory Scan
- (4) Selected Memory Channel Scan

### VFO Scan

- 1 Select the VFO mode, and then select a band to scan.
- 2 While pressing the  key, turn the  knob to specify the scanning range. Specify the scanning range as follows.

Display*	Operation
ALL	Scans all bands within the range from the current frequency to 108-999 MHz.
(PMS number)	Shortcuts the PMS scanning procedure (steps 1 and 2 described on page 46). If PMS memories have been registered in advance, PMS memory numbers are displayed. Turn the  knob to select the PMS memory you want to scan, and then scan the PMS range.
± 1 MHz	Scans the current band (see the table on the next page) within ± 1 MHz of the current frequency.
± 2 MHz	Scans the current band (see the table on the next page) within ± 2 MHz of the current frequency.
± 5 MHz	Scans the current band (see the table on the next page) within ± 5 MHz of the current frequency.
BAND	Scans the current band (see the table on the next page) starting with the current frequency.

- 3 Release the  key.

Scanning (SCAN) starts toward higher frequencies.

**Hints** While the  key is pressed down, the scanning range is displayed on the LCD.

When a signal is received during scanning, the decimal point blinks.

Turn the  knob clockwise.: Scanning is performed toward higher frequencies.

Turn the  knob counterclockwise.: Scanning is performed toward lower frequencies.

When a signal is received during scanning, a beep is emitted and its frequency is displayed for 5 seconds. When scanning is suspended, the decimal point blinks and the LCD stays lit.

After receiving the signal for 5 seconds, scanning resumes.

### Precaution

The difference between the upper limit frequency and the lower limit frequency for PMS must be 100 kHz or more.







## Using the Scanning Function

### Canceling Scanning

To cancel scanning, press the  switch.

#### Hints

- Even during scanning, you can adjust the squelch in the following procedure:  
 Press the  key briefly. → Press the  key. → Turn the  knob to adjust the squelch.
- During scanning, you can finish the squelch adjustment in the following procedure:  
 Press the  key briefly. → Press the  key.

**A-band and B-band reception frequencies**

Frequency band No.	A-BAND	B-band
(1)	1.8 MHz to 30 MHz (Shortwave band)	--
(2)	30 MHz to 76 MHz (50 MHz band )	--
(3)	108 MHz to 137 MHz (Aviation radio band)	108 MHz to 137 MHz (Aviation radio band)
(4)	137 MHz to 174 MHz (144 MHz band)	137 MHz to 174 MHz (144 MHz band)
(5)	174 MHz to 222 MHz	174 MHz to 222 MHz
(6)	222 MHz to 420 MHz (Information radio band (1))	222 MHz to 420 MHz (Information radio band (1))
(7)	420 MHz to 470 MHz (430 MHz band)	420 MHz to 470 MHz (430 MHz band)
(8)	470 MHz to 770 MHz	470 MHz to 770 MHz
(9)	770 MHz to 999 MHz (Information radio band (2))	--

- For the operation to perform when scanning stops, see "Selecting a Reception Method When Scanning Stops" on page 57.
- Press the  key more than 1 second to select the Set mode, and then select the following items for more convenient use:  
 "7 CONFIG" → "3 BEEP" → "EDGE": Emits a beep when the frequency band edge is reached.  
 "7 CONFIG" → "3 BEEP" → "SELECT": Prevents a beep from being emitted when scanning stops.  
 "5 SCAN" → "2 SCAN LAMP": Prevents the LCD from being lit when scanning stops.

### Skiping a Frequency You Do Not Want Scan (Skip Search Memory)

Scanning may stop at a frequency that you do not want to receive. Such a frequency can be skipped by storing it in the "skip search memory". Up to 99 frequencies can be saved in the skip search memory (memory channels 901 to 999).

Scanning Function

## Using the Scanning Function

### Specifying the Frequency You Do Not Want to Scan

- 1 Start VOF scanning.  
Start VOF scanning with reference to “VFO Scanning” on page 63.
- 2 When scanning stops at the frequency you do not want to receive, press the  key more than 1 second.





Numbers of unprogrammed skip search memory channels blink.

**Hints** Turning the  knob allows you to specify other skip search memory channels.

- 3 Press the  key briefly.



The frequency is saved in the skip search memory, and scanning resumes.

**Hints** • You can specify the frequency you do not want to receive by using the following procedure in advance:

- 1 In the VFO mode, tune in to the frequency you do not want to scan.
  - 2 Press the  key more than 1 second.
  - 3 Turn the  knob to select a skip search memory channel.
  - 4 Press the  key briefly.
- To cancel scanning, press the  key.



### Deleting a Frequency Saved in the Skip Search Memory

The frequency saved in the skip search memory can be deleted in the following procedure. After this, the deleted frequency is scanned.

- 1 Select the Memory mode.
- 2 Press the  key more than 1 second.
- 3 Turn the  knob to select a memory channel of the skip search memory.

Select the memory channel (901-999) containing the frequency you want to delete.

When selecting a memory channel, pressing the  key allows you to skip memory channel numbers in steps of 100 memory channel numbers.

- 4 Press the  key.  
“DELETE OK?” is displayed on the LCD.
- 5 Press the  key.

The saved frequency is deleted.

**Hints** To delete another frequency from the skip search memory, repeat steps 2-4.

#### Hint







- Restoring the Frequency Deleted from the Skip Search Memory  
If you have not specified a new frequency for the same memory channel, you can restore the deleted frequency by repeating steps 1-4.

## Using the Scanning Function

### Selecting a Reception Method When Scanning Stops



When scanning stops, you can select one of the following three reception methods:

- (1) The signal is received for the specified period of time, and then scanning resumes. You can specify this period of time in steps of 0.5 second within the range from 2 seconds to 10 seconds.
- (2) The signal is received until it fades out. Two seconds after the signal fades out, scanning resumes. "BUSY" is displayed on the LCD.
- (3) Scanning stops and the current frequency is received. "HOLD" is displayed on the LCD.

- 1 Press the  key more than 1 second.
- 2 Turn the  knob to select "5 SCAN".
- 3 Press the  key briefly.
- 4 Turn the  knob to select "4 SCAN RESUME".
- 5 Press the  key briefly.
- 6 Turn the  knob to select a reception method.



Select a reception method from "2 SEC TO 10 SEC (0.5 SEC STEP)", "BUSY", and "HOLD".



- 7 Press the  key more than 1 second. The selected reception method is determined.
- 8 Press the  key more than 1 second again. The Set mode is canceled.

#### Hints

- The reception method selected here is also applied to "VFO Scanning", "Programmable Memory Scanning", and "Dual Reception".
- The "BUSY" scanning start time can be changed by selecting the Set mode item "3 SCAN RE-START".

### Memory Scanning

Frequencies saved in the memory can be scanned in the order of memory channel number.

- 1 Select the Memory mode, and recall memory channel.
- 2 While pressing the  key, turn the  knob to specify the scanning range.

Specify the scanning range with reference to the table on the next page.

While the  key is pressed down, the scanning range is displayed.

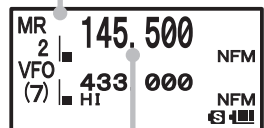

When a signal is received, the decimal point blinks.

## Using the Scanning Function

### 3 Release the key.

Scanning (SCAN) is performed toward higher memory channel numbers.

While the  key is pressed down, the scanning range is displayed on the LCD.

When a signal is received, the decimal point blinks.

**Hints** • Turn the  knob clockwise.:







Scanning is performed toward higher memory channel numbers.

Turn the  knob counterclockwise.:

Scanning is performed toward lower memory channel numbers.

- When a signal is received during scanning, scanning stops for 5 seconds and this frequency is received.
- When scanning is suspended, the decimal point blinks and the LCD stays lit.
- After receiving the frequency for 5 seconds, scanning resumes.
- To cancel scanning, press the  switch.

### Hints

- Even during scanning, you can adjust the squelch in the following procedure:  
 Press the  key briefly. → Press the  key. → Turn the  knob to adjust the squelch.
- During scanning, you can finish the squelch adjustment in the following procedure:  
 Press the  key briefly. → Press the  key.
- When memory channels are recalled, they are regular memory channels (memory numbers 1-900).
- When a memory bank is recalled, only the memory channels in the memory bank are scanned.
- For the operation to perform when scanning stops, see “Selecting a Reception Method When Scanning Stops” on page 57.
- Press the  key more than 1 second to select the Set mode, and then select the following items for more convenient use:  
 “7 CONFIG” → “3 BEEP” → “EDGE”: Emits a beep when the frequency band edge is reached.  
 “7 CONFIG” → “3 BEEP” → “SELECT”: Prevents a beep from being emitted when scanning stops.  
 “5 SCAN” → “2 SCAN LAMP”: Prevents the LCD from being lit when scanning stops.

### Precaution

The difference between the upper limit frequency and the lower limit frequency for PMS must be 100 kHz or more.

Display	Operation
ALL CH	Scans all memory channels (1-900) of the currently selected memory. When selected memory channels are specified, all of them are scanned (See page 59).
(PMS No.)	Shortcuts the PMS scanning procedure (steps 1 and 2 described on page 62). When a PMS memory has been registered in advance, its number is displayed. Turn the  knob to select the PMS memory you want to scan, and then scan the range between the upper and lower limits of the PMS.
BAND	Scans only the memory channels for which frequencies in the same frequency band*1 as that of the currently selected memory are saved. When selected memory channels are specified, scans only the selected memory channels for which frequencies in the same frequency band*1 as that of the currently selected memory are saved (See page 59).

\*1 For the relationship between frequency bands and reception frequencies, see the table at the bottom of page 56.









## Using the Scanning Function

### Specifying a Skip/Selected Memory Channel

You can specify two types of memory channels, a skip memory channel and a selected memory channel, for effective memory scanning.

**Skip memory channel:** You can specify a memory channel that need not be scanned during memory scanning.

**Selected memory channel:** You can specify selected memory channels so that only the specific memory channels are scanned during memory scanning.

- 1 Select the Memory mode, and then recall the memory channel you want to specify as a skip memory channel or a selected memory channel.
- 2 Press the  key more than 1 second.  
The Set mode is selected.
- 3 Turn the  knob to select "3 MEMORY".
- 4 Press the  key briefly.
- 5 Turn the  knob to select "5 MEMORY SKIP".
- 6 Press the  key briefly.
- 7 Turn the  knob to select "OFF", "SKIP", or "SELECT".
- 8 Press the  key more than 1 second.
- 9 Press the  key more than 1 second again.

The Set mode is canceled.

**Hints** To cancel a skip/selected memory channel, select [OFF].

When it is canceled, the ◀ icon on the LCD disappears.

Stays lit for the skip memory.



Blinks for the selected memory channel.



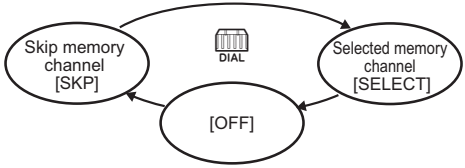

Scanning Function



## Using the Scanning Function

### Scanning Only the Selected Memory Channel

- 1 Select the Memory mode, and then recall the selected memory channel.
- 2 While pressing the  key, turn the  knob to specify the scanning range.



**Hints** For the scanning range to be specified, see the table on page 66.

- 3 Release the  key.

**Hints** • Scanning (SCAN) is performed toward higher memory channel numbers.

- Only the selected memory channel is scanned.
- If a signal is received during scanning, a beep is emitted and scanning stops for 5 seconds to receive the current frequency.
- While scanning is suspended, the decimal point blinks and the display stays lit.
- After receiving the frequency for 5 seconds, scanning resumes.
- To cancel scanning, press the  key briefly.

### Scanning a Memory Bank

Only the memory channels in the recalled memory bank can be scanned.

- 1 Press the  key.

The Memory mode is selected.

- 2 Press the  key briefly.

Recall a memory bank.

Pressing the  key briefly toggles between “MEMORY NO.” and “BANK (No.)”.

**Hints** To recall another memory bank, press the  key briefly, and then press the  key briefly.

- 3 Turn the  knob to select a memory bank.

Select a memory bank from among BANK 1 to BANK 24.

- 4 Press the  key briefly.

The selected memory bank is determined.

- 5 While pressing the  key, turn the  knob to specify the scanning range.

**Hints** For the scanning range to be specified, see the table on page 66.

- 6 Release the  key.

Scanning (SCAN) is performed toward higher memory channel numbers.

**Hints** • Turn the  knob clockwise.:

Scanning is performed toward higher memory channel numbers.

Turn the  knob counterclockwise.:

Scanning is performed toward lower memory channel numbers.

- When a signal is received during scanning, scanning stops for 5 seconds and this frequency is received.
- When scanning is suspended, the decimal point blinks and the LCD stays lit.
- After receiving the frequency for 5 seconds, scanning resumes.
- To cancel scanning, press the  switch.

## Using the Scanning Function

### Memory Bank Link Scan

During regular memory bank scanning, only the memory channels assigned to the recalled memory bank are scanned. During memory bank link scanning, memory channels registered in two or more previously specified banks can be scanned.



- 1 Press the key.  
The Memory mode is selected.
- 2 Press the key briefly.  
Recall a memory bank.
- 3 Press the key briefly, and then press the key briefly.
- 4 Turn the knob to select a memory bank.  
Select a memory bank subject to bank link scanning.
- 5 Press the key briefly.  
Select the bank link.

The memory bank number change from "B" to "b".



The memory bank number changes from "B" to "b", indicating that the bank link has been activated

- 6 Repeat steps 2-4 to select another memory bank.  
**Hints** For the scanning range to be specified, see the table on page 66.

- 7 Press the key briefly.  
The memory banks subject to memory bank scanning are determined.

- 8 While pressing the key, specify a scanning range.  
**Hints** For the scanning range to be specified, see the table on page 66.

- 9 Release the key.  
Scanning (SCAN) is performed toward higher memory channel numbers.

- Hints**
- Turn the knob clockwise.:  
Scanning is performed toward higher memory channel numbers.
  - Turn the knob counterclockwise.:  
Scanning is performed toward lower memory channel numbers.
  - When a signal is received during scanning, scanning stops for 5 seconds and this frequency is received.
  - When scanning is suspended, the decimal point blinks and the LCD stays lit.
  - After receiving the frequency for 5 seconds, scanning resumes.
  - To cancel scanning, press the switch.

### Canceling Bank Link Scanning

- 1 Press the key briefly, and then press the key briefly.
- 2 Recall the link for which bank link scanning was specified.
- 3 Press the key briefly.  
The memory bank number changes from "b" to "B", indicating that the bank link has been deactivated.

Scanning Function

## Using the Scanning Function

### Programmable Memory Scan (PMS)

#### Writing into a Programmable Memory

50 sets of PMS memory channels (L1/U1 to L50/U50) are available.

Specify the lower limit frequency of the frequency range you want to scan for “L\*”, and the upper limit frequency for “U\*”.

Enter a number between 1 and 50 for “\*”. Use the same number for the lower and upper limit channels.

Specify the lower limit frequency and upper limit frequency for the PMS memory channels according to page 39.

PMS memory channels are located late in the memory channel area. When there are 100 or more memory channels, press the  key to skip memory channels quickly in steps of 100 memory channels.

Example: Specification of the lower limit frequency “433.200 MHz” and the upper limit frequency “433.700 MHz” for PMS

#### Precaution

The difference between the upper limit frequency and the lower limit frequency for PMS must be 100 kHz or more.

#### Performing Programmable Memory Scan

The programmable memory allows you to scan the specified frequency range in the same frequency band.

##### 1 Select the Memory mode.

Recall the PMS memory storing the lower limit frequency or upper limit frequency.

##### 2 Press the key, and then turn the knob to select a PMS channel.

##### 3 Release the key.



Programmable memory scanning starts.

**Hints** • Turn the  knob clockwise.:

Scanning is performed toward higher memory channel numbers.

Turn the  knob counterclockwise.:

Scanning is performed toward lower memory channel numbers.

- When a signal is received during scanning, scanning stops for 5 seconds and this frequency is received.
- When scanning is suspended, the decimal point blinks and the LCD stays lit.
- After receiving the frequency for 5 seconds, scanning resumes.  
 To select another PMS memory, press the  knob to select it while pressing the .
- To cancel scanning, press the  switch.

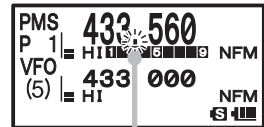
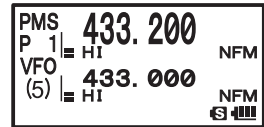

The decimal point blinks.



## Using the Scanning Function

### Hints

- If PMS memory channels have already been assigned to L1/U1 to L50/U50, selecting a PMS number in the VFO scanning procedure described on page 56 allows you to skip step 1 described above.
- When a skip memory (P\*\*) is specified for "L\*" or "U\*" or when the lower/upper limit frequency is not properly specified, program memory scanning is not performed properly.
- Press the **SET** key more than 1 second to select the Set mode, and then select the following items for more convenient use:  
"7 CONFIG" → "3 BEEP" → "EDGE": Emits a beep when the frequency band edge is reached.  
"5 SCAN" → "2 SCAN LAMP": Prevents the LCD from being lit when scanning stops.
- Even during scanning, you can adjust the squelch in the following procedure:  
Press the **V-M** key briefly. → Press the **MONI** key. → Turn the **DIAL** knob to adjust the squelch.
- During scanning, you can finish the squelch adjustment in the following procedure:  
Press the **V-M** key briefly. → Press the **MONI** key.

## Using the Search Function

### Spectrum Scope Searching for a Signal Using a Signal Strength Graph

During mono band reception in the VFO mode, strengths of channel signals around the current frequency can be graphically displayed on the LCD.

- 1 Press the **V-M** key briefly, and then press the **SCOPE** key.

Use states of 16 channels (eight channels above the current frequency and eight channels below the current frequency) are checked and the corresponding signal strengths are displayed graphically on the LCD.

- 2 Turn the **DIAL** knob to move the ▼ icon to the signal position.

The signal at the center frequency can be received.

**Hints** To resume scanning, press the **DW** key.

- 3 Press the **V-M** key briefly, and then press the **SCOPE** key.

The spectrum scope is deactivated.

### Hints

- Normally, the spectrum scope can check 16 channels around the current frequency. Pressing the **MONODUAL** key allows you to select the channel check range from among  $\pm 5$ ,  $\pm 9$ ,  $\pm 16$ ,  $\pm 24$ , and  $\pm 50$ .
- When  $\pm 5$  is selected, numeric values representing signal strengths are displayed in the graph.
- The spectrum scope channel interval is the same as the VFO frequency step.
- When the spectrum scope is running, numeric, **DSEL DTX**, **DATA**, and **DATA** keys cannot be used.
- By default, channel use states are displayed graphically after completion of scanning, and the sound of the signal at the center frequency is output if such signal is detected. Turning the **DIAL** knob allows you to restart scanning.
- Selecting "1 DISPLAY" → "2 BAND SCOPE" → "CONTINUOUS" in the Set mode allows you to view the latest use states through repetitive scanning.  
To stop scanning, press the **DW** key.  
To stop spectrum analysis, press the **V-M** key, and then press the **SCOPE** key.
- Selecting "1 DISPLAY" → "2 BAND SCOPE" → "FULL TIME" in the Set mode allows sound to be emitted with the spectrum scope running.  
However, sound cannot be emitted in frequency bands 580 MHz to 999 MHz.

## What is GPS?

GPS (Global Positioning System) is a space-based satellite navigation system that provides location and time information anywhere on the earth. It was developed by the U.S. Department of Defense as a military system. It receives signals from three or more of about 30 GPS satellites flying at an altitude of about 20,000 km, and displays the current position (latitude, longitude, and altitude) within a tolerance of several meters. In addition, GPS can receive the exact time from the satellite's onboard atomic clock.

## Activating the GPS Function

To activate the GPS function, select "8 APROS" → "23GPS POWER", and then select "GPS ON" in the Set mode.









### Hint

- Default: ON

When the GPS function of the FT1DR is turned ON, internal clock settings and position settings for your station are automatically obtained from the GPS data.

### Precaution

- Data for the current day of the week is not automatically obtained. Set the day of the week manually with reference to page ●●.

- 1 Press the  key over 1 second.  
The Set mode is selected.
- 2 Turn the  knob to select "8 APRS".
- 3 Press the  key briefly.
- 4 Turn the  knob to select "16 GPS POWER".
- 5 Press the  key briefly.
- 6 Turn the  knob to select "GPS ON".
- 7 Press the  key for more than 1 second.  
The GPS function is turned ON.
- 8 Press the  key for more than 1 second again.  
The Set mode is canceled.

T.B.D.

T.B.D.

T.B.D.

## Activating the GPS Function

### Hints

- Information about the current positions of radio stations provided by GPS can be saved in 10 memories (P1 to P10). Saved position information can be used to set the position of your station (See page 111).
- When the GPS function is active, power consumption increases about 40 mA. As a result, the battery life is reduced by about 20% compared to when the GPS function is deactivated.
- To use the GPS function during APRS operation, be sure to select "8 APRS" → "27 MY POSITION", and then select "GPS" in the Set mode.

## Method of Positioning by GPS

- 1 Turn on the FT1DR.
- 2 Shortly press the  key twice.

The GPS screen appears.  
 Pressing the  key switches among FT1DR screens in the following order:  
 Usual frequency display → BACK TRACK display → GPS display → ARTS-D display → WiRES-X display



**Precaution** The ARTS-D screen and the WiRES-X screen are displayed when the corresponding functions are active.

Since the FT1DR searches satellites, it requires a few minutes to display the positioning result.

- 3 GPS data is displayed.  
 An arrow icon (the direction in which you are heading), your current position, number of satellites, longitude, latitude, and altitude are displayed on the screen.



- Hints**
- The arrow icon (the direction in which you are heading) will not appear and the latitude/altitude blinks until GPS satellite data is acquired.
  - When GPS satellite data has been acquired, the arrow icon (the direction in which you are heading) will appear, the latitude/altitude will change from blinking to lit, and your current position will be displayed.
  - If acquisition of GPS satellite data is interrupted due to an obstacle, such as a building or tunnel, only the arrow icon (the direction in which you are heading) disappears.

- 4 Press the  key to scroll the screen.  
 Pressing the  key scrolls the screen and displays the current time.  
 Pressing the  key again displays GPS data.



Using the GPS Function

## Method of Positioning by GPS

### About Positioning by GPS

“Positioning” refers to calculation of your current position from the satellite orbit information and radio propagation time. At least three satellites need to be captured for successful positioning. If positioning fails, move away from buildings as far as possible and stand in an area with open sky.

#### • About errors

A positioning error by several hundred meters can occur due to the environmental conditions. Under favorable conditions, positioning can be performed successfully using only three satellites. However, under the following poor conditions, the positioning accuracy can decrease or positioning can fail.

- Between high-rise buildings
- On a narrow road between buildings
- In a room or behind a building
- Under high-voltage cable or overpass
- Between trees such as in the woods
- In a tunnel or underground
- Usage behind heat reflective glass
- Places with strong magnetic fields

#### • When using the GPS function for the first time today

When you use the GPS function for the first time after purchase of the FT1DR or today, a few minutes are required to search for satellites. Also, when using the GPS function after turning off the FT1DR for several hours, a few minutes are required to search for satellites.

## Explanation of GPS Screen and Operation

Activating the GPS function displays the following information on the LCD.

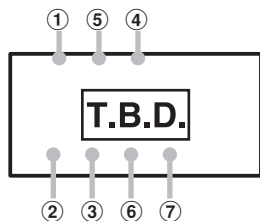

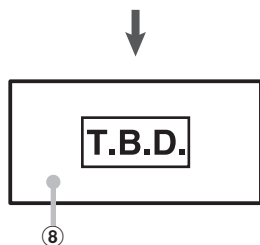

↓

Press the MONO/DUAL **(A/B)** key to scroll the screen until the current time appears.



- ① Compass:** North-UP (North is always up.)  
 Heading-UP: (When SC.MD BAND ON **(BAND)** is pressed, the direction in which you are heading is always up. A white arrow icon is displayed. "H" is displayed at the lower right of the compass icon.)

- ② Positioning:** When at least three satellites have been captured, the  icon is displayed. This icon is not displayed if it cannot capture at least three icons.
- ③ Number of satellites:** Displays the number of captured satellites.
- ④ Latitude:** The current position is displayed using north (N) or south (S) latitude.  
 Display format: X DD°MM. MMM  
 X: X=N: North latitude, X=S: South latitude  
 DD: Degree  
 MM.MMM: Minute  
 Example: N 35°38.250 (35 degrees, 38 minutes, 15 seconds north latitude)
- ⑤ Longitude:** The current position is displayed using east (E) or west (S) longitude.  
 Format: X DDD°MM. MMM  
 X: X=E: East longitude, X=W: West longitude  
 DDD: Degree  
 MM.MMM: Minute  
 Example: E 139°42.500 (139 degrees, 42 minutes, 30 seconds east latitude)
- ⑥ Speed:** The speed at which you are moving is displayed.  
 Format: SPD aaakm/h  
 Example: SPD 5 km/h
- ⑦ Altitude:** The altitude of the current position of your radio station is displayed.  
 Format: ALT aaaaaa  
 Example: ALT 20m
- ⑧ Time:** The current time set by GPS is displayed.  
 Format: aa (hour): bb (minute): cc (second)  
 Example: 23: 59: 59  
 \* When an external GPS device is connected to the data terminal, the time is displayed as follows:  
 aa (hour): bb (minute)

Using the GPS Function

## Explanation of GPS Screen and Operation

### Hints





- Selecting "8 APRS" → "18 GPS UNIT" in the APRS/GPS Set mode allows you to change the unit of GPS data.
- When the GPS function is used, the accurate time data (date and time) obtained from GPS is displayed on a 24 hour basis. This time data is reflected in the time data displayed on the GPS screen and APRS screen. However, data for the day of the week is not automatically obtained from GPS. Set the day of the week manually referring to "Setting the Clock" on page ●●.
- Selecting "8 APRS" → "15 GPS DATUM" in the APRS/GPS Set mode allows you to change the geodetic system of the built-in GPS unit. However, since APRS uses the geodetic system of WGS-84, it is recommended not to change it.
- Selecting "8 APRS" → "24 TIME ZONE" in the APRS/GPS Set mode allows you to set the time zone by units of 30 minutes.
- When the GPS function is active, the power consumption increases by about 40 mA. As a result, the battery life is reduced by about 20% compared to when the GPS function is deactivated.
- Selecting "8 APRS" → "13 COM PORT SETTING" and then setting "INPUT" to "GPS" in the APRS/GPS Set mode allows you to obtain position information from an external GPS device. In this case, the data obtained from the internal GPS is disabled.
- When using an external GPS device, keep it away from the FT1DR.

## BACK TRACK Function

This function allows you to return to the previously saved position (maximum of two positions) using the GPS function.

For example, if the position where you parked your car (such as certain position in a wide parking area of a theme park or shopping center) has been saved in the FT1DR, you can return to your car without getting lost by following the guidance on the screen of the FT1DR.





### Causing the FT1DR to Memorize the Current Point

- 1 Press the  key briefly.  
The BACKTRACK function screen appears.
- 2 Press the  key briefly.  
The POINT(L1/L2) selection screen appears.
- 3 Turn the  knob and select "POINT L1" or "POINT L2".
- 4 Press the  key.  
Saves the current position.
- 5 Press the  key.  
Returns to the BACKTRACK function screen.



**BACK TRACK Function**

**Using the BACK TRACK Function**

- 1 Press the  key briefly.  
 The BACK TRACK function screen appears.
- 2 Turn the  knob and select "POINT L1" or "POINT L2".
- 3 Press the  key.  
 Returns to the BACK TRACK function screen.
- 4 Press the  key.  
 The BACK TRACK function is activated.

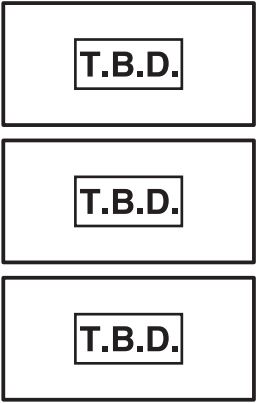

The saved position (destination) appears in the direction of the arrow within the circle.

Walk forward so that the arrow stays pointing up on the screen.

When the distance (DST) to the saved position becomes "0.1 km"\*, it will be indicated by four beeps.

\* 100 m to 200 m

When the distance (DST) to the saved position becomes "0.0 km"\*, it will be indicated by a short beep melody.

\* 0 m to 100 m

When you reach the destination, the screen changes as shown on the right, it will be indicated by a short beep, and the LED glows white.



**Description of the BACK TRACK Function Screen**



- POINT: Displays the saved position (L1 or L2).
- DST: Displays the linear distance to the saved position.
- GPS: Displays the number of captured GPS satellites.
- Arrow in circle: Indicates the direction toward the saved position.

Using the GPS Function

## Dual Reception (DW) Functions

The FT1DR supports the following three dual reception functions:

- (1) Dial dual reception
- (2) Memory dual reception
- (3) Home channel dual reception

The signal of the specified memory channel (priority memory channel) is checked at intervals of about 5 seconds. If this signal is detected, it is received.

Example: Check of the signal of priority memory channel "90" during reception of "145.500 MHz"

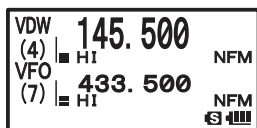

Frequency being received

The signal of the priority memory channel "90" is checked at intervals of about 5 seconds.



If the signal of the priority channel "90" is received, the decimal point blinks.

## Dial Dual Reception

VFO mode → Priority memory channel

- 1 Select the Memory mode.
- 2 Press the key more than 1 second. The Write mode is selected, and the icon and the channel number on the LCD blink.
- 3 Turn the knob to select a memory channel, and then press the key more than 1 second.

Select a memory channel (priority memory channel) whose signal is to be received preferentially. "P" is displayed on the LCD.

- 4 Select the frequency to be received.  
Select the frequency to be received constantly.
- 5 Press the key more than 1 second.  
The Write mode is canceled.

- 6 Press the key more than 1 second.  
Dial dual reception starts, and "VDW" is displayed on the LCD.

- 7 Press the key briefly.  
Dial dual reception is canceled.

"P" is displayed.



"VDW" is displayed.

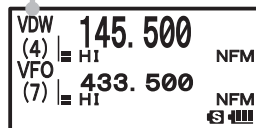









## Dual Reception (DW) Functions

### Memory Dual Reception

Memory channel → Priority memory channel



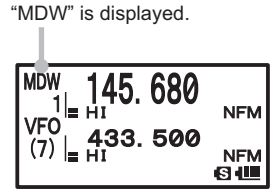
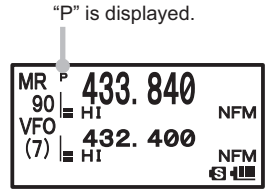



- 1 Select the Memory mode.
- 2 Press the  key more than 1 second.  
 The Write mode is selected, and the **F** icon and the channel number on the LCD blink.
- 3 Turn the  knob to select a memory channel, and then press the  key briefly.  
 Select a memory channel (priority memory channel) whose signal is to be received preferentially. "P" is displayed on the LCD.
- 4 Select the memory channel whose signal is to be received. Select the memory channel whose signal is to be received constantly.
- 5 Press the  key more than 1 second.  
 The Write mode is canceled.
- 6 Press the  key more than 1 second.  
 Memory dual reception starts, and "MDW" is displayed on the LCD.
- 7 Press the  key briefly.  
 Memory dual reception is canceled.



Useful Functions



### Home Channel Dual Reception

Home channel → Priority memory channel

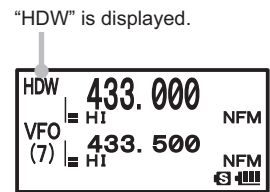
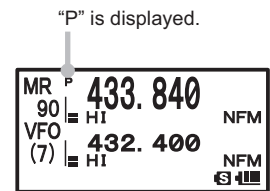
- 1 Select the Memory mode.
- 2 Press the  key more than 1 second.  
 The Write mode is selected, and the **F** icon and the channel number on the LCD blink.
- 3 Turn the  knob to select a memory channel, and then press the  key briefly.  
 Select a memory channel (priority memory channel) whose signal is to be received preferentially. "P" is displayed on the LCD.
- 4 Press the  key briefly, and then press the  key.  
 Recall the home channel.
- 5 Press the  key more than 1 second.  
 The Write mode is canceled.





## Dual Reception (DW) Functions

- Press the  key more than 1 second.  
Home channel dual reception starts, and "HDW" is displayed on the LCD.
- Press the  key briefly.  
Home channel dual reception is canceled.

### Precaution









Be sure to assign a memory channel to the priority memory channel in advance.

### Hints



- By default, memory channel 1 is assigned to the priority memory channel.
- Pressing the  key more than 1 second and changing the Set mode allows you to use this function more conveniently.  
"5 SCAN" → "1 PRI TIME": Allows you to change the priority channel monitoring interval.  
"5 SCAN" → "4 SCAN RESUME": Allows you to change dual reception restart conditions.
- The constantly received frequency can be freely combined with the frequency band and mode of the priority memory channel.
- When the signal of the priority memory channel is received, its frequency is received for 5 seconds, and then dual reception resumes. Even during priority channel reception, pressing the  key deactivates the dual reception function, allowing you to perform communication using that frequency.

## Using the DTMF Function

"DTMF (Dual Tone Multi Frequency) tones" refer to the tones (beep boop beep) heard from the receiver of the push-button phone. You can register the telephone number for phone patch connection to the public telephone line, etc. with a DTMF code comprising up to 16 characters (for up to 10 channels).



- Press the  key more than 1 second to select the Set mode.
- Turn the  knob to select "4 SIGNALING".
- Press the  key briefly.
- Turn the  knob to select "5 DTMF SELECT".
- Press the  key briefly.
- Turn the  knob to select a channel.  
Select a number (1-10) to which the DTMF code is to be assigned.
- Press the  key.
- Turn the  knob to enter a DTMF code.

**Hints** • The DTMF code can also be entered using keypad keys.

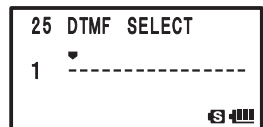
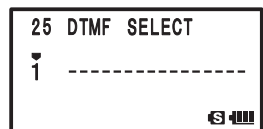
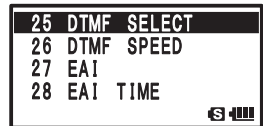
- To correct the DTMF code, press the  (to the right) or  (to the left) key to move the cursor to the character you want to correct, and enter a correct character over it.
- Pressing the  key more than 1 second allows you to delete the character at the cursor position and the subsequent characters.







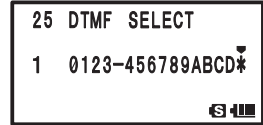
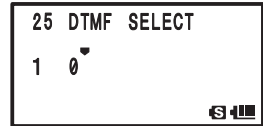



## Using the DTMF Function

- 9 Press the  key.  
The cursor moves.
- 10 Repeat steps 6 and 7 to enter the remaining characters of the DTMF code.  
**Hints** The maximum length of the DTMF code is 16 characters.
- 11 Locate the cursor at the last character, and then press the  key more than 1 second.  
The DTMF code is determined.
- 12 Press the  key more than 1 second again.  
The Set mode is canceled.







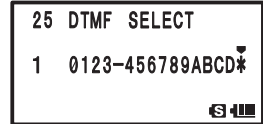



### Confirming the Entered DTMF Code by the Sound

- 1 Press the  key more than 1 second.  
The Set mode is selected.
- 2 Turn the  knob to select "4 SIGNALING".
- 3 Press the  key briefly.
- 4 Turn the  knob to select "5 DTMF SELECT".
- 5 Press the  key briefly.
- 6 Turn the  knob to select a registered channel.
- 7 Press the  key briefly.  
You can confirm the registered DTMF code by the DTMF tones.
- 8 Press the  key more than 1 second.
- 9 Press the  key more than 1 second again.  
The Set mode is canceled.



### Sending the Registered DTMF Code

- 1 Press the  key more than 1 second.  
The Set mode is selected.
- 2 Turn the  knob to select "4 SIGNALING".
- 3 Press the  key briefly.
- 4 Turn the  knob to select "4 DTMF MODE".
- 5 Press the  key briefly.
- 6 Turn the  knob to select "MODE".
- 7 Turn the  knob to select "AUTO".
- 8 Press the  key more than 1 second.
- 9 Press the  key more than 1 second again. The auto dialer is activated.

## Using the DTMF Function

- 10** While pressing the  switch, press your desired key (  **1** to  **0** ).

Using a keypad key, select the channel of the DTMF memory containing the DTMF code to be sent.

- Hints**
- The registered DTMF code is sent.
  - The sent DTMF tones are heard from the speaker.

- 11** Release the  switch.

Even after the  switch is released, sending of the DTMF signal continues until it is completed.

## Sending a DTMF Code Manually

- 1** Press the  key more than 1 second.

The Set mode is selected.

- 2** Turn the  knob to select “4 SIGNALING”.

- 3** Press the  key briefly.

- 4** Turn the  knob to select “4 DTMF MODE”.



- 5** Press the  key briefly.

- 6** Turn the  knob to select “MANUAL”.

- 7** Press the  key more than 1 second.

- 8** Press the  key more than 1 second again.

Manual entry is enabled.

- 9** While pressing the  switch, press one of  **1** to  **0** keys.

Using a keypad key, select the DTMF code to be sent.

- Hints**
- The DTMF code corresponding to the pressed key is sent. (See the table shown below.)
  - The sent DTMF tones are heard from the speaker.

- 10** Release the  switch.

Even after the  switch is released, sending of the DTMF signal continues until it is completed.





### Hint

- A DTMF code is a combination of two frequencies.

	1209 Hz	1336 Hz	1477 Hz	1633 Hz
697 Hz	1	2	3	A
770 Hz	4	5	6	B
852 Hz	7	8	9	C
941 Hz	*	0	#	D



## Using the Tone Squelch Function

The tone squelch opens the squelch only when a signal containing the specified frequency tone is received. Use of the digital code squelch (DCS) opens the squelch only when a signal containing the specified DCS code is received. The tone squelch function blocks monitoring of communications between other stations even when waiting for call by a specific station for a long time.

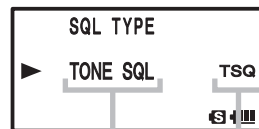
- 1 Press the  key more than 1 second.
- 2 Turn the  knob to select "4 SIGNALING".
- 3 Press the  key briefly.
- 4 Turn the  knob to select "11 SQL TYPE".
- 5 Press the  key briefly.



The Set mode item "11 SQL TYPE" is selected.

- 6 Turn the  knob to select a squelch type.  
Select a squelch type with reference to the table shown below.
- 7 Press the  key more than 1 second.  
The selected squelch type is determined.
- 8 Press the  key more than 1 second again.  
The Set mode is canceled.

### Hints

- The tone squelch setting or the DCS setting is also effective for scanning. If scanning is performed with the tone squelch or the DCS function turned on, it stops only when a signal containing a tone of the specified frequency or a signal containing the specified DCS code is received.
- Pressing the Monitor switch allows you to hear signals that do not contain a tone or DCS code, the signal that does not contain the tone of the specified frequency, and the signal which does not contain the specified DCS code,
- Pressing the  key more than 1 second and changing the Set mode item allows you to use this function more conveniently.  
 "4 SIGNALING" → "3 DCS INVERSION": Allows you to receive the DCS code of the inverted phase.  
 "4 SIGNALING" → "10 SQL EXPANTION": Allows you to specify different squelch types for transmission and reception respectively.

Display	Operation
OFF	Turns off the tone sending function, tone squelch function, etc.
TONE	Just sends tones ("TN" is displayed).
TONE SQ	Turns on the tone squelch function ("TSG" is displayed).
DCS	Turns on the digital code squelch ("DCS" is displayed).
REV TONE	Turns on the reverse tone function ("RTN" is displayed). Used to monitor communications based on the squelch control system in which a tone signal is contained when communication is not performed and the tone signal disappears when communication starts.









## Using the Tone Squelch Function

Display	Operation
PAGER (See page 124)	Turns on a new pager function ("PAG" is displayed). When using FT1DRs with your friends, specifying personal codes (each code is composed of two tones) allows only a specific station to be called.
D CD*	Sends a DCS code only in case of transmission ("DC" is displayed).
TONE-DCS*	Sends a tone signal in case of transmission, and waits for a DCS code in case of reception ("T-D" is displayed).
D CD-TONE SQL*	Sends a DCS code in case of transmission, and waits for a tone signal in case of reception ("D-T" is displayed).

\* Press the  key more than 1 second to select the Set mode and selecting "4 SIGNALING" → "10 SQL EXPANTION" → "ON" will add options "D CD", "TONE-DCS", and "D CD TONESQL" to the Set mode items "4 SIGNALING" to "16 SQL TYPE", allowing you to select different types of squelches for transmission and reception.

### Selecting a Tone Frequency

You can select a tone frequency from among 50 frequencies (67.0 Hz to 254.1 Hz) (See page 181).

- 1 Specify the operating frequency.
- 2 Press the  key more than 1 second.  
The Set mode is selected.
- 3 Turn the  knob to select "4 SIGNALING".
- 4 Press the  key briefly.
- 5 Turn the  knob to select "12 TONE SQL FREQ".
- 6 Press the  key briefly.
- 7 Turn the  knob to select a tone frequency.
- 8 Press the  key briefly.  
The selected tone frequency is determined.
- 9 Press the  key more than 1 second.  
The Set mode is canceled.

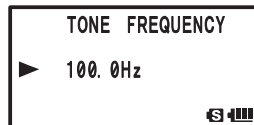
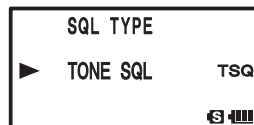









#### Hints

- The tone frequency selected using the above-described procedure is also effective when only the tone is sent out.
- By default, the tone frequency is set to 88.5 Hz.

## Searching for the Frequency of the Tone Squelch Used by the Remote Station



The frequency of the tone squelch used by the remote station can be searched for and displayed.

- 1 Press the  key more than 1 second.  
The Set mode is selected.
- 2 Turn the  knob to select "4 SIGNALING".
- 3 Press the  key briefly.
- 4 Turn the  knob to select "11 SQL TYPE".
- 5 Press the  key briefly.
- 6 Turn the  knob to select "TONE SQL".
- 7 Press the  key briefly.
- 8 Receive the signal from the remote station.
- 9 Press the  key more than 1 second.  
"TONE SEARCH" is displayed.
- 10 Release the  key.

Search for the tone frequency starts.

When a coincident frequency is detected, a beep is emitted and search stops temporarily. The detected tone frequency blinks.

**Hints** To set the found tone frequency, use the following procedure:

- Press the  key. → A beep is emitted. → Press the  key more than 1 second. → Press the  key more than 1 second again.  
The Set mode is canceled.

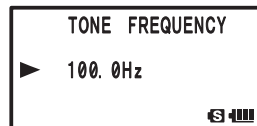
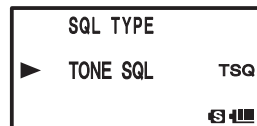







### Hint

For the operation to perform when scanning stops, refer to "Selecting a Reception Method When Scanning Stops" (See page 57).



## Selecting a DCS Code

You can select a DCS code from among 104 DCS codes (023 to 754) (See page 170).

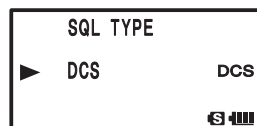
- 1 Specify the operating frequency.
- 2 Press the  key more than 1 second.  
The Set mode is selected.
- 3 Turn the  knob to select "4 SIGNALING".
- 4 Press the  key briefly.
- 5 Turn the  knob to select "2 DCS CODE".
- 6 Press the  key briefly.
- 7 Turn the  knob to select a DCS code.



## Using the Tone Squelch Function

- 8 Press the  key more than 1 second.  
The selected DCS code is determined.
- 9 Press the  key more than 1 second.  
The Set mode is canceled.

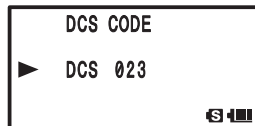











### Hint

- By default, the DCS code is set to "023".

## Searching for the Frequency of the DCS Used by the Remote Station

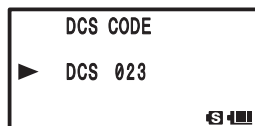
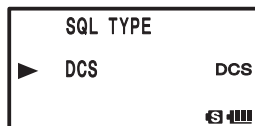

The DCS code used by the remote station can be searched for and displayed.

- 1 Press the  key more than 1 second.  
The Set mode is selected.
- 2 Turn the  knob to select "4 SIGNALING".
- 3 Press the  key briefly.
- 4 Turn the  knob to select "11 SQL TYPE".
- 5 Press the  key briefly.
- 6 Turn the  knob to select "DCS".
- 7 Press the  key briefly.  
The selected DCS is determined.
- 8 Turn the  knob to select "2 DCS CODE".
- 9 Press the  key briefly.
- 10 Receive the signal from the remote station.
- 11 Press the  key more than about 1 second.  
"DCS SEARCH" is displayed.
- 12 Release the  key.  
Search for the DCS code starts.



When a coincident DCS code is found, a beep is emitted and search stops temporarily. The found DCS code blinks.

**Hints** To set the found DCS code, use the following procedure:

- Press the  key. → A beep is emitted. → Press the  key more than 1 second. → Press the  key more than 1 second again.  
The Set mode is canceled.

### Hint









- For the operation to perform when scan stops, refer to "Selecting a Reception Method When Scanning Stops" (See page 57).



## Using the Tone Squelch Function

### Notification of Call from the Remote Station by Vibration of the Vibrator

Call from the remote station (reception of a signal containing a coincident tone or DCS) can be notified by the vibrator.

- 1 Press the  key more than 1 second.  
The Set mode is selected.
- 2 Turn the  knob to select "7 CONFIG".
- 3 Press the  key briefly.
- 4 Turn the  knob to select "22 VIBRATOR".
- 5 Press the  key briefly.
- 6 Turn the  knob to select "MODE".
- 7 Turn the  knob to select "SIGNALING".
- 8 Press the  key more than 1 second.  
The vibrator function is activated.
- 9 Press the  key more than 1 second again.  
The Set mode is canceled.

**Hints** To turn off the vibrator function, select "OFF" in step 6.

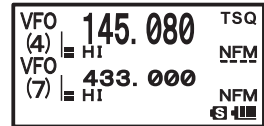
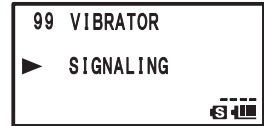
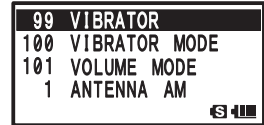





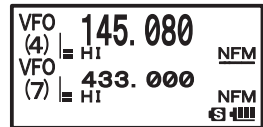

#### Hints

- The vibrator function can be set for all frequency bands belonging to A- and B-bands.
- Selecting "7 CONFIG" → "23 VIBRATOR" → "BUSY" in the Set mode will cause the vibrator to start vibrating when the BUSY LED lights upon receipt of a signal. A solid line (—) is displayed under the mode indication on the LCD.
- If you operate a key while the vibrator is vibrating, the vibrator stops vibrating and enters the suspended state. In this case, the dashed line (----) or solid line (—) on the LCD blinks. If the BUSY state is not held continuously more than 5 seconds, the suspended state is canceled.
- If the  switch is operated to change the communication mode from transmission to reception when the vibrator is turned ON, the vibrator function is turned off for 5 seconds and the dashed line (----) or solid line (—) on the LCD blinks.



### Selecting a Vibrator Operation Mode

- 1 Press the  key more than 1 second.  
The Set mode is selected.
- 2 Turn the  knob to select "7 CONFIG".
- 3 Press the  key briefly.
- 4 Turn the  knob to select "22 VIBRATOR MODE".
- 5 Press the  key briefly.
- 6 Turn the  knob to select "SELECT".

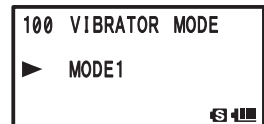



## Using the Tone Squelch Function

- 7 Turn the  knob to select a vibrator operation mode.







**Remarks** Default: MODE1

MODE1	The vibrator vibrates continuously.
MODE2	The vibrator operates at long intervals.
MODE3	The vibrator operates at short intervals.



- 8 Press the  key more than 1 second.  
The selected vibrator mode is determined.
- 9 Press the  key more than 1 second again.  
The Set mode is canceled.

## Notification of Call from a Remote Station by the Bell Bell Function

Call from a remote station (reception of a signal containing a coincident tone or DCS) can be notified by the bell sound and the  icon blinking on the LCD.



- 1 Press the  key more than 1 second.  
The Set mode is selected.
- 2 Turn the  knob to select "4 SIGNALING".
- 3 Press the  key briefly.
- 4 Turn the  knob to select "1 BELL".
- 5 Press the  key briefly.
- 6 Turn the  knob to select "RINGER".
- 7 Turn the  knob to select "BELL".

When the tone squelch or DCS function is turned on, the  icon is displayed.

- 8 Press the  key more than 1 second.  
The bell function is turned on.
- 9 Press the  key more than 1 second again.  
The Set mode is canceled.

**Hint** To turn off the bell function, select "OFF" in step 6.





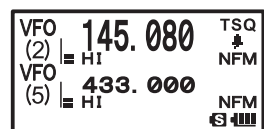
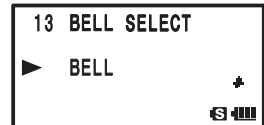

### Hints

- To use the bell function, turn on the tone squelch or DCS function.
- The bell function cannot be used via the repeater.
- The  icon is displayed when the bell function is turned on.  
Upon receipt of a signal from a remote station, the  icon blinks.



## Using the Tone Squelch Function

### Changing the Number of Times the Bell Rings



- 1 Press the  key more than 1 second.  
The Set mode is selected.
- 2 Turn the  knob to select "4 SIGNALING".
- 3 Press the  key briefly.
- 4 Turn the  knob to select "1 BELL".
- 5 Press the  key briefly.
- 6 Turn the  knob to select "SELECT".
- 7 Turn the  knob to select a number of times the bell rings.

12	BELL RINGER
13	BELL SELECT
14	BUSY LED
15	CLOCK SHIFT



**Remarks** Default: Once

**Hint** You can select the number of times the bell rings from among 1-20 and "continuous".

- 8 Press the  key more than 1 second.  
The selected number of times the bell rings is determined.
- 9 Press the  key more than 1 second again.  
The Set mode is canceled.

### Calling Only a Specific Station New Pager Function

When using FT1DRs with your friends, specifying personal codes (each code is composed of two CTCSS codes) allows only a specific station to be called. Even if the called person is not near his or her FT1DR, the information on the LCD indicates that he or she has been called.

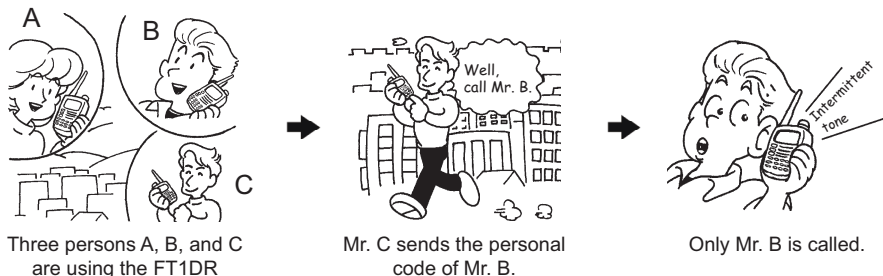

## Using the Tone Squelch Function

### Flow of Operation to Use the Pager Function

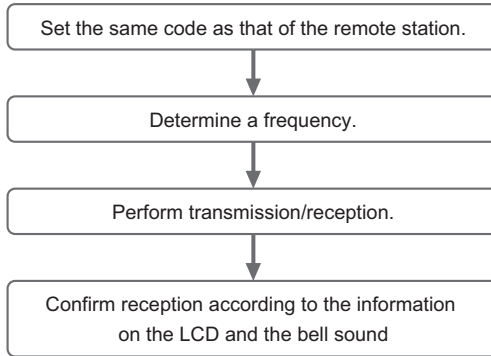

### Setting the Code of Your Station

Set the “personal code (your code)” used to be called by other stations.

- 1 Press the key more than 1 second.  
The Set mode is selected.
- 2 Turn the knob to select “4 SIGNALING”.
- 3 Press the key briefly.
- 4 Turn the knob to select “6 PAGER”.
- 5 Press the key briefly.
- 6 Turn the knob to select “CODE-RX”.
- 7 Turn the knob to select a code.  
Select the first code from among 1-50.
- 8 Press the key briefly.  
The cursor “\*” moves.
- 9 Turn the knob to select a code.  
Select the second code from among 1-50.

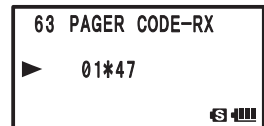
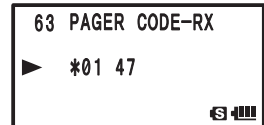
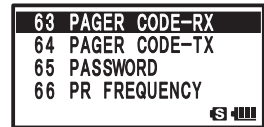

**Precaution** The second code must be different from the first code.









- 10 Press the key more than 1 second.  
The code of your station is determined.
- 11 Press the key more than 1 second again.

**Hints** • Default: “05 47”

- The first and second codes contained in your personal code may be inverted, i.e., “05 47” and “47 05” are recognized as being the same code.
- If the same personal code (group code) is specified for all persons, all persons can be called at the same time.

## Using the Tone Squelch Function





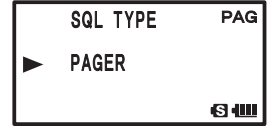







### Turning on the New Pager Function

- 1 Press the  key more than 1 second.  
The Set mode is selected.
- 2 Turn the  knob to select "4 SIGNALING".
- 3 Press the  key briefly.
- 4 Turn the  knob to select "11 SQL TYPE".
- 5 Press the  key briefly.
- 6 Turn the  knob to select "PAGER".
- 7 Press the  key briefly.  
The new pager function is turned on.
- 8 Press the  key more than 1 second.
- 9 Press the  key more than 1 second again.  
The Set mode is canceled.





Thus, you can "call" or "wait" a remote station using the new pager function.

### Calling a Specific Station

- 1 Press the  key more than 1 second.  
The Set mode is selected.
- 2 Turn the  knob to select "4 SIGNALING".
- 3 Press the  key briefly.
- 4 Turn the  knob to select "11 SQL TYPE".
- 5 Press the  key briefly.
- 6 Turn the  knob to select "PAGER".
- 7 Press the  key briefly.  
The new pager function is selected.
- 8 Turn the  knob to select "4 SIGNALING".
- 9 Press the  key briefly.
- 10 Turn the  knob to select "6 PAGER".
- 11 Press the  key briefly.
- 12 Turn the  knob to select "CODE-TX".
- 13 Turn the  knob to select the code of the remote station.

Select the first code of the remote station.

**Precaution** Register the pager code of the remote station in advance.

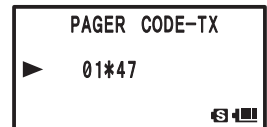
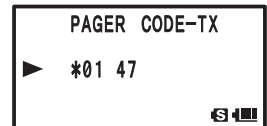
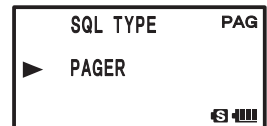

- 14 Press the  key briefly.  
The cursor "\*" moves.
- 15 Turn the  knob to select the code of the remote station.  
Select the second code of the remote station.



PAG is displayed.



## Using the Tone Squelch Function

- 16 Press the  key more than 1 second.  
The code is determined.
- 17 Press the  key more than 1 second again.  
The Set mode is canceled.
- 18 Press the  key.  
Call the remote station.

## Being Called by the Remote Station (Standby Operation)

If you use the new pager function at the same frequency as that of the remote station, "PAG" displayed on the LCD changes to "PIN", allowing you to check that you have been called by the remote station. In addition, if you turn on the "bell function (See page 140)", you can confirm call by the remote station by the "PAG" display, the blinking  icon, and the bell sound. In addition, if you turn on the "vibrator function (See page 139)", you can confirm call by the remote station by vibration of the vibrator.







### Hint

Selecting "4 SIGNALING" → "9 PAGER ANS-BACK" → "ON" in the Set mode places the FT1DR in the transmission state (for about 2.5 seconds) automatically when called by the remote party and notifies the remote party of getting ready for communication.

## Set Mode

### Selecting Set Mode Items

The Set mode allows you to select various functions from lists so that you can use your FT1DR more conveniently.

- 1 Press the  key more than 1 second.  
The Set mode is selected.
- 2 Turn the  knob to select a Set mode item.
- 3 Press the  key briefly.
- 4 Turn the  knob to select an option.  
Select an option.
- 5 Press the  key more than 1 second.
- 6 Press the  key more than 1 second again.  
The Set mode is canceled.

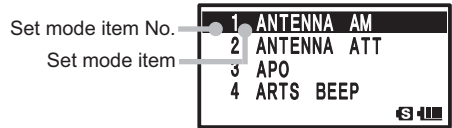

### Resetting the Set Mode Items

The Set mode items you have set can be restored to the defaults by following the procedure described below. However, to restore the following items to the defaults, all resetting (See page 15) is required.





#### Set mode item

- |                     |                    |
|---------------------|--------------------|
| 7 BANK NAME         | 15 CLOCK SHIFT     |
| 16 CW ID            | 21 DCS CODE        |
| 22 DCS INVERSION    | 25 DTMF SELECT     |
| 29 EMERGENCY SELECT | 33 HALF DEVIATION  |
| 38 INTERNET CODE    | 41 INTERNET SELECT |
| 48 MENORY FAST STEP | 49 MENORY NAME     |
| 51 MENORY SKIP      | 55 MESSAGE SELECT  |
| 63 PAGER CODE-RX    | 64 PAGER CODE-TX   |
| 71 RPT SHIFT        | 72 RPT SHIFT FREQ  |
| 90 SQL TYPE         | 93 TONE FREQUENCY  |

#### APRSR/GPS Set mode items

- |                |                     |
|----------------|---------------------|
| 5 APRS MSG TXT | 13 BEACON STATS TXT |
| 16 DIGI PATH   | 21 MSG GROUP        |
| 22 MY CALLSIGN | 23 MY POSITION      |
| 24 MY SYMBOL   |                     |

## Set Mode

- 1 While pressing the <sup>DSEL D.TX</sup>  and <sup>DW</sup>  keys, press the  key.  
The FT1DR is turned on. When a beep is heard, release the keys.
  - 2 When "SET MODE RESET PUSH F KEY" is displayed, press the <sup>V.M</sup>  key.  
A beep is emitted.
- Hints** To cancel resetting, press any key other than the <sup>V.M</sup>  key.

## Set Mode Item List

Set mode item No./Item	Description of function	Option (Bold letters: Default)	Reference page
<b>1 DISPLAY</b>			
1-1 DISPLAY SELECT	Display/hide the GPS screen each time the <sup>SET</sup>  key is pressed briefly.	GPS ON / GPS OFF	
1-2 BAND SCOPE	Select a spectrum analyzer operation mode.	ONCE / CONTINUOUS / FULL TIME	
1-3 LAMP	Set the time during which the backlight and keys stay lit.	OFF / 2-10 SEC(KEY) / CONTINUOUS	
1-4 LANGUAGE	Select Japanese or English as the display language for Set mode items, options, etc.	JAPANESE / ENGLISH	
1-5 LCD CONTRAST	Set the LCD contrast level.	LEVEL 1 to LEVEL 15	
1-6 LCD DIMMER	Set the brightness level of the LCD backlight and keypad key light.	LEVEL 1 to LEVEL 6	
1-7 OPENING MESSAGE	Select an opening message type.	NORMAL / OFF / DC / MESSAGE / CALLSIGN	
1-8 SENSOR INFO	Voltage/temperature display function	VOLTAGE & TEMPERATURE	
1-9 S-METER SYMBOL	Select a S/PO meter symbol display type.	4 types	
<b>2 TX / RX</b>			
<b>2-1 MODE</b>			
2-1-1 ANTENNA AM	Select an AM radio antenna type.	BAR & EXT. ANTEANN/BAR ANTENNA	
2-1-2 ANTENNA ATT	Turn on/off the attenuator.	OFF / ON	
2-1-3 FULL DUPLEX	Turn on/off the full duplex function.	OFF / ON	
2-1-4 HALF DEVIATION	Set the transmission modulation level.	OFF / ON	
2-1-5 RX MODE	Select a reception mode.	AUTO / NFM / AM	
<b>2-2 DIGITAL</b>			
2-2-1 DIGITAL MODE	T.B.D.	T.B.D.	
2-2-2 SQL TYPE	T.B.D.	T.B.D.	
2-2-3 MY CALLSIGN SEL	T.B.D.	T.B.D.	
2-2-4 MY CALLSIGN	T.B.D.	T.B.D.	
2-2-5 DISTINATION	T.B.D.	T.B.D.	
2-2-6 TEXT	T.B.D.	T.B.D.	



**Set Mode**

Set mode item No./Item	Description of function	Option (Bold letters: Default)	Reference page
2-2-7 DSP Ver	T.B.D.	T.B.D.	
<b>2-3 AUDIO</b>			
2-3-1 MIC GAIN	Adjust the microphone level.	LEVEL 1 to LEVEL 9	
2-3-2 MUTE	Set the muting level on the non-operating side when a signal is received on the operating band side.	OFF / MUTE 30% / MUTE 50% / MUTE 100%	
2-3-3 RX AF DUAL	Select a mode for simultaneous reception of a radio broadcast.	1-SEC COMMUNICATION to 10-SEC COMMUNICATION/ FIXED / 1-SEC TRANSMISSION to 10-SEC TRANSMISSION	
2-3-4 VOL MODE	Select a <b>[VOL]</b> key function.	NORMAL / AUTO BACK	
<b>3 MEMORY</b>			
3-1 BANK LINK	Set up a memory bank.	BANK 1 to BANK 24, BANK LINK ON / OFF	
3-2 BANK NAME	Assign a name to a memory bank.	BANK 1 to BANK 24	
3-3 MEMORY NAME	Write a memory tag.	Max. 16 characters	
3-4 MEMORY PROTECT	Enable/disable writing into the memory.	OFF / ON	
3-5 MEMORY SKIP	Assign a skip/selected memory.	OFF / SKIP / SELECT	
3-6 MEMORY WRITE	Select an auto increment mode for memory writing.	NEXT / LOWER	
<b>4 SIGNALING</b>			
4-1 BELL	Set up the bell function.	RINGER: OFF / BELL SELECT: ONCE to 20 TIMES/ CONTINUOUS	
4-2 DCS CODE	Select a DCS code	DCS 023 to DCS 754	
4-3 DCS INVERSION	Select a combination of DCS inversion codes in terms of communication direction.	RECEPTION – IN-PHASE, TRANSMISSION – IN-PHASE RECEPTION – INVERTED PHASE, TRANSMISSION – IN-PHASE RECEPTION – BOTH-PHASE, TRANSMISSION – IN-PHASE RECEPTION – IN-PHASE, TRANSMISSION – INVERTED PHASE RECEPTION – INVERTED PHASE, TRANSMISSION – INVERTED PHASE RECEPTION – BOTH-PHASE, TRANSMISSION – INVERTED PHASE	

Functions Used As Needed

**Set Mode**

Set mode item No./Item	Description of function	Option ( <b>Bold letters: Default</b> )	Reference page
4-4 DTMF MODE	Select a DTMF memory sending mode. Select a DTMF sending delay time. Select a DTMF sending time.	MODE: MANUAL / AUTO DELAY: 50ms / 250ms / 450ms / 750ms / 1000ms SPEED: 50ms / 100ms	
4-5 DTMF SELECT	Select a DTMF auto dialer channel or code (16 characters).	1 to 10	
4-6 PAGER	Turn on/off the pager answerback function and specify a personal code (transmission/reception).	ANS-BACK: OFF / ON CODE-RX: 01 02 to 50 49 CODE-TX: 01 02 to 50 49	
4-7 PR FREQUENCY	Select a no-communication squelch frequency.	300 Hz to 3000 Hz	
4-8 SQL LEVEL	Select a squelch level.	LEVEL 0 to LEVEL 15	
4-9 SQL S-METER	Select an S-meter squelch level.	OFF/LEVEL 1 to LEVEL 9	
4-10 SQL EXPANTION	Enable or disable selection of different squelch types for transmission and reception.	OFF / ON	
4-11 SQL TYPE	Select a squelch type.	OFF / TONE / TONE SQL / DCS / REV TONE / JR FREQ / PR FREQ / PAGER	
4-12 TONE SQL FREQ	Select a tone frequency.	67.0Hz to 254.1Hz	
4-13 TONE-SRCH	Enable or disable emission of tone during tone search. Turn on/off the muting function and select a tone search speed.	MUTE: ON / OFF SPEED: HIGH / LOW	
<b>5 SCAN</b>			
5-1 PRI TIME	Select a priority channel monitoring interval.	0.1 SEC to 10 SEC	
5-2 SCAN LAMP	Turn the lamp on/off when scanning stops.	ON / OFF	
5-3 SCAN RE-START	Set a scanning restart time.	0.1 SEC to 10 SEC	
5-4 SCAN RESUME	Select a scanning stop mode.	BUSY / HOLD / 2 SEC to 10 SEC	
<b>6 ARTS / WIRES</b>			
6-1 WIRES MANU/AUTO	T.B.D.	T.B.D.	
6-2 WIRES CODE	T.B.D.	T.B.D.	
6-3 WIRES KEY	T.B.D.	T.B.D.	
6-4 WIRES MODE	T.B.D.	T.B.D.	
6-5 WIRES SELECT	T.B.D.	T.B.D.	
* For more details on functions, refer to the included CD-ROM.			
<b>7 CONFIG</b>			
7-1 APO	Set the APO operating time.	OFF / 30 MIN /1 HOUR 00 MIN to 12 HOURS 00 MIN	
7-2 BCLO	Turn on the busy channel lockout function.	OFF / ON	

Functions Used As Needed

**Set Mode**

Set mode item No./Item	Description of function	Option ( <b>Bold letters: Default</b> )	Reference page
7-3 BEEP	Set up the beep output function and the function of emitting a beep when a band edge/CH1 is encountered.	SELECT: KEY&SCAN / KEY / OFF EDGE: OFF / ON	
7-4 BUSY LED	Turn on/off the BUSY LED	A BAND: ON / OFF B BAND: ON / OFF RADIO: ON / OFF	
7-5 CLOCK TYPE	Select a clock type.	A / B	
7-6 GPS LOG	Set the duration of GPS access.	OFF / 1 SEC / 2 SEC / 5 SEC / 10 SEC / 30 SEC / 60 SEC	
7-7 HOME VFO	Enable/disable VFO transfer via the home channel.	ENABLE / DISABLE	
7-8 LED LIGHT	Turn on/off the white LED flashlight.	WHITE LED ON	
7-9 LOCK	Select a lock mode.	KEY&DIAL / PTT / KEY&PTT / DIAL&PTT / ALL / KEY / DIAL	
7-10 MONI/T-CALL	Select a monitor switch or T-CALL switch.	MONI / T-CALL	
7-11 TIMER	Set the power ON/OFF timer.	ON: 00:00 to 23:59 ON / OFF OFF: 00:00 to 23:59 ON / OFF	
7-12 PASSWORD	Turn on/off the password function.	ON / OFF [ - - - - ]	
7-13 PTT DELAY	Set the PTT delay time.	OFF / 20ms / 50ms / 100ms / 200ms	
7-14 RPT ARS	Turn on/off the ARS function.	ON / OFF	
7-15 RPT SHIFT	Select a repeater shift direction.	SIMPLEX / -RPT / +RPT	
7-16 RPT SHIFT FREQ	Select a repeater shift width.	0.000 MHz to 150.000 MHz	
7-17 SAVE RX	Set the reception save time.	OFF / 0.2 SEC (1:1) to 60.0 SEC (1:300)	
7-18 STEP	Select a channel step.	AUTO / 5.0KHZ to 100KHZ	
7-19 DATE & TIME ADJ	Set up the built-in clock function.	-	
7-20 TOT	Set the timeout timer.	OFF / 30 SEC to 10 MIN 00 SEC	
7-21 VFO MODE	Select the frequency selection range in the VFO mode.	ALL / BAND	
7-22 VIBRATOR	Select a vibrator mode and set up the vibrator function.	MODE: OFF / BUSY / SIGNALING SELECT: MODE1 / MODE2 / MODE3	
<b>8 APRS</b>			
8-1 APRS AF DUAL	Turn on/off the muting function when both the APRS function and AF dual function are active.	ON / OFF	

Functions Used As Needed

**Set Mode**

Set mode item No./Item	Description of function	Option ( <b>Bold letters: Default</b> )	Reference page
8-2 APRS FILTER	Select a filter function.	Mic-E: ON / OFF POSITION: ON / OFF WEATHER: ON / OFF OBJECT: ON / OFF ITEM: ON / OFF STATUS: ON / OFF OTHER: OFF / ON ALTNET: ON / OFF	
8-3 APRS MODEM	Select an APRS baud rate.	OFF / 1200bps / 9600bps	
8-4 APRS MUTE	Turn on/off the B-band AF muting function when APRS is set.	ON / OFF	
8-5 APRS POPUP	Select a pop-up beacon type.	Mic-E: OFF / ALL 2s to ALL 60s / ALLCNT / BND2s to BND60s / BNDCNT POSITION: OFF / ALL2s to ALL60s / ALLCNT / BND2s to BND60s / BNDCNT WEATHER: OFF / ALL2s to ALL60s / ALLCNT / BND2s to BND60s / BNDCNT OBJECT: OFF / ALL2s to ALL60s / ALLCNT / BND2s to BND60s / BNDCNT ITEM: OFF / ALL2s to ALL60s / ALLCNT / BND2s to BND60s / BNDCNT STATUS: OFF / ALL2s to ALL60s / ALLCNT / BND2s to BND60s / BNDCNT OTHER: OFF / ALL2s to ALL60s / ALLCNT / BND2s to BND60s / BNDCNT	
8-5 APRS POPUP	Select a pop-up beacon type.	MY PACKET: OFF / ALL2s to ALL60s / ALLCNT / BND2s to BND60s / BNDCNT	

Functions Used As Needed

**Set Mode**

Set mode item No./Item	Description of function	Option ( <b>Bold letters: Default</b> )	Reference page
8-6 APRS RINGER	Turn on/off the bell when a beacon is received.	Mic-E: ON / OFF POSITION: ON / OFF WEATHER: ON / OFF OBJECT: ON / OFF ITEM: ON / OFF STATUS: ON / OFF OTHER: ON / OFF MY PACKET: ON / OFF	
8-7 APRS UNIT	Select the units for APRS display.	Position: MM.MM' / MM'SS' Distance: km / mile Speed: km/h / knot / mph Altitude: m / ft Temp: °C / °F Rain: mm / inch Wind: m/s / mph	
8-8 APRS TX DELAY	Set the data sending delay time.	100ms / 150ms / 200ms / 250ms / 300ms / 400ms / 500ms / 750ms / 1000ms	
8-9 BEACON INFO	T.B.D.	AMBIGUITY: OFF / 1 dig to 4 dig SPD / CSE: ON / OFF ALTITUDE: ON / OFF	
8-10 BEACON INTERVAL	Set a beacon automatic sending interval.	30sec / 1min / 2min / 3min / 5min / 10min / 15min / 20min / 30min / 60min	
8-11 BEACON STATS TXT	Make settings for status text entry.	S.TXT: ON / OFF TX RATE: 1/1 to 1/8 1 to 5 CH	
8-12 BEACON TX	Select automatic or manual sending of beacon.	AUTO / MANUAL	
8-13 COM PORT SETTING	Set up the COM port.	STATUS: ON / OFF SPEED: 4800 / 9600 / 19200 / 38400 INPUT: OFF / GPS	
8-14 DIGI PASS	Select a digipeater route.	P1 OFF P2 1 WIDE1-1 P3 1 WIDE1-1 / 2 WIDE2-1 P4 ..... - .. P5 ..... - .. P6 ..... - .. P7 ..... - .. P8 ..... - ..	
8-15 GPS DATUM	Select a datum used for the GPS function.	WGS-84 / Tokyo Mean / Tokyo Japan / Tokyo Korea / Tokyo Okinawa	
8-16 GPS POWER	Turn on/off the GPS function.	GPS ON / GPS OFF	
8-17 GPS TIME SET	Turn on/off the GPS time and date automatic acquisition function.	AUTO / MANUAL	

Functions Used As Needed

**Set Mode**

Set mode item No./Item	Description of function	Option ( <b>Bold letters: Default</b> )	Reference page
8-18 GPS UNIT	Select the units for GPS display.	Position: .MMM' / 'SS" Speed: Km/h / Knot / mph Altitude: m / ft	
8-19 MY CALLSIGN	Specify the call sign of your station.	-	
8-20 MY POSITION	Set the location of your station.	GPS / Lat N * ****.***' / P1 to P10	
8-21 MY SYMBOL	Set the symbol of your station.	64 Icon	
8-22 POSITION COMMENT	Set up the position comment function.	Off Duty / En Route / In Service / Returning / Committed / Special / Priority / Custom 0 to 6 / EMERGENCY!	
8-23 SmartBeaconing	Set up the smart beaconing function.	STATUS: OFF / TYPE1 / TYPE2 / TYPE3 LOW SPD: 2Km/h to 30Km/h HIGH SPD: 31Km/h to 70Km/h SLOW RATE: 1min to 100min FAST RATE: 10sec to 180sec TURN ANGL: 5° to 90° TURN SLOP: 1 to 255 TURN TIME: 5sec to 180sec	
8-24 TIME ZONE	Set the time zone.	UTC ± 13.0 H	
* For more details of functions, refer to the included CD-ROM.			
<b>9 SD CARD</b>			
9-1 FORMAT	Initialize the micro SD memory card.	Format the micro SD memory card.	
9-2 STORE/RECALL	Write or read the information about your FT1DR into or from the micro SD memory card.	STORE: Copy the information about your FT1DR to the micro SD memory card. RECALL: Read data from the micro SD memory card and write it over the existing information about your FT1DR.	
<b>10 OPTION</b>			
10-1 MH-85	T.B.D.	T.B.D.	

Functions Used As Needed

## General

Frequency Range:	RX: 0.5 - 1.8 MHz, 1.8 - 30 MHz, 30 - 76 MHz, 76 - 108 MHz, 108 - 137 MHz, 137 - 174 MHz, 174 - 222 MHz, 222 - 420 MHz, 420 - 470 MHz, 800 - 999 MHz (Cellular Blocked)
	TX: 144 - 148 MHz, 430 - 450 MHz
Channel Steps:	5/6.25/8.33/9/10/12.5/15/20/25/50/100 kHz
Mode of Emission:	F1D, F2D, F3E, F7W
Antenna Impedance:	50 Ω, unbalanced
Frequency Stability:	±2.5 ppm (-10 °C to +50 °C)
Operating Temperature Range:	-20 °C to +60 °C
Supply Voltage:	7.4 V DC (Rated), 4 - 9 V DC (Battery Input), 11 - 16 V DC (EXT DC Input)

### Current Consumption (Approx.):

RX:	250 mA (Analog / Mono Band) 350 mA (Digital / Mono Band)
TX:	1.7 A (144 MHz / Analog) 1.8 A (144 MHz / Digital) 2.0 A (430 MHz / Analog) 2.1 A (430 MHz / Digital)

Case Size (W × H × D): 60(W) × 95(H) × 28(D) mm (w/o knobs & antenna)

Weight (Approx.): 250g (with Battery & Antenna)

## Transmitter

Output Power:	5 W (144 / 430 MHz), 2.5 W (144 / 430MHz) 1.0 W (144 / 430 MHz), 0.1 W (144 / 430MHz)
Modulation Type:	Variable Reactance
Maximum Deviation:	±5 KHz,
Spurious Radiation:	better than -60 dB
Modulation Distortion:	less than 3%
Microphone Impedance:	2 kΩ

## Receiver

Circuit Type:	Double-conversion super heterodyne (N-FM / AM)
Intermediate Frequency:	1st: A- Band 47.25 MHz (N-FM / AM) 1st: B- Band 46.35 MHz (N-FM / AM) 2nd: 450 kHz (N-FM / AM)

## FT1DR Specifications

Sensitivity (for 12dB SINAD):	0.5 - 30 MHz: 3.00 $\mu\text{V}$ (10 dB S/N, AM)
	30 - 54 MHz: 0.35 $\mu\text{V}$ (12 dB SINAD, N-FM)
	54 - 76 MHz: 1.00 $\mu\text{V}$ (12 dB SINAD, N-FM)
	76 - 108 MHz: 1.50 $\mu\text{V}$ (12 dB SINAD, N-FM)
	108 - 137 MHz: 1.50 $\mu\text{V}$ (10 dB S/N, AM)
	137 - 140 MHz: 0.20 $\mu\text{V}$ (12 dB SINAD, N-FM)
	140 - 150 MHz: 0.16 $\mu\text{V}$ (12 dB SINAD, N-FM)
	150 - 174 MHz: 0.20 $\mu\text{V}$ (12 dB SINAD, N-FM)
	174 - 222 MHz: 1.00 $\mu\text{V}$ (12 dB SINAD, N-FM)
	300 - 350 MHz: 0.50 $\mu\text{V}$ (12 dB SINAD, N-FM)
	350 - 400 MHz: 0.20 $\mu\text{V}$ (12 dB SINAD, N-FM)
	400 - 470 MHz: 0.18 $\mu\text{V}$ (12 dB SINAD, N-FM)
	470 - 540 MHz: 1.50 $\mu\text{V}$ (12 dB SINAD, W-FM)
	540 - 800 MHz: 3.00 $\mu\text{V}$ (12 dB SINAD, N-FM)
800 - 999 MHz: 1.50 $\mu\text{V}$ (12 dB SINAD, N-FM)	
	(USA Version Cellular Blocked)
Selectivity (-6dB/-60dB):	15 kHz / 35 kHz (N-FM/AM)
Maximum AF Output:	400 mW @ 13.8V, 10% THD
	200 mW @ 7.4V, 10% THD
AF Output Impedance:	8 $\Omega$



1. Changes or modifications to this device not expressly approved by YAESU MUSEN could void the user's authorization to operate this device.
2. This device complies with part 15 of the FCC Rules. Operation is subject to the following two conditions; (1) this device may not cause harmful interference, and (2) this device must accept any interference including interference that may cause undesired operation.
3. The scanning receiver in this equipment is incapable of tuning, or readily being altered, by the User to operate within the frequency bands allocated to the Domestic public Cellular Telecommunications Service in Part 22.

Part 15.21: Changes or modifications to this device not expressly approved by YAESU MUSEN could void the user's authorization to operate this device.

#### **DECLARATION BY MANUFACTURER**

The Scanner receiver is not a digital scanner and is incapable of being converted or modified to a digital scanner receiver by any user.

**WARNING:** MODIFICATION OF THIS DEVICE TO RECEIVE CELLULAR RADIOTELEPHONE SERVICE SIGNALS IS PROHIBITED UNDER FCC RULES AND FEDERAL LAW.

***YAESU***  
***The radio***

Copyright 2012  
YAESU MUSEN CO., LTD.  
All rights reserved.

No portion of this manual  
may be reproduced  
without the permission of  
YAESU MUSEN CO., LTD.

Printed in Japan