

Preparation

Installing the Antenna

- 1 Align the antenna with the antenna terminal on the transceiver.
Caution Be sure to hold the thick base of the antenna when installing it.
- 2 Turn the antenna clockwise until it is secured.

Cautions

- Do not hold the upper part of the antenna when installing or removing it. To do so, the wire inside the antenna may break.
- Do not transmit without installing the antenna. The transmitter circuit can be damaged.
- When using an antenna other than the accessory or any other external antenna, ensure that its SWR is adjusted to 1.5 or lower.

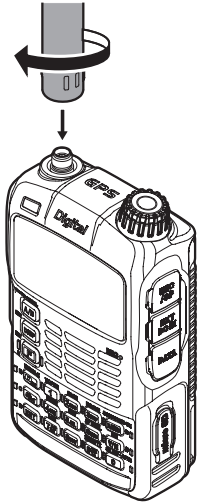

Attaching the Accessory Belt Clip/Protective Cap

Attaching the Protective Cap

- 1 Attach the protective cap
If you do not use the belt clip, attach the protective cap to the belt clip attaching screw holes on the battery pack.

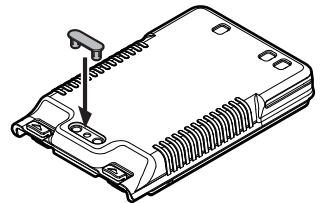

Attaching the Belt Clip

- 1 Turn over the battery pack.
- 2 Attach the belt clip to the battery pack using the supplied screws (two).

Cautions

- Be sure to use the supplied screws when attaching the belt clip. If any other screws are used, the belt clip cannot be secured firmly to the battery pack and the transceiver may drop off together with the battery pack, causing injury, breakage and other troubles.
- Be sure to attach the protective cap when the belt clip is not used.

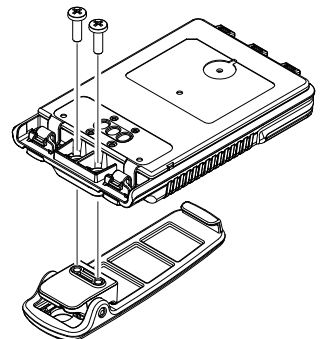

Preparation

Attaching a Hand Strap

If you attach a hand strap to the transceiver, its string which is inserted in and secured to the strap hole of the transceiver must have a diameter of 1 mm.

* The hand strap is not an accessory.

- 1 Remove the battery pack.
- 2 Attach the hand strap.

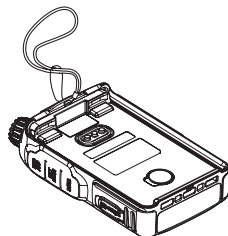

Cautions

Use a hand strap which can withstand the weight of the transceiver. If you use a hand strap which is not strong enough, the hand strap can break and the transceiver fall down, causing injury, breakage and other troubles.

How to Use the Battery Case (FBA-39) — Optional

The optional battery case (FBA-39) allows three (size) AA Alkaline batteries to be used for the power supply.

Tips

When the battery case (FBA-39) is used, you can select a power output level from:

Low Power (L1): 0.1W

Low Power (L2): Approximately 0.8W

Note that Low Power (L3) and High Power are not available.

- 1 Open the cover.
Lift up the lower right corner indicated by the hand pointer in the illustration.
- 2 Put alkaline batteries in the battery case.
Caution Use three alkaline batteries. Pay attention to polarities (+ and -) of the alkaline batteries.
- 3 Close the cover.
Push the four corners of the cover firmly to close it tightly.

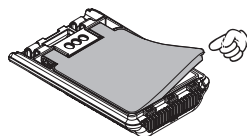

Tips

- When the battery charge is low,  lights on the LCD. When the batteries are almost exhausted,  blinks on the LCD.

Cautions

- Manganese batteries cannot be used. Rechargeable AA batteries cannot be used, either.
- Do not mix new and old batteries. The service life of new batteries may decrease.
- If you do not use the transceiver for a long period, remove the batteries from the battery case.
- If the terminal or electrode of the battery case is dirty, the transceiver can malfunction due to poor contact, resulting in overheating or explosion. If the terminal or electrode gets dirty, clean it using a dry cloth or cotton swab.

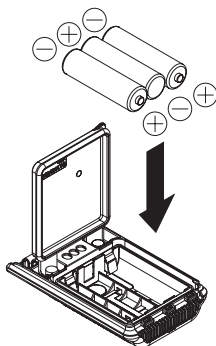

Installing/Removing the Battery Pack

Installing the Battery Pack

- 1 Insert the bottom tabs of the battery pack in the slots at the bottom of the transceiver.
- 2 Push the battery in until the latches click securely.

Caution

- When you use the transceiver for the first time after purchase or you have not used it for a long period, charge the battery pack before use.

Caution

- Risk of explosion if battery is replaced by an incorrect type. Dispose of used batteries according to the instructions..

Lock dials

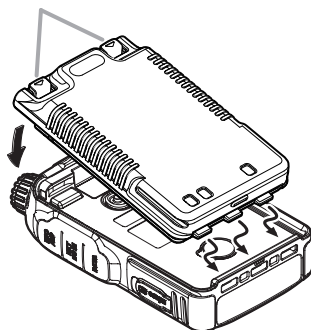

Removing the Battery Pack

- 1 While pushing down and releasing the latches, remove the battery pack, as shown in the battery pack removal illustration.

Caution

- When releasing the battery latches, be careful not to hurt your fingers and nails.

Push down on the latches in the direction of the arrow.

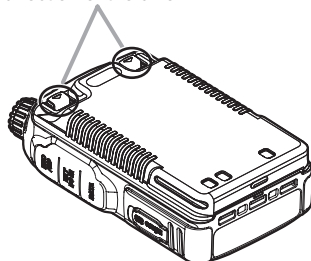

Charging the Battery Pack

Cautions

- The battery pack is rechargeable about 300 times. However, improper use such as overcharge or over-discharge can shorten its service life.
- The battery pack is a consumable item. Recharging the battery pack repeatedly will gradually shorten the duration of its usage.
- If the transceiver is not used for a long period with the battery pack installed, deterioration of the battery pack can accelerate.
- If you do not use the transceiver for a long period, be sure to store it with the battery pack removed. Even if you do not use the transceiver for a long period, install the battery pack biannually and recharge the battery pack about 50% to prevent it from over-discharging.
- Storing the battery pack in a high-temperature place can deteriorate it faster than usual. Store the battery pack in a place where the ambient temperature is -20°C to $+50^{\circ}\text{C}$ (-4°F to $+122^{\circ}\text{F}$).
- Do not drop or give a strong shock to the battery pack. It can break.

Tips

- The battery pack contains lithium-ion batteries that can be recharged for repetitive use.
- The transceiver can be used with either of the following battery packs:
 - (1) Accessory: SBR-14LI (7.2 V, 2,200 mAh)
 - (2) Option: FNB-101LI (7.4 V, 1,100 mAh)
- When the battery pack is recharged, its output voltage (about 8 V) becomes higher than the specified value (7.4 V). This is not a failure.

Preparation

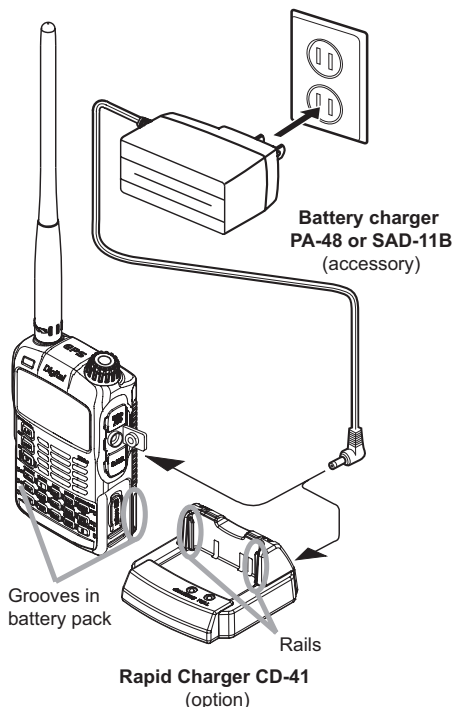



- 1 Install the Battery Pack
- 2 Turn off the transceiver.
- 3 Insert the plug of the battery charger (PA-48 or SAD-11B) in the EXT DC IN jack of the transceiver. Charging starts.

While the battery is being charged, the display will indicate "NOW CHARGING".

The charge level is indicated by a bar graph.

It takes about 8 hours to charge the battery pack fully.

When charging is completed, the display will change to indicate "COMPLETE" and the  lamp will glow green.

Remark In the USA Version, the  lamp is not lit when charging or when charging is complete. When the charge is complete, the transceiver turns off after 3 minutes.

Supplement • It takes about 5 hours to charge the FNB-101LI (option).

- The optional Rapid Charger (CD-41) requires about 4 hours to charge the supplied battery pack (about 2.5 hours to charge the optional battery pack FNB-101LI).

Place the battery pack on the CD-41 so that the rails of the CD-41 fit into the grooves on the battery pack.

When charging the battery pack using the CD-41, the LED on the CD-41 indicates the state of charging.

During charging: Lights red → Fast blink → Slow blink

Completion of charging: Lights green

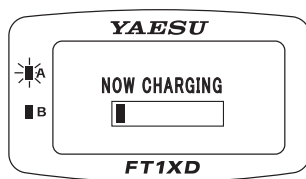

Preparation

- 4 When charging is complete, remove the plug of the battery charger from the jack of the transceiver.

Cautions

- Neither transmission nor reception can be performed while charging the battery pack using the supplied battery charger.
- Charging may cause noise in the nearby TV or radio. Charge the battery pack with the battery charger as far away as possible from a TV or radio.
- If “BATTERY NOT INSTALLED” appears on the LCD and the battery pack cannot be charged after lapse of 11 or more hours, stop charging the battery pack immediately. If the same message appears again, the battery pack is presumably at the end of its service life or defective. If so, replace the battery pack with a new one.
- While charging the battery pack, protect the transceiver from water.
- Charge the battery pack in a place where the ambient temperature is +5 °C to +35 °C (+41 °F to +95 °F).
- If the terminal or electrode of the battery case is dirty, this transceiver can malfunction due to poor contact, resulting in overheating or rupture. If the terminal or electrode gets dirty, clean it using a dry cloth or cotton swab.

Tips

- The battery charger may become hot during charging. This is not a malfunction.
- If  starts blinking, the battery pack charge is depleted. Charge it immediately.

Approximate Operating Time and Remaining Charge Level Indication

Approximate time to operate the transceiver with the fully charged battery pack or three new AA alkaline batteries is as follows:

Band in Use Digital: OFF		Battery pack FNB-101LI	Battery pack SBR-14LI	Battery FBA-39
Amateur Band	144 MHz band	Approx. 5.0 hours	Approx. 10.0 hours	Approx. 15.5 hours
	430 MHz band	Approx. 4.5 hours	Approx. 9.0 hours	Approx. 15 hours
AM Broadcast Band		Approx. 10.0 hours	Approx. 20.0 hours	Approx. 18.0 hours
FM Broadcast Band		Approx. 8.0 hours	Approx. 16.0 hours	Approx. 14.5 hours

Band in Use Digital: ON		Battery pack FNB-101LI	Battery pack SBR-14LI	Battery FBA-39
Amateur Band	144 MHz band	Approx. 4.0 hours	Approx. 8.0 hours	Approx. 11.0 hours
	430 MHz band	Approx. 3.6 hours	Approx. 7.2 hours	Approx. 10.5 hours

Transmission 6 seconds: Reception 6 seconds (VOL Level 16): Stand By 48 seconds (SAVE1:5)

Remark Approximate hours are estimated assuming that the transceiver is operated under the following conditions. The operation time that this transceiver can be actually used varies depending on use conditions, ambient temperature, etc.

- When the GPS function is deactivated.
- When the transceiver is repeatedly operated by high-power transmission for 6 seconds and reception for 6 seconds, and standby for 48 seconds with an amateur ham radio band selected.

Preparation

Connecting an External Power Supply for Use in Vehicle (USA/EXP version only)

The optional external power supply adapter with a cigarette lighter plug (SDD-13) allows the transceiver to be used in a vehicle.

- 1 Turn off the transceiver.
- 2 Insert the plug of the external power supply adapter with a cigarette lighter plug (SDD-13) in the EXT DC IN jack of the transceiver.
- 3 Insert the cigarette lighter plug of the external power supply adapter (SDD-13) in the cigarette lighter socket of the vehicle.

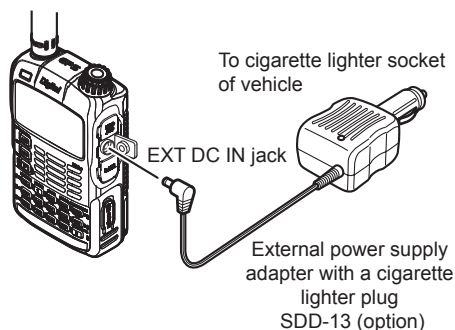

Cautions

- The SDD-13 is compatible with a 12 VDC cigarette lighter socket. Do not connect the SDD-13 to the 24 VDC cigarette lighter socket.
- Use the transceiver at the minimum required transmission power level to prevent overheating.
- Do not continue transmission for a prolonged period of time. The transceiver may overheat, resulting in malfunction or burns.
- If you operate the transceiver for 7 hours or longer, it is recommended that you remove the battery pack and install the optional battery case (FBA-39).
- Recharging the fully-charged battery pack repeatedly can shorten its service life. Be extremely careful not to do so when you operate the transceiver when using an external power supply.
- While charging the battery pack, protect the transceiver from water.
- Charge the battery pack in a place where the ambient temperature is +5 °C to +35 °C (+41 °F to +95 °F).
- If the terminal or electrode of the battery case is dirty, the transceiver can malfunction due to poor contact, resulting in overheating or rupture. If the terminal or electrode gets dirty, clean it using a dry cloth or cotton swab.

Tips

- The battery pack can be charged within approximately 8 hours using the external power supply (approximately 5 hours to charge the optional battery pack FNB-101LI). If the battery pack is charged with the transceiver turned on, the charging time increases slightly.
- When the battery pack has been fully charged, charging stops automatically.
- The external power supply can be used with the battery case installed.
- If you connect the transceiver to the external power supply with it turned off, "CONNECTED TO EXTERNAL POWER" appears on the LCD, and about 20 seconds later "BATTERY NOT INSTALLED" appears.

Connecting to an External Power Supply Using a Power Cable (USA/EXP version only)

The optional power cable (E-DC-6) allows the transceiver to be connected to an external power supply.

Preparation

- 1 Turn off the transceiver.
- 2 Connect the optional external power supply cable (E-DC-6) to an external power supply.

Remarks

- Connect the red/black wire or white/red wire to the positive (+) terminal of the external power supply and the black wire to the negative (-) terminal.
- Set the voltage of the external power supply to 12 to 14 V.

- 3 Insert the plug of the external power supply in the EXT DC IN jack of the transceiver.

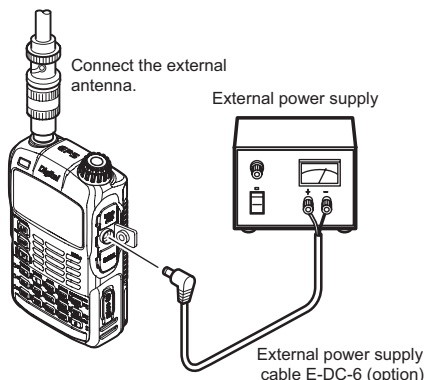

Cautions

- When you use the transceiver with the external power supply cable (E-DC-6) connected to an external power supply, pay attention to the following:
 - The power supply voltage must be between 12 V and 14 V.
 - If the voltage exceeds 14 V, the high voltage protection function is activated to disable high-power transmission. L3 (2.5 W) is selected automatically to reduce the transmission power. If the voltage exceeds 16 V, malfunctions such as damage to the electric circuits of the transceiver may result. Take extra care.
- Connect the red/black wire or white/black wire of the external power supply cable (E-DC-6) to the positive (+) terminal of the external power supply and the black wire to the negative (-) terminal.
- Use an external power supply having sufficient current capacity (3 A or more).
- If the transceiver is used with supplied antenna connected, the external power supply can malfunction, resulting in a failure. If you use an external power supply, remove the supplied antenna and connect an external antenna. Place the external power supply sufficiently away from the transceiver.
- Use the transceiver at the minimum required transmission power level to prevent overheating.
- Do not continue transmission for a prolonged period. The transceiver may overheat, resulting in malfunction or burn.
- If you operate the transceiver for 7 hours or longer, it is recommended that you remove the battery pack and install the optional battery case (FBA-39).
- Recharging the fully-charged battery pack repeatedly can shorten its service life. Be extremely careful not to do so when you operate the transceiver using an external power supply.
- While charging the battery pack, protect the transceiver from water.
- Charge the battery pack in a place where the ambient temperature is +5 °C to +35 °C (+41 °F to +95 °F).
- If the terminal or electrode of the battery case is dirty, the transceiver may malfunction due to poor contact, resulting in overheating or rupture. If the terminal or electrode gets dirty, clean it using a dry cloth or cotton swab.

Tips

- The transceiver can be charged within approximately 8 hours using the external power supply (approximately 5 hours to charge the optional battery pack FNB-101LI). If the battery pack is charged with the transceiver turned on, the charging time increases slightly.
- The external power supply can be used with the battery case installed.
If you connect the transceiver to the external power supply with it turned off, "CONNECTED TO EXTERNAL POWER" appears on the LCD, and about 20 seconds later "BATTERY NOT INSTALLED" appears.

Using a microSD memory card

Using a microSD memory card with the transceiver allows the following functions.

You can:

- Back up information on the transceiver.
- Save memory information.
- Save data other than images.
- Save GPS log data.
- Save image data captured with the optional camera-equipped microphone (MH-85A11U).
- Save messages downloaded with the GM function or WIRES-X function.

Usable microSD memory cards

This transceiver only supports the following capacity of microSD and microSDHD memory cards.

- 2GB
- 4GB
- 8GB
- 16GB
- 32GB

Cautions when using a microSD memory card

- Do not bend or place heavy objects on the microSD memory card.
- microSD memory cards formatted on other devices may not properly save information when used with this transceiver. Format microSD memory cards again with this transceiver when using memory cards formatted with another device.
- When saving data to a microSD memory card, do not remove the microSD memory card or turn off the transceiver.
- Do not insert anything other than microSD memory card into the microSD memory card slot of the transceiver.
- Do not attempt to forcefully remove mounted microSD memory card.
- Do not use microSD memory cards other than those specified by Yaesu. For the information on the specified products, please contact Yaesu Amateur Ham Radio Customer Support.

Mounting and dismounting microSD memory card

- 1 Turn off the transceiver.

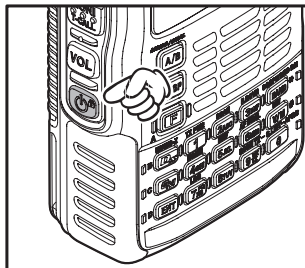

Using a microSD memory card

- 2 Open the microSD cover on the side of the transceiver.

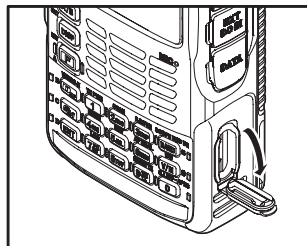

- 3 Insert the microSD memory card into the card slot until you hear a click. (as shown in the figure at the right).

- Cautions**
- Ensure that the microSD memory card is facing the proper direction when mounting it.
 - Do not touch the terminal of the microSD memory card.

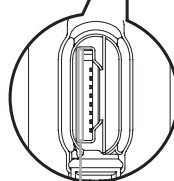
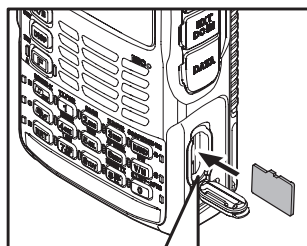

Do not push the microSD memory card into this space.

- 4 Close the microSD cover.
When the microSD memory card is properly detected, the **S** lights on the display.

Tips

Dismounting the microSD memory card.

To dismount the microSD memory card, as done in step 3 above, push the memory card in until you hear a click, then remove the memory card.

* By using the micro SD Card Clip, it is easy to remove the micro SD memory Card.

Caution

Do not turn off the transceiver while the data is being written to the microSD memory card. Doing so may corrupt the data.

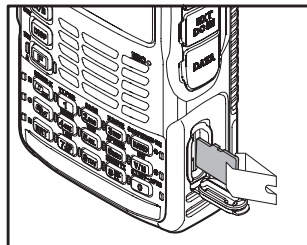
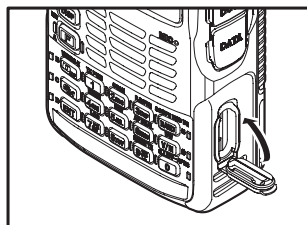

Using a microSD memory card

Formatting a microSD memory card

Format a new microSD memory card following the steps below before use.

Caution

Formatting a microSD memory card erases all data saved to it. If you are going to format the microSD memory card you are using, be sure to check the data saved to it before formatting.

1 Press and hold **SET** (**DISP**) over 1 second.

2 Turn **DIAL** to select [10 SD CARD].

3 Press **ENT**.

4 Turn **DIAL** to select [4 FORMAT].

5 Press **ENT**.

[OK?] appears on the LCD.

Tip To cancel formatting, select [Cancel].

6 Press **ENT**.

S (**S** icon) on the LCD blinks and formatting starts.

When formatting is completed, a beep sound is emitted and [Completed] appears on the LCD.

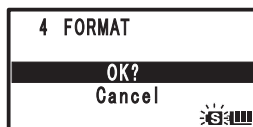
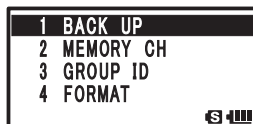
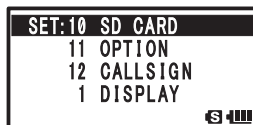

Blinking while formatting is in progress

Performing Communication

Try communication using the transceiver in the analog communication mode.
 Follow the procedure below:

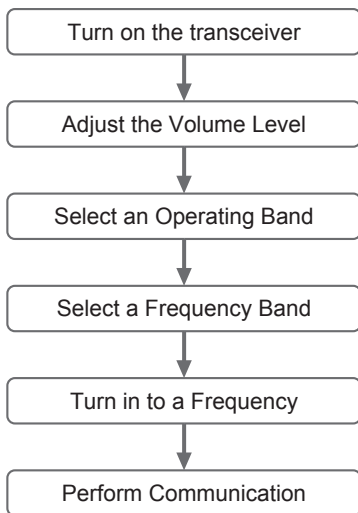

Turning on the Transceiver

- 1 Press and hold over 1 second.
- 2 The callsign input screen appears.
 The callsign input screen appears when the transceiver is turned on for the first time after purchase.
 The next time, the frequency screen will appear after the opening screen.
- 3 Input a callsign for your transceiver.
 Input the callsign with the ten key.
- 4 Press .
 The callsign is set and two frequencies (A-band and B-band frequency) appear at the same time.

Supplement Factory settings are:
 A-band (upper): 144.000 MHz
 B-band (lower): 430.000 MHz

Tips You can change the information such as the power supply voltage and the opening message displayed at power-on. For example, press and hold over 1 second to enter the Set mode and then select [1 DISPLAY] → [9 OPENING MESSAGE] to change the opening message.

In addition, you can set the transceiver to display the reception frequency immediately without displaying the opening message (See page 107).

