







Turning illumination off when scanning stops SCAN LAMP Function

You can set the backlight of LCD to turn ON or OFF when a signal is received during scanning.

Enter the Set mode:

- 1 Press and hold  for over 1 second.
- 2 Turn  to select [5 SCAN].
- 3 Press .
- 4 Turn  to select [2 SCAN LAMP].
- 5 Press .
- 6 Turn  to select [OFF].

ON: The LCD backlight will light when a signal is received.

OFF: The LCD backlight will not light when a signal is received.

Remark Default: ON



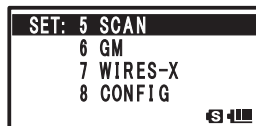



- 7 Press  to save the backlight ON or OFF setting when scanning stops, and exit the Set mode.



Setting the time to resume scan SCAN RE-START Function

You can set the time to resume scanning after a signal is received during scanning.

Enter the Set mode:

- 1 Press and hold  for over 1 second.
- 2 Turn  to select [5 SCAN].
- 3 Press .
- 4 Turn  to select [3 SCAN RE-START].
- 5 Press .
- 6 Turn  to select the time to resume scanning.

Select from 0.1 SEC to 10 SEC.

Remark Default: 2 seconds

- 7 Press  to set the resume scanning time, and exit the Set mode.

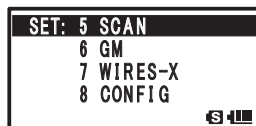

Set Mode

Selecting a reception method when scanning stops













Set the reception method for when scanning stops.

For more details, see “Selecting a Reception Method When Scanning Stops” on page P. 59.

Setting the range for SCAN

You can set the frequency range for scanning with the SCAN Function.

Enter the Set mode:

- 1 Press and hold  for over 1 second.
- 2 Turn  to select [5 SCAN].
- 3 Press .
- 4 Turn  to select [5 SCAN WIDTH].
- 5 Press .
- 6 Turn  to select [VFO].
- 7 Press .
- 8 Turn  to select the range for scanning.
Specify the scanning range with reference to the next list.
- 9 Press .
- 10 Turn  to select [MEMORY].
- 11 Press .
- 12 Turn  to select the range for scanning.

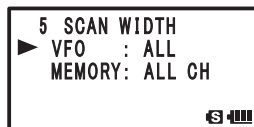
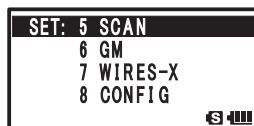

Mode	Display*	Operation Status
VFO Mode	ALL	Scans all bands within the range from the current frequency to 108-999 MHz.
	BAND	Scans the current band (see the table on the next page) starting with the current frequency.
Memory Mode	ALL CH	Scans all memory channels (1-900) of the currently selected memory channel. When selected memory channels are specified, all of them are scanned (See page 59).
	BAND	Scans only the memory channels to which frequencies in the same frequency band*1 are registered. When the selected memory channels are specified, scans only the selected memory channels to which frequencies in the same frequency band*1 are registered (See page 61).







*1 For the relationship between frequency bands and reception frequencies, see the table at the bottom of page 28.

- 13 Press  to save the range for scanning, and exit the Set mode.

Turning off the power automatically APO Function

The transceiver may be set to turn off automatically if there is no operation for a certain period of time.

Enter the Set mode:

- 1 Press and hold  for over 1 second.
- 2 Turn  to select [8 CONFIG].
- 3 Press .
- 4 Turn  to select [1 APO].
- 5 Press .
- 6 Turn  to set the time.

Set the time for the transceiver to turn off automatically in steps of 30 minutes.

OFF/30 MIN/1 HOUR to 12 HOURS

Remark Default: OFF

- 7 Press  to save the auto power-off function setting, and exit the Set mode. The transceiver will be automatically turned off if there is no operation for the set period of time.

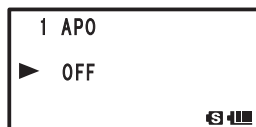
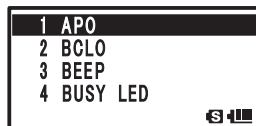
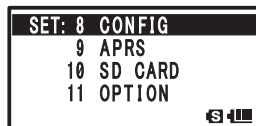

Tips

- When the auto power-off function is active, the  icon appears on the LCD.
- Once the time for automatic power-off is set, it is retained until “OFF” is selected in step 6 of the above-mentioned procedure. (The next time you turn the transceiver on, if you perform no operation for the set period of time, the transceiver will automatically turn itself off.)

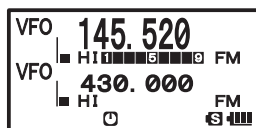







Set Mode

Preventing accidental transmission Busy Channel Lockout (BCLO) Function

You can prevent accidental transmission during signal reception.

Enter the Set mode:

- 1 Press and hold  for over 1 second.
- 2 Turn  to select [8 CONFIG].
- 3 Press .
- 4 Turn  to select [2 BCLO].
- 5 Press .
- 6 Turn  to select [ON].

Remark Default: OFF



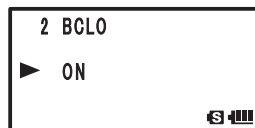
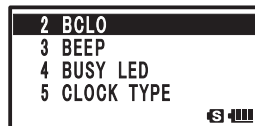
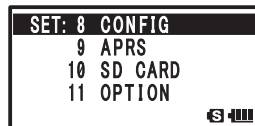





- 7 Press  to save the BCLO function setting, and exit the Set mode.



Muting the key operation confirmation tone

The operation confirmation sound (beep sound) that is heard when keys are operated, or when scanning reaches the end of a frequency band, can be turned off.





Enter the Set mode:

- 1 Press and hold  for over 1 second.
- 2 Turn  to select [8 CONFIG].
- 3 Press .
- 4 Turn  to select [3 BEEP].
- 5 Press .
- 6 Turn  to select [SELECT].
- 7 Press .
- 8 Turn  to select [OFF].

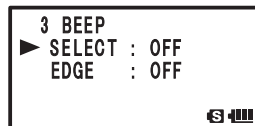
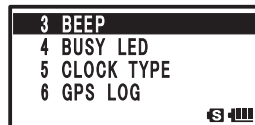
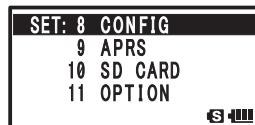
Remarks Default: KEY&SCAN

Display	Description
OFF	Mutes the beep.
KEY&SCAN	Emits a beep when a key is operated or scanning stops.
KEY	Emits a beep when a key is pressed.











- 9 Press .
- 10 Turn  to select [EDGE].
- 11 Press .
- 12 Turn  to select [OFF].
- 13 Press  to exit from the Set mode.

Turning off the BUSY Indicator

When you listen to the radio continuously or when the remaining battery level has become low, you can turn off the BUSY indicator to save battery power consumption.

Enter the Set mode:



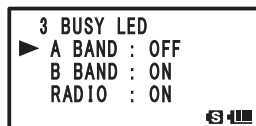
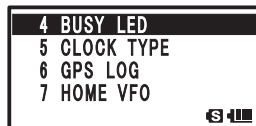
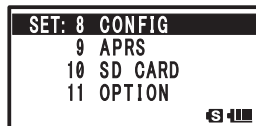



- 1 Press and hold  for over 1 second.
 - 2 Turn  to select [8 CONFIG].
 - 3 Press .
 - 4 Turn  to select [4 BUSY LED].
 - 5 Press .
 - 6 Turn  to select a band.
 Select a band from among [A BAND], [B BAND], and [RADIO].
 - 7 Press .
 - 8 Turn  to select [OFF].
- Remark** Default: ON
- 9 Press .
- The BUSY indicator is turned off, and exits from the Set mode.



Setting the clock shift for the micro computer Clock Type Function

The micro computer Clock Shift function may be set to reduce internal high frequency spurious interference signals. Select [A] for normal use.

Enter the Set mode:

- 1 Press and hold  for over 1 second.
 - 2 Turn  to select [8 CONFIG].
 - 3 Press .
 - 4 Turn  to select [5 CLOCK TYPE].
 - 5 Press .
 - 6 Turn  to select a clock type.
 A: The Clock Shift function is automatically turned on or off.
 B: The Clock Shift function is continually active.
- Remark** Default: A
- 7 Press  to save the Clock Type setting, and exit the Set mode.

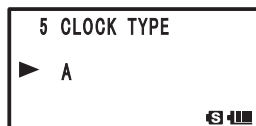
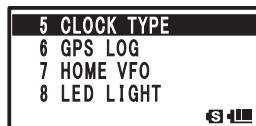
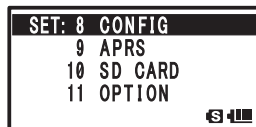







Set Mode

Setting interval to save GPS position information

Set the interval at which the GPS information of your current position is saved to the microSD memory card.

Enter the Set mode:

- 1 Press and hold  for over 1 second.
- 2 Turn  to select [8 CONFIG].
- 3 Press .
- 4 Turn  to select [6 GPS LOG].
- 5 Press .
- 6 Turn  to select an interval to save GPS position information.

OFF / 1 SEC / 2 SEC / 5 SEC / 10 SEC / 30 SEC / 60 SEC

Information is not recorded to the microSD memory card if OFF is selected.

Remark Default: OFF

- 7 Press  to save the GPS information saving interval setting, and exit the Set mode.

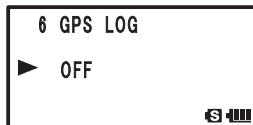
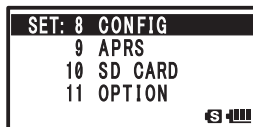







Tips

- Data saved to the microSD memory card is saved in xxx.LOG format.
- Saved data can be viewed with PC applications*.
- * PC applications are not supported by our company.

Permitting Transfer of Home Channel Frequency to VFO

You can use the set operation to transfer home channel frequency information to the VFO.

Enter the Set mode:

- 1 Press and hold  for over 1 second.
- 2 Turn  to select [8 CONFIG].
- 3 Press .
- 4 Turn  to select [7 HOME VFO].
- 5 Press .
- 6 Turn  to select Unlock or Lock.

ENABLE: Turning  in home channel transfers the home channel frequency to VFO.

DISABLE: The home channel frequency cannot be transferred.

Remark Default: ENABLE



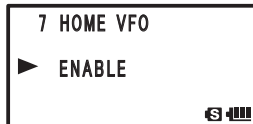
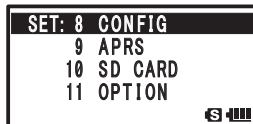



- 7 Press  to save the frequency transfer ENABLE/DISABLE/Unlock setting, and exit the Set mode.



Using the White LED as a Flashlight



The white LED may be used as a flashlight.

Enter the Set mode:

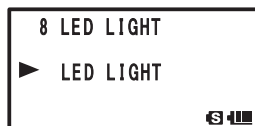
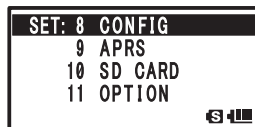





- 1 Press and hold  for over 1 second.
 - 2 Turn  to select [8 CONFIG].
 - 3 Press .
 - 4 Turn  to select [8 LED LIGT].
 - 5 Press .
- The white LED lights as a flashlight.
- 6 Press .
- The LED goes out.
- 7 Press  to exit from the Set mode.



Setting the conditions for locking LOCK Function

Conditions for activating Lock Function, such as keys, , and , can be set.

Enter the Set mode:



- 1 Press and hold  for over 1 second.
- 2 Turn  to select [8 CONFIG].
- 3 Press .
- 4 Turn  to select [9 LOCK].
- 5 Press .
- 6 Turn  to select the keys and switches to lock.

KEY & DIAL: Locks the keys and  on the front of the transceiver.

PTT: Locks .

KEY & PTT: Locks the keys and  on the front of the transceiver.

DIAL & PTT: Locks  and .

ALL: Locks the keys, , and  on the front of the transceiver.

KEY: Locks the keys on the front of the transceiver.

DIAL: Locks .

Remark Default: KEY&DIAL

- 7 Press .

The keys and switches to lock are set, and exits from the Set mode.

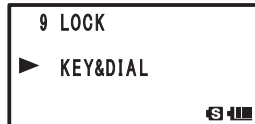
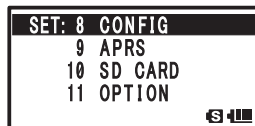

Set Mode

Setting the operation of

The function for when  is pressed can be set.

Enter the Set mode:

1 Press and hold  for over 1 second.

2 Turn  to select [8 CONFIG].

3 Press .

4 Turn  to select [10 MONI/T-CALL].

5 Press .

6 Turn  to select the function.

MONI: Pressing  monitors frequency.

T-CALL: Pressing  functions as tone call.

Remark Default: Depends on the transceiver version.

7 Press .

The function for  is set.

8 Press  to save the setting and exit the Set mode.

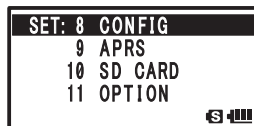

Turning on/off the transceiver at the specified time Timer Function

You can turn the transceiver to turn on/off at the set time. Before using this function, adjust the clock. See “Setting clock time” on page 34.

Enter the Set mode:

1 Press and hold  over 1 second.

2 Turn  to select [8 CONFIG].

3 Press .

4 Turn  to select [11 TIMER].

5 Press .

6 Turn  to select [ON] or [OFF].

ON: Turns on the transceiver at the specified time.

OFF: Turns off the transceiver at the specified time.

7 Press .

8 Turn  to specify hours.

9 Press .

10 Turn  to specify minutes.

11 Press .

12 Turn  to switch between ON/OFF of the timer.

13 Press .

The timer function is turned on.



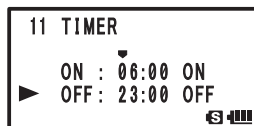
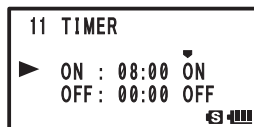
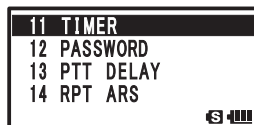
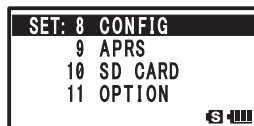







14 Press  to exit from the Set mode.



Password Function



You can enter a 4-character password to prevent a third party from using your transceiver without permission. Once a password is entered, the transceiver cannot be turned on until the valid password is entered.

Enter the Set mode:

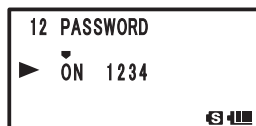
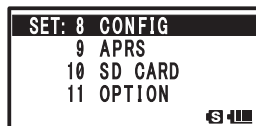
- 1 Press and hold  for over 1 second.
 - 2 Turn  to select [8 CONFIG].
 - 3 Press .
 - 4 Turn  to select [12 PASSWORD].
 - 5 Press .
 - 6 Press .
 - 7 Turn  to enter the first character of the password.
 Enter the first character (0-9, A to D, *, and #) of the password.
 - 8 Press .
 The cursor moves to the next character position.
 - 9 Repeat steps 7 and 8 to enter the remaining three characters.
 - 10 Press .
 - 11 Turn  to select [ON].
- Remark** Default: OFF
- 12 Press  to save the password setting, and exit the Set mode.



Tips

- To cancel the password function, execute the above-mentioned steps 1 to 5, select "OFF" with , and then press  over 1 second.
- Keypad keys cannot be used to enter the password.
- When the on-timer function is active, the password function is ineffective.

•Turning on the transceiver using a password

- 1 Press and hold  for over 1 second.
 The password entry screen appears.
- 2 Enter the password using keypad keys.
 Enter the registered 4-character password.
 When the valid password is entered, the frequency display screen appears.

Remark When an invalid password is entered, the transceiver is turned off automatically.

Caution







- If you've forget the registered password, carrying out all resetting allows you to turn on the transceiver without entering the password.
- It should be noted that performing all resetting resets (initializes) all information such as the information registered to memory channels and various setting values.
- It is recommended that the password be written down on paper.

Set Mode

Setting the PTT delay time PTT DELAY Function

You can set the time for actual transmission to start after  is pressed.

Enter the Set mode:

- 1 Press and hold  for over 1 second.
- 2 Turn  to select [8 CONFIG].
- 3 Press .
- 4 Turn  to select [13 PTT DELAY].
- 5 Press .
- 6 Turn  to select the time.
 OFF/20ms/50ms/100ms/200ms

Remark Default: OFF



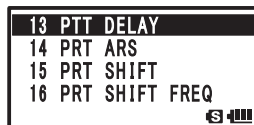
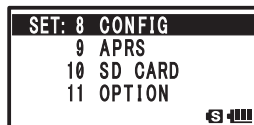



- 7 Press  to save the PTT delay time setting, and exit the Set mode.



Setting the ARS function RPT ARS Function

You can set the operation of ARS (Tuning in to the repeater frequency automatically enables the repeater).

Enter the Set mode:

- 1 Press and hold  for over 1 second.
- 2 Turn  to select [8 CONFIG].
- 3 Press .
- 4 Turn  to select [14 RPT ARS].
- 5 Press .
- 6 Turn  to select ON/OFF.
 ON: ARS is functional.
 OFF: ARS is not functional.

Remark Default: ON



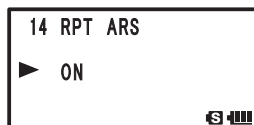
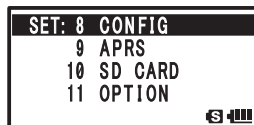



- 7 Press  to save the ARS function ON/OFF setting, and exit the Set mode.



Setting the direction for repeater shift RPT SHIFT Function

You can set the direction of repeater shift.

Enter the Set mode:



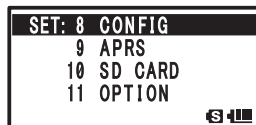





- 1 Press and hold  for over 1 second.
 - 2 Turn  to select [8 CONFIG].
 - 3 Press .
 - 4 Turn  to select [15 RPT SHIFT].
 - 5 Press .
 - 6 Turn  to select the shift direction.
 SIMPLEX: Does not shift.
 -RPT: Shifts toward lower frequencies.
 +RPT: Shifts toward higher frequencies.
- Remark** Default setting differs depending frequency
- 7 Press  to save the repeater shift direction setting, and exit the Set mode.



Setting the range for repeater shift RPT SHIFT FREQ Function

You can set the repeater shift range.

Enter the Set mode:

- 1 Press and hold  for over 1 second.
 - 2 Turn  to select [8 CONFIG].
 - 3 Press .
 - 4 Turn  to select [16 RPT SHIFT FREQ].
 - 5 Press .
 - 6 Turn  to select shift range.
 The range can be set in steps of 50 kHz between 0.0000 MHz and 150.000 MHz.
 Pressing  and then turning  allows you to set frequencies in steps of 1 MHz.
- Remark** Default setting differs depending frequency
- 7 Press  to save the repeater shift range setting, and exit the Set mode.

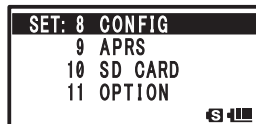







Set Mode

Disabling reception while no signal is received Reception Save Function

To reduce power consumption, the reception function can be turned off when not receiving a signal.

Enter the Set mode:

- 1 Press and hold  for over 1 second.
- 2 Turn  to select [8 CONFIG].
- 3 Press .
- 4 Turn  to select [17 SAVE RX].
- 5 Press .
- 6 Turn  to select the time.

Select the time for the reception to be turned off automatically.

- 0.2 SEC (1:1) to 1.0 SEC (1:5) (Step: 0.1 sec)
- to 1.0 SEC (1:5) to 10 SEC (1:50) (Step: 0.5 sec)
- to 1.0 sec (1:50) to 60 sec (1:300 sec) step 5 sec
- OFF

Remark Default: 0.2 sec (1:1)

- 7 Press  to save the Reception Save function setting, and exit the Set mode.

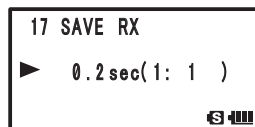
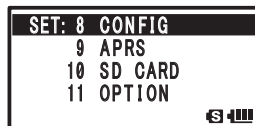

Changing the frequency step manually

Frequency step can be set so that it can be changed manually.

For more details, see “Changing the Frequency Step Manually” on page 37.

Setting clock time



Set the time for the internal clock of this transceiver.

For details, see “Setting clock time” on page 34.

Restricting the continuous transmission time TOT Function



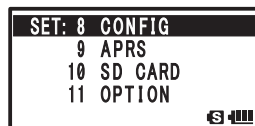

Set the transceiver to automatically return to the receive mode after transmitting continuously for a certain period of time. Accidental transmission of unnecessary signals, and unwanted battery power consumption can be prevented (time-out timer function).

Enter the Set mode:

- 1 Press and hold  for over 1 second.
- 2 Turn  to select [8 CONFIG].
- 3 Press .



Set Mode

- 4 Turn  to select [20 TOT].
- 5 Press .
- 6 Turn  to select the time.
 Set the time for the transceiver to automatically return to the reception state in steps of 30 seconds.
 OFF/30 SEC to 10 MIN
Remark Default: OFF
- 7 Press  to save the TOT function setting, and exit the Set mode.









Tips

- When the time-out timer function is active, a beep is emitted when it comes near the set time. About 10 seconds later, the transceiver returns to the reception state.
- Once the time is set, it is retained until "OFF" is selected in step 6 of the above-mentioned procedure.

Setting the frequency selection range for operation in the VFO mode VFO MODE Function

You can set the frequency selection range for operating in the VFO mode.

Enter the Set mode:

- 1 Press and hold  over 1 second.
- 2 Turn  to select [8 CONFIG].
- 3 Press .
- 4 Turn  to select [21 VFO MODE].
- 5 Press .
- 6 Turn  to select a frequency range.
 ALL: Switches to the next band when the end of a band is reached.
 BAND: Moves to the other end of the band when the end of that band is reached.
Remark Default: BAND
- 7 Press  to save the frequency selection range setting, and exit the Set mode.

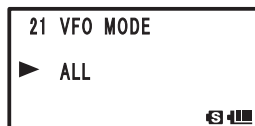
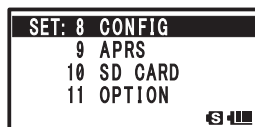

Set Mode









Notification of a call from a remote station by vibration

The vibrator function may be set to notify you of a call from a remote station. For details, see “Notification of Call from the Remote Station by Vibration of the Vibrator” on page 88.

Saving/ Loading data to/from microSD memory card

Settings information can be saved to a microSD memory card, also the saved information can be loaded to the transceiver.

Enter the Set mode:

- 1 Press and hold  over 1 second.
- 2 Turn  to select [10 SD CARD].
- 3 Press .
- 4 Turn  to select [1 BACKUP].
- 5 Press .
- 6 Turn  to select [Write to SD] or [Read from SD].
 Write to SD: Saves the setting information of your transceiver to the microSD memory card.
 Read from SD: Loads the setting information to your transceiver from the microSD memory card.
 Cancel: Stops save or load.
- 7 Press .
 [OK?] appears on the LCD.
- 8 Press .
 The write or read is performed and [Completed] appears when finished.
- 9 Press  to exit from the Set mode.

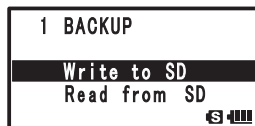
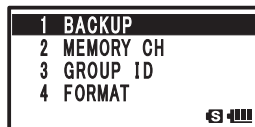
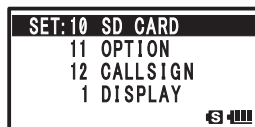



Blinks when writing

Saving/ Loading memory channel information to/from microSD memory card





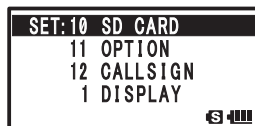

Memory channel setting information can be saved to a microSD memory card, or saved information can be loaded to this transceiver.

Enter the Set mode:

- 1 Press and hold  for over 1 second.
- 2 Turn  to select [10 SD CARD].
- 3 Press .



Set Mode

- 4 Turn  to select [2 MEMORY CH].
- 5 Press .
- 6 Turn  to select [Write to SD] or [Read from SD].
 Write to SD: A beep is heard and [Completed] appears when writing to SD finished.
 Read from SD: A beep is heard when loading from SD finished and the transceiver restarts with the settings read from the microSD memory card. (The operation in step 9 is not required.)
 Cancel: Stops save or load.
- 7 Press .
 [OK?] appears on the LCD.
- 8 Press .
 The write or read is performed and [Completed] appears when finished.
- 9 Press  to exit from the Set mode.

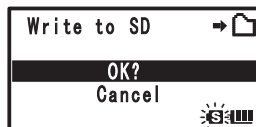
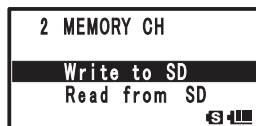







Blinks when writing

Saving/ Loading GROUP ID information to/from microSD memory card

Group ID setting information can be saved to a microSD memory card, or saved information can be loaded to this transceiver.

Enter the Set mode:

- 1 Press and hold  for over 1 second.
- 2 Turn  to select [10 SD CARD].
- 3 Press .
- 4 Turn  to select [3 GROUP ID].
- 5 Press .
- 6 Turn  to select [Write to SD] or [Read from SD].
 Write to SD: Saves the Group ID information to your transceiver to the microSD memory card.
 Read from SD: Loads the Group ID information to your transceiver from the microSD memory card.
 Cancel: Stops save or load.
- 7 Press .
 [OK?] appears on the LCD.

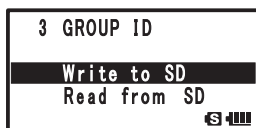
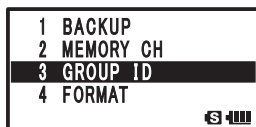
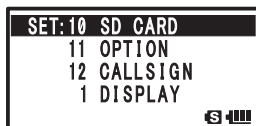

Set Mode

- 8 Press **ENT**.

Write to SD: A beep is heard and [Completed] appears when writing to SD finished.

Read from SD: A beep is heard when loading from SD finished and the transceiver restarts with the settings read from the microSD memory card. (The operation in step 9 is not required.)

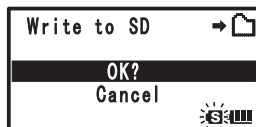

Blinks when writing

- 9 Press **PTT** to exit from the Set mode.

Formatting a microSD memory card

Format a new microSD.

For more details, see “Formatting a microSD memory card” on page 24.

Setting the optional microphone with camera for use

Image size and quality can be set for the optional microphone with camera (MH-85A11U).

Enter the Set mode:

- 1 Press and hold **SET DISP** for over 1 second.
- 2 Turn **DIAL** to select [11 OPTION].
- 3 Press **ENT**.
- 4 Turn **DIAL** to select [1 USB CAMERA].
- 5 Press **ENT**.
- 6 Turn **DIAL** to select [SIZE].
- 7 Press **ENT**.
- 8 Turn **DIAL** to select an image size.
 320×240
 160×120
- 9 Press **ENT**.
- 10 Turn **DIAL** to select [QUALITY].
- 11 Press **ENT**.
- 12 Turn **DIAL** to select an image quality.
 LOW: Low image quality
 NORMAL: Intermediate image quality
 HIGH: High image quality
- 13 Press **PTT** to exit from the Set mode.

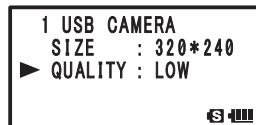
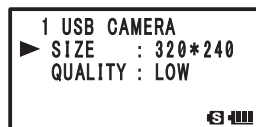
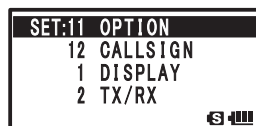



Caution

- If image size is set to large or image quality is set to high, the data transmission time becomes longer.
- The transmission time varies depending on the content of an image.







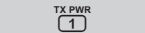

Registering CALLSIGN

The CALLSIGN used in the digital mode can be registered with up to 10 alphanumeric characters.

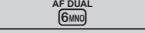

Enter the Set mode:

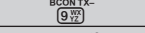
- 1 Press and hold  for over 1 second.
- 2 Turn  to select [12 CALLSIGN].
- 3 Press .
- 4 Enter the characters using keypad keys.

Enter a callsign using keypad keys with reference to the following table.

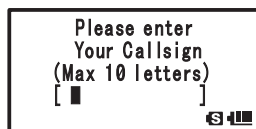
Numeric key	A, 0 (Alphanumeric)
	1
	ABC2
	DEF3
	GHI4
	JKL5
	MNO6
	PQRS7
	TUV8
	WXYZ9
	0



- Tip**
- Pressing  moves the cursor to the right.
 - Press the  to move the corsor back to the left.
 - Press the  to delete the letter or number at the current cursor position.

- 5 Press .

The cursor moves.

- 6 Repeat steps 4 and 5 to enter the CALLSIGN.
- 7 Press  to save the CALLSIGN setting and exit the Set mode.

Set Mode

Using the transceiver for packet communication

You can perform packet communication with your transceiver by connecting TNC (Terminal Node Controller) using an optional connection cable (CT-44).

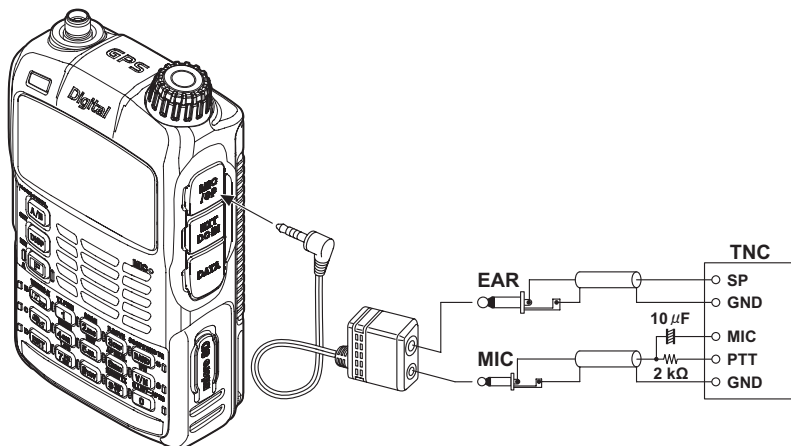

After TNC is connected, set the level of output to TNC by adjusting the sound volume level of your transceiver.

Also adjust the level of input to your transceiver using the output level adjustment volume on the TNC (Input level cannot be adjusted on your transceiver)

Caution

- When sending a vast volume of data, the transmission takes a longer time and the transceiver may be overheated.
 If the transmission is continued for a long time, the overheat prevention circuit will operate and the transmission power decreases. If the transmission is continued further, the transmission will be automatically stopped to prevent the transceiver from overheating and consequently malfunctioning. The transceiver will return to the receive mode.
 When the transceiver returns to the receive mode after the overheat prevention circuit has operated, turn the transceiver off, or keep it in the receive mode until the temperature cools.

Tips

- Set the Receive Battery Save function to OFF during packet communication by selecting [8 CONFIG] → [17 SAVE RX] in the Set mode.
- The reception can be interfered with a noise generated from PC.
 If the transceiver can not receive normally, disconnect it from the PC and reconnect it to the PC using a photocoupler or noise filter.
- To connect the TNC and PC, refer to the TNC instruction manual.

Clone Operation

Data and various settings saved in your transceiver can be copied to another FT1XDR/DE transceiver.

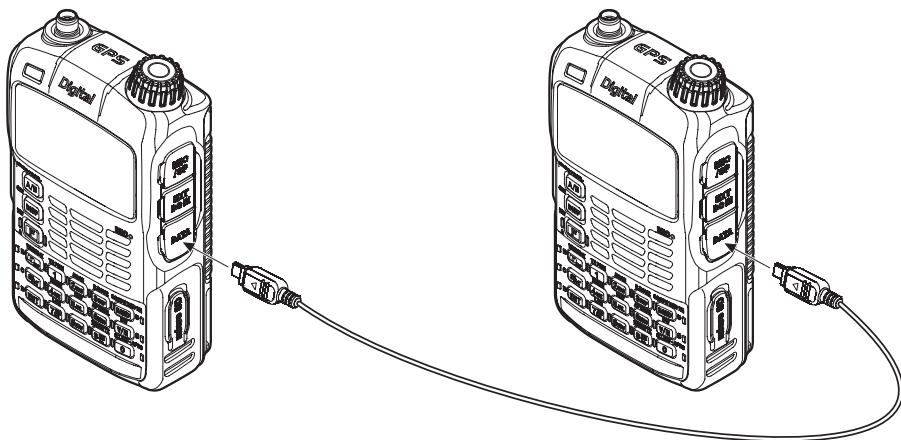

- 1 Turn off the power of both FT1XDR/DE transceivers and connect an optional clone cable (CT-168) to the DATA terminal of each transceiver.
- 2 Press while pressing on each transceiver. The two transceivers are turned on and placed in the clone mode.
- 3 Press on the receiving side transceiver and on the transmission side.

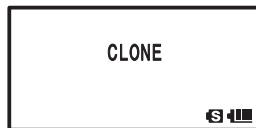

Copying data starts.

When copying starts, the display on the receiving transceiver changes from [--WAIT--] to [--RX--]. When data transmission begins from the sending transceiver, the data transmission indicator appears on the LCD, indicating the data transfer is in progress. The indicator appears on the receiving transceiver, as well when data reception starts.

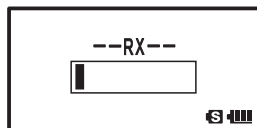
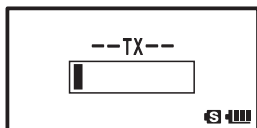

Tips When copying is completed, the reception side transceiver returns to the normal mode. The indication on the LCD of the transmission side transceiver returns from [--TX--] to [CLONE].

- 4 Turn off the power of both transceivers and disconnect the clone cable.

Caution

- When the [ERROR] appears on the LCD during data transfer, copying cannot be completed. Check the clone cable connection, and redo the clone operation from the beginning.
- Time data cannot be copied.

Set Mode

Connecting an external device

Using the DATA terminal, the transceiver can support various functions by setting “GPS”, the internal GPS unit begins outputting the position information data. The position information of the transceiver can be transferred at approximately 1 second intervals to the computer so that the position of the transceiver can be displayed in real-time on programs such as map software.

Tips

- For properties such as communication speed and Input/Output between COM ports.
- For more details, see the Set mode option, [9 APRS] → [17 COM PORT SETTING].

Connecting to a PC

Connecting a PC to the data terminal of the FT1XDR/DE using the PC Connection Cable (SCU-19) accessory will enable data transmission or updating firmware as described below.

a. Transmit position location information received by the FT1XDR/DE internal GPS unit.

By setting [OUTPUT] in [17 COM PORT SETTING] of Set mode option [9 APRS] to details on settings, see Set mode option [17 COM PORT SETTING] in the APRS Instruction Manual.

- To show information, software operating with NMEA-0183 specified GGA and RMC sentence is required.

b. FT1XDR/DE Firmware Updates

When a new firmware update for the FT1XDR/DE is available, go to the YAESU homepage to download the programming data and update the FT1XDR/DE to its newest state.

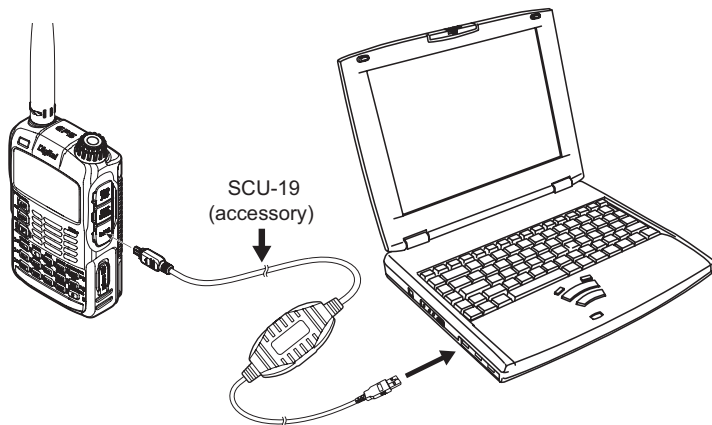

Tip

To use the SCU-19, install a dedicated driver to the PC. For downloading the dedicated driver and installation manual, please go to the YAESU website homepage (<http://www.yaesu.com>).

Connecting the FT1XDR/DE to external devices

Position information data can be exchanged between commercially sold GPS receivers or other external devices by using the optional Data Cable (CT-170) or the Data Cable 2.5Φ (CT-176).

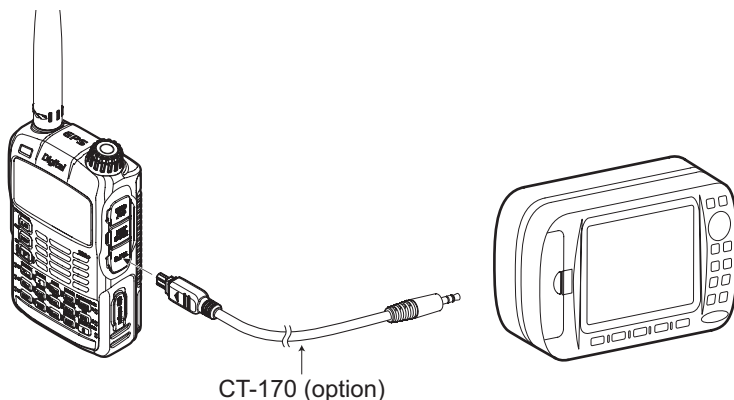

Tip

Connect the Data Cable (CT-170) and the Data Output Cable (CT-176) by referring to the instruction manual for the GPS device to be used, and cable specifications on the next page.

Data Cable (CT-170)



- ⑦ RXD (Serial data input [FT1XDR/DE ← External Equipment])
- ⑧ TXD (Serial data output [FT1XDR/DE → External Equipment])
- ⑩ GND
- ① RXD (Serial data input [FT1XDR/DE ← External Equipment])
- ② TXD (Serial data output [FT1XDR/DE → External Equipment])
- ③ GND

Data Cable (2.5Φ) (CT-176)

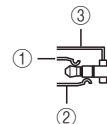
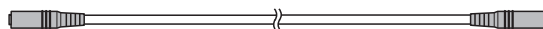
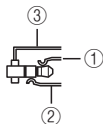

- ① RXD (Serial data input [FT1XDR/DE ← External Equipment])
- ② TXD (Serial data output [FT1XDR/DE → External Equipment])
- ③ GND
- ① TXD (Serial data output [FT1XDR/DE → External Equipment])
- ② RXD (Serial data input [FT1XDR/DE ← External Equipment])
- ③ GND

Appendix

Optional Parts

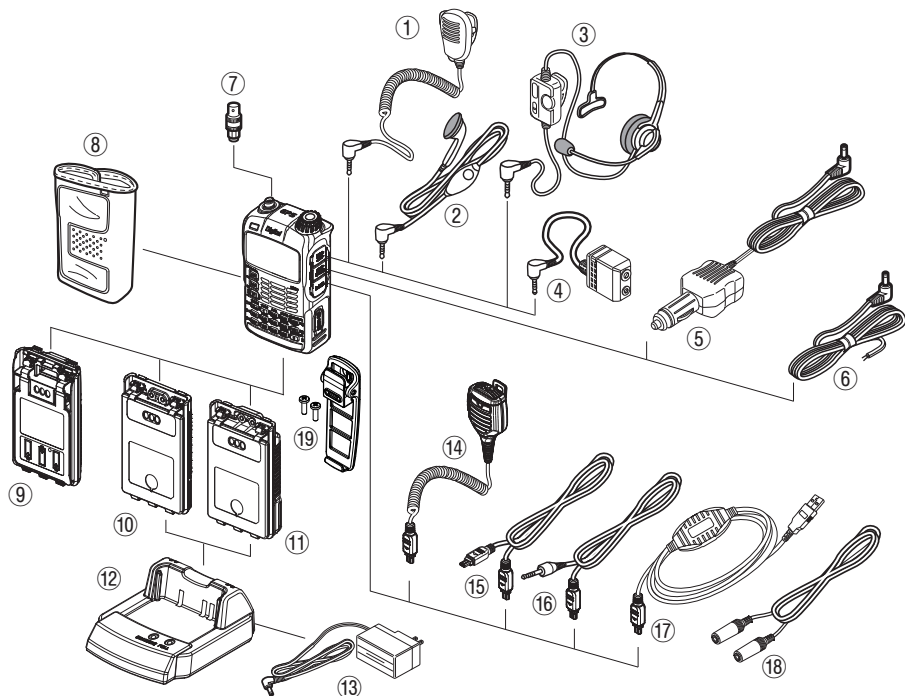

- | | |
|--|--|
| ① Speaker / Microphone (MH-34B4B) | ⑪ Lithium Ion Battery Packs (SBR-14LI, 7.2 V, 2200 mAh) |
| ② Earpiece Microphone (MH-37A4B) | ⑫ Rapid Charger (CD-41) |
| ③ VOX Headset (SSM-63A) | ⑬ Battery Charger (PA-48B/C/U*)
Battery Charger (SAD-11B; for USA market) |
| ④ Microphone Adapter (CT-44) | ⑭ Speaker Microphone with Snapshot camera (MH-85A11U) |
| ⑤ DC Cable w/ Noise Filter (SDD-13)
(USA/EXP market only) | ⑮ Clone Cable (CT-168) |
| ⑥ DC Cable (E-DC-6) (USA/EXP market only) | ⑯ Data Cable (CT-170) |
| ⑦ BNC-to-SMA Adapter (CN-3) | ⑰ PC Connection Cable (SCU-19) |
| ⑧ Soft Case (CSC-97) | ⑱ Data Cable (2.5Φ) (CT-176) |
| ⑨ 3x "AA" Cell Battery Case (FBA-39) | ⑲ Belt Clip (SBH-13) |
| ⑩ Lithium Ion Battery Packs (FNB-101LI, 7.4 V, 1100 mAh) | |

* "B" suffix is for use with 120 VAC (Type-A plug), "C" suffix is for use with 230-240 VAC (Type-C plug), and "U" suffix is for use with 230 VAC (Type-BF plug).



Availability of accessories may vary. Some accessories are supplied as standard per local requirements, while others may be unavailable in some regions. Consult your Yaesu Dealer for details regarding these and any newly-available options. Connection of any non-Yaesu approved accessory, should it cause damage, may void the Limited Warranty on this apparatus.

If you suspect malfunction Check the following items before requesting for repair.



The transceiver does not turn on.

- Is the battery is depleted?
 - Charge the battery pack after purchase, and when the transceiver has not been used for a long time.
- Is the battery pack properly set?
 - Refer to "Mounting the battery pack" and securely mount the battery pack.
- Is the external power supply properly connected?
 - When using an external power supply, connect an external power supply adapter with a cigarette lighter plug (SDD-13) or an external power cable (E-DC-6) to this jack.
- Is the voltage of the battery pack or the SDD-13 correct?
 - Be sure that there is a charge left in the battery pack (do not completely discharge). Check that the output voltage of the SDD-13 is approximately 12V.

There is no sound

- Is the level of squelch (or S meter squelch) set too high?
 - Press the Monitor Switch and check that you can hear white noise.
 - Adjust the level of squelch (or S meter squelch) when receiving a weak signal.
- Is the volume low?
 - Turn  clockwise while pressing  to increase the sound volume.
- Is the tone squelch or DCS on?
 - When the tone squelch or DCS is on, the sound is not output until the transceiver receives a signal containing the same tone frequency or DCS code set.

There is no transmission of radio waves.

- Are you pressing the  switch properly?
- Is the PTT lock on?
- Is the Busy TX Block (BCLO function) on?
 - When the Busy TX Block (BCLO Function) is on, transmission cannot be done when receiving a signal even if  is pressed. Wait until signal being received stops and then press .
- Is the transmission frequency on an ham radio band?
 - Transmission cannot be performed on the AM Radio Broadcast Band/ Short Wave Radio Band/ FM Radio Broadcast Band/ Air Band/ Information Radio Band.
- Is the voltage of the battery pack or external power source correct?
 - Check the remaining charge on the battery pack.
 - In addition, using a power supply where voltage drops during transmission will prevent the FT1XDR/DE from operating on full capability.

The keys or does not respond.

- Is the Key Lock or DIAL Lock on?

If you suspect malfunction

The battery pack cannot be charged or battery power depletes immediately after charging.









- Is the battery pack being charged with a charger specified by Yaesu?
Charge the battery pack using the accessory battery charger (PA-48B or SAD-11B) or the rapid charge cradle (CD-41).
When using an external power supply, use the external power supply adapter with a cigarette lighter plug (SDD-13) or an external power cable (E-DC-6).
- Is the battery pack in use exhausted?
If the "Charging Error" appears on the LCD when charging, there is a chance the battery pack is over discharged. If the error is repetitively displayed after charging the battery pack several times, the battery pack may have reached its service life or defective. Battery packs are consumables. Please replace the battery pack with a new one immediately. Battery packs can be charged and reused up to approximately 300 times.

Depending on the combination for simultaneous reception, there may be internal beats from high frequencies caused by the internal oscillator. This is not a malfunction. (See the calculation formula below: "n" is for the arbitrary integer). Depending on the combination for simultaneous reception, there may be fluctuations in reception sensitivity.

- Reception Frequency = 16 MHz × n multiplicative
- Reception Frequency = 15.6 MHz × n multiplicative
- Reception Frequency = 4.9152 MHz × n multiplicative
- Reception Frequency = 15.6 MHz × n multiplicative
- Reception Frequency = 18.432 MHz × n multiplicative
- Upper Side (A-Band) Frequency = (Lower Side (B-band) Frequency ± 46.35 MHz) × n multiplicative
- Upper Side (A-Band) Frequency = (Lower Side (B-band) Frequency ± 47.25 MHz) × n multiplicative @
Upper Side (A-band) Mode = NFM

Index

Symbol

 key	12
 key	12
 key	12
 key	12
 key	12
 switch	12
 switch	12
 key	12

A

Activating the GPS function	68
Adjusting the LCD backlight and keypad key light brightness level	107
Adjusting the LCD contrast level	106
Adjusting the microphone sensitivity	115
Adjusting the squelch level	37, 121
Adjusting the volume level	26
AF-DUAL function	77
All reset	39
AMS	32
AMS transmission mode	112
Analog FM mode	32
Antenna	6
Antenna terminal	12
APO function	127
APRS function	67
	*web
Assigning a name to a memory channel	47
Assigning name to memory bank	49
ATT function	109
Attaching a hand strap	16
Attaching the belt clip	15
Attaching the protective cap	15
Attenuator function	109

B

BACK TRACK function screen	74
Backtrack function	74
Band scope function	82
Battery approximate operating time	19
Battery case (FBA-39)	16
Battery Case 3x "AA" Cell (FBA-39)	146
Battery charger (PA-48B/C/U*)	146
Battery charger (SAD-11B; for USA market)	146
BCLO function	128
Before transmitting radio waves	11
Being called by the remote station (standby operation)	93
Bell	89
Belt clip	6
BNC-to-SMA adapter (CN-3)	146
Bundled items	6
Busy Channel Lockout function	128
BUSY/TX lamp	12

C

Calling a specific station	92
Calling only a specific station (new pager function)	90
Callsign	25
Canceling memory channel registration in memory bank	49
Canceling scanning	57
Changing home channel frequency	45
Changing the display pattern of the PO meter	109

Changing the frequency step manually	37
Changing the lighting condition	105
Changing the mode manually	38
Changing the number of times the bell rings	89
Changing the opening message displayed immediately after power-on	107
Changing the sound volume setting method	116
Changing the transmission power level	36
Charging the battery pack	17
Clock Type function	129
Clone cable (CT-168)	146
Clone operation	143
Communicating via the repeater	40
Communicating with a specific remote station	84
Communication mode	32
Confirming the entered DTMF code by the sound	80
Connecting the FT1XDR/DE to external devices	145

D

Data Cable (2.5Φ) (CT-176)	146
Data cable (CT-170)	146
Data FR mode	32
DATA terminal	12
DC cable (E-DC-6)	146
DC cable w/ noise filter (SDD-13)	146
DCS	84
DCS code	86
DCS INVERSION function	119
Deleting a frequency registered to the skip search memory channel	58
Deleting memory channel	46
Digital communication	32
Digital mode	32
Disabling reception while no signal is received	136
Dismounting microSD memory card	23
Displaying memory tag	47
Displaying the GPS screen	103
Displaying the version of the DSP program	115
DTMF function	79
Dual reception function	75
DW	75
DW TIME function	124

E

Earpiece microphone (MH-37A4B)	146
Enabling no-communication squelch function	120
Enter the Set mode	94
EXT DC IN jack	12
External power supply	21
External power supply for use in vehicle	20

F

Flashlight (white LED)	12
Flow of operation to use the pager function	90
FM mode	32
Formatting a microSD memory card	24
Frequencies of international VHF (marine) radio	53
Frequency band for the A-band	29
Frequency band for the B-band	29
FT1XDR/DE	6
FT1XDR/DE Firmware Updates	144

*web: Please download the instruction manuals for GM function and APRS from our home page.

Index

G

GM function	65
	*web
GPS	68
Group monitor function	65
	*web

H

Home channel	45
Home channel dual reception	76
HOME VFO	130

I

Input a call sign	25
Installing the antenna	15
Installing the battery pack	17
International VHF (marine) radio	52
IPX5	11

L

Listen to the international VHF (marine) radio	52
Listening radio broadcast with AF-DUAL reception function	77
Lithium ion battery packs (FNB-101LI, 7.4 V, 1100 mAh)	146
Lithium ion battery packs (SBR-14LI, 7.2 V, 2200 mAh)	146
LOCK function	131
Locking keys	39
Locking switches	39

M

Measuring the battery voltage and the transceiver temperature	108
Memory bank link scan	62
Memory channel dual reception	76
Memory channel protect function	118
Memory channel scanning	59
Memory channel write function	118
Memory functions	42
Memory tag	46
Method of positioning by GPS	70
Microphone adapter (CT-44)	146
Microphone gain	115
microSD memory card	22
Mounting microSD memory card	22
Mute	35
Muting audio	35
Muting the key operation confirmation tone	128

N

New pager function	90
Notification of a call from a remote station by the bell	89
Notification of call from the remote station by vibration of the vibrator	88

O

Operating band	27
Optional parts	146

P

Packet communication	142
Password function	133
PC connection cable (SCU-19)	6, 146
Performing communication	25, 31
Performing programmable memory channel scan	64
Permitting transfer of home channel frequency to VFO	130
PMS	63
PMS memory channel	63
Positioning by GPS	70
Power cable	20
Power supply voltage measurement function	108
PR FREQUENCY function	120
Preset receiver memory channel	51
Preventing accidental transmission	128
Priority memory channel	75
Programmable memory channel	63
Programmable memory channel scan	63
Prohibiting registration to memory channel	118
Protective plate for battery pack	6
PTT DELAY function	134

R

Rapid charger (CD-41)	146
Real-time navigation function	73
Recalling a memory channel	44
Recalling home channel	45
Recalling memory bank	49
Reception frequencies	28
Reception mode (radio wave type)	38
Reception Save function	136
Reducing receiver sensitivity	109
Register to a memory channel	43
Registering a memory channel in a memory bank	48
Registering CALLSIGN	141
Registering to a memory channel with the lowest memory channel number	118
Registering to a programmable memory channel	63
Registering your current position	74
Registering your favorite preset receiver memory channels in memory bank	51
Removing the battery pack	17
Repeater operation	40
Resetting the Set mode options	94
Restoring deleted memory channel	46
Restoring to defaults	39
Restricting the continuous transmission time	136
RPT ARS function	134
RPT SHIFT FREQ function	135
RPT SHIFT function	135

S

S meter squelch function	121
Safety precautions	7
Saving/ Loading data to/from microSD memory card	138
Saving/ Loading GROUP ID information to/from microSD memory card	139
Saving/ Loading memory channel information to/from microSD memory card	138
SCAN LAMP function	125
SCAN RE-START function	125
Scanning a memory bank	61
Scanning function	56
Scanning only the selected memory channel	61

Index

Searching for signals with the signal strength graph	82
Searching for the frequency of the DCS used by the remote station.....	87
Searching for the frequency of the tone squelch used by the remote station.....	86
Select a tone squelch type	84
Selected memory channel	60
Selecting a band.....	29
Selecting a DCS code	86
Selecting a display language.....	106
Selecting a frequency band.....	29
Selecting a reception method when scanning stops	59
Selecting a tone frequency.....	85
Selecting an operating band.....	27
Selecting communication mode.....	32
Selecting vibrator operation mode.....	88
Sending a DTMF code manually	81
Sending the registered DTMF code.....	80
Set mode.....	94
Set mode option list.....	95
Setting clock time	34
Setting interval to save GPS position information	130
Setting memory bank link	117
Setting the ARS function.....	134
Setting the clock shift for the micro computer.....	129
Setting the code of your station	91
Setting the conditions for locking.....	131
Setting the direction for repeater shift.....	135
Setting the display method for BACKTRACK.....	104
Setting the display method of the remote station information.....	104
Setting the DTMF code.....	79
Setting the frequency selection range for operation in the VFO mode	137
Setting the operation of 	132
Setting the operation of Monitor key.....	132
Setting the optional microphone with camera for use.....	140
Setting the pop up time of the remote station information	112
Setting the PTT delay time	134
Setting the range for repeater shift	135
Setting the range for SCAN	126
Setting the resumption time of radio reception	78
Setting the search channels for the BAND SCOPE function.....	105
Setting the signal strength to output sound	121
Setting the sound and speed during tone search.....	123
Setting the squelch type for the digital mode.....	112
Setting the squelch type for transmission and reception	122
Setting the surveillance interval time for priority channels.....	124
Setting the time signal	34
Setting the time to resume scan.....	124
Setting the transmission modulation level	110
Simultaneous radio broadcast reception	77
Simultaneous signal reception over the other frequency while listening to the radio	77
Skip memory channel	60
Skip search memory.....	57
Smart navigation function	73
Soft case (CSC-97)	146
Speaker / microphone (MH-34B4B)	146
Speaker Microphone with Snapshot camera (MH-85A11U)	82, 146
Specifying a selected memory channel	60
Specifying a skip memory channel	60
Specifying the frequency you do not want to scan	58
Split memory.....	44
SQL EXPANTION function	122
SQL LEVEL function.....	121

Squelch level.....	37
STANDBY BEEP setting.....	114
Switching between AM antennas.....	33
Switching between digital and analog mode	111

T

Taking picture	82
Taking picture with the optional camera mounted on speaker microphone	82
Temperature measurement function.....	108
Time signal tone	34
Timer function.....	132
Tone Calling (1750 Hz).....	40
Tone Search function	123
Tone squelch	84
TOT function.....	136
Transmission power level	36
Transmit and receive a DCS code with a inverted phase.....	119
Transmitting GPS data	144
Tuning in to a frequency	30
Turning illumination off when scanning stops	125
Turning off the BUSY indicator	129
Turning off the power automatically.....	127
Turning on the transceiver	25
Turning on/off the transceiver at the specified time	132

U

Usable microSD memory card.....	22
Using memory bank.....	48
Using the memory	42
Using the scanning function	56
Using the white LED as a flashlight	131

V

V/D mode.....	32
VFO dual reception.....	75
VFO MODE function	137
VFO scan.....	56
Vibrator	88
Vibrator operation mode	88
Voice FR mode.....	32
VOX headset (SSM-63A)	146

W

Worldwide short wave broadcast.....	54
-------------------------------------	----

Specifications

•General

Frequency Range

A (Main) Band RX:

0.5 ~ 1.8 MHz (AM Radio)
 1.8 ~ 30 MHz (SW Radio)
 30 ~ 76 MHz (50 MHz HAM: USA version)
 30 ~ 88 MHz (50 MHz HAM: EXP/EU version)
 76 ~ 108 MHz (FM Radio: USA version)
 88 ~ 108 MHz (FM Radio: EXP/EU version)
 108 ~ 137 MHz (Air Band)
 137 ~ 174 MHz (144 MHz HAM)
 174 ~ 222 MHz (VHF Band)
 222 ~ 420 MHz (GEN1)
 420 ~ 470 MHz (430 MHz HAM)
 470 ~ 774 MHz (UHF Band: USA version)
 470 ~ 800 MHz (UHF Band: EXP/EU version)
 803 ~ 999 MHz (GEN2, Cellular Blocked: USA version)
 800 ~ 999 MHz (GEN2: EXP/EU version)

B (Sub) Band RX:

108 ~ 137 MHz (Air Band)
 137 ~ 174 MHz (144 MHz HAM)
 174 ~ 222 MHz (VHF Band)
 222 ~ 420 MHz (GEN1)
 420 ~ 470 MHz (430 MHz HAM)
 470 ~ 580 MHz (UHF Band)

TX:

144 ~ 146 MHz or 144 ~ 148 MHz
 430 ~ 440 MHz or 430 ~ 450 MHz

Channel Steps:

5/6.25/8.33/9/10/12.5/15/20/25/50/100 kHz

Frequency Stability:

±2.5 ppm (–20 °C to +60 °C [–4 °F to +140 °F])

Emission Type:

F1D, F2D, F3E, F7W

Supply Voltage:

Nominal: 7.4 V DC (Negative Ground)

Operating:

4 – 14 V (Negative Ground, EXT DC JACK)
 11 – 16 V (Negative Ground, EXT DC JACK with SDD-13)
 7.4 V DC (Negative Ground)

Current Consumption:

150 mA (Mono band Receive)
 220 mA (Dual band Receive)
 100 mA (Mono band Receive, Standby)
 150 mA (Dual band Receive, Standby)
 45 mA (Mono band Receive, Standby, Saver On “Save Ratio 1:5”)
 45 mA (Dual band Receive, Standby, Saver On “Save Ratio 1:5”)
 +30 mA (GPS On)
 +65 mA (Digital)
 600 μ A (Auto Power Off)

Operating Temperature:

–20 °C to +60 °C [–4 °F to +140 °F]

Case Size (W × H × D):

60 × 95 × 32.5 mm (2.4" × 3.7" × 1.28") w/o knob & antenna

Weight (Approx.):

290 g (10.23 oz) with SBR-14LI & Antenna

Specifications

•Transmitter

RF Power Output:	5 W (@ 7.4 V or EXT DC)
Modulation Type:	F1D, F2D, F3E: Variable Reactance modulation F7W: 4 FSK (C4FM)
Spurious Emission:	At least 60 dB below (@TX Power Hi, L3, L2) At least 50 dB below (@TX Power L1)

•Receiver

Circuit Type:	AM, NFM: Double-Conversion Super heterodyne AM/FM Radio: Single-Conversion Super heterodyne
Intermediate Frequencies:	1st: 47.25MHz (AM, NFM A Band) 1st: 46.35MHz (AM, NFM B Band) 2nd: 450 kHz (AM, NFM) 1st: 130 kHz (AM/FM Radio)
Sensitivity:	3 μ V for 10 dB SN (0.5 ~ 30 MHz, AM) 0.35 μ V TYP for 12 dB SINAD (30 ~ 54 MHz, NFM) 1 μ V TYP for 12 dB SINAD (54 ~ 76 (88) MHz, NFM) 1.5 μ V TYP for 12 dB SINAD (76 (88) ~ 108 MHz, WFM) 1.5 μ V TYP for 10 dB SN (108 ~ 137 MHz, AM) 0.2 μ V for 12 dB SINAD (137 ~ 140 MHz, NFM) 0.16 μ V for 12 dB SINAD (140 ~ 150 MHz, NFM) 0.2 μ V for 12 dB SINAD (150 ~ 174 MHz, NFM) 1 μ V for 12 dB SINAD (174 ~ 222 MHz, NFM) 0.5 μ V for 12 dB SINAD (300 ~ 350 MHz, NFM) 0.2 μ V for 12 dB SINAD (350 ~ 400 MHz, NFM) 0.16 μ V for 12 dB SINAD (400 ~ 470 MHz, NFM) 1.5 μ V for 12 dB SINAD (470 ~ 540 MHz, NFM) 3 μ V TYP for 12 dB SINAD (540 ~ 800 MHz, NFM) 1.5 μ V TYP for 12 dB SINAD (800 ~ 999 MHz, NFM, Cellular Blocked) 0.19 μ V TYP for BER 1% (Digital Mode)
Selectivity:	NFM, AM 12 kHz / 35 kHz (-6 dB / -60 dB)
AF Output:	200 mW (8 Ω for 10 % THD 7.4 V) 400 mW (8 Ω for 10 % THD 13.8 V)

Specifications are subject to change without notice, and are guaranteed within the 144/222 (USA version)/430 MHz amateur bands only.

1. Changes or modifications to this device not expressly approved by YAESU MUSEN could void the user's authorization to operate this device.
2. This device complies with part 15 of the FCC Rules. Operation is subject to the following two conditions: (1) This device may not cause harmful interference, and (2) this device must accept any interference including received, interference that may cause undesired operation.
3. The scanning receiver in this equipment is incapable of tuning, or readily being altered, by the User to operate within the frequency bands allocated to the Domestic public Cellular Telecommunications Service in Part 22.

Part 15.21: Changes or modifications to this device not expressly approved by YAESU MUSEN could void the user's authorization to operate this device.

DECLARATION BY MANUFACTURER

The Scanner receiver is not a digital scanner and is incapable of being converted or modified to a digital scanner receiver by any user.

WARNING: MODIFICATION OF THIS DEVICE TO RECEIVE CELLULAR RADIOTELEPHONE SERVICE SIGNALS IS PROHIBITED UNDER FCC RULES AND FEDERAL LAW.

Attention in case of use

This transceiver works on frequencies which are not generally permitted.

As for the actual usage, the user has to possess an amateur radio licence.

Usage is allowed only in the frequency bands which are allocated for amateur radios.

List of national codes					
AT	BE	BG	CY	CZ	DE
DK	ES	EE	FI	FR	GB
GR	HR	HU	IE	IT	LT
LU	LV	MT	NL	PL	PT
RO	SK	SI	SE	CH	IS
LI	NO	-	-	-	-

Disposal of your Electronic and Electric Equipment

Products with the symbol (crossed-out wheeled bin) cannot be disposed as household waste.

Electronic and Electric Equipment should be recycled at a facility capable of handling these items and their waste by products.

In EU countries, please contact your local equipment supplier representative or service center for information about the waste collection system in your country.



YAESU

The radio

YAESU MUSEN CO., LTD.

Tennozu Parkside Building
2-5-8 Higashi-Shinagawa, Shinagawa-ku, Tokyo
140-0002 Japan

YAESU USA

6125 Phyllis Drive, Cypress, CA 90630, U.S.A.

YAESU UK

Unit 12, Sun Valley Business Park, Winnall Close
Winchester, Hampshire, SO23 0LB, U.K.

Copyright 2015

YAESU MUSEN CO., LTD.

All rights reserved.

No portion of this manual
may be reproduced
without the permission of
YAESU MUSEN CO., LTD.

Printed in Japan

1505X-FO