

YAESU

The radio

FTM-3200DR

Operating Manual

VHF DIGITAL /ANALOG TRANSCEIVER

C4FM/FM

Contents

FTM-3200DR Quick Reference Guide	3	Memory Operation.....	23
Introduction.....	4	Memory Storage	23
Features of this radio	4	Split Memory	23
Accessories & Options	5	Naming a Memory Channel.....	23
Supplied Accessories	5	Memory Recall.....	24
Optional Accessories	5	Memory Recall from the Microphone's Keypad ..	24
Installation.....	6	Masking Memories	25
Connecting the Microphone.....	6	Un Masking Memory.....	25
Connecting the Antenna	6	HOME Channel Memory	25
Mobile Installation.....	7	Changing the frequency of the home channel....	25
Power connection	8	Scanning	26
Base Station Installation	9	Basic Scanner Operation.....	26
AC Power Supplies	9	Scan Resume Options	26
Front Panel Controls & Switches.....	10	Memory Skip Scanning.....	26
Front Panel	10	Preferential Memory Scan	26
Microphone Switches.....	12	Programmable Memory Scan (PMS).....	26
Microphone (MH-48A6JA)	12	Priority Channel Scanning (Dual Watch)	26
[P1] button (SQL OFF).....	12	GM Function.....	27
[P2] button (HOME)	12	What is the GM (Group Monitor) Function?.....	27
[P3] button (CD SRCH).....	12	Displaying all the stations using the GM function	27
[P4] button (WX CH/T.CALL)	12	Miscellaneous Settings.....	28
Rear Panel Connectors	13	Reset Procedure.....	28
Rear Panel.....	13	Microprocessor Resetting.....	28
Basic Operation	14	Set Mode Resetting	28
Turning the Transceiver ON and OFF	14	Programming the Key Assignments	29
Inputting the call sign	14	Keyboard Beeper.....	29
Adjusting the Audio Volume Level	14	Display Brightness.....	29
Adjusting the Squelch Setting.....	14	Time-Out-Timer (TOT).....	29
Frequency Navigation.....	15	Automatic Power Off (APO).....	29
Using the Dial	15	Busy Channel Lock-Out (BCLO)	29
Using the MH-48A6JA Microphone.....	15	TX Deviation Level	29
Channel Step Selection	15	MIC Gain Setting	29
Selecting the communication mode.....	16	Packet Operation	30
Transmission	17	Cloning	31
Adjusting the transmit power	18	Setup (Menu) Mode	32
Lock Feature	18	Specifications	35
Advanced Operation	19		
Repeater Operation	19		
Checking the Repeater Uplink (Input) Frequency	19		
Weather Broadcast Reception.....	20		
Severe Weather Alert Feature	20		
CTCSS Operation.....	21		
DCS Operation	21		
EPCS (Enhanced Paging & Code Squelch)	21		
Operation.....	22		
Split Tone Operation	22		
DTMF Operation.....	22		

FTM-3200DR Quick Reference Guide

② VOL Knob

Adjusts the audio volume level.

③ Frequency DIAL Knob

Selects the operating Frequency.

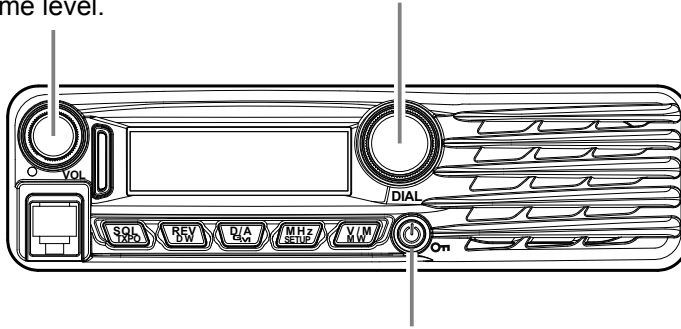

① Power Switch

Press and hold for one second.

④ Transmission Switch

Speak into the microphone in a normal voice level while pressing this switch.

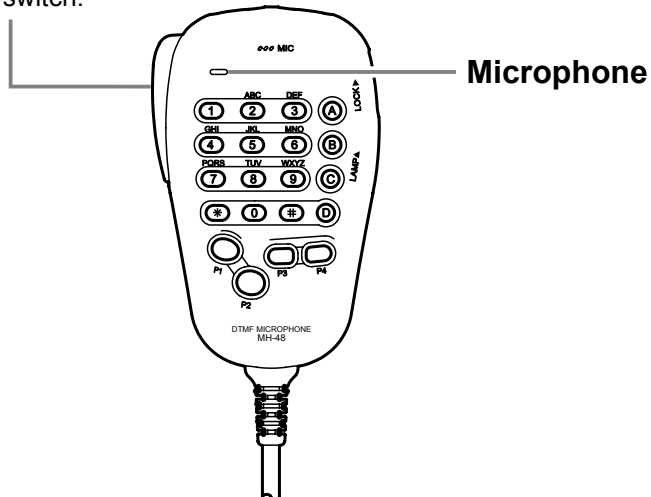

Introduction

Features of this radio

- 144 MHz mobile radio equipped with standard C4FM digital communication modem
- 65 Watts of power output, with selection of three power levels for every operating situation
- Clear audio and data communication is achieved using the digital modem functions
- Expanded receiver coverage: 136-174 MHz
- Keyboard entry of operating frequencies from the microphone
- 220 memories (199 “basic” memory channels, 10 sets of band-edge memory channels, and one “Home” channel) which can store repeater shifts, odd repeater shifts, CTCSS/ DCS tones, and 8-character Alpha-Numeric labels for easy channel recognition
- 10 NOAA Weather Broadcast Channels, with Weather Alert and a Volume Control for the Weather Alert tone
- Built-in CTCSS and DCS Encoder/Decoder circuits
- Extensive Menu system, which allows customization of a number of transceiver performance characteristics
- GM (Group Monitor) function where in a group of frequently communicating members can be registered

Additional features include a transmit Time-Out-Timer (TOT), Automatic Power-Off (APO), Automatic Repeater Shift (ARS). And an RF Squelch circuit allows the owner to set the squelch to open at a programmable setting of the S-Meter, thus reducing guesswork in setting the squelch threshold.

Congratulations on your purchase of the FTM-3200DR! Whether this is your first rig, or if Yaesu equipment is already the backbone of your station, the Yaesu organization is committed to ensuring your enjoyment of this high-performance transceiver, which should provide you with many years of satisfying operation. Our dealer network and technical support personnel stand behind every product we sell, and we invite you to contact us should you require technical advice or assistance.

We recommend that you read this manual in its entirety prior to installing the FTM-3200DR, so that you fully understand the capabilities of your new transceiver.

Accessories & Options

Supplied Accessories

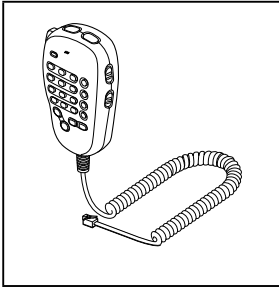

DTMF Microphone
MH-48A6JA

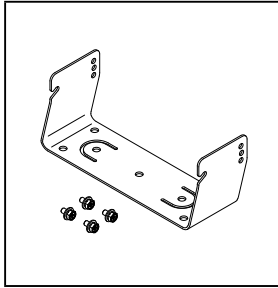

Mobile Mounting Bracket
(Attachment screw set)

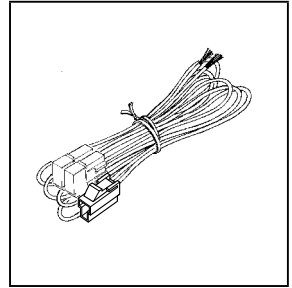

DC power cable w/Fuse

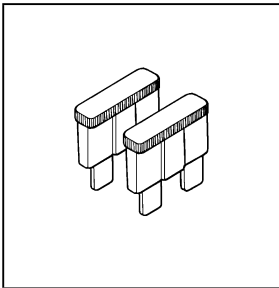

Spare fuse (25 A)

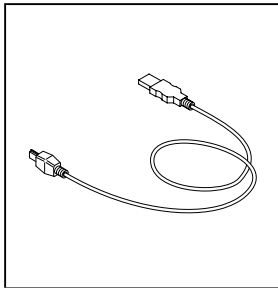

USB cable

Operating Manual
Warranty Card

Optional Accessories

MH-42C6J	Microphone
MH-48A6JA	DTMF Microphone
MEK-2	Mic Extension Kit
MLS-100	High-Power External Speaker
MLS-200-M10	High-Power External Speaker
FP-1023	AC Power Supply (USA market only)
FP-1030A	AC Power Supply

Installation

Connecting the Microphone

Connect the supplied MH-48A6JA microphone to the body.

Plug the microphone connector into the MIC jack on the front panel until it clicks.

Note: When disconnecting the microphone, pull the cable while pressing the connector latch.

Connecting the Antenna

Connect the coaxial cable to the body.

Plug the coaxial cable jack into the ANT terminal on the rear panel of the body, then rotate and tighten it.

Installation

Mobile Installation

The FTM-3200DR must only be installed in vehicles having a 13.8 Volt negative ground electrical system. Mount the transceiver where the display, controls, and microphone are easily accessible, using the supplied mounting bracket.

The transceiver may be installed in almost any location, but should not be positioned near a heating vent nor anywhere where it might interfere with driving (either visually or mechanically).

Make sure to provide plenty of space on all sides of the transceiver so that air can flow freely around the radio's case. Refer to the diagrams showing proper installation procedures.

Installation

Power connection

To minimize voltage drop and avoid blowing the vehicle's fuses, connect the supplied DC power cable directly to the battery terminals. Do not attempt to defeat or bypass the DC cable's fuse - it is there to protect you, your transceiver, and your vehicle's electrical system.

Warning!

Never apply AC power to the power cable of the FTM-3200DR, nor DC voltage greater than 15.8 Volts. When replacing the fuse, only use a 25-A fuse. Failure to observe these safety precautions will void the Limited Warranty on this product.

Before connecting the transceiver, check the voltage at the battery terminals while revving the engine. If the voltage exceeds 15 Volts, adjust the vehicle's voltage regulator before proceeding with installation.

Connect the **RED** power cable lead to the **POSITIVE (+)** battery terminal, and the **BLACK** power cable lead to the **NEGATIVE (-)** terminal. If you need to extend the power cable, use #12 AWG or larger insulated, stranded copper wire. Solder the splice connections carefully, and wrap the connections thoroughly with insulating electrical tape.

Before connecting the cable to the transceiver, verify the voltage and polarity of the voltage at the transceiver end of the DC cable using a DC voltmeter. Now connect the transceiver to the DC cable.

Base Station Installation

The FTM-3200DR is ideal for base station use as well as in mobile installations. The FTM-3200DR is specifically designed to integrate into your station easily, using the information to follow as a reference.

AC Power Supplies

Operation of the FTM-3200DR from an AC line requires a power source capable of providing at least 20 Amps continuously at 13.8 Volts DC. The FP-1023 (USA market only) and FP-1030A AC Power Supplies are available from your Yaesu dealer to satisfy these requirements. Other well regulated power supplies may be used, as well, if they meet the above voltage and current specifications.

Use the DC power cable supplied with your transceiver for making power connections to the power supply. Connect the **RED** power cable lead to the **POSITIVE (+)** power supply terminal, and connect the **BLACK** power cable lead to the **NEGATIVE (-)** power supply terminal.

Front Panel Controls & Switches

Front Panel

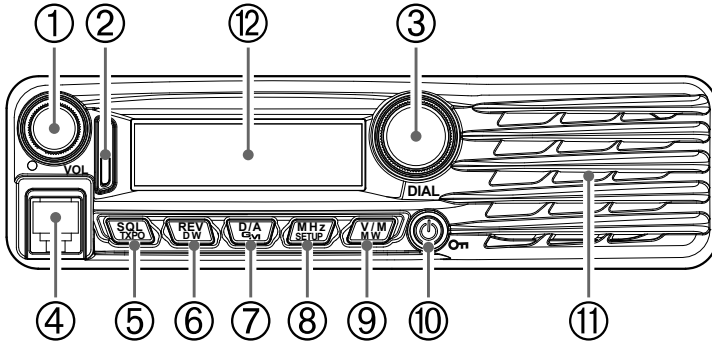

① VOL knob

Turning the knob clockwise increases the volume, whereas turning it counterclockwise decreases the volume.

② Mode/Status indicator

Indicates the transmission/reception status with a two-color combination on the upper and lower portions of the mode/status indicator.

Communication status	Upper portion	Lower portion
Receiving analog audio	Green	Green
Transmitting analog audio	Red	Red
Receiving digital audio	Green	Blue
Transmitting digital audio	Red	Blue
Receiving digital data	Green	White
Transmitting digital data	Red	White
Receiving signals with unmatched tone frequency or DCS code	Green	Blink in Blue

③ DIAL Knob

- Allows you to set the operating band frequency.
Turning clockwise increases the frequency whereas turning counterclockwise decreases the frequency.
- Allows you to select the desired item for setup, memory registration, group monitoring operation, etc.

④ MIC Jack

Connect the provided microphone cable.

⑤ [SQL(TXPO)] key

Pressing this key briefly and rotating the DIAL sets the squelch level.
 Press and hold in this key for over 1 second to select the transmission power (HIGH: 65 W / MID: 30 W / LOW: 5 W).

Front Panel Controls & Switches

- ⑥ **[REV(DW)]** key
 During split-frequency operation, such as through a repeater, this key reverses the transmit and receive frequencies.
 Press and hold in this key for over 1 second to activate the Dual Watch feature.
Note: For details, refer to the Advanced Manual (download from the Yaesu website).
- ⑦ **[D/A(GM)]** key
 Briefly pressing each time switches the operating band communication mode.
 Press and hold in this key for over 1 second to activate the GM (Group Monitor) function.
Note: For details on the GM function, see “GM (Group Monitor) Function” on page xx.
- ⑧ **[MHz(SETUP)]** key
 This key allows tuning in 1 MHz steps (the MHz digits will blink on the display).
 Press and hold in this key for over 1 second to activate the Setup (Menu) Mode.
- ⑨ **[V/M(MW)]** key
 Briefly pressing each time switches between VFO mode and memory mode.
 Press and hold for over 1 second displays the memory registration screen.
- ⑩ **Power/Lock** key
 Press and hold in this key for over 1 seconds switches the power between ON and OFF.
 Briefly pressing the key while the transceiver is turned ON engages or releases the key lock.
- ⑪ **Speaker**
- ⑫ **LCD Display**

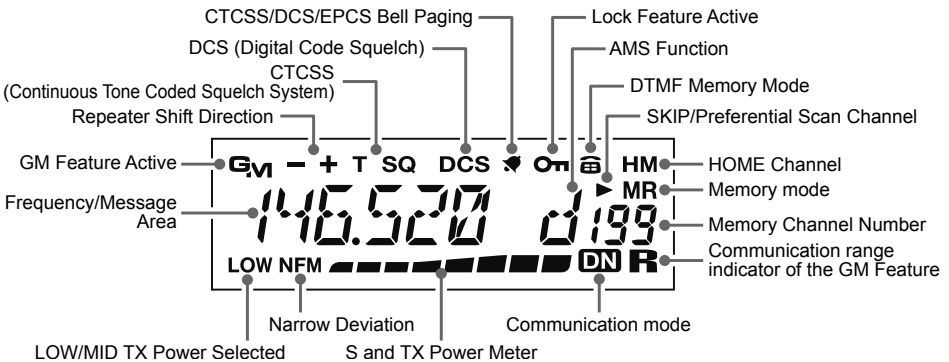

Microphone Switches

Microphone (MH-48A6JA)

① PTT Switch

Press this switch to transmit, and release it to receive.

② KEY Pad

These 16 keys generate DTMF tones during transmission.

In the receive mode, these 16 keys can be used for direct frequency entry and/or direct numeric recall of the Memory channels.

③ [P1] / [P2] / [P3] / [P4] keys

These four keys are user programmable, allowing quick access to features used often. The default functions are described below.

[P1] button (SQL OFF)

Press this button to disable the noise and tone squelch systems.

[P2] button (HOME)

Press this button to recall the receiver HOME channel.

[P3] button (CD SRCH)

Press this button to activate the Tone Search feature.

[P4] button (WX CH/T.CALL)

In the USA version, pressing this button recalls the “Weather” broadcast channel bank. In the EXP version, pressing this button activates T.CALL (1750 Hz) for repeater access.

You can reprogram the [P1], [P2], [P3], and [P4] buttons for other functions, if desired.

Note: For details, refer to the Advanced Manual (download from the Yaesu website).

④ MIC

Speak into this part during transmission.

⑤ [UP] / [DWN] keys

Press (or hold in) either of these buttons to tune (or scan up or down) the operating frequency or through the memory channels. In many ways, these buttons emulate the function of the (rotary) DIAL knob.

⑤ LOCK switch

This switch locks out the Microphone’s buttons (except for the keypad and PTT switch).

⑤ LAMP switch

This switch illuminates the Microphone’s keypad.

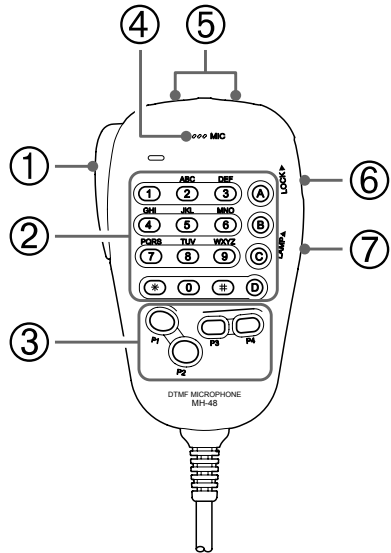

Rear Panel Connectors

Rear Panel

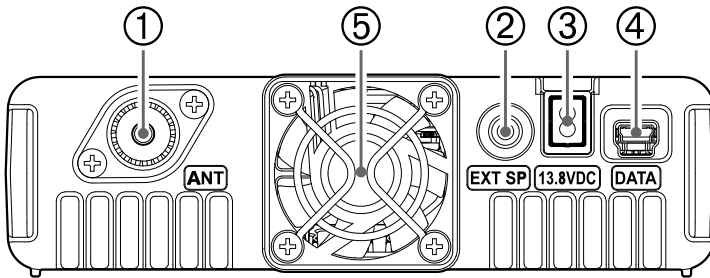

① ANT Coaxial Socket

Connect a 144 MHz antenna to this type-M (SO-239) socket using 50-Ohm coaxial cable and a type-M (PL-259) plug. Make sure the antenna is designed specifically for use on the operating frequency.

② EXT SP Jack

This 2-contact 3.5-mm mini phone jack provides receiver audio output for an optional external speaker. The audio impedance is 4 Ohms, and the level varies according to the setting of the front panel's **VOL** control. Inserting a plug into this jack disables audio from the transceiver's internal speaker.

③ 13.8 V DC Cable

Connect the provided DC power supply cable (with fuse attached).

④ DATA Jack

Use this jack when updating the firmware. When a new firmware update for the FTM-3200DR is available, go to the YAESU website to download the programming data and update the FTM-3200DR to its newest state.

⑤ Cooling Fan

Basic Operation

Turning the Transceiver ON and OFF

1. To turn the transceiver ON, press and hold in the **PWR** key for 1 second.
2. To turn the transceiver OFF, again press and hold in the **PWR** key for 1 second.

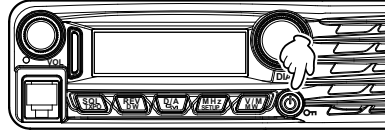

You can set the Opening Message to any desired message (up to 8 characters) via Setup Menu Item “**OPEN MSG 27**” see page xx for details.

Inputting the call sign

A screen requesting input of a call sign appears when turning the transceiver on for the first time, or after resetting the transceiver. The call sign is used to identify the transmitting station when communicating in digital mode.

1. Press the **[V/M(MW)]** key.
2. Rotate the **DIAL** knob to select characters, then press the **[V/M(MW)]**.



By rotating the **DIAL** knob, you can switch the characters in the following order:

“space” ⇨ “-” ⇨ “/” ⇨ “0” to “9” ⇨ “A” to “Z”

- Up to 10 characters (alphanumeric characters including hyphen) can be entered.
- “space”, “-”, and “/” are not selectable for the first character.

Adjusting the Audio Volume Level

Rotate the **VOL** knob to adjust the receiver volume. Clock-wise rotation increases the audio output level.

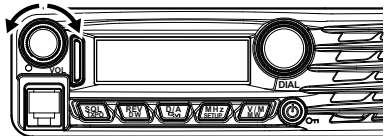

Adjusting the Squelch Setting

1. Press the **[SQL(TXPO)]** key, then rotate the **DIAL** knob to select the Squelch level.
2. Press the **[SQL(TXPO)]** key again.

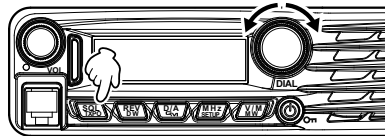

Note: A special “RF Squelch” feature is provided on this radio. This feature allows you to set the squelch so that only signals exceeding a certain S-meter level will open the squelch. For details, refer to the Advanced Manual (download from the Yaesu website).

Basic Operation

Frequency Navigation

Using the Dial

Rotating the **DIAL** knob allows tuning in the pre-programmed steps. Clockwise rotation tunes the frequency upwards, whereas counterclockwise rotation tunes the frequency downwards.

- Press the [**MHz(SETUP)**] key momentarily, then rotate the **DIAL** knob, to change the frequency steps to 1 MHz per step.

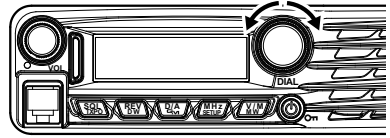

Using the MH-48A6JA Microphone

Using the [UP] and [DWN] key:

Pressing [**UP**] momentarily, tunes the frequency upwards. Whereas pressing [**DWN**] momentarily tunes the frequency in the downwards direction.

Using the number keys:

Use the [0] to [9] number keys to directly input the frequency.

There is no “decimal point” key on the MH-48A6J keypad. However, there is a short-cut for frequencies ending in zero: press the [#] key after the last non-zero digit.

- Examples:** To enter 146.520 MHz, press [1] ➡ [4] ➡ [6] ➡ [5] ➡ [2] ➡ [0]
To enter 146.000 MHz, press [1] ➡ [4] ➡ [6] ➡ [#]

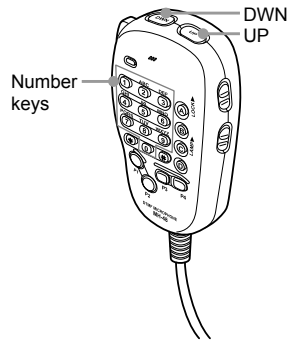

Channel Step Selection

The **DIAL** and microphone [**UP**]/[**DWN**] keys frequency tuning step can be changed.

Note: See Setup Menu Item “**STEP 43**” on page xx.

Basic Operation

Selecting the communication mode

The FTM-3200DR transceiver is equipped with the AMS (Automatic Mode Select) function which automatically selects from 4 modes of transmission corresponding to the signal being received.

The transmit mode is selected according to the received signal so that C4FM digital signals, and analog signals are received and transmitted automatically.

Press [D/A(GM)] key to display “DN” (blinks) icon on the screen.



Display example when in AMS mode

To operate in fixed communication mode, press [D/A(GM)] key to switch the communication mode.

Each time [D/A(GM)] key is pressed, the communication mode changes in the following order:

➡ AMS (“DN” blinks) ➡ V/D (“DN” lights up) ➡ FM (no icon) ➡

Communication mode	Icon	Description of modes
AMS (Automatic Mode Select)	DN (blinks)	Transmission mode is automatically selected from 4 types according to the signal received. The AMS function operation can be changed from the Setup menu setting. See “Setting the transmission mode when using the AMS function (DIG AMS 11)” on page xxx.
V/D Mode (Voice/Data simultaneous transmission mode)	DN (light up)	Calls are less prone to interruptions due to detection and correction of voice signals during digital voice signal transmission. This is the standard mode for C4FM Digital.
Analog FM Mode	no icon	Analog communication using FM mode. Effective when the signal is weak and audio is susceptible to interruption in digital mode.

Basic Operation

Transmission

1. Press and hold **PTT** on the microphone.
In analog mode, both the upper and lower portions of the mode/status indicator light red.
In digital mode, the upper portion of the mode/status indicator lights red and the lower portion of the mode/status indicator lights blue.

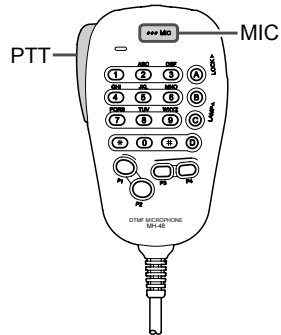

Analog mode: Both the upper and lower portions light red

Digital mode: The upper portion lights red and the lower portion lights blue

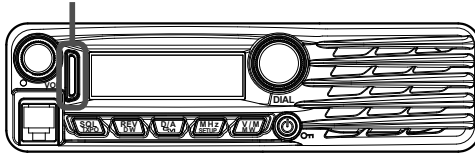

2. Speak into **MIC** on the microphone.
Note: Keep the microphone about 5 cm away from your mouth.
The sensitivity (gain) of the microphone can be adjusted. For details, refer to the Advanced Manual (download from the Yaesu website).
3. Release **PTT**.
The transmit mode/status indicator turns off and the transceiver returns to the receive mode.
Caution: Do not continue transmitting for a prolonged period. The transceiver may overheat, resulting in malfunction or burn.
Note: "ERROR" appears if you attempt to transmit an unavailable frequency.

Basic Operation

Adjusting the transmit power

When communicating with a nearby station, the transmit power level may be lowered to reduce the battery power consumption.

1. Press and hold in the **[SQL(TXPO)]** key for over 1 second.
2. Rotate the **DIAL** to select the transmit power.

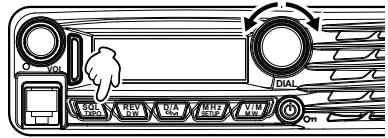

Note: The default setting: HIGH



HIGH (65 W)



MID (30 W)



LOW (5 W)

3. Press the **[SQL(TXPO)]** key to save the new setting and exit to normal operation.

Lock Feature

To activate the locking feature, press the **[Power(Lock)]** key. The "On" icon will appear on the LCD.

To cancel locking, press the **[Power(Lock)]** key again.

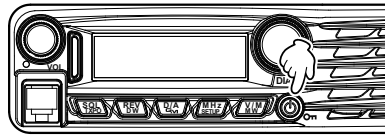

To lock out some or all of the keys, use the Setup Menu Item "**LOCK 23**" see page xx for details.

Advanced Operation

Repeater Operation

The FTM-3200DR includes the ARS (Automatic Repeater Shift) function which permits communication through repeaters automatically, by simply setting the receiver to the repeater frequency.

1. Tune to the repeater frequency.
2. Press the **PTT** to transmit.

During transmission, radio waves having an 100.0 Hz* tone signal are emitted on the frequency lower than reception frequency by 5 MHz*.

*: Depends on the transceiver version.

Note: From the Setup Menu, you can change the repeater setting.

RPT ARS 36 ➡ Deactivates the ARS function.

RPT FREQ 37 ➡ Allows changing the repeater shift frequency offset.

RPT SFT 38 ➡ Allows setting the repeater shift direction.

Checking the Repeater Uplink (Input) Frequency

It often is helpful to be able to check the uplink (input) frequency of a repeater, to see if the calling station is within direct ("Simplex") range.

To do this, just press the **[REV(DW)]** key. You'll notice that the display has shifted to the repeater uplink frequency. Press the **[REV(DW)]** key again to cause operation to revert to normal monitoring of the repeater downlink (output) frequency. While you are listening on the input frequency to the repeater using the **[REV(DW)]** key, the repeater offset icon will blink.

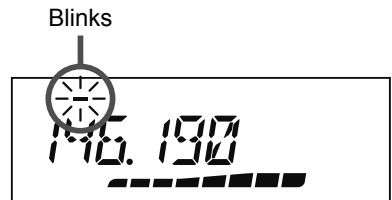

Advanced Operation

Weather Broadcast Reception

The FTM-3200R includes a unique feature which allows reception of weather broadcasts in the 160 MHz frequency range. Ten standard Weather Broadcast channels are preloaded into a special memory bank.

To listen to a Weather Broadcast Channel:

1. Press the Microphone's **[P4]** button to recall the Weather Broadcast channels.

Note: The **[P4]** key, one of the programmable keys, is assigned (default setting) as the “WX Broadcast” one-touch access key. Please note that if you change/assign another function to the **[P4]** key, one-touch access to the WX channel will be unavailable.

2. Turn the **DIAL** knob to select the desired Weather Broadcast channel.
3. If you wish to check the other channels for activity by scanning, just press the Microphone's **PTT** switch.
4. To exit to normal operation, press the **[P4]** button again. Operation will return to the VFO or Memory channel you were operating on before you began Weather Broadcast operation.

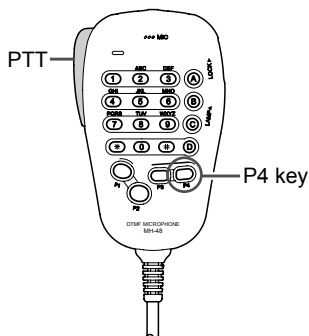

CH	Frequency	CH	Frequency
1	162.550 MHz	6	162.500 MHz
2	162.400 MHz	7	162.525 MHz
3	162.475 MHz	8	161.650 MHz
4	162.425 MHz	9	161.775 MHz
5	162.450 MHz	10	163.275 MHz

Severe Weather Alert Feature

In the event of extreme weather disturbances, such as storms and hurricanes, NOAA (the National Oceanic and Atmospheric Administration) sends a weather alert accompanied by a 1050 Hz tone and subsequent weather report on one of the NOAA weather channels. You may enable this feature via Setup Menu Item “**WX ALERT 50**” see page xx for details.