

# INSTALLATION AND INTERCONNECTIONS

## INTERFACING TO OTHER LINEAR AMPLIFIERS

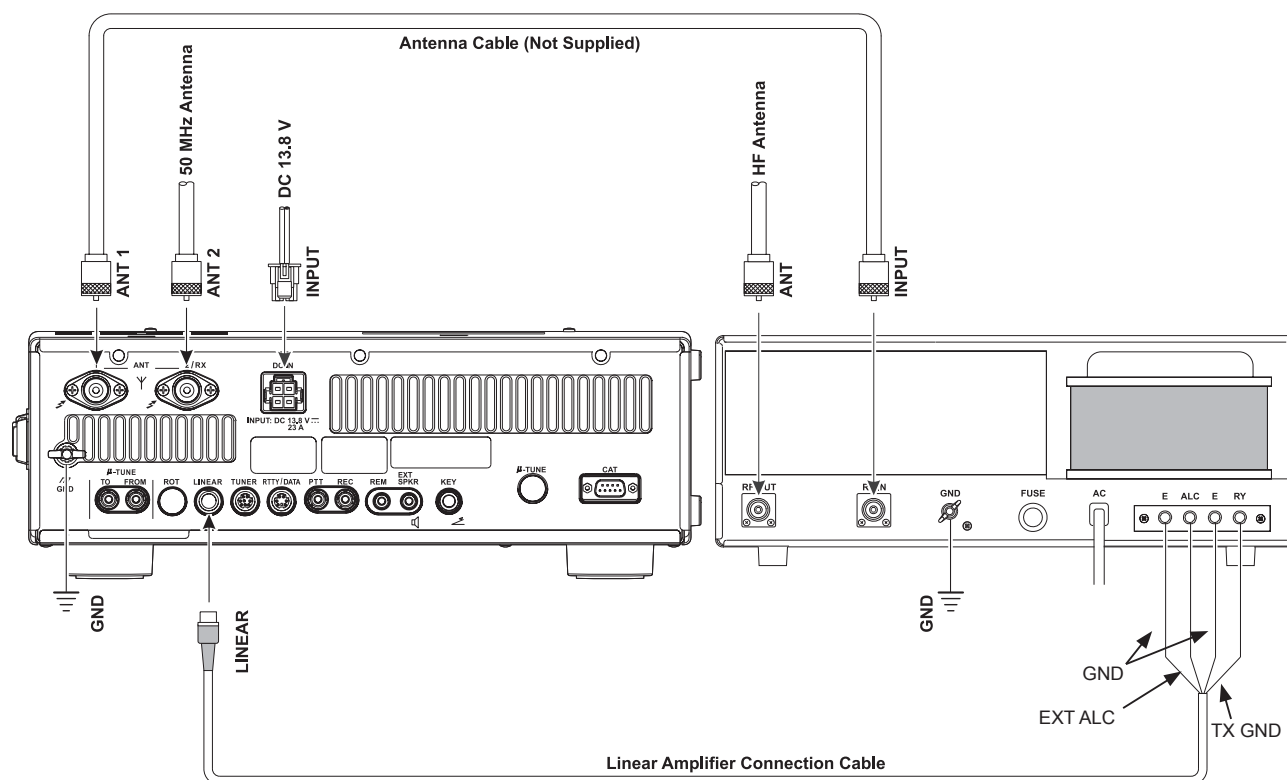

### NOTE

- ❑ The TX GND OUT pin (pin 2) of the **LINEAR** jack is a transistor “open collector” circuit. It is capable of handling positive relay coil voltages up to +60VDC at 200 mA or +30 VDC at 1 A. If you plan to use multiple linear amplifiers for different bands, you must provide external band switching of the “Linear Tx” relay control line from the “TX GND OUT” line at the **LINEAR** jack.
- ❑ The specified range for ALC voltage to be used with the **FTdx1200** is 0 to -4 Volts DC.
- ❑ Amplifier systems utilizing different ALC voltages will not work correctly with the **FTdx1200**, and their ALC lines must not be connected if this is the case.

### IMPORTANT NOTE!



- ❑ Do not exceed the maximum voltage or current ratings for the “TX GND OUT” pin (pin 2) of the **LINEAR** jack. This line is not compatible with negative DC voltages, or AC voltages of any magnitude.
- ❑ Most amplifier control relay systems require only low DC voltage/current switching capability (typically, +12V DC at 25 ~ 75 mA), and the switching transistor in the **FTdx1200** will easily accommodate such amplifiers.

### Note

When the **FC-40** is connected to the **FTdx1200**, TX GND (pin 2) of the **TUNER** jack and the **LINEAR** jack (pin 2) are common circuits.

Therefore, the maximum voltage at TX GND (pin 2) of the **LINEAR** jack must not exceed +5V.

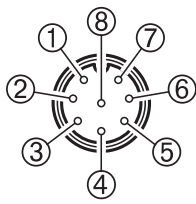
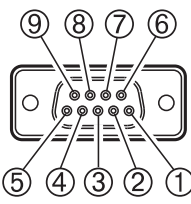
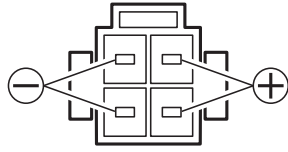
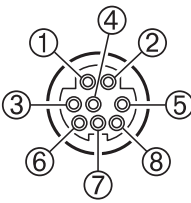
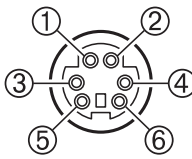
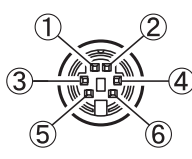
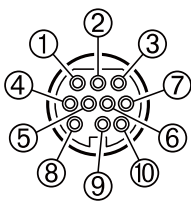
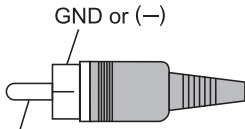
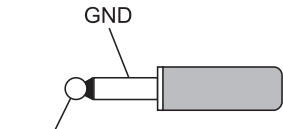
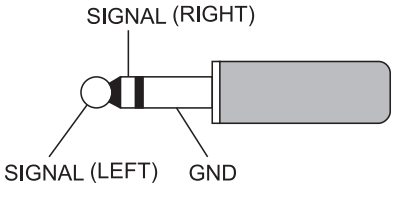
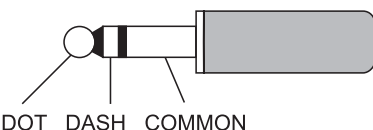
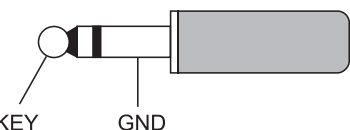
# PLUG/CONNECTOR PINOUT DIAGRAMS

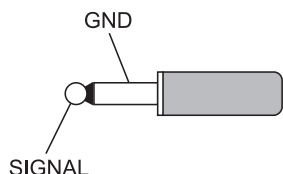
MIC	CAT	DC IN
 <ul style="list-style-type: none"> <li>① UP</li> <li>② +5V</li> <li>③ DOWN</li> <li>④ FAST</li> <li>⑤ GND</li> <li>⑥ PTT</li> <li>⑦ MIC GND</li> <li>⑧ MIC</li> </ul> <p>(as viewed from front panel)</p>	 <ul style="list-style-type: none"> <li>① N/A</li> <li>② SERIAL OUT</li> <li>③ SERIAL IN</li> <li>④ N/A</li> <li>⑤ GND</li> <li>⑥ N/A</li> <li>⑦ RTS</li> <li>⑧ CTS</li> <li>⑨ NC</li> </ul> <p>(as viewed from rear panel)</p>	 <p>(as viewed from rear panel)</p>
TUNER	RTTY/PKT	ROT (ROTATOR)
 <ul style="list-style-type: none"> <li>① +13V OUT</li> <li>② TX GND</li> <li>③ GND</li> <li>④ RX D</li> <li>⑤ TX D</li> <li>⑥ TUNER SENSE</li> <li>⑦ RESET OUT</li> <li>⑧ TX INH</li> </ul> <p>(as viewed from rear panel)</p>	 <ul style="list-style-type: none"> <li>① DATA IN</li> <li>② GND</li> <li>③ DATA PTT</li> <li>④ FSK IN</li> <li>⑤ DATA OUT</li> <li>⑥ SQL OUT</li> </ul> <p>(as viewed from rear panel)</p>	 <ul style="list-style-type: none"> <li>① CW ROTATION</li> <li>② CCW ROTATION</li> <li>③ SPEED</li> <li>④ DIRECTION</li> <li>⑤ GND</li> <li>⑥ NC</li> </ul> <p>(as viewed from rear panel)</p>
LINEAR	RCA PLUG	REM (REMOTE)
 <ul style="list-style-type: none"> <li>① +13V OUT</li> <li>② TX GND</li> <li>③ GND</li> <li>④ BAND DATA A</li> <li>⑤ BAND DATA B</li> <li>⑥ BAND DATA C</li> <li>⑦ BAND DATA D</li> <li>⑧ TX INH</li> <li>⑨ EXT ALC IN</li> <li>⑩ TX REQ IN</li> </ul> <p>(as viewed from rear panel)</p>	 <p>GND or (-) SIGNAL or (+)</p>	 <p>GND SIGNAL</p>
PHONE	KEY	
 <p>SIGNAL (RIGHT) SIGNAL (LEFT) GND</p>	<p><i>For Internal Keyer</i></p>  <p>DOT DASH COMMON</p>	<p><i>For Straight Key</i></p>  <p>KEY GND</p> <p> Do not use 2-conductor type plug</p>
EXT SPKR		
 <p>GND SIGNAL</p>		

# FRONT PANEL CONTROLS & SWITCHES

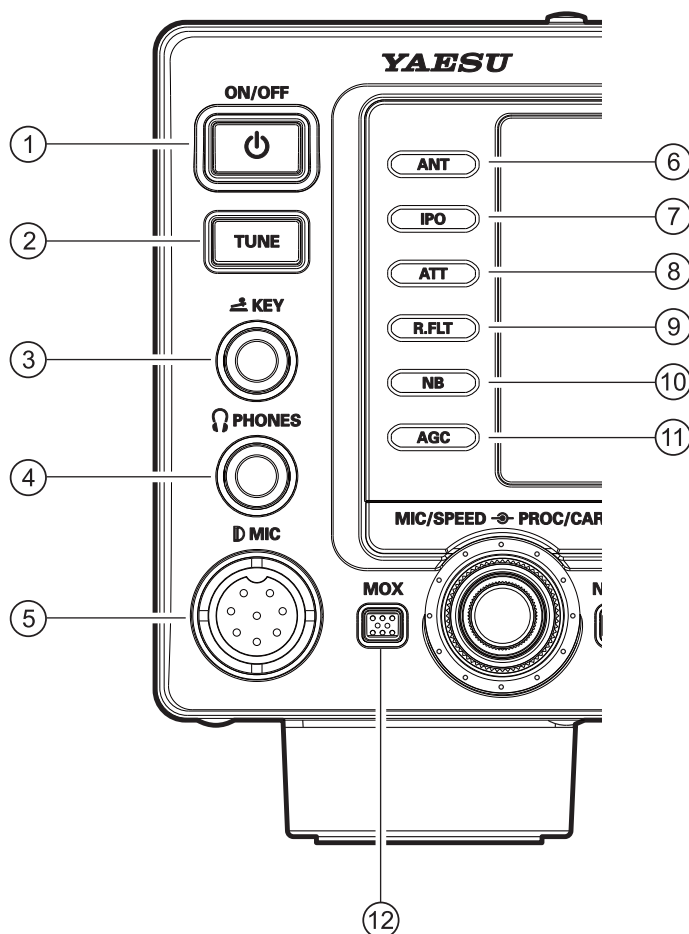

## ① [POWER] Switch

Press and hold in this switch for one second to turn the transceiver on. Similarly, press and hold in this switch for one second to turn the transceiver off.

## ② [TUNE] Switch

This is the on/off switch for the FT-DX1200's Automatic Antenna Tuner.

Pressing this button momentarily places the antenna tuner in line between the transmitter final amplifier and the antenna jack (The "TUNER" icon will appear in the display). Reception is not affected.

Pressing and holding in this button for two seconds, while receiving in an amateur band, activates the transmitter for a few seconds while the automatic antenna tuner rematches the antenna system impedance for minimum SWR. The resulting setting is automatically stored in one of the antenna tuner's 100 memories for instant automatic recall later when the receiver is tuned near the same frequency.

Pressing this button momentarily, while the Tuner is engaged, will take the Automatic Antenna tuner out of the transmit line.

### NOTE:

When the Automatic Antenna Tuner is tuning itself, a signal is being transmitted. Therefore, be certain that an antenna or dummy load is connected to the selected antenna jack before pressing and holding in the [TUNE] switch to start antenna tuning.

## ③ KEY Jack

This 1/4-inch, 3-contact jack accepts a CW key or keyer paddles (for the built-in electronic keyer), or output from an external electronic keyer. Pinout is shown on page 15. Key up voltage is +3.3 V DC, and key down current is 4 mA. This jack may be configured for keyer, "Bug", "straight key", or computer keying interface operation via Menu item "018 F CW KEYS" (see page 114). There is another jack with the same name on the rear panel, and it may be configured independently for Internal Keyer or pseudo-straight-key operation.

### NOTE:

You cannot use a 2-contact plug in this jack (to do so produces a constant "key down" condition).

# FRONT PANEL CONTROLS & SWITCHES

## ④ PHONES Jack

A 1/4-inch, 3-contact jack accepts either monaural or stereo headphones with 2- or 3-contact plugs. When a plug is inserted, the loudspeaker is disabled.

### NOTE:

When wearing headphones, we recommend that you turn the AF Gain levels down to their lowest settings before turning power on, to minimize the impact on your hearing caused by audio “pops” during switch-on.

## ⑤ MIC Jack

This 8-pin jack accepts input from a microphone utilizing a traditional YAESU HF transceiver pinout.

## ⑥ [ANT] Switch

Pressing this switch selects the **ANT 1** or the **ANT 2** connector on the rear panel, and allows convenient antenna switching at the press of a button. The selected antenna jack is indicated on the Block Diagram Display shown in the Transceiver Display.

### ADVICE:

The ANT2 jack enables to use as an antenna for reception only, using the Menu item “032 ANT2 SETTING”. See page 115.

## ⑦ [IPO] (INTERCEPT POINT OPTIMIZATION) Switch

This button may be used to set the optimum front end characteristics of the receiver circuit for a very strong signal environment. Available selections are AMP 1 (low distortion amplifier), AMP 2 (2-stage low-distortion RF amplifier), or IPO (bypasses the front end RF amplifier). The selected receiver RF amplifier appears in the IPO column of the Block Diagram Display on the display.

## ⑧ [ATT] Switch

This button selects the degree of attenuation, if any, to be applied to the receiver input.

Available selections are -6 dB, -12 dB, -18 dB, or OFF. The attenuation level appears in the ATT column of the Block Diagram Display on the display.

### ADVICE:

The Attenuator may be used in conjunction with the [IPO] button to provide two stages of signal reduction when an extremely strong signal is being received.

## ⑨ [R.FLT] (ROOFING FILTER) Switch

This button selects the bandwidth of the receiver first IF Roofing Filter. Available selections are 3 kHz, 6 kHz, 15 kHz, or Auto.

The selected bandwidth appears in the R.FLT column of the Block Diagram Display on the TFT display.

### ADVICE:

The “AUTO” selection mode selects the optimum bandwidth of the Roofing filter for the reception mode. In this case, the selected bandwidth in the R.FLT column of the Block Diagram Display

play glows yellow (The unselected choices glow Blue).

Because the roofing filter is in the first IF, the protection it provides against interference is quite significant. When set to AUTO, SSB, CW, RTTY and DATA, the bandwidth is 3 kHz while AM and FM is 15 kHz.

## ⑩ [NB] Switch

This button turns the IF Noise Blanker on and off.

Press this button momentarily to reduce short-duration pulse noise.

Available selections are ON, OFF, or NBW ON. The attenuation level appears in the ATT column of the Block Diagram Display on the display.

## ⑪ [AGC] Switch

This button selects the AGC characteristics for the receiver. Available selections are FAST, MID, SLOW and OFF, or AUTO. The selected AGC characteristics appear in the AGC column of the Block Diagram Display on the TFT display.

Press the [AGC] button repeatedly to select the desired receiver-recovery time constant. Press and hold in the [AGC] button for one second to disable the AGC (for testing or weak-signal reception).

### ADVICE:

The “AUTO” selection mode selects the characteristics of the AGC for the reception mode. The selected AGC characteristics will glow green in the AGC column of the Block Diagram Display, (unselected characteristics glow Blue).

The Attenuator may be used in conjunction with the [IPO] button to provide two stages of signal reduction when an extremely strong signal is being received.

If the AGC receiver-recovery time is set to “Off” by pressing and holding in the [AGC] button, the S-meter will no longer deflect. Additionally, you will likely encounter distortion on stronger signals, as the IF amplifiers and the following stages are probably being overloaded.

## ⑫ [MOX] Switch

Pressing this button engages the PTT (Push to Talk) circuit to activate the transmitter (the LED inside this button will glow red and the “MOX” icon will appear in the display). It must be turned off (the red LED will be off) for reception. This button replicates the action of the Push to Talk (PTT) switch on the microphone. When engaging the [MOX] button, or otherwise causing a transmission to be started, be certain you have either an antenna or 50-Ohm dummy load connected to the selected Antenna jack.

# FRONT PANEL CONTROLS & SWITCHES

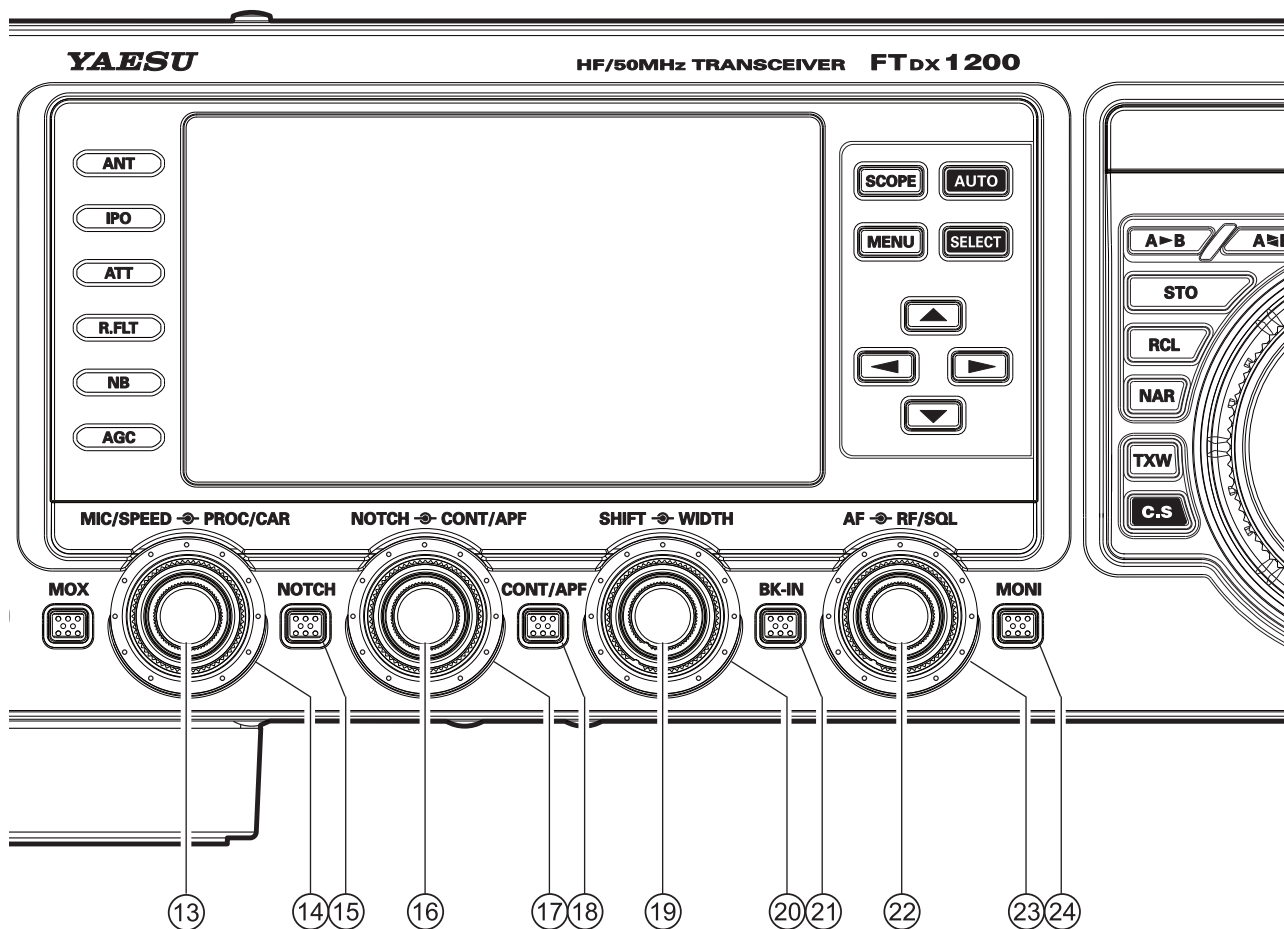

## ⑬ [MIC/SPEED] Knob

### MIC

This knob adjusts the microphone input level for (non-processed) SSB transmission.

The display will show the relative microphone gain level for 3 seconds whenever this knob is turned.

### ADVICE:

Adjust the [MIC/SPEED] knob while speaking in a somewhat louder than normal voice level, watch the ALC level and adjust the [MIC/SPEED] knob so that the ALC level indication just reaches the right edge of the ALC scale. Then, when you speak in your normal voice level, you will not be over-driving the microphone amplifier stages.

### SPEED

This knob adjusts the keying speed of the internal CW keyer (4 ~ 60 WPM). Clockwise rotation increases the sending speed.

The display will show the keying speed for 3 seconds whenever this knob is turned.

## ⑭ [PROC/CAR] Knob

### PROC

This knob adjusts the compression (input) level of the transmitter RF speech processor in the SSB mode.

### CAR

This knob adjusts the RF Power (Carrier) output of the transceiver. For the SSB mode, set the desired maximum RF Power output via Menu item "176 TX MAX POWER" (see page 63).

### IMPORTANT NOTE:

The setting value of Menu item "176 TX MAX POWER" is applied to all emission modes.

**For example:** When Menu item "176 TX MAX POWER" is set to "50", the maximum RF Power output for all emission modes is "50", even if the [PROC/CAR] knob is set to the fully clockwise position.

### ADVICE:

The RF Power output setting will be shown for 3 seconds in the right of the TFT display whenever the outer [PROC/CAR] knob is turned, except when MENU "176 TX MAX POWER" is set to 5 watts.

In the SSB mode the [PROC] value will be shown instead of the RF Power output.

# FRONT PANEL CONTROLS & SWITCHES

## ⑮ [NOTCH] Switch

Pressing this button allows you to adjust the center frequency of the IF Notch filter using the [NOTCH] knob. While activated, the LED inside this button glows orange. Press the [NOTCH] knob briefly to toggle the IF Notch filter on/off.

## ⑯ [NOTCH] Knob

Press the [NOTCH] switch to turn the IF NOTCH filter on or off. Rotate the inner [NOTCH] knob to adjust the center frequency of the IF NOTCH filter. The null position of the IF NOTCH filter can be observed on the display. Furthermore, the display will show the center frequency of the IF NOTCH filter for 3 seconds whenever the [NOTCH] knob is turned.

## ⑰ [CONT/APF] Knob

### CONT

In the SSB, AM, and FM modes, press the [CONT/APF] switch then turn the outer [CONT/APF] knob to select the desired CONTOUR filter response. The CONTOUR filter is engaged via the [CONT/APF] switch.

### APF

In the CW mode, press the [CONT/APF] switch and then turn the outer [CONT/APF] knob to select the desired APF (Audio Peak Filter) response. The APF is engaged via the [CONT/APF] switch.

## ⑱ [CONT/APF] Switch

Pressing this button allows you to select the DSP Contour filter response using the [CONT/APF] knob. While activated, the LED inside this button glows orange. Press the [CONT/APF] knob briefly to toggle the IF Contour filter on/off.

In the CW mode, pressing this button will activate the APF (Audio Peak Filter) which provides a very narrow audio bandwidth. While activated, the LED inside this button glows orange.

## ⑲ [SHIFT Knob] (EXCEPT ON AM AND FM MODE)

Rotate the inner [SHIFT] to move the passband of the IF DSP filter by 20 Hz steps. The total adjustment range is  $\pm 1$  kHz. The position of the passband can be observed on the display. Furthermore, the display will show the shift value of the IF SHIFT for 3 seconds whenever the [SHIFT] knob is turned.

## ⑳ [WIDTH Knob] (EXCEPT ON AM AND FM MODE)

Rotate the outer [WIDTH] knob to set the overall bandwidth of the IF DSP filter. Counter-clockwise rotation reduces the bandwidth, while clockwise rotation increases the bandwidth. The current bandwidth can be observed on the display. Furthermore, the frequency display will show the bandwidth of the IF passband for 3 seconds whenever the [WIDTH] knob is turned.

## ㉑ [BK-IN] Switch

This button turns the CW break-in capability on and off. While CW break-in is activated, the LED inside this button glows orange.

## ㉒ [AF] Knob

The inner [AF] knob sets the receiver audio volume level. Typically, you will operate with this control set between the 9 o'clock and 10 o'clock positions.

## ㉓ [RF/SQL] Knob

### ADVICE:

This control may be used to select between the "SQL" and "RF GAIN" functions via the Menu Item "037 RF/SQL VR".

### RF

The outer [RF/SQL] knob is the receiver RF gain control, which adjusts the gain of the receiver RF and IF amplifier stages. This control is normally left in the fully clockwise position.

### SQL

This knob sets the signal level threshold, below which the receiver audio is muted, in all modes. It is very useful during local rag-chews, to eliminate noise between incoming transmissions. This control is normally kept fully counter-clockwise (off), except when scanning and during FM operation.

## ㉔ [MONI] (Monitor) Switch

This button enables the transmit monitor in all modes. While activated, the LED inside this button glows orange.

### ADVICE:

When using headphones, the Monitor function is very helpful while adjusting the Parametric Equalizer or other voice quality adjustments. The voice heard in the headphones represents the transmitted audio qualities.

# FRONT PANEL CONTROLS & SWITCHES

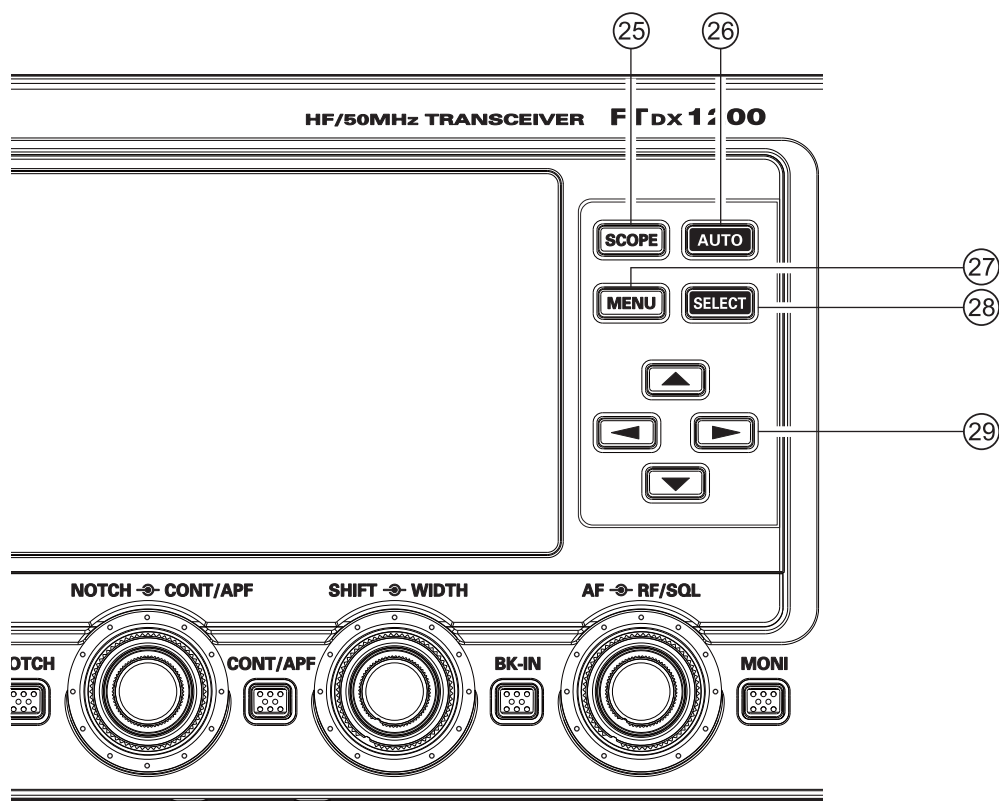

## ②⑤ [SCOPE] Switch

Press this button momentarily to switch between the MENU, the Scope, the Scope + AF-FFT, and the Scope Memory (when there is memory) screens. Press and hold this button for more than one second to operate the decode function (when operating CW, RTTY, PSK).

## ②⑥ [AUTO] Switch

Press this button to operate the scope function and initiate continuous sweeping.

## ②⑦ [MENU] Switch

This button is used to access the Menu system. The various transceiver characteristics may be configured. Menu operation is described in detail, in this manual.

### **IMPORTANT NOTE:**

Pressing the [MENU] button will activate the Menu, and the Menu items will appear on the display. Once you have changed the parameters, you must press the [MENU] button to save any configuration changes.

## ②⑧ [SELECT] Switch

This button is used to select the Menu system.

## ②⑨ [◀▶▶▶] Switch

These buttons permit selection of the Menu items and settings.

# FRONT PANEL CONTROLS & SWITCHES

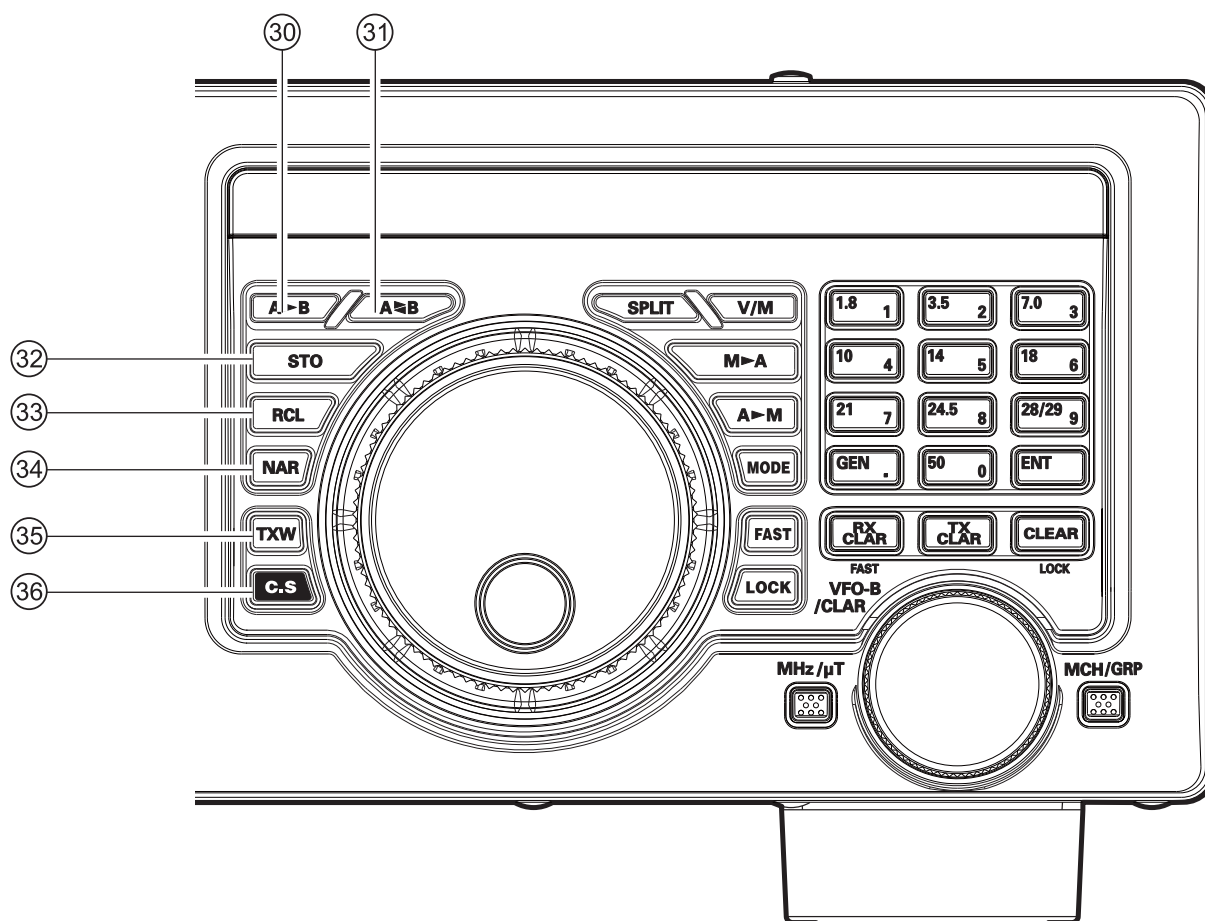

## ③① [A►B] Switch

Press this button momentarily to transfer the frequency or memory channel data, from VFO-A to VFO-B, overwriting any previous contents in VFO-B. Use this key to set both VFO-A and VFO-B to the same frequency and mode.

## ③② [A◄B] Switch

Pressing this button momentarily, exchanges the frequency or memory channel data, of VFO-A and VFO-B.

## ③③ [STO] (Store) Button

Pressing the [STO] button copies the contents (frequency, mode, bandwidth, FM repeater offset, and CTCSS settings) of VFO-A, into consecutive QMB Memories.

## ③④ [RCL] (Recall) Button

Pressing the [RCL] button, recalls one of up to five Quick Memory Bank memories for operation.

## ③⑤ [NAR] (Narrow) Switch

This button is used to set the DSP (digital) IF filters to Narrow bandwidth.

### **ADVICE:**

You may adjust the bandwidth using the [WIDTH] knob.

*In the AM mode*, this button is used to toggle the receiver bandwidth between wide (9 kHz) and narrow (6 kHz).

*In the FM mode* on the 28 MHz and 50 MHz bands, this button is used to toggle the FM deviation/bandwidth between wide ( $\pm 5.0$  kHz Dev./25.0 kHz BW) and narrow ( $\pm 2.5$  kHz Dev./12.5 kHz BW).

## ③⑥ [TXW] (TX Watch) Switch

Pressing and holding this button lets you monitor the transmit frequency when split frequency operation is engaged. Release the button to return to normal split frequency operation.

## ③⑦ [C.S] Switch

Press this button momentarily to directly recall a favorite Menu Selection.

To program a Menu selection to the [C.S] button, press the [MENU] button to enter the Menu. Select the Menu item you want to set as the short cut. Press the [C.S] button, then press the [MENU] button; this will lock in the selected Menu item as the short cut.



# FRONT PANEL CONTROLS & SWITCHES

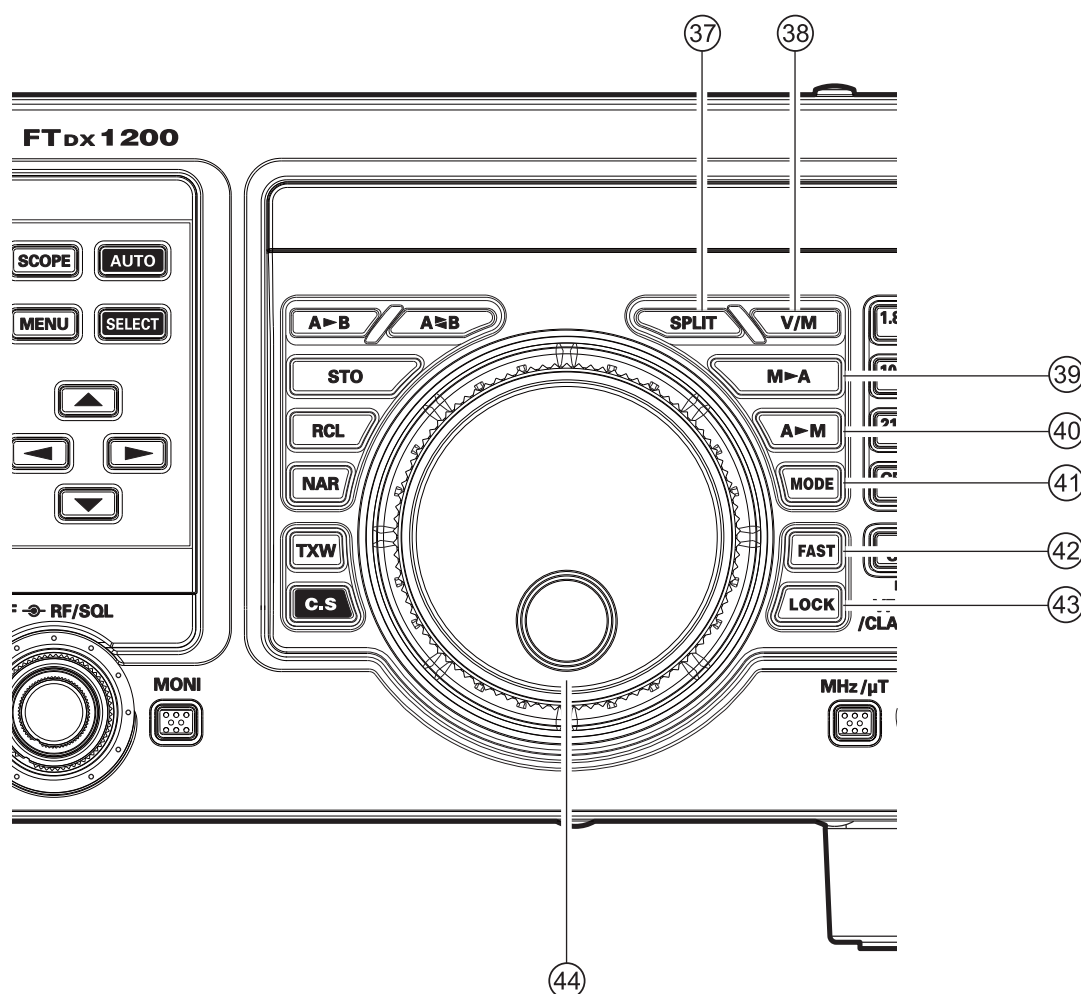

## ③⑦ [SPLIT] Switch

Press this button to operate split frequency between VFO-A (used for reception) and VFO-B (used for transmission). If you press and hold in the [SPLIT] button for one second, the “Quick Split” feature will be engaged. VFO-B transmit will automatically be set to a frequency 5 kHz higher than the VFO-A receive frequency, with the same operating mode. The transceiver will operate in the Split mode.

## ③⑧ [V/M] Switch

This button toggles frequency control between VFO-A and the memory system. In memory mode, “MCH” (Memory Channel) will be shown in the Display to indicate the current selection. Pressing the [V/M] button displays the original memory frequency, and the “MCH” icon will be displayed. Pressing it once more returns frequency operation to VFO-A, and the icon will no longer be displayed.

## ③⑨ [M>A] Switch

Pressing this button momentarily, will display the contents of the currently-selected memory channel for 10 seconds.

Holding [M>A] button in for one second copies the data from the selected memory to VFO-A, and two beeps sound. Previous data in VFO-A will be overwritten.

## ④⑩ [A>M] Switch

Pressing this button momentarily, displays the contents of the currently-selected memory channel for 10 seconds.

Pressing and holding in this key for one second (until the double beep) copies the current operating data into the currently selected memory channel, overwriting any previous data stored there.

# FRONT PANEL CONTROLS & SWITCHES

## ④① [MODE] Switch

This button selects the operating mode. The selections available are:

LSB → CW (USB) → RTTY (LSB) →  
→ DATA (LSB) → AM → LSB →

Repeated presses of this button steps through the available selections.

Pressing and holding this button will toggle to the alternate mode.

For example, *In the LSB or USB modes*, a long press of this button toggles between “LSB” and “USB” mode.

## ④② [FAST] Switch

Pressing this button will change the tuning of the Main Tuning Dial knob (VFO-A) to a higher step rate.

When this function is activated, “FAST” appears in the frequency display.

## ④③ [LOCK] Switch

This button toggles locking on/off for the Main Tuning Dial knob (VFO-A). With “Lock” on, the Main Tuning Dial knob can still be turned, but the frequency will not change, and the “LOCK” appears in the frequency display.

## ④④ Main Tuning Dial Knob

This large knob adjusts the operating frequency of VFO-A. Clockwise rotation of this knob increases the frequency. Default tuning increments are 10 Hz (CW, SSB), 50 Hz (RTTY/DATA), 100 Hz (AM/FM). When the [FAST] button is pressed, the tuning steps increases. The available steps are:

OPERATING MODE	1 STEP	1 DIAL ROTATION
LSB/USB/CW	10 Hz (100 Hz)	10 kHz (100 kHz)
AM/FM	100 Hz (1 kHz)	100 kHz (1 MHz)
RTTY/DATA	5 Hz (100 Hz)	5 kHz (100 kHz)

Numbers in parentheses indicate steps when the [FAST] button is On.

### ADVICE:

The tuning steps for the Main Tuning Dial knob are set, at the factory, to: 10 Hz (SSB, CW), 50 Hz (RTTY/DATA) and 100 Hz (AM/FM) per step. Via Menu item “150 CW DIAL STEP” to “154 SSB DIAL STEP”, however, you may change these settings to 1 or 5 Hz (SSB, CW), 1 or 10 Hz (RTTY, DATA), and 10 Hz (AM, FM) instead.

# FRONT PANEL CONTROLS & SWITCHES

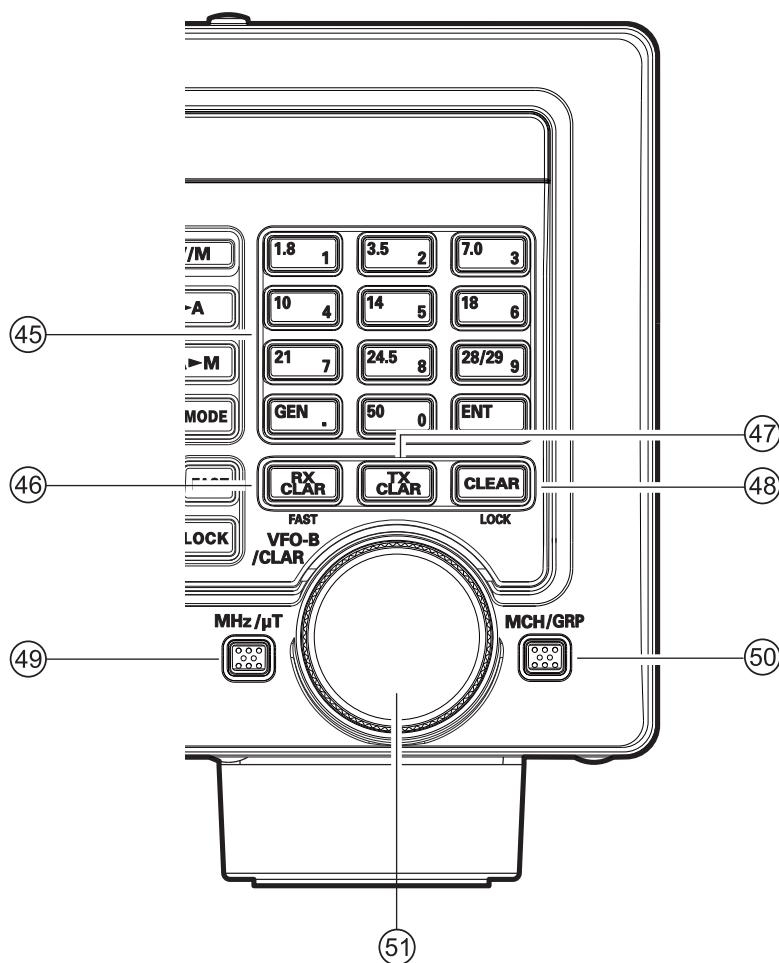

## ④⑤ [BAND] Keys

These keys allow one-touch selection of the desired Amateur band (1.8 ~ 50 MHz).

The keys may also be used for direct entry of a desired operating frequency during VFO operation.

## ④⑥ [RX CLAR] Switch

Pressing this button activates the RX Clarifier. This will allow you to temporarily adjust the receive frequency up to  $\pm 9.995$  kHz with the [VFO-B/CLAR] knob. Press this button once more to return the receiver to the original frequency; the Clarifier offset will be remembered, in case you want to use it again. To cancel the Clarifier offset, press the [CLEAR] button.

Pressing this switch during the VFO-B operation will change the tuning rate of the [VFO-B/CLAR] knob (VFO-B) to 100 Hz/step.

When this function is activated, "FAST" appears in the TFT display.

## ④⑦ [TX CLAR] Switch

Pressing this button activates the TX Clarifier, to allow offsetting the transmit frequency temporarily. Press this button once more to return the transmitter to the original frequency; the Clarifier offset will be remembered, though, in case you want to use it again. To cancel the Clarifier offset, press the [CLEAR] button.

## ④⑧ [CLEAR] Switch

Pressing this button clears out any frequency offset you have programmed into the Clarifier register (thereby setting the offset to "Zero").

Pressing this switch during the VFO-B operation toggles locking on/off for the [VFO-B/CLAR] knob (VFO-B). With "Lock" on, the [VFO-B/CLAR] knob can still be turned, but the frequency will not change, and the "LOCK" appears in the display.

# FRONT PANEL CONTROLS & SWITCHES

---

## ④⑨ [MHz/μT] Switch

Pressing this button allows you to tune the VFO frequency down or up in 1 MHz increments, using the [VFO-B/CLAR] knob.

Pressing and holding this switch for one second allows you to adjust the center frequency of the RF μ-Tuning filter passband using the [VFO-B/CLAR] knob, when the optional RF μ-Tuning Kit is connected. While activated, the “μ-Tune” appears in the display. Press and hold in the [MHz/μT] switch for one second to toggle the μ-Tuning function on/off.

## ⑤⑩ [MCH/GRP] Switch

### MCH

Pressing this button allows you to select a memory channel using the [VFO-B/CLAR] knob.

### GRP

Pressing this button allows you to select a memory group by turning the [VFO-B/CLAR] knob.

## ⑤① [VFO-B/CLAR] Knob

During the VFO-A operation, this knob tunes the Clarifier offset frequency up to ±9.995 kHz.

During the VFO-B operation, this knob adjusts the operating frequency of VFO-B.

# DISPLAY INDICATIONS



## ① Main (VFO-A) Frequency Display

### ② S/PO

On receive, this indicates the received signal strength from S-0 to S-9+60dB.

On transmit, it indicates the RF Power Output, from 0 to 150 Watts.

#### ADVICE:

The S and PO meter types can be changed to ANALOG or BAR type via Menu item "011 METER TYPE SELECT".

The S and PO meters can be set to the Peak-hold function (BAR type only) via Menu item "012 BAR MTR PEAK HOLD".

## ③ Key Function Display

### ANT (1, 2):

Indicates which antenna is selected by the front panel [ANT] button.

### IPO (AMP1, AMP2, IPO):

Indicates which front end RF amplifier is selected by the front panel [IPO] button.

### ATT (OFF, -6 dB, -12 dB, -18 dB):

Indicates the attenuation level, selected by the front panel [ATT] button.

### R.FLT (300 Hz\*, 600 Hz, 3 kHz, 6 kHz, 15 kHz):

Indicates the receiver IF Roofing Filter that is selected by the front panel [R.FLT] button.

\*: Requires optional XF-127CN CW Narrow Filter.

### NB (OFF, ON, ON [NBW]):

Indicates the receiver's "short-duration" Noise Blanker setting, which is selected by the front panel [NB] button.

### AGC (SLOW, FAST, MID):

Indicates the AGC decay time setting, which is selected by the front panel [AGC] switch.

## ④ [VOX] (see page 72)

This is the ON or OFF indicator for the automatic voice-actuated transmitter switching in the SSB, AM, and FM modes. The controls affecting VOX operation are the Menu items "180 VOX GAIN", "181 VOX DELAY", and "182 ANTI VOX GAIN". By proper adjustment of these controls, hands-free voice-actuated operation is possible.

## ⑤ [METER]

This indicator determines the function of the meter during transmission.

Press the [▲/▼/◀/▶] buttons to select the "METER" indicator, then press the [SELECT] button to select meter function in the transmit mode as follows:

PO → ALC → SWR → COMP →  
→ ID → VDD → PO .....

PO: Indicates the RF Power Output, from 0 to 150 Watts on transmit.

ALC: Indicates the relative ALC voltage.

SWR: Indicates the Standing Wave Ratio (Forward/Reflected).

COMP: Indicates the speech compressor level (SSB mode only).

ID: Indicates the final amplifier drain current.

VDD: Indicates the final amplifier drain voltage.

**⑥ [PROC] (Processor) (see page 68)**

This indicator enables the Speech Processor for SSB transmission. Adjustment of the Processor level is accomplished via the **[PROC/CAR]** knob.

**ADVICE:**

- The Speech Processor is a tool for increasing the average power output through a compression technique. However, if the Processor level is advanced too far, the increase in compression becomes counter-productive, as intelligibility will suffer. We recommend that you monitor the sound of your signal using the Monitor (with headphones).

**⑦ [DNR] (see page 57)**

This indicator turns the Main band (VFO-A) receiver's Digital Noise Reduction circuit on and off. Adjustment of the Noise Reduction level is accomplished via the Menu item "109 DNR LEVEL".

**⑧ [MIC EQ] (see page 66)**

This indicator enables the Three-Band-Parametric Microphone Equalizer. The Equalizer settings are activated via the Menu.

**⑨ [DNF] (see page 57)**

This indicator turns the Main band (VFO-A) receiver's Digital Notch Filter on and off. This is an automatic circuit, and there is no adjustment knob for the DNF.

**⑩ [KEYER] (see page 77)**

This indicator toggles the internal CW keyer on and off. The Keyer sending speed is adjusted via the front panel's **[MIC/SPEED]** knob and the CW Hang Time is adjusted via the Menu item "062 CW BK-IN DELAY".

**⑪ [ZIN/SPOT] (see page 81)**

This indicator enables the CW receiver spotting tone. By matching the SPOT tone to that of the incoming CW signal (precisely the same pitch), you will be "zero beating" your transmitted signal with the frequency of the other station.

**⑫ CLOCK**

Indicates the current time.

To set the clock:

1. Press and hold the **[C.S]** button until the flashing clock digits appear on the display.
2. Enter the present time via the number keys (band keys).
3. Press the **[ENT]** button.
4. Setup of the clock is now complete.

**⑬ DSP Display**

This indicator is used for viewing the status of the DSP (CONTOUR, NOTCH, WIDTH and SHIFT).

**⑭ Sub (VFO-B) Frequency Display**

This is the Sub band (VFO-B) frequency display.

**ADVICE:**

- When turning the **[CLAR]**, **[MIC/SPEED]**, **[PROC/CAR]**, **[NOTCH]**, **[CONT/APF]**, **[SHIFT]**, or **[WIDTH]**, **[MIC]** knob, each frequency or value will appear in this area for 3 seconds.

# DISPLAY INDICATIONS

---

⑮ **[FAST]** Indicator

This indicator appears when the Main Tuning Dial knob's tuning rate is set to "fast".

⑯ **[LOCK]** Indicator

This indicator appears when the Main Tuning Dial knob is locked.

⑰ **Frequency Display**

This is the frequency display.

⑱ **LSB, USB, CW, AM, FM, RTTY, DATA**

Displays the current operating mode.

Press and hold in the **[MODE]** button in the individual operating modes for approx. one second to switch between modes as follows:

LSB ⇔ USB  
CW (LSB) ⇔ CW (USB)  
RTTY (LSB) ⇔ RTTY (USB)  
DATA (LSB) ⇔ DATA (USB)  
AM ⇔ FM

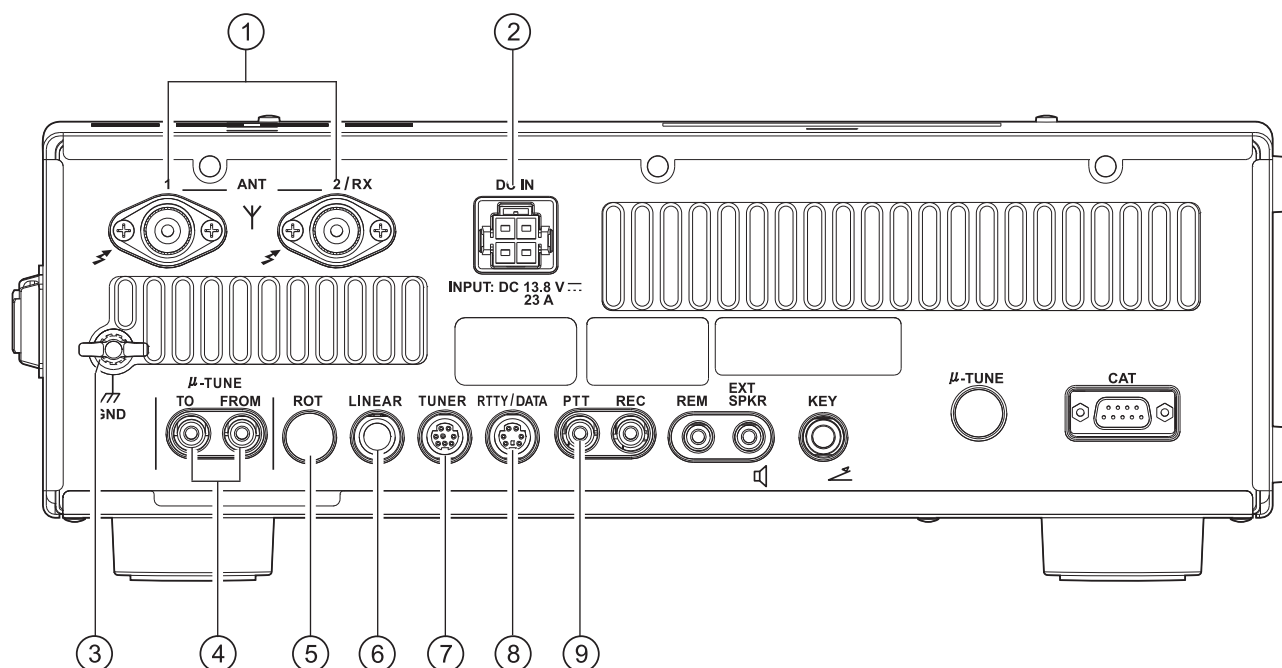

### ① ANT 1/2 Jacks

Connect your main antenna(s) here, using type-M (PL-259) connectors and coaxial feed lines. The internal antenna tuner affects only the antenna(s) connected here, and only during transmission.

#### **⚠ Warning!**

**The 100V RF voltage (@100 W/50 Ω) is applied to the TX RF section of the transceiver while transmitting. Do not touch the TX RF section while transmitting.**

### ② DC IN Jack

This is the DC power supply connection for the transceiver. Use the supplied DC cable to connect directly to a DC power supply, which must be capable of supplying at least 23 A @13.8 VDC.

### ③ GND

Use this terminal to connect the transceiver to a good earth ground, for safety and optimum performance. Use a large diameter, short braided cable for making ground connections, and please refer to page 9 for other notes about proper grounding.



**To prevent the damage from lightning, atmospheric electricity, electrical shock, etc., please provide a good earth ground.**

### ④ μ-TUNE Jacks

These jacks are used to connect the optional RF μTuning Kit, signal in and signal out.

### ⑤ ROT Jack

This covered 6-pin MINI-DIN Jack accepts a cable to connect to a YAESU **G-800DXA/-1000DXA/-2800DXA** Antenna Rotator (listed models are current as of early 2012). You may control the antenna azimuth rotation (and rotation speed) using the Function buttons on the front panel.

### ⑥ LINEAR Jack

This 15-pin output jack provides band selection data, which may be used for control of optional accessories such as the **VL-1000** Solid-state Linear Amplifier.

### ⑦ TUNER Jack

This 8-pin output jack is used for connection to the **FC-40** External Automatic Antenna Tuner.

### ⑧ RTTY/DATA Jack

This 6-pin input/output jack accepts AFSK input from a Terminal Node Controller (TNC) or an optional interface unit; it also provides fixed level (100-mV @600 Ohms) receiver audio output, and FSK keying line.

### ⑨ PTT Jack

This RCA input jack may be used to provide manual transmitter activation using a footswitch or other switching device. Its function is identical to the **[MOX]** button on the front panel. The same line is available at the **RTTY/PKT** jack for TNC control. Open-circuit voltage is +5 VDC, and closed-circuit current is 2 mA.



# REAR PANEL

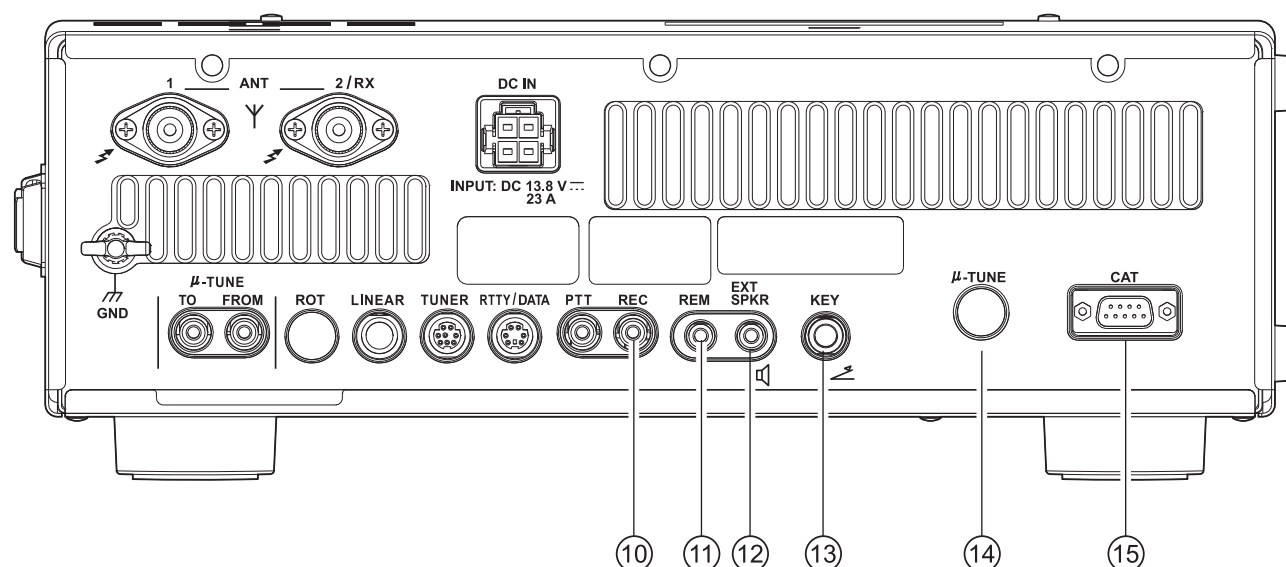

## ⑩ REC Jack

This 3.5-mm, 3-contact jack provides low-level receiver audio output for recording. It also outputs voice audio during transmission if the “MONI” is turned on.

Peak signal level is 300 mVp-p at 10 k-Ohms. The front panel [AF] knobs do not affect the signals at this jack.

## ⑪ REM (REMOTE) Jack

By plugging the optional **FH-2** Remote Control Keypad into this gold-plated jack, direct access to the **FTdx1200** CPU is provided for control functions such as contest memory keying, plus frequency and function control.

## ⑫ EXT SPKR Jack

This 3.5-mm, 2-contact, gold-plated jack provides variable audio output for an external loudspeaker. The audio output impedance at this jack is 4 - 8 Ohms, and the level varies according to the setting of the front panel [AF] knob. Inserting a plug into this jack disables the internal loudspeaker.

## ⑬ KEY Jack

This 1/4-inch 3-contact jack accepts a CW key or keyer paddle. A two-contact plug cannot be used in this jack. Key-up voltage is +3.3 V DC, and key-down current is 0.3 mA. This jack may be configured for keyer, “Bug”, “straight key”, or computer keying interface operation via Menu item “019 R KEYER TYPE”.

## ⑭ μ-TUNE Jack

This covered 10-pin mini-DIN jack is used for control of the optional RF μTuning Kit.

## ⑮ CAT Jack

This 9-pin serial DB-9 jack allows external computer control of the **FTdx1200**. Connect a serial cable here and to the RS-232C COM port on your personal computer (no external interface is required).

# OPTIONAL FH-2 SWITCHES

The optional Remote Control Keypad **FH-2** can be used to control the voice memory capability for the SSB/AM/FM modes, and the contest memory keyer for the CW mode, and the text memory for the RTTY/DATA modes. Some specific capabilities of the **FH-2** are:

- On SSB/AM/FM modes, five channels of storage and playback of voice memory (20 seconds each), using your own voice for recording (see page 70).
- On CW mode, the FH-2 provides storage and recall of CW messages for repetitive CQ and contest automatic number transmissions (see page 84).
- On RTTY/DATA mode, the FH-2 provides storage and recall of TEXT messages for repetitive CQ transmissions (see page 105, 107).

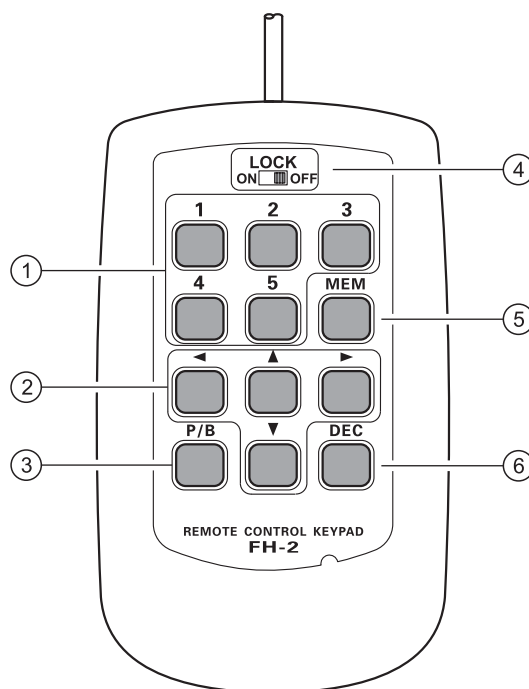

## ① [1], [2], [3], [4], [5] Switches

These buttons work as the Voice Memory and CW Message Memory Selection Key.

In the case of Voice Memory, up to 20 seconds of audio may be stored on each channel.

For CW Messages and CW Text Messages, up to 50 characters ("PARIS" specification) may be stored into each channel.

## ② [◀], [▶], [▲], [▼] Switches

Usually, these buttons are used for tuning the VFO frequency. Press the [▲]/[▼] buttons to change the frequency in the same increments as the microphone [UP]/[DWN] switches. Press the [◀]/[▶] buttons to change the frequency by 100 kHz steps.

When programming the Contest Memory Keyer, these buttons are used to move the cursor and select the text characters.

## ③ [P/B] Switch

This button can be used to insert a space into the position where the cursor is blinking.

## ④ [LOCK] Switch

This button may be used to lock out the FH-2 key buttons, to prevent accidental activation of FH-2 operations.

## ⑤ [MEM] Switch

Press this button to store either a Voice Memory, or a Contest Keyer Memory.

## ⑥ [DEC] Switch

When utilizing the sequential contest number capability of the Contest Keyer, press this button to decrement (decrease) the current Contest Number by one digit (i.e. to back up from #198 to #197, etc.).

# ***BASIC OPERATION: RECEIVING ON AMATEUR BANDS***

---

Before turning on the main power, please verify the following items once more.

- Have you made all ground connections securely? See page 9 for details.
- Do you have your antenna(s) connected to the rear-panel Antenna jack(s)? See page 10 for details.
- Is your microphone (and/or key or paddle) connected? See page 11, 12 for details.
- If using a linear amplifier, have all interconnections been successfully completed? See page 13, 14 for details.
- Please rotate the **[AF]** control to the fully counter-clockwise position, to avoid a loud blast of audio when the transceiver turns on. See page 19 for details.

# BASIC OPERATION: RECEIVING ON AMATEUR BANDS

Here is the typical start-up procedure for normal operation:

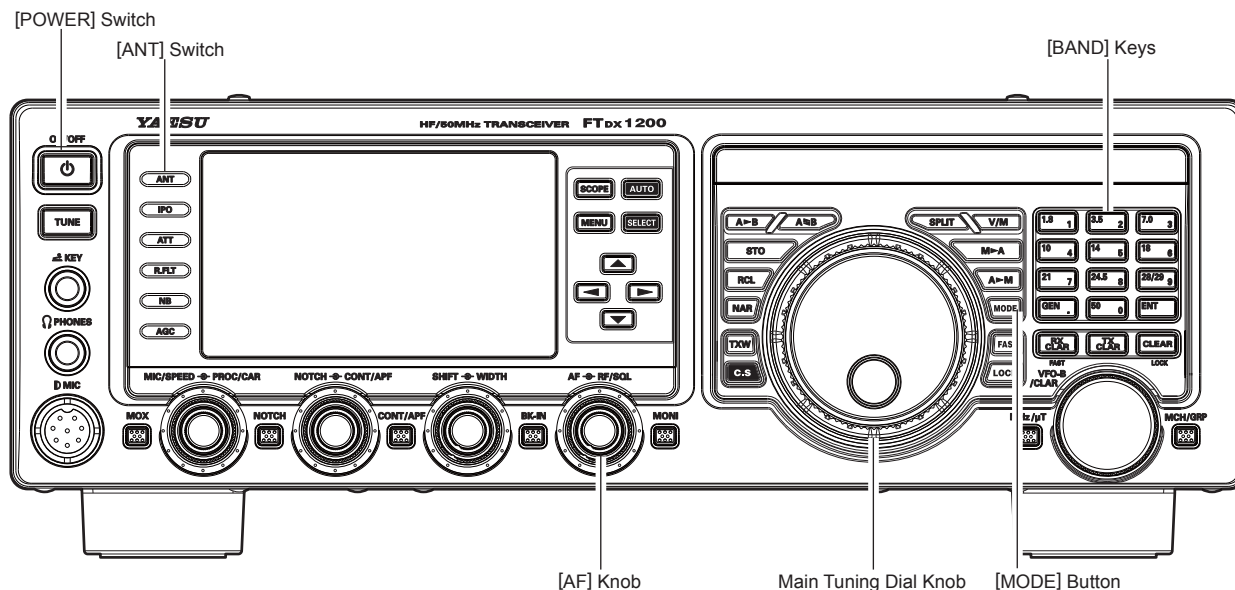

1. Turn on the external DC power supply.
2. Press and hold in the front-panel [ON/OFF] switch until the transceiver turns on. After about five seconds (ten seconds if the optional  $\mu$ -Tuning Kit is connected), the transceiver is ready for full operation.
3. The transceiver will start up on 7.000.000 MHz LSB, (or the previously used operating frequency) and normal operation may begin.



**NOTE:**

To turn power off, press and hold in the front panel [ON/OFF] switch for one second.

4. Rotate the [AF] knob to set a comfortable audio level of the incoming signals or noise. Clockwise rotation of the [AF] knob increases the volume level.

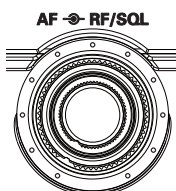

**NOTE:**

When using headphones, start by rotating the [AF] knob counter-clockwise, then bring the volume level up after you put the headphones on. This will minimize the chance of damage to your hearing caused by an unexpectedly high audio level.

5. Press an appropriate [BAND] key corresponding to the Amateur band on which you wish to begin operation.

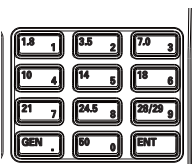

**ADVICE:**

- One-touch selection of each Amateur band between 1.8 and 50 MHz is provided.
- The FTdx1200 utilizes a triple band-stack VFO selection technique, which permits storing up to three favorite frequencies and modes onto each VFO band register. For example, you may store one frequency each on 14 MHz CW, RTTY, and USB, then recall these frequencies by successive,

momentary presses of the [14] MHz band button. Each Amateur band button may similarly have up to three frequency/mode settings applied.

- When the [MHz/ $\mu$ T] button (located to the left of the [CLAR/VFO-B] knob), is pressed, the imbedded LED will glow orange, and then rotation of the [CLAR/VFO-B] knob will change the frequency in 1 MHz steps.

6. Press the [ANT] button to select the appropriate antenna for the band in use.



**ADVICE:**

When you make an antenna selection, that antenna is “remembered” by the microprocessor in conjunction with the VFO register in use.

7. Press the [MODE] button to select the desired operating mode.

Repeated presses of the [MODE] button step through the available selections.

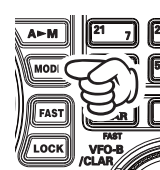

Pressing and holding the [MODE] button will toggle to the alternate mode.

For example, *In the LSB or USB modes*, pressing and holding the [MODE] button toggles between “LSB” and “USB” mode.

**ADVICE:**

- By convention in the Amateur bands, LSB is used on the 7 MHz and lower bands (with the exception of 60 meters), while USB is utilized on the 14 MHz and higher bands.
- When changing modes from SSB to CW, you will observe a frequency shift on the display. This shift represents the BFO offset between the “zero beat” frequency and the audible CW pitch (tone) you can hear (the pitch is programmed via the Menu item “065 CW FREQ DISPLAY”), even