

**YAESU**  
The radio

144 MHz  
FM TRANSCEIVER

**FT-25R**

**FT-25E**

---

Operating Manual

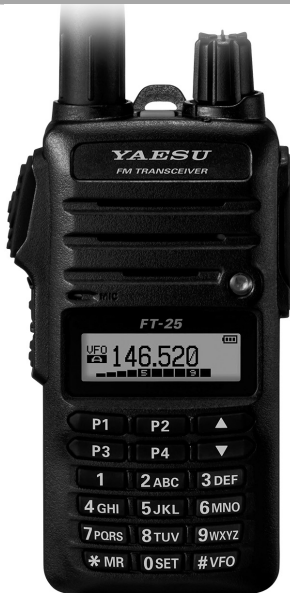

# Contents

<b>General Description</b> .....	1
Features of the FT-25R/E .....	1
About this manual .....	2
Downloading the "Advance Manual" .....	3
<b>Accessories &amp; Options</b> .....	4
Supplied Accessories .....	4
Available Options .....	4
<b>Safety Precautions</b> .....	5
<b>Control &amp; Connections (Top &amp; Front Panel)</b> ...	10
<b>Controls &amp; Connections (Side Panel)</b> .....	11
<b>Controls &amp; Connections (LCD)</b> .....	12
Normal operation display .....	12
The Set Mode and Preference Mode display .....	12
Display of features and settings .....	13
<b>Controls &amp; Connections (Keypad)</b> .....	14
<b>Installation of Accessories</b> .....	15
Antenna Installation .....	15
Preparation of SBR-25LI Battery Pack .....	15
Installing the Battery Pack .....	15
Removing the Battery Pack .....	16
Attaching the Belt Clip .....	16
<b>Charging the Battery Pack</b> .....	17
About Desktop charger lamp .....	17
Low Battery Indication .....	18
About Battery Indicator Icons .....	18
Approximate Operating Time and Remaining Charge Level Indication .....	18
<b>Basic Operation</b> .....	19
Turn the Power ON and OFF .....	19
Adjust the Audio Volume Level and Squelch Setting .....	19
Changing between VFO-A and VFO-B .....	19
Frequency Navigation .....	20
1) Tuning Frequency .....	20
2) Direct Keypad Frequency Entry .....	20
3) Scanning .....	20
Transmission .....	21
Changing the Transmit Power Level .....	21
Activating the Set Mode .....	22
Setting the Quick Recall Keys .....	22
Assigning Set Mode Items to the Quick Recall Keys (Set Mode Recall feature) .....	22
Storing the displayed Frequency and Settings to a Quick Recall Key (Quick Memory feature) .....	23
Setting the Preferred Operating Mode .....	23
<b>Advanced Operation</b> .....	24
Turning the Keylock Feature ON and OFF .....	24
Change the key locking scheme .....	24
Change the LCD and keypad back light setting .....	24
Disabling the Keypad and Scan Stop Beeper .....	25
<b>Repeater Operation</b> .....	26
Repeater Shifts .....	26
Automatic Repeater Shift (ARS) .....	26
Manual Repeater Shift Setting .....	27
Tone Calling (1750 HZ) .....	28
<b>Memory Mode</b> .....	29
Memory Storage .....	30
Memory Recall .....	31
Changing the memory label (tag) name .....	31
HOME Channel Memory Recall .....	32
Changing the Home Channel Frequency .....	32
Memory Offset Tuning .....	32
Deleting Memories .....	33
Weather Broadcast Channels .....	34
Severe Weather Alert .....	34
<b>Scanning</b> .....	35
Setting the Scan-Resume Technique .....	35
VFO Scanning .....	36
Manual VFO Scan .....	36
Programmed Mode (VFO) Scan .....	36
<b>Input Character/Symbol List</b> .....	38
<b>Set (Menu) Mode</b> .....	39
<b>Troubleshooting</b> .....	43
The transceiver does not turn on .....	43
There is no sound .....	43
There is no transmission of radio waves .....	43
The keys or DIAL do not respond .....	43
The battery pack cannot be charged or battery power depletes immediately after charging .....	44
<b>Specifications</b> .....	45
General .....	45
Transmitter .....	45
Receiver .....	46
<b>"AUTO" Mode Preset Operating Parameter</b> .....	46
USA Version .....	46
Asian/European Version .....	46
<b>Note</b> .....	48
<b>Note</b> .....	49

## General Description

### Features of the FT-25R/E





**FT-25R/E** is a FM transceiver, ruggedly constructed to meet commercial specifications. It is packed with the following popular and valuable features demanded by Amateur Radio operators around the world.

- Long-Life Battery
  - Supplied 7.4 V 1950 mAh lithium ion battery.
  - Optional 7.4 V 2500 mAh lithium ion battery.
- 5 Watts of Reliable RF Power
  - RF Power Output 5.0 W (High) / 2.5 W (Middle) / 0.5 W (Low) (@7.4 V)
- Four Quick Recall Keys (User Programmable) for Individual Preferences
  - Set Mode Recall feature and Quick Memory Feature.
- Powerful Audio
  - Bridged Transless (BTL) amplifier provides One Full Watt of Audio for operation in noisy environments.
- Rugged Body Construction
  - IP54 Rating and MIL-STD-810-C, D, E certified.
- Lockout Capabilities
  - Keypad/PTT Lockout.
- Emergency Features
  - Emergency Operation (Alarm, SOS Flash and HOME channel display), LED Flash light equipped.
- FM Radio Broadcast Receiver Feature

## General Description

### About this manual

This manual contains symbols and conventions to call attention to important information.

Symbols	Description
	This icon indicates cautions and alerts the user should be aware of.
	This icon indicates helpful notes, tips and information.
	This icon indicates other pages containing relevant information.
	This icon refers users to the <b>FT-25R/E</b> Advance Manual on the YAESU Website containing relevant information.

- The settings of the transceiver at the time of purchase are referred to as the “default” or “default setting”.
- The names of Set Mode items that are displayed on the LCD, and the transceiver key names, are printed in bold characters in this manual.

## General Description

### Downloading the “Advance Manual”

The Advance Manual provides detail information and features beyond the scope and descriptions in this manual. Download the **FT-25R/E** Advance Manual from the YAESU website and refer to it along with this Operating Manual.

<http://www.yaesu.com/>

The features described in the **FT-25R/E** Advance Manual are below.

RF Squelch	Emergency Channel Operation
Checking the Battery Voltage	ARTS™ (Automatic Range Transponder System)
VOX Operation (with earpiece microphone or External Mic)	Basic ARTS™ Setup and Operation
VFO Split Mode	DTMF Operation
Using the Squelch Feature	Miscellaneous Settings
Selecting the Squelch Type	Password
Setting CTCSS Tone frequency	Changing the Channel Steps
Setting DCS CODE number	TX Battery Saver
CTCSS/DCS/PAGER/ARTS™ Bell Operation	Disabling the TX/BUSY LED Indicator
EPCS (Enhanced Paging & Code Squelch)	Automatic Power-Off (APO) Feature
Memory Bank Operation	Transmitter Time-Out Timer (TOT)
Memory Only Mode	Busy Channel Lock-Out (BCLO)
Scanning	Changing the TX deviation Level
Memory scanning	Voice Compander Feature
Weather Alert Scan	Inversion Scramble (Asian version only)
Programmable (Band Limit) Memory Scan (PMS)	Cloning
“Priority Channel” Scanning	Set (Menu) Mode
Automatic Lamp Illumination on Scan Stop	

## Accessories & Options

### Supplied Accessories

- SBR-25LI            7.4V, 1,950 mAh  
Rechargeable Li-Ion Battery Pack
- SAD-20B            AC Adapter (for USA model)
- SAD-20C/U        AC Adapter (for European / Asian model)
- SAD-20G        AC Adapter (for Chinese model)
- SBH-22            Rapid Charger
- SHB-18            Belt Clip
- SRA-15            Antenna
- Operating Manual
- Warranty Card

### Available Options

- SBR-25LI            7.4V, 1,950 mAh  
Rechargeable Li-Ion Battery Pack
- SBR-26LI            7.4V, 2,500 mAh  
Rechargeable Li-Ion Large-Capacity Battery Pack
- SCU-35            Programming cable
- SCU-36            Cloning Cable
- SSM-512B        VOX Earpiece Microphone

*Availability of accessories may vary. Some accessories are supplied as standard for specific local requirements, while others may be unavailable in some regions. This product is designed to perform optimally when used with genuine Yaesu accessories. Yaesu shall not be liable for any damage to this product and/or accidents such as fire, leakage or explosion of a battery pack, etc., caused by the malfunction of non-Yaesu accessories. Consult your Yaesu dealer for details regarding these and any newly-available options. Connection of any non-Yaesu-approved accessory, should it cause damage, may void the Limited Warranty on this apparatus.*

## Safety Precautions

### Be sure to read the safety precautions to use this product safely.

Yaesu is not liable for failures and other problems caused due to misuse or use of this product by you or a third party. Also, Yaesu is not liable for damages caused through use of this product by you or a third party except in the case where ordered to pay for damages under the laws.

### Type and meaning of the marks

---



**DANGER**

Indicates an imminently hazardous situation which, if not avoided, could result in death or serious injury.

---



**WARNING**

Indicates a potentially hazardous situation which, if not avoided, could result in death or serious injury.

---



**CAUTION**

Indicates a potentially hazardous situation which, if not avoided, may result in minor or moderate injury or only property damage.

---

### Type and meaning of symbols

---



Indicates a prohibited action, not to be done in order to use this product safely.

For example,  indicates that the product should not be disassembled.

---



Indicates a required action, to be done in order to use this product safely.

For example,  indicates that the power plug should be removed.

---

## Safety Precautions



## DANGER

**Do not use this product in "an area where use of it is prohibited", e.g., inside the hospital, airplane, or train."**

This product can affect electronic or medical devices.

**Do not use this product while riding a bicycle or driving a car. Accidents can result.**

Be sure to stop the bicycle or car at a safe place before using this product.

**Do not perform transmission in a crowded place for the safety of persons using a medical device such as a cardiac pacemaker.**

The radio wave emitted from this product can cause the medical device to malfunction and result in an accident.

**Do not touch any material leaking from the battery pack with bare hands.**

The chemical that has stuck to your skin or entered your eye can cause chemical burns. In such a case, consult the doctor immediately.

Those who are carrying a medical device such as a cardiac pacemaker should not perform transmission near the device. **When transmitting, use an external antenna and keep as far as possible away from the external antenna.**

The radio wave emitted by the transmitter can cause the medical device to malfunction and result in an accident.

**Do not use this product or the battery charger in a place where inflammable gas is generated.**

A fire or explosion can occur.

**Do not solder or short-circuit the terminal of the battery pack.**

A fire, leak, overheating, explosion, or ignition can result.

Do not carry the battery pack together with a necklace, hair pin, or small metal objects.

A short circuit can result.

**If it starts thundering when the external antenna is used, immediately turn off this product and disconnect the external antenna from it.**

A fire, electrical shock, or damage may result.





## Safety Precautions





### WARNING

 **Do not power this transceiver with a voltage other than the specified power supply voltage.**  
A fire, electric shock, or damage may result.

 **Do not use the battery pack for any model other than the specified transceiver.**  
A fire, leak, overheating, explosion, or ignition can result.

 **Do not make very long transmissions.**  
The main body of the transceiver may overheat, resulting in a failure or burns.

 **Do not disassemble or make any alteration to this product.**  
An injury, electric shock, or failure can result.

 **Keep the terminals of the battery pack clean.**  
If terminal contacts are dirty or corroded, a fire, leak, overheating, explosion, or ignition can result.

 **Do not handle the battery pack or charger with wet hands. Do not insert or remove the power plug with wet hands.**  
An injury, leak, fire, or failure can result.

 **If smoke or strange odor is emitted from the main body, battery pack, or battery charger, immediately turn the transceiver off; remove the battery pack, and remove the power plug from the outlet.**

A fire, leak, overheating, damage, ignition, or failure can result. Contact the dealer from which you purchased this product or Yaesu Amateur Customer Support.

 **Do not use the battery pack which is externally damaged or deformed.**  
A fire, leak, heating, explosion, or ignition can result.

 **Do not use any battery charger which is not specified by Yaesu.**  
A fire or failure can result.















 **When transmitting, keep the transceiver at least 5.0 mm (3/16 inch) away from your body. Use only the supplied antenna. Do not use modified or damaged antennas.**

 **If charging of the battery pack cannot be completed within the specified charging time, immediately remove the power plug of the battery charger from the outlet.**  
A fire, leak, overheating, explosion, or ignition can result.

## Safety Precautions



### CAUTION

- 
-  **Do not dangle or throw this product by holding its antenna.** This product can hit and injure someone.  
In addition, doing so can result in a transceiver failure or damage.
- 
-  **Do not use transceiver in a crowded place.** The antenna can hit someone, resulting in a injury.
- 
-  **Do not place this transceiver in a place subject to direct sunlight or near a heater.** The transceiver can deform or discolor.
- 
-  **Do not place this transceiver in a humid or dusty place.** A fire or failure can result.
- 
-  **During transmission, keep the antenna as far from you as possible.** Long-time exposure to electromagnetic waves can have a negative impact on your health.
- 
-  **Do not clean the case with thinner or benzene.** Use a soft, dry cloth to clean the case.
- 
-  **If the transceiver is not being used for an extended period, turn it off and remove the battery pack for safety.**
- 
-  **Do not drop, strike, or throw the transceiver.** A failure or damage may result.
- 
-  **Keep magnetic cards and video tape away from the transceiver.** The data recorded on cash cards or video tape can be erased.
- 
-  **Charge the battery pack within the temperature range from +5 °C to +35 °C (+41 °F to +95 °F).** Charging the battery pack outside this temperature range can cause leak, overheating, decrease in performance, or reduction in service life can result.
- 
-  **When unplugging the power cord of the battery charger, be sure to hold the power plug.** Pulling the power cord can damage it and cause a fire or electronic shock.
- 
-  **Do not use the earpiece microphone, earphones, or headphones at an extremely high volume level.** Hearing impairment can result.
- 
-  **Keep this product out of reach of children.** An injury, etc. can result.
- 
-  **Install the hand strap and belt clip securely.** If they are installed improperly, the FT- 25R/E may fall or drop, resulting in an injury or damage.
-

## Safety Precautions



### CAUTION



**Do not place a heavy object on the power cord of the battery charger.**

The battery cord can be damaged, resulting in a fire or electric shock.



**When the battery charger is not in use, remove its power plug from the outlet.**



**Do not use the included battery charger to charge any battery pack which is not specified for use with the charger.**

A fire can result.



**Before discarding the worn battery pack, affix tape or the like to its terminals.**



**Do not operate the transmitter near the TV or radio.**

Radio disturbance can occur in the transceiver, the TV, or the radio.



**Before using this transceiver in a hybrid or fuel-saving car, be sure to check with the automobile manufacturer regarding use of the transceiver in that car.**

Noise generated by an onboard electrical device (inverter, etc.) can disrupt the normal operation of the transceiver.



**Do not use any products other than the specified options and accessories.**

A failure can result.

## Control & Connections (Top & Front Panel)

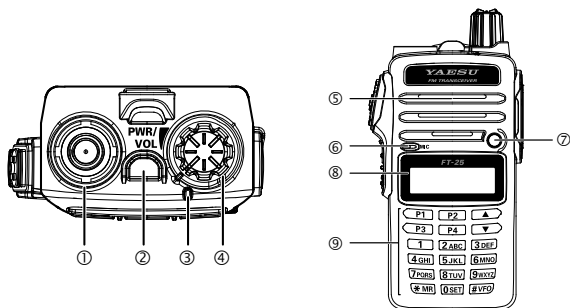

- ① **Antenna Jack** ..... 15  
 Connect the supplied SMA female antenna (or another antenna presenting a 50-Ohm impedance) here.
- ② **Emergency key**
- Press this switch briefly to turn the LED Flash-Light.
  - Press and hold it for three seconds to enable the Emergency Alarm beep functions.
  - Press the keypad F key, and then press this switch to blink the LED Flash-Light for SOS.
- ③ **TX/BUSY Indicator Lamp**..... 19  
 This indicator glows green when the squelch opens, and it glows red during transmit.
- ④ **PWR/VOL Knob**..... 19  
 Turn this control clockwise to turn the transceiver ON and to increase the volume. Counter-clockwise rotation into the click-stop will turn the transceiver OFF.
- ⑤ **Speaker** ..... 19  
 The internal speaker is located here.
- ⑥ **Microphone**..... 21  
 The internal microphone is located here.
- ⑦ **LED Flash-Light**
- ⑧ **LCD (Liquid Crystal Display)** ..... 12  
 The display shows current operating condition.
- ⑨ **Keypad** ..... 14  
 These 18 keys select the important operating functions of the FT-25R/E.