

YAESU
The radio

FTM-3207DR/DE

Operating Manual

UHF AMS TRANSCEIVER
C4FM/FM

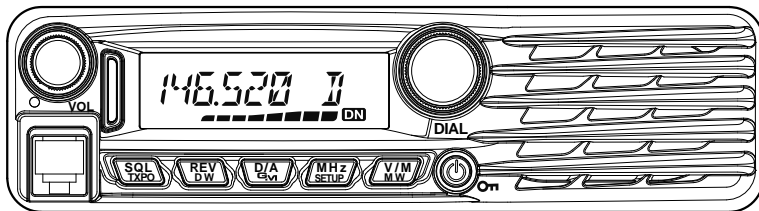

Contents

Safety Precautions (Be Sure to Read)	3	DCS Search.....	28
FTM-3207DR/DE Quick Reference Guide	5	EPCS (Enhanced Paging & Code Squelch) Operation.....	28
Introduction	6	Split Tone Operation	28
Features of this radio.....	6	DTMF Operation.....	28
Accessories & Options	7	Memory Operation	29
Supplied Accessories	7	Memory Storage.....	29
Optional Accessories	7	Split Memory.....	29
Installation	8	Naming a Memory Channel.....	29
Connecting the Microphone.....	8	Memory Recall.....	30
Connecting the Antenna	8	Memory Recall from the Microphone Keypad.....	30
Mobile Installation.....	9	Moving Memory Data to the VFO	30
Power connection	10	Memory Only Mode	30
Base Station Installation	11	Masking Memories	31
AC Power Supplies.....	11	Unmasking Memories.....	31
Front Panel Controls & Switches	12	HOME Channel Memory	31
Front Panel.....	12	Changing the frequency of the home channel....	31
Microphone Switches	14	Scanning	32
Microphone (MH-48A6JA)	14	Basic Scanner Operation.....	32
[P1] button (SQL OFF).....	14	Scan Resume Options.....	32
[P2] button (HOME)	14	Memory Skip Scanning.....	32
[P3] button (DIG/ANA)	14	Preferential Memory Scan	32
[P4] button (TX PW/T.CALL).....	14	Programmable Memory Scan (PMS).....	32
Rear Panel Connectors	15	Priority Channel Scanning (Dual Watch)	32
Rear Panel.....	15	GM Function	33
Basic Operation	16	What is the GM (Group Monitor) Function?.....	33
Turning the Transceiver ON and OFF	16	Displaying all the stations using the GM function	33
Inputting the call sign	16	Reset Procedure/Clone	34
Adjusting the Audio Volume Level	16	Reset Procedure.....	34
Adjusting the Squelch Setting.....	16	Microprocessor Resetting.....	34
Frequency Navigation.....	17	Set Mode Resetting	34
Using the Dial	17	Clone	34
Using the MH-48A6JA Microphone.....	17	Miscellaneous Settings	35
Channel Step Selection	17	Programming the Key Assignments	35
Selecting the communication mode.....	18	Keyboard Beeper.....	35
Setting the transmission mode when using the AMS	18	Display Brightness.....	35
function	19	Time-Out-Timer (TOT).....	35
Transmission	20	Automatic Power Off (APO).....	35
Adjusting the transmit power	21	Busy Channel Lock-Out (BCLO)	35
Lock Feature.....	21	TX Deviation Level	35
Using the convenient Digital C4FM feature	22	MIC Gain Setting.....	35
About the Digital Group ID (DG-ID) feature.....	22	Displaying the Supply Voltage	36
Communicating with the DG-ID feature.....	22	Displaying the Temperature.....	36
Setting the transmit and receive DG-ID number to	22	Band Edge Beeper	36
"00" for communicating with all other stations using	22	Setup (Menu) Mode	37
C4FM digital mode.....	22	Maintenance	40
Communicating only with the specific members by	22	Care and maintenance	40
setting the DG-ID number except for "00".....	23	Replacing the fuse	40
About the GM(Group Monitor) feature.....	24	Replacing the fuse of the DC power supply cable..	40
Displaying the information of the other station	24	40
received by GM (Group Monitor) function.....	25	Specifications	41
Advanced Operation	26		
Repeater Operation	26		
Checking the Repeater Uplink (Input) Frequency	26		
Tone Calling (1750 Hz)	26		
CTCSS Operation.....	27		
Tone Search.....	27		
DCS Operation	27		

Safety Precautions (Be Sure to Read)

Be sure to read these important precautions, and use this product safely.

Yaesu is not liable for any failures or problems caused by the use or misuse of this product by the purchaser or any third party. Also, Yaesu is not liable for damages caused through the use of this product by the purchaser or any third party, except in cases where ordered to pay damages under the laws.

Types and meanings of the marks

- DANGER** This mark indicates an imminently hazardous situation, which, if not avoided, could result in death or serious injury.
- WARNING** This mark indicates a potentially hazardous situation, which, if not avoided, could result in death or serious injury.
- CAUTION** This mark indicates a potentially hazardous situation, which, if not avoided, may result in minor or moderate injury or only property damage.

Types and meanings of symbols







- These symbols signify prohibited actions, which must not be done to use this product safely. For example: indicates that the product should not be disassembled.
- These symbols signify required actions, which must be done to use this product safely. For example, indicates that the power plug should be disconnected.





! DANGER

- Do not use the device in "regions or aircrafts and vehicles where its use is prohibited" such as in hospitals and airplanes.**
 This may exert an impact on electronic and medical devices.
- Do not use this product while driving or riding a motorbike. This may result in accidents.**
 Make sure to stop the car in a safe location first before use if the device is going to be used by the driver.
- Do not operate the device when flammable gas is generated.**
 Doing so may result in fire and explosion.
- Never touch the antenna during transmission.**
 This may result in injury, electric shock and equipment failure.
- Do not transmit in crowded places in consideration of people who are fitted with medical devices such as heart pacemakers.**
 Electromagnetic waves from the device may affect the medical device, resulting in accidents caused by malfunctions.
- When an alarm goes off with the external antenna connected, cut off the power supply to this radio immediately and disconnect the external antenna from this radio.**
 If not, this may result in fire, electric shock and equipment failure.
- Do not touch any liquid leaking from the liquid display with your bare hands.**
 There is a risk of chemical burns occurring when the liquid comes into contact with the skin or gets into the eyes. In this case, seek medical treatment immediately.









! WARNING









- Do not use voltages other than the specified power supply voltage.**
 Doing so may result in fire and electric shock.
- Do not transmit continuously for long periods of time.**
 This may cause the temperature of the main body to rise and result in burns and failures due to overheating.
- Do not dismantle or modify the device.**
 This may result in injury, electric shock and equipment failure.
- Do not handle the power plug and connector etc. with wet hands. Also do not plug and unplug the power plug with wet hands.**
 This may result in injury, liquid leak, electric shock and equipment failure.
- When smoke or strange odors are emitted from the radio, turn off the power and disconnect the power cord from the socket.**
 This may result in fire, liquid leak, overheating, damage, ignition and equipment failure. Please contact our company amateur customer support or the retail store where you purchased the device.
- Keep the power plug pins and the surrounding areas clean at all times.**
 This may result in fire, liquid leak, overheating, breakage, ignition etc.
- Disconnect the power cord and connection cables before incorporating items sold separately and replacing the fuse.**
 This may result in fire, electric shock and equipment failure.

-  **Never cut off the fuse holder of the DC power cord.**
This may cause short-circuiting and result in ignition and fire.
-  **Do not use fuses other than those specified.**
Doing so may result in fire and equipment failure.
-  **Do not allow metallic objects such as wires and water to get inside the product.**
This may result in fire, electric shock and equipment failure.
-  **Do not place the device in areas that may get wet easily (e.g. near a humidifier).**
This may result in fire, electric shock and equipment failure.
-  **When connecting a DC power cord, pay due care not to mix up the positive and negative polarities.**
This may result in fire, electric shock and equipment failure.
-  **Do not use DC power cords other than the one enclosed or specified.**
This may result in fire, electric shock and equipment failure.
-  **Do not bend, twist, pull, heat and modify the power cord and connection cables in an unreasonable manner.**
This may cut or damage the cables and result in fire, electric shock and equipment failure.

-  **Do not pull the cable when plugging and unplugging the power cord and connection cables.**
Please hold the plug or connector when unplugging. If not, this may result in fire, electric shock and equipment failure.
-  **Refrain from using headphones and earphones at a loud volume.**
Continuous exposure to loud volumes may result in hearing impairment.
-  **Do not use the device when the power cord and connection cables are damaged, and when the DC power connector cannot be plugged in tightly.**
Please contact our company amateur customer support or the retail store where you purchased the device as this may result in fire, electric shock and equipment failure.
-  **Follow the instructions given when installing items sold separately and replacing the fuse.**
This may result in fire, electric shock and equipment failure.
-  **Do not use the device when the alarm goes off.**
For safety reasons, please pull the power plug of the DC power equipment connected to the product out of the AC socket.
Never touch the antenna as well. This may result in fire, electric shock and equipment failure due to thunder.

CAUTION

-  **Do not place this device near a heating instrument or in a location exposed to direct sunlight.**
This may result in deformation and discoloration.
-  **Do not place this device in a location where there is a lot of dust and humidity.**
Doing so may result in fire and equipment failure.
-  **Stay as far away from the antenna as possible during transmission.**
Long-term exposure to electromagnetic radiation may have a negative effect on the human body.
-  **Do not wipe the case using thinner and benzene etc.**
Please use a soft and dry piece of cloth to wipe away the stains on the case.
-  **Keep out of the reach of small children.**
If not, this may result in injuries to children.
-  **Do not put heavy objects on top of the power cord and connection cables.**
This may damage the power cord and connection cables, resulting in fire and electric shock.
-  **Do not transmit near the television and radio.**
This may result in electromagnetic interference.
-  **Do not use optional products other than those specified by our company.**
If not, this may result in equipment failure.
-  **When using the device in a hybrid car or fuel-saving car, make sure to check with the car manufacturer before using.**
The device may not be able to receive transmissions normally due to the influence of noises from the electrical devices (inverters etc.) fitted in the car.

-  **For safety reasons, switch off the power and pull out the DC power cord connected to the DC power connector when the device is not going to be used for a long period of time.**
If not, this may result in fire and overheating.
-  **Do not throw or subject the device to strong impact forces.**
This may result in equipment failure.
-  **Do not put this device near magnetic cards and video tapes.**
The data in the cash card and video tape etc. may be erased.
-  **Do not turn on the volume too high when using a headphone or earphone.**
This may result in hearing impairment.
-  **Do not place the device on an unsteady or sloping surface, or in a location where there is a lot of vibration.**
The device may fall over or drop, resulting in fire, injury and equipment failure.
-  **Do not stand on top of the product, and do not place heavy objects on top or insert objects inside it.**
If not, this may result in equipment failure.
-  **Do not use a microphone other than those specified when connecting a microphone to the device.**
If not, this may result in equipment failure.
-  **Do not touch the heat radiating parts.**
When used for a long period of time, the temperature of the heat radiating parts will get higher, resulting in burns when touched.
-  **Do not open the case of the product except when replacing the fuse and when installing items sold separately.**
This may result in injury, electric shock and equipment failure.

FTM-3207DR/DE Quick Reference Guide

② VOL Knob

Adjusts the audio volume level.

③ Frequency DIAL Knob

Selects the operating Frequency.

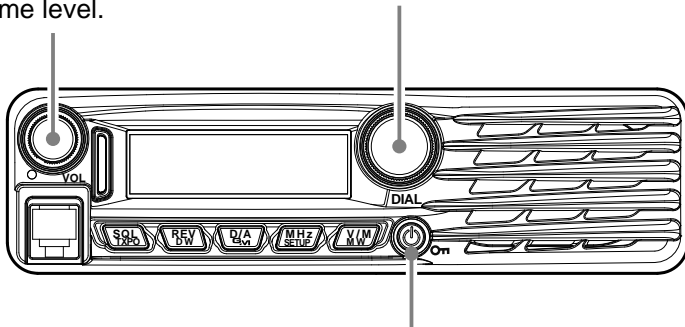

① Power Switch

Press and hold for one second.

④ Transmission Switch

Speak into the microphone in a normal voice level while pressing this switch.

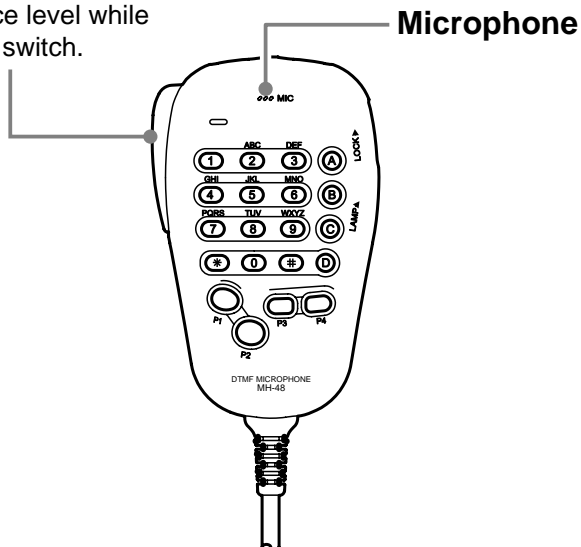

Introduction

Features of this radio

- 430 MHz mobile radio, equipped with a C4FM communication modem
- 55 Watts of power output, with selection of three power levels for every operating situation
- Clear audio and data communication is achieved using the C4FM modem functions
- Expanded receiver coverage: 420-470 MHz
- With the GD-ID (Digital Group ID) feature, the Group Monitor (GM) feature enables automatically locating, and communicating with other stations that have the same DG-ID number within contact range, by utilizing a matching group ID number from 00 to 99.
- The Digital Personal ID (DP-ID) feature may communicate only by the transceivers registered the individual ID information that is different for each transceiver included in the transmission radio wave of C4FM communication.
- The easy connection with the WIRES-X
- Keyboard entry of operating frequencies from the microphone
- 220 memories (199 “basic” memory channels, 10 sets of band-edge memory channels, and one “Home” channel) which can store repeater shifts, odd repeater shifts, CTCSS/DCS tones, and 8-character Alpha-Numeric labels for easy channel recognition
- Built-in CTCSS and DCS Encoder/Decoder circuits
- Extensive Menu system, which allows customization of a number of transceiver performance characteristics
- Equipped with the GM (Group Monitor) function.

Additional features include a transmit Time-Out-Timer (TOT), Automatic Power-Off (APO), and Automatic Repeater Shift (ARS). Also included is an RF Squelch circuit that allows the owner to set the squelch to open at a programmed setting of the S-Meter, thus reducing guesswork in setting the squelch threshold.

Congratulations on your purchase of the FTM-3207DR/DE! Whether this is your first rig, or if Yaesu equipment is already the backbone of your station, the Yaesu organization is committed to ensuring your enjoyment of this high-performance transceiver. It should provide you with many years of satisfying operation. Our dealer network and technical support personnel stand behind every product we sell, and we invite you to contact us should you require technical advice or assistance.

We recommend that you read this manual in its entirety prior to installing the FTM-3207DR/DE, so that you fully understand the capabilities of your new transceiver.

Accessories & Options

Supplied Accessories

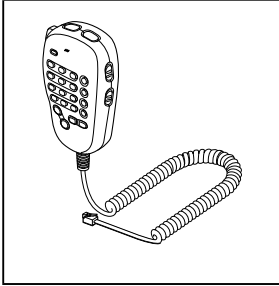

DTMF Microphone
MH-48A6JA

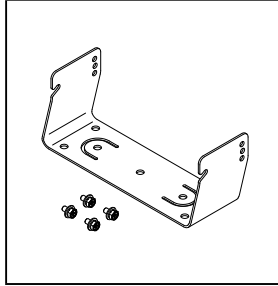

Mobile Mounting Bracket
(Attachment screw set)

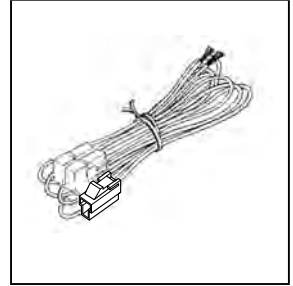

DC power cable w/Fuse

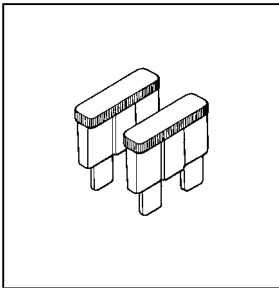

Spare fuse (25 A)
(20 A, European version)

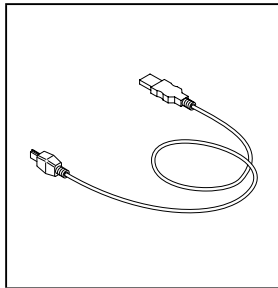

USB cable

Operating Manual
Warranty Card

Optional Accessories

MH-42C6J	Microphone
MH-48A6JA	DTMF Microphone
MLS-100	High-Power External Speaker
FP-1030A	AC Power Supply (USA/EXP market only)

Installation

Connecting the Microphone

Connect the supplied MH-48A6JA microphone to the FTM-3207DR/DE.
Plug the microphone connector into the MIC jack on the front panel until it clicks.

Note: When disconnecting the microphone, pull the cable while pressing the connector latch.

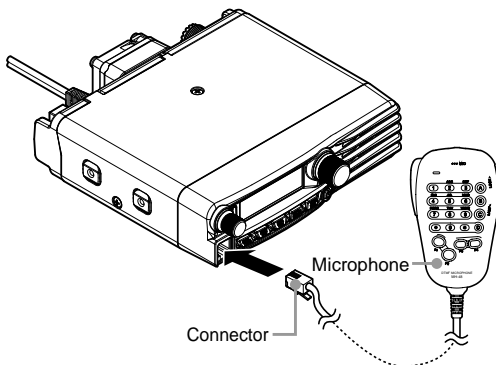

Connecting the Antenna

Connect the coaxial cable to the body.
Plug the coaxial cable jack into the ANT terminal on the rear panel of the body, then rotate and tighten it.

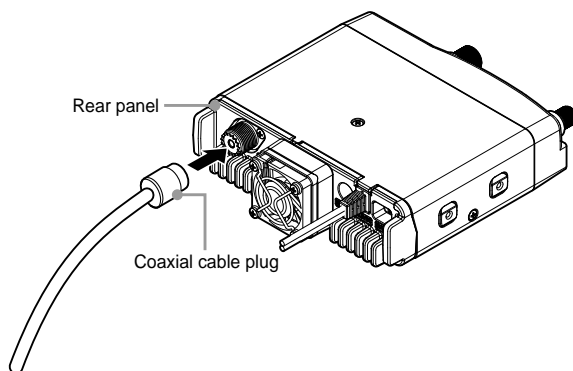

Installation

Mobile Installation

The FTM-3207DR/DE must only be installed in vehicles having a 13.8 Volt negative ground electrical system. Mount the transceiver where the display, controls, and microphone are easily accessible, using the supplied mounting bracket.

The transceiver may be installed in almost any location, but should not be positioned near a heating vent nor anywhere where it might interfere with driving (either visually or mechanically).

Make sure to provide plenty of space on all sides of the transceiver so that air can flow freely around the radio's case. Refer to the diagrams showing proper installation procedures.

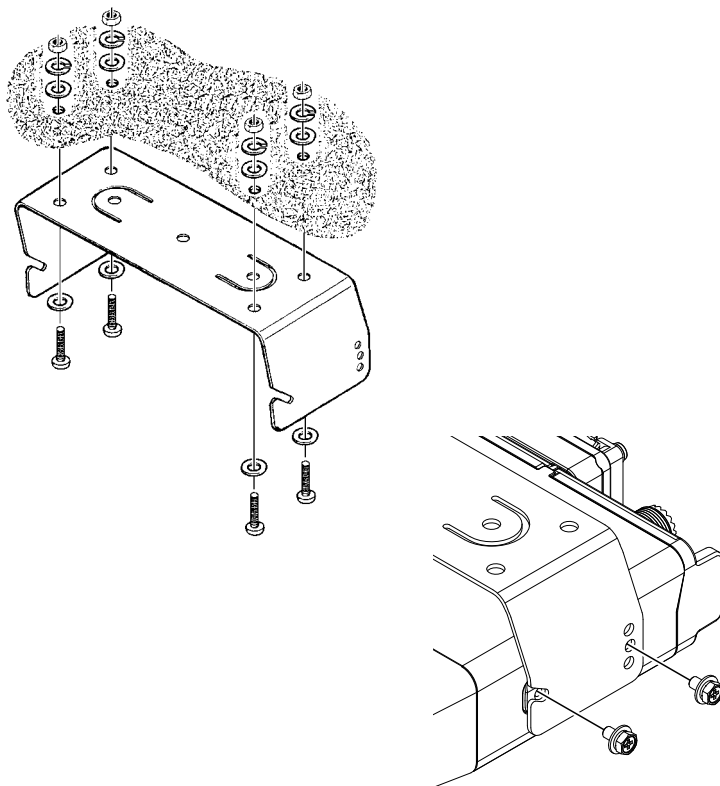

Installation

Power connection

To minimize voltage drop and avoid blowing the vehicle's fuses, connect the supplied DC power cable directly to the battery terminals. Do not attempt to defeat or bypass the DC cable fuse - it is there to protect you, your transceiver, and your vehicle's electrical system.

Warning!

Never apply AC power to the power cable of the FTM-3207DR/DE, nor DC voltage greater than 15.8 Volts. When replacing the fuse, only use a 25-A (20-A, European version) fuse. Failure to observe these safety precautions will void the Limited Warranty on this product.

- Before connecting the transceiver, check the voltage at the battery terminals while revving the engine. If the voltage exceeds 15 Volts, adjust the vehicle's voltage regulator before proceeding with installation.
- Connect the **RED** power cable lead to the **POSITIVE (+)** battery terminal, and the **BLACK** power cable lead to the **NEGATIVE (-)** terminal. If you need to extend the power cable, use #12 AWG or larger insulated, stranded copper wire. Solder the splice connections carefully, and wrap the connections thoroughly with insulating electrical tape.
- Before connecting the cable to the transceiver, verify the voltage and polarity at the voltage at the transceiver end of the DC cable, using a DC voltmeter. Now connect the transceiver to the DC cable.

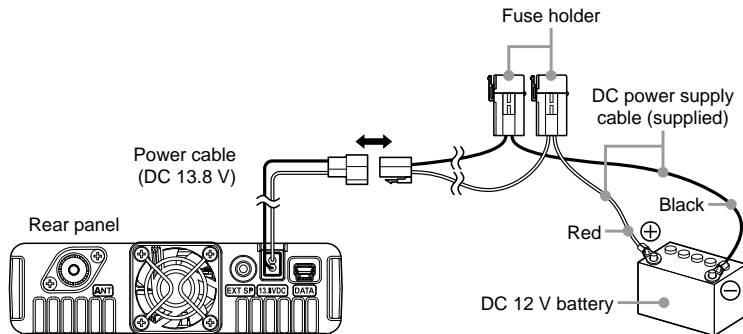

Warning!

- **Do not use a DC power supply cable other than the one that is supplied or specified.**
- **Do not place anything on the DC power supply cable or step on it.**
- **Do not use the DC power supply cable with the fuse holder cut off.**
- **Do not reverse the polarity (positive and negative) when connecting the battery.**

Installation

Base Station Installation

The FTM-3207DR/DE is ideal for base station use as well as in mobile installations. The FTM-3207DR/DE is specifically designed to integrate into your station easily, using the following information as a reference.

AC Power Supplies

Operation of the FTM-3207DR/DE from an AC line requires a power source capable of providing at least 20 Amps continuously at 13.8 Volts DC. The FP-1023 (USA market only) and FP-1030A (USA/EXP market only) AC Power Supplies are available from your Yaesu dealer to satisfy these requirements. Other well-regulated power supplies may be used as well, if they meet the above voltage and current specifications.

Use the DC power cable supplied with the transceiver to make the power connection to the power supply. Connect the **RED** power cable lead to the **POSITIVE (+)** power supply terminal, and connect the **BLACK** power cable lead to the **NEGATIVE (-)** power supply terminal.

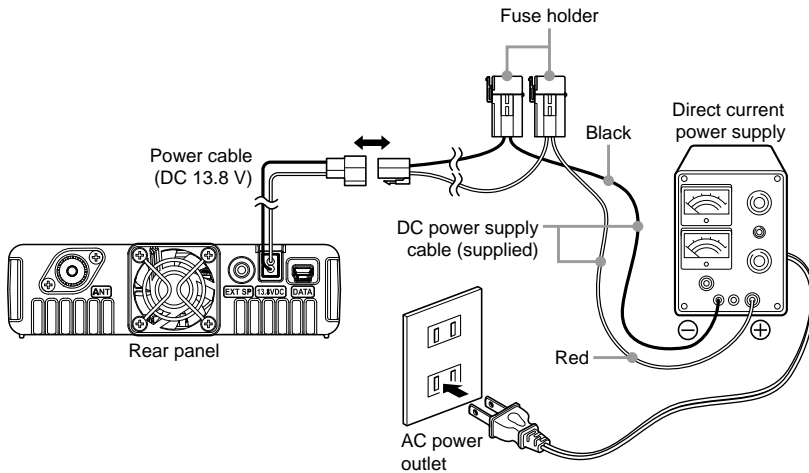

Front Panel Controls & Switches

Front Panel

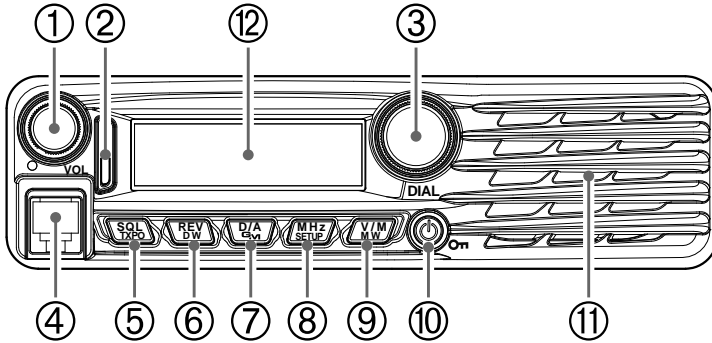

① VOL knob

Turning the knob clockwise increases the volume, whereas turning it counterclockwise decreases the volume.

② Mode/Status indicator

Indicates the transmission/reception status with a two-color combination on the upper and lower portions of the mode/status indicator.

Communication status	Upper portion	Lower portion
Receiving analog audio	Green	Green
Transmitting analog audio	Red	Red
Receiving digital audio	Green	Blue
Transmitting digital audio	Red	Blue
Receiving digital data	Green	White
Transmitting digital data	Red	White
Receiving signals with unmatched audio or data conditions*	Green	Blink in Blue

- ※ • Receiving signals with unmatched tone frequency or DCS code.
- Receiving analog audio in digital mode.
- Receiving signals with unmatched SQL code in digital mode.
- Receiving a signal level less than the RF Squelch S-meter level setting.

③ DIAL Knob

- Allows setting the operating band frequency.
Turning clockwise increases the frequency, whereas turning counterclockwise decreases the frequency.
- Allows selecting the desired items for setup, memory registration, group monitoring operation, etc.

④ MIC Jack

Connect the provided microphone cable.

Front Panel Controls & Switches

⑤ **[SQL(TXPO)]** key
 Press and hold the key in for over one second to select the transmit power (HIGH: 55 W / MID: 25 W / LOW: 5 W).

⑥ **[REV(DW)]** key
 During split-frequency operation, such as through a repeater, this key reverses the transmit and receive frequencies.
 Press and hold the key in for over one second to activate the Dual Watch feature.
Note: For details, refer to the Advanced Manual (download from the Yaesu website).

⑦ **[D/A(GM)]** key
 Briefly pressing each time switches the operating band communication mode.
 Press and hold in this key for over one second to activate the GM (Group Monitor) function.
Note: For details on the GM function, see “GM (Group Monitor) Function” on page 33

⑧ **[MHz(SETUP)]** key
 This key allows tuning in 1 MHz steps (the MHz digits will blink on the display).
 Press and hold this key in for over one second to activate the Setup (Menu) Mode.

⑨ **[V/M(MW)]** key
 Pressing this key briefly, switches between VFO mode and memory mode. Press and hold the key for over one second to display the memory registration screen.

⑩ **Power/Lock** key
 Press and hold in this key for over one second to switch the power between ON and OFF. Briefly pressing the key while the transceiver is turned ON engages or releases the key lock.

⑪ **Speaker**
 The internal speaker is located here.

⑫ **LCD Display**
 The main digits on the display may show the operating frequency, memory name, or any of many parameters during Menu setup.

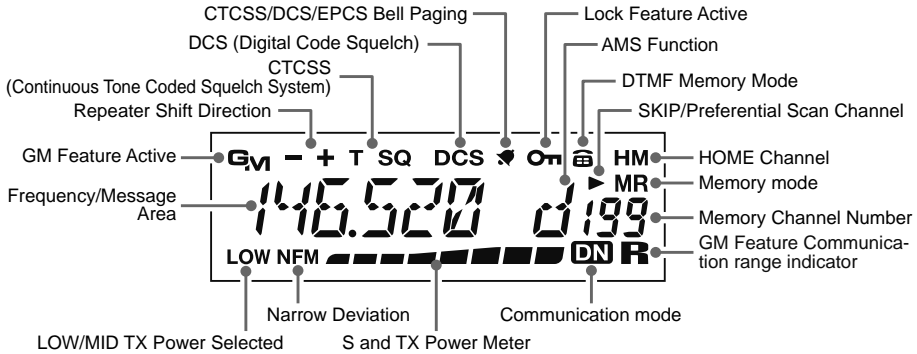

Microphone Switches

Microphone (MH-48A6JA)

① PTT Switch

Press this switch to transmit, and release it to receive.

② KEY Pad

These 16 keys generate DTMF tones during transmission.

In the receive mode, these 16 keys can be used for direct frequency entry and/or direct numeric recall of the Memory channels.

③ [P1] / [P2] / [P3] / [P4] keys

These four keys are user programmable, allowing quick access to features used often. The default functions are described below.

[P1] button (SQL OFF)

Press this button to disable the noise and tone squelch systems.

[P2] button (HOME)

Press this button to recall the receiver HOME channel.

[P3] button (DIG/ANA)

Press this button to activate the Tone or DCS Search feature.

[P4] button (TX PW/T.CALL)

In the USA version, pressing this button activates TX power setting.

In the EXP/European version, pressing this button activates T.CALL (1750 Hz) for repeater access.

You can reprogram the [P1], [P2], [P3], and [P4] buttons for other functions, if desired.

Note: For details, refer to the Advanced Manual (download from the Yaesu website).

④ MIC

Speak into this port during transmission.

⑤ [UP] / [DWN] keys

Press (or hold in) either of these buttons to tune (or scan up or down) the operating frequency or through the memory channels. In many ways, these buttons emulate the function of the (rotary) DIAL knob.

⑥ LOCK switch

This switch locks out the Microphone buttons (except for the keypad and PTT switch).

⑦ LAMP switch

This switch illuminates the Microphone keypad.

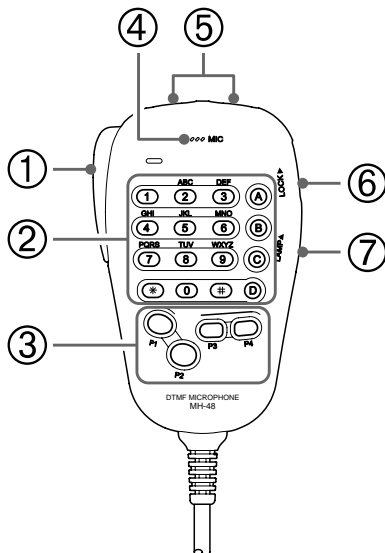

Rear Panel Connectors

Rear Panel

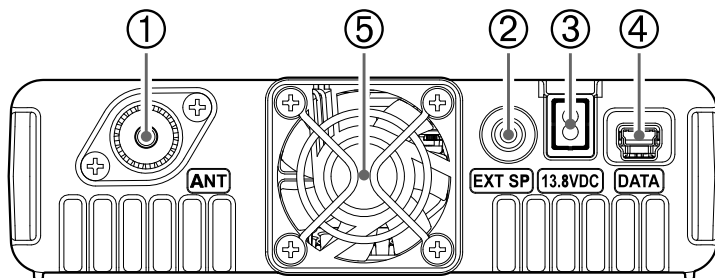

① ANT Coaxial Socket

Connect a 430 MHz antenna to this type-M (SO-239) socket using 50-Ohm coaxial cable and a type-M (PL-259) plug. Make sure the antenna is designed specifically for use on the operating frequency.

② EXT SP Jack

This 2-contact 3.5-mm mini phone jack provides receiver audio output for an optional external speaker. The audio impedance is 4 Ohms, and the level varies according to the setting of the front panel **VOL** control. Inserting a plug into this jack disables audio from the transceiver's internal speaker.

③ 13.8 V DC Cable

Connect the provided DC power supply cable (with fuse attached).

④ DATA Jack

Use this jack when updating the firmware. When a new firmware update for the FTM-3207DR/DE is available, go to the YAESU website to download the programming data and update the FTM-3207DR/DE to its newest state.

⑤ Cooling Fan

Basic Operation

Turning the Transceiver ON and OFF

1. To turn the transceiver ON, press and hold the **PWR/LOCK** key for one second.
2. To turn the transceiver OFF, again press and hold the **PWR/LOCK** key for one second.

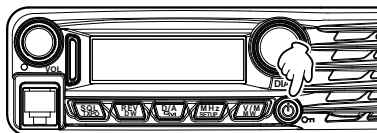

You can compose any desired Opening Message (up to 8 characters) via Setup Menu Item “**OPEN MSG 27**” see page 38 for details.

Inputting the call sign

A screen requesting input of a call sign appears when turning the transceiver on for the first time, or after resetting the transceiver. The call sign is used to identify the transmitting station when communicating in digital mode.

1. Press the **[V/M(MW)]** key.
2. Rotate the **DIAL** knob to select characters, then press the **[V/M(MW)]**.

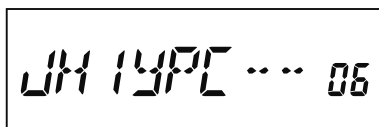

By rotating the **DIAL** knob, you can switch the characters in the following order:

“space” ⇨ “-” ⇨ “/” ⇨ “0” to “9” ⇨ “A” to “Z”

- Up to 10 characters (alphanumeric characters including hyphen) can be entered.
 - “space”, “-”, and “/” are not selectable for the first character.
3. Press and hold the **[MHZ(SETUP)]** key for one second to save the call sign and exit to normal operation.

Adjusting the Audio Volume Level

Rotate the **VOL** knob to adjust the receiver volume. Clock-wise rotation increases the audio output level.

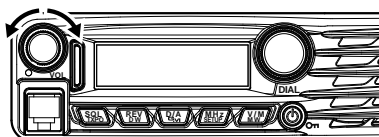

Adjusting the Squelch Setting

1. Press the **[SQL(TXPO)]** key, then rotate the **DIAL** knob to select the Squelch level.
2. Press the **[SQL(TXPO)]** key again.

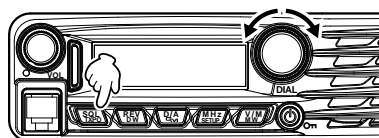

Note: A special “RF Squelch” feature is provided on this radio. This feature allows setting the squelch so that only signals exceeding a certain S-meter level will open the squelch. For details, refer to the Advanced Manual (download from the Yaesu website).

Basic Operation

Frequency Navigation

Using the Dial

Rotating the **DIAL** knob allows tuning in the pre-programmed steps. Clockwise rotation tunes the frequency upwards, whereas counterclockwise rotation tunes the frequency downwards.

- Press the [**MHz(SETUP)**] key momentarily, then rotate the **DIAL** knob, to change the frequency steps to 1 MHz per step.

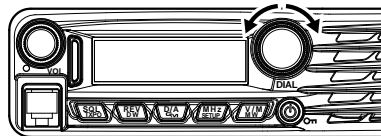

Using the MH-48A6JA Microphone

Using the [UP] and [DWN] key:

Pressing [**UP**] momentarily, tunes the frequency upwards. Whereas pressing [**DWN**] momentarily tunes the frequency in the downward direction.

Using the number keys:

Use the [0] to [9] number keys to directly input the frequency.

There is no “decimal point” key on the MH-48A6JA keypad. However, there is a short-cut for frequencies ending in zero: press the [#] key after the last non-zero digit.

Examples: To enter 146.520 MHz, press [1] ➡ [4] ➡ [6] ➡ [5] ➡ [2] ➡ [0]
To enter 146.000 MHz, press [1] ➡ [4] ➡ [6] ➡ [#]

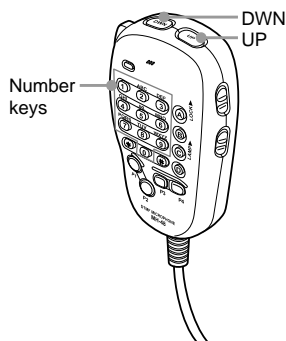

Channel Step Selection

The frequency tuning step of the **DIAL** and the microphone [**UP**]/[**DWN**] keys can be changed.

Note: See Setup Menu Item “**43 STEP**” on page 39

Basic Operation

Selecting the communication mode

The FTM-3207DR/DE transceiver is equipped with the AMS (Automatic Mode Select) function which automatically selects from two modes of transmission corresponding to the signal being received.

The transmit mode is selected according to the received signal so that C4FM digital signals, and analog signals are received and transmitted automatically.

Press **[D/A(GM)]** key to display “**DN**” (blinks) icon on the screen.

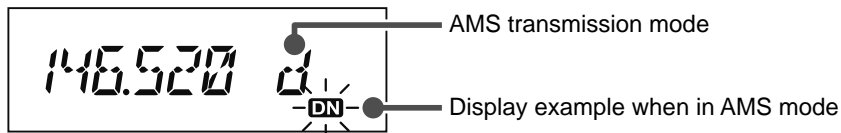

To operate in fixed communication mode, press **[D/A(GM)]** key to switch the communication mode.

Each time **[D/A(GM)]** key is pressed, the communication mode changes in the following order:

➡ AMS (“**DN**” blinks) ➡ V/D (“**DN**” lights up) ➡ FM (no icon) ➡

Communication mode	Icon	Description of modes
AMS (Automatic Mode Select)	DN (blinks)	Transmit mode is automatically selected from 3 types according to the signal received. The AMS function operation can be changed from the Setup menu setting. See “Setting the transmit mode when using the AMS function (DIG AMS 11)” on page 37
V/D Mode (Voice/Data simultaneous transmission mode)	DN (light up)	Calls are less prone to interruptions due to detection and correction of voice signals during digital voice signal transmission. This is the standard mode for C4FM Digital.
Analog FM Mode	no icon	Analog communication using FM mode. Effective when the signal is weak and audio is susceptible to interruption in digital mode.

Basic Operation

Setting the transmission mode when using the AMS function

TXMANUAL (“DN” blinks: 1 sec on, 0.5 sec off)

Automatically selects one of the two communication modes according to the received signal. Briefly pressing [PTT] on the microphone switches between digital mode and analog mode.

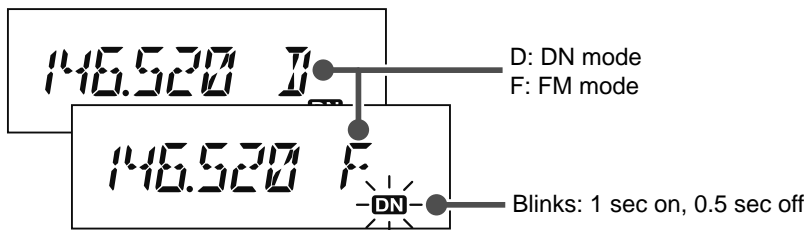

TX FMFIX (“DN” blinks: 0.5 sec on, 0.5 sec off)

Automatically selects one of the two communication modes according to the received signal. Always switches to FM mode for transmission.

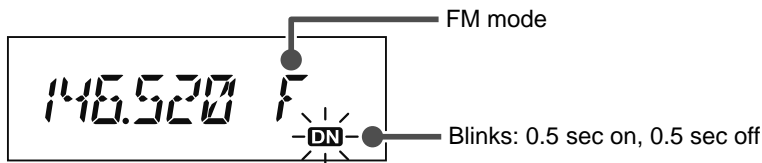

TX DNFIX (“DN” blinks: 0.5 sec on, 0.5 sec off)

Automatically selects one of the two communication modes according to the received signal. Always switches to DN mode for transmission.

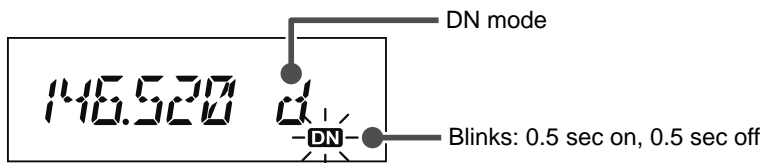

AUTO (“DN” blinks: 0.5 sec on, 0.5 sec off)

Automatically selects one of the two communication modes according to the received signal.

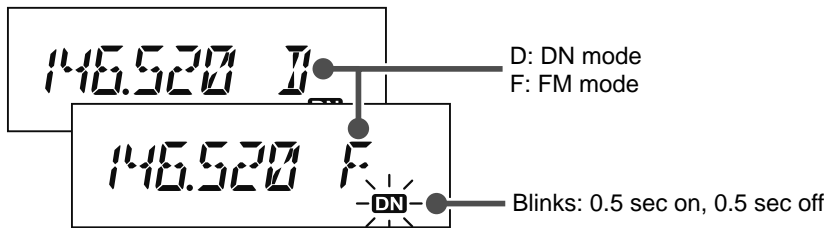

Basic Operation

Adjusting the transmit power

When communicating with a nearby station, the transmit power level may be lowered to reduce the battery power consumption.

1. Press and hold the **[SQL(TXPO)]** key for over one second.
2. Rotate the **DIAL** to select the transmit power.

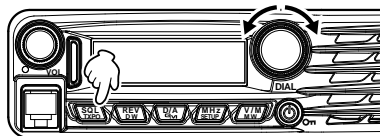

Note: The default setting: HIGH

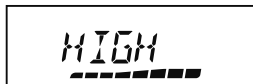

HIGH (55 W)



MID (25 W)

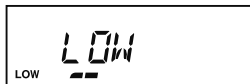

LOW (5 W)

3. Press the **[SQL(TXPO)]** key to save the new setting and exit to normal operation.

Lock Feature

To activate the key-lock feature, press the **[Power(Lock)]** key. The "On" icon will appear on the LCD.

To cancel key-lock, press the **[Power(Lock)]** key again.

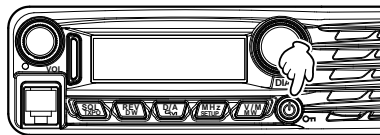

To select which keys are locked, use the Setup Menu Item "23 LOCK" see page 38 for details.

Using the convenient Digital C4FM feature

About the Digital Group ID (DG-ID) feature

1. Digital Group ID (DG-ID) function allows communications with only the specific group members using the two-digit ID numbers. The desired DG-ID number from 00 to 99 is set in advance by all the group members. This ID number may be set separately for transmit and receive, when the same ID number is set for both transmit and receive, only group members with the same ID number will be heard. This feature may be used to communicate only with group members that have the same DG-ID number. The GM function may also be utilized to automatically monitor whether or not group member stations with the same DG-ID number are operating within communication range.

The DG-ID number 00 detects signals with all ID numbers. Normally setting the ID number to "00" for both transmit and receive will permit reception of the signals from all other stations using the digital C4FM mode, regardless of the transmit DG-ID number settings of the other stations.

Also note that when the receive DG-ID number of your transceiver is set to a DG-ID number other than "00", received signals that do not have the same DG-ID number may not be heard.

2. When accessing the C4FM digital repeater controlled by the DG-ID number, set the transmit DG-ID number of the FTM-3207DR/DE to that of the repeater input. Even in that case, if the receive DG-ID number of the FTM-3207DR/DE is set to "00", all the downlink signals from the repeater may be received.

Communicating with the DG-ID feature



- Digital C4FM mode transceivers compatible with the DG-ID function are required in order to utilize this function.
- If the firmware is not compatible with the DG-ID function, update the latest firmware to use the DG-ID function. The latest firmware is available on the YAESU website

Setting the transmit and receive DG-ID number to "00" for communicating with all other stations using C4FM digital mode

1. Press the [P2] key.
 - The DG-ID number setting screen appears and the transmit DG-ID number "T00" blinks.
 - If the transmit DG-ID number is not set to "T00", rotate the DIAL knob to set "T00".
2. Press to the [P2] key again and the receive DG-ID number "R00" will blink.

If the receive DG-ID number is not set "R00", rotate the DIAL knob to set "R00".
3. Press and hold the [P2] key, or press the PTT switch to save the setting and return to the normal operation.

The setting is complete.

Basic Operation

- To check whether or not other stations are operating within communications range, press the **[D/A](GM)** key to turn the GM (Group Monitor) function ON.
The other stations also need to turn the GM (Group Monitor) function ON.
- Press and hold the **[D/A](GM)** key to turn the GM (Group Monitor) function OFF and return to the normal operation.



- While setting the DG-ID number, pressing and holding the **[D/A](GM)** key will set the transmit and the receive DG-ID numbers to "00".
- If the receive DG-ID is set to a number other than "00", only signals with that DG-ID will be received. Normally, set the receive DG-ID number to "00" except when communication is desired only with group members.
- The transmit and receive DG-ID default number is set to "00".

Communicating only with the specific members by setting the DG-ID number except for "00"

Example Set the DG-ID number of to "50"

- Press the **[P2]** key.
 - The DG-ID number setting screen appears and the transmit DG-ID number "T00" blinks.
 - Rotate the **DIAL** knob to set the transmit DG-ID number to "T50".



- Press to the **[P2]** key again to blink the receive DG-ID number "R00".

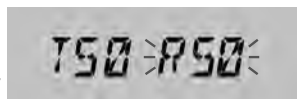

Rotate the **DIAL** knob to set the reception DG-ID number to "R50".

- Press and hold the **[P2]** key or press the **PTT** switch to save the setting and return to normal operation.

Tuning to the same frequency and setting the same DG-ID for all the group members will enable communication between the members and exclude other signals.

- Press the **[D/A](GM)** key to turn the GM (Group Monitor) function ON and check whether or not other stations that are operating on frequency, with the GM (Group Monitor) function ON, and have the same GD-ID number setting, are in the communication range.
 - The other stations also need to turn the GM (Group Monitor) function **ON**.
 - During operating on the GM (Group Monitor) function, "Operating Frequency", "GROUP" and "DG-ID number" are shown repeatedly on the LCD.
- Press and hold the **[D/A](GM)** key to turn the GM (Group Monitor) function OFF and return to the normal operation.



- While setting the DG-ID number, pressing and holding the **[D/A](GM)** key will set the transmit and the receive DG-ID numbers to "00".
- If the receive DG-ID is set to a number other than "00", only signals with that DG-ID will be received. Normally, set the receive DG-ID number to "00" except when communication is desired only with group members.

Basic Operation



For example, if the transmit and receive DG-ID numbers of group members are all set to “50”, communications from other DG-ID numbers is not received and only the group members setting the same DG-ID numbers may communicate. Also, the other stations set the receive DG-ID to any number except for “00” may not be received the signals of your stations.

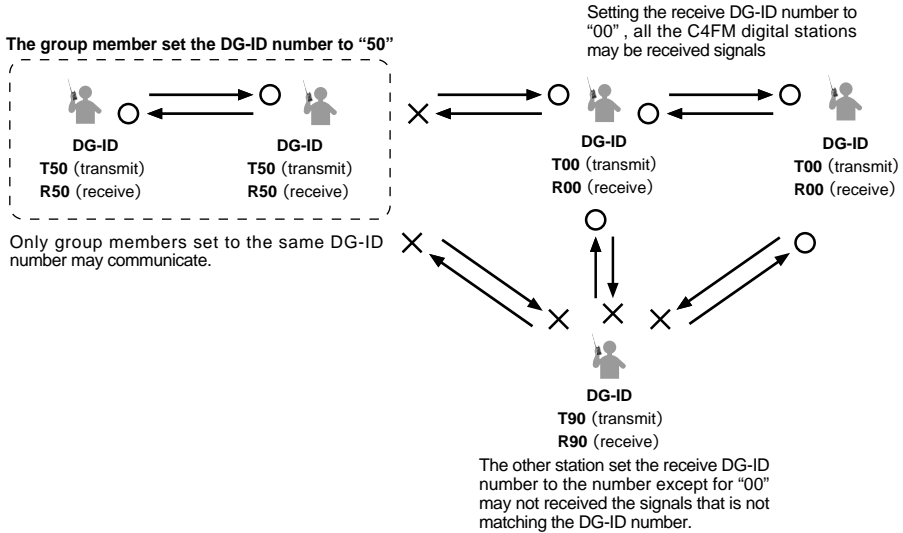

About the GM(Group Monitor) feature

The GM (Group Monitor) function automatically checks to find if there are any stations with the GM function in operation with the same DG-ID number within communication range. Setting the receive DG-ID number to “00” will check for all the C4FM digital stations In/ Out of range.



- Activating the GM (Group Monitor) function, the Digital C4FM mode is changed. For communicating in the Analog FM mode, Set the GM function OFF.
- The other member stations must also turn the GM (Group Monitor) function ON.

● In / Out Display

- When another station with the same DG-ID number is within the communication range, a beep sounds and the call sign is displayed under the GM (GroupMonitor) function icon.
- When all the members are out of the communication range, “out” is displayed and the **MODE/STATUS** indicator light is off.



When the DG-ID transmit and receive are set to “00” in the factory default setting, all stations In/ Out of range may be received and are displayed, but the other stations that set their receive DG-ID number to other than “00” may not be receiving your signals.

Basic Operation

Displaying the information of the other station received by GM (Group Monitor) function

1. When receiving the signals with the same DG-ID number, the call sign and the number of the remote station within the communication range.
 - When receiving the signals of multiple stations, rotate the DIAL knob to select the other stations to be displayed on the LCD.
 - Up to 24 stations may be displayed in order of their reception.



- The FTM-3207DR/DE may not send its own location information because the FTM-3207DR/DE is not equipped with the GPS function. Also, the latitude and longitude information included in the signal of the other station may not be displayed.
- The transceivers that may transmit position information with the GM function are as follows: (As of June 2017). FTM-400XD / FTM-400D series, FTM-100D series, FT2D, FT1XD, FT1D, FT-991A / FT-991* (*: Latitude and longitude setting must be entered manually, or an external GPS device must be connected.).

Advanced Operation

Repeater Operation

The FTM-3207DR/DE includes the ARS (Automatic Repeater Shift) function, which permits communication through repeaters automatically, by simply setting the receiver to the repeater frequency.

1. Tune to the repeater frequency.
2. Press the **PTT** to transmit.

During transmission, radio waves having an 100.0 Hz* tone signal are emitted on the frequency offset from the receive frequency by 7.6 MHz*.

*: Depends on the transceiver version.

Note: From the Setup Menu, you can change the repeater setting.

RPT ARS 36 ➡ Deactivates the ARS function.

RPT FREQ 37 ➡ Allows changing the repeater shift frequency offset.

RPT SFT 38 ➡ Allows setting the repeater shift direction.

Checking the Repeater Uplink (Input) Frequency

It is often helpful to be able to check the uplink (input) frequency of a repeater, to see if the calling station is within direct (“Simplex”) range.

To do this, just press the **[REV(DW)]** key. You’ll notice that the display has shifted to the repeater uplink frequency. Press the **[REV(DW)]** key again to cause operation to revert to normal monitoring of the repeater downlink (output) frequency. While listening on the repeater input frequency using the **[REV(DW)]** key, the repeater offset icon will blink.

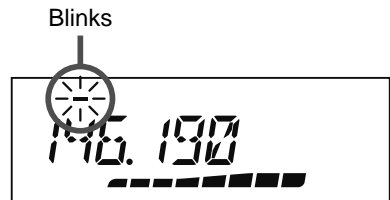

Tone Calling (1750 Hz)

If your transceiver is FTM-3207DE (European version), press and hold in the program key **[P4]** of the microphone (MH-48) to generates a 1750 Hz burst tone to access the European repeater. The transmitter will automatically be activated, and a 1750 Hz audio tone will be superimposed on the carrier. Once access to the repeater has been gained, you may release the **[P4]** key, and use the **PTT** for activating the transmitter thereafter.

Advanced Operation

CTCSS Operation

This radio is equipped with the CTCSS (Continuous Tone-coded Squelch System) that allows audio to be heard only when receiving signals containing a tone corresponding to the tone squelch menu setting. By matching the CTCSS tone with the partner station in advance, quiet standby monitoring is possible.

Caution: CTCSS does not function in digital mode. To transmit a signal using a CTCSS code, use the [D/A(GM)] key to switch the communication mode to AMS (Auto Mode Select function) or analog (FM) mode.

1. Press and hold the [MHZ(SETUP)] key for over one second.
The Setup menu appears.
2. Rotate the **DIAL** knob to select “SQL TYPE 42”, then press the [MHZ(SETUP)] key.
3. Rotate the **DIAL** knob to select “TSQL”, then press and hold the [MHZ(SETUP)] key for over one second.

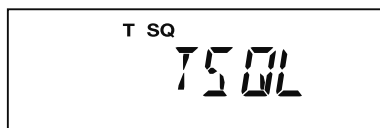

“T SQ” is displayed on the screen. Now the squelch opens only when receiving tone signals of the set frequency.

Note: From the Setup Menu, you can change the CTCSS setting.

TONE FRQ 45 ➡ The tone frequency can be selected from 50 frequencies.

BELL 6 ➡ A bell tone (beep) may be set to sound when signals containing a corresponding CTCSS tone are received.

Tone Search

When the CTCSS tone being transmitted by another station is not known, you can tune the radio to the incoming signal and activate tone scan to search for and identify the tone being used.

Note: For details, refer to the Advanced Manual (download from the Yaesu website).

DCS Operation

This radio is equipped with a DCS (Digital Coded Squelch) function that allows audio to be heard only when signals containing the corresponding DCS code are received. By matching the DCS code with the partner stations beforehand, a quiet receive standby is possible.

Caution: DCS does not function in digital mode. To transmit a signal with a DCS code, use the [D/A(GM)] key to switch the communication mode to AMS (Auto Mode Select function) or analog (FM) mode.

1. Press and hold the [MHZ(SETUP)] key for over one second.
The Setup menu appears.
2. Rotate the **DIAL** knob to select “SQL TYPE 42”, then press the [MHZ(SETUP)] key.

Advanced Operation

3. Rotate the **DIAL** knob to select “**DCS**”, then press and hold the [**MHz(SETUP)**] key for over one second.



Displays “**DCS**” on the screen. The squelch opens only when receiving a signal containing the corresponding DCS code.

Note: From the Setup Menu, you can change the DCS setting.

DCS CODE 9 ▶▶ The DCS code can be selected from 104 codes.

BELL 6 ▶▶ A bell tone (beep) may be set to sound when signals containing a corresponding DCS code are received.

DCS Search

When the DCS code being transmitted by another station is not known, you can tune the radio to the incoming signal and activate DCS code scan to search for and identify the DCS code being used.

Note: For details, refer to the Advanced Manual (download from the Yaesu website).

The following features are also available:

EPCS (Enhanced Paging & Code Squelch) Operation

Use the pager code consisting of two CTCSS tones to exchange communications with specified stations.

Note: For details, refer to the Advanced Manual (download from the Yaesu website).

Split Tone Operation

The FTM-3207DR/DE can be operated in a “Split Tone” configuration that enables operation on repeaters using a mix of both CTCSS and DCS control via the Setup menu.

Note: For details, refer to the Advanced Manual (download from the Yaesu website).

DTMF Operation

DTMF tones (Dual Tone Multi Frequencies) are the tones you hear when dialing from a telephone keypad. The FTM-3207DR/DE transceiver can transmit the DTMF codes by using the keys on the microphone or recalling registered number strings from memories. The maximum of 16-digit DTMF codes can be registered in up to 10 memory channels. It is convenient to register telephone patch numbers, and network linking sequences to the DTMF memory channels.

Note: For details, refer to the Advanced Manual (download from the Yaesu website).

Memory Operation

Memory Recall

Once the desired frequencies are stored into memory channels, switch from the “VFO” mode to the “Memory Recall” mode, to operate on the just-stored memory channels.

1. Press the [V/M(MW)] key, repeatedly if necessary, until the “MR” icon and a memory channel number appear on the display; this indicates that the “Memory Recall” mode is now engaged.
2. When more than one memory has been stored, use the **DIAL** knob to select any of the programmed memories for operation.

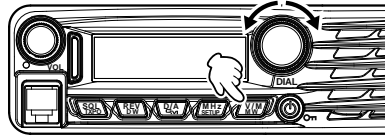

Note: Alternatively, the microphone [UP] or [DWN] button may be used to step or scan through the available memories. When using the microphone buttons, press the button momentarily to move one step up or down; press and hold the [UP] or [DWN] button for one second to begin memory scanning.

Memory Recall from the Microphone Keypad

While operating in the Memory Recall mode, the keypad of the MH-48A6JA Microphone may be used for direct recall of memory channels.

To do this, enter the desired Channel Number on the keypad and then press the [#] key.

For example:

To recall Memory Channel “5”, press [5] ➡ [#]

To recall Memory Channel “123”, press [1] ➡ [2] ➡ [3] ➡ [#]

You may also recall Programmable Memory Scan (PMS) channels (“L0/U0” through “L9/U9”) by entering the channel numbers listed in the below table:

L1	201	L3	205	L5	209	L7	213	L9	217
U1	202	U3	206	U5	210	U7	214	U9	218
L2	203	L4	207	L6	211	L8	215	L0	219
U2	204	U4	208	U6	212	U8	216	U0	220

Moving Memory Data to the VFO

Data stored on memory channels can easily be moved to the VFO.

Note: For details, refer to the Advanced Manual (download from the Yaesu website).

Memory Only Mode

Once memory channel programming has been completed, you may place the radio in a “Memory Only” mode, whereby VFO operation is impossible.

Note: For details, refer to the Advanced Manual (download from the Yaesu website).

Memory Operation

Masking Memories

There may be situations where you want to “Mask” memories so they are not visible during memory selection or scanning. (except for Memory Channel “1”, the Priority Channel, and the Home Channel).

1. In the Memory Recall mode, press and hold the **[V/M(MW)]** key for one second, then rotate the **DIAL** knob to select the memory channel you wish to mask.
2. Press the **[SQL(TXPO)]** key.
The erase confirmation screen appears.
3. Press the **[SQL(TXPO)]** key.
The previously selected memory will be “masked”.

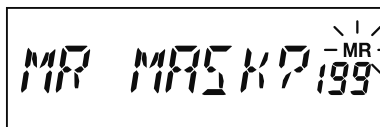
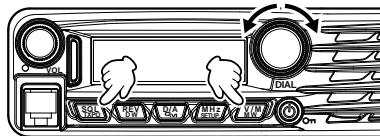

Note: Press any key, other than **[SQL(TXPO)]**, to cancel the memory mask.

Unmasking Memories

1. To Unmask a hidden memory, in the Memory Recall mode, press and hold the **[V/M(MW)]** key for one second.
2. Rotate the **DIAL** knob to select the masked memory number.
3. Press the **[SQL(TXPO)]** key to restore the memory channel data.

HOME Channel Memory

A convenient one-touch “Home” channel memory is available to simplify returning to an often used frequency.

To recall the Home channel, just press the **[V/M(MW)]** key, repeatedly if necessary, until the “**HM**” icon appears on the display; this indicates that the Home Channel has been recalled.

Note: When shipped from the factory, the Home Channel is set to 146.520 MHz (USA version) or 145.000 MHz (EXP/ European version).

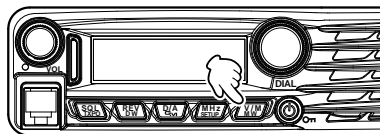

Changing the frequency of the home channel

The default frequency setting of the home channel can be changed.

1. In the VFO mode, tune to the desired Home channel frequency.
2. Press and hold the **[V/M(MW)]** key for one second, and then press the **[REV(DW)]** key.
The overwrite confirmation screen appears.
3. Press the **[REV(DW)]** key.
The home channel frequency is overwritten.

Scanning

Basic Scanner Operation

Before activating the scanner, make sure that the Squelch is set to silence the background noise when no signal is present. Scanning is not possible while the Squelch is open (if noise or signals are being heard).

Scanning may be started or stopped using the microphone [UP] or [DWN] button.

The following techniques are used for scanning:

- in the **VFO mode**, press and hold either the [UP] or [DWN] button for one second, to start upward or downward scanning of the band.
- In the **Memory mode**, press and hold either the [UP] or [DWN] button for one second to start channel scanning toward a higher or lower-numbered memory channel, respectively.

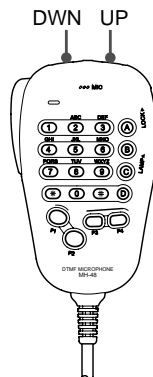

- Scanning pauses when a signal opens the squelch, and the decimal point on the display will blink. You can choose one of three scan-resume modes (described later).
- To halt the scan manually, the easiest way is to push the PTT switch on the microphone momentarily (no transmission will occur while you are scanning). The scan may also be halted manually by pressing the microphone [UP] or [DWN] button, or the [V/M(MW)] key.

Scan Resume Options

Select which of the three resume scan modes is to be performed after the scanning stops.

Note: For details, refer to the Advanced Manual (download from the Yaesu website).

Memory Skip Scanning

Memory channels which you do not want to receive can be skipped during scanning.

Note: For details, refer to the Advanced Manual (download from the Yaesu website).

Preferential Memory Scan

Set up a "Preferential Scan List" of channels which you can "flag" within the memory system.

Note: For details, refer to the Advanced Manual (download from the Yaesu website).

Programmable Memory Scan (PMS)

Using the dedicated PMS memory channels, only the frequencies within the specified frequency range will be scanned.

Note: For details, refer to the Advanced Manual (download from the Yaesu website).

Priority Channel Scanning (Dual Watch)

Scanning features include a two-channel scanning capability which allows you to operate on a VFO, Memory channel, or Home channel, while periodically checking a user defined Memory Channel for activity.

Note: For details, refer to the Advanced Manual (download from the Yaesu website).

GM Function

What is the GM (Group Monitor) Function?

The GM function automatically monitors the channel for any other stations with the GM function in operation on the same frequency, or stations transmitting in DN mode that are within communication range. You can be notified of GM stations operating within communications range, and the detected call signs are displayed on the transceiver screen,

Caution: The GM function does not work while in the analog (FM) mode.

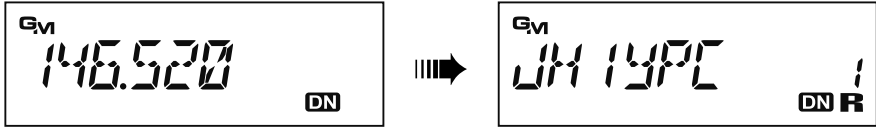

Displaying all the stations using the GM function

1. Tune to the designated frequency.
2. Press and hold the **[D/A(GM)]** key for one second.

The GM function is activated, and up to 24 stations using the GM mode, or stations operating in DN mode on the channel frequency, within the communication range are displayed

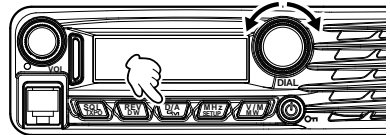

- Displays “**R**” for stations within your communication range.
- Displays “**R**” (blinks) for stations outside of your communication range.
- Turn the **DIAL** knob to select a station and display its communication range information.

3. Press and hold the **[D/A(GM)]** key for one second to disable the GM function and return to the frequency screen.

Reset Procedure/Clone

Reset Procedure

In some instances of erratic or unpredictable operation, the cause may be corruption of data in the microprocessor (due to static electricity, etc.). If this happens, resetting the microprocessor may restore normal operation. Note that all memories will be erased if you do a complete microprocessor reset, as described below.

Microprocessor Resetting

To clear all memories and other settings to factory defaults:

1. Turn the radio OFF.
2. Press and hold the [D/A(GM)], [MHz(SETUP)], and [V/M(MW)] keys while turning the radio on. The "ALL RESET PUSH V/M KEY" notation will scroll on the display.



ALL RESET PUSH V/M KEY

3. Press the [V/M(MW)] key momentarily to reset all settings to their factory defaults (press any other key to cancel the Reset procedure).

Set Mode Resetting

To reset the Set (Menu) mode settings to their factory defaults, while leaving other settings unchanged:

1. Turn the radio OFF.
2. Press and hold the [D/A(GM)] and [MHz(SETUP)] keys while turning the radio on. The "SET MODE RESET PUSH V/M KEY" notation will scroll on the display.



SET MODE RESET PUSH V/M KEY

3. Press the [V/M(MW)] key momentarily to reset the Set (Menu) mode settings to their factory defaults (press any other key to cancel the Reset procedure).

Clone

The FTM-3207DR/DE includes a convenient "Clone" feature, which allows the memory and configuration data from one transceiver to be transferred to another FTM-3207DR/DE.

This can be particularly useful when configuring a number of transceivers for a public service operation.

Note: For details, refer to the Advanced Manual (download from the Yaesu website).

Miscellaneous Settings

Programming the Key Assignments

Default FTM-3207DR/DE key functions have been assigned to the Microphone's [P1]/[P2]/[P3]/[P4] keys at the factory. The user may change these key function assignments, if quick access to another function is desired.

Note: For details, refer to the Advanced Manual (download from the Yaesu website).

Keyboard Beeper

A key/button beeper provides useful audible feedback whenever a key/button is pressed. If you want to turn the beeper off (or back on again).

Note: If you want to turn the beeper off (or back on again), see Setup Menu Item “**3 BEP KEY**” on page 37.

Display Brightness

You can adjust the display brightness.

Note: See Setup Menu Item “**22 LCD DMMR**” on page 38.

Time-Out-Timer (TOT)

The “Time-Out Timer” (TOT) feature is designed to force the transceiver into the “receive” mode after a preset time period of continuous transmission (the default is 3 minutes).

Note: See Setup Menu Item “**46 TOT**” on page 39.

Automatic Power Off (APO)

The “Automatic Power-Off” (APO) feature will turn the radio completely off after a user defined period of PTT or key/button inactivity.

Note: See Setup Menu Item “**1 APO**” on page 37.

Busy Channel Lock-Out (BCLO)

The BCLO feature prevents the transmitter from being activated whenever a signal strong enough to break through the “noise” squelch is present on the frequency.

Note: See Setup Menu Item “**2 BCLO**” on page 37.

TX Deviation Level

You can reduce the receiver bandwidth and transmit deviation when operating on closely spaced frequencies (channel spacing of 12.5 or 15 kHz). The reduced transmitter deviation will minimize adjacent channel interference to other users.

Note: See Setup Menu Item “**52 W/N DEV**” on page 39.

MIC Gain Setting

At the factory, the microphone gain has been programmed so that it should be satisfactory for the supplied MH-48A6JA Microphone. If you use an after-market microphone or connect a TNC, you may wish to set a different Mic Gain level.

Note: See Setup Menu Item “**24 MIC GAIN**” on page 38.

Miscellaneous Settings

Displaying the Supply Voltage

Display the Power Supply voltage.

Note: See Setup Menu Item “**8 DC VOLT**” on page 37.

Displaying the Temperature

Indicates the current temperature inside the transceiver's case.

Note: See Setup Menu Item “**44 TEMP**” on page 39.

Band Edge Beeper

The FTM-3207DR/DE will automatically “beep” when the receiver's band edge is encountered during scanning (either in standard VFO scanning or during PMS operation). You may additionally enable this feature (band edge beeper) when the frequency reaches the band edge while selecting the VFO frequency manually, using the **DIAL** knob.

Note: For details, refer to the Advanced Manual (download from the Yaesu website).

Setup (Menu) Mode

Menu Item	Function	Available Values	Default
16: DT DELAY	Setting of the DTMF Autodialer TX Delay Time.	50/250/450/750/1000	450 MS
17: DT SET	Loading of the DTMF Autodialer Memories.	---	---
18: DT SPEED	Setting of the DTMF Autodialer Sending Speed.	50/100	50 MS
19: DW RVRT	Enables/Disables the "Priority Channel Revert" feature.	ON/OFF	OFF
20: GM RINGR	Enables/Disables the alert sound when detecting stations within communication range	IN RANGE/ALWAYS/OFF	IN RANGE
21: GM INTVL	Selects the automatic sending interval.	NORMAL/LONG	NORMAL
22: LCD DMMR	Setting of the front panel display illumination level.	LEVEL 1/2/3/4	LEVEL 4
23: LOCK	Selects the Control Locking Lockout combination.	KEY + DIAL / PTT / KEY+PTT/DIAL+PTT / ALL/KEY/DIAL	KEY+DIAL
24: MIC GAIN	Adjust the microphone gain level.	LEVEL 1 to 9	LEVEL 5
25: MEM NAME	Programming an Alpha/Numeric label for a Memory Channel.	---	---
26: MW MODE	Selects the method of selecting of channels for Memory Storage.	NEXT CH/LOWER CH	NEXT CH
27: OPEN MSG	Selects the Opening Message that appears when the radio is powered ON.	OFF/DC/MESSAGE	MESSAGE
28: PAG CD-R	Setting the Receiver Pager Code for the Enhanced CTCSS Paging & Code Squelch function.	---	05 47
29: PAG CD-T	Setting the Transmitting Pager Code for the Enhanced CTCSS Paging & Code Squelch function.	---	05 47
30: PRG P1	Programming the function assigned to Microphone [P1] key.	SQL OFF HOME WX CH CD SRCH SCAN T CALL TX POWER DIG/ANA GM Setup Menu Item #1 to 53	SQL OFF
31: PRG P2	Programming the function assigned to Microphone [P2] key.		HOME
32: PRG P3	Programming the function assigned to Microphone [P3] key.		DIG/ANA
33: PRG P4	Programming the function assigned to Microphone [P4] key.		※
34: RADIO ID	Displays the transceiver IDs	※※※※ (uneditable)	---
35: RF SQL	Adjusts the RF Squelch threshold level.	OFF/S1 to S8	OFF
36: RPT ARS	Activates/Deactivates the Automatic Repeater Shift feature.	ON/OFF	ON
37: RPT FREQ	Sets the magnitude of the Repeater Shift.	0.00 - 150.00 (MHz)	7.60 MHz
38: RPT SFT	Sets the Repeater Shift direction.	-RPT/+RPT/SIMPLEX	SIMPLEX
39: SCAN RSM	Selects the Scan Resume mode.	BUSY/HOLD/2-10 (SEC)	5.0 SEC

Setup (Menu) Mode

Menu Item	Function	Available Values	Default
40: SCAN SKP	Selects the Memory Scan mode.	OFF/SKIP/SELECT	OFF
41: SQL EXP	Enables/Disables the split CTCSS/DCS coding.	ON/OFF	OFF
42: SQL TYPE	Selects the Tone Encoder and/or Decoder mode.	TONE/TSQL/DCS/ RV TONE/PAGER/OFF	OFF
43: STEP	Sets the frequency synthesizer steps.	AUTO/5/6.25/10/12.5/15 /20/25/50/100 (kHz)	AUTO
44: TEMP	Indicates the current temperature inside the transceiver.	---	※
45: TONE FRQ	Setting of the CTCSS Tone Frequency.	67.0 to 254.1 (Hz)	100.0 HZ
46: TOT	Sets the Time-Out Timer.	0.5 to 10.0 (MIN)/OFF	3.0 MIN
47: TS MUTE	Enables/Disables the receiver audio output while the Tone Search or DCS Search Scanner is activated.	ON/OFF	ON
48: TS SPEED	Selects the Tone Search or DCS Search Scanner speed.	FAST/SLOW	FAST
49: VER DISP	Displays the transceiver software version	CPU x.xx DSP x.xx	---
50: W/N DEV	Reduction of the Microphone Gain/Deviation and receiver bandwidth.	WIDE/NARROW	WIDE
51: MY CALL	Sets your station call sign	-----	---

※: Depends on the transceiver version.

Maintenance

Care and maintenance

Turn the power OFF before wiping away any dust and stains on the transceiver with a dry soft cloth. For stubborn stains, slightly moisten a soft cloth and wring it out before using it to wipe away the stains.

Caution: Never use washing detergents and organic solvents (thinner, benzene, etc.). Doing so may result in paint flaking or damage to the transceiver finish.

Replacing the fuse

When the fuse of the DC power supply cable blows and the transceiver becomes inoperable, correct the cause of the problem, and then replace the fuse with a new one of the correct rating (USA version: 25 Amp, EXP/European version: 20 Amp).

Caution: When replacing the fuse, be sure to disconnect the power supply cable from the transceiver and from the external DC power supply.

Replacing the fuse of the DC power supply cable

1. Prepare a new fuse.

Use a fuse with a rating of 25 A or 20 A.

Caution: Never attempt to use a fuse that is not of the specified rating.

USA version: 25 Amp

EXP/European version: 20 Amp

2. Open the fuse holder as shown in the diagram on the right.
3. Remove the blown fuse.
4. Attach the new fuse.
5. Close the fuse holder.

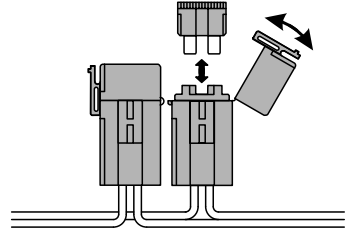

Specifications

General

Frequency Range:	Tx 430 - 450 MHz(USA version) 430 - 440 MHz(European version) 420 - 470 MHz(Asian version) Rx 420 - 470 MHz
Channel Step:	5/6.25/10/12.5/15/20/25/50/100 kHz
Standard Repeater Shift:	±5 / 7.6 MHz
Frequency Stability:	±2.5 ppm [-4 °F to +140 °F (-20 °C to +60 °C)]
Modes of Emission:	F2D/F3E/F7W
Antenna Impedance:	50 Ohms, unbalanced
Supply voltage:	13.8 V DC ±15%, negative ground
Current Consumption (typical):	Rx: less than 0.7 A, less than 0.5 A (squelched) Tx: 12 A (55 W) /7 A (25 W) /4 A (5 W)
Operating Temperature Range:	-4° F to +140° F (-20° C to +60° C)
Case Size (WxHxD):	6.1" x 1.7" x 6.1" (154 x 43 x 155 mm) (w/o knobs)
Weight (Approx.):	2.86 lb (1.3 kg)

Transmitter

Output Power:	55/25/5 W
Modulation Type:	F2D/F3E: Variable Reactance F7W: 4FSK (C4FM)
Maximum Deviation:	±5 kHz (Wide) ±2.5 kHz (Narrow)
Spurious Radiation:	Better than -60 dB Better than -61.1 dB (European version, 55 W)
Microphone Impedance:	2k Ohms

Receiver

Circuit Type:	Double Conversion Superheterodyne
Ifs:	1st 47.25 MHz, 2nd 450 kHz
Sensitivity (for 12dB SINAD):	0.20 µV (Ham band, wide) 0.22 µV (Ham band, narrow)
Sensitivity (for Digital):	0.22 µV (BER 1%)
Selectivity (-6/-60dB):	12 kHz/28 kHz
Maximum AF Output:	3 W into 4 Ohms with 10% THD

Specifications are subject to change without notice, and are guaranteed within the 430 MHz amateur bands only. Frequency ranges will vary according to transceiver version; check with your dealer.

An amateur band radio doesn't require Certification/Verification for the transmitter under Part 97

- Changes or modifications to this device that are not expressly approved by YAESU MUSEN could void the user's authorization to operate this device.
- This device complies with part 15 of the FCC Rules. Operation is subject to the following two conditions: (1) This device may not cause harmful interference, and (2) this device must accept any interference including received, interference that may cause undesired operation.
- The scanning receiver in this equipment is incapable of tuning, or readily being altered, by the User to operate within the frequency bands allocated to the Domestic public Cellular Telecommunications Service in Part 22.
- The YAESU MUSEN is not responsible for any changes or modifications not expressly approved by the party responsible for compliance. Such modifications could void the user's authority to operate the equipment.

This device complies with ISSED's applicable license-exempt RSS standard(s). Operation is subject to the following two conditions: (1) this device may not cause interference, and (2) this device must accept any interference, including interference that may cause undesired operation of the device.

Le présent appareil est conforme aux CNR d'Industrie Canada applicables aux appareils radio exempts de licence. L'exploitation est autorisée aux deux conditions suivantes : (1) l'appareil ne doit pas produire de brouillage, et (2) l'utilisateur de l'appareil doit accepter tout brouillage radioélectrique subi, même si le brouillage est susceptible d'en compromettre le fonctionnement.

DECLARATION BY MANUFACTURER

The Scanner receiver is not a digital scanner and is incapable of being converted or modified to a digital scanner receiver by any user.

WARNING: MODIFICATION OF THIS DEVICE TO RECEIVE CELLULAR RADIOTELEPHONE SERVICE SIGNALS IS PROHIBITED UNDER FCC RULES AND FEDERAL LAW.

CAN ICES-3 (B) / NMB-3 (B)

This equipment has been tested and found to comply with the limits for a Class B digital device, pursuant to part 15 of the FCC Rules. These limits are designed to provide reasonable protection against harmful interference in a residential installation. This equipment generates, uses, and can radiate radio frequency energy; and, if not installed and used in accordance with the instructions, may cause harmful interference to radio communications. However, there is no guarantee that interference will not occur in a particular installation.

If this equipment does cause harmful interference to radio or television reception, which can be determined by turning the equipment off and on, the user is encouraged to try to correct the interference by one or more of the following measures:

- Reorient or relocate the receiving antenna.
- Increase the separation between the equipment and receiver.
- Connect the equipment into an outlet on a circuit different from that to which the receiver is connected.
- Consult the dealer or an experienced radio/TV technician for help.

YAESU

The radio

Copyright 2017
YAESU MUSEN CO., LTD.
All rights reserved.

No portion of this manual may be
reproduced without the permission of
YAESU MUSEN CO., LTD.

YAESU MUSEN CO., LTD.

Tennozu Parkside Building
2-5-8 Higashi-Shinagawa, Shinagawa-ku, Tokyo
140-0002 Japan

YAESU USA

6125 Phyllis Drive, Cypress, CA 90630, U.S.A.

YAESU UK

Unit 12, Sun Valley Business Park, Winnall Close
Winchester, Hampshire, SO23 0LB, U.K.

1707X-XX

Printed in Japan



E H 0 7 5 U 1 0 0