



## QUANTUM GX2360S

25 Watt VHF/FM  
Marine Transceiver

---

### Owner's Manual

- Huge alphanumeric LCD, knobs and keys
- Large 2.8 inch internal loudspeaker producing louder audio
- 30 W Loud Hailer with listen back and 4 fog horns, Bells & Whistles
- Removable ClearVoice speaker microphone with 16/9 key and channel selection
- Display shows channel names, and repeats GPS information\*
- Capable of connecting 2 optional **RAM+** second station remote microphones
- DSC distress call automatically broadcasts lat/long and vessel ID\*
- DSC position request function and NMEA data input/output to connect to GPS Plotter\*
- Versatile user-programmable Scanning, Priority Scan and Dual Watch
- NOAA Weather channels and Alert
- One-button access to Channel 16 and 9
- One-button access to user selectable preset channels
- Access to all US, Canadian and International channels

\* with GPS attached

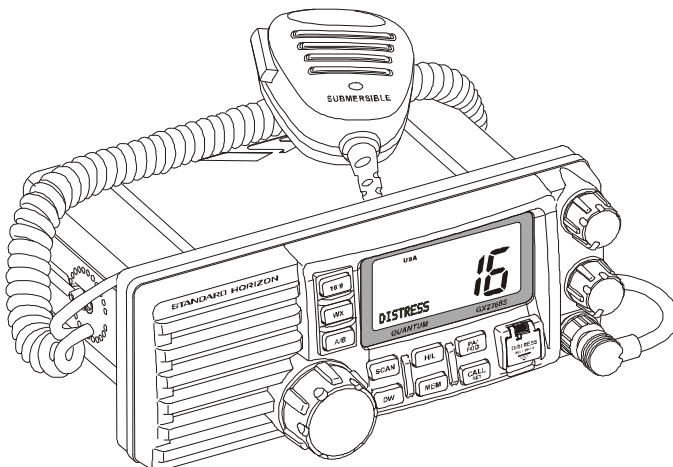

# TABLE OF CONTENTS

<b>SAFETY/WARNING INFORMATION</b> .....	<b>4</b>
<b>FCC RADIO LICENSE INFORMATION</b> .....	<b>5</b>
<b>FCC NOTICE</b> .....	<b>6</b>
<b>GETTING STARTED</b> .....	<b>7</b>
ABOUT VHF RADIO .....	7
SELECTING AN ANTENNA .....	7
COAXIAL CABLE .....	8
<b>1 GENERAL INFORMATION</b> .....	<b>9</b>
1.1 INTRODUCTION .....	9
1.2 FCC / INDUSTRY CANADA INFORMATION .....	9
<b>2 PACKING LIST</b> .....	<b>10</b>
<b>3 OPTIONS</b> .....	<b>10</b>
<b>4 INSTALLATION</b> .....	<b>11</b>
4.1 LOCATION .....	11
4.2 ELECTRICAL CONNECTIONS .....	11
4.3 ACCESSORY CABLE .....	12
4.4 CONNECTION OF GPS WITH NMEA OUTPUT .....	13
4.5 CHECKING GPS CONNECTIONS .....	14
4.6 CHANGING THE GPS TIME .....	14
4.7 CHANGING COG TO TRUE OR MAGNETIC .....	15
4.8 OPTIONAL MMB-84 FLUSH MOUNT INSTALLATION .....	16
4.9 OPTIONAL CMP25 RAM+ MIC INSTALLATION .....	17
<b>5 CONTROLS AND INDICATORS</b> .....	<b>18</b>
5.1 CONTROLS AND CONNECTIONS .....	18
<b>6 BASIC OPERATION</b> .....	<b>23</b>
6.1 RECEPTION .....	23
6.2 TRANSMISSION .....	23
6.3 TRANSMIT TIME-OUT TIMER (TOT) .....	23
6.4 SIMPLEX/DUPLEX CHANNEL USE .....	24
6.5 USA, CANADA, AND INTERNATIONAL MODE .....	24
6.6 NOAA WEATHER CHANNELS .....	24
6.7 NOAA WEATHER ALERT .....	25
6.8 NOAA WEATHER ALERT TESTING .....	25
6.9 EMERGENCY (CHANNEL 16 USE) .....	25
6.10 CALLING ANOTHER VESSEL (CHANNEL 16 OR 9) .....	26
6.11 MAKING TELEPHONE CALLS .....	27
6.12 OPERATING ON CHANNELS 13 AND 67 .....	27
6.13 PROHIBITED COMMUNICATIONS .....	27
6.14 DUAL WATCH (TO CH16) .....	27
6.15 MEMORY SCANNING (M-SCAN) .....	28
6.16 PRIORITY SCANNING (P-SCAN) .....	28
6.17 CHANNEL A/B INSTANT CALL .....	29
6.18 PA/FOG OPERATION .....	29
6.19 KEYPAD LOCKING .....	30
6.20 NAVIGATION INDICATION .....	31
6.21 INTERCOM OPERATION .....	31
6.22 VOICE SCRAMBLER .....	32
6.23 RESETTING THE TRANSCEIVER'S MICROPROCESSOR .....	32

# TABLE OF CONTENTS

<b>7</b>	<b>DIGITAL SELECTIVE CALLING</b>	<b>33</b>
7.1	GENERAL	33
7.2	DSC SCAN	33
7.3	USCG DSC WATCH	34
7.3.1	Maritime Mobile Service Identity (MMSI)	34
7.3.2	Programming the MMSI	34
7.4	ADDITIONAL DIGITAL SELECTIVE CALLING INFORMATION	35
7.5	DSC DISTRESS CALL	35
7.5.1	Transmitting a DSC Distress Call	35
7.5.2	Receiving a DSC Distress Call	36
7.6	ALL SHIPS CALL	37
7.6.1	Transmitting an All Ships Call	37
7.6.2	Receiving an All Ships Call	38
7.7	INDIVIDUAL CALL	38
7.7.1	Setting up the Individual / Position Call Directory	38
7.7.2	Setting up Individual Reply	39
7.7.3	Setting up Individual Call Ringer	40
7.7.4	Transmitting an Individual Call	40
7.7.5	Receiving an Individual Call	41
7.7.6	Setting Up the Call Waiting Function	41
7.8	ADVANCED DSC CALLS	42
7.8.1	Group Call	42
7.8.1.1	Setup a Group Call	42
7.8.1.2	Transmitting a Group Call	43
7.8.1.3	Receiving a Group Call	44
7.8.2	Position Request	44
7.8.2.1	Setting up Position Reply	45
7.8.2.2	Transmitting a Position Request to Another Vessel	45
7.8.2.3	Receiving a Position Request	46
7.8.3	Position Send	47
7.8.3.1	Transmitting a DSC Position Send Call	47
7.8.3.2	Receiving a DSC Position Send Call	47
<b>8</b>	<b>RADIO SETUP MODE</b>	<b>48</b>
8.1	LAMP ADJUSTING	48
8.2	LCD CONTRAST	48
8.3	TIME OFFSET	49
8.4	KEY BEEP (ON / OFF)	50
8.5	WX ALERT (ON / OFF)	50
8.6	VOICE SCRAMBLER	51
8.7	CHANNEL NAMING	52
8.8	TRUE MAGNETIC CHANGE (NAV display)	53
8.9	FOG ALERT TONE FREQUENCY	53
<b>9</b>	<b>RAM MIC OPERATION</b>	<b>54</b>
9.1	RAM MIC CONTROLS	54
9.2	INTERCOM OPERATION	57
9.2.1	Communication	57
9.2.2	Calling	57
9.3	DSC / RADIO SETUP MODE	58
<b>10</b>	<b>MAINTENANCE</b>	<b>59</b>
10.1	REPLACEMENT PARTS	59
10.2	FACTORY SERVICE	60
10.3	TROUBLESHOOTING CHART	60
<b>11</b>	<b>CHANNEL ASSIGNMENTS</b>	<b>61</b>
<b>12</b>	<b>WARRANTY</b>	<b>67</b>
<b>13</b>	<b>SPECIFICATIONS</b>	<b>70</b>

## SAFETY / WARNING INFORMATION

This radio is restricted to occupational use, work related operations only where the radio operator must have the knowledge to control the exposure conditions of its passengers and bystanders by maintaining the minimum separation distance of 0.6 m (2 feet).

Failure to observe these restrictions will result in exceeding the FCC RF exposure limits.

### Antenna Installation:

The antenna must be located at least 0.6 m (2 feet) away from passengers in order to comply with the FCC RF exposure requirements.

## ON-LINE WARRANTY REGISTRATION

Please visit [www.standardhorizon.com](http://www.standardhorizon.com) to register the **QUANTUM** Marine VHF. It should be noted that visiting the Web site from time to time may be beneficial to you, as new products are released they will appear on the STANDARD HORIZON Web site.

### PRODUCT SUPPORT INQUIRIES

If you have any questions or comments regarding the use of the **QUANTUM**, you can visit the STANDARD HORIZON Web site to send an E-Mail or contact the Product Support team at 800-767-2450 M-F 7:00-5:00PST.



## **FCC RADIO LICENSE INFORMATION**

Standard Horizon radios comply with the Federal Communication Commission (FCC) requirements that regulate the Maritime Radio Service.

### **STATION LICENSE**

An FCC ship station license is no longer required for any vessel traveling in U.S. waters (except Hawaii) which is under 20 meters in length. However, any vessel required to carry a marine radio on an international voyage, carrying a HF single side band radiotelephone or marine satellite terminal is required to have a ship station license. FCC license forms, including applications for ship (506) and land station licenses can be downloaded via the Internet at [www.fcc.gov/forms](http://www.fcc.gov/forms). To obtain a form from the FCC, call (888) 225-5322.

### **RADIO CALL SIGN**

Currently the FCC does not require recreational boaters to have a Ship Radio Station License. The USCG recommends the boats registration number and the state to be used.

### **CANADIAN SHIP STATION LICENSING**

You may need a license when traveling in Canada. If you do need a license contact their nearest field office or regional office or write:

**Industry Canada  
Radio Regulatory Branch  
Attn: DOSP  
300 Slater Street  
Ottawa, Ontario  
Canada, KIA 0C8**



## **FCC NOTICE**

### **NOTICE**

Unauthorized changes or modifications to this equipment may void compliance with FCC Rules. Any change or modification must be approved in writing by STANDARD HORIZON.

### **NOTICE**

This equipment has been tested and found to comply with the limits for a Class B digital device, pursuant to Part 15 of the FCC Rules. These limits are designed to provide reasonable protection against harmful interference in a residential installation. This equipment generates, uses and can radiate radio frequency energy and, if not installed and used in accordance with the instructions, may cause harmful interference to radio communications. However, there is no guarantee that interference will not occur in a particular installation. If this equipment does cause harmful interference to radio or television reception, which can be determined by turning the equipment off and on, the user is encouraged to try to correct the interference by one or more of the following measures:

- Reorient or relocate the receiving antenna.
- Increase the separation between the equipment and receiver.
- Connect the equipment into an outlet on a circuit different from that to which the receiver is connected.
- Consult the dealer or an experienced radio/TV technician for help.



## **GETTING STARTED**

### **ABOUT VHF RADIO**

The radio frequencies used in the VHF marine band lie between 156 and 158 MHz with some shore stations available between 161 and 163 MHz. The marine VHF band provides communications over distances that are essentially “line of sight” (VHF signals do not travel well through objects such as buildings, hills or trees). Actual transmission range depends much more on antenna type, gain and height than on the power output of the transmitter. On a fixed mount 25W radio transmission expected distances can be greater than 15 miles, for a portable 5W radio transmission the expected distance can be greater than 5 miles in “line of sight”.

### **SELECTING AN ANTENNA**

Marine antennas are made to radiate signals equally in all horizontal directions, but not straight up. The objective of a marine antenna is to enhance the signal toward the horizon. The degree to which this is accomplished is called the antenna’s gain. It is measured in decibels (dB) and is one of the major factors in choosing an antenna. In terms of effective radiated power (ERP), antennas are rated on the basis of how much gain they have over a theoretical antenna with zero gain. A 3 foot, 3dB gain antenna represents twice as much gain over the imaginary antenna.

Typically a 3 foot 3dB gain stainless steel whip is used on a sailboat mast. The longer 8 foot 6dB fiberglass whip is primarily used on power boats that require the additional gain.



## COAXIAL CABLE

VHF antennas are connected to the transceiver by means of a coaxial cable – a shielded transmission line. Coaxial cable is specified by its diameter and construction.

For runs less than 20 feet, RG-58/U, about 1/4 inch in diameter is a good choice. For runs over 20 feet but less than 50 feet, the larger RG-8X or RG-213/U should be used for cable runs over 50 feet RG-8X should be used. For installation of the connector onto the coaxial cable refer to the figure below.

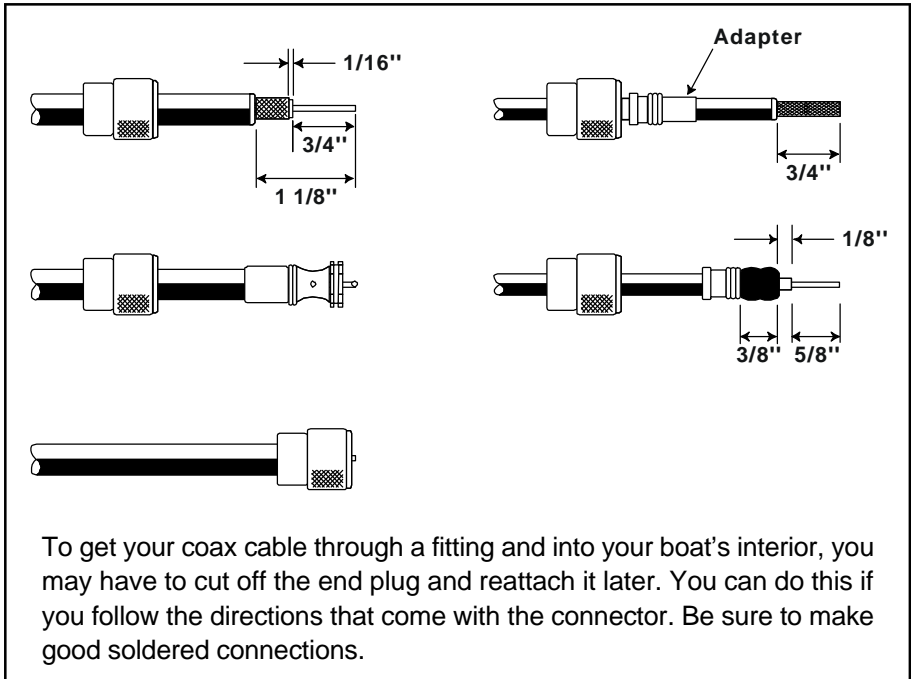



# 1 GENERAL INFORMATION

## 1.1 INTRODUCTION

The STANDARD HORIZON **QUANTUM** is a VHF/FM transceiver designed for use in the frequency range of 156.025 to 163.275 MHz. The **QUANTUM** can be operated from 11 to 16 VDC and has a switchable RF output power of 1 watt or 25 watts.

The **QUANTUM** is capable of RTCM SC101 DSC (Digital Selective Calling) operation and second station operation with the use of the improved optional RAM+ mic (**CMP25** remote-control speaker/microphone with display).

The **QUANTUM** operates on all currently-allocated marine channels which are switchable for use with USA, International, or Canadian regulations. It has an emergency channel 16 which can be immediately selected from any channel by pressing the red **[16/9]** key. NOAA Weather channels can also be accessed immediately by pressing the **[WX]** key with channel selection.

Other features of the transceiver include: scanning, priority scanning, submersible speaker mic, high and low voltage warning, and GPS repeatability.

## 1.2 FCC / INDUSTRY CANADA INFORMATION

The following data pertaining to the transceiver is necessary to fill out the license application.

Type Acceptance .....	FCC Part 80
Output Power .....	1 Watt (low) and 25 Watts (high)
Emission .....	16K0G3E, 16K0G2B
Frequency Range .....	156.025 to 163.275 MHz
FCC Type Number .....	K6630043X30
Industry Canada Type Approval .....	511B-30043X30

## 2 PACKING LIST

When the package containing the transceiver is first opened, please check it for the following contents:

- **GX2360S QUANTUM** Transceiver
- Mounting Bracket and attaching hardware
- Owner's Manual
- Quick-Reference Card
- Power Cord

## 3 OPTIONS

MMB-84 .....	Flush-Mount Bracket
CMP25B/W .....	Remote-Access Microphone (RAM+ Mic, Black/White)
CT-100 .....	10-foot Extension Cable for RAM+ Mic
CVS2500 .....	Voice Scrambler
101S .....	Mini Extension Speaker
201S .....	White Extension Speaker
201SZ .....	White Flush Mount Extension Speaker
201SBK .....	Black Extension Speaker
201SBKZ .....	Black Flush Mount Extension Speaker
220SW .....	4.5" Round Hail/PA Horn

## 4 INSTALLATION

### 4.1 LOCATION

The radio can be mounted at any angle. Choose a mounting location that:

- is far enough from any compass to avoid any deviation in compass reading due to the speaker magnet
- provides accessibility to the front panel controls
- allows connection to a power source and an antenna
- has nearby space for installation of a microphone hanger
- the antenna must be mounted at least 3 feet from radio

**Note:** To insure the radio does not affect the compass or radios performance is not affected by the antenna location, temporarily connect the radio in the desired location and:

- a. Examine the compass to see if the radio causes any deviation
- b. Connect the antenna and key the radio. Check to ensure the radio is operating correctly by requesting a radio check.

### 4.2 ELECTRICAL CONNECTIONS

#### CAUTION

**Reverse polarity connections will damage the radio!**

Connect the power cord and antenna to the radio. Antenna and Power Supply connections are as follows (see Figure 1):

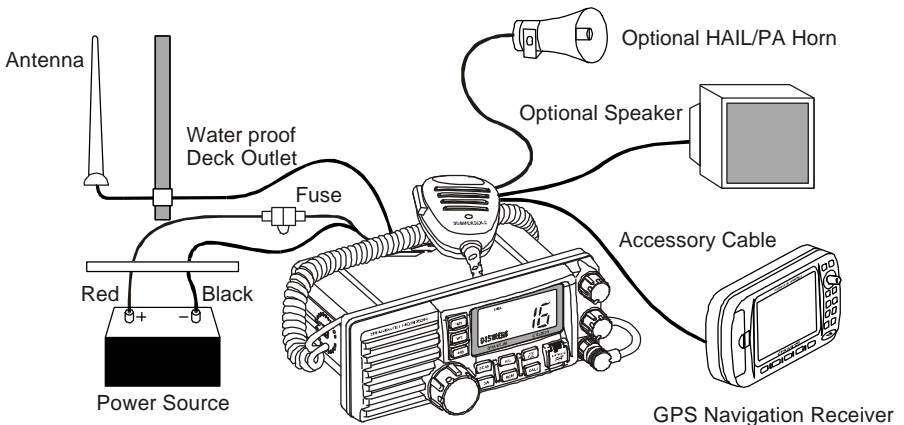

**Figure 1. General Installation**

1. Mount the antenna at least 3 feet away from the radio. At the rear of the radio, connect the antenna cable. It must have a PL259 connector. RG-8/U coaxial cable must be used if the antenna is 25 feet or more from the radio. RG58 cable can be used for distances less than 25 feet.

2. Connect the red power wire to a 13.8 VDC  $\pm 20\%$  power source. Connect the black power wire to a negative ground.
3. If an optional remote extension speaker is to be used, refer to section 3.3 for connections.
4. It is advisable to have a Certified Marine Technician check the power output and the standing wave ratio of the antenna after installation.

### 4.3 ACCESSORY CABLE

**White:** External speaker (+)

**Shield:** External speaker (-)

**Red:** PA speaker (+)

**Shield:** PA speaker (-)

**Blue:** NMEA IN (+) from GPS navigation receiver

**Green:** NMEA IN (-) from GPS navigation receiver

**Gray:** NMEA OUT (+) to GPS navigation receiver

**Brown:** Test port (for the Service Technician)

When connecting the external speaker or GPS navigation receiver, strip off about 1 inch (2.5 cm) of the specified wire's insulation, then splice the ends together.

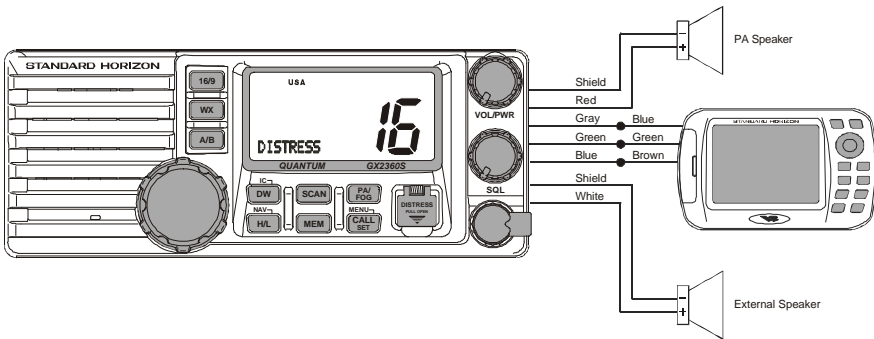

Wire Color/Description	Connection Examples
WHITE - External Speaker (+)	Connect to external 4 Ohm audio speaker
SHILED - External Speaker (-)	Connect to external 4 Ohm audio speaker
RED - PA Speaker (+)	Connect to external 4 Ohm PA speaker
SHILED - PA Speaker (-)	Connect to external 4 Ohm PA speaker
GREEN - NMEA Ground	Connect to NMEA (-) connection of GPS
BLUE- NMEA Input (+)	Connect to NMEA (+) output of GPS
GRAY-NMEA Output (+)	Connect to NMEA (+) input of GPS

## 4.4 CONNECTION OF GPS WITH NMEA OUTPUT

Manufacturer/Model	Wires	QUANTUM	Manufacturer/Model	Wires	QUANTUM
STANDARD HORIZON CP150, CP160 and CP-170C	Green	Green	Lowrance Portable	Orange	Blue
	Brown	Blue		Black (GND)	Green
Furuno GP30, 36	White	Blue	Magellan Fixed Mount	Gray	Blue
	Blue	Green		Black (GND)	Green
Furuno GP1650, 1850	White	Blue	Magellan Portable	Orange	Blue
	Black	Green		Black (GND)	Green
Garmin Fixed Mounts	Blue	Blue	Northstar	Yellow	Blue
	Black (GND)	Green		Black (GND)	Green
Garmin Portables	Brown	Blue	Raytheon 420	Yellow	Blue
	Black (GND)	Green		Brown	Green
JRC GPS500	Yellow	Blue	Raytheon 520 / 620	Blue	Blue
	Green	Green		Brown	Green
JRC 100 SERIES	Green	Blue	Raytheon RL SERIES	White	Blue
	Black	Green		Brown	Green
JRC 200 SERIES	White	Blue	Simrad	White	Blue
	Black	Green		Brown	Green
Lowrance Fixed Mount	White	Blue	Sitex Neptune, Nautilus	Gray	Blue
	Black (GND)	Green		Brown	Green

### Additional Information:

- The GPS must have the NMEA Output turned on and set to 4800 Baud in the setup menu. If there is a selection for parity select none.
- For further information on interfacing /setting up your GPS. Please contact the manufacturer of the GPS receiver.
- **QUANTUM** can read NMEA-0183 version 2.0 or higher.
- The NMEA supported sentences are:
  - GLL, GGA, RMC and GNS (RMC sentence is recommended)

If you have further inquires, please feel free to contact Product Support at:

Phone: (800) 767-2450

Email: [marinetech@vxstdusa.com](mailto:marinetech@vxstdusa.com)



## 4.5 CHECKING GPS CONNECTIONS

After connections have been made between the **QUANTUM** and the GPS, a small satellite icon will appear on the top right corner of the LCD display. To see additional GPS information press and hold the [H/L(NAV)] key until the **QUANTUM** shows the Date, Time, SOG and COG.

## 4.6 CHANGING THE GPS TIME

From the Factory the **QUANTUM** shows GPS satellite time or UTC time. A time offset is needed to offset this time to show the local time in your area.

1. Press and hold down the [CALL/SET(MENU)] key until “RADIO SETUP” menu appears.
2. Press the [CALL/SET(MENU)] key, then select “TIME SET” with the CHANNEL selector knob.
3. Press the [CALL/SET(MENU)] key.
4. Turn the CHANNEL selector knob to select time offset from UTC. See illustration below to find your offset time from UTC. If “0:00” is assigned, the time is the same as UTC (Universal Time Coordinated or GMT Greenwich Mean Time).
5. Press the [CALL/SET(MENU)] key to store the time offset.
6. Press the [16/9] key or turn the CHANNEL selector knob to select “EXIT,” then press the [CALL/SET(MENU)] key to return to the “RADIO SETUP” menu, select “EXIT” and press the [CALL/SET(MENU)] key to return to radio operation.

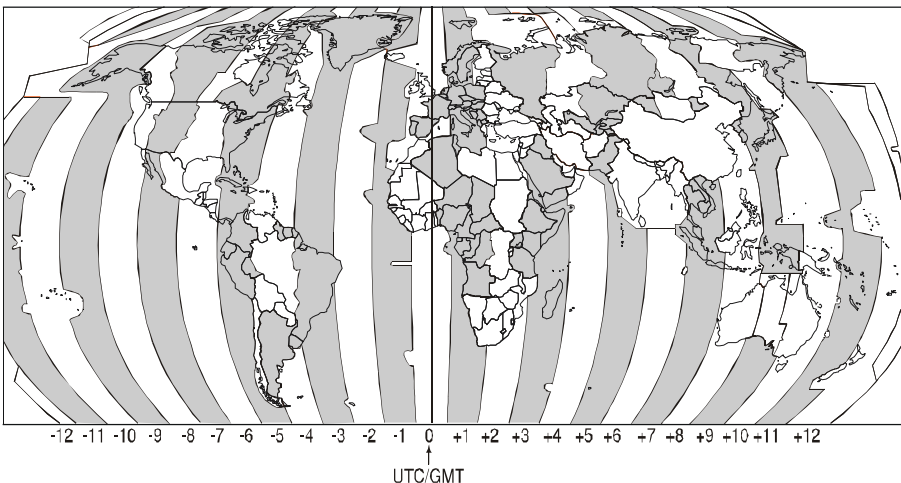

**OFFSET TIME TABLE**

## 4.7 CHANGING COG TO TRUE OR MAGNETIC

Allows customizing the NAV data showing GPS Course Over Ground (COG). Factory default is True however following the steps below the COG can be changed to Magnetic.

1. Press and hold down the [**CALL/SET(MENU)**] key until “RADIO SETUP” menu appears.
2. Press the [**CALL/SET(MENU)**] key, then select “TRUE MAG” in the “RADIO SETUP” menu with the **CHANNEL** selector knob.
3. Press the [**CALL/SET(MENU)**] key.
4. Turn the **CHANNEL** selector knob to select “MAGNETIC” or “TRUE.”
5. Press the [**CALL/SET(MENU)**] key to store the selected setting.
6. Turn the **CHANNEL** selector knob to select “EXIT,” then press the [**CALL/SET(MENU)**] key to return to the “RADIO SETUP” menu, select “EXIT” and press the [**CALL/SET(MENU)**] key to return to radio operation.



## 4.8 OPTIONAL MMB-84 FLUSH MOUNT INSTALLATION

1. Make a rectangular template for the flush mount measuring 2-5/8" H x 6-5/8" W.
2. Use the template to mark the location where the rectangular hole is to be cut. Confirm the space behind the dash or panel is deep enough to accommodate the transceiver (at least 6 inches deep).  
There should be at least 1/2 inch between the transceiver's heatsink and any wiring, cables or structures.
3. Cut out the rectangular hole and insert the transceiver.
4. Fasten the brackets to the sides of the transceiver with the lock washer nut combination; so that the mounting screw base faces the mounting surface (see Figure 2).
5. Turn the adjusting screw to adjust the tension so that the transceiver is tight against the mounting surface.

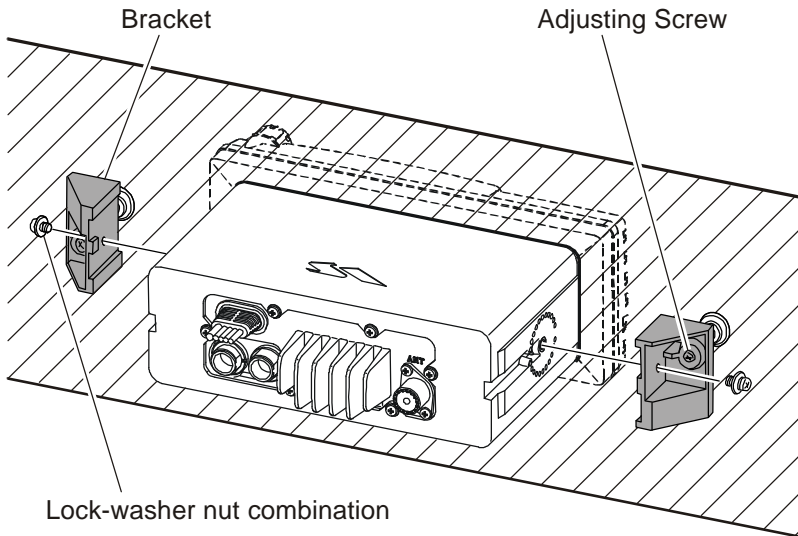
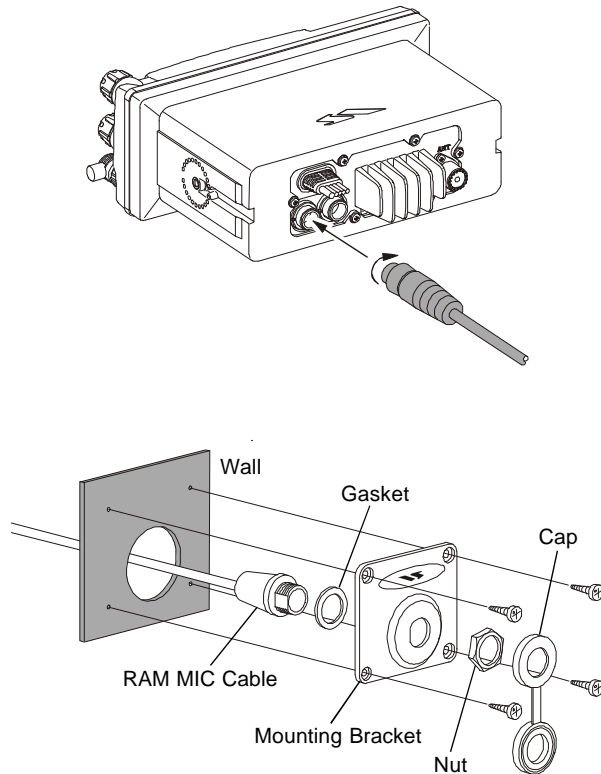

**Figure 2. MMB-84 Flush Mount Installation**



## 4.9 OPTIONAL CMP25 RAM+ MIC INSTALLATION

1. Connect the RAM+ MIC Cable to the **RAM MIC CONNECTOR** on the rear panel, then tighten the Cable Nut (See Figure 3).
2. Referring to Figure 3, make a 1.2" (30 mm) hole in the wall, then insert the RAM+ MIC Cable into this hole. Connect the Gasket and Mount Base to the RAM+ MIC Cable Connector using the Nut.
3. Drill the four Screw holes (approx. 2 mm) on the wall, then install the Mounting Base to the wall using four screws.
4. Put the Rubber Cap on to the Nut. The installation is now completed.



**Figure 3. CMP25 RAM+ MIC Installation**

## 5 CONTROLS AND INDICATORS

### NOTE

This section defines each control of the transceiver. See Figure 4 for location of controls. For detailed operating instructions refer to chapter 6 of this manual.

### 5.1 CONTROLS AND CONNECTIONS

#### ① POWER SWITCH/VOLUME CONTROL (VOL/PWR)

Turns the transceiver on and off as well as adjusts the audio volume. To turn the transceiver on press and hold this knob until the LCD turns on. To turn it off, press and hold this knob until the LCD turns off. When the power is turned on, the transceiver is set to the last selected channel.

#### **Secondary Use**

When the transceiver is turned on while the [SCAN] and [WX] keys are held down, the internal microprocessor is reset. This clears the memory and all user-programmed settings, such as scan memory, and priority scan assignments. This condition is known as the default condition, the same as when shipped from the factory. For a list of these defaults, see the section 6.18 Resetting the Transceiver's Microprocessor.

### NOTE

Resetting the microprocess **will not erase** the DSC MMSI and the Individual Directory Call information.

#### ② SQUELCH CONTROL (SQL)

Adjusting this control clockwise, sets the point at which random noise on the channel does not activate the audio circuits but a received signal does. This point is called the squelch threshold. Further adjustment of the squelch control will degrade reception of wanted transmissions.

#### ③ [DISTRESS] Key

Used to send a DSC Distress Call. To send the distress call refer to section 7.5.1 (Transmitting A DSC Distress Call).

#### ④ KEYPAD

##### [16/9] Key

Immediately recalls channel 16 from any channel location. Holding down this key recalls channel 9. Pressing the [16/9] key again reverts to the previous selected working channel.

##### **Secondary use**

Press and hold the [16/9] key then press the [WX] key to switch between USA, International and Canadian bands.



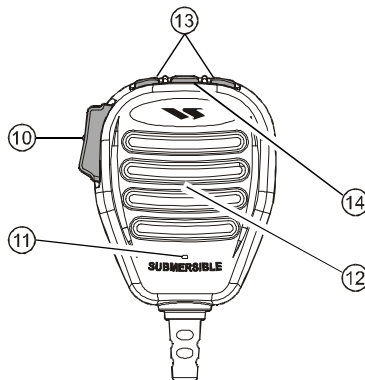
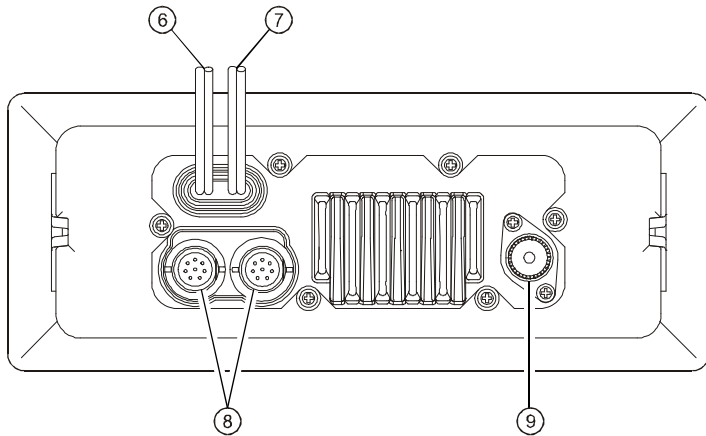
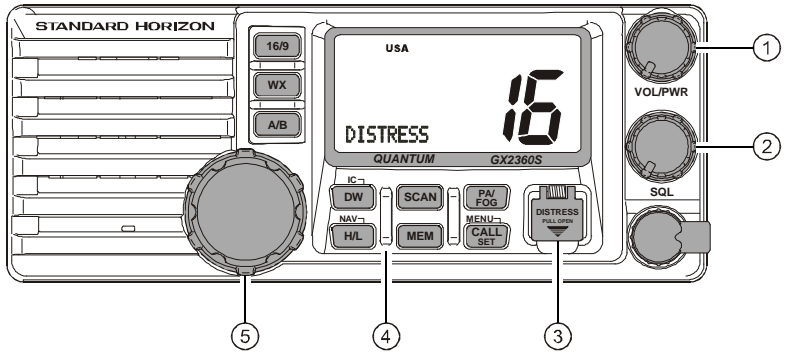

**Figure 4. Controls and Connectors**

### [WX] Key

Immediately recalls the previously selected NOAA weather channel from any channel.

#### **Secondary use**

1. Holding down the [16/9] key while pressing the [WX] key changes the mode from USA to International or Canadian.
2. Holding down the [WX] and [SCAN] key while turning the power on resets the microprocessor and erases scan channels from memory. This clears the memory and establishes the factory-set defaults. For a list of these defaults, see the section on 6.19 Resetting the Transceiver's Microprocessor.

### [A/B] Key

Immediately recalls two user assigned channels from any channel.

### [DW(IC)] Key

Scans for voice communications on CH16 and another selected channel until a signal is received on either channel. (Dual watch)

**NOTE:** When the DSC SCANNING feature is enabled (see section 7.2 DSC SCAN), the radio watches for a transmission on CH16, another selected channel, and **CH70** until a signal is received (Triple watch).

#### **Secondary use**

Press and hold [DW(IC)] key, when the optional RAM+ Mic is connected, intercom operation will operate between radio and RAM+ Mic.

### [H/L(NAV)] Key

Toggles between 25 W (High) and 1 W (Low) power. When the [H/L(NAV)] key is pressed while the transceiver is on channel 13 or 67, the power will temporarily switch from LO to HI power until the PTT is released. The [H/L(NAV)] key does not function on transmit inhibited and low power only channels.

#### **Secondary use**

Press and hold [H/L(NAV)] key, the LCD displays NAV GPS Data, Time, SOG (Speed Over Ground), and COG (Course Over Ground) when a GPS is connected to the accessory cable of the **QUANTUM**. See section 4.4 CONNECTION OF GPS WITH NMEA OUTPUT.

### [SCAN] Key

1. Starts and stops scanning of programmed channels.
2. If held while the [UP(▲)] or [DOWN(▼)] key on the microphone are pressed or **CHANNEL** selector knob on radio is turned, the radio will show the channels programmed in scan memory. This function will not work if the unit is scanning.

**NOTE:** The priority channel is channel 16 only.

- Pressing and holding again will delete the channel from scan memory.

### [MEM] Key

Memorizes the selected channel into the transceivers scan memory for scanning. When pressed again, it DELETES the channel from the scan memory.

#### Secondary use

Press and hold [MEM] key to lock out the front panel keys and **CHANNEL** selector knob. Press and hold [MEM] key again, unlock the front panel keys (except [16/9] and [DISTRESS] keys) and **CHANNEL** selector knob.

### [PA/FOG] Key

Available to operate the PA dfunction or the FOG HORN function.

### [CALL/SET(MENU)] Key

The [CALL/SET(MENU)] key functions as the enter key.

#### Secondary use

Press the [CALL/SET(MENU)] key to access the DSC OPERATION menu. The "INDIVIDUAL CALL," "GROUP CALL," "ALL SHIPS CALL," "POSITION REQUEST," "POSITION SEND," "STANDBY MODE," and "CALL WAITING" functions can be accessed from the DSC OPERATION menu.

Press and hold the [CALL/SET(MENU)] key to access the RADIO SETUP or DSC SETUP menu. The following functions can be accessed in the menu (refer to Section7).

#### RADIO SETUP-menu

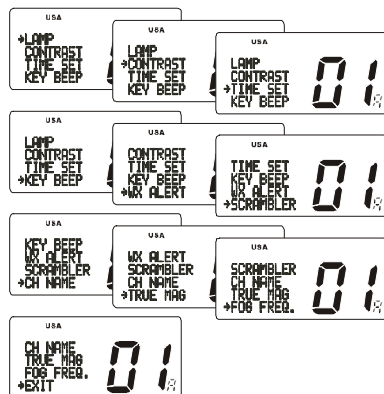

#### DSC SETUP-menu

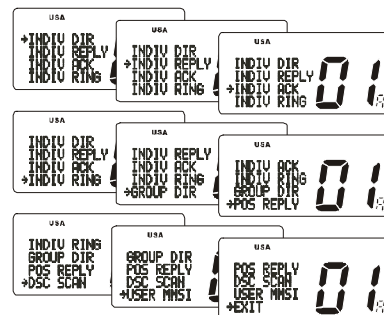

⑤ **CHANNEL SELECTOR KNOB**

Rotary knob used to select channels and to choose menu items (such as the DSC menu, radio setup and DSC setup menu). The **[UP(▲)]** / **[DOWN(▼)]** key on the microphone can also be used to select channels and menu items.

**Secondary Use**

- While holding down the **[SCAN]** key and turning the **CHANNEL** selector knob, you can confirm memory channels for scanning.
- Adjust the audio output level while in the PA/FOG mode.

⑥ **ACCESSORY CONNECTION CABLE**

Connects the **QUANTUM** to a GPS, and an external speaker. See section 3 OPTIONS for a list of speakers STANDARD HORIZON offers.

⑦ **DC INPUT CABLE**

Connects the radio to a DC power supply capable of delivering 12V DC.

⑧ **RAM MIC CONNECTORS**

Connects the **QUANTUM** to the enhanced RAM+ MIC (Remote Access Microphone). Refer to section 9 RAM+ MIC OPERATION.

⑨ **ANTENNA JACK**

Connects an antenna to the transceiver. Use a marine VHF antenna with an impedance of 50 ohms.

⑩ **PTT (Push-To-Talk) SWITCH**

Keys the transmitter when the transceiver is in radio mode. If the transceiver is in the intercom operation mode (between the RAM+ and the **QUANTUM**), it activates the **QUANTUM** microphone for voice communications.

⑪ **MICROPHONE**

Transmits the voice message with reduction of background noise.

⑫ **MICROPHONE SPEAKER**

The same audio heard through internal radio speaker is heard through microphone speaker.

⑬ **[UP(▲)] / [DOWN(▼)] KEYS**

The **[UP(▲)]** and **[DOWN(▼)]** on the microphone function the same as the **CHANNEL** selector knob on the front panel of the transceiver.

⑭ **[16/9] Key**

Pressing the **[16/9]** key immediately recalls channel 16 from any location. Press and hold the **[16/9]** key to recall channel 9. Pressing the **[16/9]** key again will revert the radio to the previous selected channel.



## 6 BASIC OPERATION

### 6.1 RECEPTION

1. After the transceiver has been installed, ensure that the power supply and antenna are properly connected.
2. Press and hold the **VOL/PWR** knob until the radio turns on.
3. Turn the **SQL** knob fully counterclockwise. This state is known as “squelch off”.
4. Turn up the **VOL/PWR** knob until noise or audio from the speaker is at a comfortable level.
5. Turn the **SQL** knob clockwise until the random noise disappears. This state is known as the “squelch threshold.”
6. Turn the **CHANNEL** selector knob to select the desired channel. Refer to the channel chart on page 62 for available channels.
7. When a message is received, adjust the volume to the desired listening level. The “**BUSY**” indicator in the LCD is displayed indicating that the channel is being used.

### 6.2 TRANSMISSION

1. Perform steps 1 through 6 of RECEPTION.
2. Before transmitting, monitor the channel to ensure it is clear.  
**THIS IS AN FCC REQUIREMENT!**
3. Press the **PTT** (push-to-talk) switch. The “**TX**” indicator on the LCD is displayed.
4. Speak slowly and clearly into the microphone.
5. When the transmission is finished, release the **PTT** switch.

#### NOTE

This is a noise-canceling microphone. The oval slot on the bottom of microphone should be positioned within 1 inch (2.5 cm) from the mouth for optimum performance.

### 6.3 TRANSMIT TIME - OUT TIMER (TOT)

When the **PTT** switch on the microphone is held down, transmit time is limited to 5 minutes. This limits unintentional transmissions due to a stuck microphone. About 10 seconds before automatic transmitter shutdown, a warning beep will be heard from the speaker(s). The transceiver will automatically go to receive mode, even if the **PTT** switch is continually held down. Before transmitting again, the **PTT** switch must first be released and then pressed again.

## 6.4 SIMPLEX/DUPLEX CHANNEL USE

Refer to the VHF MARINE CHANNEL CHART (page 63) for instructions on use of simplex and duplex channels.

### NOTE

All channels are factory-programmed in accordance with FCC (USA), Industry Canada (Canada), and International regulations. Mode of operation cannot be altered from simplex to duplex or vice-versa.

## 6.5 USA, CANADA, AND INTERNATIONAL MODE

1. To change the modes, hold the [**16/9**] key and press the [**WX**] key. The mode changes from USA to International to Canadian with each press of the [**WX**] key.
2. “**USA**” will be displayed on the LCD for USA mode, “**INTL**” will be displayed for International mode, and “**CAN**” will be displayed for Canadian mode.
3. Refer to the VHF MARINE CHANNEL CHART (page 63) for allocated channels in each mode.

## 6.6 NOAA WEATHER CHANNELS

1. To receive a NOAA weather channel, press the [**WX**] key from any channel. The transceiver will go to the last selected weather channel.
2. Turn the **CHANNEL** selector knob on the radio or [**UP(▲)**] / [**DOWN(▼)**] keys on the microphone to select a different NOAA weather channel.
3. To exit from the NOAA weather channels, press the [**WX**] key. The transceiver returns to the channel it was on prior to a weather channel.

## 6.7 NOAA WEATHER ALERT

In the event of extreme weather disturbances, such as storms and hurricanes, the NOAA (National Oceanic and Atmospheric Administration) sends a weather alert accompanied by a 1050 Hz tone and subsequent weather report on one of the NOAA weather channels. When the Weather Alert feature is enabled (see section 8.5 WX ALERT), the transceiver is capable of receiving this alert if the following is performed:

1. Program NOAA weather channels into the transceiver’s memory for scanning. Follow the same procedure as for regular channels under section 6.15.
2. Press the [**SCAN**] key once to start memory scanning or hold down the [**SCAN**] key during memory scanning to start priority scanning.
3. The programmed NOAA weather channels will be scanned along with the regular-programmed channels. However, scanning will not stop on a normal weather broadcast unless a NOAA alert is received.





4. When an alert is received on a NOAA weather channel, scanning will stop and the transceiver will emit a loud beep to alert the user of a NOAA broadcast.
5. Press the [WX] key to stop the alert tone and receive the weather report.

#### NOTE

If the [WX] key is not pressed the alert tone will be emitted for 5 minutes and then the weather report will be received.

#### NOTE

The Weather Alert feature is also engaged while the transceiver is receiving on one of the NOAA weather channels.

## 6.8 NOAA WEATHER ALERT TESTING

In the event of a major storm or other appreciable weather condition requiring vessels at sea or other bodies of water to be notified, the NOAA (National Oceanographic and Atmospheric Administration) broadcasts a 1050 Hz tone that some marine VHF radios can detect. (Refer to Section 6.7 “NOAA WEATHER ALERT” on how to use this feature.) This tone, when detected, will produce a loud beep from the radio speaker to signal that a weather alert is being broadcast.

In order to test this system, the NOAA broadcasts the 1050 Hz tone every Wednesday, sometime between 11 AM and 1 PM.

## 6.9 EMERGENCY (CHANNEL 16 USE)

Channel 16 is known as the Hail and Distress Channel. An emergency may be defined as a threat to life or property. In such instances, be sure the transceiver is on and set to CHANNEL 16. Then use the following procedure:

1. Press the microphone push-to-talk switch and say “**Mayday, Mayday, Mayday**. This is \_\_ , \_\_ , \_\_ ” (your vessel’s name).
2. Then repeat once: “**Mayday, \_\_** ” (your vessel’s name).
3. Now report your position in latitude/longitude, or by giving a true or magnetic bearing (state which) to a well-known landmark such as a navigation aid or geographic feature such as an island or harbor entry.
4. Explain the nature of your distress (sinking, collision, aground, fire, heart attack, life-threatening injury, etc.).
5. State the kind of assistance your desire (pumps, medical aid, etc.).
6. Report the number of persons aboard and condition of any injured.
7. Estimate the present seaworthiness and condition of your vessel.
8. Give your vessel’s description: length, design (power or sail), color and other distinguishing marks. The total transmission should not exceed 1 minute.



9. End the message by saying "**OVER**". Release the microphone button and listen.
10. If there is no answer, repeat the above procedure. If there is still no response, try another channel.

## **6.10 CALLING ANOTHER VESSEL (CHANNEL 16 OR 9)**

Channel 16 may be used for initial contact (hailing) with another vessel. However, its most important use is for emergency messages. This channel must be monitored at all times except when actually using another channel.

It is monitored by the U.S. and Canadian Coast Guards and by other vessels. **Use of channel 16 for hailing must be limited to initial contact only.** Calling should not exceed 30 seconds, but may be repeated 3 times at 2-minute intervals. In areas of heavy radio traffic, congestion on channel 16 resulting from its use as a hailing channel can be reduced significantly in U.S. waters by using **channel 9** as the initial contact (hailing) channel for non-emergency communications. Here, also, calling time should not exceed 30 seconds but may be repeated 3 times at 2-minute intervals.

Prior to making contact with another vessel, refer to the channel charts in this manual, and select an appropriate channel for communications after initial contact. For example, Channels 68 and 69 of the U.S. VHF Charts are some of the channels available to non-commercial (recreational) boaters. Monitor your desired channel in advance to make sure you will not be interrupting other traffic, and then go back to either channel 16 or 9 for your initial contact.

When the hailing channel (16 or 9) is clear, state the name of the other vessel you wish to call and then "**this is**" followed by the name of your vessel and your Station License (Call Sign). When the other vessel returns your call, immediately request another channel by saying "**go to**," the number of the other channel, and "over." Then switch to the new channel. When the new channel is not busy, call the other vessel.

After a transmission, say "**over**," and release the microphone's push-to-talk (PTT) switch. When all communication with the other vessel is completed, end the last transmission by stating your Call Sign and the word "**out**." Note that it is not necessary to state your Call Sign with each transmission, only at the beginning and end of the contact.

Remember to return to Channel 16 when not using another channel. Some radios automatically monitor Channel 16 even when set to other channels or when scanning.



## 6.11 MAKING TELEPHONE CALLS

To make a radiotelephone call, use a channel designated for this purpose. The fastest way to learn which channels are used for radiotelephone traffic is to ask at a local marina. Channels available for such traffic are designated **Public Correspondence** channels on the channel charts in this manual. Some examples for USA use are Channels 24, 25, 26, 27, 28, 84, 85, 86, and 87. Call the marine operator and identify yourself by your vessel's name. The marine operator will then ask you how you will pay for the call (telephone credit card, collect, etc.) and then link your radio transmission to the telephone lines.

The marine telephone company managing the VHF channel you are using may charge a link-up fee in addition to the cost of the call.

## 6.12 OPERATING ON CHANNELS 13 AND 67

Channel 13 is used at docks and bridges and by vessels maneuvering in port. Messages on this channel must concern navigation only, such as meeting and passing in restricted waters.

Channel 67 is used for navigational traffic between vessels.

By regulation, power is normally limited to 1 Watt on these channels. Your radio is programmed to automatically reduce power to this limit on these channels. However, in certain situations it may be necessary to temporarily use a higher power. See page 20 (H/L key) for means to temporarily override the low-power limit on these two channels.

## 6.13 PROHIBITED COMMUNICATIONS

The FCC prohibits the following communications:

- False distress or emergency messages;
- Messages to “any boat” except in emergencies and radio tests;
- Messages to or from a vessel on land;
- Transmission while on land;
- Obscene, indecent, or profane language (potential fine of \$10,000).

## 6.14 DUAL WATCH (TO CH16)

1. Adjust the **SQL** knob until the background noise disappears.
2. Select the channel you wish to dual watch to CH16.
3. Press the **[DW(IC)]** key. The display will scan between CH16 and the channel that was selected in step 2.

If a transmission is received on the channel selected in step 2, the **QUANTUM** will dual watch to CH16.

4. To stop Dual Watch press the **[DW(IC)]** key again.



## 6.15 MEMORY SCANNING (M-SCAN)

### NOTE

During scanning, the dot matrix area of the LCD will show “**M-SCAN**” or “**P-SCAN**” depending on the scan mode selected.

1. Adjust the **SQL** knob until background noise disappears.
2. Select a desired channel to be scanned using the **CHANNEL** selector knob. Press and hold the [**SCAN**] key, “**MEM**” will appear on the LCD which indicates the channel has been programmed into the transceivers memory.
3. Repeat step 2 for all the desired channels to be scanned.
4. To **DELETE** a channel from the transceiver’s memory, select the channel then press and hold the [**SCAN**] key, “**MEM**” will disappear in the LCD.
5. To start scanning, press the [**SCAN**] key. Scanning will proceed from the lowest to the highest programmed channel number and will stop on a channel when a transmission is received.
6. The channel number will blink during reception.
7. To stop scanning, press the [**SCAN**], [**16/9**], [**WX**], [**CALL/SET(MENU)**], or **PTT** key.



## 6.16 PRIORITY SCANNING (P-SCAN)

1. Channel 16 is set as the priority channel and cannot be changed.
2. To select priority scanning, press the [**SCAN**] key to start memory scanning (“**M-SCAN**” will appears), then press and hold down the [**SCAN**] key until “**P-SCAN**” appears on the LCD. Scanning will proceed between the memorized channels and the priority channel. CH 16 the priority channel will be scanned after each programmed channel.

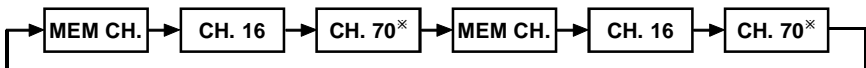

3. To stop scanning, press the [**SCAN**], [**16/9**], [**WX**], [**CALL/SET(MENU)**], or **PTT** key.



### NOTE

Triple watch (T/W) means the radio is watching CH70 for DSC Calls.  
Dual watch (D/W) means the radio is not watching CH70 for DSC Calls.

## 6.17 CHANNEL A /B INSTANT CALL

Two calling channels (used by an organization or a favorite channel) can be preset. But USA channels 9 and 16, and WX channels should not be assigned as A or B channels because they are readily available with the [16/9] and [WX] keys. If the [A/B] key is pressed and no channel A or B has been assigned, the alert signal will be present.

### 6.17.1 Storing new channel A/B

1. Press and hold down the [A/B] key and rotate the **CHANNEL** Selector knob to select the desired channel.
2. Release the [A/B] key to store a desired channel as channel A/B.
3. Repeat steps to program second channel A/B.

### 6.17.2 Changing the stored channel A/B

1. Press the [A/B] key for memorized channel to appear.
2. Press and hold down the [A/B] key and rotate the Channel Selector knob to select the desired channel.
3. Release the [A/B] key to store a desired channel as channel A/B.

#### NOTE

The stored channels will delete in microprocessor resetting mode only.

### 6.17.3 Operating the channel A/B

Pressing the [A/B] key more than once toggles between channel A, channel B and the channel that was received on.



## 6.18 PA/FOG OPERATION

### PA HAIL mode:

**PA HAIL** mode allows the transceiver to be used as a power hailer when an optional 4 ohm HAIL/PA speaker is installed. The Hail mode has a listen-back feature which provides two way communication through the HAIL/PA speaker.

### FOG HORN mode:

Automatic signaling is transmitted through the HAIL/PA speaker.

### 6.18.1 Operating the PA HAIL mode

1. Press the [PA/FOG] key, then select "PA" with the **CHANNEL** selector knob.
2. Press the [CALL(MENU)] key.
3. Press the **PTT** switch to speak through the



HAIL/PAspeaker.

Rotate the **CHANNEL** selector knob to control the AF output level. The AF output level can be set from 0 to 30 watts.

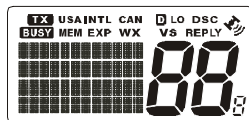

- To exit the PA HAIL mode, press the [16/9], [WX] or [CALL/SET(MENU)] key.

### 6.18.2 Operating the FOG HORN mode

Operator can select from FOG 1, FOG 2, FOG 3, FOG 4, HORN, SIREN, AGROUND, or ANCHOR.

FOG 1: POWER BOAT UNDERWAY

FOG 2: POWER BOAT STOPPED

FOG 3: SAIL BOAT, FISH VESSEL, TOW VESSEL

FOG 4: VESSEL UNDER TOW

- Press the [PA/FOG] key, then select "FOG" with the **CHANNEL** selector knob.
- Press the [CALL/SET(MENU)] key.
- Turn the **CHANNEL** selector knob to select the function.
- Press the [CALL/SET(MENU)] key.
- On the HORN and SIREN modes, press the **PTT** switch to activate the tone through the HAIL/PA speaker.



Rotate the **CHANNEL** selector knob to control the AF output level. The AF output level can be set from 0 to 30 watts.

- To exit the FOG HORN mode, press the [16/9], [WX] or [CALL/SET(MENU)] key.

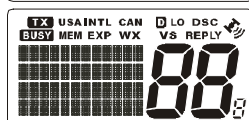

### 6.19 KEYPAD LOCKING

To order to prevent accidental frequency change, front panel keys (except [DISTRESS], [16/9] and [CALL/SET(MENU)] key) and **CHANNEL** selector knob may be locked out.

Press and hold [MEM] key to lock out the front panel keys and **CHANNEL** selector knob. Press and hold [MEM] key again, unlock the front panel keys and **CHANNEL** selector knob.

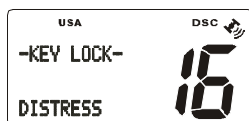

## 6.20 NAVIGATION INDICATION

The transceiver has the ability to display the time, SOG and COG date, as well as the vessel's position (LAT/LON), when connected to a GPS receiver.

1. Press and hold the [H/L(NAV)] key to display position information. If the GPS receiver is not receiving a fix, the display will be as shown in the illustration on the right.
2. To hide the position information, press the [H/L(NAV)] key.

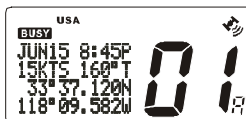

## 6.21 INTERCOM OPERATION

If the RAM+ Mic is connected to the **QUANTUM**, you may communicate between the **QUANTUM** and RAM+ Mic, or RAM+ Mic and RAM+ Mic (See page 57 for Intercom Operation of the RAM+ Mic).

### 6.22.1 Communication

1. Press and hold the [DW(IC)] key while in the "RADIO" mode, the mode is changed to "INTERCOM" mode.
2. If your **QUANTUM** is equipped two RAM+ Mic, select the companion you wish to communicate (RAM1, RAM2, or ALL) with the **CHANNEL** selector knob, then press the [CALL/SET(MENU)] key to terminated.



2. When the "INTERCOM" operation is activated, "INTERCOM" is displayed on the **QUANTUM**, and "IC" is displayed on the RAM+ Mic.
3. Press the **PTT** switch. The "TALK" is displayed.



(MATRIX's PTT switch is pressed)

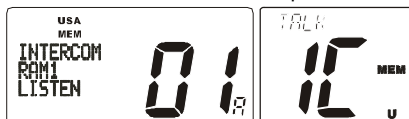

(RAM+ Mic's PTT switch is pressed)

**NOTE:** A warning beep is emitted when the **QUANTUM** microphone's **PTT** switch is pressed while the RAM+ Mic's **PTT** switch is pressed.

4. Speak slowly and clearly into the microphone, hold the microphone about 1/2 inch away from your mouth.
5. When finished, release the **PTT** switch.
6. Press and hold the [DW(IC)] key again the mode will revert to "RADIO" mode.

## 6.22.2 Calling

Hold down the [DW(IC)] key for 1 second or more, when the “INTERCOM” operation is activated. A calling beep is emitted twice from the transceiver speaker.

### NOTE

Disable any operation of the **QUANTUM**, when communicate the both RAM+ Mic while “INTERCOM” mode.



## 6.22 VOICE SCRAMBLER

If privacy of communications is desired, a **CVS2500** voice scrambler (VS) can be installed in the transceiver. Contact your Dealer to have a **CVS2500** installed. Refer to the section 8.9 VOICE SCRAMBLER to program the voice scrambler.

1. Turn on the transceiver.
2. Select a channel that was programmed for scrambler mode (“**VS**” will appear on the LCD).
  - If a channel is not set for the voice scrambler, the display will be as shown in the illustration at the right (“**VS**” will disappear from the LCD).
  - If a voice scrambler is canceled temporarily in the “SETUP” menu, the display will be as shown in the illustration at the right.
3. Monitor the channel before transmitting.
4. Transmit the voice message. The signal sent will be scrambled.

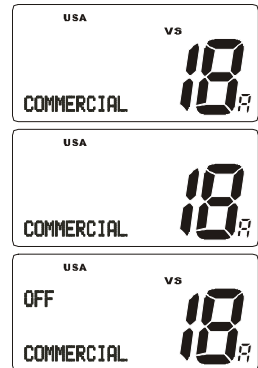

## 6.23 RESETTING THE TRANSCEIVER’S MICROPROCESSOR

Resetting the microprocessor restores the initial, factory supplied conditions in the transceiver. These are called the default conditions.

To reset the microprocessor, first turn the transceiver off. Then while pressing the [WX] and [SCAN] keys, turn the transceiver on. The default conditions are:

- No channels in the SCAN memory.
- Channel 16 will be selected when the transceiver is turned on.
- WX channel 01 will be recalled when the [WX] key is pressed.
- Key beep will be on.

### NOTE

Resetting the microprocessor will not erase DSC MMSI and Directory Call Waiting information.





## 7 DIGITAL SELECTIVE CALLING

### 7.1 GENERAL

#### WARNING

This radio is designed to generate a digital maritime distress and safety call to facilitate search and rescue. To be effective as a safety device, this equipment must be used only within communication range of a shore-based VHF marine channel 70 distress and safety watch system. The range of signal may vary but under normal conditions should be approximately 20 nautical miles.

Digital Selective Calling is a semi-automated method of establishing a radio call, it has been designated by the International Maritime Organization (IMO) as an international standard for establishing VHF, MF and HF radio calls. It has also been designated as part of the Global Maritime Distress and Safety System (GMDSS). It is planned that DSC will eventually replace aural watches on distress frequencies and will be used to announce routine and urgent maritime safety information broadcasts.

This new system allows mariners to instantly send a distress call with GPS position (when connected to the transceiver) to the US Coast Guard and other vessels within range of the transmission. DSC will also allow mariners to initiate or receive Distress, Urgency, Safety, Routine, POSITION REQUEST, POSITION SEND, and Group calls to or from another vessel equipped with a DSC transceiver.

### 7.2 DSC SCAN

When the radio is shipped from the factory it is programmed so CH70 (the DSC channel) is scanned at all times. A selection is provided in the SETUP MENU to disable the DSC SCAN. Turning off DSC SCAN will disable the radio from receiving DSC calls (i.e.: Distress Call, Individual Call, All Ships Call, and Position Requests). If you want to use any of the functions the selection must be left ON.

To Change DSC SCAN Method:

1. Press and hold down the [**CALL/SET(MENU)**] key until "RADIO SETUP" menu appears.
2. Turn the **CHANNEL** selector knob to select "DSC SETUP" menu.
3. Press the [**CALL/SET(MENU)**] key, then select "DSC SCAN" with the **CHANNEL** selector knob.
4. Press the [**CALL/SET(MENU)**] key.



5. Turn the **CHANNEL** selector knob to select “ON” or “OFF.”
6. Press the [**CALL/SET(MENU)**] key to store the selected setting.
7. To exit this menu and return to radio operation mode press the [**16/9**] key.

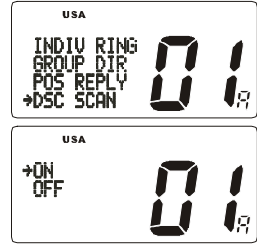

## 7.3 USCG DSC WATCH

The USCG has plans to upgrade its VHF National Distress System (expected by 2005), so at the time of printing only larger vessels that are required to carry VHF DSC radios will be able to hear your distress transmission.

### 7.3.1 Maritime Mobile Service Identity (MMSI)

#### What is an MMSI?

An MMSI is a nine digit number used on Marine Transceivers capable of using Digital Selective Calling (DSC). This number is used like a telephone number to selectively call other vessels.

**THIS NUMBER MUST BE PROGRAMMED INTO THE RADIO TO OPERATE THE MATRIX DSC FUCTIONS.**

#### How can I obtain an MMSI assignment?

Boat US offers free MMSI numbers. Visit the following to register:  
<http://www.boatus.com/mmsi/>.

### 7.3.2 Programming the MMSI

#### NOTE

User MMSI can be input only twice. If the user tries to input MMSI more than twice, the radio will show the display on the right. If the user needs to change the MMSI more than twice, the transceiver will have to be sent to Factory Service. Refer to the section 10.2 FACTORY SERVICE.

1. Press and hold down the [**CALL/SET(MENU)**] key until the “RADIO SETUP” menu appears.
2. Turn the **CHANNEL** selector knob to the left to select “DSC SETUP” menu.
3. Press the [**CALL/SET(MENU)**] key, then select “USER MMSI” with the **CHANNEL** selector knob.
4. Press the [**CALL/SET(MENU)**] key. The “User MMSI” number will appear, and the first space will flash.

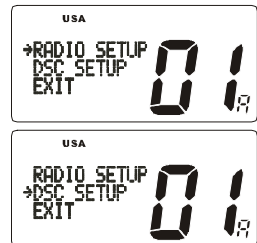

5. Select first number of your MMSI, then press the [CALL/SET(MENU)] key to step to the next number.
6. Repeat step 5 to set your MMSI (up to nine digits).
7. When finished programming the number, press and hold the [CALL/SET(MENU)] key to store the number in memory.
8. To exit this menu and return to radio operation mode press the [16/9] key.

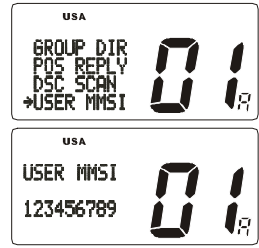

## 7.4 ADDITIONAL DIGITAL SELECTIVE CALLING INFORMATION

For additional information the USCG has an excellent site that should be visited at [www.navcen.uscg.mil/marcoms/gmdss/dsc.html](http://www.navcen.uscg.mil/marcoms/gmdss/dsc.html).

## 7.5 DSC DISTRESS CALL

The **QUANTUM** is capable of transmitting and receiving DSC Distress messages to all DSC radios. The **QUANTUM** may be connected to a GPS to also transmit the Latitude, Longitude of the vessel.

### 7.5.1 Transmitting A DSC Distress Call

#### NOTE

To be able to transmit a DSC distress call a MMSI number must be programmed, refer to section 7.3.2 Programming the MMSI

In order for your ships location to be transmitted a GPS must be connected to the **QUANTUM**, refer to section 4.4 CONNECTION OF GPS WITH NMEA OUTPUT

1. Lift the red spring loaded DISTRESS cover and press the [DISTRESS] key. The "DISTRESS" menu will appear on the LCD.
2. Press and hold the [DISTRESS] key. The radios display will count down (3-2-1) and then transmit the Distress call.
3. When the distress signal is sent, CH70 and "TX" icon will appear on the LCD. After the message has been sent, the radio will sound a Distress Alarm.
4. The transceiver "shadow-watches" for a transmission between CH16 and CH70 until an acknowledgment signal is received. "DISTRESS" and "WAITING" will appear on the LCD.
5. If an acknowledgement is received, select channel 16 and advise your distress situation.



6. If no acknowledgment is received, the distress call is repeated in 4 minute intervals until an acknowledgment is received.



7. When a DSC Distress acknowledgment is received, a distress alarm sounds and channel 16 is automatically selected. The LCD shows the MMSI of the ship responding to your distress.

RECEIVED ACK: acknowledgment signal is received.

RECEIVED RLY: relay signal is received from another vessel or coast station.

8. To cancel the DSC distress alarm signal from the speaker, press any key.

### Cancel a DSC Distress Call

If a DSC Distress call was sent by error the **QUANTUM** allows you to send a message to other vessels to cancel the Distress Call that was made in error.

Press the [**CALL/SET(MENU)**] key, turn the **CHANNEL** selector knob to select "CANCEL." Then, press the [**CALL/SET(MENU)**] key or turn off the radio.

### 7.5.2 Receiving a DSC Distress Call

1. A distress call is received. An emergency alarm sounds.

Then channel 16 is automatically selected.

2. Press any key to stop the alarm.

3. Turn the **CHANNEL** selector knob to change the display to show the position of the vessel in distress.

4. If the position of the vessel distress data does not include position, the LCD will show the display on the left.

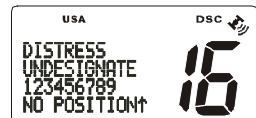
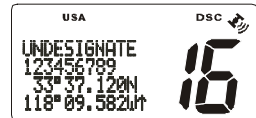

### NOTE

You must continue monitoring channel 16 as a coast station may require assistance in the rescue attempt.

## 7.6 ALL SHIPS CALL

The All Ships Call function allows contact to be established with other vessel stations without having their ID in the individual calling directory. Also, priority for the call can be designated as Urgency or Safety.

**URGENCY Call:** This type of call is used when a vessel may not truly be in distress, but have a potential problem that may lead to a distress situation. This call is the same as saying PAN PAN PAN on channel 16.

**SAFETY Call:** Used to transmit boating safety information to other vessels. This message usually contains information about an overdue boat, debris in the water. Loss of a navigation aid or an important meteorological message. This call is the same as saying Securite" Securite" Securite'.

### 7.6.1 Transmitting an All Ships Call

1. Press the **[CALL/SET(MENU)]** key. The "DSC OPERATION" menu will appear.
2. Turn the **CHANNEL** selector knob to select "ALL SHIPS."
3. Press the **[CALL/SET(MENU)]** key. (To cancel, turn the **CHANNEL** selector knob to select "EXIT.")
5. Turn the **CHANNEL** selector knob to select the nature of call ("URGENCY" or "SAFETY").
6. Press the **[CALL/SET(MENU)]** key to transmit the selected type of all ships DSC call.
7. After the ALL SHIPS CALL is transmitted, the transceiver will switch to CH16.
8. Listen to the channel to make sure it is not busy, then key the microphone and say PAN PAN PAN or Securite" Securite" Securite depending on the priority of the call. Then announce your call sign and announce the channel you wish to switch to for communications.



## 7.6.2 Receiving an All Ships Call

1. When an all ships call is received, an emergency alarm sounds.  
The radio will automatically change to channel 16.
2. Press any key to stop the alarm.
3. Turn the **CHANNEL** selector knob to see the MMSI of the vessel transmitting the All Ships Call.
4. Monitor channel 16 or traffic channel until the URGENCY voice communication is completed.



## 7.7 INDIVIDUAL CALL

This feature allows the **QUANTUM** to contact another vessel with a DSC VHF radio and automatically switch the receiving radio to a desired communications channel. This feature is similar to calling a vessel on CH16 and requesting to go to another channel (switching to the channel is private between the two stations).

### 7.7.1 Setting up the Individual / Position Call Directory

The **QUANTUM** has a DSC directory that allows you to store a vessel or person names and the MMSI number associated with vessels you wish to transmit Individual calls, Position Requests and Position Send transmissions.

To transmit an Individual call you must program this directory with information of the persons you wish to call, similar to a cellular phones telephone directory.

1. Press and hold down the [**CALL/SET(MENU)**] key until "RADIO SETUP" menu appears.
2. Turn the **CHANNEL** selector knob to select "DSC SETUP" menu.
3. Press the [**CALL/SET(MENU)**] key, then select "INDIV DIR" with the **CHANNEL** selector knob.
4. Press the [**CALL/SET(MENU)**] key, then select "ADD" with the **CHANNEL** selector knob.
5. Press the [**CALL/SET(MENU)**] key.
6. Turn the **CHANNEL** selector knob to scroll through the first letter of the name of the vessel or person you want to reference in the directory.
7. Press the [**CALL/SET(MENU)**] key to store the first letter in the name and step to the next letter to the right.
8. Repeat step 6 and 7 until the name is complete. The name can consist of up to eleven characters, if you do not use all eleven characters press the

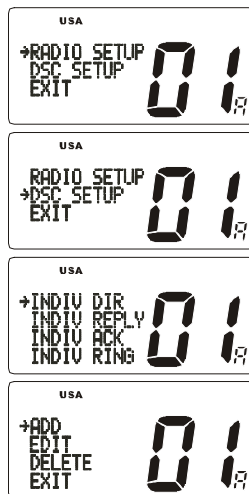

[CALL/SET(MENU)] key to move to the next space. This method can also be used to enter a blank space in the name. To clear the previous letter, press the [H/L(NAV)] key.

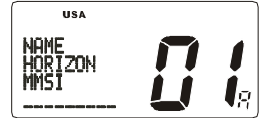

9. After the eleventh letter or space has been entered, press the [CALL/SET(MENU)] key to advance to the MMSI (Maritime Mobile Service Identity Number) number entry.
10. Turn the **CHANNEL** selector knob to scroll through numbers, 0-9. To enter the desired number and move one space to the right press the [CALL/SET(MENU)] key. Repeat this procedure until all nine space of the MMSI number are entered.
11. If a mistake was made entering in the name or the MMSI number repeat pressing the [CALL/SET(MENU)] key until the wrong character is selected, then move the channel knob to correct the entry.
12. To store the data entered, press and hold the [CALL/SET(MENU)] key.
13. To enter another individual address, repeat steps 4 through 13.
14. To exit this menu and return to radio operation mode press the [16/9] key.

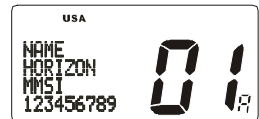

### NOTE

Selecting "NEXT" or "EXIT" will automatically save the name and MMSI number into memory.

## 7.7.2 Setting up Individual Reply

Allows setting up the radio to automatically (default setting) or manually respond to a DSC Individual call requesting you to switch to a working channel for voice communications. When Manual is selected the MMSI of the calling vessel is shown allowing you to see who is calling. This function is similar to caller id on a cellular phone.

1. Press and hold down the [CALL/SET(MENU)] key until "RADIO SETUP" menu appears.
2. Turn the **CHANNEL** selector knob to select "DSC SETUP" menu.
3. Press the [CALL/SET(MENU)] key, then select "INDIV REPLY" with the **CHANNEL** selector knob.
4. Press the [CALL/SET(MENU)]key.
5. Turn the **CHANNEL** selector knob to select "AUTO" or "MANUAL."
6. Press the [CALL/SET(MENU)] key to store the se-



lected setting.

7. To exit this menu and return to radio operation mode press the [16/9] key.



### 7.7.3 Setting up Individual Call Ringer

When a Individual call is received the radio will produce a ringing tone for 3 minutes. This selection allows the Individual Call ringer time to be changed.

1. Press and hold down the [CALL/SET(MENU)] key until "RADIO SETUP" menu appear.
2. Turn the **CHANNEL** selector knob to select "DSC SETUP" menu.
3. Press the [CALL/SET(MENU)] key, then select "INDIV RING" with the **CHANNEL** selector knob.
4. Press the [CALL/SET(MENU)] key.
5. Turn the **CHANNEL** selector knob to select ringing time of a Individual Call.
6. Press the [CALL/SET(MENU)] key to store the selected setting.
7. To exit this menu and return to radio operation mode press the [16/9] key.



### 7.7.4 Transmitting an Individual Call

This feature allows the user to contact another vessel with a DSC radio. This feature is similar to calling a vessel on CH16 and requesting to go to another channel. Select the traffic channel for voice communication.

1. Press the [CALL/SET(MENU)] key. The "DSC OPERATION" menu will appear.
2. Turn the **CHANNEL** selector knob to select "INDIVIDUAL." (To cancel, select "EXIT" with the **CHANNEL** selector knob or press the [16/9] key.)
3. Press the [CALL/SET(MENU)] key. The transceiver will beep, and the "Individual directory" will appear.
4. Turn the **CHANNEL** selector knob to select the "Individual" you want to contact.
5. Press the [CALL/SET(MENU)] key to transmit the individual DSC signal.
6. After INDIVIDUAL CALL is transmitted, the transceiver will wait 8 seconds for the acknowledgment. If the reply signal is not received, the transceiver





will transmit again.

7. After the second INDIVIDUAL CALL is transmitted, if the reply signal is not received, the dot matrix area of the LCD will display “→SEND” to prompt the user to send the call again or exit the mode.
8. When an individual call acknowledgment is received, the established channel is automatically selected and a ringing tone sounds.
9. Press the [CALL/SET(MENU)] key to listen to the channel to make sure it is not busy, then key the microphone and call the other vessel you desire to communicate with.

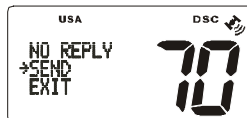
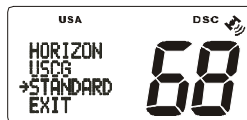

### 7.7.5 Receiving an Individual Call

When receiving an individual call, an acknowledgment must be sent back to the calling station. The **QUANTUM** default setting is Automatic, but has a selection that allows you to manually send a reply before the radio will switch to the requested calling channel. This selection is useful if you want to see who is calling and requesting you to switch to a channel for communications, similar to caller id on a cellular phone.

1. When an individual call is received, an individual call ringing alarm sounds.  
The radio automatically (automatic mode selected) switches to the requested channel.
2. Press any key to stop the alarm.
3. Press the **PTT** on the mic and talk to the calling ship.
4. Turn the **CHANNEL** selector knob to see the MMSI of the vessel calling.

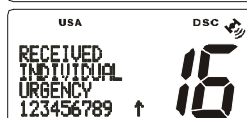

### 7.7.6 Setting Up the Call Waiting Function

Allows the **QUANTUM** to be setup to reply (ABLE) or set the radio so it transmits a call that advises to the vessel the person is UNABLE to reply to the call at this time. This function is similar to an answering machine. When set up in UNABLE and a individual call is received the Individual call from the other vessel is logged in the CALL WAITING directory for you to review and call back at a later time.

1. Press and hold down the [**CALL/SET(MENU)**] key until “RADIO SETUP” menu appears.
2. Turn the **CHANNEL** selector knob to select “DSC SETUP” menu.
3. Press the [**CALL/SET(MENU)**] key, then select “INDIV ACK” with the **CHANNEL** selector knob.
4. Press the [**CALL/SET(MENU)**] key.
5. Turn the **CHANNEL** selector knob to select “ABLE” or “UNABLE.”
6. Press the [**CALL/SET(MENU)**] key to store the selected setting.
7. To exit this menu and return to radio operation mode press the [**16/9**] key.

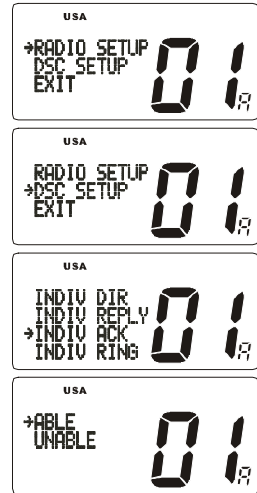

## 7.8 ADVANCED DSC CALLS

### 7.8.1 Group Call

This feature allows the user to contact a group of specific vessels (example members of a yacht club) using DSC radios with Group call function to automatically switch to a desired channel for voice communications.

#### 7.8.1.1 Setup a Group Call

For this function to operate the same Group MMSI must be programmed into all the DSC VHF radios within the group of vessels that will be using this feature. The group MMSI is a 9 digit (first digit permanently set to “0”) that will allow other radios to call your vessel along with others to automatically switch to a working channel for voice communications. This function is very useful for yacht clubs and vessels traveling together that want to collectively make announcements on a predetermined channel.

1. Press and hold down the [**CALL/SET(MENU)**] key until “RADIO SETUP” menu appears.
2. Turn the **CHANNEL** selector knob to select “DSC SETUP” menu.
3. Press the [**CALL/SET(MENU)**] key, then select “GROUP DIR” with the **CHANNEL** selector knob.
4. Press the [**CALL/SET(MENU)**] key, then select “ADD” with the **CHANNEL** selector knob.
5. Press the [**CALL/SET(MENU)**] key.
6. Turn the **CHANNEL** selector knob to scroll through the first letter of the name of the group you want to



reference in the directory.

7. Press the **[CALL/SET(MENU)]** key to store the first letter in the name. Press the **[CALL/SET(MENU)]** key to move the cursor one space to the right.
8. Repeat step 6 and 7 until the name is complete. The name can consist of up to eleven characters, if you do not use all eleven characters press the **[CALL/SET(MENU)]** key to move to the next space. This method can also be used to enter a blank space in the name. To clear the previous letter, press the **[H/L(NAV)]** key.
9. After the eleventh letter or space has been entered, press the **[CALL/SET(MENU)]** key to advance to the GROUP MMSI (Maritime Mobile Service Identity Number) number entry.
10. Turn the **CHANNEL** selector knob to scroll through numbers, 0-9.
11. To enter the desired number and move one space to the right press the **[CALL/SET(MENU)]** key. Repeat procedure until all nine spaces of MMSI number are entered.
12. If a mistake was made entering in the name or the MMSI number repeat pressing the **[CALL/SET(MENU)]** key until the wrong character is selected, then move the **CHANNEL** selector knob to correct the entry.
13. To store the data entered, press and hold the **[CALL/SET(MENU)]** key.
14. To enter another individual address, repeat steps 4 through 13.
15. To exit this menu and return to radio operation mode press the **[16/9]** key.

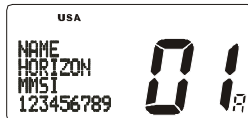
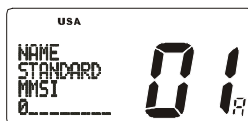

### 7.8.1.2 Transmitting a Group Call

1. Select the desired channel to use Group Call for voice communications.
2. Press the **[CALL/SET(MENU)]** key. The “DSC OPERATION” menu will appear.
3. Turn the **CHANNEL** selector knob to select “GROUP.” (To cancel, select “EXIT” with the **CHANNEL** selector knob or press **[16/9]** key.)
4. Press the **[CALL/SET(MENU)]** key. The transceiver will beep, and the “Group directory” will appear.
5. Turn the **CHANNEL** selector knob to select the “Group” you want to contact.
6. Press the **[CALL/SET(MENU)]** key to transmit the Group Call signal.



7. When the Group Call signal is sent, the dot-matrix area of the LCD will be as shown in the illustration at the right.
8. After the GROUP CALL is transmitted, all the radios in the group will switch to the designated channel.
9. Listen to the channel to make sure it is not busy, then key the microphone and call the other vessels you desire to communicate with.



### 7.8.1.3 Receiving a Group Call

1. When a group call is received, the **QUANTUM** will produce a ringing alarm sound.
2. The radio automatically switches to the requested channel.
3. Press any key to stop the alarm.
4. Monitor the channel for the person calling the Group for a message.
5. If you want to respond, monitor the channel to make sure it is clear, then press the **PTT** on the mic and talk to the calling ship(s).

#### **NOTE**

After a Group call is received, the time the call was made and the ships MMSI or vessels name will appear on the LCD.

### 7.8.2 Position Request

Advancements in DSC have made it possible to poll the location of another vessel and show the position of that vessel on the display of the **QUANTUM**. Standard Horizon has taken this feature one step further, if any Standard Horizon GPS is connected to the **QUANTUM**, the polled position of the vessel is shown on the display of the GPS chart plotter making it easy to navigate to the location of the polled vessel. This is a great feature for anyone wanting to know the position of another vessel. For example you buddy that is catching fish, or finding the location of a person you are cruising with.

#### **NOTE**

The other vessel must have an operating GPS receiver connected to its DSC transceiver and must not have its transceiver set to deny position requests. (Refer the section 7.9 to enter information into the individual directory).

### 7.8.2.1 Setting up Position Reply

The **QUANTUM** can be set up to automatically or manually send your position to another vessel. This selection is important if you are concerned about someone polling the position of your vessel that you may not want to. In the manual mode you will see the MMSI or persons name shown on the display allowing you to choose to send your position to the requesting vessel.

1. Press and hold down the [**CALL/SET(MENU)**] key until “RADIO SETUP” menu appear.
2. Turn the **CHANNEL** selector knob to select “DSC SETUP” menu.
3. Press the [**CALL/SET(MENU)**] key, then select “POS REPLY” with the **CHANNEL** selector knob.
4. Press the [**CALL/SET(MENU)**] key.
5. Turn the **CHANNEL** selector knob to select “AUTO” or “MANUAL.” In “AUTO” mode, after a DSC POS Request is received, the radio will automatically transmit your vessels position. In “MANUAL” mode, the display of the **QUANTUM** will show who is requesting the position.
6. Press the [**CALL/SET(MENU)**] key to store the selected setting.
7. To exit this menu and return to radio operation mode press the [**16/9**] key.



### 7.8.2.2 Transmitting a Position Request to Another Vessel

#### NOTE

To transmit a Position Request, you must setup the **QUANTUM** DSC Individual / Position Call Directory with the name of the vessel(s) or person and the MMSI of the DSC radio you wish to poll. To setup this directory refer to section 12.1 Setting up the Individual / Position Call Directory

1. Press the [**CALL/SET(MENU)**] key. The “DSC OPERATION” menu will appear in the display.
2. Turn the **CHANNEL** selector knob to select the “POS REQUEST.”
3. Press [**CALL/SET(MENU)**] key to show the Position request directory. This directory uses the INDIVIDUAL Directory information.
4. Turn the **CHANNEL** selector knob to select a name.
5. Press the [**CALL/SET(MENU)**] key to transmit the position request DSC call.



- After a DSC position request is transmitted, the transceiver remains on channel 70 until position data is received from the polled vessel.
- When the **QUANTUM** receives the position from the polled vessel it is shown on the radio display and also transferred to the GPS Chart plotter.
- If the **QUANTUM** does not receive a reply, the LCD will display “→SEND” to prompt the user to send the call again or exit the mode.



### NOTE

If the **QUANTUM** does not receive position data from the polled vessel, the LCD will show “NO POSITION DATA.”

#### 7.8.2.3 Receiving a Position Request

When a position request call is received from another vessel, a ringing alarm will sound and POS REQUEST will be show in the LCD. Operation and transceiver function differs depending on “POS REPLY” in the “DSC SETUP” menu setting.

#### **Automatically reply:**

- When a position request call is received, a calling alarm sounds 4 times. Then requested position coordinates are transmitted automatically to the vessel requesting your vessels position.
- To exit from position request display, press any key.



#### **Manually reply:**

- When a position request call is received from another vessel, the LCD will be as shown in the illustration at the right.
- A ringing alarm sounds 4 times. Then select type of reply function “REPLY” or “NO REPLY” by using the **CHANNEL** selector knob.
- The **QUANTUM** display will show “REPLY” or “NO REPLY” allowing you choose to send your vessels location by using the **CHANNEL** selector knob.
- When “REPLY” is selected, press the [**CALL/SET(MENU)**] key. And the your position will be transmitted to the requesting vessel.
- To exit from position request display, press any key.

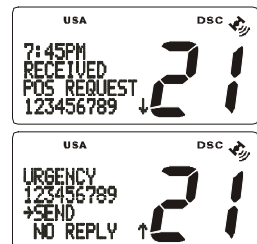

### 7.8.3 Position Send

The feature is similar to Position Request, however instead of requesting a position of another vessel this function allows you to send your position to another vessel. Your vessel must have an operating GPS receiver connected for the **QUANTUM** to send the position.

#### NOTE

To transmit a Position Send Call, you must setup the **QUANTUM** DSC Individual / Position Call Directory with the name of the vessel(s) or person and the MMSI of the DSC radio you wish to send your position to. To setup this directory refer to section 7.7.1 Setting up the Individual / Position Call Directory.

#### 7.8.3.1 Transmitting a DSC Position Send Call

1. Press the **[CALL/SET(MENU)]** key. The “DSC OPERATION” menu will appear in the display.
2. Turn the **CHANNEL** selector knob to select the “POS SEND.”
3. Press the **[CALL/SET(MENU)]** key to select the Individual directory.
4. Turn the **CHANNEL** selector knob to select a name in the directory.
5. Press the **[CALL/SET(MENU)]** key to send your position to the selected vessel.
6. After your position is transmitted, the resend menu will appear. To send your position again, select “SEND” and press the **[CALL/SET(MENU)]** key.
7. To exit the mode, select “EXIT” and press the **[CALL/SET(MENU)]** key.



#### 7.8.3.2 Receiving a DSC Position Send Call

When another vessel transmits their vessels location to the **QUANTUM** the following will happen:

1. A ringing sound will be produced when the call is received.
2. Press the **[16/9]** key to stop ringing
3. The position from the vessel sending it's position will be shown on the display of the radio and also transferred to any Standard Horizon GPS Chart plotter if connected.

## 8 RADIO SETUP

### NOTE

The optional RAM+ MIC CMP25 can be also change the SETUP menu.  
Refer to page 54 for details.

### 8.1 LAMP ADJUSTING

Allows setting up the backlight intensity or to turn it off.

1. Press and hold down the [**CALL/SET(MENU)**] key until “RADIO SETUP” menu appears.
2. Press the [**CALL/SET(MENU)**] key, then select “LAMP” in the “RADIO SETUP” menu with the **CHANNEL** selector knob.
3. Press the [**CALL/SET(MENU)**] key.
4. Turn the **CHANNEL** selector knob to select the desired level. When “OFF” is selected, the lamp is extinguished.
5. Press the [**CALL/SET(MENU)**] key to store the selected level.
6. To exit this menu and return to radio operation mode press the [**16/9**] key.



### 8.2 LCD CONTRAST

Due to varying mounting (overhead or below) this selection sets up the display for best viewability.

1. Press and hold down the [**CALL/SET(MENU)**] key until “RADIO SETUP” menu appears.
2. Press the [**CALL/SET(MENU)**] key, then select “CONTRAST” in the “RADIO SETUP” menu with the **CHANNEL** selector knob.
3. Press the [**CALL/SET**] key.
4. Turn the **CHANNEL** selector knob to select the desired level. The contrast level can be set from “1” to “7.”
5. Press the the [**CALL/SET(MENU)**] key to store the selected level.
6. To exit this menu and return to radio operation mode press the [**16/9**] key.





### 8.3 TIME OFFSET

Sets the time offset between local time and UTC (time GPS sends to radio). Time is displayed when GPS position (LAT/LON) is displayed by pressing the [H/L(NAV)] key.

1. Press and hold down the [CALL/SET(MENU)] key until "RADIO SETUP" menu appears.
2. Press the [CALL/SET(MENU)] key, then select "TIME SET" in the "RADIO SETUP" menu with the CHANNEL selector knob.
3. Press the [CALL/SET(MENU)] key.
4. Turn the CHANNEL selector knob to select time offset from UTC. See illustration below to find your offset time from UTC. If "0:00" is assigned, the time is the same as UTC (Universal Time Coordinated or GMT Greenwich Mean Time).
5. Press the [CALL/SET(MENU)] key to store the time offset.
6. To exit this menu and return to radio operation mode press the [16/9] key.

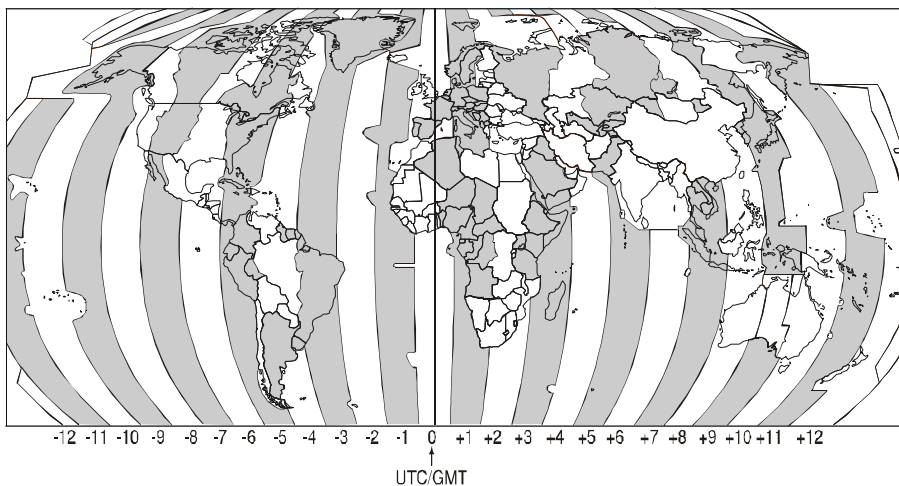

**OFFSET TIME TABLE**

## 8.4 KEY BEEP (ON/OFF)

This selection allows the beep tone when a key is pressed to be turned off.

1. Press and hold down the [**CALL/SET(MENU)**] key until "RADIO SETUP" menu appears.
2. Press the [**CALL/SET(MENU)**] key, then select "KEY BEEP" in the "RADIO SETUP" menu with the **CHANNEL** selector knob.
3. Press the [**CALL/SET(MENU)**] key.
4. Turn the **CHANNEL** selector knob to select "ON" or "OFF."
5. Press the [**CALL/SET(MENU)**] key to set the key beep condition.
6. To exit this menu and return to radio operation mode press the [**16/9**] key.



### NOTE

Emergency alarm and beeps for DSC operation cannot be turned OFF.

## 8.5 WX ALERT (ON/OFF)

This selection allows the radios NOAA Weather alert to be turned off. Default setting is ON.

1. Press and hold down the [**CALL/SET(MENU)**] key until "RADIO SETUP" menu appears.
2. Press the [**CALL/SET(MENU)**] key, then select "WX ALERT" in the "RADIO SETUP" menu with the **CHANNEL** selector knob.
3. Press the [**CALL/SET(MENU)**] key.
4. Turn the **CHANNEL** selector knob to select "ON" or "OFF."
5. Press the [**CALL/SET(MENU)**] key to store the selected setting.
6. To exit this menu and return to radio operation mode press the [**16/9**] key.



## 8.6 VOICE SCRAMBLER

(Operates only when the optional CVS2500 is installed)

This menu is used to setup the channels to be scrambled and the scrambler code.

### NOTE

This menu will not appear unless a CVS2500 is installed.

1. Press and hold down the [CALL/SET(MENU)] key until "RADIO SETUP" menu appears.
2. Press the [CALL/SET(MENU)] key then select "SCRAMBLER" in the "RADIO SETUP" menu with the **CHANNEL** selector knob.
3. Press the [CALL/SET(MENU)] key then select "CODE" in the "SCRAMBLER" menu with the **CHANNEL** selector knob.
4. Press the [CALL/SET(MENU)] key then turn the **CHANNEL** selector knob to change the scrambler code. The scrambler code can be set from "0" to "3" and "OFF." When "OFF" is selected the voice scrambler is disabled.
5. Press the [CALL/SET(MENU)] key to store the selected code.
6. Select "CHANNEL" in the "SCRAMBLER" menu with the **CHANNEL** selector knob, then press the [CALL/SET] key.
7. Turn the **CHANNEL** selector knob to change the Scrambler channel.
8. Press the [SCAN] key to store the selected channel. Repeat steps 6 and 7 to set other channels.
9. Press the [CALL/SET(MENU)] key to return to the "SCRAMBLER" menu.
10. To exit this menu and return to radio operation mode press the [16/9] key.



## 8.7 CHANNEL NAMING

This selection allows you to customize the name of a channel from the default name.

1. Press and hold down the **[CALL/SET(MENU)]** key until “RADIO SETUP” menu appear.
2. Press the **[CALL/SET(MENU)]** key, then select “CH NAME” in the “RADIO SETUP” menu with the **CHANNEL** selector knob.
3. Press the **[CALL/SET(MENU)]** key.
4. Turn the **CHANNEL** selector knob to select the channel to be named and press the **[CALL/SET(MENU)]** key.
5. Turn the **CHANNEL** selector knob scroll through the alphabet and 0 - 9.
6. Press the **[CALL/SET(MENU)]** key to enter the desired letter and move the cursor one space to the right.
7. Repeat procedure until the name is complete. The name can consist of up to twelve characters. If you do not use all twelve character, press the **[CALL/SET(MENU)]** key to move to the next space. To clear the previous letter, press the **[H/L(NAV)]** key.
8. Press and hold down the **[CALL/SET(MENU)]** key to enter the name and exit from the “CH NAME” menu. The LCD will return to the “SETUP” menu.
9. If you want to enter the name of another channel, repeat steps 3 through 8.
10. To exit this menu and return to radio operation mode press the **[16/9]** key.

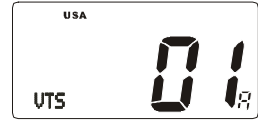

## 8.8 TRUE MAGNETIC CHANGE (NAV display)

Allows customizing the GPS COG (Course Over Ground) displayed on the LCD to be in True or Magnetic.

1. Press and hold down the [**CALL/SET(MENU)**] key until "RADIO SETUP" menu appear.
2. Press the [**CALL/SET(MENU)**] key, then select "TRUE MAG" in the "RADIO SETUP" menu with the **CHANNEL** selector knob.
3. Press the [**CALL/SET(MENU)**] key.
4. Turn the **CHANNEL** selector knob to select "MAGNETIC" or "TRUE."
5. Press the [**CALL/SET(MENU)**] key to store the selected setting.
6. To exit this menu and return to radio operation mode press the [**16/9**] key.



## 8.9 FOG ALERT TONE FREQUENCY

This selection allows you to select the Alert Tone Frequency for the PA/FOG Operation. Available selections are "250 Hz" through "850 Hz" in 50 Hz step multiple.

1. Press and hold down the [**CALL/SET(MENU)**] key until "RADIO SETUP" menu appear.
2. Press the [**CALL/SET(MENU)**] key, then select "FOG FREQ." in the "RADIO SETUP" menu with the **CHANNEL** selector knob.
3. Press the [**CALL/SET(MENU)**] key.
4. Turn the **CHANNEL** selector knob to select desired tone frequency.
5. Press the [**CALL/SET(MENU)**] key to store the selected setting.
6. To exit this menu and return to radio operation mode press the [**16/9**] key.



## 9 RAM+ MIC OPERATION

If the enhanced optional RAM+ Mic (**CMP25**) is connected to the remote microphone connector on the transceiver's rear panel, the transceiver can use the remote control operation except for a few functions. The RAM+ Mic supplied with 23 feet (7 m) of routing cable and can be extended up to 70 feet (21 m) using three 23 feet extension cables model **CT-100**. The intercom operation can be used between the RAM+ Mic and the transceiver.

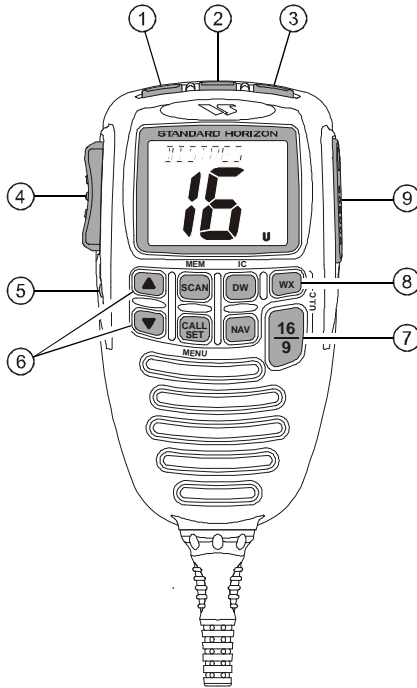

### 9.1 RAM+ MIC CONTROLS

#### ① SQUELCH CONTROL (SQL)

Activates the squelch adjusting mode.

Press this key to activate the squelch adjusting mode. Press the microphone's [▲] or [▼] key to adjust the squelch.

When this key is pressed and held down for 1 second or more, the squelch is turned off.

#### ② VOLUME KEY (VOL)

Activates the volume adjusting mode.

Press this key to activate the volume adjusting mode. Press the microphone's [▲] or [▼] to adjust the volume.

③ **POWER SWITCH (PWR)**

Press and hold down this key to turn to the transceiver and RAM+ Mic on and off.

④ **PTT (Push-To-Talk) SWITCH**

Activates transmission.

⑤ **[H/L] KEY**

Toggles between high and low power. When the **[H/L]** key is pressed while the transceiver is on channel 13 or 67, the power will temporarily switch from LO to HI power until the **PTT** is released. The **[H/L]** key does not function on transmit inhibited and low power only channels.

⑥ **[▲](UP)/[▼](DOWN) KEY**

These keys are used to select channels, adjusts the volume and squelch level, and to choose the item selection of different functions (such as the DSC operation). In many ways, these keys emulate the function of the transceiver's **CHANNEL** selector knob.

⑦ **[16/9] KEY**

Immediately recalls channel 16 from any channel location. Holding down this key recalls channel 9. Pressing the **[16/9]** key reverts to the previous selected working channel.

**Secondary use**

Please see secondary use for the **[WX]** and **[MEM]** key.

⑧ **KEY PAD**

**[SCAN] Key**

1. Starts and stops scanning of programmed channels.
2. If held while the **[UP(▲)]** or **[DOWN(▼)]** key on the microphone are pressed or **CHANNEL** selector knob on radio is turned, the radio will show the channels programmed in scan memory. This function will not work if the unit is scanning.

**NOTE:** The priority channel is channel 16 only.

**[CALL/SET] Key**

The **[CALL/SET]** key functions as the enter key.

**Secondary use**

Press the **[CALL/SET]** key to access the DSC OPERATION menu.

Press and hold the **[CALL/SET]** key to access the SETUP menu.

## [DW] Key

Watches for a transmission on CH16 and another selected channel until either signal is received. (Dual watch)

**NOTE:** When the DSC SCANNING feature is enabled (see section 7.15 DSC SCAN), the radio watches for a transmission on CH16, another selected channel, and **CH70** until either signal is received (Triple watch).

### **Secondary use**

Press and hold [DW] key, intercom operation will operate between radio and RAM Mic.

## [NAV] Key

Press and hold this key, when connected to the GPS receiver, the LCD displays Position Data, Time, SOG (Speed Over Ground), and COG (Course Over Ground) from the GPS.

## [WX] Key

Immediately recalls the previously selected NOAA weather channel from any channel location.

### **Secondary use**

1. Holding down the [16/9] key while pressing the [WX] key changes the mode from USA to International or Canadian.

**NOTE:** If position is displayed, this icon will be hidden.

2. Holding down the [WX] and [SCAN] key while turning the power on resets the microprocessor and erases scan channels from memory. This clears the memory and establishes the factory-set defaults. For a list of these defaults, see the section on Resetting the Transceiver's Microprocessor.

## ⑨ [DISTRESS] KEY

Used to send a DSC Distress Call. To send the distress call:

1. Lift the red rubber cover.
2. Press and hold the Red button. The RAM+ display will count down (3-2-1) and then transmit the Distress call.
3. When the distress signal is sent, Ch70 and "TX" icon will appear on the LCD. After the message has been sent, the radio will sound a Distress Alarm.
4. The transceiver "shadow-watches" for a transmission on CH16 or CH70 until an acknowledgment signal is received. "DISTRESS" and "WAITING" will appear on the LCD.
5. If an acknowledgement is received, select channel 16 and advise your distress situation.





6. If no acknowledgment is received, the distress call is repeated in 4 minute intervals until an acknowledgment is received.
7. When a DSC Distress acknowledgment is received, a distress alarm sounds and channel 16 is automatically selected. The LCD shows the MMSI of the ship responding to your distress.  
 RECEIVED ACK: acknowledgment signal is received.  
 RECEIVED RLY: relay signal is received from another vessel or coast station.
8. To cancel the DSC distress alarm signal from the speaker, press any key.

## 9.2 INTERCOM OPERATION

### 9.2.1 Communication

1. Press and hold the [DW] key while in the “RADIO” mode, the mode is changed to “INTERCOM” mode.
2. If your **QUANTUM** is equipped two RAM+ Mic, select the companion you wish to communicate (RADIO, RAM, or ALL) with the [▲]/[▼] key, then press the [CALL/SET] key to terminated.
3. When the “INTERCOM” operation is activated, “IC” is displayed on the RAM+ Mic and “INTERCOM” is displayed on the **QUANTUM**.

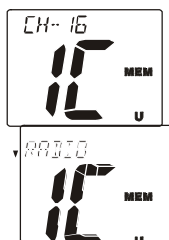

4. Press the PTT switch. The “TALK” is displayed.

**NOTE:** A warning beep is emitted when the RAM+ Mic PTT switch is pressed while the transceiver microphone’s PTT switch is pressed.



(RAM+ Mic’s PTT switch is pressed)

5. Speak slowly and clearly into the microphone, hold the microphone about 1/2 inch away from your mouth.



(MATRIX’s PTT switch is pressed)

6. When finished, release the PTT switch.
7. Press the [DW] key again the mode will revert to “RADIO” mode.

### 9.2.2 Calling

Hold down the [DW] key for 1 second or more, when the “INTERCOM” operation is activated. A calling beep is emitted twice from the transceiver speaker.

### 9.3 DSC/RADIO SETUP MODE

The **CMP25** can access the DSC / RADIO setup menu (refer to section 7 “DSC/RADIO SETUP” for details). However, the LAMP, CONTRAST, and KEY BEEP menu item which is accessed from the **CMP25** only controls the **CMP25**'s display and speaker.

DSC/RADIO Setup mode from the **CMP25**:

1. Press and hold down the [CALL/SET] key until “RADIO SETUP” menu appears.
2. Press the [▲]/[▼] key to select “RADIO SET” or “DSC SETUP” menu.
3. Press the [CALL/SET] key, then select the menu item you wish to work on by pressing the [▲]/[▼] key.
4. Press the [CALL/SET] key.
5. Press the [▲]/[▼] key to change the value or condition for the menu item, then press the [CALL/SET] key to save the new setting.
6. Press the [▲]/[▼] key to select “EXIT,” then press the [CALL/SET] key to return to the normal operation.

**RADIO SETUP-menu**

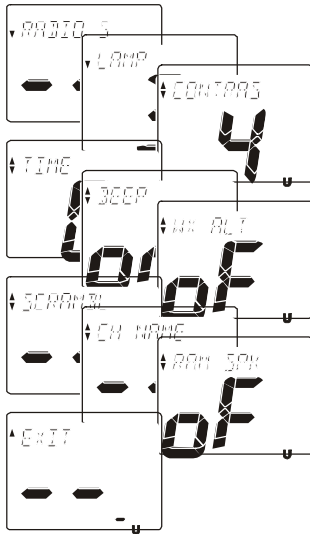

**DSC SETUP-menu**

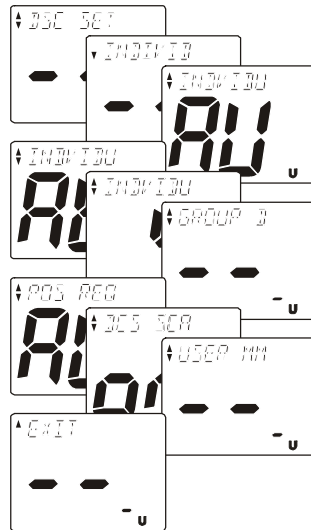

## 10 MAINTENANCE

The inherent quality of the solid-state components used in this transceiver will provide many years of continuous use. Taking the following precautions will prevent damage to the transceiver.

- Keep the microphone connected or the jack covered at all times to prevent corrosion of electrical contacts;
- Never key the microphone unless an antenna or suitable dummy load is connected to the transceiver.
- Ensure that the supply voltage to the transceiver does not exceed 16 VDC or fall below 11 VDC.
- Use only STANDARD HORIZON-approved accessories and replacement parts.

In the unlikely event of serious problems, please contact your Dealer or our repair facility. Address and phone numbers for this facility, as well as warranty information, are contained in section 12 WARRANTY.

### 10.1 REPLACEMENT PARTS

Occasionally an owner needs a replacement mounting bracket or knob. These can be ordered from our Parts Department by writing or calling:

**Marine Division of Vertex Standard**

US Headquarters

10900 Walker Street, Cypress, CA 90630, U.S.A.

Telephone (714) 827-7600

Commonly requested parts, and their part numbers are listed below.

- **Power Code:** T9023306
- **VOL/SQL Knob:** RA0542600
- **Rotary Channel Knob:** RA0542500
- **Mounting Bracket:** RA0544200
- **Mounting Bracket Knob:** RA045910A
- **Microphone Hanger:** RA0458800

## 10.2 FACTORY SERVICE

In the unlikely event that the radio fails to perform or needs servicing, please contact the following:

**Standard Horizon**  
**Attention Marine Repair Department**  
 10900 Walker Street  
 Cypress, CA 90630  
 Telephone (800) 366-4566

An “RA” Return Authorization number is not necessary to send a product in for service. Include a brief note describing the problem along with your name, return address, phone number, and proof of purchase.

## 10.3 TROUBLESHOOTING CHART

SYMPTON	PROBABLE CAUSE	REMEDY
Transceiver fails to power up.	No DC voltage to the transceiver, or blown fuse.	a. Check the 12VDC battery connections and the fuse. b. The <b>VOL/PWR</b> knob needs to be pressed and held to turn the radio on.
Transceiver blows fuse when connected to power supply.	Reversed power wires.	Check the power cable for DC voltage, or replace the fuse (6A 250V). Make sure the red wire is connected to the positive (+) battery post, and the black wire is connected to the negative (-) battery post. If the fuse still blows, contact your Dealer.
Popping or whining noise from the speaker while engine runs.	Engine noise.	Reroute the DC power cables away from the engine. Add noise suppressor on power cable. Change to resistive spark plug wires and/or add an alternator whine filter.
Sound is not emitted from the external speaker.	Accessory cable.	Check the connections of the accessory cable.
Receiving station report low transmit power, even with transceiver set to HI power.	Antenna.	Have the antenna checked or test the transceiver with another antenna. If the problem persists, contact your Dealer for servicing.
“HI BATTERY” or “LO BATTERY” message is appeared when the power is turned on.	The power supply voltage is too high or too low.	Confirm that the connected power supply voltage is not 17 volts or lower than 10 volts. Confirm that the generator has not malfunctioned.
Your position is not displayed.	Accessory cable.	Check the accessory cable connection. Some GPS use the battery ground line for NMEA connection.
	Setting of the GPS navigation receiver.	Check the output signal format of the GPS navigation receiver. This radio requires NMEA0183 format with GLL sentence as an output signal. If the GPS has a baud rate setting make sure to select 4800 and parity to NONE.

## 11. CHANNEL ASSIGNMENTS

Tables on the following columns list the VHF Marine Channel assignments for U.S.A. and International use. Below are listed some data about the charts.

1. VTS. Where indicated, these channels are part of the U.S. Coast Guard's **Vessel Traffic System**.
2. Alpha channel numbers, that is, channel numbers followed by the letter A (such as Channel 07A) are **simplex** channels on the U.S.A. or Canadian channel assignments whose counterparts in the International assignments are **duplex** channels. International channels do not use "alpha" numbers. If you call the Coast Guard on Channel 16, they will sometimes ask you to "**go to channel 22 Alpha.**" This is a channel assigned to U.S.A, and Canadian Coast Guards for handling distress and other calls. If your radio is set for **International** operation you will go to Channel 22 instead of 22A, and will not be able to communicate with the Coast Guard. To use Channel 22A, your radio must be set for **USA** or **Canada** operation, usually by a U/I/C (USA/International/Canada) control or combination of controls. Channel 22 (without an "A") is an **International** duplex channel for port operations. Some radios indicate an "A" adjacent to the alpha channels on the display; on others "alpha" is not indicated but the proper channel is selected based on the U/I/C setting.
3. Bridge-to-Bridge channels (for example, Channel 13) are for use by bridge operators on intercoastal waterways and rivers. It is also used by marine vessels in the vicinity of these bridges for navigation and for communicating with the bridge operators. Note that a limit of 1 Watt is specified for these channels. See page 27 for additional information.
4. The **S/D** column on the chart indicates either S (simplex) or D (duplex). **Simplex** means transmitting and receiving on the same frequency. Only one party at a time can talk, unlike a telephone. Be sure to say "**over**" and release your microphone push-to-talk switch at the end of each transmission. **Duplex** operation involves the use of one frequency for transmitting and a separate frequency for receiving. On channels specified as duplex on the charts, correct mode of operation is established automatically by your radio when you select a channel; you cannot change the mode. And you still must release the push-to-talk switch after each transmission in order to listen to the radio.
5. Channels normally used by recreational boaters are those that include the term "non-commercial" in the **Channel Use** column of the chart. Some of these are shared with other users and some are used only in certain geographic regions.

**6. Marine vessels equipped with VHF radios are required to monitor Channel 16.**

VHF MARINE CHANNEL CHART							
CH	U	C	I	S/D	TX	RX	CHANNEL USE
01		X	X	D	156.050	160.650	Public Correspondence (Marine Operator)
01A	X			S	156.050		Port Operation and Commercial. VTS in selected areas
02		X	X	D	156.100	160.700	Public Correspondence (Marine Operator)
03		X	X	D	156.150	160.750	Public Correspondence (Marine Operator)
<b>03A</b>	<b>X</b>			<b>S</b>	<b>156.150</b>		<b>US Government only, Coast Guard</b>
04			X	D	156.200	160.800	Public Correspondence (Marine Operator), Port operation, ship movement
04A		X		S	156.200		Pacific coast: Coast Guard, East Coast: Commercial fishing
05			X	D	156.250	160.850	Public Correspondence (Marine Operator), Port operation, ship movement
05A	X	X		S	156.250		Port operation. VTS in Seattle
06	X	X	X	S	156.300		Inter-ship Safety
07			X	D	156.350	160.950	Public Correspondence (Marine Operator), Port operation, ship movement
07A	X	X		S	156.350		Commercial
08	X	X	X	S	156.400		Commercial (Inter-ship only)
09	X	X	X	S	156.450		Boater Calling channel, Commercial & Non-commercial (Recreational)
10	X	X	X	S	156.500		Commercial
11	X	X	X	S	156.550		Commercial. VTS in selected areas.
12	X	X	X	S	156.600		Port operation. VTS in selected areas.
13	X	X	X	S	156.650		Inter-ship Navigation Safety (Bridge-to-bridge)
14	X	X	X	S	156.700		Port operation. VTS in selected areas.
15	X			S	- - -	156.750	Environmental (Receive only)
15		X	X	S	156.750		Commercial, non-commercial, ship movement (1 W)
16	X	X	X	S	156.800		International Distress, Safety and Calling
17	X	X	X	S	156.850		State Controlled (1 W)
18			X	D	156.900	161.500	Port operation, ship movement
18A	X	X		S	156.900		Commercial
19			X	D	156.950	161.550	Port operation, ship movement
19A	X			S	156.950		US: Commercial
19A		X		S	156.950		Coast Guard
20	X	X	X	D	157.000	161.600	Canadian Coast Guard Only, International: port operations and shipment
20A	X			S	157.000		Port operation
21			X	D	157.050	161.650	Port operation, ship movement
<b>21A</b>	<b>X</b>	<b>X</b>		<b>S</b>	<b>157.050</b>		<b>U.S. Government Only, Canadian Coast Guard</b>
22			X	D	157.100	161.700	Port operation, ship movement
22A	X	X		S	157.100		US and Canadian Coast Guard Liaison and Maritime Safety Information Broadcasts announced on channel 16

VHF MARINE CHANNEL CHART							
CH	U	C	I	S/D	TX	RX	CHANNEL USE
23		X	X	D	157.150	161.750	Public Correspondence (Marine Operator)
<b>23A</b>	<b>X</b>			<b>S</b>	<b>157.150</b>		<b>U.S. Government Only</b>
24	X	X	X	D	157.200	161.800	Public Correspondence (Marine Operator)
25	X	X	X	D	157.250	161.850	Public Correspondence (Marine Operator)
26	X	X	X	D	157.300	161.900	Public Correspondence (Marine Operator)
27	X	X	X	D	157.350	161.950	Public Correspondence (Marine Operator)
28	X	X	X	D	157.400	162.000	Public Correspondence (Marine Operator)
60		X	X	D	156.025	160.625	Public Correspondence (Marine Operator)
61			X	D	156.075	160.675	Public Correspondence (Marine Operator), Port operation, ship movement
<b>61A</b>	<b>X</b>	<b>X</b>		<b>S</b>	<b>156.075</b>		<b>U.S. Government Only, Canadian Coast Guard-Pacific Coast, Commercial Fishing-East Coast</b>
62			X	D	156.125	160.725	Public Correspondence (Marine Operator), Port operation, ship movement
62A		X		S	156.125		Public Coast: Coast Guard; East Coast: commercial fishing only
63			X	D	156.175	160.775	Public Correspondence (Marine Operator), Port operation, ship movement
63A	X			S	156.175		Port Operation and Commercial. VTS in selected areas.
64		X	X	D	156.225	160.825	Public Correspondence (Marine Operator), Port operation, ship movement
<b>64A</b>	<b>X</b>	<b>X</b>		<b>S</b>	<b>156.225</b>		<b>U.S. Government Only, Canadian Commercial Fishing</b>
65			X	D	156.275	160.875	Public Correspondence (Marine Operator), Port operation, ship movement
65A	X	X		S	156.275		Port Operations
66			X	D	156.325	160.925	Public Correspondence (Marine Operator), Port operation, ship movement
66A	X	X		S	156.325		Port Operations
67	X	X	X	S	156.375		US: Commercial. Used for Bridge-to-bridge communications in lower Mississippi River. Inter-ship only, Canada: Commercial fishing, S&R
68	X	X	X	S	156.425		Non-commercial (Recreational)
69	X	X	X	S	156.475		US: Non-commercial (Recreational), Canada: Commercial fishing only, International: Inter-ship, Port operations and Ship movement
70	X	X	X	S	156.525		Digital selective calling (voice communications not allowed)
71	X	X	X	S	156.575		US, Canada: Non-commercial (Recreational), International: Port operations and Ship movement
72	X	X	X	S	156.625		Non-commercial (Inter-ship only)
73	X	X	X	S	156.675		US: Port Operations, Canada: Commercial fishing only, International: Inter-ship, Port operations and Ship movement
74	X	X	X	S	156.725		US: Port Operations, Canada: Commercial fishing only, International: Inter-ship, Port operations and Ship movement

VHF MARINE CHANNEL CHART							
CH	U	C	I	S/D	TX	RX	CHANNEL USE
75	X			S	156.775		Port Operations (Inter-ship only) (1W)
76	X			S	156.825		Port Operations (Inter-ship only) (1W)
77	X	X		S	156.875		Port Operations (Inter-ship only) (1W)
77			X	S	156.875		Port Operations (Inter-ship only)
78			X	D	156.925	161.525	Public Correspondence (Marine Operator), Port operation, ship-movement
78A	X	X		S	156.925		Non-commercial (Recreational)
79			X	D	156.975	161.575	Port operation and Ship movement
79A	X	X		S	156.975		Commercial
80			X	D	157.025	161.625	Port operation, ship movement
80A	X	X		S	157.025		Commercial
81			X	D	157.075	161.675	Port operation, ship movement
<b>81A</b>	<b>X</b>	<b>X</b>		<b>S</b>	<b>157.075</b>		<b>U.S. Government Only - Environmental protection operations.</b>
82			X	D	157.125	161.725	Public Correspondence (Marine Operator), Port operation, ship movement
<b>82A</b>	<b>X</b>	<b>X</b>		<b>S</b>	<b>157.125</b>		<b>U.S. Government Only, Canadian Coast Guard Only</b>
83		X	X	D	157.175	161.775	Canadian Coast Guard Only
<b>83A</b>	<b>X</b>	<b>X</b>		<b>S</b>	<b>157.175</b>		<b>U.S. Government Only, Canadian Coast Guard Only</b>
83		X	X	D	157.175	161.775	Public Correspondence (Marine Operator)
84	X	X	X	D	157.225	161.825	Public Correspondence (Marine Operator)
85	X	X	X	D	157.275	161.875	Public Correspondence (Marine Operator)
86	X	X	X	D	157.325	161.925	Public Correspondence (Marine Operator)
87	X	X	X	D	157.375	161.975	Public Correspondence (Marine Operator)
88	X	X	X	D	157.425	162.025	Public Correspondence (ship-to-coast)
88A	X			S	157.425		Commercial, Inter-ship Only
WX01	X	X	X	D	---	162.550	Weather (receive only)
WX02	X	X	X	D	---	162.400	Weather (receive only)
WX03	X	X	X	D	---	162.475	Weather (receive only)
WX04	X	X	X	D	---	162.425	Weather (receive only)
WX05	X	X	X	D	---	162.450	Weather (receive only)
WX06	X	X	X	D	---	162.500	Weather (receive only)
WX07	X	X	X	D	---	162.525	Weather (receive only)
WX08	X	X	X	D	---	161.650	Weather (receive only)
WX09	X	X	X	D	---	161.775	Weather (receive only)
WX10	X	X	X	D	---	163.275	Weather (receive only)

The above **BOLD** channels are not for use of the general public in U.S. waters, unless proper authorization is given.



Channel designator	Carrier frequency (MHz)		Points of communication (Intership and between coast and ship unless otherwise indicated)	
	Ship transmit	Coast transmit		
<b>Port Operations</b>				
01A <sup>1</sup>	156.050	156.050		
63A <sup>1</sup>	156.175	156.175		
05 <sup>2</sup>	156.250	156.250		
65A	156.275	156.275		
66A	156.325	156.325		
12 <sup>3</sup>	156.600	156.600		
73	156.675	156.675		
14 <sup>3</sup>	156.700	156.700		
74	156.725	156.725		
77 <sup>4</sup>	156.875			
20A <sup>12</sup>	157.000			
<b>Intership only. Intership only.</b>				
<b>Navigational (Bridge-to-Bridge)<sup>5</sup></b>				
13 <sup>6</sup>	156.650	156.650		
67 <sup>7</sup>	156.375	156.375		
<b>Commercial</b>				
01A <sup>1</sup>	156.050	156.050		
63A <sup>1</sup>	156.175	156.175		
07A	156.350	156.350		
67 <sup>7</sup>	156.375			
08	156.400	.....		
09	156.450	156.450		
10	156.500	156.500		
11 <sup>3</sup>	156.550	156.550		
18A	156.900	156.900		
19A	156.950	156.950		
79A	156.975	156.975		
80A	157.025	157.025		
88A <sup>8</sup>	157.425	.....		
72 <sup>14</sup>	156.625	.....		
<b>Intership only. Do. Intership only. Intership only.</b>				
<b>Digital Selective Calling</b>				
70 <sup>15</sup>	156.525	156.525		

Channel designator	Carrier frequency (MHz)		Points of communication (Intership and between coast and ship unless otherwise indicated)	
	Ship transmit	Coast transmit		
<b>Noncommercial</b>				
68 <sup>17</sup>	156.425	156.425		
09 <sup>16</sup>	156.450	156.450		
69	156.475	156.475		
71	156.575	156.575		
72	156.625	.....		
78A	156.925	156.925		
79A	156.975	156.975		
80A	157.025	157.025		
67 <sup>14</sup>	156.375	.....		
<b>Intership only. Great Lakes only. Do. Intership only.</b>				
<b>Distress, Safety and Calling</b>				
16	156.800	156.800		EPRIB
<b>Intership Safety</b>				
06	156.300	.....		a. Intership, or b. For SAR: Ship and aircraft for the U.S. Coast Guard.
<b>Environmental</b>				
15 <sup>13</sup>	.....	156.750	Coast to ship only.	
<b>Maritime Control</b>				
17 <sup>9,10</sup>	156.850	156.850		
<b>Liaison, U.S. Coast Guard</b>				
22A <sup>11</sup>	157.100	157.100	Ship, aircraft, and coast stations of the U.S. Coast Guard and at Lake Mead, Nev., ship and coast stations of the National Park Service, U.S. Department of the Interior.	

- 1: 156.050 MHz and 156.175 MHz are available for port operations and commercial communications purposes when used only within the U.S. Coast Guard designated Vessel Traffic Services (VTS) area of New Orleans, on the lower Mississippi River from the various pass entrances in the Gulf of Mexico to Devil's Swamp Light at River Mile 242.4 above head of passes near Baton Rouge.
- 2: 156.250 MHz is available for port operations communications use only within the U.S. Coast Guard designated VTS radio protection areas of New Orleans and Houston described in Sec. 80.383. 156.250 MHz is available for intership port operations communications used only within the area of Los Angeles and Long Beach harbors, within a 25-nautical mile radius of Point Fermin, California.
- 3: 156.550 MHz, 156.600 MHz and 156.700 MHz are available in the U.S. Coast Guard designated port areas only for VTS communications and in the Great Lakes available primarily for communications relating to the movement of ships in sectors designated by the St. Lawrence Seaway Development Corporation or the U.S. Coast Guard. The use of these frequencies outside VTS and ship movement sector protected areas is permitted provided they cause no interference to VTS and ship movement communications in their respective designated sectors.

- 4: Use of 156.875 MHz is limited to communications with pilots regarding the movement and docking of ships. Normal output power must not exceed 1 watt.
- 5: 156.375 MHz and 156.650 MHz are available primarily for intership navigational communications. These frequencies are available between coast and ship on a secondary basis when used on or in the vicinity of locks or drawbridges. Normal output power must not exceed 1 watt. Maximum output power must not exceed 10 watts for coast stations or 25 watts for ship stations.
- 6: On the Great Lakes, in addition to bridge-to-bridge communications, 156.650 MHz is available for vessel control purposes in established vessel traffic systems. 156.650 MHz is not available for use in the Mississippi River from South Pass Lighted Whistle Buoy "2" and Southwest Pass entrance Midchannel Lighted Whistle Buoy to mile 242.4 above Head of Passes near Baton Rouge. Additionally it is not available for use in the Mississippi River-Gulf Outlet, the Mississippi River-Gulf Outlet Canal, and the Inner Harbor Navigational Canal, except to aid the transition from these areas.
- 7: Use of 156.375 MHz is available for navigational communications only in the Mississippi River from South Pass Lighted Whistle Buoy "2" and Southwest Pass entrance Midchannel Lighted Whistle Buoy to mile 242.4 above head of Passes near Baton Rouge, and in addition over the full length of the Mississippi River-Gulf Outlet Canal from entrance to its junction with the Inner Harbor Navigation Canal, and over the ull length of the Inner Harbor Navigation Canal from its junction with the Mississippi River to its entry to Lake Pontchartrain at the New Seabrook vehicular bridge.
- 8: Within 120 km (75 miles) of the United States/Canada border, in the area of the Puget Sound and the Strait of Juan de Fuca and its approaches, 157.425 MHz is half of the duplex pair designated as Channel 88. In this area, Channel 88 is available to ship stations for communications with public coast stations only. More than 120 km (75 miles) from the United States/Canada border in the area of the Puget Sound and the Strait of Juan de Fuca, its approaches, the Great Lakes, and the St. Lawrence Seaway, 157.425 MHz is available for intership and commercial communications. Outside Puget Sound area and its approaches and the Great Lakes, 157.425 MHz is also available for communications between commercial fishing vessels and associated aircraft while engaged in commercial fishing activities.
- 9: When the frequency 156.850 MHz is authorized, it may be used additionally for search and rescue training exercises conducted by state or local governments.
- 10: The frequency 156.850 MHz is additionally available to coast stations on the Great Lakes for transmission of scheduled Coded Marine Weather Forecasts (MAFOR), Great Lakes Weather Broadcast (LAWEB) and nscheduled Notices to Mariners or Bulletins. F3C and J3C emissions are permitted. Coast Stations on the Great Lakes must cease weather broadcasts which cause interference to stations operating on 156.800 MHz until the interference problem is resolved.
- 11: The frequency 157.100 MHz is authorized for search and rescuetraining exercises by state or local government in conjunction with U.S. Coast Guard stations. Prior U.S. Coast Guard approval is required. Use must cease immediately on U.S. Coast Guard request.
- 12: The duplex pair for channel 20 (157.000/161.600 MHz) may be used for ship to coast station communications.
- 13: Available for assignment to coast stations, the use of which is in accord with an agreed program, for the broadcast of information to ship stations concerning the environmental conditions in which vessels operate, i.e., weather; sea conditions; time signals; notices to mariners; and hazards to navigation.
- 14: Available only in the Puget Sound and the Strait of Juan de Fuca.
- 15: The frequency 156.525 MHz is to be used exclusively for distress, safety and calling using digital selective calling techniques. No other uses are permitted.
- 16: The frequency 156.450 MHz is available for intership, ship and coast general purpose calling by noncommercial vessels, such as recreational boats and private coast stations.
- 17: The frequency 156.425 MHz is assigned by rule to private coast stations in Alaska for facsimile transmissions as well as voice communications.

## 12. WARRANTY

### Marine Products Limited Warranty

STANDARD HORIZON (a division of VERTEX STANDARD) warrants, to the original purchaser only, each new Marine Communications Product ("Product") manufactured and/or supplied by STANDARD HORIZON against defects in materials and workmanship under normal use and service for a period of time from the date of purchase as follows:

#### **Fixed Mount and Portable Transceivers**

**1 year - if purchased before 01/01/91**

**3 years - if purchased between 01/01/91 and 01/01/94**

**3 years Waterproof - if purchased after 01/01/94**

#### **Loud hailers**

**1 year - if purchased before 01/01/91**

**3 years - if purchased after 01/01/91**

#### **Associated Chargers**

**1 year - if purchased before 01/01/91**

**3 years - if purchased after 01/01/91**

**Associated Batteries** - 18 months. Note: Batteries will be deemed defective only if storage capacity drops below 80% of rated capacity or if leakage develops.

**Associated Accessories** - 1 year. Includes: Microphones/Handsets, External Speakers, Antennas, Carrying Accessories, Power Supplies, and Signaling Boards.

To receive warranty service, the purchaser must deliver the Product, transportation and insurance prepaid, to STANDARD HORIZON (a division of VERTEX STANDARD), Attention Marine repairs 10900 Walker Street, Cypress, CA 90630. Include proof of purchase indicating model, serial number, and date of purchase. STANDARD HORIZON will return the Product to the purchaser freight prepaid. Products purchased prior to January 1, 1991 will bear the STANDARD HORIZON warranty terms in effect prior to that date.

In the event of a defect, malfunction or failure of the Product during the warranty period, STANDARD HORIZON's liability for any breach of contract or any breach of express or implied warranties in connection with the sale of Products shall be limited solely to repair or replacement, at its option, of the Product or part(s) therein which, upon examination by STANDARD HORIZON, appear to be defective or not up to factory specifications. STANDARD HORIZON may, at its option, repair or replace parts or subassemblies with new or reconditioned

parts and subassemblies. Parts thus repaired or replaced are warranted for the balance of the original applicable warranty.

STANDARD HORIZON will not warrant installation, maintenance or service of the Products. In all instances, STANDARD HORIZON's liability for damages shall not exceed the purchase price of the defective Product.

This warranty only extends to Products sold within the 50 States of the United States of America and the District of Columbia.

STANDARD HORIZON will pay all labor to repair the product and replacement parts charges incurred in providing the warranty service except where purchaser abuse or other qualifying exceptions exist. The purchaser must pay any transportation expenses incurred in returning the Product to STANDARD HORIZON for service.

This limited warranty does not extend to any Product which has been subjected to misuse, neglect, accident, incorrect wiring by anyone other than STANDARD HORIZON, improper installation, or subjected to use in violation of instructions furnished by STANDARD HORIZON, nor does this warranty extend to Products on which the serial number has been removed, defaced, or changed. STANDARD HORIZON cannot be responsible in any way for ancillary equipment not furnished by STANDARD HORIZON which is attached to or used in connection with STANDARD HORIZON's Products, or for the operation of the Product with any ancillary equipment, and all such equipment is expressly excluded from this warranty. STANDARD HORIZON disclaims liability for range, coverage, or operation of the Product and ancillary equipment as a whole under this warranty. STANDARD HORIZON reserves the right to make changes or improvements in Products, during subsequent production, without incurring the obligation to install such changes or improvements on previously manufactured Products.

The implied warranties which the law imposes on the sale of this Product are expressly LIMITED, in duration, to the time period specified above. STANDARD HORIZON shall not be liable under any circumstances for consequential damages resulting from the use and operation of this Product, or from the breach of this LIMITED WARRANTY, any implied warranties, or any contract with STANDARD HORIZON. IN CONNECTION WITH THE SALE OF ITS PRODUCTS, STANDARD HORIZON MAKES NO WARRANTIES, EXPRESS OR IMPLIED AS TO THE MERCHANTABILITY OR FITNESS FOR A PARTICULAR PURPOSE OR OTHERWISE, EXCEPT AS EXPRESSLY SET FORTH HEREIN.



Some states do not allow the exclusion or limitation of incidental or consequential damages, or limitation on how long an implied warranty lasts, so the above limitations or exclusions may not apply. This warranty gives specific legal rights, and there may be other rights which may vary from state to state.

ONLY PRODUCTS SOLD ON OR AFTER JANUARY 1, 1991 ARE COVERED UNDER THE TERMS OF THIS LIMITED WARRANTY.

## ON-LINE WARRANTY REGISTRATION

THANK YOU for buying STANDARD HORIZON (a division of Vertex Standard) products! We are confident your new radio will serve your needs for many years!

Please visit [www.standardhorizon.com](http://www.standardhorizon.com) to register the **QUANTUM** Marine VHF. It should be noted that visiting the Web site from time to time may be beneficial to you, as new products are released they will appear on the STANDARD HORIZON Web site. Also a statement regarding product support should be added to the manual.

### Product Support Inquiries

If you have any questions or comments regarding the use of the **QUANTUM**, you can visit the STANDARD HORIZON Web site to send an E-Mail or contact the Product Support team at (714) 827-7600 ext 6300 M-F 7:00-5:00PST.

In addition to the warranty, STANDARD HORIZON includes a lifetime "flat rate" program to provide service after the warranty period has expired. If you wish to obtain the flat rate price for out-of-warranty repair, you must include the information on the Owner's Record with the unit when you return it to your Dealer or to STANDARD HORIZON.

Lifetime Flat Rate Service Program: For the original Owner only, for the lifetime of the unit, STANDARD HORIZON will repair the unit to original specifications.

Note: The flat rate amount is payable by the Owner only if STANDARD HORIZON or the STANDARD HORIZON Dealer determines that a repair is needed. After the repair, a 90-day warranty will be in effect from the date of return of the unit to the Owner.

This service program is not available for equipment which has failed as a result of neglect, accident, breakage, misuse, improper installation or modification, or water damage (depending on the product).

## 13 SPECIFICATIONS

Performance specifications are nominal, unless otherwise indicated, and are subject to change without notice.

### 13.1 GENERAL

Channels .....	All USA, International and Canadian
Input Voltage .....	13.8 VDC $\pm$ 20%
Current Drain	
Standby .....	0.5 A
Receive .....	1.5 A
Transmit .....	5.0 A (Hi); 1.5 A (Lo)
Dimensions .....	3-1/4" H x 7-1/4" W x 6-5/16" D (83 H x 184 W x 135 D mm)
Flush-Mount Dimensions .....	2-5/8" H x 6-5/8" W x 5-1/8" D (67 H x 168 W x 130 D mm)
Weight .....	2.2 lbs (1 kg)

### 13.2 TRANSMITTER

Frequency Range .....	156.025 to 157.425 MHz
RF Output .....	25 W (Hi); 1 W (Lo)
Conducted Spurious Emissions .....	80 dB (Hi); 60 dB (Lo)
Audio Response .....	within $\pm$ 1/-3 of a 6 dB/octave pre-emphasis characteristic at 300 to 3000 Hz
Audio Distortion .....	5 %
Modulation .....	16K0G3E, for DSC 16K0G2B
Frequency Stability (-20°C to +50°C) .....	$\pm$ 0.0005%
FM Hum and Noise .....	50 dB

### 13.3 RECEIVER

Frequency Range .....	156.050 to 163.275 MHz
Sensitivity	
20 dB Quieting .....	0.35 $\mu$ V
12 dB SINAD .....	0.25 $\mu$ V
Squelch Sensitivity (Threshold) .....	0.13 $\mu$ V
Modulation Acceptance Bandwidth .....	$\pm$ 7.5 kHz
Selectivity	
Spurious and Image Rejection .....	better than -70 dB
Intermodulation and Rejection at 12 dB SINAD .....	better than -70 dB
Audio Output .....	4.5 W
Audio Response .....	within $\pm$ 2/-8 of a 6 dB/octave de-emphasis characteristic at 300 to 3000 Hz
Frequency Stability (-20°C to +50°C) .....	$\pm$ 0.0005 %
Channel Spacing .....	25 kHz
DSC Format .....	RTCMSC101
NMEA Input/Output .....	Output - DSC, DSE Input - GLL, GGA, RMC and GNS





**Marine Division of VERTEX STANDARD**  
**US Headquarters**  
10900 Walker Street, Cypress, CA 90630, U.S.A.  
**[www.standardhorizon.com](http://www.standardhorizon.com)**



Copyright 2003  
VERTEX STANDARD CO., LTD.  
All rights reserved.

No portion of this manual  
may be reproduced  
without the permission of  
VERTEX STANDARD CO., LTD.

0306R-0Y