

YAESU
The radio

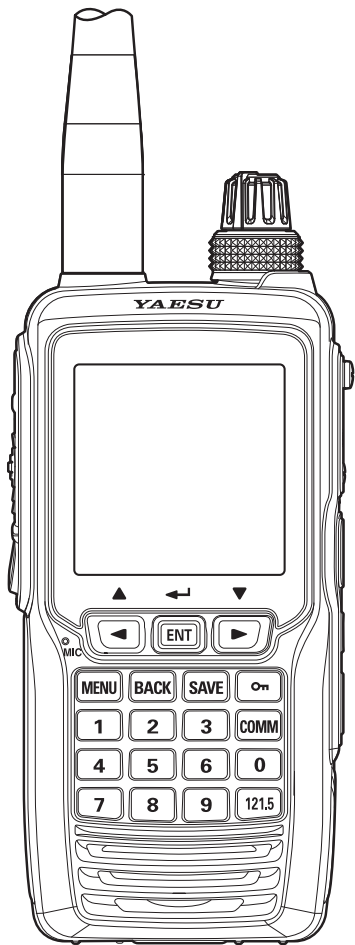

AIR BAND TRANSCEIVER

FTA-750
FTA-550

Operating Manual

CONTENTS

| | | | |
|--|----|---|----|
| Important Notice! | 1 | Saving the Battery during Reception | 39 |
| Introduction | 2 | VOX Operation..... | 40 |
| Accessories & Options | 3 | Side Tone Control | 41 |
| Supplied Accessories | 3 | ANL Feature | 41 |
| Available Options | 3 | Lock Function | 42 |
| Controls & Connectors (Top Panel) | 4 | Memory Operation | 44 |
| LCD Display (COM Band) | 8 | Recalling the Memories..... | 44 |
| Before You Begin | 11 | Instant Storage | 46 |
| Battery Installation and Removal | 11 | Maintenance of the Memory..... | 47 |
| Battery Charging..... | 11 | Scanning Operation | 51 |
| Alkaline Battery Case Installation | 12 | Scanning All Channels..... | 51 |
| Low Battery Indication | 12 | Scanning the Specified Channels..... | 52 |
| External DC Power Supply Connection | 13 | GPS Function (FTA-750 Only) | 54 |
| Antenna Installation..... | 13 | Activating the GPS Unit..... | 54 |
| Belt Clip Installation..... | 14 | Displaying the Position Information..... | 55 |
| Headset Connection..... | 14 | Memorizing the Position Information | 57 |
| Precautions..... | 15 | Recording the Position Information | 58 |
| Basic Operation | 16 | Waypoint Navigation (FTA-750 Only) | 59 |
| Reception (COM Band)..... | 16 | Entering the Navigation (NAVI) Mode | 59 |
| Accessing the 121.5 MHz Emergency Frequency..... | 19 | Setting the Destination..... | 60 |
| Transmission (COM Band)..... | 20 | Starting the Navigation to the Receiving Station | 62 |
| Operation Bands | 21 | SETUP Mode | 63 |
| Operation Modes | 22 | Basic Operation | 63 |
| Resetting the Radio..... | 23 | Maintenance of the Memory..... | 64 |
| Advanced Operation | 25 | Setting of the COMM Mode Operation..... | 65 |
| Reception of VOR Signals..... | 25 | Setting of the GPS Mode Operation (FTA-750 Only)..... | 67 |
| Reception of ILS Signals..... | 27 | Setting of the Operation and Configuration of the Radio..... | 71 |
| Split Operation..... | 29 | About the Radio..... | 74 |
| Reception of Weather Channel Broadcasts (USA version only)..... | 31 | Specifications | 75 |
| Dual Watch Operation | 33 | | |
| Timer Mode Operation | 35 | | |
| TOT Feature..... | 39 | | |

IMPORTANT NOTICE!

FCC RF Exposure Compliance Requirements for Occupational Use Only:

The **FTA-750/FTA-550** have been tested and complies with the Federal Communications Commission (FCC) RF exposure limits for Occupational Use/Controlled Exposure Environment. In addition, it complies with the following Standards and Guidelines:

- FCC 96-326, Guidelines for Evaluating the Environmental Effects of Radio-Frequency Radiation.
- FCC OET Bulletin 65 Edition 97-01 (1997) Supplement C, Evaluating Compliance with FCC Guidelines for Human Exposure to Radio Frequency Electromagnetic Fields.
- ANSI/IEEE C95.1-1992, IEEE Standard for Safety Levels with Respect to Human Exposure to Radio Frequency Electromagnetic Fields, 3 kHz to 300 GHz.
- ANSI/IEEE C95.3-1992, IEEE Recommended Practice for the Measurement of Potentially Hazardous Electromagnetic Fields - RF and Microwave.
- **This radio is NOT approved for use by the general population in an uncontrolled environment. This radio is restricted to occupational use, work related operations only where the radio operator must have the knowledge to control its RF exposure conditions.**
- **When transmitting, hold the radio in a vertical position with its microphone 1 to 2 inches (2.5 to 5 cm) away from your mouth and keep the antenna at least 1 inch (2.5 cm) away from your head and body.**
- **The radio must be used with a maximum operating duty cycle not exceeding 50%, in typical Push-to-Talk configurations. DO NOT transmit for more than 50% of total radio use time (50% duty cycle). Transmitting more than 50% of the time can cause FCC RF exposure compliance requirements to be exceeded.**
The radio is transmitting when the “TX” icon is displayed on the upper left corner of the screen of the radio. You can cause the radio to transmit by pressing the PTT button.
- **Always use YAESU authorized accessories.**

NOTICE

There are no user-serviceable points inside this transceiver.
All service jobs must be referred to your Authorized Service Center.

INTRODUCTION

The YAESU **FTA-750/FTA-550** are compact, stylish, solid hand-held transceivers providing communication (transmit and receive) capability on the International Aircraft Communication Band (“COM” band: 118 to 136.975 MHz), and they additionally provide VOR and ILS navigation features on the “NAV” band (108 to 117.975 MHz).

The **FTA-750/FTA-550** boast a 1.7 x 1.7 inch full dot matrix LCD displaying a plenty of information in a row, with our exclusive Omni-Glow™ display back-lighting for minimal degradation of your night vision. The **FTA-750/FTA-550** include NOAA weather band monitoring and 200 memory channels. The channel configurations can be easily reprogrammed in minutes using the optional PC Programming Kit and your PC. In addition, the **FTA-750** provides positioning and navigation features realized by the internal GPS unit.

We recommend that you read this manual in its entirety, so as to understand the many features of the **FTA-750/FTA-550** completely. Keep this manual handy, so you may use it for reference.

Congratulations!

You now have at your fingertips a valuable communications tool, a YAESU two-way radio! Rugged, reliable and easy to use, your YAESU radio will keep you in constant touch with your friends and colleagues for years to come, with negligible maintenance or down-time.

Please take a few minutes to read this manual carefully. The information presented here will allow you to derive maximum performance from your radio, in case questions arise later on.

We’re glad you joined the YAESU team. YAESU products cover the entire spectrum of radio communications applications, and our worldwide support network is here to serve you. Let us help you get your message across.

ACCESSORIES & OPTIONS

Supplied Accessories

Lithium-ion Battery Pack (7.4V)
AC Charger
Charger Cradle
Cigarette Lighter DC/DC Converter

Helical Antenna
Belt Clip
Headset Cable
Alkaline Battery Case
USB Cable
Operating Manual
Warranty Card

SBR-12LI^{*1}
SAD-11^{*1}
SBH-11^{*1}
SDD-11^{*2}
SDD-12^{*3}
SRA-13A^{*4}
SHB-11
SCU-15
SBT-12
T9101606

Available Options

SSM-10A Speaker Microphone
YCE01 PC Programming Kit

Availability of accessories may vary. Some accessories are supplied as standard per local requirements, while others may be unavailable in some regions. Consult your YAESU Dealer for details regarding these and any newly-available options.

Connection of any non-YAESU-approved accessory, should it cause damage, may void the Limited Warranty on this apparatus.

- *1 FTA-750 only. Separately available for the FTA-550.
- *2 For FTA-***
- *3 For FTA-***
- *4 Antenna gain: 2.15 dBi
Impedance: 50 ohm

CONTROLS & CONNECTORS (TOP PANEL)

① **Antenna Jack**

This BNC connector accepts the supplied flexible antenna, or another antenna designed to provide 50 Ω impedance on the Aircraft Communication Band.

② **VOLUME (Inner) Knob**

Turn this (inner) control clockwise to increase the volume.

③ **DIAL Selector (Outer) Knob**

This (outer) 20-position detented rotary switch tunes the operating frequency or selects the memory channels.

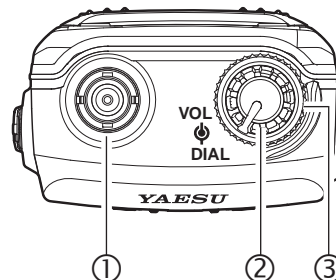

CONTROLS & CONNECTORS (FRONT PANEL)

① LCD (Liquid Crystal Display)

The display shows selected operating conditions, as indicated on Pages 8 to 10.

② Microphone

Speak across this opening in a normal voice level, while pressing the **PTT** switch, to transmit.

③ Cursor Keys and **ENT** Key

The cursor keys are used to select an item displayed on the LCD.

Press the **ENT** key to determine the selection or entered values.

④ Control Keys

Press the **MENU** key to display the MENU screen.

Press the **BACK** key to turn the display to the previous screen.

Press the **SAVE** key to store the current channel information to the memory.

Press and hold the lock key [**On**] to disable the controls with the keys and knobs.

⑤ **COMM** Key

Press this key to enter the COMM mode instantly.

⑥ Numeric Keypad

The keypad is used when setting frequencies.

⑦ **121.5** Key

Press and hold this key to access the emergency frequency (121.5 MHz) instantly.

⑧ Loudspeaker

The internal speaker is located in this position.

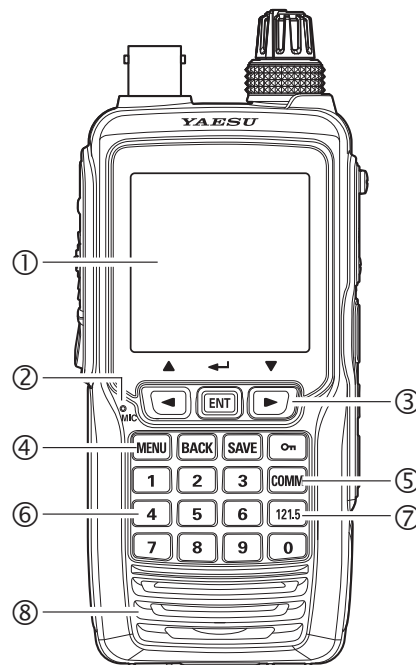

CONTROLS & CONNECTORS (LEFT SIDE)

① **POWER** Switch

Press and hold this button to turn the radio on and off.

② **PTT** (Push To Talk) Switch

Press and hold this button to transmit when you are operating in the COM band. Release this button to return to the “Receive” mode. See Page 20 for details.

③ **SQL** (Squelch) Switch

This button may be pressed to “open” the squelch manually, allowing you to listen for very weak signals. Press and hold this button for 2 seconds to “open” the squelch continuously. Press this button again to resume normal (quiet) monitoring. See Page 18 for details.

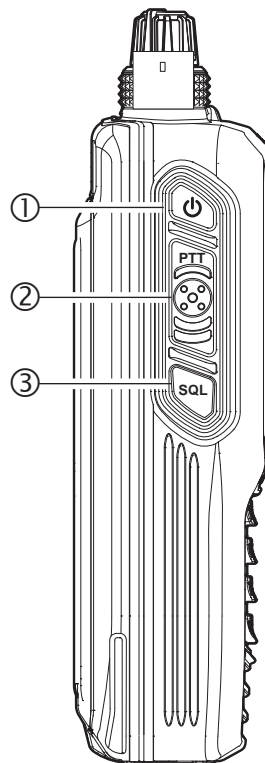

CONTROLS & CONNECTORS (RIGHT SIDE)

① MIC/SP Jack

You may connect the supplied **SCU-15** Headset Cable or the optional **SSM-10A** Speaker/Microphone to this jack. To use this jack, you must first remove the cover from the transceiver body.



*Do not allow the **FTA-750/FTA-550** to become submerged in water while the cover over the **MIC/SP** jack is removed.*

② DATA Jack

You may connect the optional USB cable to this jack. To use this jack, you must first lift the rubber cover away from the transceiver body.

③ EXT DC Jack

When an external 10.5-Volt DC power source is available, you may connect the **SDD-11/SDD-12** Cigarette Lighter DC/DC Converter here.



*1) Do not allow the **FTA-750/FTA-550** to become submerged in water while the rubber cover is removed.*

*2) Do not connect any accessory unapproved by **YAESU** to supply DC power.*

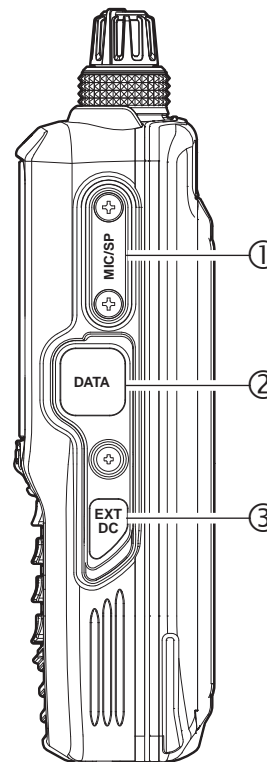

LCD DISPLAY (COM BAND)

“BUSY” icon appears during audio reception, or “TX” during transmission.

This field displays the icons indicating various statuses of the transceiver, such as “GPS on”, “Data Logger on”, “Timer on”, “Battery full”, etc.

This field displays the operation modes.

This field displays the tag name of the current channel.

This field displays the level of the audio volume or the squelch.

This field displays the channels you have previously used.

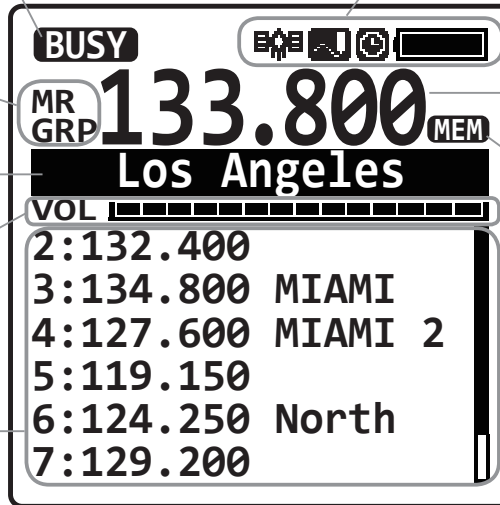

This field displays the operating frequency.

“MEM” icon appears if the channel is set to the target of the memory scan.

LCD DISPLAY (NAV BAND)

VOR CDI SCREEN

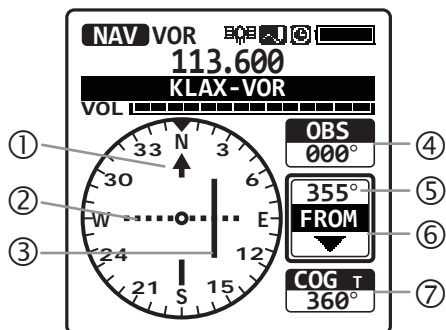

- ① Course indicator
- ② Deviation marks
- ③ Course deviation needle
- ④ OBS (omni bearing selector) value
- ⑤ VOR value
- ⑥ TO/FROM indicator
- ⑦ COG (course over ground) value according to the GPS signal

ILS CDI SCREEN

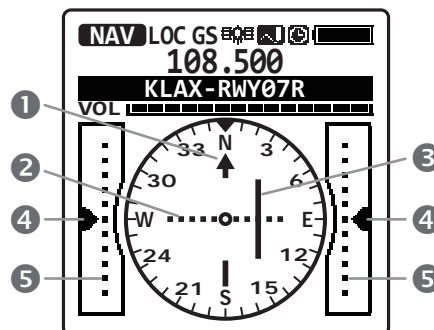

- ① Course indicator
- ② Deviation marks for localizer
- ③ Course deviation needle for localizer
- ④ Height deviation indicator for glide slope
- ⑤ Deviation marks for glide slope

LCD DISPLAY (GPS MODE: FTA-750 ONLY)

GPS INFORMATION SCREEN

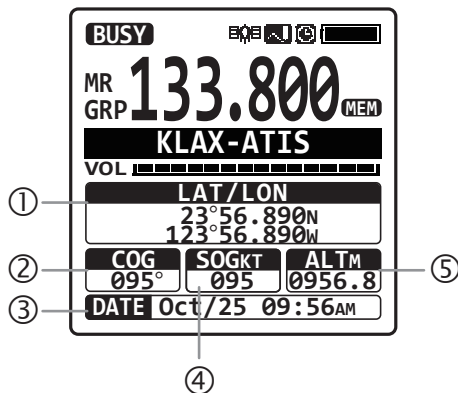

- ① Latitude and longitude values
- ② COG (course over ground) value
- ③ Date obtained from the GPS signal
- ④ SOG (speed over ground) value
- ⑤ Altitude value

COMPASS SCREEN

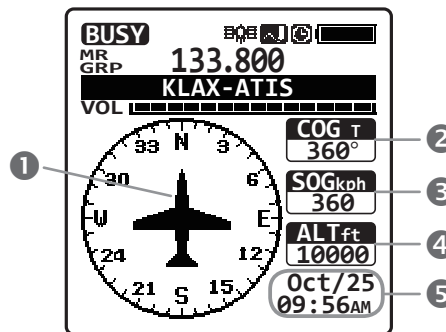

- ① Course indicator
- ② COG (course over ground) value
- ③ SOG (speed over ground) value
- ④ Altitude value
- ⑤ Date obtained from the GPS signal

BEFORE YOU BEGIN

Battery Installation and Removal

- ❑ To install the battery, insert the battery pack into the battery compartment on the back of the radio, press the end of the battery pack while pressing the battery pack latch on the bottom of the radio, then lock the pack by sliding the locking plate beside the latch until the entire “LOCK” appears.
- ❑ To remove the battery, turn the radio off, slide the locking plate until the “UNLOCK” appears entirely, lift up the end of the battery pack while pressing the battery pack latch, then pull out the battery from the radio.

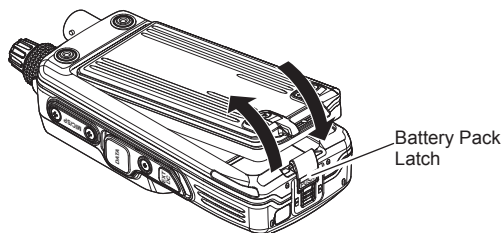

Do not attempt to open any of the rechargeable Lithium-ion packs, as personal injury or damage to the Lithium-ion pack could occur if a cell or cells become accidentally short-circuited.

Battery Charging

It is necessary to charge the Lithium-ion battery fully before its first use. Follow the procedures below:

1. Install the supplied Lithium-ion battery pack onto the transceiver. Ensure that the transceiver is switched off.
2. Insert the cable plug of the **SAD-11** Battery Charger into the jack located on the back of the **SBH-11** Charging Cradle, then plug the **SAD-11** into the AC line outlet.

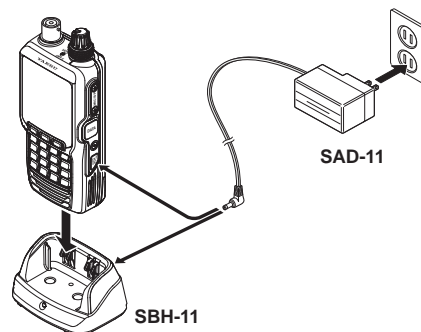

3. Insert the transceiver into the **SBH-11**; the antenna jack should be at the left side when viewing the cradle from the front.

BEFORE YOU BEGIN

- ❑ You may insert the cable plug of the **SAD-11** into the **EXT DC** jack located on the right side of the transceiver directly.
- 4. If the transceiver is inserted correctly, the RED indicator on the **SBH-11** will glow. A fully-discharged pack will be charged completely in 4 hours.
 - ❑ It takes 5 hours for full charge with the **SAD-11** connected to the transceiver directly.

Important Notes:

- The **SAD-11** is not designed to power the transceiver for operation (transmission).
- Do not leave the charger connected to the transceiver for continuous periods in excess of 24 hours. Long term overcharging can degrade the Lithium-ion battery pack and significantly shorten its useful life.
- If using a charger other than the **SAD-11**, **SBH-11**, or if using a battery pack other than the **SBR-12LI**, follow the appropriate instructions provided with the charger/battery. Contact your Dealer if you have any doubts about the appropriateness of the particular charger or battery pack you intend to use.

Alkaline Battery Case Installation

The supplied **SBT-12** Battery Case allows operation of the **FTA-750/FTA-550** using six “AA” size Alkaline batteries.

When installing batteries, insert the (–) end first, then press in the (+) end so the battery snaps into place. Always replace all six batteries at the same time, paying attention to the polarity indicated inside the case.



The SBT-12 must not be used with rechargeable cells. The SBT-12 does not contain the thermal and over-current protection circuits (provided in the “SBR” series of Lithium-ion Battery Packs) required when utilizing Ni-Cd and Ni-MH cells.

Low Battery Indication

- ❑ As your battery discharges during use, the voltage will gradually become lower. When the battery voltage reaches 6.0 Volts, the “” icon will blink on the LCD display indicating that the battery pack must be recharged before further use.
- ❑ Avoid recharging Lithium-ion batteries before the “Low Battery” indicator is observed, as this can degrade the charge capacity of your Lithium-ion battery pack. YAESU recommends that you carry an extra, fully-charged pack with you so you will not lose communications capability due to a depleted Lithium-ion battery.

BEFORE YOU BEGIN

External DC Power Supply Connection

- ❑ You may insert the cable plug of the optional **SDD-11/SDD-12** Cigarette Lighter DC/DC Converter into the **EXT DC** jack located on the right side of the transceiver. When making DC connections via the **SDD-11/SDD-12**, be absolutely certain to observe the proper voltage level and polarity guidelines.
 - The **SDD-11/SDD-12** can be connected to 12 to 24 Volt DC power sources.

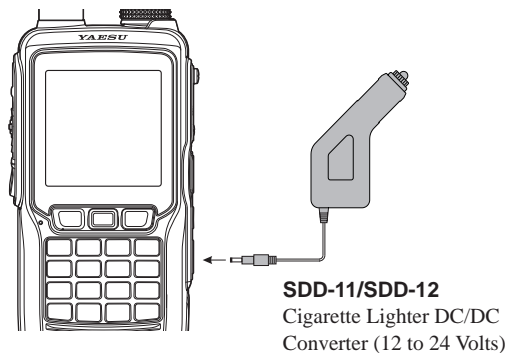

Do not connect any accessory unapproved by YAESU to supply DC power; otherwise the FTA-750/FTA-550 may be damaged.

Antenna Installation

- ❑ To attach the supplied antenna to the **FTA-750/FTA-550**, grasp the base of the antenna firmly, and exert a moderate “pinching” pressure on the base as you press the antenna onto the radio’s antenna connector. While exerting this pressure, rotate the antenna clockwise 1/4 turn to lock the antenna in place.

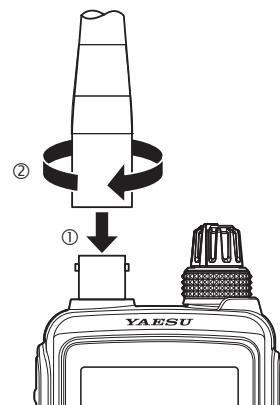

BEFORE YOU BEGIN

Belt Clip Installation

- Mount the clip to the rear of the **FTA-750/FTA-550** using the supplied screws.

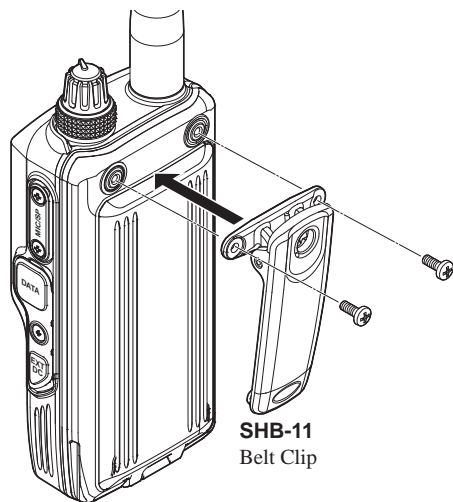

Headset Connection

- You may use an optional headset through the supplied **SCU-15** Headset Cable by connecting to the **MIC/SP** jack located on the right side of the transceiver.

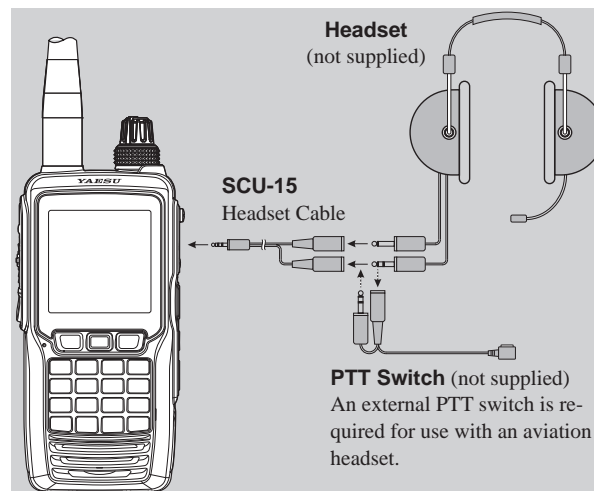

BEFORE YOU BEGIN

Precautions

- The **FTA-750/FTA-550** are capable of two-way communication on channels used for critical aviation safety communications. Therefore, it is important that this radio be kept away from children or other unauthorized users at all times.
- Do not dispose of the Lithium-ion battery pack in a fire. Do not carry a Lithium-ion battery pack in your pocket, where keys or coins could short the terminals. This could create a serious fire/burn danger, and possibly cause damage to the Lithium-ion pack.
- The **FTA-750/FTA-550** are designed to have the waterproof capability equivalent to IPX-5. Do not allow the radio to become submerged, and do not subject it to water spray under pressure.

BASIC OPERATION

Reception (COM Band)

Turning on and off the radio

- ❑ To turn the radio on, press and hold the **POWER** switch. The **WARNING** message will be displayed.

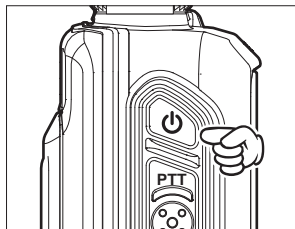

- ❑ If you agree with the message, press the **[ENT]** key.

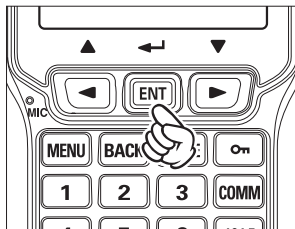

- ❑ A channel frequency will appear on the display. If not, press the **[COMM]** key.

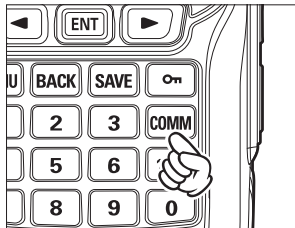

- ❑ The “**BUSY**” icon appears on the display when the audio signal is received on the current frequency.

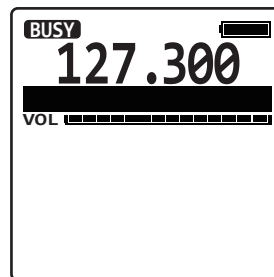

- ❑ To turn the radio off, press and hold the **POWER** switch.

BASIC OPERATION

Adjusting the frequency

- ❑ You may turn the **DIAL** selector (outer) knob on the top panel to choose the desired operating frequency. The channel frequency will appear on the LCD.

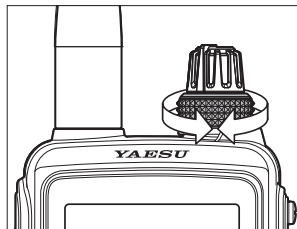

- ❑ Directly entering frequencies from the keypad is the easiest method if you know the frequency on which you wish to operate. Just enter the five digits of the frequency to move to that frequency.

For example, to set 134.35 MHz,
 press [1] → [3] → [4]
 → [3] → [5].

To set 118.275 MHz,
 you do not need to
 press the final “5” in the
 frequency as below:

[1] → [1] → [8] → [2]
 → [7].

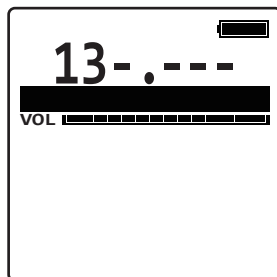

- ❑ You may recall the operating frequency that you have used by pressing the [◀] or [▶] key.

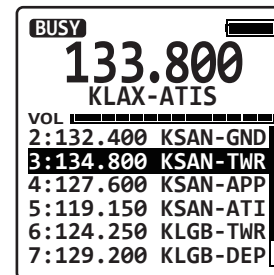
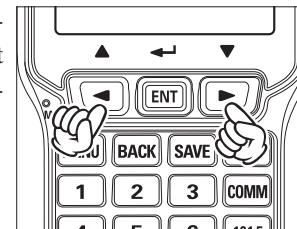

BASIC OPERATION

Adjusting the volume

- Rotate the **VOL** (inner) knob to set the volume level. If no signal is present, press the **SQL** switch; background noise will now be heard, and you may use this noise to set the **VOL** knob for the desired audio level. Press and hold the **SQL** switch to silence the noise and resume normal (quiet) monitoring.

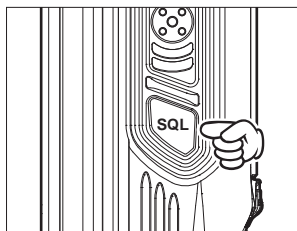
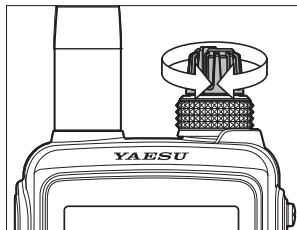

Adjusting the squelch

- Press the **SQL** switch, then rotate the **DIAL** selector knob or press the [◀] or [▶] key to set the squelch threshold (0 to 15) so that the receiver is just silenced. A higher number indicates that a higher signal level is required in order to open the squelch.

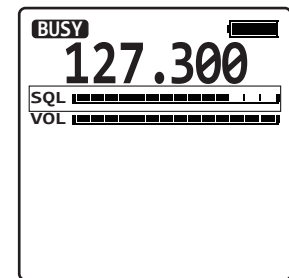
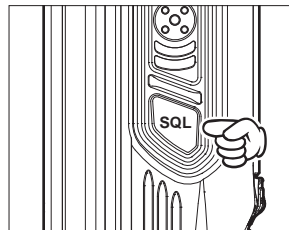

- Press and hold the **SQL** switch to set the squelch threshold to 0 (off).
- Your new setting will be saved each time you perform either of the operations above.

BASIC OPERATION

Monitor Switch

When listening to a very weak signal from an aircraft or ground station, you may observe the signal disappearing periodically as the incoming signal strength becomes too weak to override the squelch threshold setting.

To disable the squelch temporarily, press and hold the **SQL** switch for 2 seconds. The squelch will remain open and you should have a better chance of hearing weak signals.

To return to normal operation, press the **SQL** or the **PTT** switch momentarily.

Accessing the 121.5 MHz Emergency Frequency

The **FTA-750/FTA-550** can quickly access the 121.500 MHz emergency frequency. This function can be activated even when the keypad lock function (described on Page 42) is in use.

- ❑ To access the emergency frequency, press and hold the [121.5] key. After four beeps, the transceiver enters the emergency mode and the frequency is automatically tuned to 121.500 MHz.

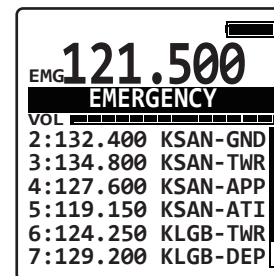
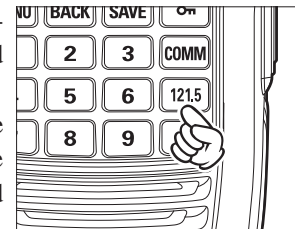

- ❑ To exit the emergency mode, press the [COMM] key. The message confirming the cancelation of the emergency mode will appear. Press the [◀] or [▶] key to select "YES", then press the [ENT] key.

BASIC OPERATION

Transmission (COM Band)

- To transmit, press and hold the **PTT** switch. Speak into the microphone area of the front panel grille in a normal voice level.

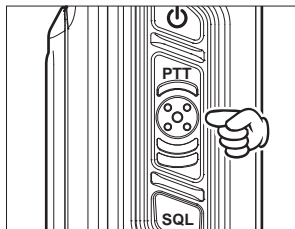

The “TX” icon, which indicates that the **FTA-750/FTA-550** are in the transmit mode, appears on the display.

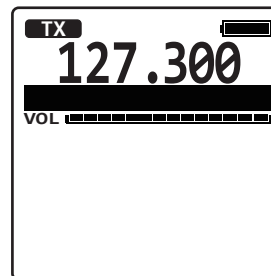

- To return to the receive mode, release the **PTT** switch.

Operating Advice: Use of Internal Microphone

Your **FTA-750/FTA-550** are extensively sealed against water ingress, so as to ensure reliable operation even if it has become submerged. This unique construction includes waterproofing seals around the microphone and speaker enclosure, requiring that care be exercised when speaking into the internal microphone.

Please refer to the illustration, and observe the location of the internal microphone. It is important that you focus your speech in the direction of the microphone’s location, so as to ensure sufficient voice input to the radio.

If you find it difficult to utilize the **FTA-750/FTA-550** conveniently and safe while speaking directly into the microphone, we recommend the use of the **SSM-10A** Speaker/Microphone (option), or an after-market aviation headset/boom microphone.

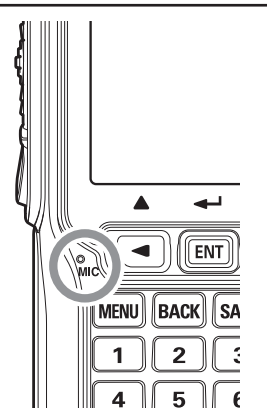

BASIC OPERATION

Operation Bands

When the **FTA-750/FTA-550** are turned on for the first time, it enters the COMM mode and displays the COM band screen. The COMM mode is the basic operation mode of the **FTA-750/FTA-550** that allows you to tune through either of the NAV and COM bands using the **DIAL** knob or the keypad.

- **NAV band (108.000 - 117.975 MHz):**
 Band for navigation utilizing data signals emitted by VOR (VHF omnidirectional range) stations and ILS (instrument landing system) of airports.
- **COM band (118.000 - 136.975 MHz):**
 Band for communication utilizing audio signals.

When the **FTA-750/FTA-550** receive a data signal associated with VOR or ILS, the display will automatically switch to the NAV band screen which shows a CDI (course deviation indicator) based on the received signal, and “NAV”, which indicates that the **FTA-750/FTA-550** are on the NAV band, appears on the display.

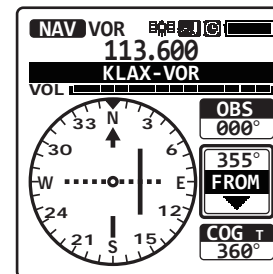

BASIC OPERATION

Operation Modes

The **FTA-750/FTA-550** operate in either of the modes below. You can switch the modes via the MENU screen displayed by pressing the [MENU] key on the front panel.

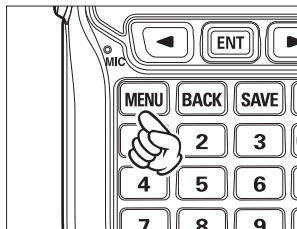

When turning on the **FTA-750/FTA-550**, the last mode you have used before turning off will automatically be entered.

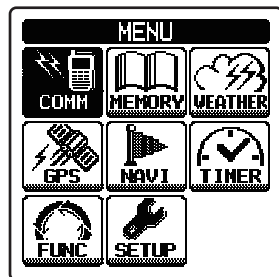

- **COMM**

The basic operating mode for communication. Navigation through the NAV band is also performed on this mode.

- **MR (MEMORY)**

This mode provides you with the ability to store and recall as many as 200 channels in the radio's main memory bank.

- **WX (USA version only)**

The receive mode for the VHF weather channel broadcasts. 10 weather channels are pre-programmed at the factory.

- **GPS (FTA-750 only)**

The position information and status of the GPS satellites according to the signals received by the built-in GPS unit are displayed during this mode.

- **NAVI (FTA-750 only)**

Navigation to the waypoint (destination) memorized or manually input is carried out in this mode.

- **SETUP**

This mode allows certain aspects of your radio's configuration to be customized for your personal operating conditions.

BASIC OPERATION

Convenient menu items

The MENU screen also includes the following items which provide advanced and convenient usage of the **FTA-750/FTA-550**.

○ **TIMER**

You may use the **FTA-750/FTA-550** as a count-down timer or a stopwatch through this menu.

○ **FUNCTION**

Enables and disables various functions such as scan and dual watch features through this menu.

Resetting the Radio

To clear all memories and other settings to factory defaults:

1. Press the [**MENU**] key to display the MENU screen.
2. Select “SETUP” on the screen by pressing the [**◀**] or [**▶**] key, and then press the [**ENT**] key.

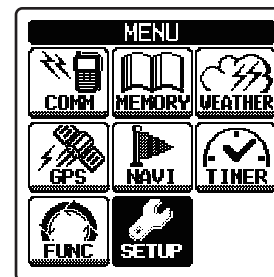

3. Select “CONFIGURATION” on the screen by pressing the [**◀**] or [**▶**] key, and then press the [**ENT**] key.

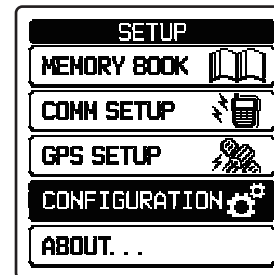

BASIC OPERATION

4. Select “RESET” on the screen by pressing the [◀] or [▶] key, and then press the [ENT] key.

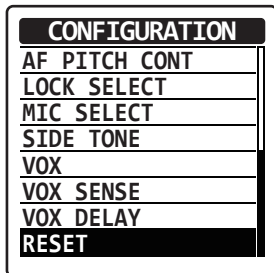

The initialization will start and then “COMPLETED!” will be displayed after the radio returns to factory default.

5. Select “FACTORY” on the screen by pressing the [◀] or [▶] key, and then press the [ENT] key.

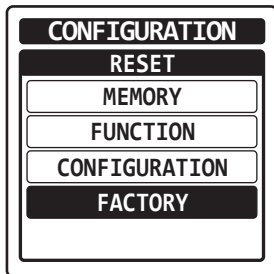

6. Select “OK?” on the screen by pressing the [◀] or [▶] key, and then press the [ENT] key.

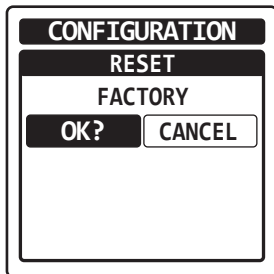

ADVANCED OPERATION

Reception of VOR Signals

When the **FTA-750/FTA-550** receive a VOR (VHF omnidirectional range) signal, the display will automatically switch to the NAV band screen which shows a CDI (course deviation indicator) based on the received signal, and “VOR”, which indicates that the **FTA-750/FTA-550** are receiving the VOR signal, appears on the display.

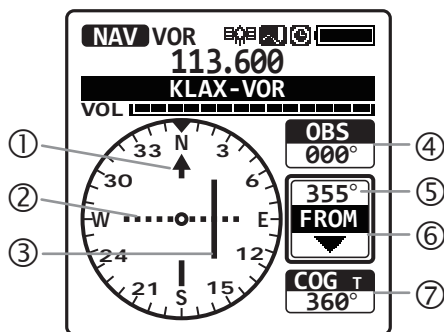

- ① Course indicator
- ② Deviation marks
- ③ Course deviation needle
- ④ OBS (omni bearing selector) value
- ⑤ VOR value
- ⑥ TO/FROM indicator
- ⑦ COG (course over ground) value according to the GPS signal

- The OBS will be set to the direction (0 to 359 degrees) included in the received VOR signal until you set a new one.
- When the internal GPS unit is not activated or cannot receive a fix even it is activated, the top of the compass rose always indicates the direction set as the OBS.
 When the internal GPS unit is activated and receives a fix, the compass rose rotates to display the traveling direction always at the top.
- The COG is displayed only when the internal GPS unit is activated and receives a fix.

Note:

The internal GPS unit is inactive in the factory default. Activate it via the SETUP mode (see Page 54) if necessary.

ADVANCED OPERATION

Flying to a desired course

If you know the direction of your destination from a specific VOR station, you may use the CDI to correct your course of flying.

1. Set the frequency to the desired VOR station.
2. Press the [◀] or [▶] key to select “OBS” on the screen.

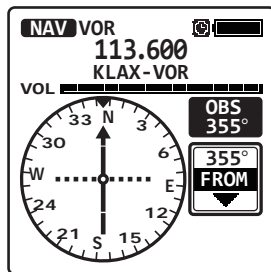

3. Enter the course from the VOR station with the keypad or the DIAL knob.

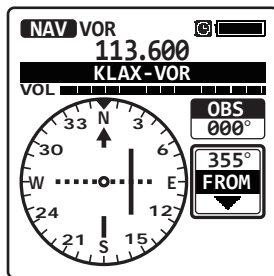

4. Correct your course until the course deviation needle on the screen is at the center of the compass rose.
 - The course deviation needle moves to the right if your aircraft is off course to the left of the OBS, or moves to the left if your aircraft is off course to the right of the OBS.
 - The deviation marks indicate off-course level by 2 degrees up to 10 degrees per each side. If your deviation exceeds 10 degrees, the course deviation needle will stay at the position of the fifth mark (the end of the scale) of the left or right side.

Flying to a VOR station

1. Set the frequency to the desired VOR station.
2. Press the [◀] or [▶] key to select “OBS” on the screen.

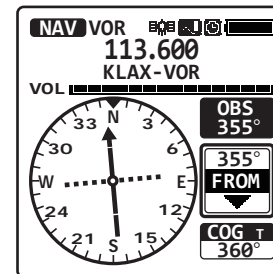

ADVANCED OPERATION

- Enter the course to the VOR station with the keypad or the **DIAL** knob.

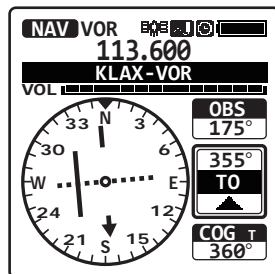

- Correct your course until the course deviation needle on the screen is at the center of the compass rose.

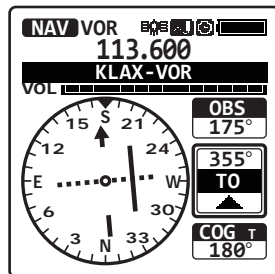

Reception of ILS Signals

When the **FTA-750/FTA-550** receive an ILS (instrument landing system) signal, the display will automatically switch to the NAV band screen which shows a CDI (course deviation indicator) based on the received signal, and “LOC”, which indicates that the **FTA-750/FTA-550** are receiving the localizer signal, and “GS”, which indicates that the **FTA-750** is receiving the glide slope signal, appear on the display.

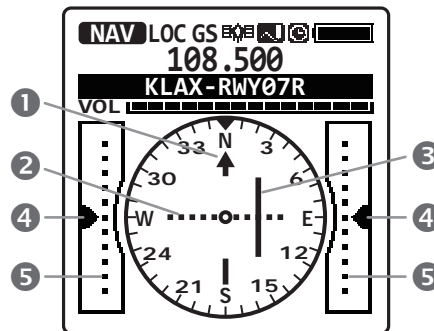

- Course (runway) indicator
- Deviation marks for localizer
- Course deviation needle for localizer
- Height deviation indicator for glide slope
- Deviation marks for glide slope

ADVANCED OPERATION

- When the internal GPS unit is not activated or cannot receive a fix even it is activated, the top of the compass rose always indicates the direction of the runway and no sign indicating the bearings is displayed on the compass rose.
- When the internal GPS unit is activated and receives a fix, the compass rose rotates to display the approaching direction always at the top.

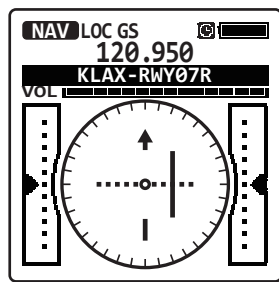

Without GPS



With GPS, no GS signal

Note:

The internal GPS unit is inactive in the factory default. Activate it via the SETUP mode (see Page 54) if necessary.

- The course deviation needle moves to the right if your aircraft is off course to the left of the runway, or moves to the left if your aircraft is off course to the right of the runway.

The deviation marks for localizer indicate off-course level by 0.5 degrees up to 2.5 degrees per each side. If your deviation exceeds 2.5 degrees, the course deviation needle will stay at the position of the fifth mark (the end of the scale) of the left or right side.

- The height deviation indicator moves up if your aircraft flies lower than the ideal altitude, or moves down if your aircraft flies higher than the ideal altitude.

The deviation marks for glide slope indicate off-height level by 0.14 degrees up to 0.7 degrees per each side. If your deviation exceeds 0.7 degrees, the height deviation indicator will stay at the position of the fifth mark (the end of the scale) of the upper or lower side.

ADVANCED OPERATION

Split Operation

The split operation feature allows you to transmit a call to a flight service station using the COM band frequencies, while receiving a station in the NAV band. VOR stations equipped with this capability typically are shown, on navigation charts, with the voice calling frequency in parenthesis above the navigation frequency.

Programming a transmit frequency

1. Press the [MENU] key to display the MENU screen.
2. Select “SETUP” on the screen by pressing the [◀] or [▶] key, and then press the [ENT] key.

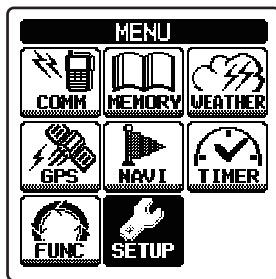

3. Select “COMM SETUP” on the screen by pressing the [◀] or [▶] key, and then press the [ENT] key.

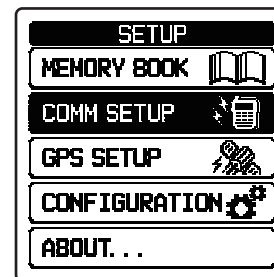

4. Select “SPLIT FREQUENCY” on the screen by pressing the [◀] or [▶] key, and then press the [ENT] key.

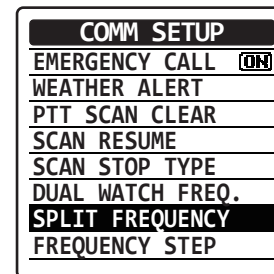

5. Enter the transmit frequency with the keypad.

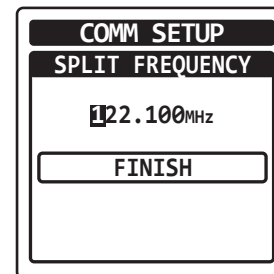

ADVANCED OPERATION

6. Select “FINISH” on the screen by pressing the [◀] or [▶] key, and then press the [ENT] key.

The frequency will be determined and the display will return to the COMM SETUP menu.

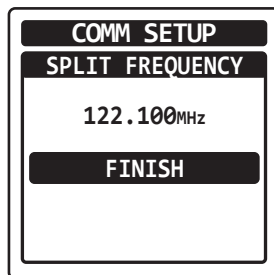

Note:

Either of the COM band frequencies only can be set as the transmit frequency.

Activating the split mode

1. Press the [MENU] key to display the MENU screen.
2. Select “FUNC” on the screen by pressing the [◀] or [▶] key, and then press the [ENT] key.

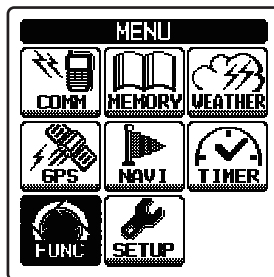

3. Select “SPLIT” on the screen by pressing the [◀] or [▶] key, and then press the [ENT] key.

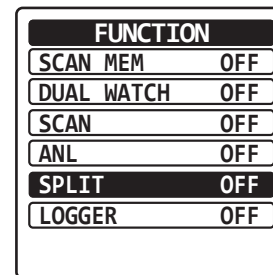

- If “ON” is displayed in the right hand of “SPLIT”, the **FTA-750/FTA-550** are already in the split mode.

The display will return to the previous screen and “±”, which indicates that the **FTA-750/FTA-550** are in the split mode, will appear on the display.

ADVANCED OPERATION

Operating in the split mode

- ❑ To transmit a voice call during the NAV band reception, press and hold the **PTT** switch, and speak into the microphone. The COM band screen will be displayed with the frequency you have set.
- ❑ To exit the split mode, select “SPLIT” and press the [ENT] key in the FUNCTION menu.

| FUNCTION | |
|--------------|-----------|
| SCAN MEM | OFF |
| DUAL WATCH | OFF |
| SCAN | OFF |
| ANL | OFF |
| SPLIT | ON |
| LOGGER | OFF |

Reception of Weather Channel Broadcasts (USA version only)

The **FTA-750/FTA-550** can receive VHF weather channel broadcasts, which may assist your flight planning. The **FTA-750/FTA-550** include a special bank capable of storing 10 weather channels, which simplifies your access when you are in an unfamiliar location.

- ❑ To receive weather channels, press the [MENU] key, select “WEATHER” on the screen by pressing the [◀] or [▶] key, and then press the [ENT] key. “WX”, which indicates that the **FTA-750/FTA-550** are in the WX mode, appears on the display. The last channel you have tuned will be received.

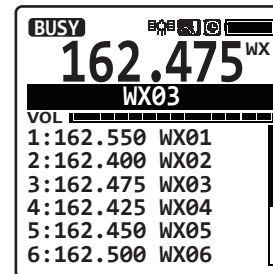
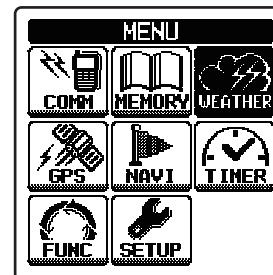

ADVANCED OPERATION

- ❑ You can also select a weather channel from the pre-programmed list with the **DIAL** selector knob.

To confirm the weather channel frequency selection, press the **[ENT]** key.

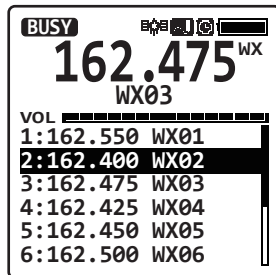

- ❑ To exit the WX mode, press the **[MENU]** key, select the mode other than “WEATHER” on the screen by pressing the **[◀]** or **[▶]** key, and then press the **[ENT]** key.

Weather alert reception

In the event of extreme weather disturbances, such as storms and hurricanes, the NOAA (National Oceanic and Atmospheric Administration) sends a weather alert accompanied by a 1050 Hz tone and subsequent weather report on one of the NOAA weather channels.

When the radio receives the weather alert on the operating frequency, it displays a warning as below on the screen and continues to make alarm sounds until either of the keys is pressed.

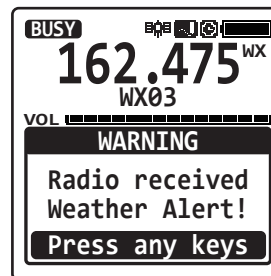

You may enable or disable the alarm function when receiving the weather alert signal via the COMM SETUP menu, if desired. See Page 65 for details.

ADVANCED OPERATION

Dual Watch Operation

The dual watch feature automatically checks for activity on the P-ch (priority channel) set via the COMM SETUP menu while you are operating on another channel. During the dual watch operation, the current channel and the P-ch will be polled alternately for a 200 ms interval.

Setting the P-ch

1. Press the [MENU] key to display the MENU screen.
2. Select "SETUP" on the screen by pressing the [◀] or [▶] key, and then press the [ENT] key.

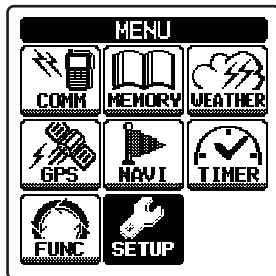

3. Select "COMM SETUP" on the screen by pressing the [◀] or [▶] key, and then press the [ENT] key.

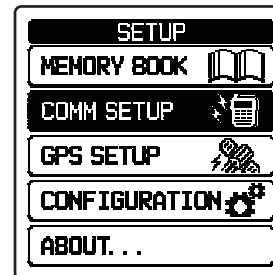

4. Select "DUAL WATCH FREQ." on the screen by pressing the [◀] or [▶] key, and then press the [ENT] key.

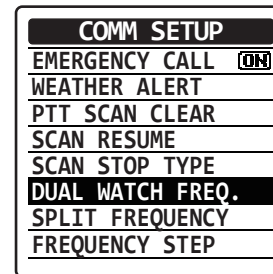

5. Enter the frequency you want to poll, with the keypad.

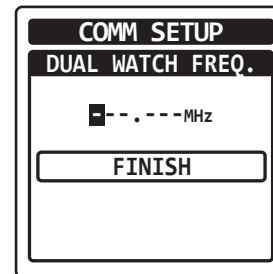

ADVANCED OPERATION

- Select "FINISH" on the screen by pressing the [◀] or [▶] key, and then press the [ENT] key.

The frequency will be determined and the display will return to the COMM SETUP menu.



Starting the dual watch

- Press the [MENU] key to display the MENU screen.
- Select "FUNC" on the screen by pressing the [◀] or [▶] key, and then press the [ENT] key.

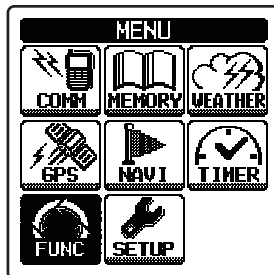

- Select "DUAL WATCH" on the screen by pressing the [◀] or [▶] key, and then press the [ENT] key.

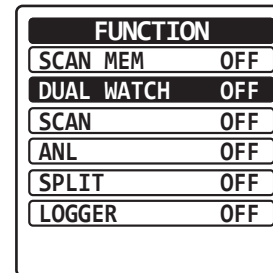

- If "ON" is displayed in the right hand of "DUAL WATCH", the **FTA-750/FTA-550** are performing the dual watch.

The display will return to the previous screen and "DW", which indicates that the **FTA-750/FTA-550** are performing the dual watch, will appear on the display.

- When the radio encounters a signal in the current channel, it still polls both channels alternately with longer staying time on the current channel.
- When the radio encounters a signal in the P-ch, the radio stays on the P-ch until the signal disappears, and the frequency indication on the display blinks. After the signal disappears, the dual watch resumes.

ADVANCED OPERATION

- ❑ To stop the dual watch, select “DUAL WATCH” and press the [ENT] key in the FUNCTION menu.

| FUNCTION | |
|------------|-----|
| SCAN MEM | OFF |
| DUAL WATCH | ON |
| SCAN | OFF |
| ANL | OFF |
| SPLIT | OFF |
| LOGGER | OFF |

Timer Mode Operation

The **FTA-750/FTA-550** are provided a “Stopwatch” timer and a “Countdown” timer. These can be used for a variety of time-keeping purposes.

Even while the timer is in operation, you can move to the other operation modes to receive, transmit, scan, etc.

Using the stopwatch timer

1. Press the [MENU] key to display the MENU screen.
2. Select “TIMER” on the screen by pressing the [◀] or [▶] key, and then press the [ENT] key.

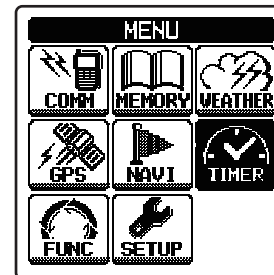

ADVANCED OPERATION

3. Select “STOPWATCH” on the screen by pressing the [◀] or [▶] key, and then press the [ENT] key.

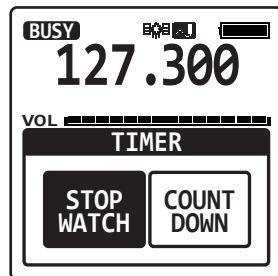

4. To start the counting, select “START” on the screen by pressing the [◀] or [▶] key, and then press the [ENT] key.

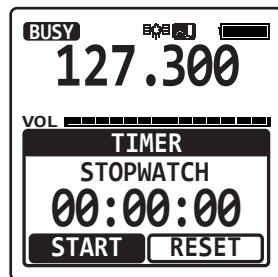

The displayed time will increase and “START” changes to “STOP”.

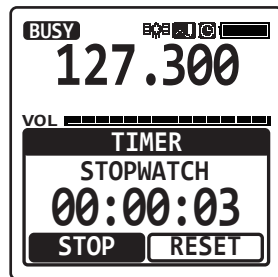

5. To stop the counting, select “STOP” and press the [ENT] key.

To resume the counting, select “START” changed from “STOP” and press the [ENT] key again.

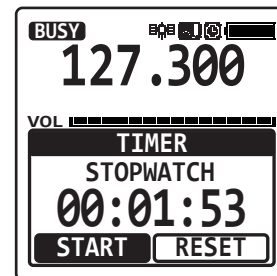

6. To clear the count, select “RESET” on the screen by pressing the [◀] or [▶] key, and then press the [ENT] key.

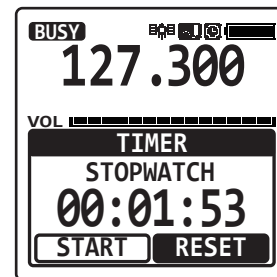

If “RESET” is determined while counting, the timer will continue to count from “00:00:00”.

If “RESET” is determined while stopping, the displayed time will be changed to “00:00:00” and the timer will keep stopping.

ADVANCED OPERATION

Using the countdown timer

1. Press the **[MENU]** key to display the MENU screen.
2. Select “TIMER” on the screen by pressing the **[◀]** or **[▶]** key, and then press the **[ENT]** key.
3. Select “COUNTDOWN” on the screen by pressing the **[◀]** or **[▶]** key, and then press the **[ENT]** key.

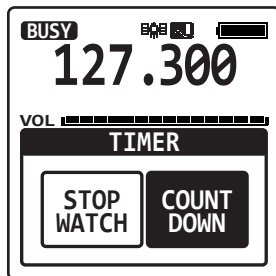

4. Input the time with the keypad or the **DIAL** selector knob, and then press the **[ENT]** key. Press the **[◀]** or **[▶]** key to move the cursor to hour, minute, or second. Press the **[BACK]** key to cancel the input time.

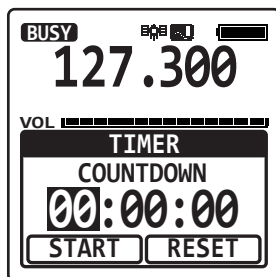

5. To start the counting, select “START” on the screen by pressing the **[◀]** or **[▶]** key, and then press the **[ENT]** key.

The displayed time will decrease and “START” changes to “STOP”.

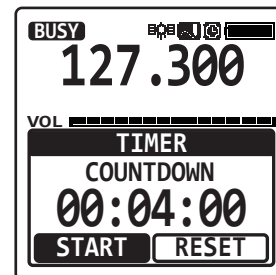

6. To stop the counting, select “STOP” and press the **[ENT]** key. To resume the counting, select “START” changed from “STOP” and press the **[ENT]** key again.

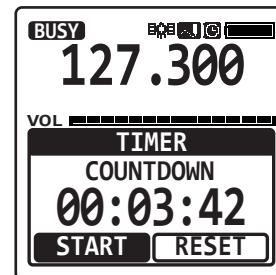
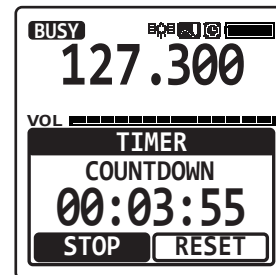

ADVANCED OPERATION

7. To clear the count, select “RESET” on the screen by pressing the [◀] or [▶] key, and then press the [ENT] key.
 The displayed time will be changed to “00:00:00” and the timer will stop.

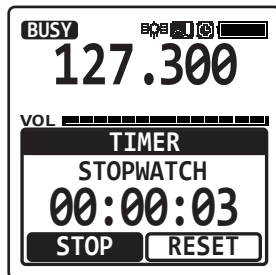

- When the countdown reaches to “00:00:00”, the beeps will continuously sound and “Timer Alarm!” will be displayed on the screen. Press any key to stop the beeps.

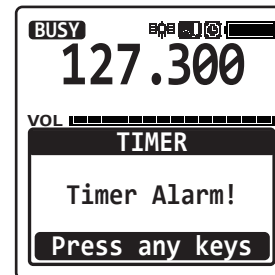

- You can set the timer to alarm without beeps. Select “OFF” on the item “TIMER ALARM” of the CONFIGURATION menu in the SETUP mode.

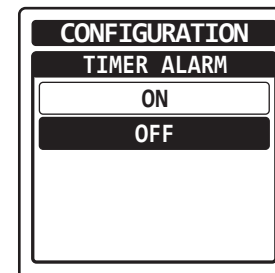
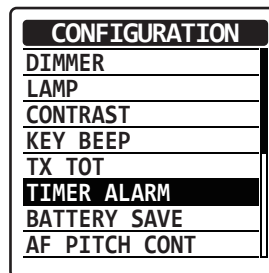

ADVANCED OPERATION

TOT Feature

The TOT (time-out timer) shuts off the transceiver after continuous transmission exceeds the programmed time. This feature prevents unintended transmission by mistake and reduces battery consumption.

To activate the TOT, select either of “1min”, “2min”, “3min”, “5min” on the item “TX TOT” of the CONFIGURATION menu in the SETUP mode.

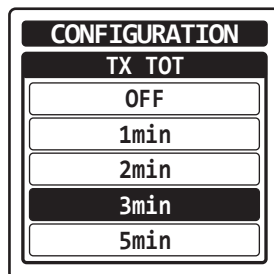
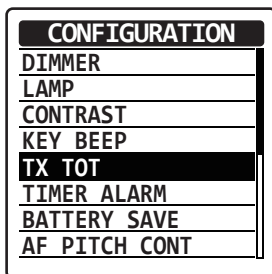

Saving the Battery during Reception

One of the important features of the **FTA-750/FTA-550** are its battery saver, which “puts the radio to sleep” for a time interval, periodically “waking it up” to check for activity. If somebody is talking on the channel, the **FTA-750/FTA-550** will remain in the “awaking” mode, then resume its “sleep” cycles. This feature significantly reduces quiescent battery drain.

To activate the battery saver, select one of the following interval time ratios on the item “BATTERY SAVE” of the CONFIGURATION menu in the SETUP mode.

- 50% ... Sleeps for 100 ms after 100 ms awaking
- 70% ... Sleeps for 250 ms after 100 ms awaking
- 80% ... Sleeps for 450 ms after 100 ms awaking
- 90% ... Sleeps for 900 ms after 100 ms awaking

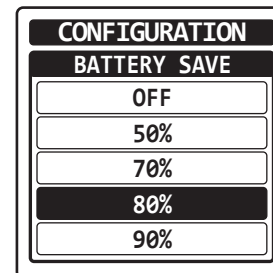
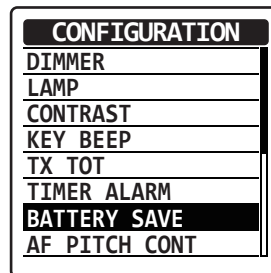

ADVANCED OPERATION

VOX Operation

If you want to have both hands free, use a headset prepared by yourself and activate the VOX (voice-actuated transmit/receive switching) system.

Note:

The VOX system does not function when using just the internal microphone; an external headset must be used.

- ❑ To activate the VOX system, select “ON” on the item “VOX” of the CONFIGURATION menu in the SETUP mode.

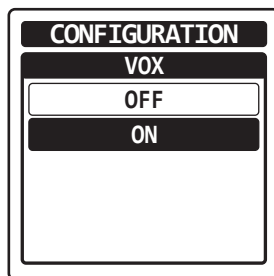
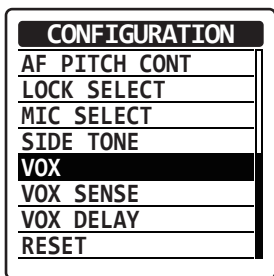

- ❑ To adjust the VOX gain, select one of the following gain levels on the item “VOX SENSE” of the CONFIGURATION menu in the SETUP mode.

MIN / LEVEL 1 /
 LEVEL 2 / LEVEL 3 /
 MAX

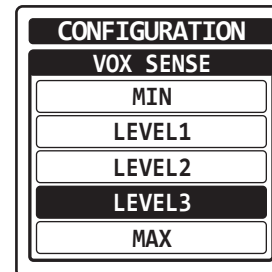

- ❑ To set the VOX delay, select one of the following times on the item “VOX DELAY” of the CONFIGURATION menu in the SETUP mode.

0.5sec / 1.0sec /
 1.5sec / 2.0sec /
 3.0sec

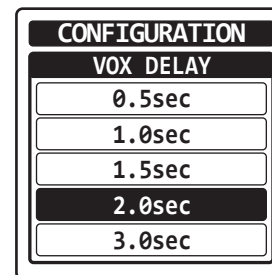

ADVANCED OPERATION

Side Tone Control

When utilizing an external headset, you may monitor your own voice talking to the microphone through the headphone.

- ❑ To activate the monitoring of your voice (side tone), select one of the following side tone level on the item “SIDE TONE” of the CONFIGURATION menu in the SETUP mode.

MIN/LEVEL1/LEVEL2/MAX

| CONFIGURATION |
|---------------|
| AF PITCH CONT |
| LOCK SELECT |
| MIC SELECT |
| SIDE TONE |
| VOX |
| VOX SENSE |
| VOX DELAY |
| RESET |

| CONFIGURATION |
|---------------|
| SIDE TONE |
| OFF |
| MIN |
| LEVEL1 |
| LEVEL2 |
| MAX |

- ❑ To change the side tone level temporarily during the monitoring, press the [◀] or [▶] key or rotate the **DIAL** selector knob when pressing and holding the **PTT** switch.

ANL Feature

For reduction of impulse noise, such as that produced by an engine’s ignition system, the ANL (automatic noise limiter) feature may prove helpful.

To activate the ANL, select “ANL” and press the [ENT] key in the FUNCTION menu.

| FUNCTION | |
|------------|-----|
| SCAN MEM | OFF |
| DUAL WATCH | OFF |
| SCAN | OFF |
| ANL | OFF |
| SPLIT | OFF |
| LOGGER | OFF |

ADVANCED OPERATION

Lock Function

This function prevents accidental changes to the frequency setting and the keypad controls.

Setting the lockout configuration

You may choose the controls to be locked.

1. Press the [MENU] key to display the MENU screen.
2. Select "SETUP" on the screen by pressing the [◀] or [▶] key, and then press the [ENT] key.
3. Select "CONFIGURATION" on the screen by pressing the [◀] or [▶] key, and then press the [ENT] key.
4. Select "LOCK SELECT" on the screen by pressing the [◀] or [▶] key, and then press the [ENT] key.

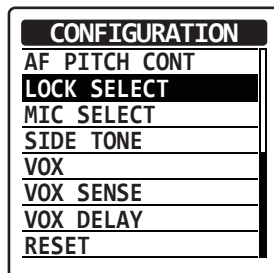

5. Select one of the following lock configuration by pressing the [◀] or [▶] key, and then press the [ENT] key.
 KEY LOCK /
 DIAL LOCK /
 ALL LOCK

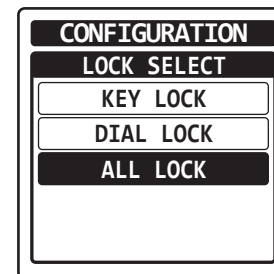

The setting will be determined and the display will return to the CONFIGURATION menu.

ADVANCED OPERATION

Activating the lock feature

- Press and hold the [**On**] key.

According to the setting of the lockout configuration, either of “KEY LOCK”, “DIAL LOCK”, or “ALL LOCK” will appear on the screen for 2 seconds and then the display will return to the previous screen.

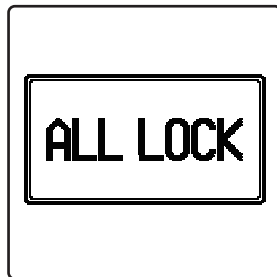
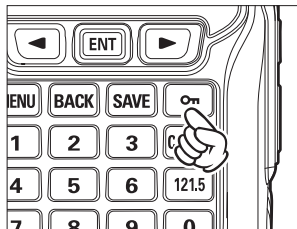

- During the **FTA-750/FTA-550** are locked, the controls with the **DIAL** selector knob and/or the keys except the **PTT** switch, the **POWER** switch, and the [121.5] key are disabled.

If the **DIAL** selector knob is rotated or any of the keys is pressed, either of “DIAL LOCK”, “KEY LOCK”, or “ALL LOCK” will appear on the screen for 2 seconds and then the display will return to the previous screen.

- To turn the lock feature off, press and hold the [**On**] key again. “UNLOCK” will appear on the screen for 2 seconds and then the display will return to the previous screen.

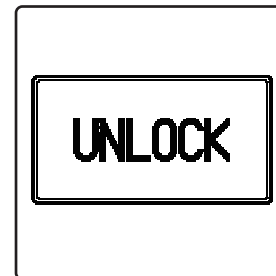

MEMORY OPERATION

The **FTA-750/FTA-550** provide 200 user-programmable memories which can hold sets of information about channels such as its channel frequency, position information, channel tag (name) up to 15 characters, group label, etc.

The stored channels can be assigned to the priority group which can be named with up to 10 characters.

The **FTA-750/FTA-550**'s memory system allows you to store, label, and recall channel frequencies you may use frequently.

Recalling the Memories

- To enter the MR (memory recall) mode from the COMM mode, press the [MENU] key to display the MENU screen, select "MEMORY" on the screen by pressing the [◀] or [▶] key, and then press the [ENT] key.

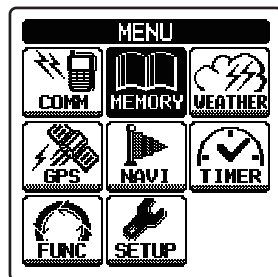

The frequency and tag name of the last channel and "MR", which indicates that the **FTA-750/FTA-550** are in the MR mode, will appear on the upper area of the display.



If the last channel is assigned to the priority group, "GRP", which indicates that the channel belongs to the priority group of the memory, will appear below "MR".

The list of memory channels you have used will also appear below the VOL meter on the display. You may select and move to a channel in the list by pressing the [◀] or [▶] key followed by the [ENT] key.

MEMORY OPERATION

- ❑ To recall a channel other than the last one, press the [ENT] key while the cursor is on the tag name. The MEMORY BOOK screen listing the following two groups appears on the display.

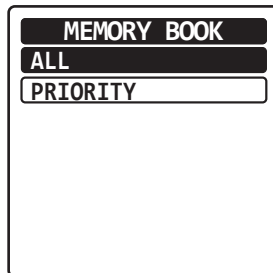

ALL ... Group including all the memory channels
 PRIORITY ... Group of memory channels you have specified when storing

Select a group first that the desired channel is assigned by pressing the [◀] or [▶] key followed by the [ENT] key, then select a channel from the channel list of the group in the same way.

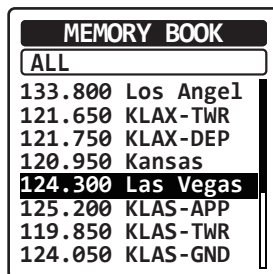

- ❑ If you have not yet stored any memory channel, a dialog box titled “No Address” will appear, which asks whether you make an entry. Select “YES” and press the [ENT] key to store channel information.

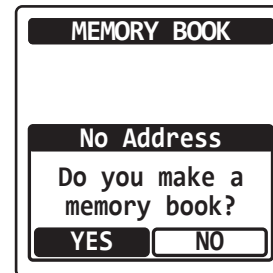

See Page 47 for detailed procedure of storing channel information.

- ❑ To exit the MR mode, press the [COMM] key.

MEMORY OPERATION

Instant Storage

- Select a desired frequency in the COMM mode, then press the [SAVE] key. The MEMORY BOOK form appears on the display, with the channel name (tag), frequency, group tag, and position information (if exists) already filled.

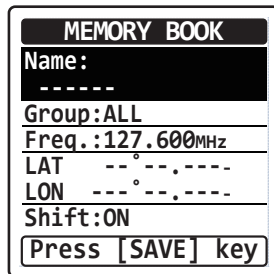

- If you need no change to the items on the form, press the [SAVE] key. The channel information will be stored into the memory and the display returns to the COMM mode.

- If you want to change or input either of the items in the form, press the [◀] or [▶] key to select the item, then press the [ENT] key.

Input letters and/or numerics with the keypad or the DIAL selector knob, or select a setting with the [◀] or [▶] key, then press the [ENT] key. Press the [SAVE] key after all the inputs or changes have been done to store them into the memory.

- Press the [BACK] key to cancel the changes or inputs.



Note: You cannot store weather channels to the memory by pressing the [SAVE] key during the WX mode. If you dial up or key in the weather station's frequency manually in the COMM mode, you may store the frequency and other information with a custom tag name.

MEMORY OPERATION

Maintenance of the Memory

Adding new addresses, editing the stored information, and deleting the stored addresses are allowed through the SETUP mode.

Adding entries

1. Press the [MENU] key to display the MENU screen.
2. Select "SETUP" on the screen by pressing the [◀] or [▶] key, and then press the [ENT] key.
3. Select "MEMORY BOOK" on the screen by pressing the [◀] or [▶] key, and then press the [ENT] key.

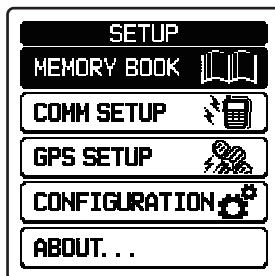

4. Select the item you wish to view and/or modify by pressing the [◀] or [▶] key, and then press the [ENT] key.

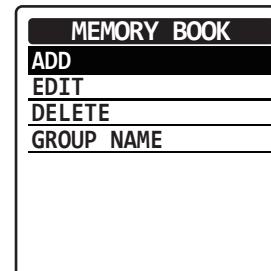

5. Select the item, input letters and/or numerics, select a setting, and store the changes in the same way as the instant storage described previously.

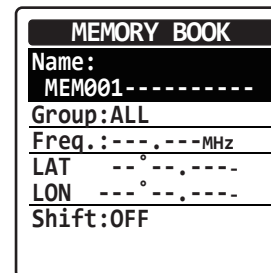

MEMORY OPERATION

Editing the information

1. Press the [MENU] key to display the MENU screen.
2. Select "SETUP" on the screen by pressing the [◀] or [▶] key, and then press the [ENT] key.
3. Select "MEMORY BOOK" on the screen by pressing the [◀] or [▶] key, and then press the [ENT] key.
4. Select "EDIT" by pressing the [◀] or [▶] key, and then press the [ENT] key.

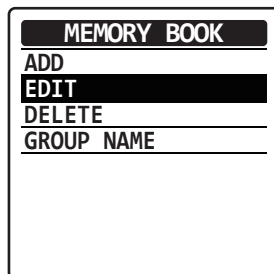

5. Press the [◀] or [▶] key to select the group including the entry you want to edit, then press the [ENT] key.

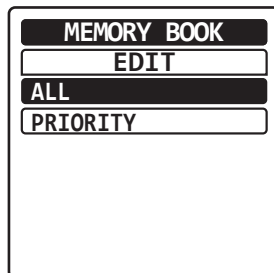

6. Press the [◀] or [▶] key to select the entry you want to edit, then press the [ENT] key.

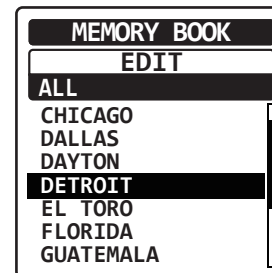

7. Select the item, input letters and/or numerics, select a setting, and then store the changes in the same way as the instant storage described previously.

MEMORY OPERATION

Deleting the memory

1. Press the [MENU] key to display the MENU screen.
2. Select "SETUP" on the screen by pressing the [◀] or [▶] key, and then press the [ENT] key.
3. Select "MEMORY BOOK" on the screen by pressing the [◀] or [▶] key, and then press the [ENT] key.

4. Select "DELETE" by pressing the [◀] or [▶] key, and then press the [ENT] key.

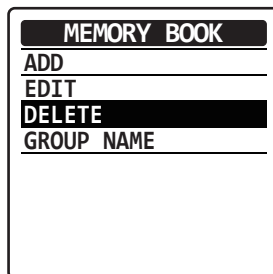

5. Press the [◀] or [▶] key to select the group including the entry you want to delete, then press the [ENT] key.

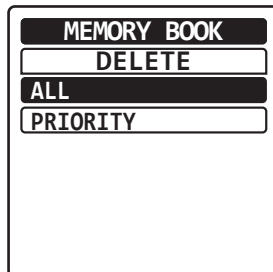

6. Press the [◀] or [▶] key to select the entry you want to delete, and then press the [ENT] key.

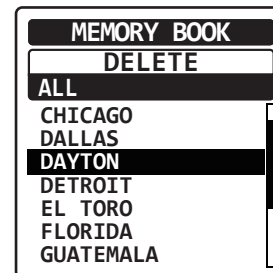

7. Select "OK?" on the screen by pressing the [◀] or [▶] key, and then press the [ENT] key.

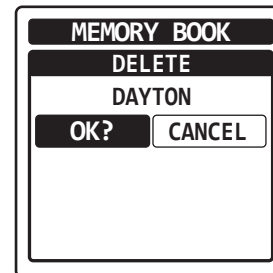

The display will return to the previous screen after the deletion of the entry from the memory.

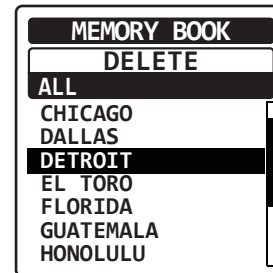

MEMORY OPERATION

Editing the group name

You may assign a unique name to the priority group.

1. Press the [◀] or [▶] key to select “GROUP NAME” on the MEMORY BOOK menu, and then press the [ENT] key.
2. Enter the desired group name with the **DIAL** selector knob and/or the keypad followed by the [ENT] key.

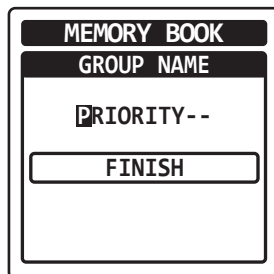

3. Select “FINISH” on the screen by pressing the [◀] or [▶] key, and then press the [ENT] key.
The group name will be determined and the display will return to the MEMORY BOOK menu.

SCANNING OPERATION

The **FTA-750/FTA-550** allow you to scan active channels automatically in the COMM (COM band), MR, and WX (USA version only) modes. It pauses on signals encountered, so you can talk to the station(s) on that frequency if you like.

Scanning All Channels

1. Set the radio to the COMM mode.
2. Press the [MENU] key to display the MENU screen.
3. Select "FUNC" on the screen by pressing the [◀] or [▶] key, and then press the [ENT] key.
4. Select "SCAN" on the screen by pressing the [◀] or [▶] key, and then press the [ENT] key.

| FUNCTION | |
|------------|-----|
| SCAN MEM | OFF |
| DUAL WATCH | OFF |
| SCAN | OFF |
| ANL | OFF |
| SPLIT | OFF |
| LOGGER | OFF |

The scanning starts and the display returns to the COMM mode screen.

- The scanner searches a signal from the lower frequency to higher.
- When the scanner encounters a signal, the scanning pauses and the radio remains on that channel until the signal disappears, and the frequency indication on the display blinks.
- After the signal disappears, the scanning resumes.
- To stop the scanning, press the **PTT** switch, or select "SCAN" again in the FUNCTION menu.

| FUNCTION | |
|------------|-----|
| SCAN MEM | OFF |
| DUAL WATCH | OFF |
| SCAN | ON |
| ANL | OFF |
| SPLIT | OFF |
| LOGGER | OFF |

Next time the scanning is activated, the search will start from the frequency at which the scanning was stopped last time.

SCANNING OPERATION

Scanning the Specified Channels

Among the memory and weather channels, you may scan only those on which you want to see if a signal exists.

Marking the channels

1. Set the radio to the MR or WX mode and tune to the channel that you want to be scanned.
2. Press the **[MENU]** key to display the MENU screen.
3. Select “FUNC” on the screen by pressing the **[◀]** or **[▶]** key, and then press the **[ENT]** key.
4. Select “SCAN MEM” on the screen by pressing the **[◀]** or **[▶]** key, and then press the **[ENT]** key.

| FUNCTION | |
|------------|-----|
| SCAN MEM | OFF |
| DUAL WATCH | OFF |
| SCAN | OFF |
| ANL | OFF |
| SPLIT | OFF |
| LOGGER | OFF |

The current channel is marked to be scanned and the “MEM” icon, which indicates that the channel is the target of scanning, will appear at the right side of the channel frequency when the display returns to the MR or WX mode screen.

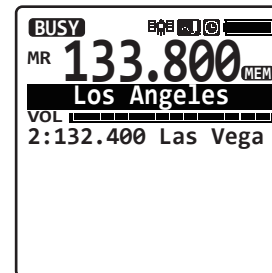

5. Repeat the steps 1 to 4 above to mark other channels as well.

SCANNING OPERATION

Scanning the marked channels

- ❑ Set the radio to the MR or WX mode, then perform the steps 2 to 4 of the section “Scanning All Channels” in the previous page.
The scanning starts and the display returns to the MR or WX mode screen.
- ❑ The **FTA-750/FTA-550** operate in the same way as that when scanning all channels described in the previous page, except that it searches a signal on the marked frequencies only.

GPS FUNCTION (FTA-750 ONLY)

The **FTA-750** has an internal GPS reception unit to receive and display the position information at all times. The position information of your own as well as received stations can be memorized and utilized later for navigation.

Activating the GPS Unit

In factory default, the GPS unit is set to OFF to save the power consumption. Switch the unit to ON to use the GPS function with the procedure below.

1. Press the [MENU] key to display the MENU screen.
2. Select "SETUP" on the screen by pressing the [◀] or [▶] key, and then press the [ENT] key.
3. Select "GPS SETUP" on the screen by pressing the [◀] or [▶] key, and then press the [ENT] key.

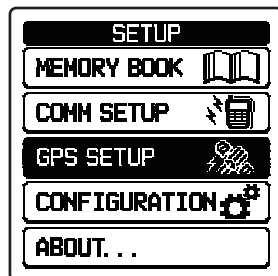

4. Select "GPS ON/OFF" on the screen by pressing the [◀] or [▶] key, and then press the [ENT] key.

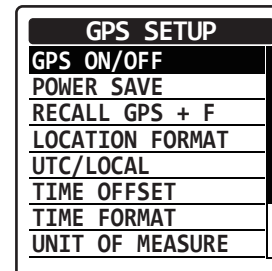

5. Select "ON" on the screen by pressing the [◀] or [▶] key, and then press the [ENT] key.

The GPS unit is set to ON and the display will return to the GPS SETUP menu.

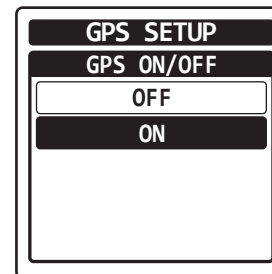

GPS FUNCTION (FTA-750 ONLY)

Displaying the Position Information

You can choose the way to display the position information from three types; numerical, compass, and numerical with GPS status.

Notes:

- You may change the unit of displayed measurements via the SETUP mode.
- You may set the time area and offset via the SETUP mode.
- The position information will be displayed with the screen type you have selected last time before switching the operation mode or turning off the radio.

Numerical display

1. Press the [MENU] key to display the MENU screen.
2. Select “GPS” on the screen by pressing the [◀] or [▶] key, and then press the [ENT] key.

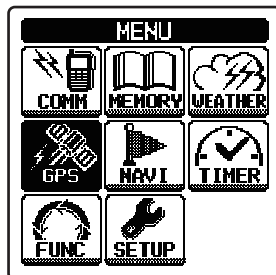

3. Select “GPS INFO” on the screen by pressing the [◀] or [▶] key, and then press the [ENT] key.

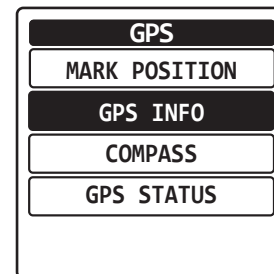

The latitude and longitude of your current position, COG (course over ground), SOG (speed over ground), altitude, and the date will be displayed below the VOL meter on the screen.

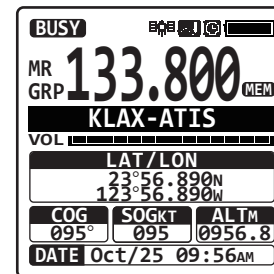

GPS FUNCTION (FTA-750 ONLY)

Compass display

1. Press the **[MENU]** key to display the MENU screen.
2. Select “GPS” on the screen by pressing the **[◀]** or **[▶]** key, and then press the **[ENT]** key.
3. Select “COMPASS” on the screen by pressing the **[◀]** or **[▶]** key, and then press the **[ENT]** key.

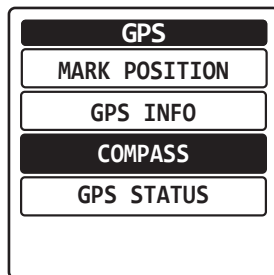

The compass with your traveling direction always at the top, COG (course over ground), SOG (speed over ground), altitude, and the date will be displayed below the VOL meter on the screen.



Numerical display with GPS status

1. Press the **[MENU]** key to display the MENU screen.
2. Select “GPS” on the screen by pressing the **[◀]** or **[▶]** key, and then press the **[ENT]** key.
3. Select “GPS STATUS” on the screen by pressing the **[◀]** or **[▶]** key, and then press the **[ENT]** key.

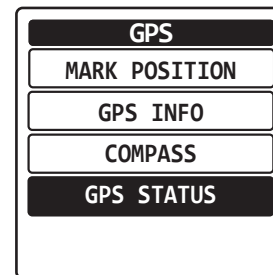

The latitude and longitude of your current position, a radar scope showing the position of captured GPS satellites, bars indicating the signal strength of captured GPS satellites, and the date will be displayed below the VOL meter on the screen.

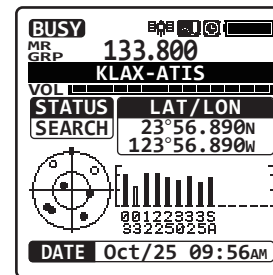

GPS FUNCTION (FTA-750 ONLY)

Memorizing the Position Information

You can save your position information at a certain point of time in the memory book of the radio.

1. Press the [MENU] key to display the MENU screen.
2. Select "GPS" on the screen by pressing the [◀] or [▶] key, and then press the [ENT] key.
3. Select "MARK POSITION" on the screen by pressing the [◀] or [▶] key, and then press the [ENT] key.

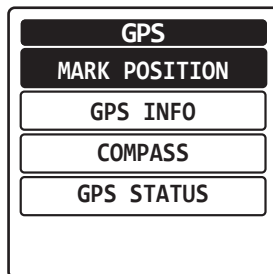

The MARK POSITION form appears on the display, with the name (tag), frequency, group tag, and current position information already filled.



- If you need no change to the items on the form, press the [SAVE] key. The position information will be stored into the memory and the display returns to the screen displayed before entering the menu mode.
- If you want to change or input either of the items in the form, press the [◀] or [▶] key to select the item, then press the [ENT] key. Input letters and/or numerics with the keypad or the DIAL selector knob, then press the [ENT] key. Press the [SAVE] key after all the inputs or changes have been done to store them into the memory.
- Press the [BACK] key to cancel the changes or inputs.

GPS FUNCTION (FTA-750 ONLY)

Recording the Position Information

You can save your current position information in the memory of the radio at a regular interval.

1. Press the [MENU] key to display the MENU screen.
2. Select "FUNC" on the screen by pressing the [◀] or [▶] key, and then press the [ENT] key.
3. Select "LOGGER" on the screen by pressing the [◀] or [▶] key, and then press the [ENT] key.

| FUNCTION | |
|------------|-----|
| SCAN MEM | OFF |
| DUAL WATCH | OFF |
| SCAN | OFF |
| ANL | OFF |
| SPLIT | OFF |
| LOGGER | OFF |

The recording starts and the display returns to the previous screen.

- You may change the interval time of recording via the SETUP mode.

WAYPOINT NAVIGATION (FTA-750 ONLY)

The navigation feature of the **FTA-750** is presented in a compass that helps you to figure out the destination and your traveling direction at a glance.

The destination can be selected from the database of airports and VOR stations, memory channels, and the list of points you have selected previously, or directly specified.

Notes:

- Be sure that the internal GPS unit has been activated before using the navigation.
- The navigation does not work when insufficient number of GPS satellites are captured to obtain your position.

Entering the Navigation (NAVI) Mode

- ❑ Select “NAVI” on the MENU screen by pressing the [◀] or [▶] key, and then press the [ENT] key.

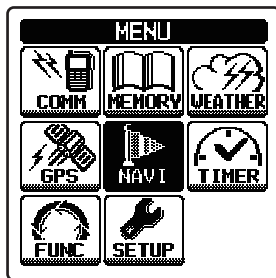

The compass screen including the destination you have selected last time will be displayed if you did not reach there before switching the operation mode or turning off the radio.

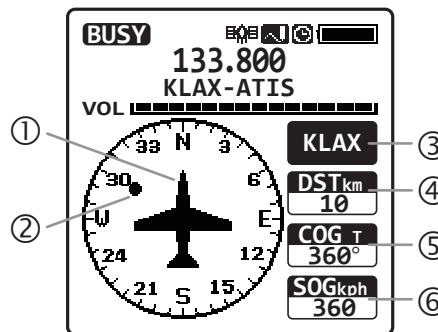

- ① Course indicator
- ② Destination indicator
- ③ Tag name of the destination
- ④ DST (distance)
- ⑤ COG (course over ground)
- ⑥ SOG (speed over ground)

WAYPOINT NAVIGATION (FTA-750 ONLY)

Setting the Destination

When you enter the NAVI mode for the first time, or if you have reached the destination during the NAVI mode last time, the NAVI menu will be displayed after selecting “NAVI” on the MENU screen.

Selecting from the memory

1. Select “MEMORY” on the NAVI menu by pressing the [◀] or [▶] key, and then press the [ENT] key.

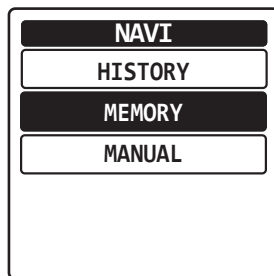

2. Select a group that the desired station is assigned by pressing the [◀] or [▶] key, and then press the [ENT] key.

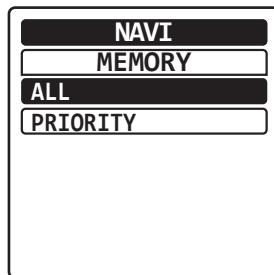

3. Select a station from the station list of the group by pressing the [◀] or [▶] key, and then press the [ENT] key.

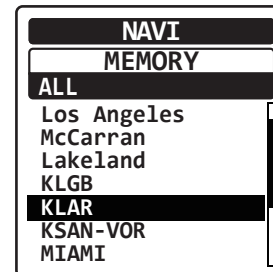

The information of the selected station will appear with the reversed “GOTO” displayed at the bottom.

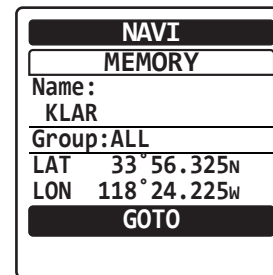

4. Press the [ENT] key. The compass screen will be displayed.

Selecting from the history

- ❑ Select “History” on the NAVI menu, and then select and set the desired station in the same way as the steps 3 and 4 above.

WAYPOINT NAVIGATION (FTA-750 ONLY)

Specifying the position directly

1. Select “MANUAL” on the NAVI menu by pressing the [◀] or [▶] key, and then press the [ENT] key.

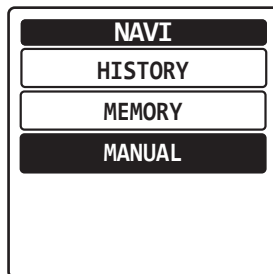

2. Select the “LAT” and “LON” field by pressing the [◀] or [▶] key, and then press the [ENT] key.

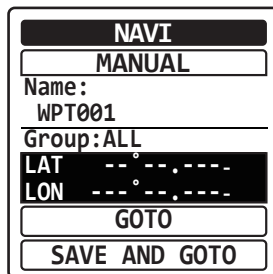

3. Input numerics and letters with the keypad or the DIAL selector knob, then press the [ENT] key.

The cursor will move to the next digit of the position information.

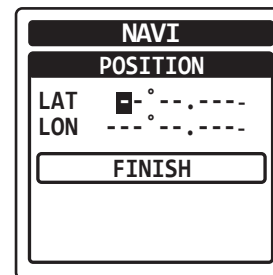

4. Repeat the step 3 to input all digits of the position information.

If you want to correct a mistake, press the [◀] or [▶] key to move the cursor to the digit you want to change, then perform the step 3 again.

5. Select “FINISH” by pressing the [◀] or [▶] key, and then press the [ENT] key.

The input information will appear with the reversed “GOTO” displayed at the bottom.

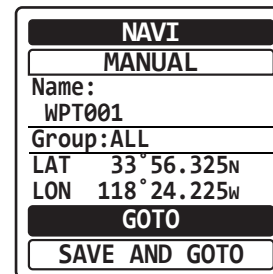

6. Press the [ENT] key.
The compass screen will be displayed.

WAYPOINT NAVIGATION (FTA-750 ONLY)

- ❑ You may store the input information to the memory of the radio by selecting “SAVE AND GOTO” before the step 6 above.
- ❑ You may give a custom tag name to the input information and assign it to a desired group before the step 6, in the same way as the steps 2 to 5.

Starting the Navigation to the Receiving Station

You can set the currently receiving station in the COMM mode as the destination, and start navigation instantly.

1. Tune to the frequency of the station you want to be navigated to in the COMM mode.
2. Press the [ENT] key to display the instant menu.
3. Select “INFO” by pressing the [◀] or [▶] key, and then press the [ENT] key.



The information including the latitude and longitude of the station will appear with the reversed “GOTO” displayed at the bottom.

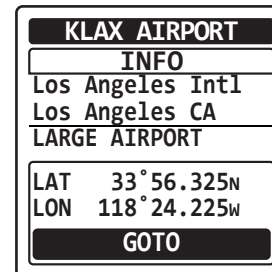

4. Press the [ENT] key.
 The compass screen will be displayed.

SETUP MODE

Note:

We do not recommend that any of the default settings be changed until you are thoroughly familiar with the operation of the **FTA-750/FTA-550**.

Basic Operation

1. Press the **[MENU]** key to display the MENU screen.
2. Select “SETUP” on the MENU screen by pressing the [**◀**] or [**▶**] key, and then press the **[ENT]** key.

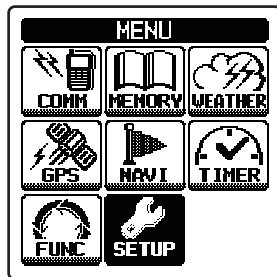
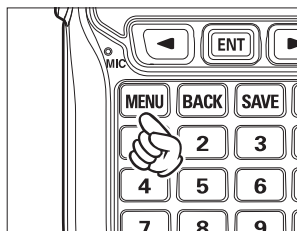

3. Select the item on the SETUP menu by pressing the [**◀**] or [**▶**] key, and then press the **[ENT]** key.
4. Select the item you wish to view and/or change the settings by pressing the [**◀**] or [**▶**] key, and then press the **[ENT]** key.
5. Enter or select settings on the screen dedicated to each item, and then press the **[ENT]** key to determine the new settings.

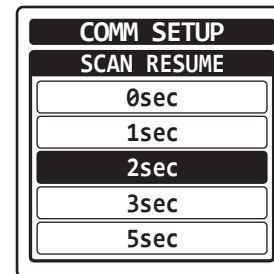
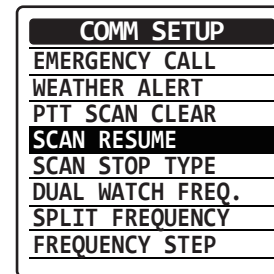
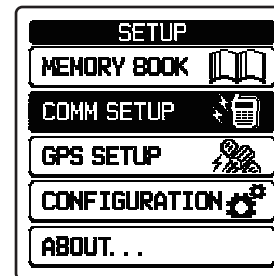

SETUP MODE

Menu items

○ **MEMORY BOOK**

You may store the frequencies or positions with a tag name to the memory of the radio, and maintain the stored entries.

○ **COMM SETUP**

You may set and adjust the operations of the radio in the COMM mode.

○ **GPS SETUP (FTA-750 only)**

You may set and adjust the operations of the radio in the GPS mode.

○ **CONFIGURATION**

You may set and adjust the various conditions of the radio.

○ **ABOUT...**

You may confirm the version of the software currently operating on the radio.

Maintenance of the Memory

See Pages 47 to 50 for details.

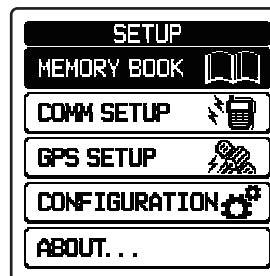

SETUP MODE

Setting of the COMM Mode Operation

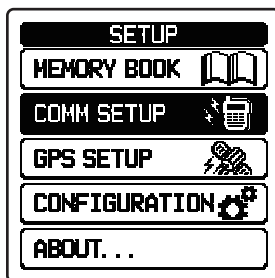

Turning on/off the emergency call

You may enable or disable the quick access to the 121.500 MHz emergency frequency (see also Page 19).

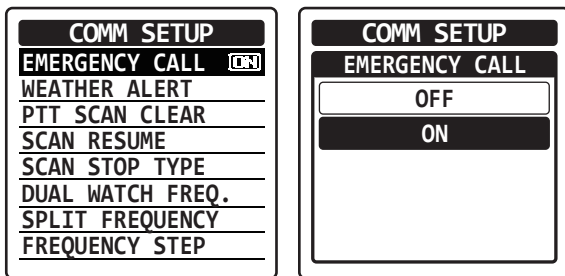

Turning on/off the weather alert

You may enable or disable the alarm function when receiving the weather alert signal (see also Page 32).

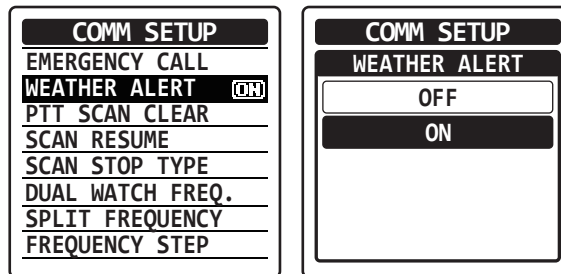

Turning on/off the scan stop with the PTT

You may lock out the **PTT** switch during the scan operation (see also Page 51).

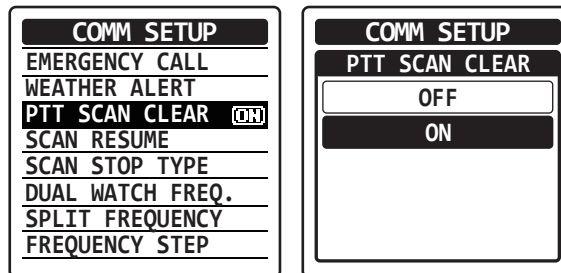

SETUP MODE

Setting the scan resume time

You may select a waiting time till the resuming of scan after the encountered signal disappears (see also Page 51).

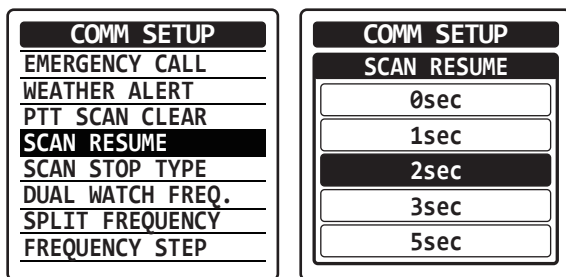

Setting the operation after stopping a scan

You may select either of the operation below when encountering a signal during a scan (see also Page 51).

- BUSY STOP ... Stays at the frequency and will not resume the scan
- 5sec STOP ... Stays at the frequency for 5 seconds and then resume the scan
- 10sec STOP ... Stays at the frequency for 10 seconds and then resume the scan

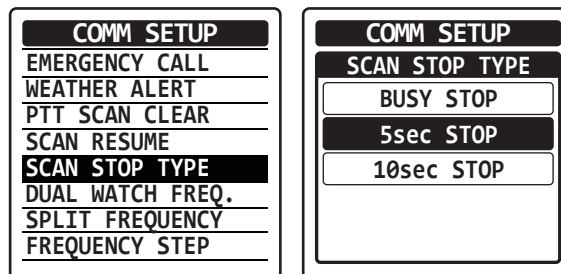

Setting the polled frequency for dual watch
 See Page 33 for details.

Setting the transmit frequency during the NAV band reception
 See Page 29 for details.

SETUP MODE

Setting the frequency step for tuning

You may select the frequency rate for one click of the **DIAL** selector knob (see also Page 17).

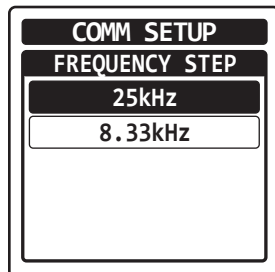
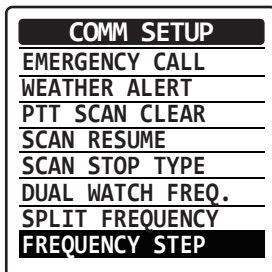

Setting of the GPS Mode Operation (FTA-750 Only)

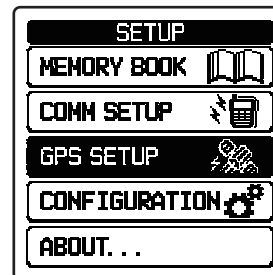

Turning on/off the internal GPS unit

See Page 54 for details.

SETUP MODE

Setting the power save operation of the internal GPS unit

You may select an interval time of periodical operation of the GPS unit to reduce battery consumption (see also Page 39).

- OFF ... Operates all the time
- AUTO ... *****
- 50% ... Sleeps for 3 sec after 3 sec operation
- 75% ... Sleeps for 9 sec after 3 sec operation
- 90% ... Sleeps for 27 sec after 3 sec operation

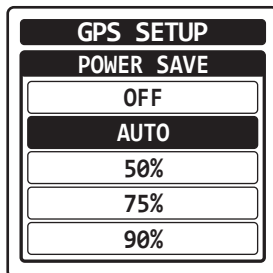
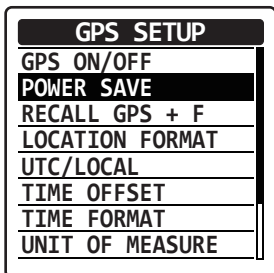

Turning on/off the *****

You may enable or disable the *****.

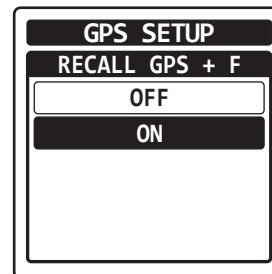
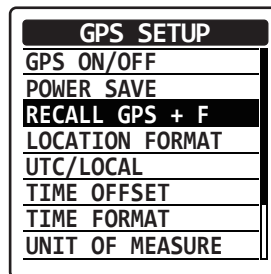

Setting the notation format of location

You may select the coordinate system for position information to be shown on the display (see also Page 55).

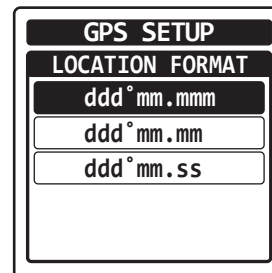
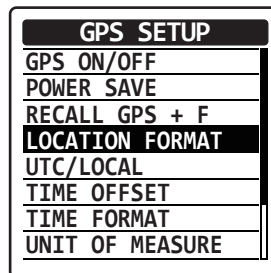

SETUP MODE

Setting the time area

You may select either of the UTC (universal time coordinated) time or local time to be shown on the display (see also Page 55).

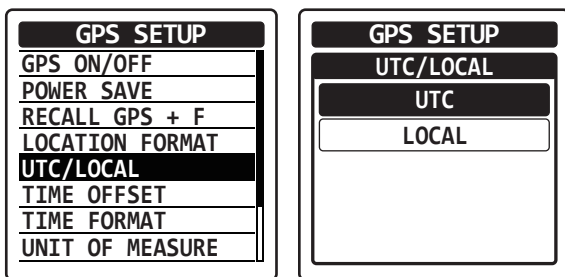

Setting the notation format of time

You may select either of the 24-hour or 12-hour notation of time to be shown on the display (see also Page 55).

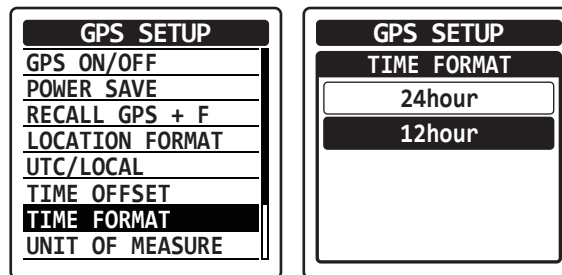

Setting the time offset

You must set the time offset of your current area when using the local time (see also Page 55).

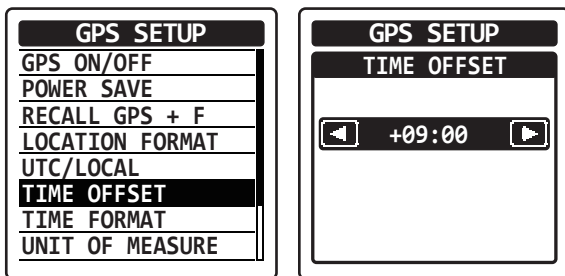

Setting the unit of measurement

You may select the unit of speed, distance, and altitude to be shown on the display (see also Page 55).

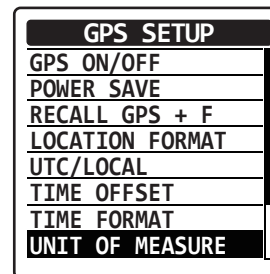

SETUP MODE

| GPS SETUP | |
|-----------------|-----|
| UNIT OF MEASURE | |
| SPEED | kts |
| DISTANCE | sm |
| ALTITUDE | ft |

| GPS SETUP | |
|-----------|--|
| SPEED | |
| knots | |
| mile/h | |
| km/h | |

| GPS SETUP | |
|-----------------|-----|
| UNIT OF MEASURE | |
| SPEED | kts |
| DISTANCE | sm |
| ALTITUDE | ft |

| GPS SETUP | |
|---------------|--|
| DISTANCE | |
| statute mile | |
| nautical mile | |
| km | |

| GPS SETUP | |
|-----------------|-----|
| UNIT OF MEASURE | |
| SPEED | kts |
| DISTANCE | sm |
| ALTITUDE | ft |

| GPS SETUP | |
|-----------|--|
| ALTITUDE | |
| feet | |
| meter | |

Turning on/off the pinning

You may enable or disable the *****.

| GPS SETUP | |
|-----------------|-------------------------------------|
| POWER SAVE | |
| RECALL GPS + F | |
| LOCATION FORMAT | |
| UTC/LOCAL | |
| TIME OFFSET | |
| TIME FORMAT | |
| UNIT OF MEASURE | |
| PINNING | <input checked="" type="checkbox"/> |

| GPS SETUP | |
|-----------|--|
| PINNING | |
| OFF | |
| ON | |

Turning on/off the *****

You may enable or disable the *****.

| GPS SETUP | |
|-----------------|-------------------------------------|
| RECALL GPS + F | |
| LOCATION FORMAT | |
| UTC/LOCAL | |
| TIME OFFSET | |
| TIME FORMAT | |
| UNIT OF MEASURE | |
| PINNING | |
| D-GPS | <input checked="" type="checkbox"/> |

| GPS SETUP | |
|-----------|--|
| D-GPS | |
| OFF | |
| ON | |

SETUP MODE

Setting the interval time of logging

You may select a time rate for recording of the position information obtained from the GPS (see also Page 58).

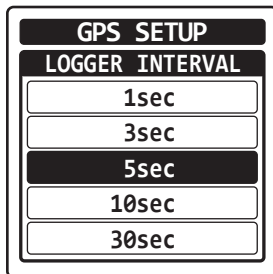
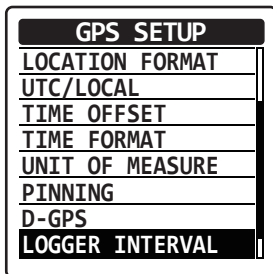

Erasing the log

You may delete the records of the position information obtained from the GPS (see also Page 58).

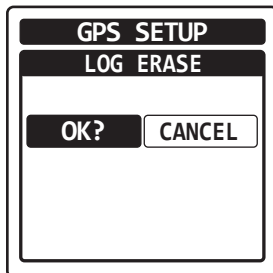
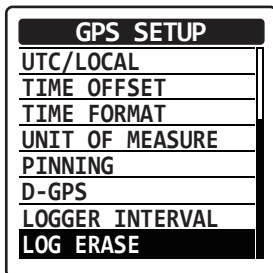

Setting of the Operation and Configuration of the Radio

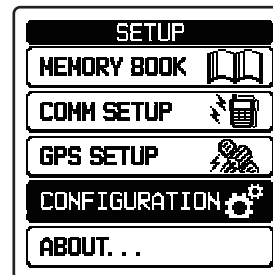

Setting the brightness of the display

You may adjust the dimmer in 5 levels.

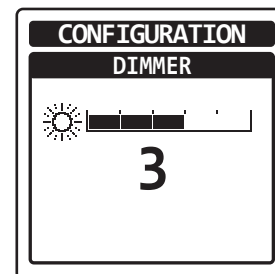
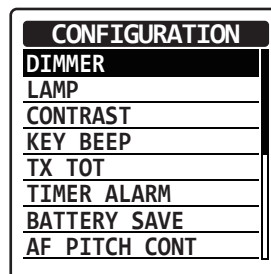

SETUP MODE

Setting the lamp of the display

You may select the operation of the display lighting from the following 4 types.

- OFF ... No lighting at any time
- CONTINUE ... Lights at all time
- KEY ON ... Lights only when any key is pressed
- EXT PO/KEY ... Lights when *****

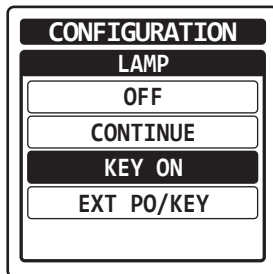
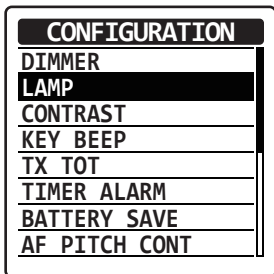

Setting the contrast of the display

You may adjust the contrast in 30 levels.

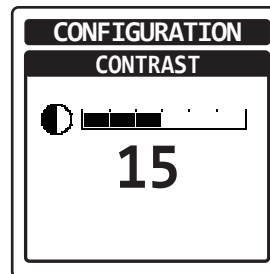
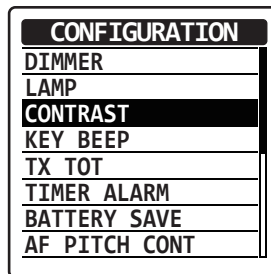

Setting the loudness of key beeps

You may adjust the loudness in 5 levels.

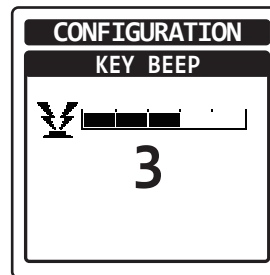
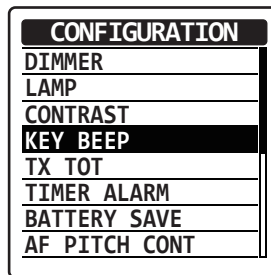

SETUP MODE

Setting the time-out timer for transmission

See Page 39 for details.

Turning on/off the timer alarm

See Page 38 for details.

Setting the power save operation

See Page 39 for details.

Setting the audio filter of the receiver

You may select the operation of the audio filter from the following 4 types.

NORMAL ... No filtering

LOW CUT ... Cuts off the lower range of sound

HIGH CUT ... Cuts off the higher range of sound

HIGH AND LOW CUT ... Cuts off the higher and lower ranges of sound

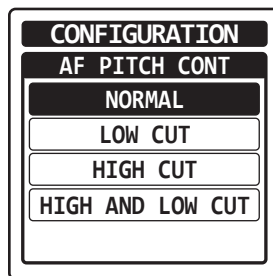
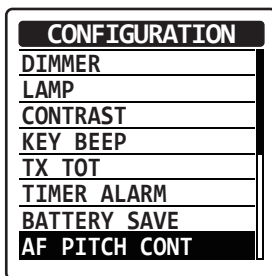

Setting the lockout configuration

See Page 42 for details.

Setting the microphone configuration

You may select an external microphone if connected.

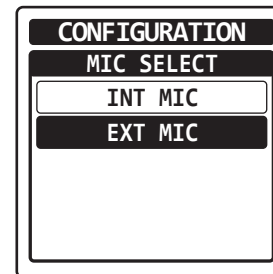
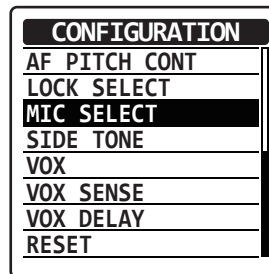

Setting the side tone operation

See Page 41 for details.

Turning on/off the VOX operation

See Page 40 for details.

Setting the sensitivity of the VOX system

See Page 40 for details.

Setting the sensing time of the VOX system

See Page 40 for details.

SETUP MODE

Resetting the radio

You may initialize the memories and settings of the menu categories independently or at once (see also Pages 23 and 24).

MEMORY ... Clears the entries in the memory

FUNCTION ... Initializes the on/off settings in the
 FUNCTION menu

CONFIGURATION ... Initializes the settings in the
 CONFIGURATION menu

FACTORY ... Resets the radio to factory default

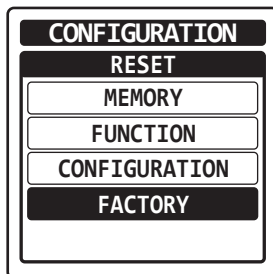
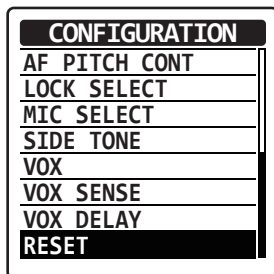

About the Radio

You may confirm the version of the software currently operating on the radio.

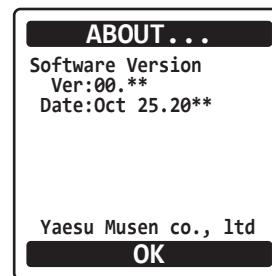
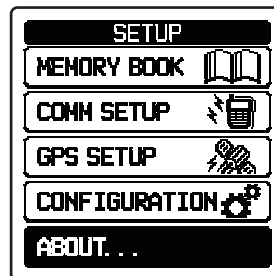

SPECIFICATIONS

General

| | |
|---------------------------------------|--|
| Frequency Range: | TX: 118.000 to 136.975 MHz RX: 108.000 to 136.975 MHz, Weather Channels (WX-01 to WX-10: USA version only) |
| Channel Spacing: | 25 kHz/8.33 kHz |
| Emission Type: | TX: AM RX: AM & FM (FM: for receiving the Weather Channels, USA version only) |
| Supply Voltage: | 6.0 to 9.5 VDC |
| Current Consumption (approx.): | 20 μ A (power off), 20 mA (battery saver on, saver ratio 1:5) 60 mA (squelch on), 270 mA (receive), 0.9 A (transmit 1.5 W Carrier) |
| Temperature Range: | +14 °F to + 140 °F (−10 °C to +60 °C) |
| Case Size (W x H x D): | 2.4 x 5.2 x 1.3 inches (62 x 133 x 34 mm) with SBR-12LI |
| Weight (approx.): | 14.5 oz (410 grams) with SBR-12LI and antenna |

Receiver

| | |
|----------------------------------|--|
| Circuit Type: | Double-conversion superheterodyne |
| IFs: | 35.4 MHz & 450 kHz |
| Sensitivity: | Better than 0.8 μ V (for 6 dB S/N with 1 kHz, 30 % modulation) |
| Selectivity: | >8 kHz/−6 dB |
| Adjacent CH. Selectivity: | <25 kHz/−60 dB |
| AF Output (@7.4 V): | 0.8 W @ 16 Ohms, 10 % THD |

SPECIFICATIONS

Transmitter

| | |
|--------------------------------|---|
| Power Output (@ 7.4 V): | 5.0 W (PEP), 1.5 W (Carrier Power) |
| Frequency Stability: | Better than ± 2 ppm (+14 °F to + 140 °F [-10 °C to +60 °C]) |
| Modulation System: | Low Level Amplitude Modulation |
| Spurious Emission: | >60 dB below carrier |
| Int. Microphone Type: | Condenser |
| Ext. Mic. Impedance: | 150 Ohms |

GPS Unit (FTA-750 only)

| | |
|--------------------------|---|
| Receiver Channels | 12 Channels |
| Sensitivity | Less than -130 dBm |
| Time to First Fix | 1 minute typical (@Cold Start) 40 seconds typical (@ Warm Start) |
| Geodetic Datum | WGS84 |

Specifications are subject to change without notice or obligation.

Quick Reference

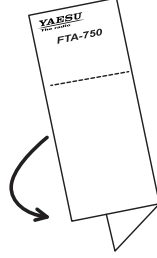

(Cut Here)

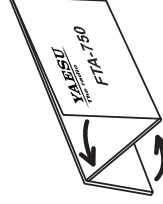

YAESU
The radio

FTA-750

Quick Reference Card

YAESU MUSEN CO., LTD.

Recalling the Memory Channels

1. Press the [MENU] key to display the MENU screen.
2. Press the [◀] or [▶] key to select "MEMORY", then press the [ENT] key.
3. Press the [◀] or [▶] key to select the desired channel from the list.
4. Press the [ENT] key.

Recalling the Previous Frequencies

1. In the COM band screen, press the [◀] or [▶] key to select the desired channel from the list.
2. Press the [ENT] key.

Selecting the Alternate Channels

1. In the COM band screen, press the [ENT] key.
2. Select "COMM", then press the [ENT] key.
3. Press the [◀] or [▶] key to select the desired channel from the list.
4. Press the [ENT] key.

Saving the Frequency to Memory

1. In the COM band screen, set the frequency to be stored with the DIAL selector knob or the keypad. Press the [SAVE] key.
3. To save the data without change, press the [SAVE] key.

Receiving the Weather Channels

1. Press the [MENU] key to display the MENU screen.
2. Press the [◀] or [▶] key to select "WEATHER", then press the [ENT] key.
3. Press the [◀] or [▶] key to select the desired channel from the list.
4. Press the [ENT] key.

Locking the Dial and Keys

Press and hold the [On] key. Press and hold the [On] key again to unlock.

Selecting the Operation Mode

1. Press the [MENU] key to display the MENU screen.
2. Press the [◀] or [▶] key to select the mode, then press the [ENT] key.
3. To return to the COMM mode, press the [COMM] key.

VOR and ILS Navigation

1. In the COM band screen, press the [ENT] key.
2. Select "VOR/ILS", then press the [ENT] key.
3. Press the [◀] or [▶] key to select the desired station from the list.
4. Press the [ENT] key.
When the VOR or ILS signal is received, the CDI (course deviation indicator) will appear on the display.

Entering and Editing Characters

1. Rotate the DIAL selector knob to select alphabets and numbers, then press the [ENT] key to set the character.
2. Press the appropriate key on the keypad to enter numbers.
3. Press the [◀] or [▶] key to move the cursor.
4. Press the [BACK] key to delete one character.
5. Press and hold the [BACK] key to clear all the characters in the field.

GPS Activation

1. Press the [MENU] key to display the MENU screen.
2. Press the [◀] or [▶] key to select "SETUP", then press the [ENT] key.
3. Select "GPS SETUP", then press the [ENT] key.
4. Select "GPS ON/OFF", then press the [ENT] key.
5. Select "ON", then press the [ENT] key.
6. To return to the COMM mode, press the [COMM] key.

Waypoint Navigation

1. In the COM band screen, press the [ENT] key.
2. Select "INFO", then press the [ENT] key.
3. Press the [ENT] key with the "GOTO" reversed.

Under Industry Canada regulations, this radio transmitter may only operate using an antenna of a type and maximum (or lesser) gain approved for the transmitter by Industry Canada. To reduce potential radio interference to other users, the antenna type and its gain should be so chosen that the equivalent isotropically radiated power (e.i.r.p.) is not more than that necessary for successful communication.

Conformément à la réglementation d'Industrie Canada, le présent émetteur radio peut fonctionner avec une antenne d'un type et d'un gain maximal (ou inférieur) approuvé pour l'émetteur par Industrie Canada. Dans le but de réduire les risques de brouillage radioélectrique à l'intention des autres utilisateurs, il faut choisir le type d'antenne et son gain de sorte que la puissance isotrope rayonnée équivalente (p.i.r.e.) ne dépasse pas l'intensité nécessaire à l'établissement d'une communication satisfaisante.

This radio transmitter (identify the device by certification number, or model number if Category II) has been approved by Industry Canada to operate with the antenna types listed below with the maximum permissible gain and required antenna impedance for each antenna type indicated. Antenna types not included in this list, having a gain greater than the maximum gain indicated for that type, are strictly prohibited for use with this device.

Le présent émetteur radio (identifier le dispositif par son numéro de certification ou son numéro de modèle s'il fait partie du matériel de catégorie I) a été approuvé par Industrie Canada pour fonctionner avec les types d'antenne énumérés ci-dessous et ayant un gain admissible maximal et l'impédance requise pour chaque type d'antenne. Les types d'antenne non inclus dans cette liste, ou dont le gain est supérieur au gain maximal indiqué, sont strictement interdits pour l'exploitation de l'émetteur.

Part 15.21: Changes or modifications to this device not expressly approved by YAESU MUSEN could void the user's authorization to operate this device.

YAESU

The radio

YAESU MUSEN CO., LTD.

Tennozu Parkside Building
2-5-8 Higashi-Shinagawa, Shinagawa-ku, Tokyo 140-0002 Japan

YAESU USA

6125 Phyllis Drive, Cypress, CA 90630, U.S.A.

YAESU UK

Unit 12, Sun Valley Business Park, Winnall Close
Winchester, Hampshire, SO23 0LB, U.K.

YAESU HK

Unit 2002, 20/F, 9 Chong Yip Street,
Kwun Tong, Kowloon, Hong Kong

Copyright 2013

YAESU MUSEN CO., LTD.

All rights reserved.

No portion of this manual may be
reproduced without the permission of
YAESU MUSEN CO., LTD.

Printed in Japan