



MATRIX GX1280S

25 Watt VHF/FM
Marine Transceiver

Owner's Manual

- Submersible
- DSC distress call automatically broadcasts lat/long and vessel ID*
- MARITEL DSC telephone capability
- DSC position request function and NMEA data input/output
- Latitude/Longitude and SOG/COG display*
- Channel name capability
- Versatile user-programmable Scanning, Priority Scan and Dual Watch
- NOAA Weather Alert
- One-button access to Channel 16 and 9
- Access to all US, Canadian and International channels
- Big, back-lit display and keys

* with GPS attached

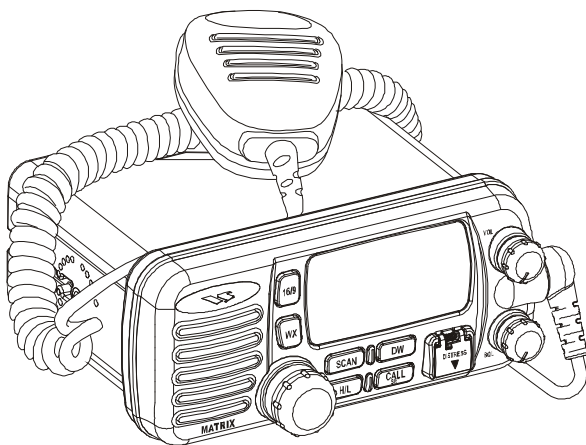



SAFETY / WARNING INFORMATION

This radio is restricted to occupational use, work related operations only where the radio operator must have the knowledge to control the exposure conditions of its passengers and bystanders by maintaining the minimum separation distance of 0.6 m (2 feet).

Failure to observe these restrictions will result in exceeding the FCC RF exposure limits.

Antenna Installation:

The antenna must be located at least 0.6 m (2 feet) away from passengers in order to comply with the FCC RF exposure requirements.

For roof top installation, the antenna must be placed in the center of the roof.

ON-LINE WARRANTY REGISTRATION

Please visit www.standardhorizon.com to register the **MATRIX** Marine VHF. It should be noted that visiting the Web site from time to time may be beneficial to you, as new products are released they will appear on the STANDARD HORIZON Web site.

PRODUCT SUPPORT INQUIRIES

If you have any questions or comments regarding the use of the **MA-TRIX**, you can visit the STANDARD HORIZON Web site to send an E-Mail or contact the Product Support team at 800-767-2450 M-F 7:00-5:00PST.

FCC RADIO LICENSE INFORMATION

Standard Horizon radios comply with the Federal Communication Commission (FCC) requirements that regulate the Maritime Radio Service.

STATION LICENSE

An FCC ship station license is no longer required for any vessel traveling in U.S. waters which is under 20 meters in length. However, any vessel required to carry a marine radio on an international voyage, carrying a HF single side band radiotelephone or marine satellite terminal is required to have a ship station license. FCC license forms, including applications for ship (506) and land station licenses can be downloaded via the Internet at www.fcc.gov/forms. To obtain a form from the FCC, call (888) 225-5322.

RADIO CALL SIGN

Currently the FCC does not require recreational boaters to have a Ship Radio Station License. The USCG recommends the boats registration number and the state to be used.

CANADIAN SHIP STATION LICENSING

You may need a license when traveling in Canada.. If you do need a license contact their nearest field office or regional office or write:

**Industry Canada
Radio Regulatory Branch
Attn: DOSP
300 Slater Street
Ottawa, Ontario
Canada, KIA 0C8**

FCC NOTICE

NOTICE

Unauthorized changes or modifications to this equipment may void compliance with FCC Rules. Any change or modification must be approved in writing by STANDARD HORIZON.

NOTICE

This equipment has been tested and found to comply with the limits for a Class B digital device, pursuant to Part 15 of the FCC Rules. These limits are designed to provide reasonable protection against harmful interference in a residential installation. This equipment generates, uses and can radiate radio frequency energy and, if not installed and used in accordance with the instructions, may cause harmful interference to radio communications. However, there is no guarantee that interference will not occur in a particular installation. If this equipment does cause harmful interference to radio or television reception, which can be determined by turning the equipment off and on, the user is encouraged to try to correct the interference by one or more of the following measures:

- Reorient or relocate the receiving antenna.
- Increase the separation between the equipment and receiver.
- Connect the equipment into an outlet on a circuit different from that to which the receiver is connected.
- Consult the dealer or an experienced radio/TV technician for help.

1 GENERAL INFORMATION

1.1 INTRODUCTION

The STANDARD HORIZON **MATRIX** is a VHF/FM transceiver designed for use in the frequency range of 156.025 to 163.275 MHz. The **MATRIX** requires 13.8V for operation and has a switchable RF output power of 1 watt or 25 watts.

The **MATRIX** is capable of RTCM SC101 DSC (Digital Selective Calling) operation and intercom operation with the use of an optional RAM mic (**CMP25** remote-control speaker/microphone with display).

The **MATRIX** operates on all currently-allocated marine channels which are switchable for use with either USA, International, or Canadian regulations. It has an emergency channel 16 which can be immediately selected from any channel by pressing the red **[16/9]** key. NOAA Weather channels can also be accessed immediately by pressing the **[WX]** key with channel selection.

Other features of the transceiver include: scanning, priority scanning, submersible speaker mic, high and low voltage warning, and GPS repeatability.

1.2 FCC / INDUSTRY CANADA INFORMATION

The following data pertaining to the transceiver is necessary to fill out the license application.

Type Acceptance FCC Part 80
Output Power 1 Watt (low) and 25 Watts (high)
Emission 16K0G3E, 16K0G2B
Frequency Range 156.025 to 163.275 MHz
FCC Type Number K66GX1280S
Industry Canada Type Approval.....511B-GX1280S V

2 ACCESSORIES

2.1 PACKING LIST

When the package containing the transceiver is first opened, please check it for the following contents:

- **GX1280S MATRIX** Transceiver (White/Black)
- Mounting Bracket and attaching hardware
- Owner's Manual
- Quick-Reference Card
- Power Cord
- Dust Cover

2.2 OPTIONS

| | |
|----------------|---|
| MMB-84 | Flush-Mount Bracket |
| CMP25B/W | Remote-Access Microphone (RAM Mic, Black/White) |
| CT-100 | 10-foot Extension Cable for RAM Mic |
| CVS2500 | Voice Scrambler |
| 101S | Mini Extension Speaker |
| 201S | White Extension Speaker |
| 201SZ | White Flush Mount Extension Speaker |
| 201SBK | Black Extension Speaker |
| 201SBKZ | Black Flush Mount Extension Speaker |

3 INSTALLATION

3.1 LOCATION

The radio can be mounted at any angle. Choose a mounting location that:

- is far enough from any compass to avoid any deviation in compass reading due to the speaker magnet
- provides accessibility to the front panel controls
- allows connection to a power source and an antenna
- has nearby space for installation of a microphone hanger
- the antenna must be mounted at least 3 feet from radio

3.2 ELECTRICAL CONNECTIONS

CAUTION

Reverse polarity connections will damage the radio!

Connect the power cord and antenna to the radio. Antenna and Power Supply connections are as follows (see Figure 1):

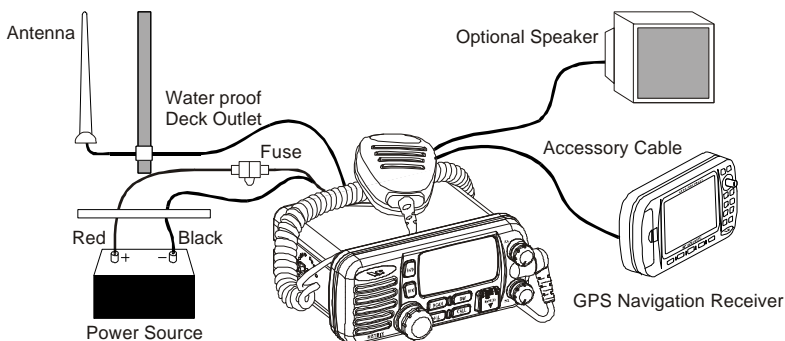

Figure 1. General Installation

1. Mount the antenna at least 3 feet away from the radio. At the rear of the radio, connect the antenna cable. It must have a PL259 connector. RG-8/U coaxial cable must be used if the antenna is 25 feet or more from the radio. RG58 cable can be used for distances less than 25 feet.
2. Connect the red power wire to a 13.8 VDC $\pm 20\%$ power source. Connect the black power wire to a negative ground.
3. If an optional remote extension speaker is to be used, refer to section 3.3 for connections.
4. It is advisable to have a Certified Marine Technician check the power output and the standing wave ratio of the antenna after installation.

3.3 ACCESSORY CABLE

White: External speaker (+)

Shield: External speaker (-)

Blue: NMEA IN (+) from GPS navigation receiver

Green: NMEA IN (-) from GPS navigation receiver

Gray: NMEA OUT (+) to GPS navigation receiver

Brown: Test port (for the Service Technician)

When connecting the external speaker or GPS navigation receiver, strip off about 1 inch (2.5 cm) of the specified wire's insulation.

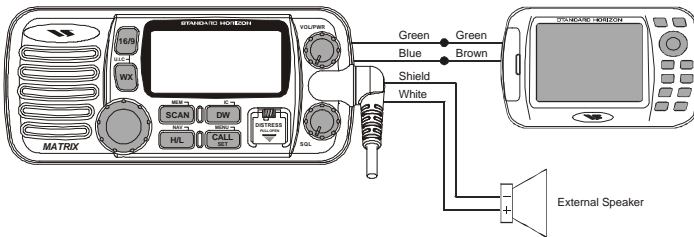

| Wire Color/Description | Connection Examples |
|-------------------------------|---|
| WHITE - External Speaker (+) | Connect to external 4 Ohm audio speaker |
| SHILED - External Speaker (-) | Connect to external 4 Ohm audio speaker |
| GREEN - NMEA Ground | Connect to NMEA (-) connection of GPS |
| BLUE- NMEA Input (+) | Connect to NMEA (+) output of GPS |

3.4 OPTIONAL MMB-84 FLUSH MOUNT INSTALLATION

1. Make a rectangular template for the flush mount measuring 2-1/8" H x 5-3/4" W.
2. Use the template to mark the location where the rectangular hole is to be cut. Confirm the space behind the dash or panel is deep enough to accommodate the transceiver (at least 6 inches deep). There should be at least 1/2 inch between the transceiver's heatsink and any wiring, cables or structures.
3. Cut out the rectangular hole and insert the transceiver.
4. Fasten the brackets to the sides of the transceiver with the lock washer nut combination, so that the mounting screw base faces the mounting surface (see Figure 2).
5. Turn the adjusting screw to adjust the tension so that the transceiver is tight against the mounting surface.

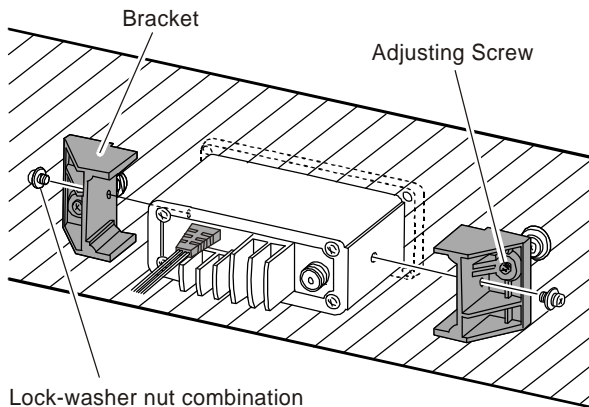

Figure 2. MMB-84 Flush Mount Installation

4 CONTROLS AND INDICATORS

NOTE

This section defines each control of the transceiver. See Figure 3 for location of controls. For detailed operating instructions refer to chapter 5 of this manual.

4.1 CONTROLS AND CONNECTIONS

① POWER SWITCH/VOLUME CONTROL

Turns the transceiver on and off as well as adjusts the audio volume. To turn the transceiver on press and hold this knob until the LCD turns on. To turn it off, press and hold this knob until the LCD turns off. When the power is turned on, the transceiver is set to the last selected channel.

Secondary Use

When the transceiver is turned on while the **[SCAN]** and **[WX]** keys are held down, the internal microprocessor is reset. This clears the memory and all user-programmed settings, such as scan memory, and priority scan assignments. This condition is known as the default condition, the same as when shipped from the factory. For a list of these defaults, see the section on Resetting the Transceiver's Microprocessor.

NOTE

Resetting the microprocessor **will not erase** DSC MMSI and Directory Call information.

② SQUELCH CONTROL (SQL)

Sets the point at which random noise on the channel does not activate the audio circuits but a received signal does. This point is called the squelch threshold. Further adjustment of the squelch control will degrade reception of wanted transmissions.

③ CHANNEL SELECTOR KNOB

Rotary knob used to select channels and, to choose the item selection of different functions (such as the DSC operation). The **[UP(▲)]** / **[DOWN(▼)]** key on the microphone can also be used to select them.

Secondary Use

While holding down the **[SCAN]** Key and turning the **CHANNEL** selector knob, you can confirm memory channels for scanning.

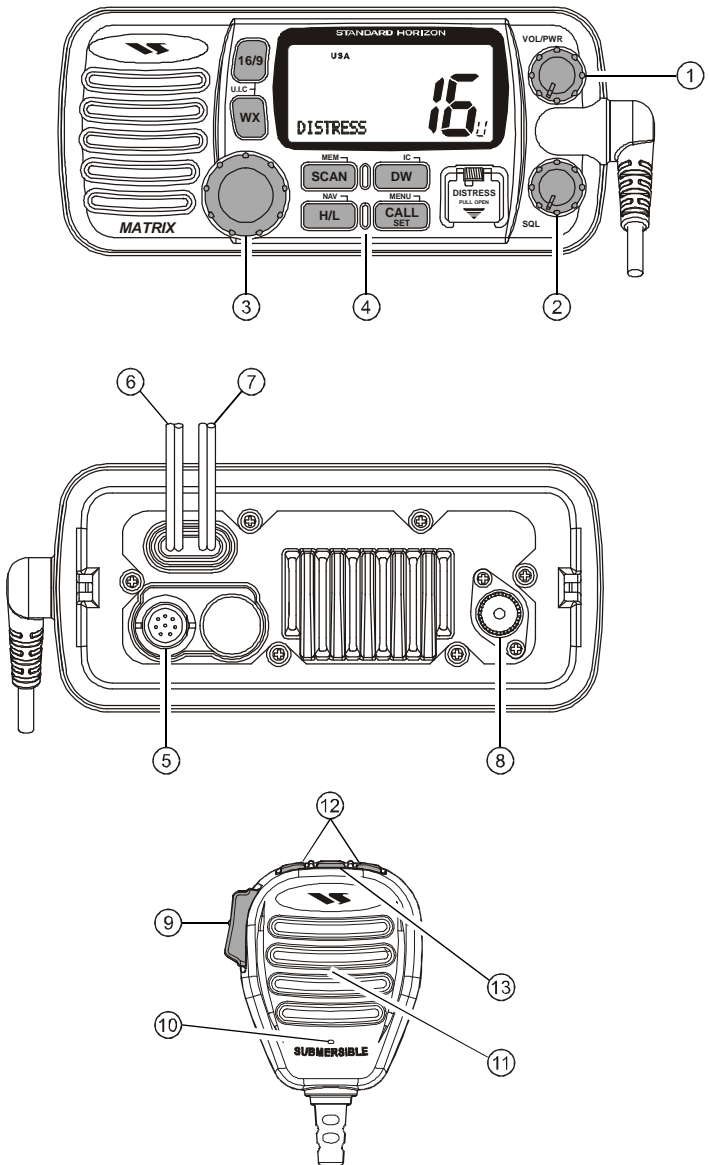

Figure 3. Controls and Connectors

④ **KEYPAD**

[16/9] Key

Immediately recalls channel 16 from any channel location. Holding down this key recalls channel 9. Pressing the **[16/9]** key again reverts to the previous selected working channel.

Secondary use

Please see secondary use for the **[WX]** and **[MEM]** key.

[WX] Key

Immediately recalls the previously selected NOAA weather channel from any channel location.

Secondary use

1. Holding down the **[16/9]** key while pressing the **[WX]** key changes the mode from USA to International or Canadian.

NOTE: If position is displayed, this icon will be hidden.

2. Holding down the **[WX]** and **[SCAN]** key while turning the power on resets the microprocessor and erases scan channels from memory. This clears the memory and establishes the factory-set defaults. For a list of these defaults, see the section on Resetting the Transceiver's Microprocessor.

[SCAN] Key

1. Starts and stops scanning of programmed channels.
2. If held while the **[UP(▲)]** or **[DOWN(▼)]** key on the microphone are pressed or **CHANNEL** selector knob on radio is turned, the radio will show the channels programmed in scan memory. This function will not work if the unit is scanning.

NOTE: The priority channel is channel 16 only.

[H/L] Key

Toggles between high and low power. When the **[H/L]** key is pressed while the transceiver is on channel 13 or 67, the power will temporarily switch from LO to HI power until the **PTT** is released. The **[H/L]** key does not function on transmit inhibited and low power only channels.

Secondary use

Press and hold **[H/L]** key, when connected to the GPS receiver, the LCD displays Position Data, Time, SOG (Speed Over Ground), and COG (Course Over Ground) from the GPS.

[DW] Key

Watches for a transmission on CH16 and another selected channel until either signal is received. (Dual watch)

NOTE: When the DSC SCANNING feature is enabled (see section 7.10 DSC SCANNING), the radio watches for a transmission on CH16, another selected channel, and **CH70** until either signal is received (Triple watch).

Secondary use

Press and hold [DW] key, when the optional RAM Mic is connected, intercom operation will operate between radio and RAM Mic.

[CALL/SET] Key

The [CALL/SET] key functions as the enter key.

Secondary use

Press the [CALL/SET] key to access the DSC OPERATION menu. The "INDIVIDUAL CALL" and "ALL SHIPS CALL" functions can be accessed from the DSC OPERATION menu.

Press and hold the [CALL/SET] key to access the RADIO SETUP or DSC SETUP menu. The following functions can be accessed in the menu.

RADIO SETUP menu

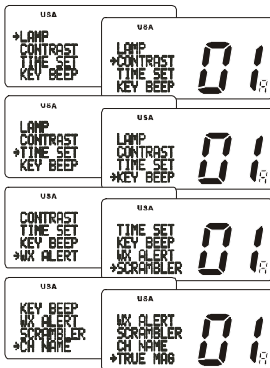

DSC SETUP menu

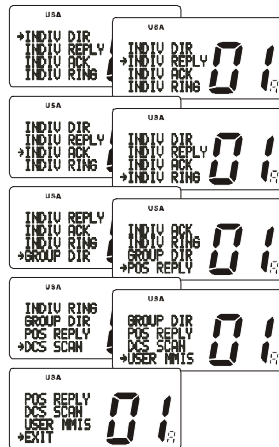

[DISTRESS] Key

Used to send a DSC Distress Call. To send the distress call see section 6.2 (Sending a Distress Call).

- ⑤ **RAM MIC CONNECTOR**
Connects the Remote Access Microphone (RAM MIC). Refer to section 8.0 RAM MIC OPERATION.
- ⑥ **ACCESSORY CONNECTION CABLE**
Connects the radio to a GPS, and an external speaker.
- ⑦ **DC INPUT CABLE**
Connects the radio to a DC power supply of 13.8V
- ⑧ **ANTENNA JACK**
Connects an antenna to the transceiver. Use a marine VHF antenna with an impedance of 50 ohms.
- ⑨ **PTT (Push-To-Talk) SWITCH**
Keys the transmitter when the transceiver is in radio mode. If the transceiver is in the intercom operation mode, it activates the microphone for the intercom.
- ⑩ **MICROPHONE**
Transmits the voice message with reduction of background noise.
- ⑪ **MICROPHONE SPEAKER**
The same audio heard through internal radio speaker as heard through microphone speaker.
- ⑫ **[UP(▲)] / [DOWN(▼)] KEYS**
The [UP(▲)] and [DOWN(▼)] on the microphone function the same as the **CHANNEL** selector knob on the front panel of the transceiver.
- ⑬ **[16/9] Key**
Pressing the [16/9] key immediately recalls channel 16 from any location. Press and hold the [16/9] key to recall channel 9. Pressing the [16/9] key again revert the radio to the previous select channel.

5 BASIC OPERATION

5.1 RECEPTION

1. After the transceiver has been installed, ensure that the power supply and antenna are properly connected.
2. Press and hold the **VOL/PWR** knob until the radio turns on.
3. Turn the **SQL** knob fully counterclockwise. This state is known as “squelch off”.
4. Turn up the **VOL/PWR** knob until noise or audio from the speaker is at a comfortable level.
5. Turn the **SQL** knob clockwise until the random noise disappears. This state is known as the “squelch threshold.”
6. Turn the **CHANNEL** selector knob to select the desired channel. Refer to the channel chart on page ?? for available channels.
7. When a message is received, adjust the volume to the desired listening level. The **“BUSY”** indicator in the LCD is displayed indicating that the channel is being used.

5.2 TRANSMISSION

1. Perform steps 1 through 6 of RECEPTION.
2. Before transmitting, monitor the channel to ensure it is clear. **THIS IS AN FCC REQUIREMENT!**
3. Press the **PTT** (push-to-talk) switch. The **“TX”** indicator on the LCD is displayed.
4. Speak slowly and clearly into the microphone.
5. When the transmission is finished, release the **PTT** switch.

NOTE

This is a noise-canceling microphone. The oval slot on the bottom of microphone should be positioned within 1 inch (2.5 cm) from the mouth for optimum performance.

6. Refer to page 38 for operating practices.

5.3 TRANSMIT TIME - OUT TIMER (TOT)

When the **PTT** switch on the microphone is held down, transmit time is limited to 5 minutes. This limits unintentional transmissions due to a stuck microphone. About 10 seconds before automatic transmitter shutdown, a warning beep will be heard from the speaker(s). The transceiver will automatically go to receive mode, even if the **PTT** switch is continually held down. Before transmitting again, the **PTT** switch must first be released and then pressed again.

5.4 SIMPLEX/DUPLEX CHANNEL USE

Refer to the VHF MARINE CHANNEL CHART (page 49) for instructions on use of simplex and duplex channels.

NOTE

All channels are factory-programmed in accordance with FCC (USA), Industry Canada (Canada), and International regulations. Mode of operation cannot be altered from simplex to duplex or vice-versa.

5.5 USA, CANADA, AND INTERNATIONAL MODE

1. To change the modes, hold the [16/9] key and press the [WX] key. The mode changes from USA to International to Canadian with each press of the [WX] key.
2. “USA” will be displayed on the LCD for USA mode, “INTL” will be displayed for International mode, and “CAN” will be displayed for Canadian mode.
3. Refer to the VHF MARINE CHANNEL CHART (page ??) for allocated channels in each mode.

5.6 NOAA WEATHER CHANNELS

1. To receive a NOAA weather channel, press the [WX] key from any channel. The transceiver will go to the last selected weather channel.
2. Turn the CHANNEL selector knob on the radio or [UP(▲)] / [DOWN(▼)] keys on the microphone to select a different NOAA weather channel.
3. To exit from the NOAA weather channels, press the [WX] key. The transceiver returns to the channel it was on prior to a weather channel.

5.7 NOAA WEATHER ALERT

In the event of extreme weather disturbances, such as storms and hurricanes, the NOAA (National Oceanic and Atmospheric Administration) sends a weather alert accompanied by a 1050 Hz tone and subsequent weather report on one of the NOAA weather channels. When the Weather Alert feature is enabled (see section 7.4 WEATHER ALERT), the transceiver is capable of receiving this alert if the following is performed:

1. Program NOAA weather channels into the transceiver's memory for scanning. Follow the same procedure as for regular channels under section 5.8.
2. Press the **[SCAN]** key once to start memory scanning or hold down the **[SCAN]** key during memory scanning to start priority scanning.
3. The programmed NOAA weather channels will be scanned along with the regular-programmed channels. However, scanning will not stop on a normal weather broadcast unless a NOAA alert is received.
4. When an alert is received on a NOAA weather channel, scanning will stop and the transceiver will emit a loud beep to alert the user of a NOAA broadcast.
5. Press the **[WX]** key to stop the alert tone and receive the weather report.

NOTE

If the **[WX]** key is not pressed the alert tone will be emitted for 5 minutes and then the weather report will be received.



NOTE

The Weather Alert feature is also engaged while the transceiver is received on the one of the NOAA weather channel.

5.8 MEMORY SCANNING (M-SCAN)

NOTE

- During scanning, the dot matrix area of the LCD will show M-SCAN or P-SCAN depending on the scan mode selected.
- If GPS position is displayed this icon will be hidden.

1. Adjust the **SQL** knob until background noise disappears.
2. Select a desired channel to be scanned using the **CHANNEL** selector knob. Press the **[MEM]** key, “**MEM**” will appear on the LCD which indicates the channel has been programmed into the transceivers memory. 
3. Repeat step 2 for all the desired channels to be scanned.
4. To DELETE a channel from the transceiver’s memory, press and hold the **[MEM]** key, “**MEM**” will disappear in the LCD.
5. To start scanning, press the **[SCAN]** key. Scanning will proceed from the lowest to the highest programmed channel number and will stop on a channel when a transmission is received. 
6. The channel number will blink during reception.
7. To stop scanning, press the **[SCAN]**, **[16/9]**, **[WX]**, or **PTT** key.

5.9 PRIORITY SCANNING (P-SCAN)

1. Any channel can be set as the priority channel, other than weather channels and channel 70. To set the priority channel, select the desired channel. Press and hold down the **[MEM]** key until “**P-CH**” is shown on the display. 
2. To select priority scanning, hold down the **[SCAN]** key until “**P-SCAN**” appears on the LCD during memory scanning. Scanning will proceed between the memorized channels and the priority channel. The priority channel will be scanned after each programmed channel.

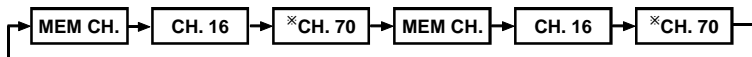

※: When DSC Scanning method is enabled. Default is DSC scan is ON.

3. The scanning will be performed while receiving the MEM CH (memorized channel).
4. To stop scanning, press the **[SCAN]**, **[16/9]**, **[WX]**, or **PTT** key.



NOTE

Triple watch (T/W) means the radio is watching CH70 for DSC Calls.
Dual watch (D/W) means the radio is not watching CH70 for DSC Calls.

5.10 NAVIGATION INDICATION

The transceiver has the ability to display the time, SOG and COG date, as well as the vessel's position (LAT/LON), if connected to a GPS receiver.

1. Press and hold the [H/L] key to display position information. If the GPS receiver receives no signal, the display will be as shown in the illustration on the right.
2. To hide the position information, press the [H/L] key.

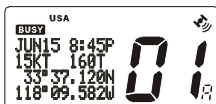

NOTE

The TIME OFFSET should be set to local time in the DSC/RADIO setup mode when the radio is connected to the GPS navigation receiver. To adjust TIME OFFSET to your local time, refer to section 7.11 TIME OFFSET.

5.11 VOICE SCRAMBLER

If privacy of communications is desired, a **CVS2500** voice scrambler (VS) can be installed in the transceiver. Contact your Dealer to have a **CVS2500** installed. Refer to the section 7.8 DSC/RADIO SET UP mode to program the voice scrambler.

1. Turn on the transceiver.
2. Select a channel that was programmed for scrambler mode. (Example: the voice scrambler code is set 3.)
 - If a channel is not set for the voice scrambler, the display will be as shown in the illustration at the right.
 - If a voice scrambler is canceled temporarily in the "SETUP" menu, the display will be as shown in the illustration at the right.
3. Monitor the channel before transmitting.
4. Transmit the voice message. The signal sent will be scrambled.

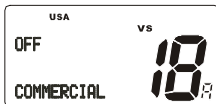
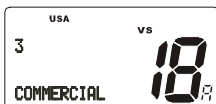

5.14 RESETTING THE TRANSCEIVER'S MICROPROCESSOR

Resetting the microprocessor restores the initial, factory supplied conditions in the transceiver. These are called the default conditions.

To reset the microprocessor, first turn the transceiver off. Then while pressing the **[WX]** and **[SCAN]** keys, turn the transceiver on. The default conditions are:

- No channels in the SCAN memory.
- Channel 16 will be selected when the transceiver is turned on.
- WX channel 01 will be recalled when the **[WX]** key is pressed.
- Key beep will be on.

NOTE

Resetting the microprocessor will not erase DSC MMSI and Directory Call Waiting information.

6 DIGITAL SELECTIVE CALLING

6.1 GENERAL

6.1.1 Digital Selective Calling (DSC)

Digital Selective Calling is a semi-automated method of establishing a radio call, it has been designated by the International Maritime Organization (IMO) as an international standard for establishing VHF, MF and HF radio calls. It had also been designated as part of the Global Maritime Distress and Safety System (GMDSS). It is planned that DSC will eventually replace aural watches on distress frequencies and will be used to announce routine and urgent maritime safety information broadcasts.

This new system will allow mariners to instantly send a distress call with GPS position (when connected to the transceiver) to the US Coast Guard and other vessels within range of the transmission. DSC will also allow mariners to initiate or receive distress, urgency, safety routine, POS Request, POS Send and Group calls to or from another vessel equipped with a DSC transceiver.

6.1.2 Maritime Mobile Service Identity (MMSI)

What is an MMSI?

An MMSI is a nine digit number used on Marine Transceiver capable of using Digital Selective Calling (DSC). This number is used like a telephone number to selectively call other vessels. Refer to section 7.13 (USER MMSI INPUT).

How can I obtain an MMSI assignment?

Contact your dealer, or Standard Horizon for details.

WARNING

This radio is designed to generate a digital maritime distress and safety call to facilitate search and rescue. To be effective as a safety device, this equipment must be used only within communication range of a shore-based VHF marine channel 70 distress and safety watch system. The range of signal may vary but under normal conditions should be approximately 20 nautical miles.

6.2 SENDING A DISTRESS CALL

The distress call automatically includes the vessel's DSC MMSI and Lat/Lon position. Refer to section 7.9 (USER MMSI INPUT). The vessel's position can be sent only if the transceiver is properly connected to an operating GPS receiver.

1. Lift the red spring loaded DISTRESS cover and press the **[DISTRESS]** key. The "DISTRESS" menu will appear on the LCD.
2. Press and hold the **[DISTRESS]** or **[CALL/SET]** key for 3 seconds or more. Holding time will appear on the LCD.
3. When the distress signal is sent, "TX" icon will appear on the LCD. After the message has been sent, the Distress Alarm will sound.
6. The transceiver "shadow-watches" for a transmission between CH16 and CH70 until an acknowledgment signal is received. "DISTRESS" and "WAITING" will appear on the LCD.
7. If no acknowledgment is received, the distress call is repeated in 4 minute intervals until an acknowledgment is received.
8. To cancel a Distress Call, press the **[16/9]** key, turn the **CHANNEL** selector knob to select "CANCEL." Then, press the **[CALL/SET]** key or turn off the radio.
9. When a distress acknowledgment is received, a distress alarm sounds and channel 16 is automatically selected.
LCD shows ID and the answering type.
RECEIVED ACK: acknowledgment signal is received.
RECEIVED RLY: relay signal is received from other vessel or coast station.
10. To cancel the alarm, press any key.



NOTE

When a GPS receiver with NMEA output is connected, the vessel's position is automatically transmitted with the distress call.

6.3 SENDING AN INDIVIDUAL CALL

This feature allows the user to contact another user vessel DSC and to automatically switch the receiving DSC radio to a desired working channel. This feature is similar to calling a vessel on CH16 and requesting to go to another channel. To send an individual call, see section 7.5 INDIVIDUAL DIRECTORY SETUP. The individual call function allows you to transmit a DSC signal to a specific party only, prompting communication on a voice channel.

1. Select the traffic channel for voice communication.
2. Press the **[CALL/SET]** key. The “DSC OPERATION” menu will appear.
3. Turn the **CHANNEL** selector knob to select “INDIVIDUAL.” (To cancel, select “EXIT” with the **CHANNEL** selector knob or press the **[16/9]** key.)
4. Press the **[CALL/SET]** key. The transceiver will beep, and the “Individual directory” will appear.
5. Turn the **CHANNEL** selector knob to select the “Individual” you want to contact.
6. Press the **[CALL/SET]** key to transmit the individual DSC signal.
7. After INDIVIDUAL CALL is transmitted, the transceiver will wait 8 seconds for the acknowledgment. If the reply signal is not received, the transceiver will transmit again.
8. After the second INDIVIDUAL CALL is transmitted, if the reply signal is not received, the dot matrix area of the LCD will display “→SEND” to prompt the user to send the call again or exit the mode.
9. When an individual call acknowledgment “able to comply” is received, the established channel is automatically selected and an alarm sounds.
10. When an individual call acknowledgment with “unable to comply” is received, the established channel is automatically selected.
11. To cancel, select “EXIT” using the **CHANNEL** selector knob and press the **[CALL/SET]** key. This procedure can be also canceled by pressing the **[CALL/SET]** key or **[16/9]** key.



6.4 SENDING A GROUP Call

This feature allows the user to contact a group of specific vessels using DSC and to automatically switch to a desired channel. This feature allows you to transmit a DSC signal with group MMSI that has been set according to section 7.13 Group MMSI INPUT.

1. Select the desired channel to use Group Call for voice communications.
2. Press the [CALL/SET] key. The “DSC OPERATION” menu will appear.
3. Turn the **CHANNEL** selector knob to select “GROUP.” (To cancel, select “EXIT” with the **CHANNEL** selector knob or press [16/9] key.)
4. Press the [CALL/SET] key. The transceiver will beep, and the “Individual directory” will appear.
5. Turn the **CHANNEL** selector knob to select the “Group” you want to contact.
6. Press the [CALL/SET] key to transmit the Group Call signal.
8. When the Group Call signal is sent, the dot-matrix area of the LCD will be as shown in the illustration at the right.
9. After the GROUP CALL is transmitted, all the radios in the group will switch to the designated channel.



6.5 SENDING AN ALL SHIPS CALL

The All Ships Call function allows contact to be established with other vessel stations without having their ID in the individual calling directory. Also, priority for the call can be designated as Urgency or Safety.

URGENCY Call: This type of call is used when a vessel may not truly be in distress, but have a potential problem that may lead to a distress situation.

SAFETY Call: Used to transmit boating safety information to other vessels. This message usually contains information about an overdue boat, debris in the water. Loss of a navigation aid or an important meteorological message.

1. Select the traffic channel (for voice communication).
2. Press the **[CALL/SET]** key. The “DSC OPERATION” menu will appear.
3. Turn the **CHANNEL** selector knob to select “ALL SHIPS.”
4. Press the **[CALL/SET]** key. (To cancel this, turn the **CHANNEL** selector knob to select “EXIT.”)
5. Turn the **CHANNEL** selector knob to select the nature of call (“URGENCY” or “SAFETY”).
6. Press the **[CALL/SET]** key to transmit the selected type of all ships DSC call.
7. After the ALL SHIPS CALL is transmitted, the transceiver will wait on CH16.



6.6 DSC STANDBY

The DSC Standby function allows the transceiver to reply to DSC calls with the Unattended message and logs the calls in the call waiting directory (This feature is similar to an answering machine). When set to the DSC Standby mode, voice traffic may still be monitored on the selected channel.

1. Press the **[CALL/SET]** key. The “DSC OPERATION” menu will appear.
2. Turn the **CHANNEL** selector knob to select the “STANDBY.”
3. Press the **[CALL/SET]** key.
4. When an individual DSC call is received, the radio will respond with the unattended message if an operator cannot answer the call. The DSC call will be logged into the radio’s call waiting directory.
5. To cancel this, press the **[16/9]** key.



NOTE

This function is available as following;
DSC SCAN is turned on, or the current channel is set to CH70 if DSC SCAN is turned off.

6.7 CALL WAITING DIRECTORY

The DSC Call Waiting directory logs 10 received distress calls, and logs 20 individual calls that are received and not answered within 5 minutes or while the radio is set on the DSC Standby function. Calls will be logged while busy with other communications as long as the transmitter is not keyed at the time of the call. If the call is answered within 5 minutes the call will not be logged. When a call is logged, a message will appear on the LCD.

NOTE

When a DISTRESS CALL is received, this call will be logged on the distress call waiting directory.

6.7.1 Operation of Distress Call Waiting

1. Press the [CALL/SET] key. The “DSC OPERATION” menu will appear.
2. Turn the **CHANNEL** selector knob to select “CALL WAIT.”
3. Press the [CALL/SET] key.
4. Turn the **CHANNEL** selector knob to select “DISTRESS.”
5. Press the [CALL/SET] key to enter the “distress log.”
6. Turn the **CHANNEL** selector knob to select the “name.”
7. Press the [CALL/SET] key to display the log data.
8. To exit from Distress Call Waiting, press the [CALL/SET] key and select “EXIT.”

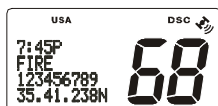

6.7.2 Operation of Individual Call Waiting

1. Press the [CALL/SET] key. The “DSC OPERATION” menu will appear.
2. Turn the **CHANNEL** selector knob to select “CALL WAIT.”
3. Press the [CALL/SET] key.
4. Turn the **CHANNEL** selector knob to select “INDIVIDUAL.”
5. Press the [CALL/SET] key to enter the “individual log.”
6. Turn the **CHANNEL** selector knob to select the “name.”
7. Press the [CALL/SET] key to display the “logged call.”
8. Press the [CALL/SET] key to resend the INDIVIDUAL CALL.
9. To exit from Individual Call Waiting, select “EXIT” and press the [CALL/SET] key.

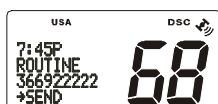

6.8 POSITION REQUEST

The position request mode may be used to show the position of another vessel that has a DSC radio with this feature. The other vessel must have an operating GPS receiver connected to its DSC transceiver and must not have its transceiver set to deny position requests. (Refer the section 7.5 to enter information into the individual directory).

1. Select a traffic channel, then press the **[CALL/SET]** key. The “DSC OPERATION” menu will appear in the display.
2. Turn the **CHANNEL** selector knob to select the “POS REQUEST.”
3. Press **[CALL/SET]** key to show the Position request directory. This directory uses the INDIVIDUAL Directory information.
4. Turn the **CHANNEL** selector knob to select a name.
5. Press the **[CALL/SET]** key to transmit the position request DSC call.
6. After a DSC position request is transmitted, the transceiver remains on channel 70 until position data is received.
7. The transceiver received position data from a vessel.
8. If the transceiver does not receive a reply, the LCD will display “>SEND” to prompt the user to send the call again or exit the mode.
9. If the transceiver received no position data, the LCD will show “NO POSITION DATA.”
10. When the transceiver receives the requested position, the transceiver outputs a NMEA DSC sentence which may be used by a Standard Horizon GPS chart plotter to show the vessels position.



6.9 POSITION SEND

The position send mode may be used to send your position to another radio with this feature. Your vessel must have an operating GPS receiver connected to its **MATRIX** to send the position and must not have its transceiver set to deny position send.

When other vessel receives your position, the transceiver outputs a NMEA DSC sentence which may be used by a Standard Horizon GPS chart plotter to show your position.

1. Select a traffic channel, then press the **[CALL/SET]** key. The “DSC OPERATION” menu will appear in the display.
2. Turn the **CHANNEL** selector knob to select the “POS SEND.”
3. Press the **[CALL/SET]** key to select the Position send directory. This directory uses the INDIVIDUAL Directory information.
4. Turn the **CHANNEL** selector knob to select a name.
5. Press the **[CALL/SET]** key to transmit your position DSC call.
6. After your position DSC is transmitted, the resend menu will appear. When you send your position DSC again, select “SEND” and press the **[CALL/SET]** key. When you exit the mode, select “EXIT” and press the **[CALL/SET]** key.
7. The transceiver returns to radio mode.

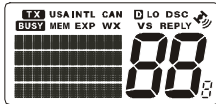
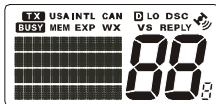
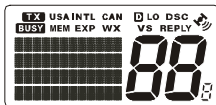
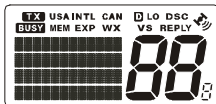
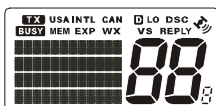
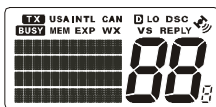

6.10 RECEIVING DSC CALLS

Several types of DSC transmissions can be received. The required action depends on the particular DSC type as outlined in the following examples.

NOTE

If the radio is receiving on a working channel or transmitting on a working channel, DSC calls will not be received.

6.10.1 Receiving a distress call

1. A distress call is received. An emergency alarm sounds.
Then channel 16 is automatically selected.
2. Press any key to stop the alarm.
3. Turn the **CHANNEL** selector knob to scroll the received distress data.
4. If the received distress data does not include the position data, the LCD will show the display on the left.

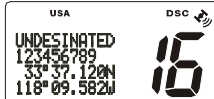
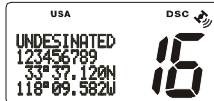

NOTE

You must continue monitoring channel 16 as a coast station may require assistance in any rescue attempt.

6.10.2 Receiving a distress relay call

1. A distress relay call is received. An emergency alarm sounds.
Then channel 16 is automatically selected.
2. Press any key to stop the alarm.
3. Turn the **CHANNEL** selector knob to scroll the received distress data.

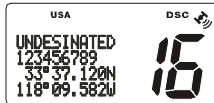

NOTE

You must continue monitoring channel 16 as a coast station may require assistance in any rescue attempt.

6.10.3 Receiving an all ships call

1. An all ships call is received. An emergency alarm sounds.
Then channel 16 is automatically selected.
2. Press any key to stop the alarm.
3. Turn the **CHANNEL** selector knob to scroll the received data.
4. Monitor channel 16 or traffic channel until the URGENCY communication is completed.

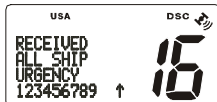
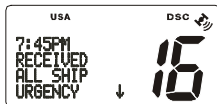

6.10.4 Receiving a geographical area call

1. A geographical call is received. An emergency alarm sounds (different from DISTRESS).
Then the requested channel from the other ship is automatically selected.
2. Press any key to stop the alarm.
3. Monitor the traffic channel for an announcement from the calling ship.



NOTE

This feature is only available when a GPS receiver is connected.

6.10.5 Receiving an individual call

When receiving an individual call, an acknowledgment must be sent back to the calling station.

1. An individual call is received. An individual call alarm sounds.
Then the radio automatically switches to the requested channel.
2. Press any key to stop the alarm.
3. Turn the **CHANNEL** selector knob to scroll the received data.
4. Press the PTT on the mic and talk to the calling ship.

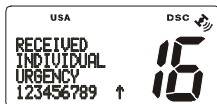
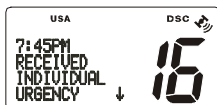

6.10.6.Receiving a position request

When a position request call is received from another vessel, a calling alarm will sound and POS REQUEST will show in the LCD. Operation and transceiver function differs depending on “POS REPLAY” in the “DSC SETUP” menu setting.

Automatically reply:

1. When a position request call is received, a calling alarm sounds 4 times. Then requested position coordinates are transmitted automatically.
2. To exit from position request display, press any key.

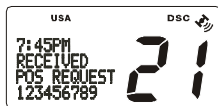

Manually reply:

1. When a position request call is received, the LCD will be as shown in the illustration at the right.
2. A calling alarm sounds 4 times. Then select type of reply function “REPLY” or “NO REPLY” by using the **CHANNEL** selector knob.
3. When “REPLY” is selected, press the [CALL/SET] key. And the requested position coordinates will be transmitted.
4. To exit from position request display, press any key.

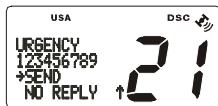
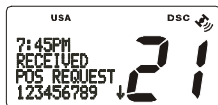

7 DSC / RADIO SETUP

NOTE

The optional RAM MIC CMP can be change the SETUP menu. Refer to page ?? for datiles.

7.1 LAMP ADJUSTING

1. Press and hold down the [CALL/SET] key until "RADIO SETUP" menu appear.
2. Press the [CALL/SET] key, then select "LAMP" in the "RADIO SETUP" menu with the CHANNEL selector knob.
3. Press the [CALL/SET] key.
4. Turn the CHANNEL selector knob to select the desired level. When "OFF" is selected, the lamp is extinguished.
5. Press the the [CALL/SET] key to store the selected level.
6. Turn the CHANNEL selector knob to select "EXIT," then press the [CALL/SET] key to return to the normal operation.



7.2 LCD CONTRUST

1. Press and hold down the [CALL/SET] key until "RADIO SETUP" menu appear.
2. Press the [CALL/SET] key, then select "CONTRUST" in the "RADIO SETUP" menu with the CHANNEL selector knob.
3. Press the the [CALL/SET] key.
4. Turn the CHANNEL selector knob to select the desired level. The contrust level can be set from "1" to "7."
5. Press the the [CALL/SET] key to store the selected level.
6. Turn the CHANNEL selector knob to select "EXIT," then press the [CALL/SET] key to return to the normal operation.



7.3 TIME OFFSET

Sets the time difference between local time and UTC. Time is displayed when position (LAT/LON) is displayed by pressing the [H/L] key.

1. Press and hold down the [CALL/SET] key until "RADIO SETUP" menu appear.
2. Press the [CALL/SET] key, then select "TIME SET" in the "RADIO SETUP" menu with the CHANNEL selector knob.
3. Press the [CALL/SET] key.
4. Turn the CHANNEL selector knob to select time offset from UTC. See illustration below to find your offset time from UTC. If "0:00" is assigned, the time is the same as UTC (Universal Time Coordinated or GMT Greenwich Mean Time).
5. Press the [CALL/SET] key to store the time offset.
6. Tune the CHANNEL selector knob to select "EXIT," then press the [CALL/SET] key to return to the normal operation.

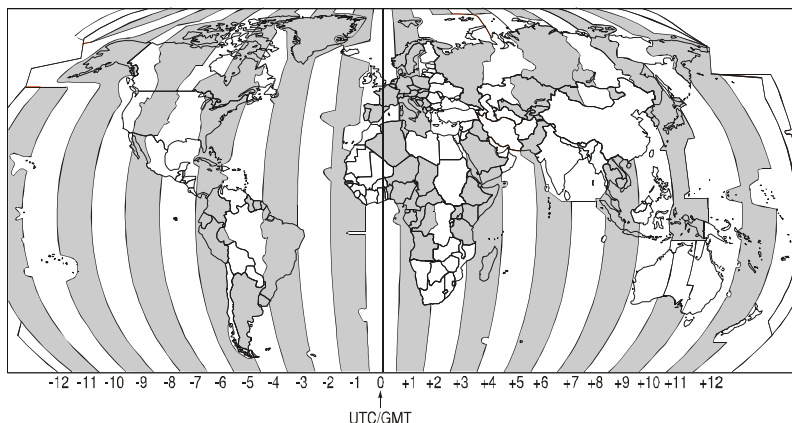
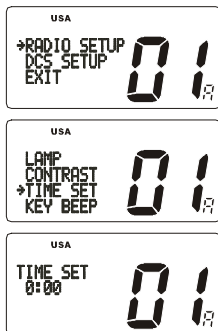

OFFSET TIME TABLE

7.4 KEY BEEP (ON/OFF)

1. Press and hold down the [CALL/SET] key until "RADIO SETUP" menu appear.
2. Press the [CALL/SET] key, then select "KEY BEEP" in the "RADIO SETUP" menu with the **CHANNEL** selector knob.
3. Press the [CALL/SET] key.
4. Turn the **CHANNEL** selector knob to select "ON" or "OFF."
5. Press the [CALL/SET] key to set the key beep condition.
6. Tune the **CHANNEL** selector knob to select "EXIT," then press the [CALL/SET] key to return to the normal operation.



NOTE

Emergency alarm and beeps for DSC operation cannot be turned OFF.

7.5 WX ALERT (ON/OFF)

1. Press and hold down the [CALL/SET] key until "RADIO SETUP" menu appear.
2. Press the [CALL/SET] key, then select "WX ALERT" in the "RADIO SETUP" menu with the **CHANNEL** selector knob.
3. Press the [CALL/SET] key.
4. Turn the **CHANNEL** selector knob to select "ON" or "OFF."
5. Press the [CALL/SET] key to store the selected setting.
6. Tune the **CHANNEL** selector knob to select "EXIT," then press the [CALL/SET] key to return to the normal operation.



7.6 VOICE SCRAMBLER

1. Press and hold down the [CALL/SET] key until "RADIO SETUP" menu appear.
2. Press the [CALL/SET] key, then select "SCRAMBLER" in the "RADIO SETUP" menu with the **CHANNEL** selector knob.
3. Press the [CALL/SET] key, then select "CODE" in the "SCRAMBLER" menu with the **CHANNEL** se-

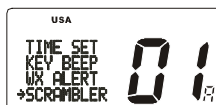

lector knob.

- Press the [CALL/SET] key, then turn the **CHANNEL** selector knob to change the scrambler code. The scrambler code can be set from "0" to "3" and "OFF." When "OFF" is selected, the voice scrambler is disabled.
- Press the [CALL/SET] key to store the selected code.
- Select "CHANNEL" in the "SCRAMBLER" menu with the **CHANNEL** selector knob, then press the [CALL/SET] key.
- Turn the **CHANNEL** selector knob to change the Scrambler channel.
- Press the [CALL/SET] key to store the selected channel. Repeat steps 6 and 7 to set other channels.
- Press and hold down the [CALL/SET] key.
- Tune the **CHANNEL** selector knob to select "EXIT," then press the [CALL/SET] key to return to the normal operation.

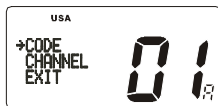

NOTE

This menu will not appear unless a CVS2500 is installed.

7.7 CH NAMING

- To select USA, INT or CANADA, press and hold the [16/9] key and press [WX] key.
- Press and hold down the [CALL/SET] key until "RADIO "SETUP" menu appear.
- Press the [CALL/SET] key, then select "CH NAME" in the "RADIO SETUP" menu with the **CHANNEL** selector knob.
- Press the [CALL/SET] key.
- Turn the **CHANNEL** selector knob to select the channel to be named and press the [CALL/SET] key.
- Turn the **CHANNEL** selector knob scroll through the alphabet and 0 - 9.
- Press the [CALL/SET] key to enter the desired letter and move the cursor one space to the right.



- Repeat procedure until the name is complete. The name can consist of up to twelve characters. If you do not use all twelve character, press the **[CALL/SET]** key to move to the next space. If you clear the previous letter, press the **[H/L]** key.
- Press and hold down the **[CALL/SET]** key to enter the name and exit from the “CHANNEL” menu. The LCD will return to the “SETUP” menu.
- If you want to enter the name of another channel, repeat steps 4 through 9.
- Tune the **CHANNEL** selector knob to select “EXIT,” then press the **[CALL/SET]** key to return to the normal operation.



7.8 TRUE MAGNETIC CHANGE

- Press and hold down the **[CALL/SET]** key until “RADIO SETUP” menu appear.
- Press the **[CALL/SET]** key, then select “TRUE MAG” in the “RADIO SETUP” menu with the **CHANNEL** selector knob.
- Press the **[CALL/SET]** key.
- Turn the **CHANNEL** selector knob to select “ON” or “OFF.”
- Press the **[CALL/SET]** key to store the selected setting.
- Tune the **CHANNEL** selector knob to select “EXIT,” then press the **[CALL/SET]** key to return to the normal operation.



7.9 INDIVIDUAL DIRECTORY SETUP

- Press and hold down the **[CALL/SET]** key until “RADIO SETUP” menu appear.
- Turn the **CHANNEL** selector knob to select “DSC SETUP” menu.
- Press the **[CALL/SET]** key, then select “INDIV DIR” in the “DSC SETUP” menu with the **CHANNEL** selector knob.
- Press the **[CALL/SET]** key, then select “ADD” in the “INDIV DIR” menu with the **CHANNEL** selector knob.
- Press the **[CALL/SET]** key.



6. Turn the **CHANNEL** selector knob to display the next address number.

(Example: The address number 01 - 04 have been stored in the illustration at the right.) The address number can be set from "01" to "30."



7. Press the **[CALL/SET]** key to store the address number.
8. Turn the **CHANNEL** selector knob scroll through the alphabet and 0 - 9.
9. Press the **[CALL/SET]** key to enter the desired letter and move the cursor one space to the right. Repeat procedure until the name is complete. The name can consist of up to eleven characters, if you do not use all eleven characters press the **[CALL/SET]** key to move to the next space. This method can also be used to enter a blank space in the name. To clear the previous letter, press the **[H/L]** key.
10. After the eleventh letter or space has been entered, press the **[CALL/SET]** key to advance to the MMSI (Maritime Mobile Service Identity Number) number entry.
11. Turn the **CHANNEL** selector knob to scroll through numbers, 0-9. To enter the desired number and move one space to the right press the **[CALL/SET]** key. Repeat procedure until all nine space of MMSI number are entered.
12. To enter another individual address, repeat steps 4 through 11.
13. After entering the MMSI number, tune the **CHANNEL** selector knob to select "EXIT," then press the **[CALL/SET]** key to return to the normal operation.

NOTE

Selecting "NEXT" or "EXIT" will automatically save the name and MMSI number into memory.

7.10 INDIVIDUAL REPLY

1. Press and hold down the [CALL/SET] key until "RADIO SETUP" menu appear.
2. Turn the **CHANNEL** selector knob to select "DSC SETUP" menu.
3. Press the [CALL/SET] key, then select "INDIV REPLY" in the "DSC SETUP" menu with the **CHANNEL** selector knob.
4. Press the [CALL/SET] key.
5. Turn the **CHANNEL** selector knob to select "AUTO" or "MANUAL."
6. Press the [CALL/SET] key to store the selected setting.
7. Tune the **CHANNEL** selector knob to select "EXIT," then press the [CALL/SET] key to return to the normal operation.



7.11 INDIVIDUAL ACK

1. Press and hold down the [CALL/SET] key until "RADIO SETUP" menu appear.
2. Turn the **CHANNEL** selector knob to select "DSC SETUP" menu.
3. Press the [CALL/SET] key, then select "INDIV ACK" in the "DSC SETUP" menu with the **CHANNEL** selector knob.
4. Press the [CALL/SET] key.
5. Turn the **CHANNEL** selector knob to select "ABLE" or "UNABLE."
6. Press the [CALL/SET] key to store the selected setting.
7. Tune the **CHANNEL** selector knob to select "EXIT," then press the [CALL/SET] key to return to the normal operation.



7.12 INDIVIDUAL RINGER

1. Press and hold down the [CALL/SET] key until "RADIO SETUP" menu appear.
2. Turn the **CHANNEL** selector knob to select "DSC SETUP" menu.
3. Press the [CALL/SET] key, then select "INDIV RING" in the "DSC SETUP" menu with the **CHANNEL** selector knob.
4. Press the [CALL/SET] key.
5. Turn the **CHANNEL** selector knob to select ringing time of a Individual Call. When "DEFAULT" is selected, the ringer rings for 3 minmutes continuously.
6. Press the [CALL/SET] key to store the selected setting.
7. Tune the **CHANNEL** selector knob to select "EXIT," then press the [CALL/SET] key to return to the normal operation.



7.13 GROUP MMIS INPUT

1. Press and hold down the [CALL/SET] key until "RADIO SETUP" menu appear.
2. Turn the **CHANNEL** selector knob to select "DSC SETUP" menu.
3. Press the [CALL/SET] key, then select "GROUP DIR" in the "DSC SETUP" menu with the **CHANNEL** selector knob.
4. Press the [CALL/SET] key, then select "ADD" in the "GROUP DIR" menu with the **CHANNEL** selector knob.
6. Press the [CALL/SET] key. The "Group MMIS" number will appear, and the first space will flash.
7. Turn the **CHANNEL** selector knob to set the number (0 to 9), then press the [CALL/SET] key to define the setting.
8. Repeat step 7 to set your Group MMIS (up to nine digits).
9. Tune the **CHANNEL** selector knob to select "EXIT," then press the [CALL/SET] key to return to the normal operation.



7.14 POSITION REQUEST REPLY

1. Press and hold down the [CALL/SET] key until "RADIO SETUP" menu appear.
2. Turn the **CHANNEL** selector knob to select "DSC SETUP" menu.
3. Press the [CALL/SET] key, then select "POS REPLY" in the "DSC SETUP" menu with the **CHANNEL** selector knob.
4. Press the [CALL/SET] key.
5. Turn the **CHANNEL** selector knob to select "AUTO" or "MANUAL." In "AUTO" mode, after a DSC POS Request is received, the radio will automatically transmit your vessels position. In "MANUAL" mode, the display of the **MATRIX** will show who is requesting the position.
6. Press the [CALL/SET] key to store the selected setting.
7. Tune the **CHANNEL** selector knob to select "EXIT," then press the [CALL/SET] key to return to the normal operation.



7.15 DSC SCAN

When the radio is shipped from the factory it is programmed so CH70 (the DSC channel) is scanned at all times. There is a selection in the SETUP MENU to disable the DSC SCAN. However, turning off DSC SCAN will disable the radio from receiving DSC calls (i.e.: Individual Call, All Ships Call, Distress Call and Position Requests). If you want to use any of the functions the selection must be left ON.

To Change DSC SCAN Method:

1. Press and hold down the [CALL/SET] key until "RADIO SETUP" menu appear.
2. Turn the **CHANNEL** selector knob to select "DSC SETUP" menu.
3. Press the [CALL/SET] key, then select "DSC SCAN" in the "DSC SETUP" menu with the **CHANNEL** selector knob.
4. Press the [CALL/SET] key.
5. Turn the **CHANNEL** selector knob to select "ON" or "OFF."



6. Press the [CALL/SET] key to store the selected setting.
7. Tune the **CHANNEL** selector knob to select “EXIT,” then press the [CALL/SET] key to return to the normal operation.



7.16 USER MMIS INPUT

1. Press and hold down the [CALL/SET] key until “RADIO SETUP” menu appear.
2. Turn the **CHANNEL** selector knob to select “DSC SETUP” menu.
3. Press the [CALL/SET] key, then select “USER MMIS” in the “DSC SETUP” menu with the **CHANNEL** selector knob.
4. Press the [CALL/SET] key. The “User MMIS” number will appear, and the first space will flash.
5. Turn the **CHANNEL** selector knob to select first number of your MMSI, then press the [CALL/SET] key to define the setting.
6. Repeat step 5 to set your MMIS (up to nine digits).
7. Tune the **CHANNEL** selector knob to select “EXIT,” then press the [CALL/SET] key to return to the normal operation.



NOTE

User MMSI can be input only twice. If the user tries to input MMSI more than twice, the radio will show the display on the right. If the user needs to change the MMSI more than twice, the transceiver will have to be sent to Factory Service. Refer to the section 10.2 FACTORY SERVICE.

8 RAM MIC OPERATION

If the optional RAM Mic (**CMP25**) is connected to the remote microphone connector on the transceiver's rear panel, the transceiver can use the remote control operation except for a few functions. The RAM Mic has a maximum range of 50 feet (15 m) with the use of two 10-foot extension cables (**CT-100**). The intercom operation can be used between the RAM Mic and the transceiver.

8.1 RAM MIC CONTROLS AND CONNECTIONS

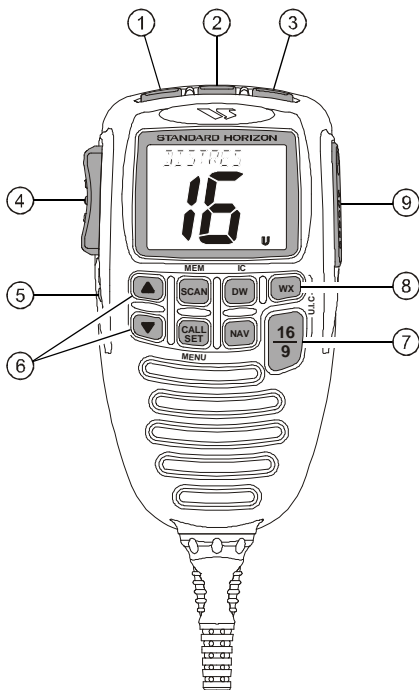

① SQUELCH CONTROL (SQL)

Activates the squelch adjusting mode.

Press this key to activate the squelch adjusting mode. Press the microphone's [▲] or [▼] key to adjust the squelch.

When this key is pressed and held down for 1 second or more, the squelch is turned off.

② **VOLUME KEY (VOL)**

Activates the volume adjusting mode.

Press this key to activate the volume adjusting mode. Press the microphone's [▲] or [▼] to adjust the volume.

③ **POWER SWITCH (PWR)**

Press and hold down this key to turn to the transceiver and RAM Mic on and off.

④ **PTT (Push-To-Talk) SWITCH**

Activates transmission.

⑤ **[H/L] KEY**

Toggles between high and low power. When the [H/L] key is pressed while the transceiver is on channel 13 or 67, the power will temporarily switch from LO to HI power until the **PTT** is released. The [H/L] key does not function on transmit inhibited and low power only channels.

⑥ **[▲](UP)/[▼](DOWN) KEY**

These keys used to select channels, adjusts the volume and squelch level, and to choose the item selection of different functions (such as the DSC operation). In many ways, these keys emulate the function of the transceiver's **CHANNEL** selector knob.

⑦ **[16/9] KEY**

Immediately recalls channel 16 from any channel location. Holding down this key recalls channel 9. Pressing the [16/9] key again reverts to the previous selected working channel.

Secondary use

Please see secondary use for the [WX] and [MEM] key.

⑧ **KEY PAD**

[SCAN] Key

1. Starts and stops scanning of programmed channels.
2. If held while the [UP(▲)] or [DOWN(▼)] key on the microphone are pressed or **CHANNEL** selector knob on radio is turned, the radio will show the channels programmed in scan memory. This function will not work if the unit is scanning.

NOTE: The priority channel is channel 16 only.

[CALL/SET] Key

The [CALL/SET] key functions as the enter key.

Secondary use

Press the [CALL/SET] key to access the DSC OPERATION menu.

Press and hold the [CALL/SET] key to access the SETUP menu.

[DW] Key

Watches for a transmission on CH16 and another selected channel until either signal is received. (Dual watch)

NOTE: When the DSC SCANNING feature is enabled (see section 7.10 DSC SCANNING), the radio watches for a transmission on CH16, another selected channel, and **CH70** until either signal is received (Triple watch).

Secondary use

Press and hold [DW] key, intercom operation will operate between radio and RAM Mic.

[NAV] Key

Press and hold this key, when connected to the GPS receiver, the LCD displays Position Data, Time, SOG (Speed Over Ground), and COG (Course Over Ground) from the GPS.

[WX] Key

Immediately recalls the previously selected NOAA weather channel from any channel location.

Secondary use

1. Holding down the [16/9] key while pressing the [WX] key changes the mode from USA to International or Canadian.

NOTE: If position is displayed, this icon will be hidden.

2. Holding down the [WX] and [SCAN] key while turning the power on resets the microprocessor and erases scan channels from memory. This clears the memory and establishes the factory-set defaults. For a list of these defaults, see the section on Resetting the Transceiver's Microprocessor.

⑨ [DISTRESS] KEY

Used to send a DSC Distress Call. To send the distress call see section 6.2 (Sending a Distress Call).

8.2 INTERCOM OPERATION

8.2.1 Communication

1. Press and hold the [DW] key while in the “RADIO” mode, the mode is changed to “INTERCOM” mode. If press and hold the [DW] key again the mode will revert to “RADIO” mode.
2. “IC” is displayed on both the transceiver and the RAM Mic when the “INTERCOM” operation is activated.
3. Press the PTT switch. The “TX” indicator is displayed.

NOTE

A warning beep is emitted when the RAM Mic PTT switch is pressed while the transceiver microphone's PTT switch is pressed.

4. Speak slowly and clearly into the microphone, hold the microphone about 1/2 inch away from your mouth.
5. When finished, release the PTT switch.

8.2.2 Calling

Hold down the [DW] key for 1 second or more, when the “INTERCOM” operation is activated. A calling beep is emitted twice from the transceiver speaker.

8.3 DSC/RADIO SETUP MODE

The **CMP25** can be setup the all DSC/RADIO setup menu (refer to section 7 “DSC/RADIO SETUP” for details), as well. However, the LAMP, CONTRAST, and KEY BEEP menu item which is accessed from the **CMP25** only works to the CMP25's display and speaker only. In other wards, the LAMP, CONTRAST, and KEY BEEP menu item which is accessed from the radio only works to the radio's display and speaker.

Here is the general procedures for the setup of the DSC/RADIO Setup mode from the **CMP25**:

1. Press and hold down the [CALL/SET] key until “RADIO SETUP” menu appear.
2. Press the [▲]/[▼] key to select “RADIO SET” or “DSC SETUP” menu.
3. Press the [CALL/SET] key, then select the menu item you wish to work on by pressing the [▲]/[▼] key.
4. Press the [CALL/SET] key.
5. Press the [▲]/[▼] key to change the value or condition for the menu item, then press the [CALL/SET] key to save the new setting.

6. Press the [▲]/[▼] key to select “EXIT,” then press the [CALL/SET] key to return to the normal operation.

8 OPERATING PRACTICES

8.1 EMERGENCY (CHANNEL 16 USE)

Channel 16 is known as the Hail and Distress Channel. An emergency may be defined as a threat to life or property. In such instances, be sure the transceiver is on and set to CHANNEL 16. Then use the following procedure:

1. Press the microphone push-to-talk switch and say "**Mayday, Mayday, Mayday**. This is __, __, __" (your vessel's name).
2. Then repeat once: "**Mayday, __**" (your vessel's name).
3. Now report your position in latitude/longitude, or by giving a true or magnetic bearing (state which) to a well-known landmark such as a navigation aid or geographic feature such as an island or harbor entry.
4. Explain the nature of your distress (sinking, collision, aground, fire, heart attack, life-threatening injury, etc.).
5. State the kind of assistance you desire (pumps, medical aid, etc.).
6. Report the number of persons aboard and condition of any injured.
7. Estimate the present seaworthiness and condition of your vessel.
8. Give your vessel's description: length, design (power or sail), color and other distinguishing marks. The total transmission should not exceed 1 minute.
9. End the message by saying "**OVER**". Release the microphone button and listen.
10. If there is no answer, repeat the above procedure. If there is still no response, try another channel.

8.2 CALLING ANOTHER VESSEL (CHANNEL 16 OR 9)

Channel 16 may be used for initial contact (hailing) with another vessel. However, its most important use is for emergency messages. This channel must be monitored at all times except when actually using another channel. It is monitored by the U.S. and Canadian Coast Guards and by other vessels. **Use of channel 16 for hailing must be limited to initial contact only.** Calling should not exceed 30 seconds, but may be repeated 3 times at 2-minute intervals. In areas of heavy radio traffic, congestion on channel 16 resulting from its use as a hailing channel can be reduced significantly in U.S. waters by using **channel 9** as the initial contact (hailing) channel for non-emergency communications. Here, also, calling time should not exceed 30 seconds but may be repeated 3 times at 2-minute intervals.

Prior to making contact with another vessel, refer to the channel charts in this manual, and select an appropriate channel for communications after initial contact. For example, Channels 68 and 69 of the U.S. VHF Charts are some of the channels available to non-commercial (recreational) boaters. Monitor your desired channel in advance to make sure you will not be interrupting other traffic, and then go back to either channel 16 or 9 for your initial contact.

When the hailing channel (16 or 9) is clear, state the name of the other vessel you wish to call and then **“this is”** followed by the name of your vessel and your Station License (Call Sign). When the other vessel returns your call, immediately request another channel by saying **“go to,”** the number of the other channel, and **“over.”** Then switch to the new channel. When the new channel is not busy, call the other vessel.

After a transmission, say **“over,”** and release the microphone’s push-to-talk (PTT) switch. When all communication with the other vessel is completed, end the last transmission by stating your Call Sign and the word **“out.”** Note that it is not necessary to state your Call Sign with each transmission, only at the beginning and end of the contact.

Remember to return to Channel 16 when not using another channel. Some radios automatically monitor Channel 16 even when set to other channels or when scanning; see your Owner’s Manual.

8.3 MAKING TELEPHONE CALLS

To make a radiotelephone call, use a channel designated for this purpose, The fastest way to learn which channels are used for radiotelephone traffic is to ask at a local marina. Channels available for such traffic are designated **Public Correspondence** channels on the channel charts in this manual. Some examples for USA use are Channels 24, 25, 26, 27, 28, 84, 85, 86, and 87. Call the marine operator and identify yourself by your vessel’s name, The marine operator will then ask you how you will pay for the call (telephone credit card, collect, etc.) and then link your radio transmission to the telephone lines.

The marine telephone company managing the VHF channel you are using may charge a link-up fee in addition to the cost of the call.

8.4 OPERATING ON CHANNELS 13 AND 67

Channel 13 is used at docks and bridges and by vessels maneuvering in port. Messages on this channel must concern navigation only, such as meeting and passing in restricted waters.

Channel 67 is used for navigational traffic between vessels.

By regulation, power is normally limited to 1 Watt on these channels. Your radio is programmed to automatically reduce power to this limit on these channels. However, in certain situations it may be necessary to temporarily use a higher power. See page 7 (H/L key) for means to temporarily override the low-power limit on these two channels.

8.5 PROHIBITED COMMUNICATIONS

The FCC prohibits the following communications:

- False distress or emergency messages;
- Messages to “any boat” except in emergencies and radio tests;
- Messages to or from a vessel on land;
- Transmission while on land;
- Obscene, indecent, or profane language (potential fine of \$10,000).

8.6 NOAA WEATHER ALERT TESTING

In the event of a major storm or other appreciable weather condition requiring vessels at sea or other bodies of water to be notified, the NOAA (National Oceanographic and Atmospheric Administration) broadcasts a 1050 Hz tone that some marine VHF radios can detect. (Refer to Section 5.7 “NOAA WEATHER ALERT” on how to use this feature.) This tone, when detected, will produce a loud beep from the radio speaker to signal that a weather alert is being broadcast.

In order to test this system, the NOAA broadcasts the 1050 Hz tone every Wednesday, sometime between 11 AM and 1 PM. Any marine VHF radio that can detect the weather alert tone, may use this test to verify that this feature is functioning properly.

8.7 DIGITAL SELECTIVE CALLING (DSC)

Digital Selective Calling is a semi-automated method of establishing a radio call, it has been designated by the International Maritime Organization (IMO) as an international standard for establishing VHF, MF and HF radio calls. It has also been designated part of the Global Maritime Distress and Safety System (GMDSS) and it is planned that DSC will eventually replace aural watches on distress frequencies and will be used to announce routine and urgent maritime safety information broadcasts.

This new service will allow mariners to instantly send a distress call with GPS position (when connected to the transceiver) to the US Coast Guard and other vessels within range of the transmission. DSC will also allow mariners to initiate or receive distress, urgency, safety and routine calls to or from another vessel equipped with a DSC transceiver.

8.7.1 USCG DSC Watch

The USCG has plans to upgrade its VHF National Distress System (expected by 2005), so at the time of printing only larger vessels that are required to carry VHF DSC radios will be able to hear your distress transmission.

8.8 MARITIME MOBILE SERVICE IDENTITY (MMSI)

8.8.1 What is an MMSI?

An MMSI is a nine digit number used on Marine Transceivers capable of using Digital Selective Calling (DSC). This number is used like a telephone number to selectively call other vessels.

8.9 USING DIGITAL SELECTIVE CALLING FEATURES

8.9.1 Distress Call

Transmits a DSC Distress message to all radios equipped to receive a DSC Distress call. Some Standard Horizon radios may be connected to a GPS to also transmit the Latitude, Longitude of the vessel.

8.9.2 Individual Call

This feature allows the user to contact another vessel capable of using DSC and automatically switch the radio to a desired working channel. This feature is similar to calling a desired vessel on CH16 and requesting them to go to another channel.

8.9.3 Urgency Call

This call should be used when a vessel may not be truly in distress, but have a potential problem that might lead to a distress situation.

8.9.4 Safety Call

Used to transmit boating safety information to other vessels. This message usually contains information about an overdue boat, a derelict afloat, loss of a navigation aid or an important meteorological message.

8.10 ADDITIONAL DIGITAL SELECTIVE CALLING INFORMATION

For additional information the USCG has an excellent site that should be visited at www.navcen.uscg.gov/marcoms/gmdss/dsc.html.

8.11 ABOUT VHF RADIO

The radio frequencies used in the VHF marine band lie between 156 and 158 MHz with some shore stations available between 161 and 163 MHz. The marine VHF band provides communications over distances that are essentially “line of sight” (VHF signals do not travel well through objects such as buildings, hills or trees). Actual transmission range depends much more on antenna type, gain and height than on the power output of the transmitter. On a fixed mount 25W radio transmission expected distances can be greater than 15 miles, for a portable 5W radio transmission the expected distance can be greater than 5 miles in “line of sight”.

8.12 SELECTING AN ANTENNA

Marine antennas are made to radiate signals equally in all horizontal directions, but not straight up. The objective of a marine antenna is to enhance the signal toward the horizon. The degree to which this is accomplished is called the antenna’s gain. It is measured in decibels (dB) and is one of the major factors in choosing an antenna. In terms of effective radiated power (ERP), antennas are rated on the basis of how much gain they have over a theoretical antenna with zero gain. A 3 foot, 3dB gain antenna represents twice as much gain over the imaginary antenna. The length of the antenna you choose, however, must also be related to the size of your boat.

Typically a 3 foot 3dB gain stainless steel whip is used on a sailboat mast. The longer 8 foot 6dB fiberglass whip is primarily used on power boats that require the additional gain.

8.13 COAXIAL CABLE

VHF antennas are connected to the transceiver by means of a coaxial cable – a shielded transmission line. Coaxial cable is specified by its diameter and construction.

For runs less than 20 feet, RG-58/U, about 1/4 inch in diameter is a good choice. For runs over 20 feet but less than 50 feet, the larger RG-8 or RG-213/U should be used for cable runs over 50 feet RG-8 should be used. For installation of the connector onto the coaxial cable refer to the figure below.

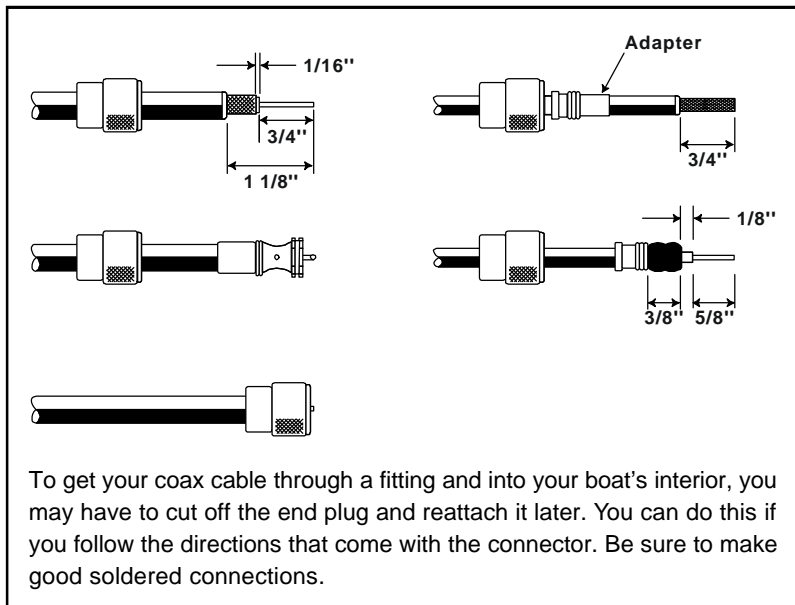

9 MAINTENANCE

The inherent quality of the solid-state components used in this transceiver will provide many years of continuous use. Taking the following precautions will prevent damage to the transceiver.

- Keep the microphone connected or the jack covered at all times to prevent corrosion of electrical contacts;
- Never key the microphone unless an antenna or suitable dummy load is connected to the transceiver.
- Ensure that the supply voltage to the transceiver does not exceed 16 VDC or fall below 11 VDC.
- Use only STANDARD HORIZON-approved accessories and replacement parts.

In the unlikely event of serious problems, please contact your Dealer or our repair facility. Address and phone numbers for this facility, as well as warranty information, are contained in section 11 WARRANTY.

9.1 REPLACEMENT PARTS

Occasionally an owner needs a replacement mounting bracket or knob. These can be ordered from our Parts Department by writing or calling:

Marine Division of Vertex Standard

US Headquarters

10900 Walker Street, Cypress, CA 90630, U.S.A.

Telephone (714) 827-7600

Commonly requested parts, and their part numbers are listed below.

- **Power Code:** T9023306
- **Dust Cover:** RA0437900
- **VOL/SQL Knob Assy:** RA0422200
- **Mounting Bracket (White):** RA0448900
- **Microphone Hanger:** RA0436000

9.2 FACTORY SERVICE

In the unlikely event that the radio fails to perform or needs servicing, please contact the following:

Standard Horizon Factory Service

115 North Wright Brothers Drive

Salt Lake City, UT 84116-2838

Telephone (800) 366-4566

Fax No. (801) 359-4122

An "RA" Return Authorization number is not necessary to send a product in for service. Include a brief note describing the problem along with your name, return address, phone number, and proof of purchase.



9.3 TROUBLESHOOTING CHART

| SYMPTON | PROBABLE CAUSE | REMEDY |
|---|--|--|
| Transceiver fails to power up. | No DC voltage to the transceiver, or blown fuse. | Rotate the VOL/PWR knob clockwise to turn on the transceiver. |
| Transceiver blows fuse when connected to power supply. | Reversed power wires. | Check the power cable for DC voltage, or replace the fuse (6A 250V). Make sure the red wire is connected to the positive (+) battery post, and the black wire is connected to the negative (-) battery post. If the fuse still blows, contact your Dealer. |
| Popping or whining noise from the speaker while engine runs. | Engine noise. | Reroute the DC power cables away from the engine. Add noise suppressor on power cable. Change to resistive spark plug wires and/or add an alternator whine filter. |
| Sound is not emitted from the external speaker. | External cable. | Check the polarity of the connected external cable. |
| Receiving station report low transmit power, even with transceiver set to HI power. | Antenna. | Have the antenna checked or test the transceiver with another antenna. If the problem persists, contact your Dealer for servicing. |
| "HI BATTERY" or "LO BATTERY" message is appeared when the power is turned on. | The power supply voltage is too high or too low. | Confirm that the connected power supply voltage is not 17 volts or lower than 10 volts. Confirm that the generator has not malfunctioned. |
| Your position is not displayed. | External cable. | Check the polarity of the connected external cable. Some GPS use the battery ground line for NMEA connection. |
| | Setting of the GPS navigation receiver. | Check the output signal format of the GPS navigation receiver. This radio requires NMEA0183 format with GLL sentence as an output signal. If the GPS has a baud rate setting make sure to select 4800 and parity to NONE. |

9.4 CONNECTION OF GPS WITH NMEA OUTPUT

| Manufacturer/Model | Wires | MATRIX | Manufacturer/Model | Wires | MATRIX |
|---|-------------|--------|-------------------------|-------------|--------|
| STANDARD HORIZON CP150, CP160 and CP-170C | Green | Green | Lowrance Portable | Orange | Blue |
| | Brown | Blue | | Black (GND) | Green |
| Furuno GP30, 36 | White | Blue | Magellan Fixed Mount | Gray | Blue |
| | Blue | Green | | Black (GND) | Green |
| Furuno GP1650, 1850 | White | Blue | Magellan Portable | Orange | Blue |
| | Black | Green | | Black (GND) | Green |
| Garmin Fixed Mounts | Blue | Blue | Northstar | Yellow | Blue |
| | Black (GND) | Green | | Black (GND) | Green |
| Garmin Portables | Brown | Blue | Raytheon 420 | Yellow | Blue |
| | Black (GND) | Green | | Brown | Green |
| JRC GPS500 | Yellow | Blue | Raytheon 520 / 620 | Blue | Blue |
| | Green | Green | | Brown | Green |
| JRC 100 SERIES | Green | Blue | Raytheon RL SERIES | White | Blue |
| | Black | Green | | Brown | Green |
| JRC 200 SERIES | White | Blue | Simrad | White | Blue |
| | Black | Green | | Brown | Green |
| Lowrance Fixed Mount | White | Blue | Sitex Neptune, Nautilus | Gray | Blue |
| | Black (GND) | Green | | Brown | Green |

Additional Information:

- The GPS must have the NMEA Output turned on and set to 4800 Baud in the setup menu. If there is a selection for parity select none.
- For further information on interfacing /setting up your GPS. Please contact the manufacturer of the GPS receiver.
- QUEST is corresponded with following NMEA sentence:
 - NMEA-0183 version 2.0 or higher
 - GLL, GGA, RMC and GNS (RMC sentence is recommended)

If you have further inquires, please feel free to contact us at:

Phone: (800) 767-2450

Fax: (714) 527-9031

Web site: standardhorizon.com

Email: marinetech@vxstdusa.com

10. CHANNEL ASSIGNMENTS

Tables on the following columns list the VHF Marine Channel assignments for U.S.A. and International use. Below are listed some data about the charts.

1. VTS. Where indicated, these channels are part of the U.S. Coast Guard's **Vessel Traffic System**.
2. Alpha channel numbers, that is, channel numbers followed by the letter A (such as Channel 07**A**) are **simplex** channels on the U.S.A. or Canadian channel assignments whose counterparts in the International assignments are **duplex** channels. International channels do not use "alpha" numbers. If you call the Coast Guard on Channel 16, they will sometimes ask you to "**go to channel 22 Alpha.**" This is a channel assigned to U.S.A. and Canadian Coast Guards for handling distress and other calls. If your radio is set for **International** operation you will go to Channel 22 instead of 22**A**, and will not be able to communicate with the Coast Guard. To use Channel 22**A**, your radio must be set for **USA** or **Canada** operation, usually by a U/I/C (USA/International/Canada) control or combination of controls. Channel 22 (without an "A") is an **International** duplex channel for port operations. Some radios indicate an "A" adjacent to the alpha channels on the display; on others "alpha" is not indicated but the proper channel is selected based on the U/I/C setting.
3. Bridge-to-Bridge channels (for example, Channel 13) are for use by bridge operators on intercoastal waterways and rivers. It is also used by marine vessels in the vicinity of these bridges for navigation and for communicating with the bridge operators. Note that a limit of 1 Watt is specified for these channels. See page xx for additional information.
4. The **S/D** column on the chart indicates either S (simplex) or D (duplex). **Simplex** means transmitting and receiving on the same frequency. Only one party at a time can talk, unlike a telephone. Be sure to say "**over**" and release your microphone push-to-talk switch at the end of each transmission. **Duplex** operation involves the use of one frequency for transmitting and a separate frequency for receiving. On channels specified as duplex on the charts, correct mode of operation is established automatically by your radio when you select a channel; you cannot change the mode. And you still must release the push-to-talk switch after each transmission in order to listen to the radio.

5. Channels normally used by recreational boaters are those that include the term “non-commercial” in the **Channel Use** column of the chart. Some of these are shared with other users and some are used only in certain geographic regions.

6. Marine vessels equipped with VHF radios are required to monitor Channel 16.

| VHF MARINE CHANNEL CHART | | | | | | | |
|--------------------------|----------|----------|---|----------|----------------|---------|---|
| CH | U | C | I | S/D | TX | RX | CHANNEL USE |
| 01 | | X | X | D | 156.050 | 160.650 | Public Correspondence (Marine Operator) |
| 01A | X | | | S | 156.050 | | Port Operation and Commercial. VTS in selected areas |
| 02 | | X | X | D | 156.100 | 160.700 | Public Correspondence (Marine Operator) |
| 03 | | X | X | D | 156.150 | 160.750 | Public Correspondence (Marine Operator) |
| 03A | X | | | S | 156.150 | | US Government only, Coast Guard |
| 04 | | | X | D | 156.200 | 160.800 | Public Correspondence (Marine Operator), Port operation, ship movement |
| 04A | | X | | S | 156.200 | | Pacific coast: Coast Guard, East Coast: Commercial fishing |
| 05 | | | X | D | 156.250 | 160.850 | Public Correspondence (Marine Operator), Port operation, ship movement |
| 05A | X | X | | S | 156.250 | | Port operation. VTS in Seattle |
| 06 | X | X | X | S | 156.300 | | Inter-ship Safety |
| 07 | | | X | D | 156.350 | 160.950 | Public Correspondence (Marine Operator), Port operation, ship movement |
| 07A | X | X | | S | 156.350 | | Commercial |
| 08 | X | X | X | S | 156.400 | | Commercial (Inter-ship only) |
| 09 | X | X | X | S | 156.450 | | Boater Calling channel, Commercial & Non-commercial (Recreational) |
| 10 | X | X | X | S | 156.500 | | Commercial |
| 11 | X | X | X | S | 156.550 | | Commercial. VTS in selected areas. |
| 12 | X | X | X | S | 156.600 | | Port operation. VTS in selected areas. |
| 13 | X | X | X | S | 156.650 | | Inter-ship Navigation Safety (Bridge-to-bridge) |
| 14 | X | X | X | S | 156.700 | | Port operation. VTS in selected areas. |
| 15 | X | | | S | --- | 156.750 | Environmental (Receive only) |
| 15 | | X | X | S | 156.750 | | Commercial, non-commercial, ship movement (1 W) |
| 16 | X | X | X | S | 156.800 | | International Distress, Safety and Calling |
| 17 | X | X | X | S | 156.850 | | State Controlled (1 W) |
| 18 | | | X | D | 156.900 | 161.500 | Port operation, ship movement |
| 18A | X | X | | S | 156.900 | | Commercial |
| 19 | | | X | D | 156.950 | 161.550 | Port operation, ship movement |
| 19A | X | | | S | 156.950 | | US: Commercial |
| 19A | | X | | S | 156.950 | | Coast Guard |
| 20 | X | X | X | D | 157.000 | 161.600 | Canadian Coast Guard Only, International: port operations and shipment |
| 20A | X | | | S | 157.000 | | Port operation |
| 21 | | | X | D | 157.050 | 161.650 | Port operation, ship movement |
| 21A | X | X | | S | 157.050 | | U.S. Government Only, Canadian Coast Guard |
| 22 | | | X | D | 157.100 | 161.700 | Port operation, ship movement |
| 22A | X | X | | S | 157.100 | | US and Canadian Coast Guard Liaison and Maritime Safety Information Broadcasts announced on channel 16 |

| VHF MARINE CHANNEL CHART | | | | | | | |
|--------------------------|----------|----------|---|----------|----------------|---------|--|
| CH | U | C | I | S/D | TX | RX | CHANNEL USE |
| 23 | | X | X | D | 157.150 | 161.750 | Public Correspondence (Marine Operator) |
| 23A | X | | | S | 157.150 | | U.S. Government Only |
| 24 | X | X | X | D | 157.200 | 161.800 | Public Correspondence (Marine Operator) |
| 25 | X | X | X | D | 157.250 | 161.850 | Public Correspondence (Marine Operator) |
| 26 | X | X | X | D | 157.300 | 161.900 | Public Correspondence (Marine Operator) |
| 27 | X | X | X | D | 157.350 | 161.950 | Public Correspondence (Marine Operator) |
| 28 | X | X | X | D | 157.400 | 162.000 | Public Correspondence (Marine Operator) |
| 60 | | X | X | D | 156.025 | 160.625 | Public Correspondence (Marine Operator) |
| 61 | | | X | D | 156.075 | 160.675 | Public Correspondence (Marine Operator), Port operation, ship movement |
| 61A | X | X | | S | 156.075 | | U.S. Government Only, Canadian Coast Guard-Pacific Coast, Commercial Fishing-East Coast |
| 62 | | | X | D | 156.125 | 160.725 | Public Correspondence (Marine Operator), Port operation, ship movement |
| 62A | | X | | S | 156.125 | | Public Coast: Coast Guard; East Coast: commercial fishing only |
| 63 | | | X | D | 156.175 | 160.775 | Public Correspondence (Marine Operator), Port operation, ship movement |
| 63A | X | | | S | 156.175 | | Port Operation and Commercial. VTS in selected areas. |
| 64 | | X | X | D | 156.225 | 160.825 | Public Correspondence (Marine Operator), Port operation, ship movement |
| 64A | X | X | | S | 156.225 | | U.S. Government Only, Canadian Commercial Fishing |
| 65 | | | X | D | 156.275 | 160.875 | Public Correspondence (Marine Operator), Port operation, ship movement |
| 65A | X | X | | S | 156.275 | | Port Operations |
| 66 | | | X | D | 156.325 | 160.925 | Public Correspondence (Marine Operator), Port operation, ship movement |
| 66A | X | X | | S | 156.325 | | Port Operations |
| 67 | X | X | X | S | 156.375 | | US: Commercial. Used for Bridge-to-bridge communications in lower Mississippi River. Inter-ship only, Canada: Commercial fishing, S&R |
| 68 | X | X | X | S | 156.425 | | Non-commercial (Recreational) |
| 69 | X | X | X | S | 156.475 | | US: Non-commercial (Recreational), Canada: Commercial fishing only, International: Inter-ship, Port operations and Ship movement |
| 70 | X | X | X | S | 156.525 | | Digital selective calling (voice communications not allowed) |
| 71 | X | X | X | S | 156.575 | | US, Canada: Non-commercial (Recreational), International: Port operations and Ship movement |
| 72 | X | X | X | S | 156.625 | | Non-commercial (Inter-ship only) |
| 73 | X | X | X | S | 156.675 | | US: Port Operations, Canada: Commercial fishing only, International: Inter-ship, Port operations and Ship movement |
| 74 | X | X | X | S | 156.725 | | US: Port Operations, Canada: Commercial fishing only, International: Inter-ship, Port operations and Ship movement |
| 75 | X | | | S | 156.775 | | Port Operations (Inter-ship only) (1W) |
| 76 | X | | | S | 156.825 | | Port Operations (Inter-ship only) (1W) |
| 77 | X | X | | S | 156.875 | | Port Operations (Inter-ship only) (1W) |
| 77 | | | X | S | 156.875 | | Port Operations (Inter-ship only) |
| 78 | | | X | D | 156.925 | 161.525 | Public Correspondence (Marine Operator), Port operation, ship-movement |
| 78A | X | X | | S | 156.925 | | Non-commercial (Recreational) |

| VHF MARINE CHANNEL CHART | | | | | | | |
|--------------------------|----------|----------|---|----------|----------------|---------|--|
| CH | U | C | I | S/D | TX | RX | CHANNEL USE |
| 79 | | | X | D | 156.975 | 161.575 | Port operation and Ship movement |
| 79A | X | X | | S | 156.975 | | Commercial |
| 80 | | | X | D | 157.025 | 161.625 | Port operation, ship movement |
| 80A | X | X | | S | 157.025 | | Commercial |
| 81 | | | X | D | 157.075 | 161.675 | Port operation, ship movement |
| 81A | X | X | | S | 157.075 | | U.S. Government Only - Environmental protection operations. |
| 82 | | | X | D | 157.125 | 161.725 | Public Correspondence (Marine Operator), Port operation, ship movement |
| 82A | X | X | | S | 157.125 | | U.S. Government Only, Canadian Coast Guard Only |
| 83 | | X | X | D | 157.175 | 161.775 | Canadian Coast Guard Only |
| 83A | X | X | | S | 157.175 | | U.S. Government Only, Canadian Coast Guard Only |
| 83 | | X | X | D | 157.175 | 161.775 | Public Correspondence (Marine Operator) |
| 84 | X | X | X | D | 157.225 | 161.825 | Public Correspondence (Marine Operator) |
| 85 | X | X | X | D | 157.275 | 161.875 | Public Correspondence (Marine Operator) |
| 86 | X | X | X | D | 157.325 | 161.925 | Public Correspondence (Marine Operator) |
| 87 | X | X | X | D | 157.375 | 161.975 | Public Correspondence (Marine Operator) |
| 88 | X | X | X | D | 157.425 | 162.025 | Public Correspondence (ship-to-coast) |
| 88A | X | | | S | 157.425 | | Commercial, Inter-ship Only |
| WX01 | X | X | X | D | --- | 162.550 | Weather (receive only) |
| WX02 | X | X | X | D | --- | 162.400 | Weather (receive only) |
| WX03 | X | X | X | D | --- | 162.475 | Weather (receive only) |
| WX04 | X | X | X | D | --- | 162.425 | Weather (receive only) |
| WX05 | X | X | X | D | --- | 162.450 | Weather (receive only) |
| WX06 | X | X | X | D | --- | 162.500 | Weather (receive only) |
| WX07 | X | X | X | D | --- | 162.525 | Weather (receive only) |
| WX08 | X | X | X | D | --- | 161.650 | Weather (receive only) |
| WX09 | X | X | X | D | --- | 161.775 | Weather (receive only) |
| WX10 | X | X | X | D | --- | 163.275 | Weather (receive only) |

The above **BOLD** channels are not for use of the general public in U.S. waters, unless proper authorization is given.

11. WARRANTY

Marine Products Limited Warranty

STANDARD HORIZON (a division of VERTEX STANDARD) warrants, to the original purchaser only, each new Marine Communications Product ("Product") manufactured and/or supplied by STANDARD HORIZON against defects in materials and workmanship under normal use and service for a period of time from the date of purchase as follows:

Fixed Mount and Portable Transceivers

1 year - if purchased before 01/01/91

3 years - if purchased between 01/01/91 and 01/01/94

3 years Waterproof - if purchased after 01/01/94

Loud hailers

1 year - if purchased before 01/01/91

3 years - if purchased after 01/01/91

Associated Chargers

1 year - if purchased before 01/01/91

3 years - if purchased after 01/01/91

Associated Batteries - 18 months. Note: Batteries will be deemed defective only if storage capacity drops below 80% of rated capacity or if leakage develops.

Associated Accessories - 1 year. Includes: Microphones/Handsets, External Speakers, Antennas, Carrying Accessories, Power Supplies, and Signaling Boards.

To receive warranty service, the purchaser must deliver the Product, transportation and insurance prepaid, to STANDARD HORIZON (a division of VERTEX STANDARD), 115 North Wright Brothers Dr, Salt Lake City, Utah 84116-2838. Include proof of purchase indicating model, serial number, and date of purchase. STANDARD HORIZON will return the Product to the purchaser freight prepaid. Products purchased prior to January 1, 1991 will bear the STANDARD HORIZON warranty terms in effect prior to that date.

In the event of a defect, malfunction or failure of the Product during the warranty period, STANDARD HORIZON's liability for any breach of contract or any breach of express or implied warranties in connection with the sale of Products shall be limited solely to repair or replacement, at its option, of the Product or part(s) therein which, upon examination by STANDARD HORI-

ZON, appear to be defective or not up to factory specifications. STANDARD HORIZON may, at its option, repair or replace parts or subassemblies with new or reconditioned parts and subassemblies. Parts thus repaired or replaced are warranted for the balance of the original applicable warranty.

STANDARD HORIZON will not warrant installation, maintenance or service of the Products. In all instances, STANDARD HORIZON's liability for damages shall not exceed the purchase price of the defective Product.

This warranty only extends to Products sold within the 50 States of the United States of America and the District of Columbia.

STANDARD HORIZON will pay all labor to repair the product and replacement parts charges incurred in providing the warranty service except where purchaser abuse or other qualifying exceptions exist. The purchaser must pay any transportation expenses incurred in returning the Product to STANDARD HORIZON for service.

This limited warranty does not extend to any Product which has been subjected to misuse, neglect, accident, incorrect wiring by anyone other than STANDARD HORIZON, improper installation, or subjected to use in violation of instructions furnished by STANDARD HORIZON, nor does this warranty extend to Products on which the serial number has been removed, defaced, or changed. STANDARD HORIZON cannot be responsible in any way for ancillary equipment not furnished by STANDARD HORIZON which is attached to or used in connection with STANDARD HORIZON's Products, or for the operation of the Product with any ancillary equipment, and all such equipment is expressly excluded from this warranty. STANDARD HORIZON disclaims liability for range, coverage, or operation of the Product and ancillary equipment as a whole under this warranty. STANDARD HORIZON reserves the right to make changes or improvements in Products, during subsequent production, without incurring the obligation to install such changes or improvements on previously manufactured Products.

The implied warranties which the law imposes on the sale of this Product are expressly LIMITED, in duration, to the time period specified above. STANDARD HORIZON shall not be liable under any circumstances for consequential damages resulting from the use and operation of this Product, or from the breach of this LIMITED WARRANTY, any implied warranties, or any contract with STANDARD HORIZON. IN CONNECTION WITH THE SALE OF ITS PRODUCTS, STANDARD HORIZON MAKES NO WARRANT-

TIES, EXPRESS OR IMPLIED AS TO THE MERCHANTABILITY OR FITNESS FOR A PARTICULAR PURPOSE OR OTHERWISE, EXCEPT AS EXPRESSLY SET FORTH HEREIN.

Some states do not allow the exclusion or limitation of incidental or consequential damages, or limitation on how long an implied warranty lasts, so the above limitations or exclusions may not apply. This warranty gives specific legal rights, and there may be other rights which may vary from state to state.

ONLY PRODUCTS SOLD ON OR AFTER JANUARY 1, 1991 ARE COVERED UNDER THE TERMS OF THIS LIMITED WARRANTY.

ON-LINE WARRANTY REGISTRATION

THANK YOU for buying STANDARD HORIZON (a division of Vertex Standard) products! We are confident your new radio will serve your needs for many years!

Please visit www.standardhorizon.com to register the QUEST Marine VHF. It should be noted that visiting the Web site from time to time may be beneficial to you, as new products are released they will appear on the STANDARD HORIZON Web site. Also a statement regarding product support should be added to the manual.

Product Support Inquiries

If you have any questions or comments regarding the use of the QUEST, you can visit the STANDARD HORIZON Web site to send an E-Mail or contact the Product Support team at (714) 827-7600 or (800) 767-2450 M-F 7:00-5:00PST.

In addition to the warranty, STANDARD HORIZON includes a lifetime "flat rate" program to provide service after the warranty period has expired. If you wish to obtain the flat rate price for out-of-warranty repair, you must include the information on the Owner's Record with the unit when you return it to your Dealer or to STANDARD HORIZON.

Lifetime Flat Rate Service Program: For the original Owner only, for the lifetime of the unit, STANDARD HORIZON will repair the unit to original specifications.

Note: The flat rate amount is payable by the Owner only if STANDARD HORIZON or the STANDARD HORIZON Dealer determines that a repair is needed. After the repair, a 90-day warranty will be in effect from the date of return of the unit to the Owner.

This service program is not available for equipment which has failed as a result of neglect, accident, breakage, misuse, improper installation or modification, or water damage (depending on the product).

12 SPECIFICATIONS

Performance specifications are nominal, unless otherwise indicated, and are subject to change without notice.

12.1 GENERAL

| | |
|------------------------------|---|
| Channels | All USA, International and Canadian |
| Input Voltage | 13.8 VDC \pm 20% |
| Current Drain | |
| Standby | 0.5 A |
| Receive | 1.5 A |
| Transmit | 5.0 A (Hi); 1.5 A (Lo) |
| Dimensions | 2-1/2" H x 6-5/16" W x 6-5/16" D (64 H x 160 W x 160 D mm) |
| Flush-Mount Dimensions | 2" H x 5-5/16" W x 5-1/8" D (50 H x 136 W x 130 D mm) |
| Weight | 2.2 lbs (1 kg) |

12.2 TRANSMITTER

| | |
|--|---|
| Frequency Range | 156.025 to 157.425 MHz |
| RF Output | 25 W (Hi); 1 W (Lo) |
| Conducted Spurious Emissions | 80 dB (Hi); 60 dB (Lo) |
| Audio Response | within \pm 1/-3 of a 6 dB/octave pre-emphasis characteristic at 300 to 3000 Hz |
| Audio Distortion | 5 % |
| Modulation | 16K0G3E, for DSC 16K0G2B |
| Frequency Stability (-20°C to +50°C) | \pm 0.0005% |
| FM Hum and Noise | 50 dB |

12.3 RECEIVER

| | |
|--|--|
| Frequency Range | 156.050 to 163.275 MHz |
| Sensitivity | |
| 20 dB Quieting | 0.35 μ V |
| 12 dB SINAD | 0.25 μ V |
| Squelch Sensitivity (Threshold) | 0.13 μ V |
| Modulation Acceptance Bandwidth | \pm 7.5 kHz |
| Selectivity | |
| Spurious and Image Rejection | -70 dB |
| Intermodulation and Rejection at 12 dB SINAD | -70 dB |
| Audio Output | 4 W |
| Audio Response | within \pm 2/-8 of a 6 dB/octave de-emphasis characteristic at 300 to 3000 Hz |
| Frequency Stability (-20°C to +50°C) | \pm 0.0005 % |
| Channel Spacing | 25 kHz |
| DSC Format | RTCMSC101 |



**Marine Division of VERTEX STANDARD
US Headquarters**

10900 Walker Street, Cypress, CA 90630, U.S.A.

[WWW. standardhorizon.com](http://WWW.standardhorizon.com)



Copyright 2003
VERTEX STANDARD CO., LTD.
All rights reserved.

No portion of this manual
may be reproduced
without the permission of
VERTEX STANDARD CO., LTD.

0303?-0K