

YAESU MUSEN CO., LTD.  
FCC ID: K66GX2350S  
EXHIBIT #: 12

# HORIZON

Marine Electronics

**SPECTRUM GX2350S**  
25 Watt VHF/FM  
Marine Transceiver

## Owner's Manual

- Submersible
- One-Button DSC Distress Call Automatically  
Sends Latitude & Longitude and Vessel ID
- Noise Canceling "Clear Voice" Microphone
- Latitude & Longitude Shown On Display  
When Connected To GPS
- Programmable Scan & Priority Ch 16 Scan
- NOAA Weather Alert
- Backlit LCD & Keys

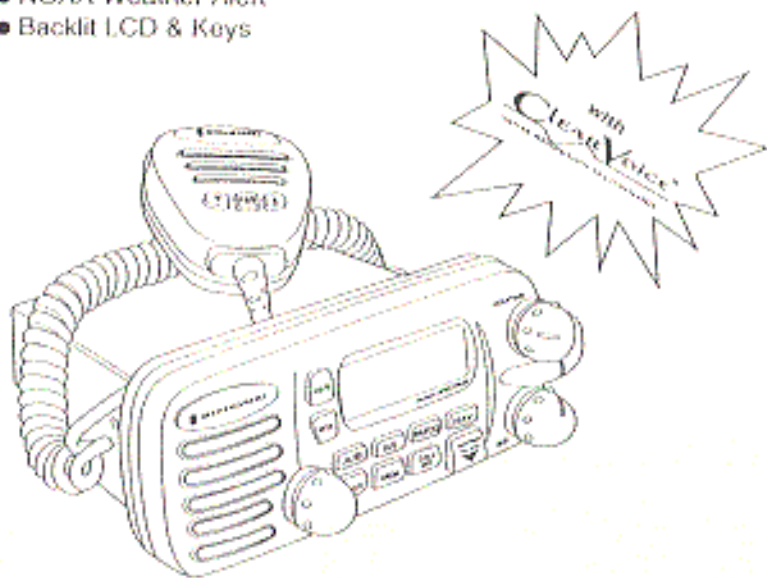

 **Standard**  
Communications

Standard Communication Corp.  
P.O. Box 92151  
Los Angeles, CA 90009-2151  
Telephone 310/532-5300  
© STANDARD COMMUNICATIONS CORP. 1999  
All Rights Reserved

Printed in Japan  
07/1999 MIT

438B851010

a division of  
 **Standard**  
Communications

## FCC NOTICE

### NOTICE

Unauthorized changes or modifications to this equipment may void compliance with FCC Rules. Any change or modification must be approved in writing by Standard Communications Corp.

### NOTICE

This equipment has been tested and found to comply with the limits for a Class B digital device, pursuant to Part 15 of the FCC Rules. These limits are designed to provide reasonable protection against harmful interference in a residential installation. This equipment generates, uses and can radiate radio frequency energy and, if not installed and used in accordance with the instructions, may cause harmful interference to radio communications. However, there is no guarantee that interference will not occur in a particular installation. If this equipment does cause harmful interference to radio or television reception, which can be determined by turning the equipment off and on, the user is encouraged to try to correct the interference by one or more of the following measures:

- Reorient or relocate the receiving antenna.
- Increase the separation between the equipment and receiver.
- Connect the equipment into an outlet on a circuit different from that to which the receiver is connected.
- Consult the dealer or an experienced radio/TV technician for help.

# TABLE OF CONTENTS

FCC NOTICE .....	1
<b>1 GENERAL INFORMATION .....</b>	<b>2</b>
INTRODUCTION .....	2
FCC/INDUSTRY CANADA INFORMATION .....	2
<b>2 ACCESSORIES .....</b>	<b>3</b>
PACKING LIST .....	3
OPTIONS .....	3
<b>3 CONTROLS AND INDICATORS .....</b>	<b>4</b>
CONTROLS AND CONNECTIONS .....	4
<b>4 INSTALLATION .....</b>	<b>9</b>
LOCATION .....	9
ELECTRICAL CONNECTIONS .....	9
ACCESSORY CABLE .....	10
Cable pin number and signal .....	10
CMB16 FLUSH MOUNT INSTALLATION .....	11
<b>5 BASIC OPERATION .....</b>	<b>12</b>
RECEPTION .....	12
TRANSMISSION .....	12
TRANSMIT TIME - OUT TIMER (TOT) .....	13
SIMPLEX/DUPLEX CHANNEL USE .....	13
USA, CANADA, AND INTERNATIONAL MODE .....	13
NOAA WEATHER CHANNELS .....	14
NOAA WEATHER ALERT .....	14
MEMORY SCANNING .....	15
CH16 PRIORITY SCANNING (PRI-SCAN) .....	15
CHANNEL A/B INSTANT CALL .....	16
Storing new channel A/B .....	16
Changing the stored channel A/B .....	16
Operating the channel A/B .....	16
PA/FOG OPERATION .....	16
Operating the PA HAIL mode .....	17
Operating the FOG HORN mode .....	17
NAVIGATION INDICATION .....	18
VOICE SCRAMBLER .....	18
Operation with voice scrambler .....	18
RESETTING THE TRANSCIEVER'S MICROPROCESSOR .....	19

<b>6 DIGITAL SELECTIVE CALLING .....</b>	<b>20</b>
GENERAL .....	20
Digital Selective Calling (DSC) .....	20
Marine Mobile Service Identity (MMSID) .....	20
SENDING A DISTRESS CALL .....	21
SENDING A DISTRESS CALL WITH NATURE OF DISTRESS .....	22
SENDING AN INDIVIDUAL CALL .....	23
SENDING AN ALL SHIP CALL .....	24
SC STANDBY .....	25
CALL WAITING DIRECTORY .....	25
Operation of Distress Call Waiting .....	26
Operation of Individual Call Waiting .....	26
POSITION REQUEST .....	27
RECEIVING DSC CALLS .....	28
Receiving a distress call .....	28
Receiving a distress relay call .....	29
Receiving an all ships call .....	29
Receiving a geographical area call .....	29
Receiving an individual call .....	29
Receiving a position request .....	30
<b>7. DSC / RADIO SETUP MODE .....</b>	<b>31</b>
SETUP .....	31
LAMP ADJUSTING .....	31
LCD CONTRAST .....	31
INDIVIDUAL DIRECTORY SETUP (DSC) .....	32
POSITION REQUEST REPLY TYPE .....	33
VOICE SCRAMBLER .....	34
KEY BEEP (ON OR OFF) .....	35
TIME OFFSET .....	36
USER MMSID INPUT .....	37
<b>8 RAM MIC OPERATION .....</b>	<b>38</b>
RAM MIC CONTROLS AND CONNECTIONS .....	38
INDICATORS .....	40
INTERCOM OPERATION .....	41
Communication .....	41
Calling .....	41
<b>9 MAINTENANCE .....</b>	<b>42</b>
REPLACEMENT PARTS .....	42
TROUBLESHOOTING CHART .....	43
<b>10 SPECIFICATIONS .....</b>	<b>44</b>
GENERAL .....	44
TRANSMITTER .....	44
RECEIVER .....	44

## 1 GENERAL INFORMATION

### 1.1 INTRODUCTION

The Standard Communications Corp. (SCC) GX2350S is a VHF/FM transceiver designed for use in the frequency range of 156.025 to 163.275 MHz. It requires 13.8V for operation and has a switchable RF output power of 1 watt or 25 watts.

The transceiver is capable of RTCMSC101 DSC (Digital Selective Calling) operation and intercom operation with the use of an optional CMP23 (remote-control speaker/microphone with display).

The transceiver operates on all currently-allocated marine channels which are switchable for use with either USA, International, or Canadian regulations. It has an emergency channel 16 which can be immediately selected from any channel by pressing the red 16/9 key. NOAA Weather channels can also be accessed immediately by pressing the WX key with channel selection.

Other features of the transceiver include: scanning, priority scanning, public address (PA) mode, submersible noise-canceling mic, high and low voltage warning, and GPS repeatability.

### 1.2 FCC/INDUSTRY CANADA INFORMATION

The following data pertaining to the transceiver is necessary to fill out the license application.

Type Acceptance ..... FCC Part 80  
Output Power ..... 1 Watt (low) and 25 Watts (high)  
Emission ..... 16K0F3E, 16K0G3E  
Frequency Range ..... 156.025 to 157.425 MHz  
FCC Type Number ..... K66GX2350S

Additional FCC and Industry Canada data, including licensing requirements, are contained in the companion document titled **OWNER'S MANUAL SUPPLEMENT**. The document also contains charts for VHF channel assignments, transceiver procedures, maintenance, factory service information, and warranty data.

## 2 ACCESSORIES

### 2.1 PACKING LIST

When the package containing the transceiver is first opened, please check it for the following contents:

- GX2350S SPECTRUM Transceiver (White/Black)
- CMP351W/CMP351B (White/Black Microphone attached to the transceiver) and hanger kit
- Mounting Bracket and attaching hardware
- Spare Fuse (6 A, 250 V)
- Owner's Manual
- Owner's Manual Supplement
- Quick-Reference Card
- Accessory Cable
- Power Cord

### 2.2 OPTIONS

CMB16 .....	Flush-Mount Bracket
CMP23 .....	Remote-Access Microphone (RAM Mic)
CAW23 .....	10-foot Extension Cable for RAM Mic
101S .....	Mini Extension Speaker
201S .....	Extension Speaker
201SZ .....	Flush Mount Extension Speaker
220SW .....	4.5" Round Hailer/ PA Horn
230SW .....	5" X 8" Hailer/PA Horn



## 3 CONTROLS AND INDICATORS

### NOTE

This section defines each control of the transceiver. See Figure 1 for location of controls. For detailed operating instructions refer to chapter 4 of this manual.

### 3.1 CONTROLS AND CONNECTIONS

#### ① POWER SWITCH/VOLUME CONTROL

Turns the transceiver on and off as well as adjusts the audio volume. To turn the transceiver on press and hold this knob until the LCD turns on. Turn it off, press and hold this knob until the LCD turns off. When the power is turned on, the transceiver is set to the last selected channel.

##### *Secondary Use*

When the transceiver is turned on while the **SCAN** and **WX** keys are held down, the internal microprocessor is reset. This clears the memory and all user-programmed settings, such as scan memory, priority scan assignments, and A/B channel assignments. This condition is known as the default condition, the same as when shipped from the factory. For a list of these defaults, see the section on Resetting the Transceiver's Microprocessor.

### NOTE

Resetting the microprocessor will not erase DSC MMSID and Directory Call Waiting information.

#### ② SQUELCH CONTROL (SQL)

Sets the point at which random noise on the channel does not activate the audio circuits but a received signal does. This point is called the squelch threshold. Further adjustment of the squelch control will degrade reception of wanted transmissions.

#### ③ KEY PAD

##### **16/9 Key**

Immediately recalls channel 16 from any channel location. Holding down this key recalls channel 9.

##### *Secondary use*

Please see secondary use for the **WX** and **MEM** key.

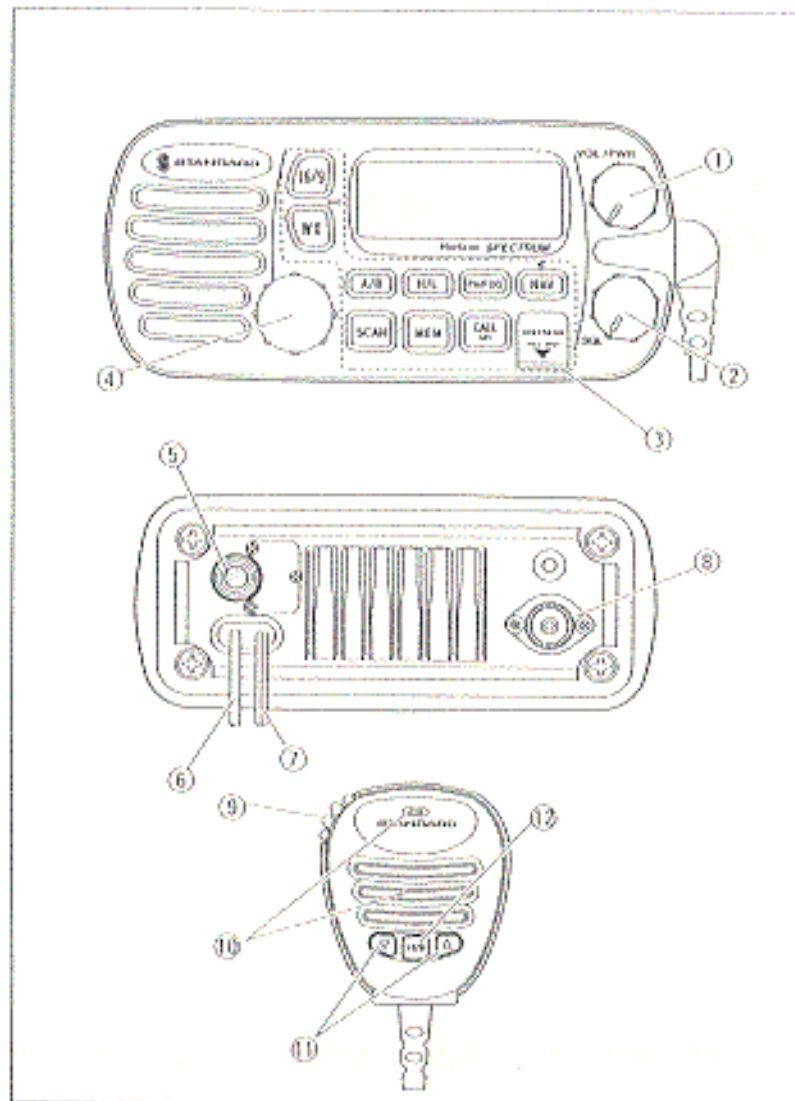

Figure 1. Controls and Connectors

### WX Key

Immediately recalls the previously selected NOAA weather channel from any channel location.

#### Secondary use

1. Holding down the 16/9 key while pressing the WX key changes the mode from USA to International or Canadian.
2. Holding down the WX and SCAN key while turning the power on resets the microprocessor and erases scan channels from memory. This clears the memory and establishes the factory-set defaults. For a list of these defaults, see the section on Resetting the Transceiver's Microprocessor.

### SCAN Key

1. Starts and stops scanning of programmed channels.
2. If held while the UP or DOWN key is pressed, the radio will show the channels in scan memory. This functions will not work if the unit is scanning.

#### NOTE

There is only one priority channel. However, it can be assigned a one of the channel other than WX and CH70. The priority channel is marked with PRI on the LCD.

### MEM Key

Memorizes the selected channel into the transceivers scan memory for scanning. When pressed again, DELETES the channel from the scan memory.

#### Secondary use

The MEM key is also used to select a priority channel.

1. Select the desired channel.
2. Press and hold the MEM key until the display shows PRIORITY.

### DISTRESS Key

To send the distress call see section 6.2, (Sending a Distress Call).

### PA/FOG key

Available to operate the PA function or the FOGHORN function

### A/B Key

Immediately recalls two user assigned channels from any channel.

### CALL/SET Key

The CALL/SET key functions as the enter key.

#### Secondary use

Press the CALL/SET key to access the DSC OPERATION menu. The following DSC functions can be accessed from the DSC OPERATION menu; INDIVIDUAL, ALL SHIPS, STANDBY, and CALL WAIT. Press and hold the CALL/SET key to access the SETUP menu. The following functions can be accessed in the SETUP menu; LAMP ADJUST, CONTRAST, INDIV DIR, KEY BEEP, TIME SET, USER MMSID.

### H/L Key

Toggles between high and low power. When the H/L key is pressed while the transceiver is on channel 13 or 67, the power will temporarily switch from LO to HI power until the PTT is pressed. The H/L key does not function on transmit inhibited and low power only channels.

### NAV / IC Key

1. Pressing this key, when connected navigation receiver equipment, a radio displays position data, Date, Time, Ground Speed and Heading from the navigation equipment.
2. Press and hold down this key, when the optional RAM Mic connected. Intercom operation will operate between radio and RAM Mic.

### ④ CHANNEL SELECTOR KNOB

Rotary knob used to select channels and, to select the item selection of many functions (DSC operation, PA/FOG operation and etc.). The CH key on the microphone can also be used to select them.

#### Secondary Use

While holding down the SCAN Key and rotating the rotary knob, you can confirm memory channels for scanning.

### ⑤ RAM MIC CONNECTOR

Connects the Remote Access Microphone (RAM MIC). Refer to \*section 8.0, (RAM MIC OPERATION).

### ⑥ ACCESSORY CONNECTION CABLE

Connects the radio to a GPS and an external speaker.

#### ⑦ DC INPUT CABLE

Connects the radio to a DC power supply of 13.8V

#### ⑧ ANTENNA JACK

Connects an antenna to the transceiver. Use a marine VHF antenna with an impedance of 50 ohms.

#### ⑨ PTT (Push-To-Talk) SWITCH

Keys the transmitter when the transceiver is in radio mode. If the transceiver is in the intercom operation mode, it activates the microphone for the intercom.

#### ⑩ CLEAR VOICE NOISE-CANCELING MIC/SPEAKER

Transmits the voice message with reduction of background noise.

#### ⑪ UP ▲ and DOWN ▼ KEYS

The UP ▲ and DOWN ▼ function the same as the UP and DOWN keys on the front panel of the transceiver.

#### ⑫ 16/9 Key

Pressing the 16/9 key immediately recalls channel 16 from any location. Press and hold the 16/9 key to recall channel 9.

## 4

## INSTALLATION

### 4.1 LOCATION

1. The radio can be mounted at any angle. Choose a mounting location that:
  - is far enough from any compass to avoid any deviation in compass reading due to the speaker magnet
  - provides accessibility to the front panel controls
  - allows connection to a power source and an antenna
  - has nearby space for installation of a microphone hanger
  - the antenna can be mounted at least 3 feet from radio

### 4.2 ELECTRICAL CONNECTIONS

#### CAUTION

Reverse polarity connections will damage the radio!

Connect the power cord and antenna to the radio. Antenna and Power Supply connections are as follows (see Figure 2):

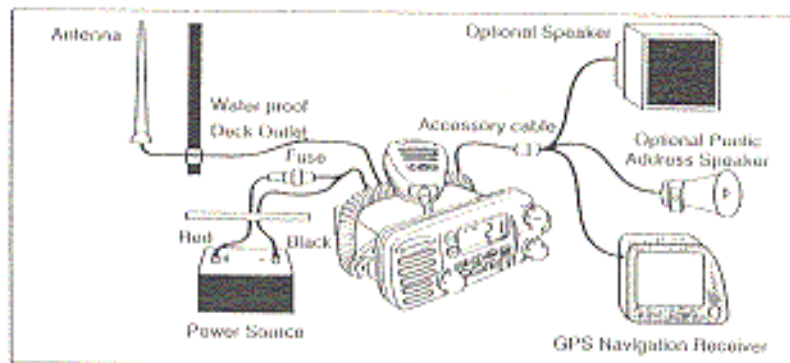

Figure 2. General Installation

1. Mount the antenna at least 3 feet away from the radio. At the rear of the radio, connect the antenna cable. It must have a PL259 connector. RG-6/U coaxial cable must be used if the antenna is 25 feet or more from the radio. RG58 cable can be used for distances less than 25 feet.

2. Connect the red power wire to a 13.8 VDC  $\pm$  20% power source. Connect the black power wire to a negative ground.
3. If an optional remote extension speaker is to be used, refer to section 4.3 for connections.
4. It is advisable to have a Certified Marine Technician check the power output and the standing wave ratio of the antenna after installation.

### 4.3 ACCESSORY CABLE

Cable pin number and signal



Pin number	Signal
1	External speaker (+)
2	External speaker (-)
3	PA (+)
4	NMEA IN (+)
5	PA (-)
6	NMEA IN (-)
7	NMEA OUT (+)
8	NMEA OUT (-)

When connecting the external speaker or GPS navigation receiver, strip off about 1 inch (2 cm) of the specified wire's insulation.

#### NOTE

Never short wires. This may lead to malfunctions.

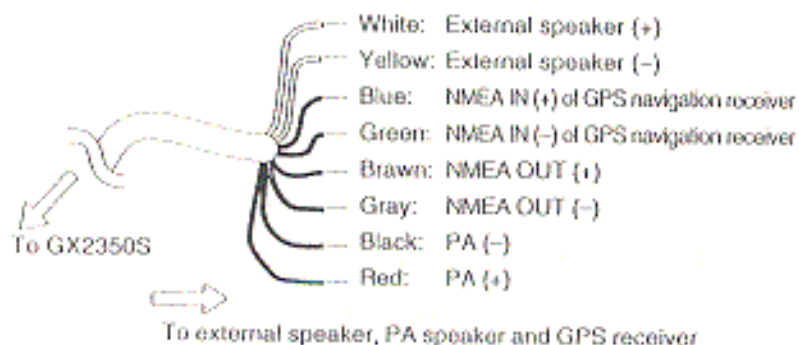

### 4.4 CMB16 FLUSH MOUNT INSTALLATION

1. Make a rectangular template for the flush mount measuring 2 1/8" H x 5 3/4" W.
2. Use the template to mark the location where the rectangular hole is to be cut. Confirm the space behind the dash or panel is deep enough to accommodate the transceiver (at least 6 inches deep). There should be at least 1/2 inch between the transceiver's heatsink and any wiring, cables or structures.
3. Cut out the rectangular hole and insert the transceiver.
4. Fasten the brackets to the sides of the transceiver with the lock washer nut combination, so that the mounting screw base faces the mounting surface (see Figure 3).
5. Turn the adjusting screw to adjust the tension so that the transceiver is tight against the mounting surface.

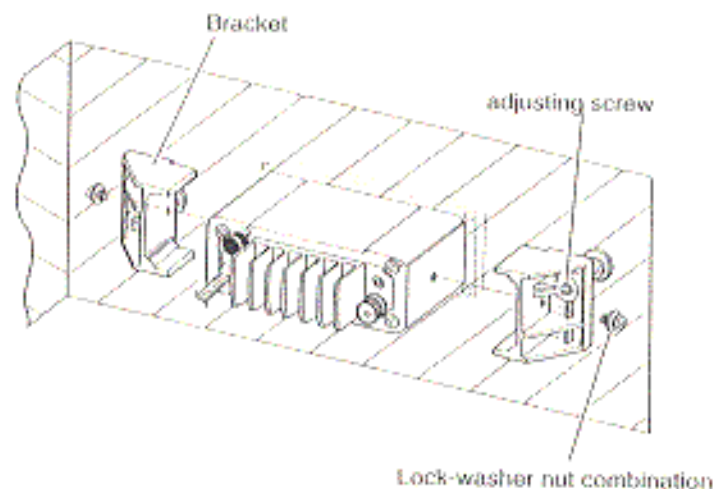

Figure 3. CMB16 Flush Mount Installation



### 5.1 RECEPTION

1. After the transceiver has been installed, ensure that the power supply and antenna are properly connected.
2. Press and hold the VOL/PWR knob until the radio turns on.
3. Turn the SQL knob fully counterclockwise. This state is known as "squelch off".
4. Turn up the volume until noise or audio from the speaker is at a comfortable level.
5. Turn the SQL knob clockwise until the random noise just disappears. This state is known as the "squelch threshold."
6. Turn the Channel Selector knob to select the desired channel. Refer to the channel chart in the OWNER'S MANUAL SUPPLEMENT for available channels.
7. When a message is received, adjust the volume to the desired listening level. The "BUSY" indicator in the LCD is displayed indicating that the channel is being used.

### 5.2 TRANSMISSION

1. Perform steps 1 through 6 of RECEPTION.
2. Before transmitting, monitor the channel and ensure it is clear. THIS IS AN FCC REQUIREMENT!
3. Press the PTT (push-to-talk) switch. The TX indicator on the LCD is displayed.
4. Speak slowly and clearly into the microphone.
5. When the transmission is finished, release the PTT switch.
6. Refer to the OWNER'S MANUAL SUPPLEMENT for standard transceiver operating procedures.

#### NOTE

This is a noise-canceling microphone. It should be positioned within 1 inch (2 cm) from the mouth for optimum performance.

### 5.3 TRANSMIT TIME - OUT TIMER (TOT)

When the PTT switch on the microphone is held down, transmit time is limited to 5 minutes. This prevents unintentional transmissions. About 10 seconds before automatic transmitter shutdown, a warning beep will be heard from the speaker(s). The transceiver will then automatically go to receive mode, even if the PTT switch is continually held down. Before transmitting again, the PTT switch must first be released and then pressed again.

### 5.4 SIMPLEX/DUPLEX CHANNEL USE

Refer to the OWNER'S MANUAL SUPPLEMENT for instructions on use of simplex and duplex channels.

#### NOTE

All channels are factory-programmed in accordance with FCC (USA), Industry Canada (Canada), and International regulations. Mode of operation cannot be altered from simplex to duplex or vice-versa.

### 5.5 USA, CANADA, AND INTERNATIONAL MODE

1. To change the modes, hold the 16/9 key and press the WX key. The mode changes from USA to International to Canadian with each press of the WX key.
2. USA will be displayed on the LCD for USA mode, INTL will be displayed for International mode, and CAN will be displayed for Canadian mode.
3. Refer to the OWNERS MANUAL SUPPLEMENT for allocated channels in each mode.

## 5.6 NOAA WEATHER CHANNELS

1. To receive a weather channel, press the **WX** key from any channel. The transceiver will go to the last selected weather channel.
2. Turn the **Channel Selector** knob on the microphone to select a different weather channel.
3. To exit from the weather channels, press the **WX** key. The transceiver returns to the channel it was on prior to a weather channel.

## 5.7 NOAA WEATHER ALERT

In the event of extreme weather disturbances, such as storms and hurricanes, the NOAA (National Oceanic and Atmospheric Administration) sends a weather alert accompanied by a 1050 Hz tone and subsequent weather report on one of the weather channels. The transceiver is capable of receiving this alert if the following is performed:

1. Program weather channels into the transceiver's memory for scanning. Follow the same procedure as for regular channels under Section 5.8.
2. Press the **SCAN** key once to start memory scanning or hold down the **SCAN** key during memory scanning to start priority scanning.
3. The programmed weather channels will be scanned along with the regular-programmed channels. However, scanning will not stop on a normal weather broadcast unless a NOAA alert is received.
4. When an alert is received on a weather channel, scanning will stop and the transceiver will emit a loud beep to alert the user of a NOAA broadcast.
5. Press the **WX** key to stop the alert tone and receive the weather report.

### NOTE

If the **WX** key is not pressed the alert tone will be omitted for 5 minutes and then the weather report will be received.

## 5.8 MEMORY SCANNING

### NOTE

- During scanning, the dot matrix area of the LCD will show **MEM-SCAN** or **PRI-SCAN** depending on the scan mode selected.
- The channel number shown is the last channel that a transmission was received on.

1. Adjust the **SQL** knob just until background noise disappears.
2. Select a desired channel to be scanned using the **UP** or **DOWN** key. Press the **MEM** key, **MEM** will appear in the LCD which to program the channel into the transceiver's memory.
3. Repeat step 2 for all the desired channels to be scanned.
4. To **DELETE** a channel from the transceiver's memory, press the **SCAN** key, **MEM** will disappear in the LCD while the memorized channel is displayed in the LCD.
5. To start scanning, press the **SCAN** key. Scanning will proceed from the lowest to the highest programmed channel number and will stop on a channel when a transmission is received.
6. The received channel number will be blinked during busy stop.

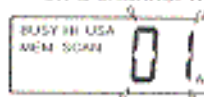

7. To stop scanning, press the **SCAN**, **16/9**, **WX**, or **PTT** key.

## 5.9 CH16 PRIORITY SCANNING (PRI-SCAN)

1. The any channel can be set as the priority channel other than weather channels and channel 70. To set the priority channel, select the desired channel. Press and hold down the **MEM** key until **PRI** is shown on the display.
2. To select priority scanning, hold down the **SCAN** key until **PRI-SCAN** will appear in the LCD during memory scanning. Scanning will proceed between the memorized channels and the priority channel. The priority channel will be scanned after each programmed channel.

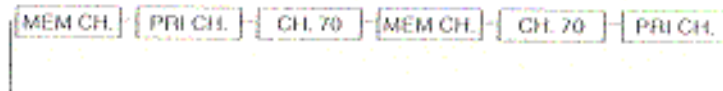
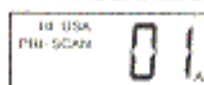



- The scanning will be performed while receiving the MEM CH (memorized channel).

- To stop scanning, press the **SCAN**, **16/9**, **WX**, or **PTT** key.

## 5.10 CHANNEL A/B INSTANT CALL

Two calling channels used by an organization or other favorite channel can be preset. But USA channels 9 and 16, and WX channels should not be assigned as A or B channels because they are readily available with the **16/9** and **WX** keys. If the **A/B** key is pressed and no channel A or B has been assigned, alert signal will be present twice.

### 5.10.1. Storing new channel A/B

- Press and hold down the **A/B** key and rotate the Channel Selector knob to select the desired channel.
- Release the **A/B** key to store a desired channel as channel A/B.

### 5.10.2 Changing the stored channel A/B

- Press the **A/B** key to appear memorized channel.
- Press and hold down the **A/B** key and rotate the Channel Selector knob to select the desired channel.
- Release the **A/B** key to store a desired channel as channel A/B.

#### NOTE

The stored channels will delete in microprocessor resetting mode only.

### 5.10.3 Operating the channel A/B

Pressing the **A/B** key more than once toggles between channel A, channel B and working channel.

## 5.11. PA/FOG OPERATION

### PA HAIL mode:

PA HAIL mode allows the transceiver's microphone to be used as a power hailer when an optional 4 ohm hail speaker is installed. The Hail mode has a listen-back feature which provides two way communication through the hail speaker.

### FOG HORN mode:

Automatic signaling is typically transmitted through the PA speaker.

### 5.11.1. Operating the PA HAIL mode

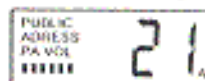

- Press the **PA/FOG** key. Toggles between the PA HAIL and FOG HORN mode by pressing the **PA/FOG** key.
- Press the **PTT** switch to speak through the hail speaker. Rotate the Channel Selector knob to control the AF output level. The AF output level can be set from 0 to 20 watts.
- To exit the PA HAIL mode, press any key other than **PTT** (**MEM**, **SCAN**, **H/L**, **UP**, **DOWN** keys and Channel Selector).

### 5.11.2. Operating the FOG HORN mode

Operator can select from FOG 1, FOG 2, FOG 3, FOG 4, AGROUND, SIREN, or HORN.

FOG 1: POWER BOAT UNDERWAY

FOG 2: POWER BOAT STOPPED

FOG 3: SAIL BOAT, FISH VESSEL, TOW VESSEL

FOG 4: VESSEL UNDER TOW

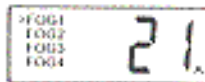

- Press the **PA/FOG** key on PA HAIL mode. Toggles between the PA HAIL and FOG HORN mode by pressing the **PA/FOG** key.

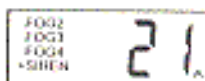

- Turn the Channel Selector knob to select the function.

- Press the **CALL/SET** key to operate the FOG HORN mode.

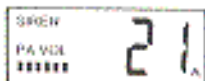

- On the SIREN and FOG HORN mode, press the **PTT** switch to speak through the PA speaker. Turn the Channel Selector knob to control the AF output level. The AF output level can be set from 0 to 20 watts.
- To exit the FOG HORN mode, press any key other than **PTT** (**MEM**, **SCAN**, **H/L**, **UP**, **DOWN** keys and Channel Selector).

## 5.12 NAVIGATION INDICATION

The transceiver has the ability to display the time and date as well as the vessel's position (LAT/LON), if connected to a GPS receiver.



1. Press the NAV key to display position information.

If the GPS receiver receives no signal, the display will be as shown in the illustration on the left.

2. To hide the position information, press the NAV key.

### NOTE

- The TIME OFFSET should be set to local time in the DSC/RADIO setup mode when the radio is connected the GPS navigation receiver. To adjust TIME OFFSET to your local time, refer to section 7.8 TIME OFFSET.

## 5.13 RESETTING THE TRANSCEIVER'S MICROPROCESSOR

Resetting the microprocessor restores the initial, factory supplied conditions in the transceiver. These are called the default conditions.

To reset the microprocessor, first turn the transceiver off. Then while pressing the WX and SCAN keys, turn the transceiver on. The default conditions are:

- No channels in SCAN memory.
- Channel 16 will be selected when the transceiver is turned on.
- WX channel 01 will be recalled when the WX key is pressed.

### NOTE

Resetting the microprocessor will not erase DSC MMSID and Directory Call Waiting information.



## 6.1 GENERAL

### 6.1.1 Digital Selective Calling (DSC)

Digital Selective Calling is a semi-automated method of establishing a radio call, it has been designated by the International Maritime Organization (IMO) as an international standard for establishing VHF, MF and HF radio calls. It had also been designated part of the Global Maritime Distress and Safety System (GMDSS). It is planned that DSC will eventually replace aural watches on distress frequencies and will be used to announce routine and urgent maritime safety information broadcasts.

This new service will allow mariners to instantly send a distress call with GPS position (when connected to the transceiver) to the USA Coast Guard and other vessel within range of the transmission. DSC will also allow mariners to initiate or receive distress, urgency, safety and routine calls to or from another vessel equipped with a DSC transceiver.

### 6.1.2 Marine Mobile Service Identity (MMSID)

#### What is an MMSID?

An MMSID is a nine digit number used on Marine Transceiver capable of using Digital Selective Calling (DSC). This number is used like a telephone number to selectively call other vessels. Refer to section 7.7 (USER MMSID INPUT).

#### How can I obtain a MMSID assignment?

Currently, the only way to obtain an MMSID is to apply for Ship Station License, or an amendment to a ship station license, regardless of whether the license is otherwise required. These procedures are currently under review by both the FCC and US Coast Guard.

#### WARNING

This radio is designed to generate a digital maritime distress and safety call to facilitate search and rescue. To be effective as a safety device, this equipment must be used only within communication range of a shore-based VHF marine channel 70 distress and safety watch system. The range of signal may vary but under normal conditions should be approximately 20 nautical miles.

## 6.2 SENDING A DISTRESS CALL

The distress call automatically includes the vessel's DSC MMSID and Lat/Lon position. Refer to section 7.7, USER MMSID INPUT. The vessel's position can be sent only if the transceiver is properly connected to an operating navigation receiver.



1. Remove the cover and press the **DISTRESS** key. The distress call menu will appear on the LCD.

Press and hold the **DISTRESS** key until the distress signal is sent (see step 2)

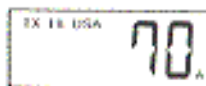

2. When the distress signal is sent, the dot-matrix area of the LCD will be as shown in the illustration on the left.

After the message has been sent, the Distress Alarm will be sounded.



3. The transceiver shadow-watches for a transmission between CH16 and CH170 until an acknowledgment signal is received. "DISTRESS" and "WAITING" will appear on the LCD.

4. If no acknowledgment is received, the distress call is repeated in 4 minute intervals until an acknowledgment is received.

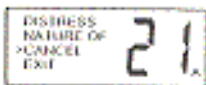

5. To cancel, turn the Channel Selector knob to select **CANCEL** after pressing the **DISTRESS** key. Then, press the **CALL/SET** key or turn off the radio.

6. When a distress acknowledgment is received, a distress alarm sounds and channel 16 is automatically selected.

7. To cancel the alarm, press any key.

#### NOTE

When a GPS receiver with NMEA output is connected, the vessel's position is automatically transmitted with the distress call.

## 6.3 SENDING A DISTRESS CALL WITH NATURE OF DISTRESS

The emergency mode may be used to send to a distress call. The distress call automatically includes the vessels DSC MMSID and Lat/Lon position. The vessels position will be sent only if transceiver is properly connected to an operating navigation receiver.



1. Remove the cover and press the DISTRESS key. The Emergency display will appear.

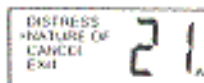

2. Turn the Channel Selector knob or press the UP or DOWN key on the microphone to select the distress with nature of distress. (NATURE OF)

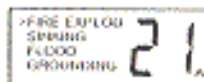

3. Press the CALL/SET key. The dot-matrix area of LCD will as shown in the illustration on the left.

4. Turn the Channel Selector knob or press the UP or DOWN key on microphone to select the item. To send DISTRESS CALL with NATURE OF DISTRESS and position if connect GPS receiver, press CALL/SET key.

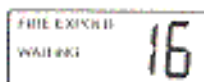

5. After message has been sent, the transceiver shadow watches between CH16 and CH70 until an acknowledgment is received. (Example: Fire Explosion is sent.)

6. If no acknowledgment is received, the distress call is repeated in 4 minute intervals until an acknowledgment is received. To cancel this, turn power OFF then ON again.

7. When a distress acknowledgment is received, emergency alarm sounds and channel 16 is automatically selected.

8. To cancel the alarm, press any key.

## 6.4 SENDING AN INDIVIDUAL CALL

To send an individual call, see section 7.4 INDIVIDUAL DIRECTORY SETUP. The individual call function allows you to transmit a DSC signal to a specific party only, prompting communication on a voice channel.

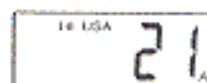

1. Select the traffic channel for voice communication.

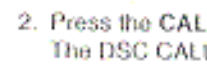

2. Press the CALL/SET key. The DSC CALLING menu will appear.

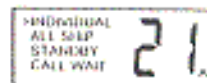

3. Turn the Channel Selector knob to select INDIVIDUAL. (To cancel, select EXIT with the Channel Selector knob or press the 16/9 key.)

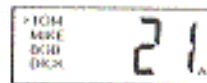

4. Press the CALL/SET key. The transceiver will beep, and the individual directory will appear.



5. Turn the Channel Selector knob to select the individual you want to contact.

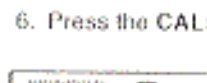

6. Press the CALL/SET key to transmit the individual DSC signal.

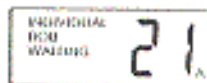

7. After INDIVIDUAL CALL is transmitted, the transceiver will wait 8 seconds for the acknowledgment. If the reply signal is not received, then the transceiver will transmit again.

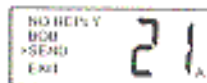

8. After the second INDIVIDUAL CALL is transmitted, if the reply signal is not received, the dot matrix area of the LCD will display ">SEND" to prompt the user to send the call again or exit the mode.

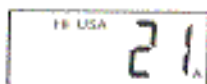

9. When an individual call acknowledgment "able to comply" is received, the established channel is automatically selected and an alarm sounds.

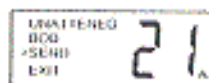

10. When an individual call acknowledgment with "unable to comply" is received, the established channel is automatically selected.

11. To cancel, select EXIT using the Channel Selector knob and press the CALL/SET key.

This procedure can be also canceled as follows;  
Press the CALL/SET key or 16/9 key.

## 6.5 SENDING AN ALL SHIP CALL

The All Ships Call function allows contact to be established with other vessel stations without having their ID in the individual calling directory. Also, priority for the call can be designated as Urgency, Safety or Routine.

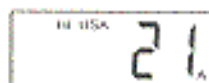

1. Select the traffic channel (for voice communication).

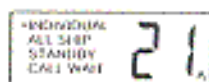

2. Press the CALL/SET key. The DSC CALLING menu will appear.

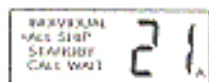

3. Turn the Channel Selector knob to select ALL SHIP.

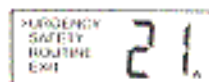

4. Press the CALL/SET key.  
To cancel this, Turn the Channel Selector knob to select EXIT.

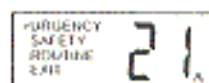

5. Turn the Channel Selector knob to select the nature of call (urgency, safety or routine).

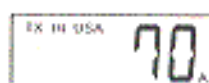

6. Press the CALL/SET key to transmit the all ships DSC signal.

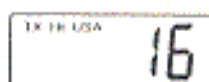

7. After the ALL SHIPS CALL is transmitted, the transceiver will wait on CH16.

## 6.6 DSC STANDBY

The DSC Standby function allows the transceiver to reply to DSC calls with the UNATTENDED message and log the calls for return at a more convenient time. When set to the DSC Standby mode, voice traffic may still be monitored on any selected channel.



1. Press the CALL/SET key.  
The DSC CALLING menu will appear.



2. Turn the Channel Selector knob to select the STANDBY mode.

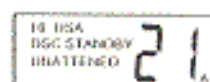

3. Press the CALL/SET key.

4. When an individual DSC call is received, the radio will respond with the UNATTENDED message when an operator cannot answer to the caller.

The DSC call will be logged into the radio's call waiting directory.

5. To cancel this, press the 16/9 key.

## 6.7 CALL WAITING DIRECTORY

The DSC Call Waiting directory logs 10 received distress calls, and logs 20 individual calls that are received and not answered within 5 minutes or while the radio is set on the DSC Standby function. Calls will be logged while busy with other communications as long as the transmitter is not keyed at the time of the call. If the call is answered within 5 minutes the call will not be logged. When a call is logged, a message will appear.

### NOTE

When a DISTRESS CALL is received, this call will be logged on the distress call waiting directory.



### 6.7.1 Operation of Distress Call Waiting

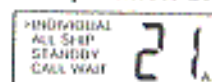

1. Press the CALL/SET key.  
The DSC CALLING menu will appear.

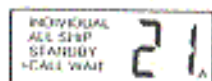

2. Turn the Channel Selector knob to select CALL WAIT.



3. Press the CALL/SET key.



4. Turn the Channel Selector knob to select the DISTRESS.

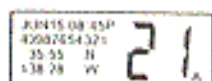

5. Press the CALL/SET key to display the log data which was received last.

6. Turn the Channel Selector knob to select another logged call
7. To exit from Distress Call Waiting, press the CALL/SET key and select EXIT. Then press the CALL/SET key again.

### 6.7.2 Operation of Individual Call Waiting

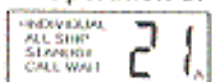

1. Press the CALL/SET key.  
The DSC CALLING menu will appear.



2. Turn the Channel Selector knob to select CALL WAIT.

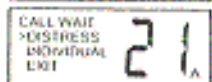

3. Press the CALL/SET key.



4. Turn the Channel Selector knob to select INDIVIDUAL.

5. Press the CALL/SET key to enter the individual log.



6. Turn the Channel Selector knob to select the name.

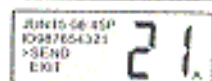

7. Press the CALL/SET key to display the logged call.

8. Press the CALL/SET key to resend the INDIVIDUAL CALL.
9. To exit from Individual Call Waiting, select EXIT and press the CALL/SET key.
10. Turn the Channel Selector knob to select another logged call or to select EXIT.
11. Press the CALL/SET key to access next logged call or EXIT.

### 6.8 POSITION REQUEST

The position request mode may be used to know other vessel position. The other vessel must have an operating navigation receiver connected to its DSC transceiver and must not have its transceiver set to deny position requests.



1. Select a traffic channel, then press the CALL/SET key. The transceiver will beep, then the DSC CALLING menu will appear in the display.

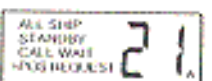

2. Rotate the Channel Selector knob or press the UP/DOWN keys to select the POS REQUEST.



3. Press CALL/SET key to appear the Position request directory. This directory uses the INDIVIDUAL Directory information.

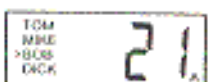

4. Rotate the Channel Selector knob or press the UP/DOWN keys to select a name.



5. Press the CALL/SET key to transmit the position request DSC signal.



6. After a DSC signal transmitted, the transceiver remains on channel 70 until a position data is received.

POS REQUEST  
000  
35 33 N  
139 20 W

21

7. The transceiver received position data from a vessel.

NO REPLY  
000  
>SEND  
EXIT

21

8. If the transceiver is not received a reply, the LCD will display ">SEND" to prompt the user to send the call again or exit the mode.

POS REQUEST  
000  
NO POSITION  
DATA

21

9. If the transceiver received no position data.

10. When the transceiver receives the requested position, the transceiver outputs a NMEA DSC sentence used by a GPS chart plotter to show the vessels position.

## 6.9 RECEIVING DSC CALLS

Several types of DSC transmissions can be received. The required action depends on the particular DSC type as outlined in the following examples.

### NOTE

When the radio receives on working channel or transmits on working channel, DSC calls will not be received.

### 6.9.1 Receiving a distress call

DISTRESS  
0306091111  
35 33 N  
139 20 W

16

1. A distress call is received. An emergency alarm sounds. Then channel 16 is automatically selected.

2. Press any key to stop the alarm.

DISTRESS  
0306091111  
NO POSITION  
DATA

16

3. If the received distress data does not include the position data, the LCD will show the display on the left.

### NOTE

You must continue monitoring channel 16 as a coast station may require assistance in any rescue attempt.

### 6.9.2 Receiving a distress relay call

DISTRESS RELY  
0306091111  
35 33 N  
139 20 W

16

1. A distress relay call is received. An emergency alarm sounds. Then channel 16 is automatically selected.

2. Press any key to stop the alarm.

### NOTE

You must continue monitoring channel 16 as a coast station may require assistance in any rescue attempt.

### 6.9.3 Receiving an all ships call

ALL SHIPS  
0306091111  
JAN15 07 00P

16

1. An all ships call is received. An emergency alarm sounds (different from DISTRESS). Then channel 16 is automatically selected.

2. Press any key to stop the alarm.

3. Monitor channel 16 or traffic channel until the URGENCY communication has completed.

### 6.9.4 Receiving a geographical area call

GEOGRAPHICAL  
0306091111  
JAN15 07 00P

18

1. A geographical call is received. An emergency alarm sounds (different from DISTRESS). Then the requested channel from the other ship is automatically selected.

2. Press any key to stop the alarm.

3. Monitor the traffic channel for an announcement from the calling ship.

### NOTE

This feature is only available when a GPS or LORAN receiver is connected.

### 6.9.5 Receiving an individual call

When receiving an individual call, an acknowledgment must be sent back to the calling station.

INDIVIDUAL  
000  
JAN15 04 00P

16

1. An individual call is received. A calling alarm sounds. Then the requested channel from the calling station is automatically selected.

2. Press any key to stop the alarm.
3. Monitor the selected channel for an announcement from the calling ship.

### 6.9.6. Receiving a position request

When a position request call is received from another vessel, a calling alarm will sound and POS REQUEST will show in the LCD. Operation and transceiver function differs depending on the SET UP mode setting.

#### Automatically reply:

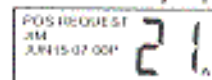

1. When a position request call is received, a calling alarm sounds 4 times. Then requested position coordinates are transmitted automatically.

2. To exit from appearing position request display, press any key.

#### Manually reply:

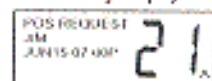

1. When a position request call is received, the LCD will be as shown in the illustration on the left.

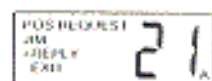

2. A calling alarm sounds 4 times. Then select type of reply function SEND REPLY or EXIT by using the Channel Selector knob.

3. When SEND REPLY is selected, then press CALL/SET key. After that, requested position coordinates are transmitted.
4. To exit from appearing position request display, press any key.

## 7.

## DSC / RADIO SETUP MODE

### 7.1 SETUP

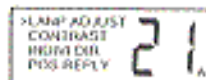

1. Press and hold down the CALL/SET key until the SETUP menu appears.
2. To select the items, Turn the Channel Selector knob.

#### NOTE

The RAM MIC CMP23 cannot change the SETUP menu. The SETUP menu is displayed in the LCD of the CMP23 as shown in the illustration on the right.



### 7.2 LAMP ADJUSTING

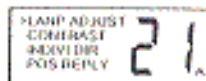

1. Select LAMP ADJUST in the SETUP menu with the Channel Selector knob.

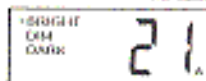

2. Press the CALL/SET key. The lamp adjusting menu will appear.

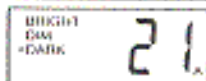

3. Press the Channel Selector knob to select the desired level. When DARK is selected, the lamp is extinguished. When BRIGHT is selected, the lamp is brightest.

4. Press the CALL/SET key to store the selected level. The LCD will return to the SETUP menu.

### 7.3 LCD CONTRAST



1. Select CONTRAST in the SETUP menu with the UP or DOWN key.

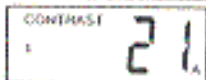

2. Press the CALL/SET key. The contrast setting menu will appear. The contrast level can be set from 1 to 7.

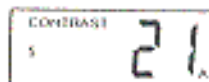

- Turn the Channel Selector knob to select the desired level (Example: 5 is selected)  
The contrast is stronger as the selected level increases.

- Press the CALL/SET key to store the selected level.  
The LCD will return to the SETUP menu.

## 7.4 INDIVIDUAL DIRECTORY SETUP (DSC)



- Press and hold the CALL/SET key until the SETUP menu is displayed.

- Select INDIVI DIR by using the Channel Selector knob.



- Press the CALL/SET key to enter the individual directory.

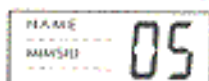

- Turn the Channel Selector knob to set the desired address number.  
The address number can be set from 01 to 30.



- Press the CALL/SET key to store the address number.

- Turn the Channel Selector knob to scroll through the alphabet.



- Press the CALL/SET key to enter the desired letter and move the cursor one space to the right. Repeat procedure until the name is complete. The name can consist of up to eleven characters, if you do not use all eleven characters, if you do not use all eleven character press the CALL/SET key to move to the next space. This method can be used to enter a blank space in the name.

- After the eleventh letter or space has been entered, press the CALL/SET key to advance to the MMSID (Maritime Mobile Service Identity Number) number entry.

- Turn the Channel Selector knob to scroll through the number, 0-9.  
To enter the desired number and move one space to the right press the CALL/SET key. Repeat procedure until all nine space of MMSID number are entered.



- After entering the MMSID number press and hold the CALL/SET key until the screen prompts you to select NEXT or EXIT.

- To enter another individual address select NEXT with the Channel Selector knob and press the CALL/SET key. Repeat steps 4 through 10.
- To exit the individual directory setup, select with the Channel Selector knob and press the CALL/SET key.

### NOTE

Selecting NEXT or EXIT will automatically save the name and MMSID number into memory.

## 7.5 POSITION REQUEST REPLY TYPE

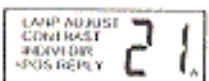

- Select POS REPLY in the SETUP menu with the Channel Selector knob.

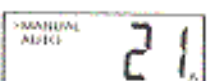

- Press the CALL/SET key.  
The position request reply type menu will appear.

- Turn the Channel Selector knob to select MANUAL or AUTO.
- Press the CALL/SET key to store a selected reply type.  
The LCD display will return to the SETUP menu.

## 7.6 KEY BEEP (ON OR OFF)

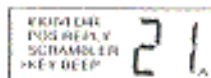

1. Select KEY BEEP in the SETUP menu with the Channel Selector knob.

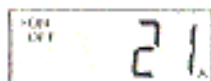

2. Press the CALL/SET key.  
The key beeps setting menu will appear.

3. Turn the Channel Selector knob to select ON or OFF.
4. Press the CALL/SET key to set the key beep condition.  
The LCD will return to the SETUP menu.

### NOTE

Emergency alarm and beeps for DSC operation cannot be turned OFF.



## 7.8 TIME OFFSET

Sets the time difference between local time and UTC. Time is displayed when position (LAT/LON) is displayed by pressing the NAV key.

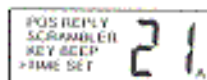

1. Select TIME SET in the SETUP menu with the Channel Selector knob.

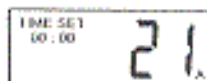

2. Press the CALL/SET key. The time offset menu appears.

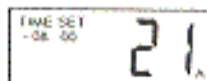

3. Turn the Channel Selector knob to select time offset from UTC. See Figure 4 to find your offset time from UTC. If 00:00 is assigned, the time is the same as UTC (Universal Time Coordinated) or GMT (Greenwich Mean Time)

4. Press the CALL/SET key to store the time offset. The LCD will return to the SETUP menu.



Figure 4. Offset time table

## 7.7 USER MMSID INPUT



1. Select the USER MMSID in the SETUP menu with the Channel Selector knob.



2. Press the CALL/SET key. The user MMSID menu will appear, and the first space will blink.



3. Turn the Channel Selector knob to set the number (0 to 9).



4. Press the CALL/SET key to store the set number. The blinking number is stored, and the next space will blink.

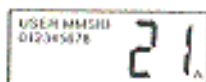

5. Repeat steps 3 and 4 to set your MMSID.

6. When the last number of your MMSID is in place, press and hold down the CALL/SET key to store your MMSID.

### NOTE

User MMSID can be input only twice. If the user tries to input MMSID more than twice, the radio will show the display on the right. If the user needs to change the MMSID more than twice, the transceiver will have to be sent to Factory Service. Refer to the Owner's Manual Supplement for address.

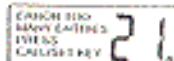

If the optional RAM Mic (CMP23) is connected to the remote microphone connector on the transceiver's rear panel, then the transceiver can use the remote control operation except for a few functions. The RAM Mic has a maximum range of 50 feet (15 m) with the use of two 10-foot extension cables (CAW23). The intercom operation can be used between the RAM Mic and the transceiver.

## 8.1 RAM MIC CONTROLS AND CONNECTIONS

### POWER SWITCH (PWR)

Turns the transceiver on and off.

Press and hold down the PWR key until the LCD turns on. To turn the transceiver off with the RAM Mic, press and hold the PWR key until the LCD turns off.

### SQUELCH KEY (SQL)

Activates the squelch adjusting mode.

Press this key to activate the squelch adjusting mode. Press the ▲ or ▼ key to adjust the squelch.

Sets the point at which random noise on the channel does not activate the audio circuits but a received signal does. This point is called the "squelch threshold". Further adjustment of the squelch control by pressing the ▲ key will degrade the reception of wanted transmissions.

When the ▼ key is pressed and held down for 1 second or more, the squelch is turned off.

### VOLUME KEY (VOL)

Activates the volume adjusting mode.

Press this key to activate the volume adjusting mode. Press the ▲ or ▼ key to adjust the volume.

### PTT (Push-To-Talk) SWITCH

Activates transmission.

### 16/9 KEY

Immediately recalls channel 16 from any channel location. Press and hold the 16/9 key to recall channel 9. Recalls the previous channel when the 16/9 key is pressed again. When holding down the 16/9 key while pressing the WX key, the mode toggles between USA, International and Canadian.

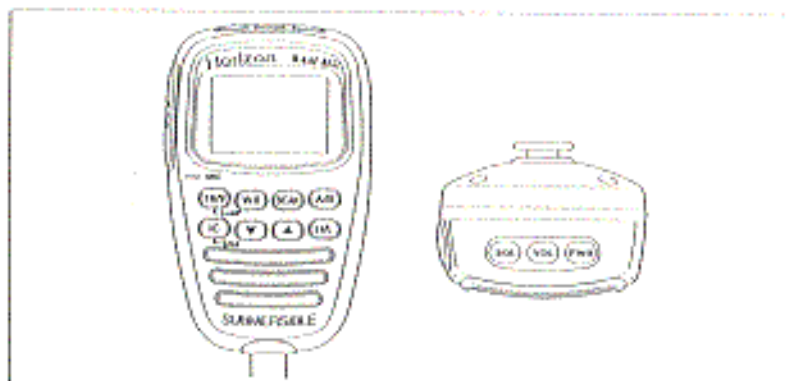

Figure 5. CMP23 RAM Mic

### A/B Key

Immediately recalls two user assigned channels from any channel.

### IC Key

Activates the intercom mode between the RAM Mic and the transceiver. Refer to section 8.3, INTERCOM OPERATION.

### WX Key

Immediately recalls a weather channel from any channel location. Recalls the previous channel when the WX key is pressed again.

### Secondary use

When holding down the 16/9 key while pressing the WX key, the mode toggles between USA, International and Canadian.

### SCAN Key

1. Starts and stops scanning of programmed channels.
2. If held while the UP or DOWN key is pressed, the radio will show the channels in scan memory. This function will not work if the unit is scanning.

### Secondary use

Press and hold the SCAN key to add the selected channel into the transceiver's scan memory for scanning. MEM will appear on the LCD to indicate that the channel has been entered into scan memory. To delete the channel from scan memory, press and hold the SCAN key until the MEM disappears from the LCD.

### NOTE

If the transceiver is in the MEM-SCAN mode, then the RAM Mic is in SC mode. If the transceiver is in PRI-SCAN mode, then the RAM Mic is in PS mode.

#### DOWN KEY (▼)

Selects the desired channel and adjusts the volume and squelch levels. Each press decreases the channel number, volume level and squelch level. When held down, the channels or levels decrease continuously.

#### UP KEY (▲)

Selects the desired channel and adjusts the volume and squelch levels. Each press increases the channel number, volume level, and squelch level. When held down, the channels or levels increase continuously.

#### Secondary use

When holding down the 16/9 key while pressing the UP ▲ key, changes the brightness (3 levels) of the LCD back light.

#### H/L KEY

Toggles between high and low power. When the H/L key is pressed while the transceiver is on Canadian channel 13, USA channel 13 or 67, the power will temporarily switch from LO to HI power until the PTT switch is pressed. The H/L key does not function on transmit-inhibited and low power-only channels.

## 8.2 INDICATORS



#### Channel Display

Displays the operating channel in both transmission and reception mode.

#### A Indicator

A simplex channel in USA or Canadian mode whose counterpart in the International mode is a duplex channel.

#### TX/ BUSY Indicator

"TX" is displayed in transmitting mode. "BUSY" is displayed in receiving mode.

#### USA/ INTL/ CAN Indicator

The mode of operation. "USA" indicates USA mode. "INTL" indicates International mode and "CAN" indicates Canadian mode.

#### WX Indicator

A weather channel.

#### MEM Indicator

The channel is in the transceiver's scan memory.

#### H/L Indicator

"H" is high power. "L" is low power. Blank is a reception only channel.

#### SQL/VOL Indicator

"SQL" is squelch adjusting mode. "VOL" is volume adjusting mode.

## 8.3 INTERCOM OPERATION

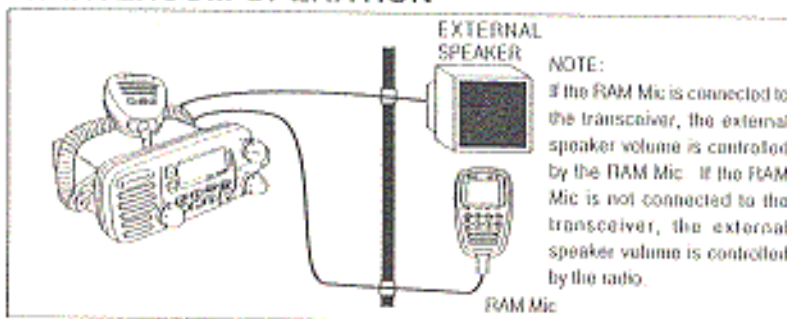

Figure 6. Intercom operation

### 8.3.1 Communication

1. Press the IC key in the radio mode. The mode is changed to the INTERCOM mode. If the IC key is pressed again the mode will revert to radio mode.
2. "IC" is displayed on both the transceiver and the RAM Mic when the intercom operation is activated.
3. Press the PTT switch. The "TX" indicator is displayed.

#### NOTE

A warning beep is emitted when the RAM Mic PTT switch is pressed while the transceiver microphone's PTT switch is pressed.

4. Speak slowly and clearly into the microphone, hold the microphone about 1/2 inch away from your mouth.
5. When finished, release the PTT switch.

### 8.3.2 Calling

1. Hold down the IC key in the intercom operation for 1 second or more. A calling beep is emitted twice from the transceiver speaker.



The inherent quality of the solid-state components used in this transceiver will provide many years of continuous use. Taking the following precautions will prevent damage to the transceiver.

\* Never key the microphone unless an antenna or suitable dummy load is connected to the transceiver.

\* Ensure that the supply voltage to the transceiver does not exceed 16 VDC or fall below 11 VDC.

In the unlikely event of serious problems, please contact your SCC Dealer or our repair facility. Address and phone numbers for this facility, as well as warranty information, are contained in your Owner's Manual Supplement.

## 9.1 REPLACEMENT PARTS

Occasionally an owner needs a replacement mounting bracket or knob. These can be ordered from our Parts Department by writing or calling:

Standard Communications Corp. Parts Department  
P.O. Box 92151  
Los Angeles, CA 90009-2151  
Telephone 800-366-8431

Commonly requested parts, and their part numbers are listed below.

Microphone, White (CMP351W) .....	MP51000400
Microphone, Black (CMP351B) .....	MP51000410
RAM Microphone Connector Cover .....	389B053010
Standard Mounting Bracket, White .....	444X160030
Standard Mounting Bracket, Black .....	444X160130
Standard Mounting Bracket Knob, White .....	444X154030
Standard Mounting Bracket Knob, Black .....	444X154130
Volume Control Knob .....	443X154500
Squelch Control Knob .....	443X154500
Channel Selector Knob .....	443X154510
Accessory Cable .....	ZD00700020
Distress Key Cover .....	444X053010
Power Cord .....	ZC01300010
Mic Hanger, White .....	277X155020
Mic Hanger, Black .....	277X155120

## 9.2 TROUBLESHOOTING CHART

TROUBLESHOOTING CHART		
SYMPTOM	PROBABLE CAUSE	REMEDY
Transceiver fails to power up.	No DC voltage to the transceiver, or blown fuse.	Press and hold the Power switch. Volume control knob until the transceiver turns on. Check the power cable for DC voltage, or replace the fuse (8A 250V).
Transceiver blows fuse when connected to power supply.	Reversed power wires.	Make sure the red wire is connected to the positive battery post and the black wire is connected to the negative. If the fuse still blows, contact your SCC Dealer.
Popping or whining noise from the speaker while engine runs.	Engine noise.	Reroute the DC power cables away from the engine. Add noise suppressor on power cable. Change to resistive spark plug wires and/or add an alternator whine filter.
Sound is not emitted from the external speaker.	External cable.	Check the polarity of the connected external cable.
Receiving stations report low transmit power, even with transceiver set to full power.	Antenna.	Have the antenna checked or test the transceiver with another antenna. If the problem persists, contact your SCC Dealer for servicing.
"THE BATTERY" or "LOW BATTERY" is blinking when the power is turned on.	The power supply voltage is too high or too low.	Confirm that the connected power supply voltage is not 24 volts or lower than 9 volts. Confirm that the generator has not malfunctioned.
Your position is not displayed.	External cable.	Check the polarity of the connected external cable.
	Setting of the GPS navigation receiver.	Check the output signal format of the GPS navigation receiver. This radio requires NMEA0183 format with GLL sentence as an output signal.



Performance specifications are nominal, unless otherwise indicated, and are subject to change without notice.

### 10.1 GENERAL

Channels .....	All USA, International and Canadian
Input Voltage .....	13.0 VDC $\pm$ 20%
Current Drain	
Standby .....	0.5A
Receive .....	1.5A
Transmit .....	6A (H); 1.7A (L)
Dimensions .....	3-1/8" H x 6-7/8" W x 7-1/4" D (80 H x 176 W x 185 D mm)
Flush Mount Dimensions .....	2" H x 5-5/8" W x 5-1/4" D (51 H x 143 W x 133 D mm)
Weight .....	2.73 lb. (1.24 kg)

### 10.2 TRANSMITTER

Frequency Range .....	156.025 to 157.425 MHz
RF Output .....	25 W (H); 1 W (L)
Conducted Spurious Emissions .....	80 dB (H); 60 dB (L)
Audio Response .....	within $\pm$ 1/3 of a 6 dB/octave pre-emphasis characteristic at 300 to 3000 Hz
Audio Distortion .....	5 %
Modulation .....	16K0F3E, for DSC 16K0G3E
Frequency Stability (-20° to +50°C) .....	$\pm$ 0.0005 %
FM Hum and Noise .....	50 dB

### 10.3 RECEIVER

Frequency Range .....	156.050 to 163.275 MHz
Sensitivity	
20 dB Quietng .....	0.40 $\mu$ V
12 dB SINAD .....	0.35 $\mu$ V
Speech Sensitivity (Threshold) .....	0.13 $\mu$ V
Modulation Acceptance Bandwidth .....	1.75 kHz
Selectivity	
Spurious and Image Rejection .....	- 70 dB
Intermodulation and Rejection at 12 dB SINAD .....	- 70 dB
Audio Output .....	4 W
Audio Response .....	within $\pm$ 2/-8 of a 6 dB/octave de-emphasis characteristic at 300 to 3000 Hz
Frequency Stability (-20° to +50°C) .....	$\pm$ 0.0005 %
Channel Spacing .....	25 kHz
DSC Format .....	RTCMSC101