

VX-160/-180 Operating Manual

Controls & Connectors

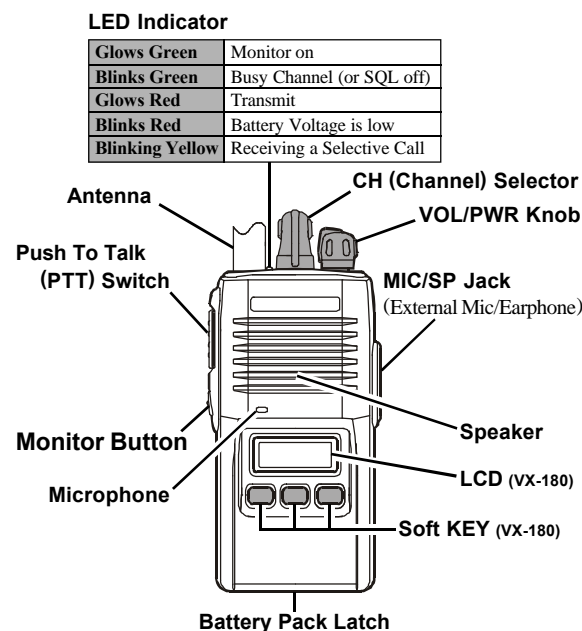

0103?-0?



IMPORTANT NOTICE!

FCC RF Exposure Compliance Requirements for Occupational Use Only:

This Radio has been tested and complies with the Federal Communications Commission (FCC) RF exposure limits for Occupational Use/Controlled exposure environment. In addition, it complies with the following Standards and Guidelines:

- FCC 96-326, Guidelines for Evaluating the Environmental Effects of Radio-Frequency Radiation.
- FCC OET Bulletin 65 Edition 97-01 (1997) Supplement C, Evaluating Compliance with FCC Guidelines for Human Exposure to Radio Frequency Electromagnetic Fields.
- ANSI/IEEE C95.1-1992, IEEE Standard for Safety Levels with Respect to Human Exposure to Radio Frequency Electromagnetic Fields, 3 kHz to 300 GHz.
- ANSI/IEEE C95.3-1992, IEEE Recommended Practice for the Measurement of Potentially Hazardous Electromagnetic Fields - RF and Microwave.

- **This radio is NOT approved for use by the general population in an uncontrolled environment. This radio is restricted to occupational use, work related operations only where the radio operator must have the knowledge to control its RF exposure conditions.**
- **When transmitting, hold the radio in a vertical position with its microphone 1 to 2 inches (2.5 to 5 cm) away from your mouth and keep the antenna at least 1 inch (2.5 cm) away from your head and body.**
- **The radio must be used with a maximum operating duty cycle not exceeding 50%, in typical Push-to-Talk configurations.**
DO NOT transmit for more than 50% of total radio use time (50% duty cycle). Transmitting more than 50% of the time can cause FCC RF exposure compliance requirements to be exceeded.
The radio is transmitting when the red LED on the top of the radio is illuminated. You can cause the radio to transmit by pressing the P-T-T button.
- **DO NOT transmit when the radio is used in Body Worn configuration with the following accessory: belt-clip (Parts # CP7064001). It must be used ONLY for (1) there is a 4 cm distance from the body during transmitting, (2) monitoring purposes, using the speaker only and (3) for carrying purposes.**
- Always use Vertex Standard authorized accessories.

Before You Begin

Battery Pack Installation and Removal

- To install the battery, hold the transceiver with your left hand, so your palm is over the speaker and your thumb is on the top of the belt clip. Insert the battery pack into the battery compartment on the back of the radio while tilting the Belt Clip outward, then close the Battery Pack Latch until it locks in place with a "Click."

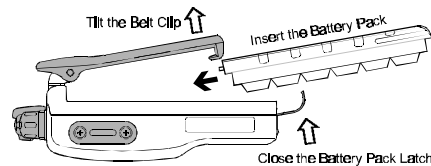

- To remove the battery, turn the radio off and remove any protective cases. Open the Battery Pack latch on the bottom of the radio, then slide the battery downward and out from the radio while holding the Belt Clip.

Caution!

Do not attempt to open any of the rechargeable Ni-Cd packs, as they could explode if accidentally short-circuited.

VERTEX STANDARD CO., LTD.
4-8-8 Nakameguro, Meguro-Ku, Tokyo 153-8644, Japan
VERTEX STANDARD
US Headquarters
17210 Edwards Rd., Cerritos, CA 90703, U.S.A.

Low Battery Indication

- As the battery discharges during use, the voltage gradually becomes lower. When the battery voltage reaches 6.3 volts, substitute a freshly charged battery and recharge the depleted pack. The **TX/BUSY** indicator on the top of the radio will blink **red** when the battery voltage is low.
- Avoid recharging Ni-Cd batteries often with little use between charges, as this can degrade the charge capacity. We recommend that you carry an extra, fully-charged pack with you so the operational battery may be used until depletion (this "deep cycling" technique promotes better long-term battery capacity).

Operation

Preliminary Steps

- Install a charged battery pack onto the transceiver, as described previously.
- Screw the supplied antenna onto the Antenna jack. Never attempt to operate this transceiver without an antenna connected.
- If you have a Speaker/Microphone, we recommend that it not be connected until you are familiar with the basic operation of the **VX-160/-180**.

Operation Quick Start

- To turn the top panel's **VOL/PWR** knob clockwise to turn on the radio on.

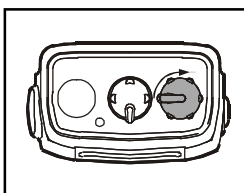

- Turn the top panel's **CH** selector knob to choose the desired operating channel.

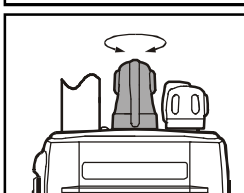

- Rotate the **VOL/PWR** knob to set the volume level. If no signal is present, press and hold the **MONITOR** key (the lower button on the left side) more than 2 seconds; background noise will now be heard, and you may use this to set the **VOL/PWR** knob for the desired audio level.

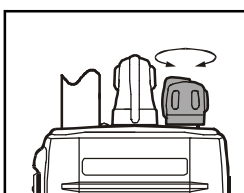

- Press and hold the **MONITOR** key more than 2 seconds (or press the **MONITOR** key twice) to quiet the noise and resume normal (quiet) monitoring.

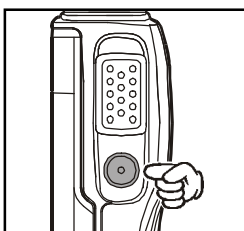

This device complies with Part 15 of the FCC rules. Operation is subject to the condition that this device does not cause harmful interference.

- To transmit, press and hold the **PTT** switch. Speak into the microphone area of the front panel grille (lower left-hand corner) in a normal voice level. To return to the Receive mode, release the **PTT** switch.

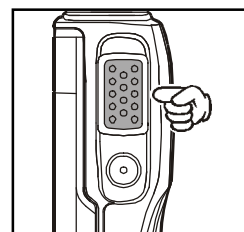

- If a Speaker/Microphone is available, remove the plastic cap and its two mounting screws from the right side of the transceiver, then insert the plug from the Speaker/Microphone into the **MIC/SP** jack; secure the plug using the screws supplied with the Speaker/Microphone. Hold the speaker grille up next to your ear while receiving. To transmit, press the PTT switch on the Speaker/Microphone, just as you would on the main transceiver's body.

Note: Save the original plastic cap and its mounting screws. They should be re-installed when not using the Speaker/Microphone.

Key Functions (VX-180 only)

The **VX-180** have the **[A]**, **[B]**, and **[C]** function keys and **MONITOR** key. These **Soft** keys functions can be customized, via programming by your **VERTEX STANDARD** dealer, to meet your communications/network requirements. Some features may require the purchase and installation of optional internal accessories. The possible **Soft** key programming features are illustrated below, and their functions are explained next chapter. For further details, contact your **VERTEX STANDARD** dealer. For future reference, check the box next to each function that has been assigned to the **Soft** key on your particular radio, and keep it handy.

Function	Soft Key			
	[A]	[B]	[C]	MONITOR
Monitor				
Scan				
Dual Watch				
Talk Around				
TX Save Off				
Follow-me Dual Watch				
Channel Up				
Channel Down				
Call/Reset				
Lamp				
Speed Dial				
Low Power				
Lock				
Add/Del				
None				

Description of Operating Functions

Monitor

Press the assigned Soft key momentarily to disable the Tone squelch. Press and hold the assigned Soft key more than 2 seconds to disable the Noise and Tone squelch. Repeatedly press and hold the assigned Soft key more than 2 seconds (or press the assigned Soft key twice) to resume the Noise and Tone squelch.

Scan

The Scanning feature is used to monitor multiple channels programmed into the transceiver. While scanning, the transceiver will check each channel for the presence of a signal, and will stop on a channel if a signal is present.

- To activate scanning:
Press the assigned Soft key.
The scanner will search the channels, looking for active ones; it will pause each time it finds a channel on which someone is speaking.
- To stop scanning:
Press the assigned Soft key.
Operation will revert to the channel to which the CH knob is set.

Dual Watch

The Dual Watch feature is similar to the Scan feature, except that only two channels are monitored: The current operating channel; and the "Priority" channel.

- To activate Dual Watch:
Press the assigned Soft key.
The scanner will search the two channels; it will pause each time it finds a channel on which someone is speaking.
- To stop Dual Watch:
Press the assigned Soft key.
Operation will revert to the channel to which the CH knob is set.

Talk Around

Press the assigned Soft to activate the Talk Around feature when you are operating on duplex channel systems (separate receive and transmit frequencies, utilizing a "repeater" station). The Talk Around feature allows you to bypass the repeater station and talk directly to a station that is nearby. This feature has no effect when you are operating on "Simplex" channels, where the receive and transmit frequencies are already the same.

Note that your dealer may have made provision for "Talk Around" channels by programming "repeater" and "Talk Around" frequencies on two adjacent channels. If so, the key may be used for one of the other Pre-Programmed Functions.

TX Save Off

Press the assigned Soft key to disable the Transmit Battery Saver, if you are operating in a location where high power is almost always needed.

The Transmit Battery Saver helps extend battery life by reducing transmit power when a very strong signal from an apparently nearby station is being received. Under some circumstances, though, your hand-held radio may not be heard well at the other end of the communication path, and high power may be necessary at all times.

Follow-Me Dual Watch

To set up a "Dual Watch" frequency pair using the "Follow-Me" feature, select a channel using the CH selector knob. Now press the assigned Soft key; pressing the assigned Soft key locks the current channel as the User-assigned Priority Channel. Now rotate the CH selector knob to another channel (not the "Scanning Start" channel). Your radio will now switch back-and-forth between the currently-selected channel (shown on the CH selector knob) and the User-assigned Priority Channel. During "Follow-Me" scanning (after you have pressed

the key), you can set up the "Dual Watch" feature by rotating the CH selector knob to another channel. The radio will then scan back and forth between the original User-assigned Priority Channel and the newly-selected channel.

The Priority Channel you have assigned (before pressing the key) will be retained in memory until you change it.

Channel Up

Press the assigned Soft key to increase operating channel.

Channel Down

Press the assigned Soft key to decrease operating channel.

Call/Reset

When the 2-tone selective calling unit is installed, press the assigned Soft key to silence the receiver and reset for another call, when a communication is finished.

Lamp

Press the assigned Soft key to illuminate the LCD for five second.

Speed Dial

Your Dealer may have pre-programmed Auto-Dial telephone number memories into your radio.

To dial a number, just press the Dealer-assigned Soft key for Speed Dialing. The DTMF tones sent during the dialing sequence will be heard in the speaker.

Low Power

Press the assigned Soft key to set the radio's transmitter to the "Low Power" mode, thus extending battery life. Press the assigned Soft key again to return to "High Power" operation when in difficult terrain.

Lock

Press the assigned Soft key to lock the Soft key, CH knob, and PTT switch (except Lock key); this can be enabled to prevent radio settings from being disturbed.

Add/Del

Add/Del feature can be arranged Scan list by the User. Press the assigned Soft key to delete/restore the current channel to/from your scanning list.

When you delete a current channel, "-SKIP-" will appear on the LCD for one second after pressing the Soft key. When you restore a current channel, "-STOP-" will appear on the LCD for one second after pressing the Soft key.

Accessories & Options

FNB-64	7.2 V 700 mAh Ni-Cd Battery
FNB-V57	7.2 V 1100 mAh Ni-Cd Battery
FBA-25	Alkaline Battery Case
NC-77B	120 VAC Overnight Desktop Charger
NC-77C	230-240 VAC Overnight Desktop Charger
NC-77U	230 VAC Overnight Desktop Charger
VAC-800	Rapid Charger
MH-45^{B4B}	Speaker/Microphone
MH-37^{A4B}	Earpiece Microphone
VC-25	VOX Headset
CT-42	PC Programming Cable
CT-27	Radio to Radio Programming Cable
CE44	Programming Software