

**YAESU**

# FT-8500

Dual Band FM  
Paging Transceiver

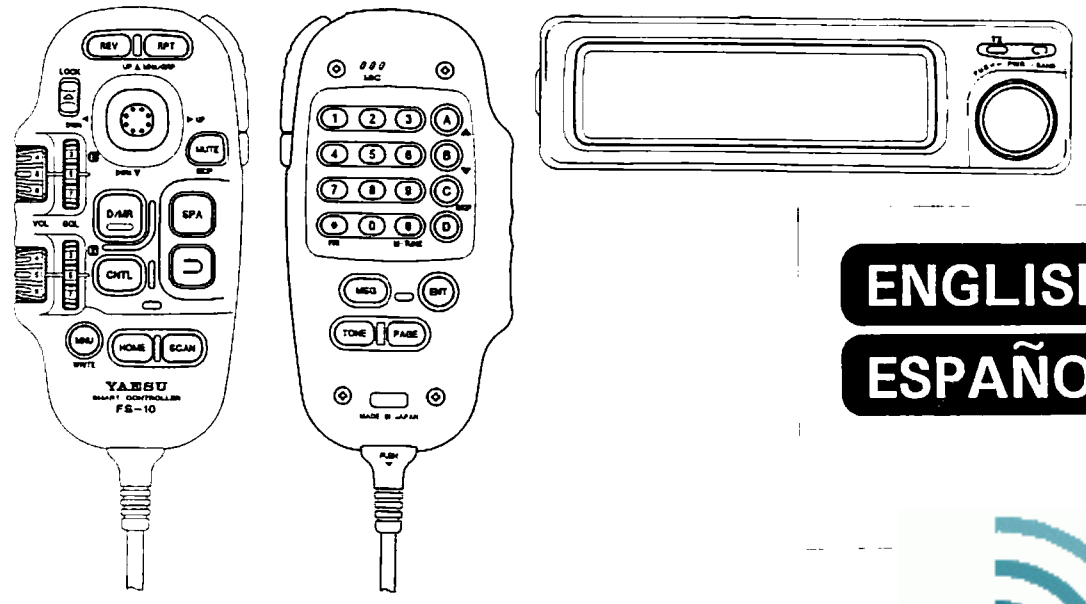

**ENGLISH**  
**ESPAÑOL**





# FT-8500

Dual Band FM  
Paging Transceiver

# Contents

<b>Introduction</b> . . . . .	<b>1</b>	CTCSS Operation	36
<b>Specifications</b> . . . . .	<b>3</b>	CTCSS Bell Paging	36
<b>Accessories &amp; Options</b> . . . . .	<b>4</b>	DTMF Code Squelch & Paging	37
<b>Controls &amp; Connectors</b> . . . . .	<b>5</b>	Trigger Paging	41
Top, Front & Side Panel Views	5-9	One-Touch Paging	41
LCD Indications	10	Paging "Answer-Back"	41
<b>Installation</b> . . . . .	<b>11</b>	Paging Tx Delay	42
Installing the FS-10 Smart Controller	11	Sending DTMF Messages	43
Transceiver	13	Customizing Ringer Settings	45
FS-10 Smart Controller Holder	14-16	DTMF Autodialer Operation	46
FS-10 Key Reference Tables	18	Composing the Ringer User-Melody	46
<b>Basic Operation</b> . . . . .	<b>19</b>	APO (Auto Power Off)	46
Preliminary Steps	19	Alphanumeric Character & Symbol Charts	48, 49
FS-10 Smart Controller	19	Power-On Settings Chart	50
<b>Advanced Operation</b> . . . . .	<b>25</b>	<b>Appendix</b> . . . . .	<b>51</b>
Spectra-Analyzer Operation	25-28	Packet Radio Operation	51
Auto Receiver Mute	28	Cross-Band Repeater Operation	52
Memory Storage	30	Transceiver Cloning	53
Recalling Memories	30	In Case of Problems	54
Home Channel Memory	31	<b>Personal Computer Control Operation</b> .	<b>55</b>
Split Memory Operation	31	PCC Data Protocol	56
Tuning Memories	31	Writing Programs	58
Scanning	33	FTS-22 Tone Squelch Unit Installation	59
Memory Skip Scanning	33	<b>Menu Programming &amp; Custom Settings</b> .	<b>61</b>
Programmed Subband Tuning & Scanning	34	Menu Organization	61
Priority Memory Monitoring	34-35	Menu Headings	62-74

ENGLISH

# FT-8500 Dual-Band FM Mobile Paging Transceiver

Congratulations on the purchase of your Yaesu amateur transceiver! Whether this is your first rig, or if Yaesu equipment is already the backbone of your station, rest assured that your transceiver will provide many hours of operating pleasure for years to come. Along with the philosophy that each Yaesu transceiver should serve you well into the future, Yaesu stands behind our products with a worldwide network of dealers and service centers. Feel free to contact us if you ever need technical advice or assistance.

The FT-8500 is a deluxe compact FM mobile transceiver for both 2-m and 70-cm amateur band operation. A few of the new features in this dual-band rig include the following:

- FS-10 Smart Controller – permits controlling all transceiver functions from the palm of your hand. With the unique joystick lever, tuning and menu programming is now quick and straightforward.
- Spectra-Analyzer – allows viewing station activity above and below a selected channel: simply turn the dial to center a signal of interest on the scope and press the PTT to operate! You can also view activity among programmed memory banks. Adjustable signal width, spacing and span markers allow fine-tuning the spectrum view as you like.

- Configurable Memory Banks – fifty general-purpose memories are arranged into five memory banks on each band. However, you can transfer memory banks from one band to the other as needed. Free up unused memories and move them where they are needed! Five special-purpose memories (including an instant-recall Home channel) are also available on each band. Memories can be tagged with a 6-character alphanumeric name and this name can be displayed instead of the frequency.
- DTMF and Message Paging with CW Monitor – decodes incoming DTMF Paging codes and messages with selectable CW playback speed.
- Dual In-Band Receive (V&V and U&U) with Auto Receiver Muting for improved cross-band operation. Receiver muting has selectable levels and duration.

The upper LCD shows channel data and most programmable settings, you can even display the DC supply voltage. The lower dot matrix display shows programming menus and also double as a Spectra-Analyzer display for viewing channel activity. The LCD has selectable contrast and illumination levels for maximum visibility under varying lighting.

Searching for station activity has never been easier with VFO, memory and programmed-limit (sub band)

scanning and the new Spectra-Analyzer feature. Select all memories or only those you want to be scanned. Two scan modes are now available: Busy Scan searches for activity then pauses, while Clear Scan looks for an inactive channel to operate on - great for urban areas with crowded bands. Scan speed can be set to normal or slow, and when activity is found, scanning pauses, then resume after 5-seconds, or only when the station stops transmitting. Each band has one priority memory which can be monitored every few seconds while operating from the VFO or memories.

The built-in CTCSS (Continuous Tone-Coded Squelch System) provides 39 subaudible tones which can be stored in each memory independently. The CTCSS Bell feature can be set to ring when the tone squelch opens.

DTMF calling and private paging features quietly monitors until calls to you (or only stations in groups you select) are received. After receiving a page, the calling station's ID code is displayed so you know who is calling you. With answer-back paging, the FT-8500 can even acknowledge or relay (forward) DTMF paging calls when you are absent. A fully configurable paging ringer beeps, plays a melody you compose, or plays back paging ID codes in CW! The Trigger Paging function automatically switches from paging to code squelch operation after receiving a page by pressing the PTT so you can talk immediately. The DTMF paging ringer can be dis-

abled, or set to ring 1, 3, 5 or 8 times, and even cycle every minute until you respond. With the one-touch paging feature, selecting and displaying paging codes from the FS-10 is simplified.

DTMF text messages up to eight characters long can be sent to other stations. A message ID of eight characters can also be sent and displayed with the text. Received messages are displayed and automatically stored for later retrieval. A tri-mode ringer alerts you to calls or messages by sounding a preset or user-programmed melody, or else have the built-in CW monitor playback the message in Morse code!

For autopatch operation, a 10-memory, 16-digit DTMF autodialer stores nine frequently-called numbers and one memory reserved for a user-programmed DTMF melody ringer for playback. The DTMF autodial memories can also be tagged with six-character alphanumeric names.

The Tx time-out timer (TOT) limits key-down time and the selectable-period APO (Automatic Power Off) timer turns off the radio after a period of inactivity. A convenient rear-panel data jack is provided for packet TNC connection. Data rate (1200/9600 BPS) and VHF/UHF port selection can be configured via menu programming. PCC (Personal Computer Control) and transceiver cloning is also accomplished using this jack. Please take some time to carefully review this manual thoroughly before operation.

# Specifications

## General

Frequency range: (Rx) 110-174 MHz 410-500 MHz  
(Tx) 144-148 MHz 430-450 MHz

Channel steps: 5, 10, 12.5, 15, 20, 25 & 50 kHz

Frequency stability:  $\pm 10$  ppm from -20 to +60° C (VHF)  
 $\pm 5$  ppm from -5 to +50° C (UHF)

Repeater shift:  $\pm 600$  kHz,  $\pm 5$  MHz (programmable)

Emission type: F3 (G3E), F2

Supply voltage: 11.7 ~ 15.9 VDC

Current consumption:

Receive: Less than 1 A

	VHF	UHF
Transmit (MAX) (high)	11.5 A	9.0 A
(mid)	6.0 A	5.0 A
(low)	4.5 A	4.0 A

Operating temp. range: -20 to +60° C

Case size (WHD): 140 x 40 x 160 w/o knobs

Weight (approx.): 1.1 kg (2.4 lb)

## Transmitter

RF output:	VHF	UHF
(high)	50 W	35 W
(mid)	10 W	10 W
(low)	5 W	5 W

Modulation system: variable reactance

Maximum deviation:  $\pm 5$  kHz

FM Noise (@ 1kHz): better than -40dB

Spurious emissions: > 60 dB below carrier

Microphone type: 2-k $\Omega$  condenser

## Receiver

Circuit type: double-conversion superheterodyne

IFs: 45.05 MHz & 455 kHz (VHF)  
58.525 MHz & 455 kHz (UHF)

12-dB SINAD Sensitivity: < 0.18  $\mu$ V (main)  
< 0.25  $\mu$ V (sub)

Selectivity (-6/-60 dB): 12/24 kHz

Image Rejection: better than 70 dB

Squelch Sensitivity: better than 0.13  $\mu$ V

AF Output: 2 W @ 8 $\Omega$  for 5% THD

AF Output Impedance: 4-16  $\Omega$  (8- $\Omega$  internal speaker)

*Specifications subject to change without notice or obligation.*

*Specifications guaranteed within amateur bands only.*

*Frequency ranges and repeater shift vary according to transceiver version, check with your dealer.*

# Accessories & Options

## ***Accessories***

FS-10 Smart Controller w/cable  
MMB-36 Mobile Mounting Bracket  
DC Power Cord w/fuse  
Spare 15-A Fuse  
Smart Controller Hanger

## ***Options***

YSK-8500 Separation Kit  
MMB-62 Mobile Controller Bracket  
FTS-22 Tone Squelch Unit  
SP-7 External Loudspeaker  
FP-800 AC Power Supply w/Loudspeaker  
MMB-60 Quick-Release Mobile Bracket

*Availability of accessories may vary. Some accessories are supplied as standard per local requirements, others may be unavailable in some regions. Check with your local Yaesu dealer for changes to the above list.*

# Controls & Connectors

## Front Panel

### (1) LCD (Liquid Crystal Display)

The upper half of the display consists of segmented digits for frequency readout and various icons representing enabled transceiver features. The lower half contains a dot-matrix display for Spectrum Analyzer viewing, menu programming and alphanumeric name display. See the graphics on page 10 for descriptions of the display icons and indications.

### (2) DIAL Rotary Selector

Rotate this to tune, or select memories and other settings, according to the function selected by the keys. This knob duplicates some functions of the FS-10 joystick and UP▲/DOWN▼ keys for convenience.

### (3) TX Indicator

This LED indicator glows red when transmitting.

### (4) Auto Dimmer Photo Sensor

This senses ambient lighting and adjusts LCD backlighting for optimum visibility.

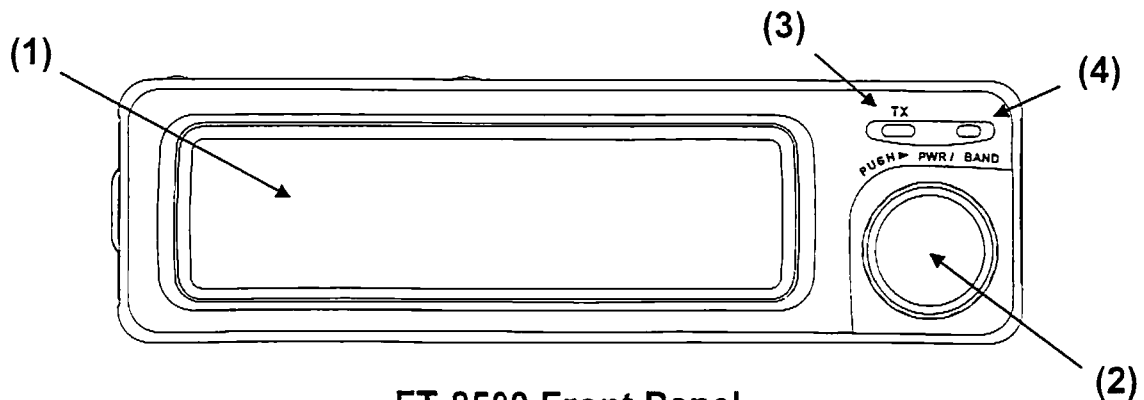

FT-8500 Front Panel

## Rear Panel

### (1) Antenna Jack

This Type-"M" jack accepts an antenna designed to provide 50-Ω impedance on 2-m & 70-cm. An external duplexer is not required. Note: European versions use a Type- "N" connector.

### (2) UHF -SP- EXT Jacks

These 2-conductor, 3.5-mm mini phone jacks provide separate VHF & UHF audio output for an optional speaker (impedance is 8Ω). Inserting a plug into the UHF -SP- jack disables UHF audio from the internal speaker. Both VHF & UHF audio is disabled when a plug is inserted in to the -SP- EXT jack.

### (3) +13.8 VDC Cable Pigtail w/Fuse

This is the power supply connection for the transceiver. Use the supplied DC cable to connect this pigtail to the car battery or other DC power supply capable of at least 15 amperes (continuous duty). Make certain that the red lead connects to the positive side of the supply.

### (4) DATA Jack

This provides interface connections for packet TNC operation, transceiver memory cloning and (with the optional FIF-232C Interface Box) for PCC (Personal Computer Control) operation of the transceiver.

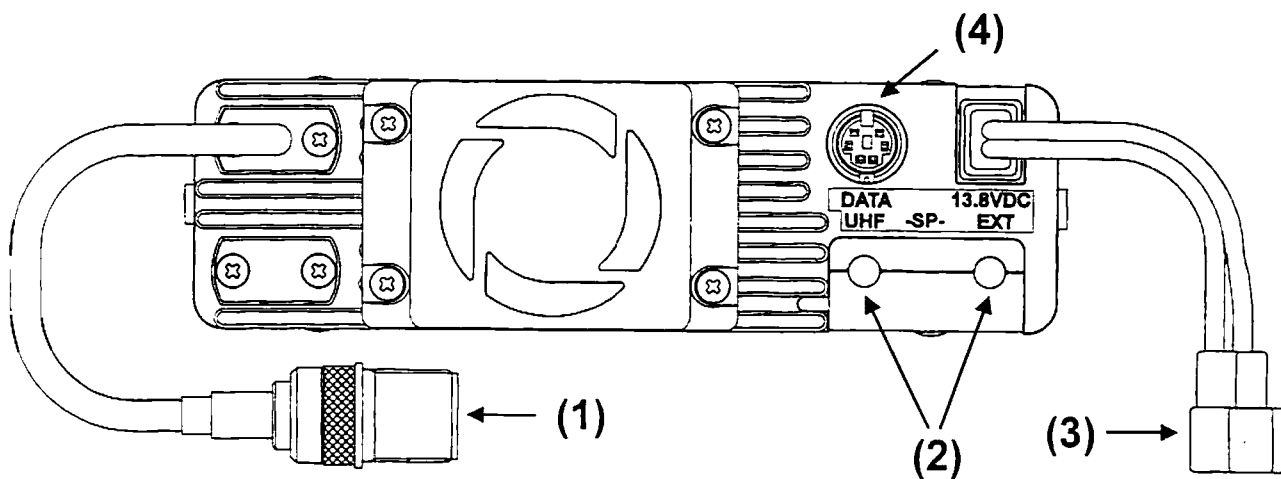

## FS-10 Smart Controller (rear view)

### (1) Microphone

Beneath this grill is the condenser microphone element. Speak across this opening in a normal tone of voice while pressing the PTT.

### (2) Keypad

All 16 keys generate DTMF tones during transmit, some also have other special functions: **A** & **B** tune channels, select memories and start scanning, **C** selects scan skip for selected memories, **H** enables memory tuning in the MR mode, and **\*** activates priority memory monitoring.

### (3) ENT button

Used for direct keypad entry of frequencies. Press this preceding and following digit entry.

### (4) PAGE button

This selects various paging modes: DTMF Paging, Trigger Paging, Code Squelch and CTCSS Bell operation.

### (5) MSG button

This selects prestored message slots for transmission during DTMF Message operation.

### (6) TONE button

Press this to enable CTCSS tone encode or encode and decode (*ENC* or *ENC DEC*).

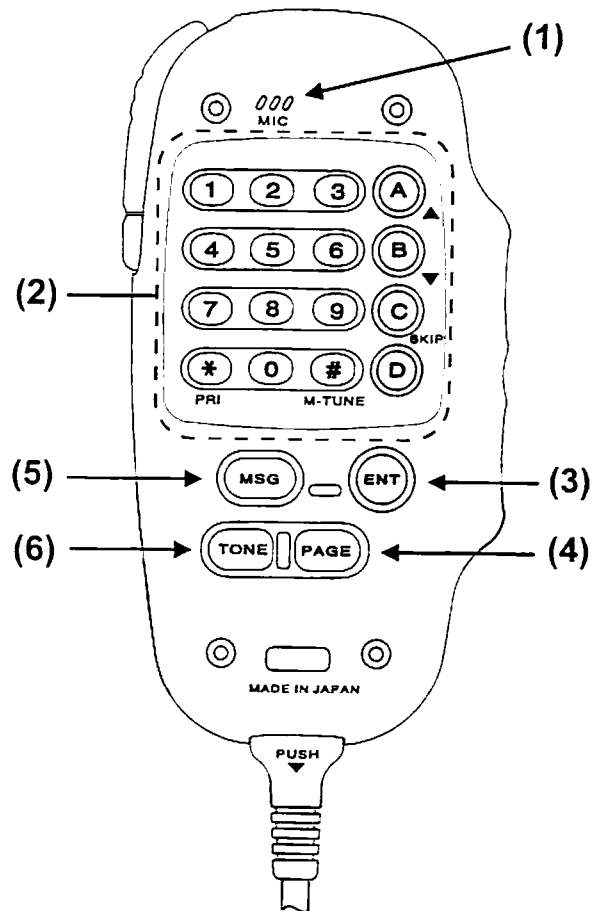

## FS-10 Smart Controller (front view)

**(1) Joystick**

This 3-axis joystick allows frequency tuning, channels selection, as well as adjusting and programming various transceiver settings.

**(2) VOL & SQL Band Selection Controls**

The outer controls adjust the volume of the receiver for each band. Likewise, the squelch is adjusted using the inner controls. This sets the threshold at which received signals (or noise) open the squelch. Pressing inward on either VOL button selects the main channel (band) for operation.

**(3) LOCK switch**

This switch locks the FS-10 controls and buttons. Various locking combinations are selectable.

**(4)  button**

This toggles operation between DIAL and MR (Memory Recall) modes.

**(5)  button**

This toggles the main channel of operation from one band to the other.

**(6)  button**

Pressing this momentarily recalls the Menu Programming loop. Holding it for longer than 1/2 second writes the current channel data to an allocated memory.

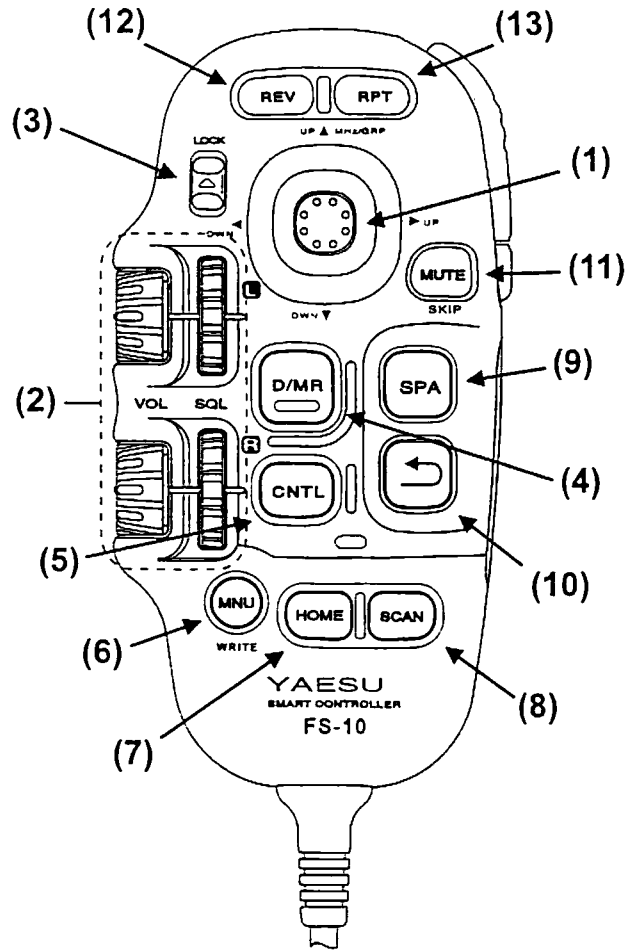

(7) **HOME** button

Pressing this instantly recalls the Home channel for the selected band.

(8) **SCAN** button

This starts band scanning in the DIAL (VFO) mode, or memory scanning in the MR (Memory Recall) mode.

(9) **SPA** button

Press this momentarily to start manual "one-shot" Spectra-Analyzer sweep or hold it to start continuous spectrum sweeping.

(10) **⇐** button

During Spectra-Analyzer operation, press this to revert to the center channel.

(11) **MUTE** button

Press this momentarily to manually mute audio from both channels.

(12) **REV** button

Press this to reverse Tx/Rx frequencies momentarily during duplex or repeater operation.

(13) **RPT** button

Press this to enable Tx offset (+/-) needed for repeater operation.

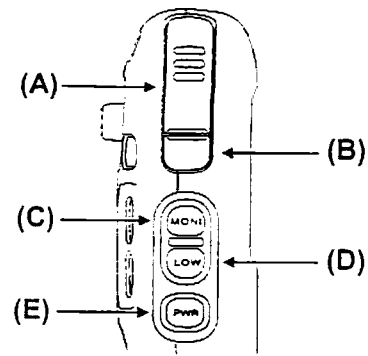

(A) PTT switch

Press and hold this while speaking across the microphone opening to transmit.

(B) Tone Burst switch

In European versions, this transmits a 1750-Hz tone for use with repeaters requiring tone burst. In other versions it has no function.

(C) **MONI** button

Pressing this momentarily disables the receiver squelch to monitor for weak stations.

(D) **LOW** button

Press this to toggle RF output (transmit) power level between low, mid and high.

(E) **PWR** button

Hold this to turn the transceiver on/off or press momentarily while the transceivers is on to toggle main and sub channel operation.

# LCD Indications

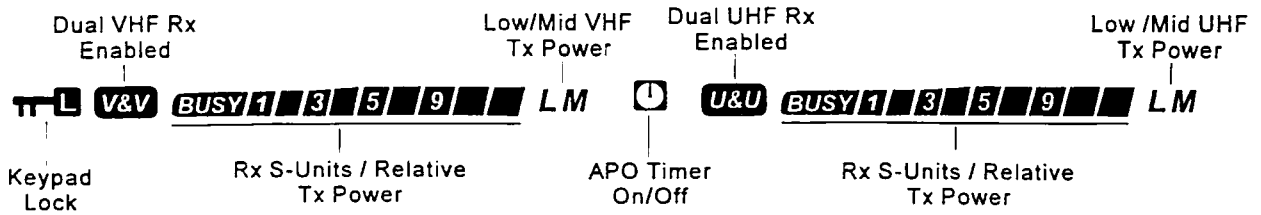
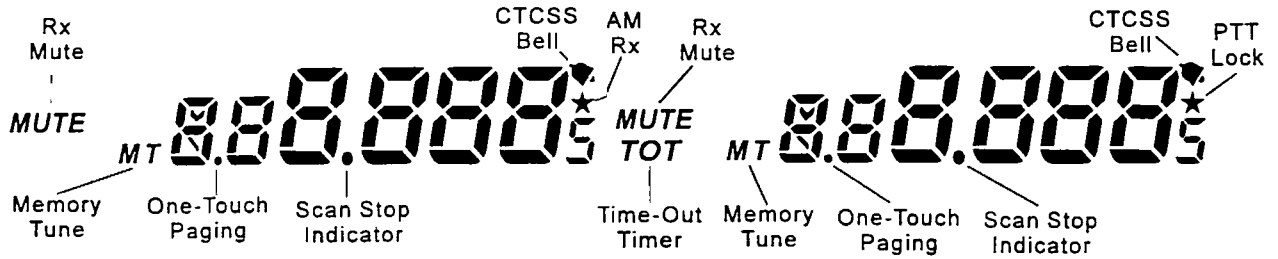
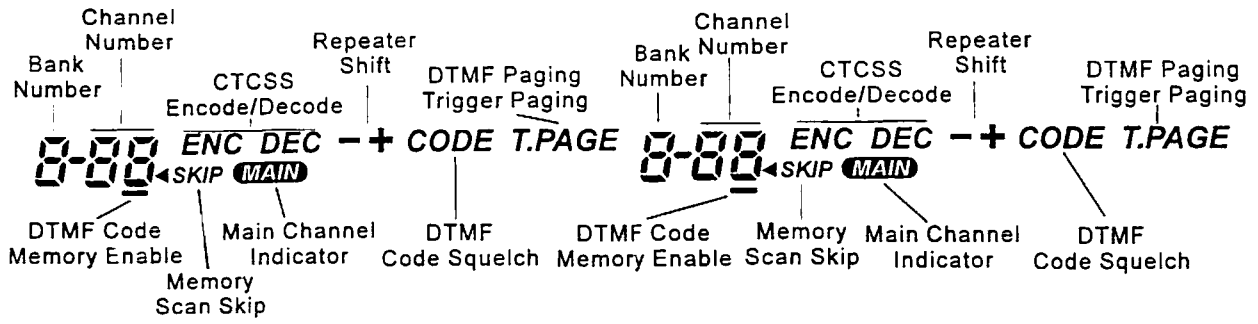

ENGLISH

# Installation

This chapter describes installation of the FT-8500 with typical supplied accessories. Installation of the optional FTS-22 Tone Squelch Unit should be done *before installing the transceiver* and is described in the *Installation of Options* chapter at the back of this manual.

## Preliminary Inspection

Inspect the transceiver thoroughly immediately upon opening the packing carton. Confirm that all controls and switches work freely, and inspect the case for any damage. Make sure the accessory fuse is included. If any damage is found, document it completely, and contact the shipping company (or dealer, if you purchased it over the counter) right away. Save the packing materials in case you need to return the set for service.

If you purchased the optional FTS-22 Tone Squelch Unit, install it now as described on page 59. This chapter describes base station installation first, followed by mobile installation and then interconnections with external accessories.

## Installing the FS-10 Smart Controller

From the factory, the FS-10 Smart Controller and control cable are packaged separately from the transceiver body. They are installed by removing the front panel from the transceiver, plugging the control cable into the FS-10 and transceiver body, then re-installing the front panel.

- To remove the front panel, use your left thumb nail to *slightly* pry open the latch on the left side of the transceiver. Next, using your right hand to slide the panel outward and away from the transceiver.

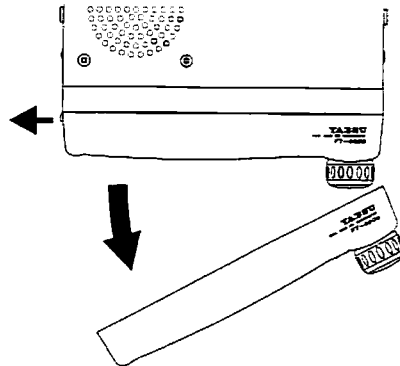

- Locate the control cable and insert the plug with the rubber boot into the bottom of the FS-10 Smart Controller. Insert the other plug into the recessed jack on the transceiver, as shown in the drawing.

- Before reinstalling the front panel, decide if you want the control cable to exit from the side or bottom of the transceiver, then route the cable into the appropriate channel provided (see drawing) Reinstall the front panel by hinging it into place, you will hear a click when the panel locks into place.

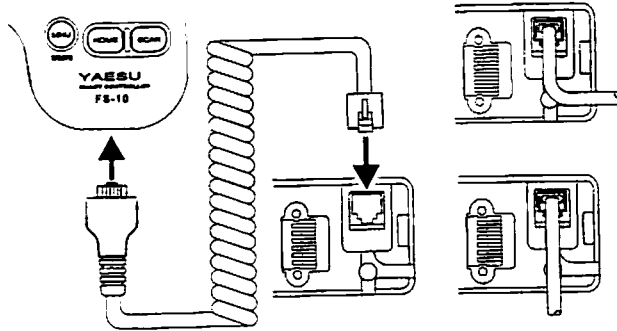

**Important!** Ensure the power is first switched off before removing the front sub-panel. The transceiver will turn off automatically after two seconds if the front panel is removed with power applied.

## Antenna Considerations

The FT-8500 is designed for use with antennas having an impedance near 50  $\Omega$  at all operating frequencies. For optimum performance use a high quality, carefully designed antenna. The antenna should be connected whenever power is on, to avoid damage that could otherwise result if transmission occurs accidentally without an antenna.

Ensure your antenna is designed to handle 50 Watts continuous transmitter power. For best performance and safety in mobile installations, mount the antenna in the center of a flat surface, out of reach of human hands: 50 Watts can cause an RF burn to *anyone touching the antenna during transmission!*

For best performance use the shortest possible length of quality coaxial cable. Use a matching type-M plug for the jack on the transceiver pigtail (European versions use Type-N).

## Mobile Installation

The FT-8500 must only be installed in cars having a *negative ground* electrical system. The transceiver can be installed in one piece using the supplied MMB-36 mobile mounting bracket, or in two pieces using the optional YSK-8500 separation kit and MMB-60 quick release mounting bracket. Mount the transceiver where the display, controls and microphone are easily accessible. The transceiver may be installed in any position, but should not be near a

heater vent or where it could interfere with driving. Make sure to provide plenty of space at the rear so that air can flow freely through the heatsink. Refer to the diagrams showing installation.

### Transceiver Installation

- ❑ Decide the mounting location with sufficient clearance for the transceiver, plus space for ventilation around the cooling fan and above and below the set. Use the mounting bracket as a template to locate the mounting holes. Use a 4.8-mm ( $\frac{3}{16}$ " ) bit to drill the holes, and secure the bracket with the supplied screws, washers and nuts (see diagram).

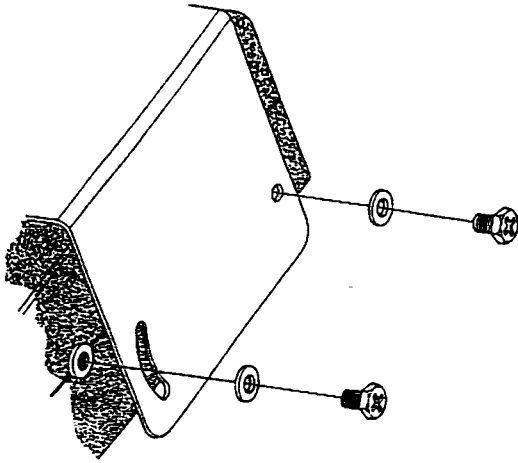

- ❑ Position the transceiver in the bracket so that the holes in the side are aligned with those in the bracket, and bolt the transceiver into place using the supplied short screws and flat washers. The FS-10 Smart Controller hanger may be installed wherever convenient.

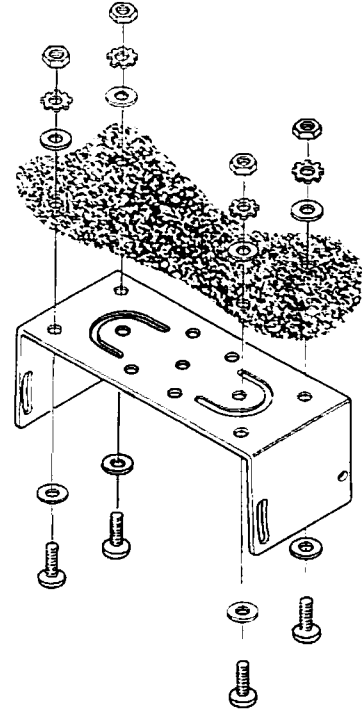

## Mobile Power Connections

To minimize voltage drop and avoid blowing the car fuses, connect the supplied DC cable directly to the battery terminals. *Do not attempt to defeat or bypass the fuse — it is there to protect you and the equipment!*

### Warning!

*Never apply AC power to the power cable of the transceiver, nor DC voltage greater than 15 volts. When replacing the fuse, only use a 15-A fast-blow type. Failure to observe these safety precautions will void the warranty.*

- Before connecting the transceiver, check the voltage at the battery terminals while revving the engine. If it exceeds 15 volts, adjust the car regulator before proceeding.
- Connect the RED power cable lead to the POSITIVE (+) battery terminal, and the BLACK lead to

the NEGATIVE (-) terminal. If you need to extend the power cable use #14 AWG or larger insulated, stranded copper wire. Connect the cable to the transceiver only after connecting to the battery.

## FP-800 AC Power Supply

Operation from the AC line requires a power supply capable of providing at least 15A continuously at 13.8 VDC. The FP-800 AC power supply/loud-speaker is available from your Yaesu dealer to meet these needs. Use the DC power cable supplied with the transceiver for making power connections, and connect the external speaker cable to either speaker jack on the rear panel.

## External Speakers

The optional SP-7 External Speaker includes its own swivel-type mounting bracket, and is available from your Yaesu dealer. Of course the SP-3, SP-4 or SP-55 External Speakers may also be used. Plugging in an external speaker disables the speaker in the transceiver.



**FS-10 Rear Panel Key Reference**

Key	Function
	Toggles CTCSS Encode/Decode Mode: <b>ENC / DEC / off</b> (FTS-22 needed for decode).
	Press to display/select message slot.
	Select Paging, Trigger Pager, Code Squelch or CTCSS Bell operation.
	Direct frequency entry from the 16-digit keypad.
	Tune/Scan up/dwn or select settings.
	Toggles memory scan skip for selected memories.
	Activates Priority Memory Channel monitoring.
	Activates Memory Tuning of the selected memory.
	Transfers Main Channel control to the other band.

**FS-10 Side Panel Key Reference**

Key	Function
	Momentarily disables receiver squelch.
	Toggles High, Mid or Low Tx power.
	Hold to turn power on/off, press momentarily to toggle Main Channel.

**FS-10 Front Panel Key Reference**

Key	Function
	Reverses Tx & Rx frequencies.
	Toggles repeater shift direction: - / +/ off (simplex).
	Toggles the receiver audio mute feature on or off.
	Toggles Dial/Memory Recall operation.
	Enables/disables the receiver spectrum analyzer.
	Transfers Main Channel control to the other band.
	Returns operation to the center channel during spectrum analyzer operation.
	Press momentarily to recall Menu Programming routine, hold for one-touch memory write.
	Recalls the programmed Home channel for the selected band.
	Activates VFO or memory channel scanning.



Notes:

# Basic Operation

This chapter is prefaced with a short tutorial to get users on the air quickly. The remainder of the manual covers the more complex transceiver settings and various programming routines.

For now, we recommend reading these first few pages in detail, then, after you have become more familiar with the basic operation of the FT-8500, you can move on to customize transceiver settings to your taste and take advantage of all of the features of this transceiver.

## Preliminary Steps

Before operating the FT-8500 the first time:

- Connect an appropriate antenna to the antenna jack at the rear of the transceiver. *Never operate the transceiver without an antenna connected.*
- Ensure a 13.8-volt regulated DC power supply capable of providing 15 amps continuous current is used. Never connect this transceiver to 24-volt or positive-ground automotive electrical systems.
- Never connect AC to the power lead of this transceiver, irreparable damage may result and this will void your warranty!

## The FS-10 Smart Controller

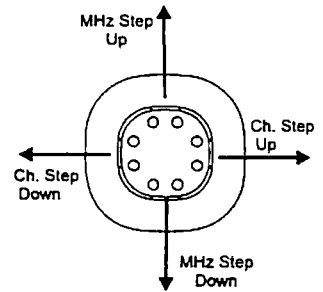

The operating versatility of the FT-8500 is the FS-10 Smart Controller. All transceiver operations are accomplished with this hand-held control unit. Designed with an easy to operate and logical layout, the FS-10 incorporates joystick control - four simple



thumb movements now replace the need for separate UP/DWN buttons and DIAL knob (although they can still be used). Tuning and customizing transceiver settings is now quick and easy. Although it may take some time getting accustomed to using the FS-10 Smart Controller, once you become familiar with its layout and operation, maneuvering through transceiver operations will come naturally.

To lock out functions of the DIAL knob, joystick or controller buttons, slide the **LOCK** switch upward so that  appears. The PTT lock is enabled via the programming menu and **★** appears when activated. The locking scheme (PTT, DIAL, keypad, etc.) can be configured later on page 73.

### Turning the Power On/Off

Turn the power on by pressing in the DIAL knob or  button as shown below. The transceiver is turned off in the same manner - only this time press *and hold* either the DIAL knob or  for 1/2 second.

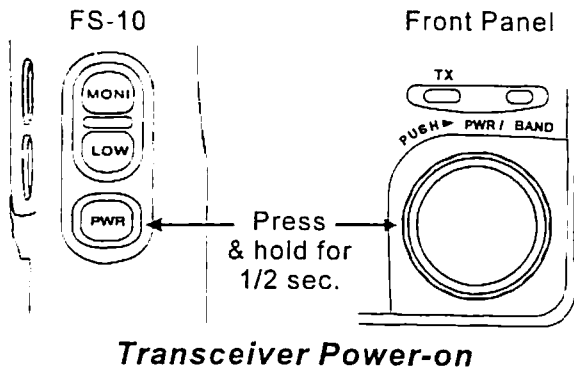

### Adjusting the Volume & Squelch

Volume and squelch are set independently for VHF and UHF. Rotate the outer controls for a comfortable volume level (upper control for VHF, lower for UHF) while receiving stations. The inner squelch control sets the signal threshold for each band at which stations will open the squelch and be heard.

Generally, you will want to set the squelch level just past the point where channel noise is muted. Adjust-

ing the squelch too "tight" results in only strong, relatively nearby stations being heard. With the squelch too "loose", stations too weak to operate, or falsing on channel noise will open the squelch.

### Selecting VHF or UHF Operation

The frequency with **MAIN** appearing next to it is called the *main* channel, while the other displayed frequency is known as the *sub* channel. The sub channel can be *disabled* for monoband operation or you can have the DC supply voltage displayed in place of the frequency (see graphic below and page 71 in the Menu Programming section).

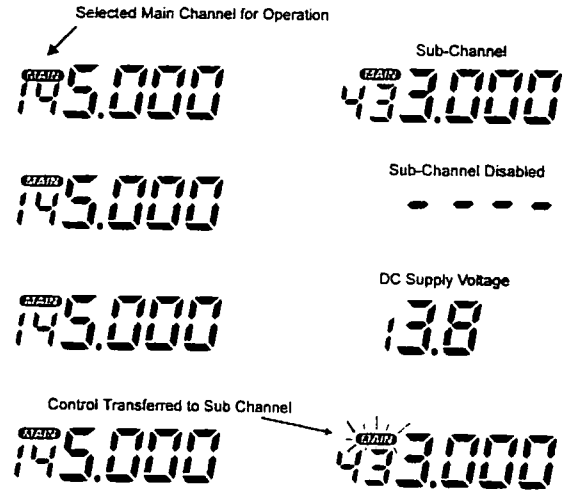

There are three ways to select or toggle a band for operation. You can *momentarily* press in the VOL knob to select the band you want as the main channel, or else momentarily press the DIAL knob or **PWR** button to toggle the main band of operation. Remember to only press these for less than 1/2 sec, as holding them longer will turn the transceiver off, or activate other functions.

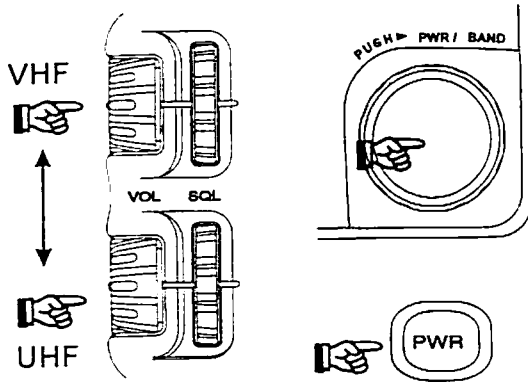

**Selecting Main Band**

Normally, the FS-10 controller and DIAL knob only affect the main channel. However by pressing **CNTL** until **MAIN** blinks next to the sub channel, the controls now act on the sub channel. After making adjustments to the sub channel, press **CNTL** again to return to the main channel.

### Tuning

The FS-10 Controller offers four easy ways for tuning to the desired frequency. The joystick provides versatility in rapidly tuning to a desired frequency. You can jump in 1-MHz segments or in the default channel steps by manipulating the joystick.

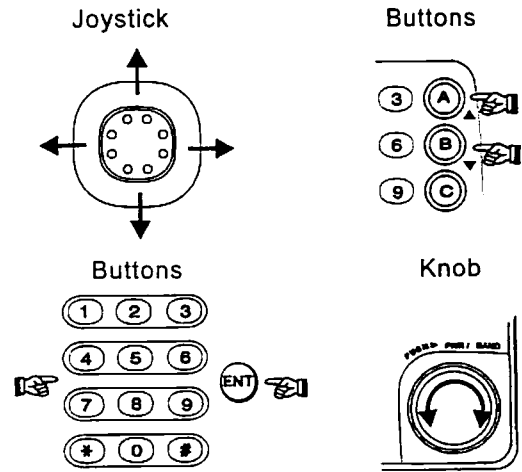

**Tuning Methods**

Pressing the **A** or **B** buttons or rotating the DIAL tunes in the default channel steps only.

IBD (Intelligent Band Display) is active by default and causes the channel display to *blink* to let you know at a glance which band is receiving a station. IBD can be enabled or disabled as described on page 71.

Frequencies can also be entered from the FS-10 keypad using the following procedure:

ex. to enter 446.520 MHz, press:

 ENT → 4 → 4 → 6 → 5 → 2 → ENT

ex. to enter 446.500 MHz, press:

 ENT → 4 → 4 → 6 → 5 → ENT

ex. to enter 446.000 MHz, press:

 ENT → 4 → 4 → 6 → ENT

ex. to enter 440.000 MHz, press:

 ENT → 4 → 4 → ENT

Remember to match the 1-kHz and 10-kHz digits -place entry of the frequency to the default channel (tuning) step size. While some entries are valid, other will be rounded to the nearest 12.5-kHz or 25-kHz channel, or else rejected. If you enter an incorrect digit at any time, simply press the PTT and start over again (this does not key the transmitter). You can enter frequencies directly without needing to first press ENT by turning on the *Direct Frequency Entry* mode via menu programming (see page 71).

### Mixed Receive (V & V.U & U) Operation

You can simultaneously receive on two VHF or two UHF channels, and select either channel as the main channel for operation. During mixed receive, the sub-channel receiver is disabled during transmit.

To mix receive, depress either the VHF or UHF VOL knob for *longer than* 1/2 second (remember that only momentarily depressing toggles main channel selection). Each time a knob is held, the selected display toggles between its normal and alternate band, enabling U&U, V&V and V&U capability (but not U&V). Also, **U&U** or **V&V** appears in the display indicating which combination is selected.



Afterwards, the joystick, DIAL knob and A / B keys are used as before for tuning or scanning operation on either receiver.

During mixed receive, sensitivity and IMD of the alternate receiver is degraded slightly, however this should not be a problem except in highly RF-congested areas.



### Transmitting

Select low, medium or high transmit power by pressing . A three-pitch beep sounds along with each selected output level, and *L* or *M* appear when low or mid-power levels are selected, respectively.

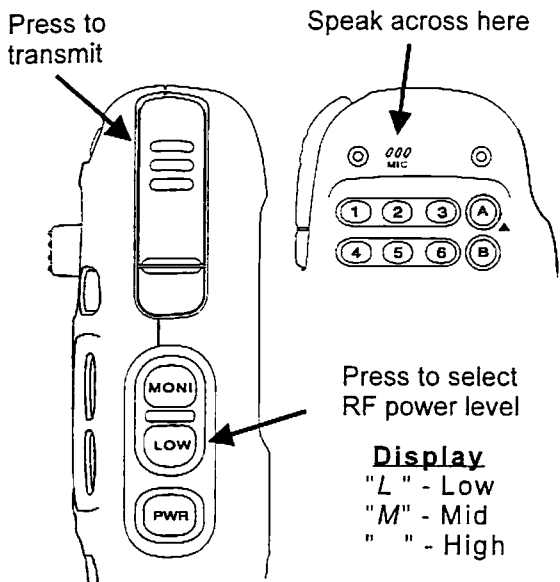

To transmit, press and hold the PTT while speaking across the microphone element grill in a normal voice. Release the PTT to receive again. During transmission, LCD bargraph segments appear and the red TX lamp just above the DIAL knob turns on (as shown in the graphic).

		VHF	UHF
	L	5 W	5W
	M	10 W	10 W
		50 W	35 W

### Repeater Operation

The ARS (Auto Repeater Shift) feature allows easy repeater operation by automatically selecting the standard shift (-/+) used in the VHF/UHF repeater sub bands of the country the unit is shipped to.

#### ARS-Repeater Subbands

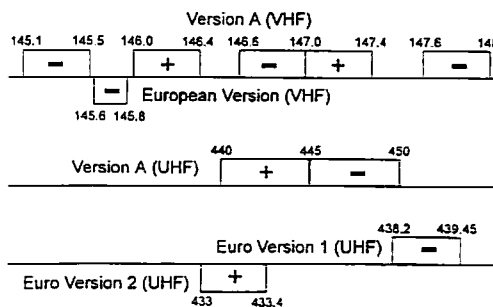

Pressing the PTT is all that is normally needed to operate on standard "open" repeaters. If the repeater uses a reverse shift, you can select this manually by toggling the button until the required shift ap-

pears. If you want to listen on the repeater input (to see if you can work a station direct, for example), you can reverse Rx/Tx frequencies by pressing **[REV]**.

For repeaters requiring a CTCSS tone for access, press **[TONE]** to activate the CTCSS tone encoder (**ENC** appears). CTCSS operation and tone selection are covered later on page 35.

**Note:** European versions of the FT-8500 can access repeaters requiring a 1750 Hz tone burst by pressing the lower segment of the PTT switch (this activates the transmitter and sends the 1750 Hz tone). In other versions this switch has no function.

#### Selecting DIAL or Memory Operation

**DIAL Mode** - This is for tuning or scanning a band when looking for a clear channel to operate on. In this mode, the joystick, DIAL knob and **[A]** / **[B]** keys each tune the band in the selected step size, (or in 1-MHz steps using the joystick), and the scanning function tunes in the selected step size.

**Memory (MR) Mode** - This is for operating on channels usually stored in memories. For example, after storing the frequencies of your local repeaters, you can confine operation to those channels by selecting the memory mode. The joystick, DIAL, **[A]** / **[B]** keys and scanning function select stored memories.

Each band has 50 general-purpose memories arranged into five banks with ten memory channels per bank. These banks can be transferred from one band

to another as needed (explained later). Six additional special-purpose memories store band scanning & tuning limits, a priority channel and a home channel.

Memory Structure					
General Purpose Memories					Special Use
1-01	2-01	3-01	4-01	5-01	L1
1-02	2-02	3-02	4-02	5-02	U2
↓	↓	↓	↓	↓	L2
1-09	2-09	3-09	4-09	5-09	U2
1-10	2-10	3-10	4-10	5-10	PR1

Each memory has a Memory Tune mode which allows tuning similar to the DIAL mode, and storing the resulting re-tuned memory into the same or another memory slot. This and other special MR functions are described later, but keep these terms in mind.

You can tell at a glance which mode is active for each band by looking above and to the left of the first frequency digit. If you see a number or name (such as **1-01** or **PR1**), you are in the MR mode. The numbered annotation denotes bank and channel. For example 1-01 indicates bank 1, channel 1.

The **[MEM]** key toggles between DIAL and the last-used memory. While in the MR mode, your previous DIAL settings are preserved.



# Advanced Operation

In the Basic Operation chapter, essential transceiver functions were briefly covered to get you on the air quickly. In this chapter, the remainder of the more advanced operating features and programming are covered. The FT-8500 has a wealth of features to allow you to derive the most operating pleasure whether you are mobile, base or away from your rig.



The more advanced transceiver functions have various settings and parameters associated with them that are usually configured according to operating requirements or personal taste. The FT-8500 uses a menu display system which allows using the FS-10 controller joystick to navigate among the various menu entries, then select and configure settings as needed. Afterwards, most of these settings take effect when the transceiver is turned on, or when manually enabled with the press of a button. Menu programming is covered in the last chapter, which begins on page 61.

Throughout this chapter, various page references are made to the Menu chapter. In this chapter we cover more advanced operational features and settings. After understanding how each feature works, you can proceed to the Menu chapter and customize each setting as we go along - or after all the descriptions are covered first.

## Spectra-Analyzer Operation

The Spectra-Analyzer displays station activity above and below the current operating channel in the DIAL (VFO) mode. In MR (Memory Recall) mode, all programmed memories within a selected memory bank (up to 10 channels) are displayed for activity. In both modes, the display shows the relative signal strength of any stations on each channel.

You can use the analyzer to search out signal activity, and then QSY directly to a signal of interest for a QSO.

The Spectra-Analyzer is operated using the  and  buttons. Two types of sweep activity are possible:

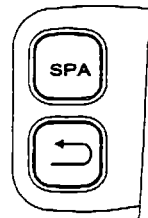

**Single Sweep** - press  momentarily (less than 1/2 sec.). Each press thereafter gives a "one-shot" sweep for activity.

**Continuous Sweep** - press and hold  (longer than 1/2 sec.) for continuous sweeping. During continuous sweep, *S PA* blinks above and to the left of the Main Channel (similar to that shown on the next page).

When activated, the lower dot-matrix display sweeps from left to right searching for activity on the main channel. The centered pixel group (top & bottom) of

the lower display is the *center marker*, and a single blinking group is the *tuning marker* (representing the displayed receive frequency). When Spectra-Analyzer operation starts, the center marker is at the receive (displayed) frequency. In fact, the lower center marker and tuning markers overlay and appear as one. As you move the joystick, turn the DIAL or press on the **A** / **B** buttons, the tuning marker shifts left or right, while the center marker remains fixed to give a relative position of your retuned frequency.

The vertical (stacked) pixels indicate the relative strength of received stations and ranges from 1-7 pixels. The sweeping circuit of the Spectra-Analyzer combined with vertical representation of signal activity form a characteristic "silhouette" of band activity.

*Span markers* are provided to give visual reference during frequency excursions and signal "location". They can be calibrated to appear in 100-kHz, 200-kHz, 500-kHz, or 1-MHz increments.

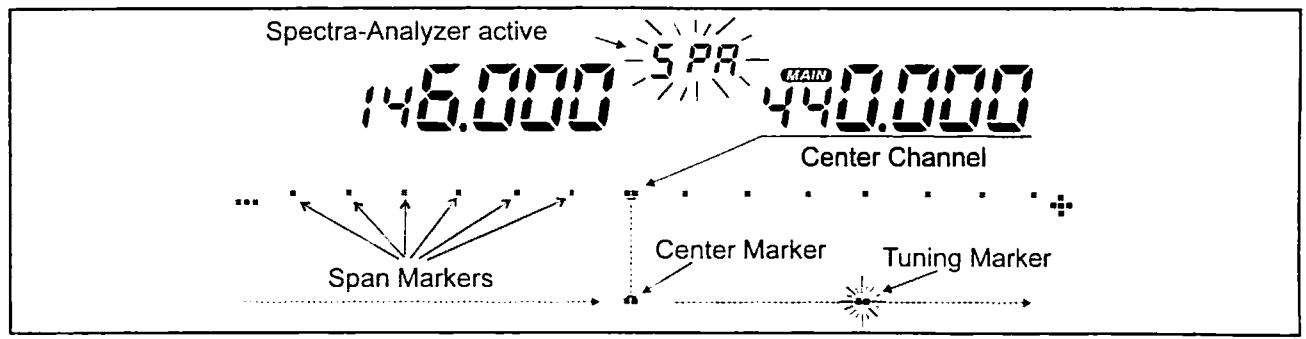
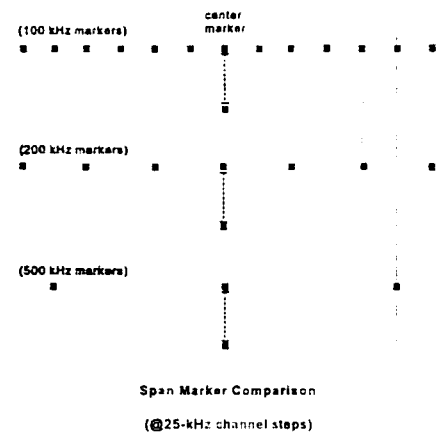
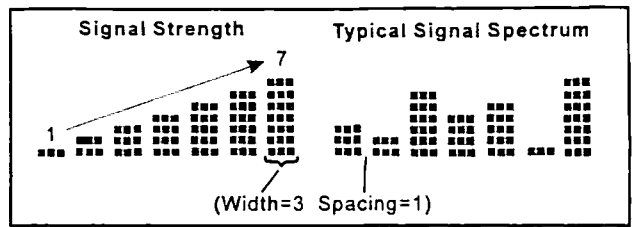

It is important to realize that the total spectrum you can view depends on the configuration of three (3) following settings:

**Channel Step Size** – basically, the larger the steps size, the greater the total spectral view, but at the expense of channel resolution. For general operation, we recommend keeping the default step size to the standard size used for the amateur band you operate on.

**Signal Width** – the number of horizontal pixels assigned to represent a signal. Received signals can be displayed using 1 to 10 pixels in width.

**Space Width** – similarly, this is how many horizontal pixels are turned off to represent “spaces” between visible channel activity. This can be varied from 0–5 pixel widths. Both this and the signal width setting determine how the spectrum “silhouette” appears.

With seven channel steps sizes, ten signal widths and six space widths, there are a variety of combinations that each present a unique spectrum view. With experimentation, you can select the combinations that are most effective for your operating needs and configure these settings in the Menu Programming chapter on page 61. The illustration shows examples of the effect of these settings.

Signal Width=5  
Signal Spacing=1



Signal Width=5  
Signal Spacing=5

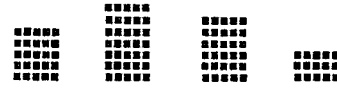

Signal Width=2  
Signal Spacing=0





### Using the Spectra-Analyzer

For DIAL (VFO) operation press **SPA** to start continuous or single sweeping. When you see activity or a signal of interest, use the joystick, DIAL or **A**/**B** buttons to shift the tuning marker over so that it is centered on the visible segment (or the tallest segment of a group). When properly centered on an active channel, the frequency display blinks (unless IBD is disabled, see page 71). Please remember the following points when using the Spectra-Analyzer:

- If *single-sweep* mode was used (pressing **SPA** for less than 1/2 sec), the station will be heard when



- properly tuned (the marker is centered). You can press the PTT at any time to operate.
- With *continuous-sweeping*, after centering (tuning) a signal of interest, you must first *press in on the joystick once* to monitor and/or transmit, *and again* to resume sweeping.
- When viewing main channel activity, you can toggle operation to the sub channel at any time, however, *Spectra-Analyzer operation remains on the previous band*. To change spectrum views, you must first turn the scope off by pressing , then toggle bands and press  again.

You can instantly return to the original (center) channel at any time during Spectra-Analyzer operation by simply pressing .

#### Display Dimmer and Contrast

The LCD backlighting adjusts automatically to ambient lighting from the front panel photo sensor. However, there are six auto-dimmer levels and six manual levels that can be selected, and backlighting can also be turned off if desired.

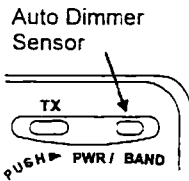

The display contrast can be manually adjusted through 16 levels for best visibility at different viewing angles. Please refer to page 71 for menu programming of dimmer and contrast settings.

#### Auto Receiver Mute

With dual receive capability, stations can occasionally be heard from both receivers simultaneously. Aside from causing confusion, important information such as a QTH or callsign from the desired station might be missed. This feature mutes or disables audio while receiving a station from a selected band while receiving a station on the other band. You still have S-meter indications of activity on the sub-channel, but audio will not be heard while the main-channel is busy. Audio from both channels can also be muted together, if desired.

The mute feature can activate automatically or manually using the  button. In addition, selectable muting levels and time duration are available. The settings explained below are menu-configured and covered on page 73.

**Mute Time** - during manual muting, audio is continuously muted by selecting Off, otherwise a mute duration of 1 - 60 mins can be selected. After the time expires, audio is unmuted until  is pressed again. Timer settings do not apply if Auto Mute is enabled.

**Mute Level** - Audio is either partially or completely muted according to selected mute level.



- Mute Level 1 (*preset muting*) - reduces audio to a *preset level*-regardless of the original volume (the preset level is also factory default).

- Mute Level 2 (*full mute*) – audio is disabled so that received audio from the selected band is not heard.



**Auto Mute** - this selects which band's audio is to be muted if two stations are received simultaneously (see the note below). The **MUTE** icon appears above the selected band. The mute function is completely disabled by selecting OFF.

**Note** - during mixed V&V or U&U receive, the **MUTE** icon identifies which channel's audio will be muted.

With Auto Mute enabled from the menu, the function activates whenever the radio is turned on, and **MUTE** appears to the left of the selected band. Refer to the table for a comparison of manual and auto mute.

Mute Function Comparison	
Manual Mute	Auto Mute
Enabled by pressing  momentarily (<1/2 second).	Enabled/disabled in the auto mute menu, activates when the transceiver is turned on.
Mutes <i>both</i> channels / bands according to the selected mute <i>level</i> (1, 2) and <i>duration</i> (1-60 mins) set by menu.	Mutes a selected channel / band ( <b>MUTE</b> icon displayed) according to the selected mute level.
Comments	Comments
Ensure mute time is set between 1-60 mins - setting this to 0 <i>disables</i> the manual mute feature completely.	Mute time duration (1-60 mins) does not apply to this function.
Do not hold the  button longer than 1/2 sec. this activates the unrelated skip function.	Pressing  momentarily during Auto Mute operation mutes <i>both</i> channels.

### Extended Receive & AM Reception

Receive range (only) can be extended from 110-174 MHz (VHF) and 410-500 MHz (UHF) by performing a power-on routine. Press and hold  &  while turning on the power.

If you want to receive aeronautical transmissions, AM mode can be set to automatically activate for frequencies between 110-137 MHz or else be disabled via menu programming (see page 74). For best tuning, use 50-kHz channel steps in the aeronautical band.

The ★ symbol *blinks* next to the *left* frequency display to remind you that AM reception is enabled. *Note:* do not confuse the blinking ★ AM indication with the PTT lock indication (which appears as a *steady* ★ next to the *right* frequency display.

To return to amateur band-only reception, repeat the power-on sequence.

## Memory Storage

There are 112 programmable memory channels in the FT-8500. These consist of 100 regular memories divided into 10 banks, along with 6 special-purpose memories (L1, L2, U1, U2, PRI and HOME) for each band. Normally, the ten memory banks are divided evenly, providing 5 banks (50 memory channels) each for VHF and UHF. If you need more memories on a particular band, you can transfer banks as needed (see the box to the right).

Each memory can store separate receive and transmit frequencies or repeater shift, and CTCSS tone data. The Home channel memory is recalled instantly by pressing . The L1 & U1 and L2 & U2 memories can be used in pairs to store the programmable tuning and scanning limit as described later, in addition to general purpose operation. The PRI memory can be used for priority channel monitoring.

You can assign alphanumeric (A/N) names up to 6 characters long to each memory, and have it displayed by name rather than frequency. Memories that have not been named are still displayed in the usual *3-01, L1* format, so you can mix and select the way memories are displayed.

A choice of 60 different characters is available, with 24 special-purpose symbols to customize your name tags (see the table on page 48). While programming frequency and operating settings into a memory, you can assign it a name. Refer to page 62 in the Menu Programming section.

### Transferring Memory Banks

The ratio between VHF and UHF memory banks can be changed as needed. Hold the button while turning the transceiver on. The display appears as below showing the present memory bank ratio:

UHF 5 BANKS UHF 5 BANKS

Move the joystick up/down to select the ratio you need, then press to save and exit. *Note: previously-stored channel data is lost when performing this procedure.*

Notice that pressing from the VFO mode always recalls the *last stored or used* memory. When storing memories, <VACANT> appears on the display for memories that have not been previously programmed, while <AVAILABLE> appears when memories presently storing data are selected. Make sure you don't overwrite memories that contain important data.

### Recalling Memories

In confirming the results of the last example, we used to change from the VFO mode to the memories after they were stored. The group and channel number appears at the display top whenever operating on a memory.

After at least one memory has been stored, you can select memories for operation by pressing using the joystick, DIAL, or . If you use the keys, press and release the key for each memory: if



you hold either key down for more than 1/2-second, memory scanning will start. In any case, only pre-stored memories are displayed: empty memories are skipped. To exit the memories and return to the last-used VFO, press **EXIT**.

### Direct Memory Recall

After at least one memory has been stored, you can also select them for operation by direct keypad access. Simply press **ENT**, enter the memory bank and channel number, followed by **\***. Note: *special function* memories (L1, L2, U1, U2, PRI & Home) cannot be recalled via direct recall.

For example, to recall programmed memory 3-08, press the following:

**ENT** → **3** → **0** → **8** → **\***

### Home Channel Memory

The Home channel is an instant-recall memory (one per band) that can be used to give quick access to any commonly used frequency (such as a simplex calling channel or club repeater). It is instantly recalled from DIAL or MR modes by pressing **HOME**. It appears in the channel box for the respective band while the Home channel is selected. The Home channel memory is set to bottom edge of the band by default, but you can reprogram it with any frequency and repeater state, or even a separate transmit frequency.

To program the Home channel memory, select **03:HOME CHANNEL WRITE** under the **<MEMORY FUNCTIONS>** menu (page 63) and use the same procedure for storing regular memories.

### Split Memory Operation

All memories can store an independent transmit frequency, for operation on repeaters with non-standard shift. To do this:

- Store the receive frequency in the desired memory using the method already described (it does not matter if a repeater offset is active).
- Tune the VFO to the desired transmit frequency. Press **REV** and use the joystick to again bring up the **01:MEMORY WRITE** entry.
- Push the joystick in, then hold the PTT switch while pressing **REV** once more momentarily (this does not key the transmitter).

Whenever you recall a separate transmit frequency memory, “- +” appear together above the appropriate frequency display. Again, you can press **REV** to display the transmit frequency, and the shift symbols will blink. You can also press **RPT** to cancel repeater shift (temporarily, until you change channels).

After storing a memory with a separate transmit frequency, rewriting the receive frequency *also* deletes the separate transmit frequency.



### Tuning Memories

While receiving on a recalled memory, you can re-tune it and change other memorized settings (such as repeater shift) by pressing . The *MT* icon appears to the left of the channel display, and you can tune in the same way as described before (including 1-MHz steps).

- To store the retuned frequency or setting in the current (or other) memory: press , bring up the **01:MEMORY WRITE** entry, select a new memory (if desired). Press again to save the retuned memory, then to exit memory tuning.
- Once you have retuned a memory, if you don't want to save your changes, just press to return to the original memory data.

### Clearing Memories

If you regularly move from one area to another, you may want to use certain memories at specific locations or times. You can temporarily clear undesired memories from operation (except memory channel *1-01*) and restore them any time later when needed. Refer to page 63 for details on memory clearing. The status of each memory appears on the menu display.

The following are a few terms to be familiar with:

- **<VACANT>** indicates the memory has not been previously programmed.

- **<RESTORE>** appears for previously written memories which have been erased.
- **<ERASE>** indicates memories stored with data but not yet erased.
- **<PERMANENT>** only appears on memory *1-01*, this memory cannot be erased.

### One-Touch Memory

To store channel data quickly, holding for 1 second writes the current channel settings into the *first vacant memory of the last available bank*. For example, if five banks were made available for VHF (see the box on page 30), and all memories in bank 5 were vacant, channel data would be entered into *5-01*. You can later recall this memory and assign it a name or move it to another memory channel, as desired.

### Memory-Only Mode

If you would like to only operate on memory channels, you can use this feature for very simple operation: only stored memories can be selected and displayed (along with their alphanumeric names, if so tagged). Indicators for settings like repeater shift and tone squelch are still displayed, although they cannot be changed. Only TX power, volume/squelch, channel selection and paging operation can still be selected.

- After programming memories, you can toggle memory-only operation by holding & while turning on the power.

## Scanning

Before scanning, make sure the squelch is set to silence background noise. In the DIAL (VFO) mode scanning starts *upward* by pressing **SCAN**. To toggle scanning direction *downward*, press **ⓑ**, hold the joystick to the left or rotate the DIAL ccw. If the transceiver is in the VFO or MT (memory tune) mode, band scanning will result. Otherwise, in normal memory mode, only the memories are scanned.

In the MR (memory recall) mode, *momentarily* (less than 1/2 sec.) pressing **SCAN** only scans those programmed memories *in the currently selected bank* (1-0 1-1-10, for example). Pressing *and holding* **CTRL** scans all memories (except L1, U1, L2, U2 & PRi).

Scanning pauses when a signal opens the squelch, the decimal point in the display blinks (with IBD enabled, the frequency also blinks - see page 71).

When band scanning, a double beep sounds each time the scanner reaches the band edge, unless the beeper is disabled (page 71). Scanning resumes according to how you set the scan resume mode in the menu programming on page 72. There are two types of scanning, each with two modes of resume operation:

**BUSY SCAN** - searches for the next active channel, then pauses. With *Carrier Resume*, scanning continues after the station stops transmitting. *Time Re-*

*sume* pauses on activity for 5 seconds then scanning continues (if the station is still transmitting or not).

**CLEAR SCAN** - searches for the next open (clear) channel, then pauses. With *Carrier Resume*, scanning continues if a station transmits. *Time Resume* pauses on open channels for 5 seconds then scanning continues (if a station is transmitting or not). You can use Clear Scan in metropolitan areas with crowded bands to find a free channel to operate.

Normal or slow scan speed can also be selected in the \*37:SCAN SPEED SELECT menu on page 72.

To manually stop scanning, press the joystick up or down, PTT, **PTT** or **PTT**. This leaves operation on the current frequency.

### Memory Skip Scanning

With very active channels stored in memories, you may wish to skip them when scanning, but still have them available for manual selection. You can mark a memory to be *skipped* by pressing **ⓐ** while receiving on the memory. The **SKIP** icon appears just above the 100's of MHz digits, indicating that this memory will be skipped during scanning (although you can still recall it manually).

To cancel scan-skip and allow the memory to be scanned, repeat the steps used to disable it; select the memory manually, and press **ⓐ**.



### PMS (Programmed Memory Scanning & Tuning)

Besides band and memory scanning, you can also scan only between two frequencies of your choice (in the selected channel steps). The limits are stored in two pairs of special memories labeled L1 & U1 and L2 & U2 as follows:

- Store the lower edge of the desired scanning range in memory L1, and the upper edge in memory U1 (or L2 & U2).
- With either of the memories recalled, press **MT** to enable memory tuning (*MT* appears *blinking*).

You can now tune and scan as before, however the range is now limited to the resulting subband. If ARS or manual repeater shift is activated, the offset is applied automatically when you transmit (even if the resulting transmit frequency is outside the subband limits). Memories L2 & U2 work together the same way.

**Note:** The frequency resolution of subband limits is 100 kHz, although the channel resolution of the L & U memories is the selected channel step size. Therefore, the actual limits are the frequencies stored in these memories *rounded down* to the nearest 100 kHz. Since the memories themselves are not limited to a specific frequency, you can still use them for other purposes within the 100-kHz range above the intended limit.

Note that with PMS, as with regular band scanning, a double beep sounds each time the scanner reaches the sub band edge, unless you have disabled the beeper (page 71).

- To release subband limits press **MEM** once to return to memory operation, again to return to a VFO, or **HOME** to switch to the Home channel.

Once the L & U memory pairs are stored, you can reactivate subband scanning and tuning just by recalling either memory of the pair and pressing **MT** again. However, you cannot activate the subband if either memory of either PMS memory-pair is marked for skip-scanning, or cleared (page 63).

### One-Touch PMS



A faster way to start PMS scanning is by holding **SCAN** for one second; the display reverts to the *last-used PMS memory* with memory tuning automatically enabled (*MT* blinking). If this memory is in the pair (subband) you wish to scan, simply press **SCAN** to start. Otherwise select a memory in the other pair and press **SCAN** to begin scanning.

### Priority Memory Monitoring

The priority function automatically checks for activity on the priority memory every five seconds while operating on the VFO or other memories. When the receiver detects a signal on the priority memory, operation automatically shifts there while the signal is present (plus a few seconds). If you transmit while

paused on the priority memory, monitoring ceases and operation stays on the priority memory.



To set up priority monitoring:

- Program a channel you wish to use as the priority channel in memory *PR 1* (found between *U2* and *1-0 1*).
- Press  to operate in the VFO mode or select the memory you want to operate on, and then press . *P* appears in the display, and about every five seconds the displayed frequency and channel number shift to the priority memory (*PR 1*) briefly while the receiver checks for a signal.

As long as no signal appears on the priority memory to open the squelch, you can tune, transmit and receive on the VFO, or select other memories (memory labels are displayed only while changing). If you hear a station you wish to talk with on the priority memory, press the PTT momentarily while receiving their signal to stop priority checking, otherwise, operation reverts and checking continues. Priority monitoring will resume according to how you set the scan-resume mode (see page 72). To cancel priority monitoring manually, press .

Note that you programmed memory *PR 1* as the priority memory in the above procedure when operating from a VFO. You cannot, however, switch between memory and VFO operation (because pressing  cancels priority monitoring).

### Locking the Controls

The PTT, FS-10 buttons and DIAL can each be locked (disabled) to prevent inadvertent transmissions or adjustments. You will find  (dial and/or buttons) or possibly  (PTT lock) displayed singly, or in combination near the frequency display when any of these are locked. Configuring the locking scheme is explained on page 73.

The DIAL and buttons are locked using the LOCK switch (located just to the left of the joystick), while the PTT lock is menu-enabled. Slide the switch upward to lock and down to unlock.

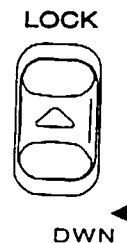

## CTCSS Operation

You can access repeaters requiring a CTCSS (continuous, subaudible) tone, and silently monitor for calls on busy channels. The encode "**ENC**" function superimposes a subaudible tone on the transmitted carrier. The decode "**DEC**" (tone squelch) function monitors receiver audio through a narrow filter at the same subaudible frequency, keeping the squelch closed until you receive a matching tone (with optional FTS-22 tone squelch unit installed). To check or set the current CTCSS tone frequency, refer to page 64.

To activate CTCSS functions, press **(TONE)** when the operating frequency is displayed. With one press, **ENC** (encode) appears above the display and the tone generator is activated for transmission. Press **(TONE)** again and **ENC DEC** are displayed together as the tone squelch system is activated for both transmit and receive (only incoming signals "encoded" with the matching tone open the squelch). To turn off the tone squelch features, press **(TONE)** once more.

You can store CTCSS tones (and encode/decode states) in each memory in the same manner and at the same time as storing channel frequencies. To change the tone or state stored in a memory, just recall it, reset the tone frequency or function, and store the memory again. If you activate CTCSS on a subband limit memory, it will be active when *that* memory is used to start subband operation.

## CTCSS Bell Paging

CTCSS Bell operation is an extension of the CTCSS encode/decode function previously described: incoming subaudible tones open the squelch. However, it adds two features to make this semi-private operation more convenient:

(1) The CTCSS Bell mode displays  above the respective band's frequency display. When you receive a matching CTCSS tone, this bell blinks for a few moments to indicate you received a call. So, by looking at the display you can tell if a call came. You cannot tell, however, who called. That requires DTMF Paging, described later.

(2) If you are waiting for a call, it is sometimes convenient to have the transceiver "ring" to get your attention. The alert ringer can be set to ring once, several times or can be disabled completely (see page 69 for CTCSS Bell ringer configuration).

To activate the CTCSS Bell:

- Tune to the desired frequency, then select a CTCSS tone frequency as described on page 64. Note: **ENC DEC** does not have to be selected and/or appear in this case.
- Press **(PAGE)** four times to select the CTCSS Bell mode. This cycles through the following paging mode/displays:
  - DTMF paging – **PAGE** is displayed below the center of the respective frequency display.



- DTMF "Trigger" Pager – *T.PAGE* is displayed, as above;
- DTMF tone-coded squelch – *CODE* is displayed;
- CTCSS Bell Paging –  is displayed at the upper left, and;
- No paging (none of the above symbols).

Now all incoming calls without a matching CTCSS tone will be ignored by your receiver. Any call received with the matching CTCSS tone will cause  to blink and the transceiver to ring (if the ringer is enabled) as the squelch opens while the caller transmits. Note that other stations do not need to be using the CTCSS Bell function to call you: they can use normal CTCSS functions of their transceiver.

When you reply to a CTCSS Bell call, you may want to turn off the CTCSS Bell function, since otherwise the transceiver will ring every time your squelch opens (unless you have disabled the ringer). Just press **PAGE** once to turn it off. If you have set up normal tone squelch operation beforehand, you can continue your QSO.

You can store the CTCSS Bell mode selection in a memory, just as you can store different CTCSS tones and encode/decode states.

### DTMF Code Squelch & Paging

The FT-8500 includes a DTMF (Dual-Tone, Multi-Frequency) tone encoder/decoder for paging and selective calling features. This allows calling specific stations or groups, and receiving calls directed only to you or to groups of your choice.

The paging and code squelch systems use 3-digit numeric codes (000 ~ 999), transmitted as DTMF number sequences. There are eight Code Memories (independent of channel memories and the VFO) numbered 1 ~ 6, C and P, which all store 3-digit DTMF paging codes.

3-Digit DTMF Code Memories	
CH	USE
1 - 6	Individual ID code of stations you wish to call or monitor stored here.
C*	Automatically shows ID code of paging station — Rx-only, cannot be written to.
P*	Your personal ID code is stored here.
*memory cannot be selected for page-code inhibit	

Your receiver remains silent until it receives three DTMF digits that match those stored in one of its code memories. The squelch then opens so the caller is heard, and the paging ringer sounds (see page 68-69). When you press the PTT, the same three pre-stored DTMF code digits are transmitted

automatically. In the paging mode, *three more DTMF digits are sent*, representing the 3-digit identification code of the transmitting station.

Like the CTCSS Bell system described previously, the DTMF Paging and Code Squelch systems are selected by pressing . Either the *PAGE*, *T.PAGE* or *CODE* icon appear when DTMF paging, trigger paging or code squelch is activated, respectively. The following descriptions begin with an overview of the various DTMF selective calling features, followed by details of actual operation.

### DTMF Code Squelch

The code squelch mode is very simple: both you and the other station communicate using the same 3-digit DTMF sequence, sent automatically at the start of every transmission. Your receiver remains silent to all signals that are not prefixed by your selected 3-digit code. When you receive the matching tone sequence, your squelch opens and stays open until a few seconds after the end of their transmission.

In the code squelch mode, you must first store and then manually select the one Code Memory holding the 3-digit DTMF code required to open your squelch (described on page 67). Also, in the code squelch mode, Code Memories 1 ~ 6 always function the same — the distinctions and special settings described next for the paging mode do not apply.

### DTMF Paging

Standard DTMF Paging uses a specially formatted string of 7 DTMF digits (see below). With DTMF paging, you can receive signals that are prefixed with your personal 3-digit code, or any of up to six other 3-digit codes.

DTMF PAGING FORMAT						
Code of Called Station			Flag	Code of Calling Station		
1	2	3	*	4	5	6
DTMF String (7 digits in length)						

When you receive a paging call, the selected Code Memory changes automatically, and the way the display responds depends on which paging code was received. The key to using DTMF paging in the FT-8500 is first understanding how the Code Memories are used.

### Code Memory P (Personal Code Memory)

You must choose a 3-digit code to identify your station, and store it in this Code Memory. You can share this code with your friends, club members or anyone you want to be able to reach you by paging.

When a station transmits your personal 3-digit code, the receiver squelch opens, the ringer responds (page 68), and the 3-digit code of the station calling is stored in Code Memory C. At the same time the



frequency display changes to show the contents of Code Memory C - which always contains the identity of the calling station.

### Code Memories 1 - 6

Codes of up to six other stations can be stored in these memories. These are stations you expect to frequently contact, and whose page calls you also want to receive. Members of a common group or club usually share a common 3-digit paging code so that they can be paged simultaneously.

If the paging code received is *not your personal code*, but matches one of those stored in Code Memories 1-6, the transceiver still responds as before, but the display now shows the code memory of the *station that was paged* (rather than the calling station's ID).

### Code Memory C

This is reserved for only one purpose - to store the calling station's 3-digit ID code for later display. This code memory is *read-only* and cannot be used to manually store codes like memories 1-6 & P.

If a station pages your personal 3-digit code (stored in code memory P), the transceiver *automatically* reverts to code memory C and displays the caller's ID. If the paging code matches one of the other codes stored in code memories 1-6, the calling sta-

tion's ID is *still* entered in code memory C, however, you have to *manually* recall it for viewing.

Note that Code Memories 1-6 are used to store codes for calling purposes only, or for both calling and receiving, as you desire.

Remember, with Code Squelch operation (but not with DTMF Paging), you can only receive a call on the currently selected code memory, and the display does not change when a call is received. So for code squelch, as mentioned before, the code memory distinction does not apply (although you must still store the 3-digit Code Memories).

In either code squelch or paging modes, any DTMF-equipped station can call you. They can use a DTMF keypad to send the three digits if you are in code squelch mode, or seven digits (actually, three digits—"star"—three digits, e.g. 1 2 3 \* 4 5 6) if you are in paging mode.

### DTMF Code Monitoring

When a 3-digit DTMF code is received during Code Squelch or DTMF Paging operation, it is automatically written into code memory C. By selecting this code memory as described next, you can view what DTMF code was last heard, whether or not it opened your squelch.



### Configuring Code Memories

The first thing to do before using DTMF Paging or Code Squelch is to store your personal 3-digit code in Code Memory P. Although up to six other code memories can be stored, you might only need a few of them to call your friends or a specific group. Likewise, you'll probably only want your radio to respond to pages directed to you (or maybe your group or club's code). When storing code memories using the procedure on page 65, you choose whether your transceiver should respond to paging calls for the codes in memories 1-6 (code memories P & C, however cannot be modified). Remember that the field entry at the far right determines whether DTMF Code Squelch or Paging operation will respond to the 3-digit code stored in this memory.

After entering the 3-digit code, move to the right and use the joystick to toggle the field selection to either **ENABLE** or **DISABLE**. You can also have a small underbar appear in the display for code memories enabled to receive paging calls with the One-Touch paging feature (covered later).

As mentioned above, code memory P cannot be disabled, since this is your own ID (that you will always want to receive when paging is activated). Likewise, code memory C cannot be enabled, since this is reserved for displaying incoming codes only.

Once you have stored your 3-digit ID in code memory P, you can activate the paging or code squelch func-

tions from the normal frequency display by pressing **PAGE**. As mentioned earlier in the CTCSS Bell procedure, repeatedly pressing this key cycles through DTMF paging (**PAGE** displayed), trigger paging (**T.PAGE**), code squelch (**CODE**), CTCSS Bell paging (**▼**), and no paging (none of these symbols).

### DTMF Code Squelch Operation

As described earlier, with DTMF code squelch activated (**CODE** displayed), your squelch will not open until you receive the proper 3-digit DTMF code according to the selected code memory. Likewise, each time you press the PTT, the same 3-digit code is automatically sent to open the other station's DTMF coded squelch.

### DTMF Paging Operation

Any DTMF-equipped station can call you by sending your 3-digit code, followed by their 3-digit ID Code. When a valid paging tone sequence is received, several things happen:

- The ringer sounds (unless you disabled it, as described on page 69).
- The **PAGE** icon blinks, and the 3-digit ID code of the *calling station* appears in the frequency display. This code is now stored in code memory C.

If you press your PTT switch after receiving a page, the transceiver sends the other station's ID code, a DTMF "star" (\*) followed by your own 3-digit per-

sonal ID code (code memory P) all automatically, and then resets the radio to receive another call.

Unless you are using the Trigger Paging function (covered next), you may want to switch from paging to code squelch mode once contact is established. Just press **[CODE]** once, so that **CODE** appears. Either you or the other station will also have to select code memory C, so that you will both be using the same DTMF code (either, but not both, must re-select their Code Memory).

With the Code Squelch activated in this manner, you will hear three DTMF code digits transmitted when you press your PTT switch. These are the digits stored in the currently selected code memory (and displayed in place of the 100's-of-MHz digit if One Touch Paging option is enabled), and that open the squelch of the other station.

Therefore, at the start of each transmission, you must wait a second or two after pressing the PTT switch for the DTMF code to be sent (you will hear it in your speaker).

When you finish your conversation, if you need to reactivate DTMF Code Paging, press **[PAGE]** until **PAGE** is again displayed.

### Trigger Paging

This feature overcomes the inconvenience of manually switching to and from Code Squelch operation when responding to a page. It can only be used between transceivers equipped with this feature: such as the Yaesu FT-11R/41R and FT-51R.

To activate Trigger Paging, press **[CODE]** repeatedly until **T.PAGE** is displayed. When a call is received, **T.PAGE** blinks, and the alert ringer sounds. If the other station is also using Trigger Paging, communications can begin just by acknowledging the page: press the PTT and begin talking within three seconds after the DTMF code sequence is sent. The pager resets to receive a new call as soon as either station fails to respond to the other within three seconds.

### One-Touch Paging

If you prefer, you can enable the One-Touch Paging feature, and have the code memory number displayed in place of the 100's-of-MHz frequency digit whenever DTMF Code Squelch, DTMF Paging, or Trigger Paging is enabled. The rest of the frequency digits remain as before, except for the separator decimal (see below).

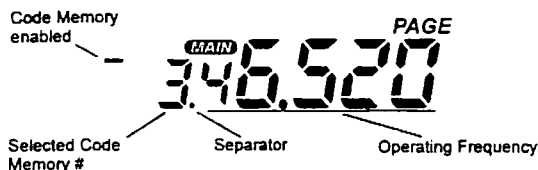



In addition, one touch of the **(A)** and **(B)** keys now select *code memories*, instead of tuning or scanning as before (D/MR operation remains unchanged). Each press displays the selected code memory setting for a second, then returns to the channel display.

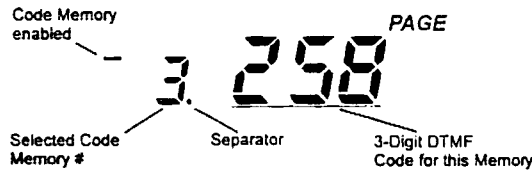

To free up (display) the 100's-of-MHz frequency digit for tuning/scanning while in these modes, you may prefer to disable One-Touch Paging. DTMF Codes are now only displayed after receiving a page (or in the code memory menu programming). One-Touch Paging is enabled/disabled by menu programming, explained on page 69.

### Paging "Answer Back"

When you press the PTT to respond to a page call, the caller's ID code, followed by a DTMF "\*" and your personal ID code, are transmitted. This informs the calling station that their page was received. If you prefer, you can have the FT-8500 respond *automatically* (transpond) to received calls using the answer-back feature.

There are two choices for automatic response - *Answer-Back* and *Page Forwarding*. As mentioned be-

fore, the answer-back mode acknowledges a received page by "paging back" the calling station (just as if you manually selected their 3-digit station code and pressed the PTT). Page Forwarding takes a received DTMF paging string and re-transmits the *original* sequence (rather than reversing the ID code pair as in answer-back format), relaying the call to extend your paging range. The graphics on page 47 illustrates the difference between these modes.

You can leave your FT-8500 with this mode enabled in your vehicle, office or other vantage point when you are temporarily away, but will be using another transceiver and don't want to miss any paging calls.

To enable this feature refer to the Menu Programming section on page 68.

### Paging Tx Delay

When calling other stations using DTMF Paging or DTMF Code Squelch, particularly through repeaters, you may find that some stations are unable to receive your calls. This can be caused by their squelch not opening fast enough (after receiving your transmitted carrier) to allow all of the DTMF digits to be received and decoded.

To correct this problem, you can set a longer delay between the time your transmitter is keyed and the first DTMF digit is sent.

Refer to page 68 for to change the default delay of 450 msec to a longer delay (750 or 1000 msec).

## Sending DTMF Messages

This feature uses DTMF signaling to send messages to stations with transceivers equipped for message reception, such as the Yaesu FT-11/41R & FT-51R. This feature is *independent* of DTMF Paging described previously and you aren't required to first page a station in order to send them a message.

### Message Format

The FT-8500 contains a bank of ten Tx message memory "slots" labeled 1-9 and 0 (which is reserved for holding your personal ID, etc). Any of the numbers, letters or symbols from the sixty alphanumeric-character set (page 48) can be used in message and ID text.

Tx Message Bank	
Slot No.	Messages
0	YAESU (ID slot)
1	QSY U
2	QSY U
3	QSY
4	SIMPLX
5	GO2RPT
6	IN CAR
7	AT HOME
8	CALLME
9	EMERG

A separate 9-slot memory bank is used for *incoming* (received) message storage. Once received, these messages are automatically stored to be recalled and viewed later.

Message are sent using a simple format: the message text is composed of up to eight DTMF characters, always preceded by and ending with a DTMF "#" character, as shown below.

Flag	TX Message TEXT & ID Format (up to 8 characters)	Flag
#	CALLHOME	#

The DTMF # flags used at the beginning and end are significant because they identify the DTMF string contained within as a message when decoded. The FT-8500 automatically formats your message with # flags, so you only have to enter text as you would like it to appear.

The reserved ID slot uses the same format, and is basically just another message slot. However, when the receiving station is set up for message and ID reception, it will be handled (and displayed) separately.

There are ten factory-programmed Tx messages (including the ID slot), as shown in the table. You can store your own personal ID in slot 0 and customize slots 1-9 with messages of your choice by following the procedure outlined on page 66-67.

### DTMF Message Operation

When sending messages, you can have your ID included along with the message, and have their ID displayed when you receive a message (if they include it). Also, "MSG" or else "MSG ID" appears at the lower left of the display, indicating if one or both are to be sent (and displayed). Message or message+ID operation is selected and enabled in the programming menu on page 66.

With message mode activated, you operate as before (there is no requirement to have DTMF paging or CTCSS turned on). Message operation remains transparent until a properly formatted DTMF sequence is received. When this occurs:

- The message is stored into an open slot in the receive message bank. Up to nine messages are stored in the order received, and can be recalled later.
- A display header appears, showing the message (and ID if enabled), which band it was received on, and the slot it is now stored in (1~9). If the CW Monitor is enabled, the message is decoded and played back in Morse (see page 67).
- In either case, the message header remains until **MSG** is pressed *twice*.

Vacant slots can be filled with up to nine messages, subsequent messages are queued and *overwrite* filled slots on a *first-in, first-out* order. If you do not want stored messages overwritten, this can be dis-



abled and **MSG FULL** appears after the ninth message (see page 67). To view messages, press **MSG** and recall message slots using joystick (up/down), the DIAL knob or **A/B** keys. Empty message slots are indicated by <BLANK>.

### Sending Messages

Before sending a message, inform the other station to switch their transceiver into its message reception mode. With that done, any stored messages can be sent using the following procedure:





- Hold the PTT and press **MSG**, the display changes to show the currently selected message slot.
- Use the numbered keys or the **A/B** button to selected the desired message slot to send, then press **MSG** and release the PTT. You will hear the DTMF message string (and ID if selected) as it is being sent.

### Sending Messages Manually

If you do not have a particular message in memory (or the time to store it), you can send it manually by using keypad button combinations. As explained before, message format consists of a DTMF # followed by up to eight message characters, ending with an

additional #. When sending a pre-stored message, the #'s are automatically inserted. When sending messages manually, however, *remember to include these.*

Unlike DTMF numerals, which are entered with a single key, letters of the alphabet and other symbols each require a *two-button key sequence*. For example, generating the letter P requires manually entering 7→A. The table on page 49 shows the key sequences required to generate each of the available characters.

- ☐ Press and hold the PTT during the message string; press , followed by your message (up to eight characters), then  again before releasing the PTT. If sending an ID string immediately follow with an additional , the ID text (up to eight characters), then  to finish.

### Customizing Ringer Settings

The transceiver's ringer responds CTCSS Bell, DTMF Paging or DTMF Message calls according to how it is configured via menu programming. Three types of ringer melodies are available:

- Beeper Melody (factory-programmed)
- User-programmed Melody
- CW Monitor

The CTCSS Bell & DTMF Paging Ringer can be enabled to repeat the selected melody (or Morse

announcement) 1, 3, 5 or 8 times when a call is received, or disabled.

The DTMF Message ringer can be enabled or disabled. The User-Melody is stored in DTMF Auto-Dial Memory USER (reserved for this purpose), and is explained in detail shortly. The CW monitor decodes incoming DTMF tones and replays them via the internal speaker to alert you to incoming calls and their message. The CW playback speed is selectable from approximately 5 wpm to 25 wpm (see page 72). The chart shows possible ringer settings.

<u>Ringer Function</u>	<u>Repetition (on/off)</u>	<u>Melody Selection</u>
CTCSS Bell	Off 1, 3, 5, 8	{ CW Monitor Internal User
Paging Ringer	Off 1, 3, 5, 8	{ CW Monitor Internal User
Message Ringer	Off On	CW Monitor

To configure the CTCSS Bell, Paging/Message Ringer and CW Monitor, refer to pages 68-70.

## DTMF Autodialer Operation

Ten autodial memories, labeled 1 ~ 9 and USr store DTMF tone sequences of up to 16 digits each. Memory USR is reserved for storing a user-composed ringer melody, and is covered shortly. You may assign a name up to 6 characters to each DTMF autodial memory, to be displayed when the memory is recalled. This can help you to identify whose numbers you have stored. The same character set and procedure is used for autodialer memory naming. Autodialer memories can be used for remote DTMF control sequences or telephone numbers for repeater or personal autopatch systems.

The DTMF autodial memory feature is toggled on or off via menu programming and  is displayed at the center of the lower display when autodialing is activated. To store DTMF Autodialer Memories and enable the function, refer to page 65.

### Using the Autodialer

- To play back DTMF auto-dial memories on the air, first make sure the DTMF memory mode is activated ( is displayed). Then close the PTT switch and simply press the number of the auto-dial memory to transmit. Once the DTMF sequence has begun, you may release the PTT (the transmitter stays keyed until the auto-dial string has been sent).

### Note!

With the DTMF Auto-Dialer active, the keypad cannot be used to transmit individual DTMF codes. If you do not have the required DTMF sequence stored in memory, turn the Auto-Dial mode off, then manually enter the desired DTMF codes.

### Composing the Ringer User-Melody

The default ringer with CTCSS Bell or DTMF Paging operation is factory programmed. You may compose your own melody if desired, and store it in a special DTMF Autodial memory reserved for this purpose (memory USR). When enabled, the user-melody plays instead of the factory melody. Refer to page 65 to enter your own melody.

### APO (Automatic Power-Off)

This turns the transceiver off after 1~12 hours of key or PTT inactivity\*. APO is activated using the routine on page 70. Afterwards,  appears in the display, and a timer starts every time you press a key. If you don't press any keys for the selected time-out period, and as long as you are not scanning or priority monitoring, the transceiver turns off. After that, you must switch the transceiver back on for use. You can deactivate the APO feature via menu programming, so the display shows OFF. **\*Note: Tx during Packet and X-Band Repeater operation will not reset the APO (but pressing a key will).**

### Transmit Time-Out Timer (TOT)

This limits Tx time after the PTT is held (1~60 mins), after which the transmitter automatically un-keys (even if the PTT is still held). To reset the timer and transmit again, the PTT must first be released. This feature is useful to limit long key-down periods when the cross-band repeater feature is enabled, or in the event of a stuck microphone (wedged between the car seats, for example).

The TOT is menu-enabled (page 70); select a timer duration of 1~60 mins or OFF. When active, TOT appears between the channel displays.

### Checking the Battery or DC Supply Voltage

The battery or DC supply voltage can be displayed in place of the sub channel frequency or momentarily checked in the Programming Menu (page 71).

### Disabling the Keypad Beeper

You can turn off the keypad beeper that sounds whenever a key or button is pressed on the FS-10 Smart Controller unit. If you lock the keypad, each key will sound a different musical note for as long as it is held. Refer to page 71 in the Menu Programming section to enable/disable the beeper.

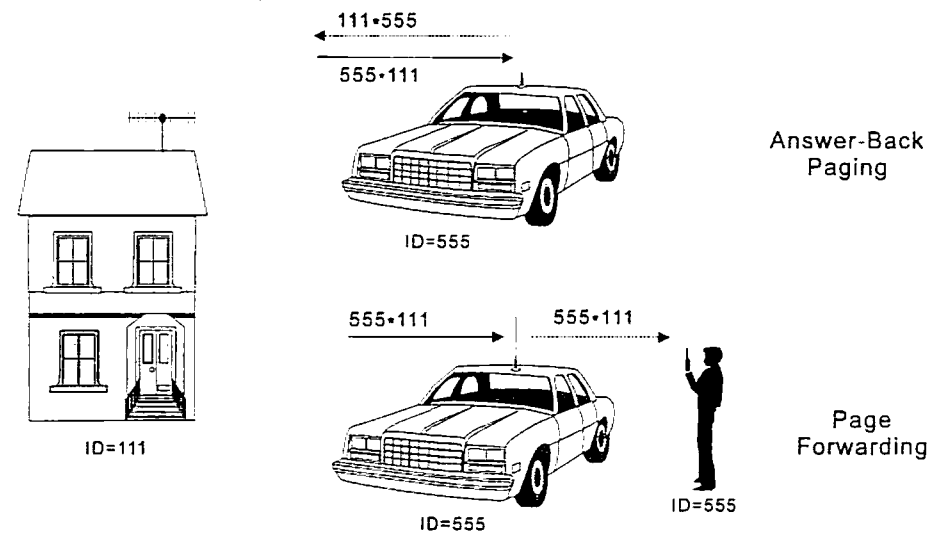

Automatic "Answer-Back" Paging (see page 42).

annot  
ou do  
mem-  
enter:

: Paging  
ompose  
e it in a  
for this  
ne user-  
Refer to

rs of key  
ie routine  
e display,  
ey. If you  
ut period,  
or priority  
that, you  
. You can  
ramming,  
ng Packet  
reset the

Alphanumeric Character Set

Note! Characters within the thick boundary line are Japanese kana, and are used in domestic Japanese transceiver versions. While selecting and entering characters for memory names, you can instantly return to the first character of a set (shown in the shaded boxes) by simply pressing **HOME**, instead of using the joystick. Also, you can move among first characters in each set by pressing **SCAN**.

( )	+ -	= *	/ △	⊕	Σ	:	!	?	%	&				
_	⌘	⌘	\ ;	< >	■	a	b	c	d	e	f	g		
h	i	j	k	l	m	n	o	p	q	r	s	t	u	v
w	x	y	z	ア	イ	ウ	エ	カ	キ	ク	ケ	コ	サ	
シ	ス	セ	ソ	タ	チ	ツ	テ	ト	ナ	ニ	ヌ	ネ	ノ	ハ
ヒ	フ	フ	ホ	マ	ミ	ム	メ	モ	ヤ	ユ	ヨ	ラ	リ	ル
レ	ロ	ワ	ヲ	ヅ	ヰ	ヱ	ヲ	ン	ヴ	ヵ	ヶ	ヷ	ヸ	ヹ
0	1	2	3	4	5	6	7	8	9	A	B	C		
D	E	F	G	H	I	J	K	L	M	N	O	P	Q	R
S	T	U	V	W	X	Y	Z	Space						

















0	0	A	2	→	Ⓐ	N	6	→	Ⓑ	space	1	→	Ⓒ	?	0	→	Ⓓ
1	1	B	2	→	Ⓑ	O	6	→	Ⓒ	(	0	→	Ⓐ	%	1	→	*
2	2	C	2	→	Ⓒ	P	7	→	Ⓐ	)	0	→	Ⓑ	&	2	→	*
3	3	D	3	→	Ⓐ	Q	1	→	Ⓑ	+	0	→	Ⓒ	-	3	→	*
4	4	E	3	→	Ⓑ	R	7	→	Ⓐ	.	1	→	Ⓓ	\$	4	→	*
5	5	F	3	→	Ⓒ	S	7	→	Ⓒ	=	2	→	Ⓓ	%	5	→	*
6	6	G	4	→	Ⓐ	T	8	→	Ⓐ	*	3	→	Ⓓ	\	6	→	*
7	7	H	4	→	Ⓑ	U	8	→	Ⓑ	/	4	→	Ⓓ	:	7	→	*
8	8	I	4	→	Ⓒ	V	8	→	Ⓒ	∇	5	→	Ⓓ	>	8	→	*
9	9	J	5	→	Ⓐ	W	9	→	Ⓐ	∏	6	→	Ⓓ	<	9	→	*
		K	5	→	Ⓑ	X	9	→	Ⓑ	∑	7	→	Ⓓ	■	0	→	*
		L	5	→	Ⓒ	Y	9	→	Ⓒ	:	8	→	Ⓓ	.			
		M	6	→	Ⓐ	Z	1	→	Ⓑ	i	9	→	Ⓓ				

Alphanumeric Character Key Code Table

## Power-On Settings

Some transceiver default operational settings can be enabled/disabled, changed or reset using a power-on procedure. This requires holding a particular key (or key combination) depressed while turning the transceiver on, as outline in the table below. For detailed explanations on how these affect transceiver operation refer to the page(s) listed in the far right column.

### Power-On Settings and Functions

Press and hold the following key(s) while turning the transceiver on.	Operational Effect or Setting Enabled	Ref. Page
	Enables Cross-Band Repeat Mode (bi-directional repeat).	52
	Enables Transceiver Cloning Mode.	53
 & 	Enable Extended Receive (110–174 MHz & 410–500 MHz).	29
 &  & 	Reset CPU and all operational settings to factory-default.	54
 & 	Activate Memory-Only mode.	32
	Adjust Memory Bank Ratio for VHF and UHF.	30
 &  & VHF volume knob	Reset VHF memories to factory-default settings.	54
 &  & UHF volume knob	Reset UHF memories to factory-default settings.	54



# APPENDIX

## Packet Radio Operation

The FT-8500 provides a convenient rear-panel DATA jack for easy TNC interconnections. Refer to the graphic for pin-out connections.

When the DATA jack PKS line is grounded, data transmission is enabled and the FS-10 microphone circuit *is disabled during transmit*. However, keying the FS-10 PTT at the same time defeats this and a "live mic" will occur, so be careful. Band selection and data rate (1200/9600 BPS) can be selected via the programming menu on page 72.

**Note:** Tx and Rx audio via the DATA jack is determined by menu programming (\*40: DATA JACK SELECT), even if the main channel indicated by **MATN** is the other band.

To use the FT-8500 for packet, first select the desired band and data rate for operation. Construct or purchase a patch cable for connection between the FT-8500 and your TNC and refer to the table at the right for complete level and switching information. If your TNC uses a PLL-type DCD (Data Carrier Detect) circuit, you may not require the squelch status input from pin 6 (SQC).

DATA JACK PIN CONNECTIONS		
PIN	LABEL	NOTES
1	PKD	<i>Packet Data Input:</i> Impedance: 10 kΩ Max. Input Level: 40 mVpp @ 1200 bps 2.0 Vpp @ 9600 bps
2	GND	<i>Signal Ground</i>
3	PKS	<i>Packet Send: PTT switching:</i> <i>ground to transmit-FS-10 mic circuit</i> <i>disabled during data transmission.</i>
4	RX9600	<i>9600 bps Packet Data Output:</i> Impedance: 10 kΩ Max. Output: 500 mVpp @ 9600 bps
5	RX1200	<i>1200 bps Packet Data Output:</i> Impedance: 10 kΩ Max. Output: 300 mVpp @ 1200 bps
6	SQC	<i>Squelch Control</i> Squelch Open: +5V (TTL) Squelch Closed: 0V (TTL)

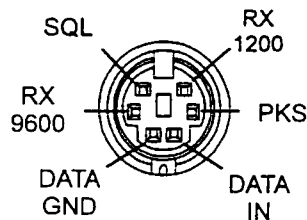

(as viewed from the rear panel)

wer-on  
sceiver  
refer to

Page
52
53
29
54
32
30
54
54

## Cross-Band Repeater Operation

The FT-8500 can be set up to operate as a full-featured cross-band repeater with a simple power-on procedure. This feature is useful for field-day, club station or emergency operation in remote areas, and for cross-band linking. However, remember these few points before using the cross-band repeater function.

- Check with amateur rules and regulations to ensure this type of operation is permitted in your country.
- Pick your frequency pair carefully, so as to not interfere with existing repeaters in operation, cross linking two repeaters on two separate bands may cause a lot of havoc, and may be illegal! If you are not sure of active repeater frequencies, a safe rule is to stay off of the repeater sub bands and use the simplex portion of each band. *Contact the frequency coordinator for your area for guidance.*
- Remember that the Tx duty cycle will probably be much greater than before, so use a low Tx power output setting for cooler operation.

Transceiver CTCSS settings (encode/decode) can still be selected for each band, so you can make your repeater "closed" if desired.

- Before enabling cross-band repeat, configure both channel settings as desired. Then, hold **[MFR]** while turning on the power. The display shows **X-BAND RPTR ON/OFF**.

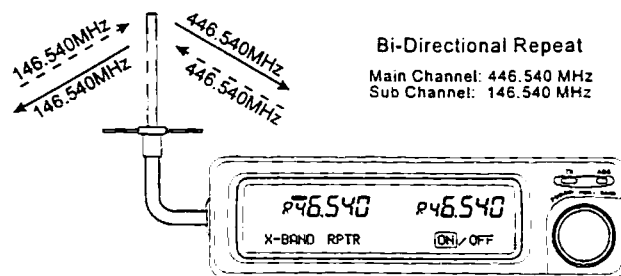

- Move the joystick to the left to select **[MFR]**, turn the transceiver off, then on again.
- For cross-band repeat you do not need to select the main channel, as this changes depending on which channel the input signal is received on. The **[MAIN]** icon automatically switches to show which channel the FT-8500 is transmitting, or you can glance at the meter to see which side is transmitting and receiving.

To exit the cross-band repeater mode, turn the transceiver off, repeat the appropriate power-on sequence, and select **[OFF]**.

### Transceiver Cloning

You can transfer all data stored in one FT-8500 to another set automatically by a cloning procedure. This requires a user-constructed cable to connect the DATA jacks on the two transceivers as shown below.

- Now insert the clone cable into the DATA jack of each transceiver.
- Turn both units off, then press and hold the **MEM** key of each radio while turning the power on again. **<CLONE MODE>** appears on the display.

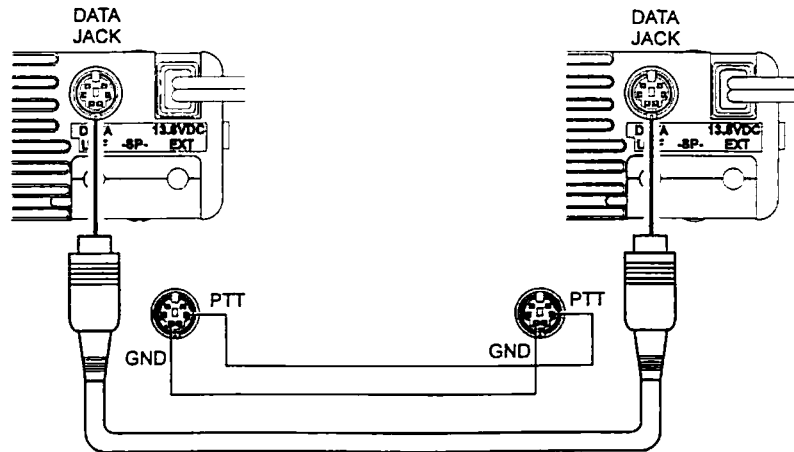

- On the destination transceiver, press **[REV]**, the display shows **<WAITING DATA>**. Next press **[RPT]** on the source transceiver so the display shows **<SENDING DATA>**. After successful data transfer, **<CLONE DATA>** appears again on both transceiver displays. If there was a problem, **<ERROR>** appears on the display, recheck your cable and then turn both transceivers off and try again.
- Remove the cloning cable. Channel and operating data for both transceivers are now identical.



## In Case of Problems

Don't worry if you find transceiver operation somewhat complicated at first. You might find yourself temporarily lost, at least until you have had the chance to learn the various functions of the display and keys. This section provides some tips to help you navigate the various display and key modes if you get stuck.

If the display shows nothing at all, check the power switch, and power supply, fuses and cables. If two beeps sound unexpectedly when you transmit, check for a small "+" or "-" near the top center of the display, indicating that the operating frequency, with the selected repeater shift, is resulting in an out-of-band Tx frequency.



Invalid key entries usually do nothing, and no beep sounds. However, if the keys are locked, nothing happens when you press a key for even valid commands. Check for  (key, DIAL & joystick lock) or  (PTT lock) in the display. If you see one of these, slide the LOCK switch, or check the lock configuration in menu programming.

If you still cannot enter data, check to see if TX LED is red, indicating the transmitter is activated. Releas-



ing the PTT switch should return the set to receive. If not, switch the transceiver off, and then back on.

If a 1 does not appear in the 100's-of-MHz digit place on the VHF band, or a 4 on the UHF band, or if the transceiver behaves strangely when you try to tune, check for either *PAGE*, *T.PAGE* or *CODE* above the frequency display, indicating that DTMF Paging, Trigger Paging or Code Squelch is active with the code memory display option. If so, press , several times if necessary, to clear these symbols and return the frequency display to normal.

### Resetting Memories

To reset the VHF and UHF programmed memories, hold  &  with the respective band's volume knob depressed while turning on the transceiver.

### Resetting the CPU

- As a last resort, if you are unable to gain control of the transceiver, the FT-8500 can be reset from the keypad to clear all settings, memories, channel step and repeater shifts to their factory defaults. Just press and hold  and  together while turning the transceiver on.

# Personal Computer Control Operation

## Introduction

The PCC (Personal Computer control) System in the FT-8500 provides control of frequency, VFO, memory, and other settings using an external personal computer. This allows multiple control operations to be fully automated as single mouse click or key-stroke operations on the computer keyboard.

You will need the optional FIF-232C Interface Box for PCC operation. This device connects between the transceiver DATA jack and computer, and converts the digital signal levels for proper data transfer. When the command instruction activating PCC operation is sent from the computer via the FIF-232C, <PCC ON> appears in the display.

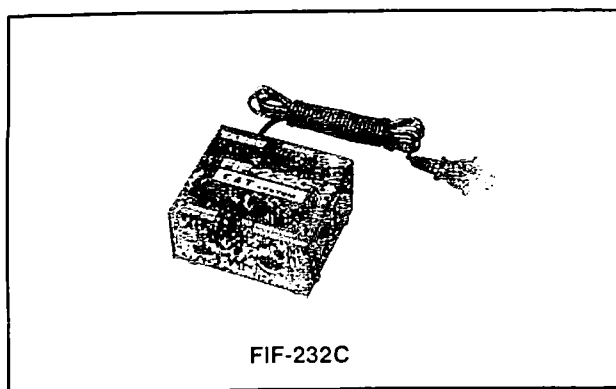

The cable connecting the transceiver to the FIF-232C is supplied, however, you will need a serial cable for connection to the RS-232C (serial or COM port) connector on your computer. Purchase a standard serial cable (not the so-called "null modem" type), ensuring it has the correct gender and number of pins (some serial COM port connectors use a 9-pin rather than 25-pin configuration). If your computer uses a custom connector, you may have to construct the cable. In this case, refer to the technical documentation supplied with your computer.

Yaesu Musen does not produce PCC System operating software due to the wide variety of personal computers and operating systems in use today. However, the information provided in this chapter explains the serial data structure and opcodes used by the PCC system. This is intended to help you start writing programs on your own. As you become more familiar with PCC operation, you can customize programs later on for your operating needs.

There are commercially produced software packages available, and various shareware and freeware programs. To find out more information, contact your dealer or check advertisements in current amateur radio journals and publications. Other valuable information sources include amateur radio and PC users-groups, packet radio and PC bulletin boards (BBS), and amateur radio swap-meets (hamfests).

### PCC Data Protocol

Serial data is passed at TTL levels (0 /+5V) via the DATA IN & DATA GND pins of the DATA jack on the rear panel of the transceiver, at 9600 bits/sec. (see the DATA jack pinout shown to the right).

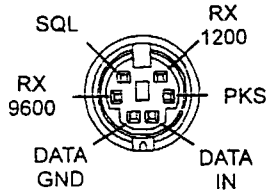

(as viewed from the rear panel)

Each byte sent consists of one start bit, 8 data bits, no parity and two stop bits:

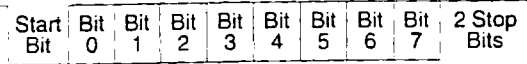

One byte, sent left-to-right

All transceiver settings and operating features can be enabled and programmed by sending commands in hexadecimal code to the transceiver CPU via the FIF-232C interface. The coding table to the right lists all functions (and their FS-10 button equivalent) with the corresponding hexadecimal code.

#### Using the PCC Command Coding Table

To use the coding table, first choose which function or button you wish to emulate. Next locate its corresponding hexadecimal code by reading the table *column first, row last* be sure to remember this se-

### PCC Command Coding Table

	0	1	2	3	4	A	F
0	⓪	Ⓜ	Ⓝ	(1)			hold
1	Ⓛ	Ⓟ	press	(1)			
2	Ⓜ	Ⓠ	up	(1)			
3	Ⓨ	Ⓡ	down	(1)			
4	Ⓩ	Ⓢ	right	(1)			
5	ⓐ	Ⓣ	left	(1)			
6	ⓑ	Ⓤ		(1)			
7	ⓐ	Ⓥ		(1)			
8	ⓑ	Ⓦ		(1)			
9	ⓐ	Ⓧ		(1)			
A	ⓐ	Ⓨ		(1)		PCC ON	
B	ⓑ	144		(1)		PCC OFF	
C	Ⓒ	430		(1)			
D	Ⓓ	Ⓟ		(1)			
E	Ⓜ	Ⓡ		(1)			
F	Ⓨ	Ⓣ		(1)			

(1) Note

bit 0	bit 1	bit 2	bit 3	bit 4	bit 5	bit 6	bit 7
*1	*2	*3	*4	1	1	0	0

For \*1, \*2, \*3 and \*4: 0=PTT off, 1=PTT on

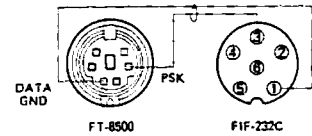





**Example:** Activate continuous-sweep spectrum analyzer operation.

- Using the FS-10, the  button needs to be *held* to enable continuous sweeping, (single sweep activates if it is only momentarily pressed). Referring to the PCC Commands Table, preceding a button code with F0h (press & hold) simulates holding that button for 1 second.

In this case the command to activate continuous-sweep spectrum analyzer operation is:

F0h 19h

**Note:** Also remember that some functions may have more than one unique opcode instruction.

For example, upward scanning can be started by either *holding* , or pressing . Therefore, an opcode instruction of either F0h 0Ah or 17h would both be valid and produce the same result. Programming structure dictates which would be more efficient for the transceiver operation involved.

## Writing Programs

### Coding Examples

Although Yaesu Musen Company does not offer PCC control programs (due to the variety of incompatible computers used by our customers), the following is an example of a PCC command, in BASIC programming language. Note that all variations of BASIC may not support some of the commands, in which case alternate algorithms may need to be developed to duplicate the functions of those shown.

### Sending a Command

After "opening" the computer's serial port for 9600-baud, 8 data bits and 2 stop bits with no parity, as i/o device #2, any PCC command may be sent.

Notice that the instruction opcode is sent in the same order in which they appear in the PCC Commands table.

For example, the following command could be used to set the frequency of the display to 145.520 MHz:

```
PRINT #2,  
CHR$(&H1B); CHR$(&H01);  
CHR$(&H04); CHR$(&H05);  
CHR$(&H05); CHR$(&H02);
```

Sending a parameter that is out of range for the intended function, or not among the specified legal values for that function should do nothing.

## FTS-22 Tone Squelch Unit Installation

The FTS-22 includes dual decoders for 39 user-selectable EIA standard subaudible CTCSS tones. It provides silent monitoring of busy channels when activated (*ENC/DEC*). See the page 36 & 64 for operational and tone selection.

- ❑ Disconnect the power cable, and turn the set upside-down. Referring to Figure 1, remove the six screws affixing the bottom cover.

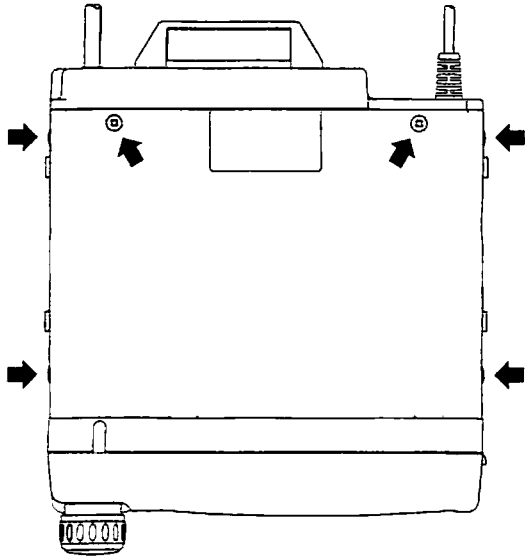

Figure 1

- ❑ Referring to Figure 2, locate the unused 12-pin connector inside the front panel. Plug the FTS-22 cable into the connector.
- ❑ Peel the covering from one side of the double-sided tape provided with the FTS-22, and stick it in the bare area on the printed circuit board.
- ❑ The factory adjusts the output tone level (VR1 on the FTS-22) for the proper deviation, so it should require no further adjustment.
- ❑ Replace the bottom cover and six screws.

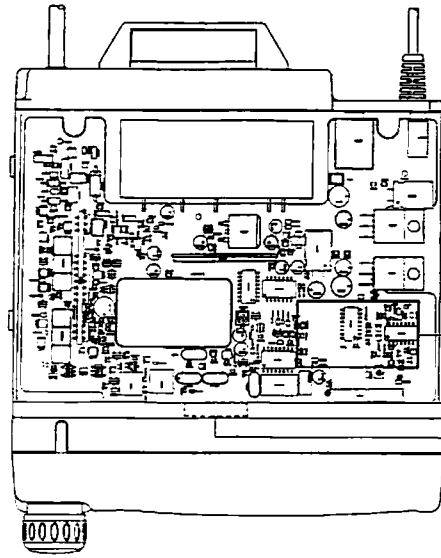
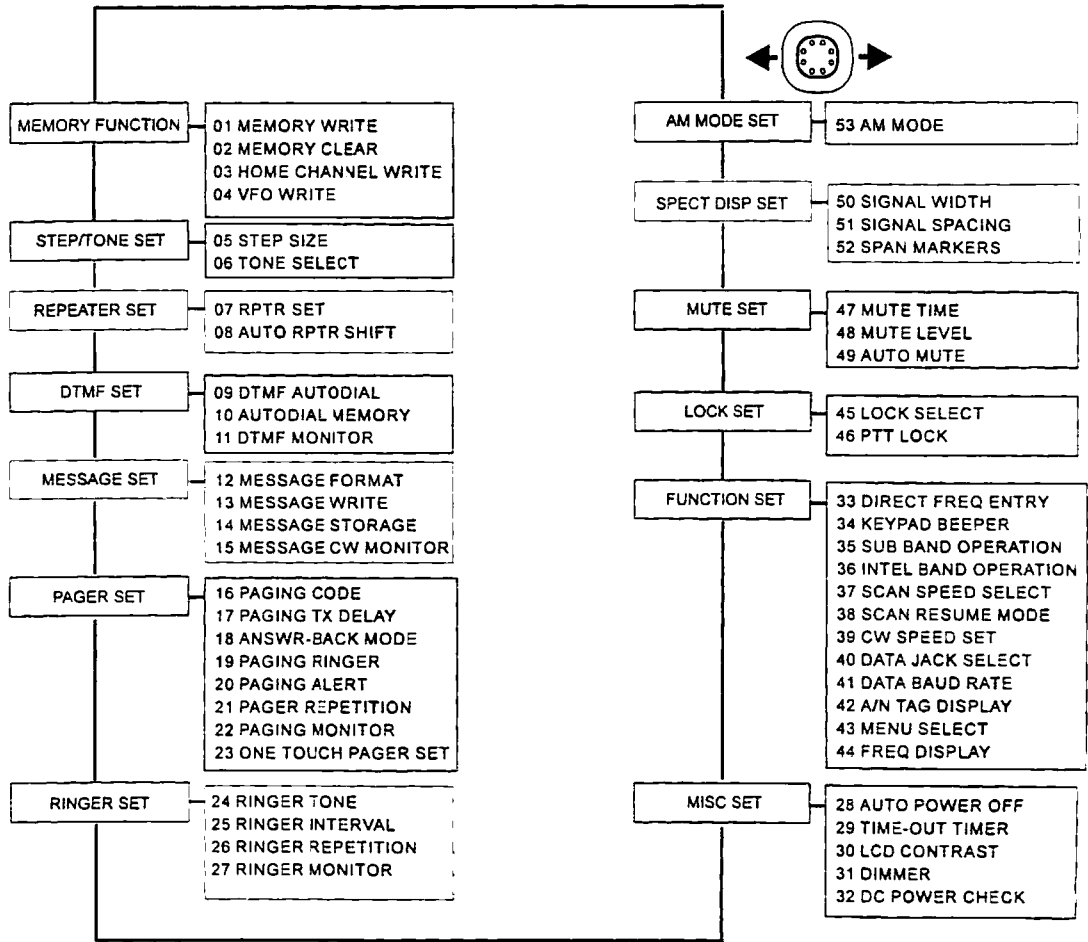
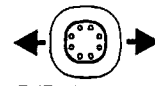
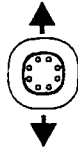

Figure 2

FTS-22  
Mounting  
Location  
12-pin  
Connector





# Menu Programming and Custom Settings



In the last chapter, basic and advanced operation were covered to enable you to quickly get on the air and show the various transceiver features. This chapter covers all of the menu entries and selection settings used by the transceiver. These functions were described previously, but must be configured as desired using menu programming. Menu and entry headings are shown as they appear in the display to assist you as you go along.

## Menu Organization

Fifty three transceiver settings are contained in one of thirteen menus (refer to the menu loop shown on the opposite page). To enable menu selection and programming, press  momentarily.

The lower display heading contained within the   brackets is the *menu title*, and the number inside of the [ ] list how many *entries* are available for the selected menu. Setting for menu entries preceded by a "\*" symbol take effect for both bands, otherwise the setting must be configured twice (once for VHF then again for UHF).

Moving the joystick up/down maneuvers inside the menu loop. When the desired menu appears, move the joystick left or right to display its first entry (some menus have only one entry, while others have as many as twelve). Move up/down to view the other

menu entries. If you know the *number of the entry* you want, you can go directly to it using the keypad. For example, to recall 45:PTT LOCK, simply press  → .



With an entry appearing, you must *press the joystick in* to display its default setting, then once again use up/down joystick movement to select or change a setting. Pressing  saves the entry setting and exits.

Let's begin by doing an example that demonstrates the basic procedure used throughout this chapter.

ex. change the default CTCSS tone to 103.5 Hz.

- First press  to bring up the menu display.

<MEMORY FUNCTIONS> [4]

- Press the joystick up once so that the STEP/TONE SET menu appears. Move the joystick either left or right so menu entries appear, then up or down until 05:TONE SELECT is displayed. **Note:** tone select could also have been recalled directly by pressing  → .
- Press in on the joystick so the default setting - TONE 05 5 Hz- blinks, then move up/down until 103.5 Hz appears. Press the joystick in again to save the entry and return to the original menu or  to exit.

ENTRY  
RATION  
ERATION  
ELECT  
MODE  
ECT  
TE  
AY  
OFF  
ER  
IT  
ECK

This demonstrates the basic maneuvering and entry method used for most transceiver menu-based settings. The remainder of this chapter covers each menu in order with a brief description of entries and their settings. A menu flowchart is provided for your reference on page 60, refer to this as necessary.

## Menu Headings

As mentioned before, the menu "loop" contains 13 headings and a total of 53 entries encompassing most transceiver functions and settings. Entries are numbered and grouped under appropriate headings. A brief explanation of each menu heading, its various entries and their settings follows.



---

### <MEMORY FUNCTIONS> [ 4]

---

There are 55 programmable memory channels for each band. These consist of 50 regular memories arranged into 5 banks, along with 5 special-purpose memories. Memories can be tagged with alphanumeric names (up to six characters in length) if desired. Each memory can store separate receive and transmit frequencies or repeater shift, and CTCSS tone data (also refer to the memory organization table on page). The Home channel memory is recalled instantly by pressing  and L1, U1, L2 & U2 memories can be used in pairs to store the programmable tuning and scanning limit as described on pg. 33-34, in addition to general purpose operation.

#### 01: MEMORY WRITE

- To store a frequency in memory, first select the desired frequency (and repeater split manually, if desired) in the dial mode as already described.
- Press the joystick in so that the memory label blinks. If the memory has not been previously programmed <VACANT> appears, otherwise <AVAILABLE> is displayed. If you select one that is already being used (stored with data), it will be overwritten with new data in the next step.
- Move the joystick up/dwn to select channel groups or L1, U1, L2, U2 & PRI. With a channel group appearing, move the joystick once to the right to "open" up the group, then up/dwn to selecting a specific memory within that group to fill. To attach a name to the memory, proceed to the next step, otherwise press  to save the entry and exit.
- To name the memory, move the joystick to the right so that the first underline blinks. Up/dwn joystick movement selects any of 85 characters (including upper-case and lower-case alphabet, numbers and special symbols). With the desired first character appearing, move the joystick once to the right and select the next character in the same manner.
- After entering the desired name or after six characters, press  to save all data for the channel and exit to the dial mode.

## 02: MEMORY CLEAR

This is used to temporarily erase all data from a previously-programmed memory. Memories can later be restored if needed.

- Press the joystick in so that the small group number blinks.
- Move the joystick up/down then left/right to select the memory to erase or restore. In the lower left display one of three cases appear:
  - <VACANT> indicates the memory has not been previously programmed.
  - <RESTORE> appears for previously written memories which have been erased.
  - <ERASE> indicates memories stored with data but not yet erased.
  - <PERMANENT> only appears on memory 1-0; this memory cannot be erased.
- Pressing **REV** erases and restores selected memories with previously-programmed data. Press **ENT** to save the entry and exit to the dial.

## 03: HOME CHANNEL WRITE

- The instant-recall home channel is programmed in similar fashion to regular memories (remember to first select a frequency and any other desired settings). To attach a name to the Home channel, proceed to the next step, otherwise press **ENT** to

save the entry and exit. Press the joystick in so that *H* appears in the memory window, and the first character's place blinks.

- Move the joystick up/down to select the first character of the name for the home channel.
- Move once to the right then up/down to select the next character. Repeat the sequence (right, then up/down) to finish the name, then press **ENT** to save the entry and exit to the dial.

## 04: VFO WRITE

- A name can be also entered for display to identify (dial) operation. Press in on the joystick so that the underline of the first character's place blinks.
- Move the joystick up/down to select the first character of the name for the VFO, then move once to the right then up/down to select the next character. Repeat the sequence to finish the name, then press **ENT** to save the entry and exit.

### Note

While selecting and entering characters for names, you can instantly return to the first character of the alphabet set (upper & lower case) or numeral set by simply pressing **REV**. You can also move among the first characters of each set by pressing **ENT**. Refer to the table on page 48.

<STEP/TONE SET> [2]

Tuning steps are pre-set for the country the unit is exported, but can be changed to any one of seven available steps. Tone selection is used to access repeaters that require a CTCSS (continuous, subaudible) tone, and to silently monitor for calls on busy channels. See page 36 for an explanation on CTCSS operation.

05: STEP SIZE

- Push the joystick in for the channel step selection, then left/right to choose the desired step. Press in again to save the entry and exit.

06: TONE SELECT

- Push the joystick in to display the current CTCSS tone, then up/down to choose a different tone. Press in again to save the entry and exit. CTCSS tone frequencies are listed below.

67.0	85.4	107.2	136.5	173.8	225.7
69.3	88.5	110.9	141.3	179.9	233.6
71.9	91.5	114.8	146.2	186.2	241.8
74.4	94.8	118.8	151.4	192.8	250.3
77.0	97.4	123.0	156.7	203.5	
79.7	100.0	127.3	162.2	210.7	
82.5	103.5	131.8	167.9	218.1	

<REPEATER SET> [2]

The repeater shift is pre-set to 600 kHz for VHF, and 5, 7.6 or 1.6 MHz for UHF. When tuning through standard repeater subbands, ARS (Auto Repeater Shift) selects the appropriate shift and offset (+/-) for easy operation. The following entries enable changing the default offset or turning ARS on/off.

07: AUTO RPTR SHIFT

- Press in on the joystick to display the default offset. Move left/right to select the offset digits place, and up/down to change the offset value.
- With the correct offset displayed, press the joystick in again to save the entry and exit.

08: REPEATER SHIFT

- Press in on the joystick to see if ARS is presently enabled or disabled. Move left/right to turn ARS on or off, then press the joystick in to save the entry and exit.
- NOTE!** Since offsets are independent for VHF and UHF, this setting must be repeated for both bands.

<DTMF SET> [3]

Ten memories, numbered 1-9 & USr, are reserved for storing DTMF tone sequences of up to 16 digits each. These can be used to store telephone numbers for auto-patching systems. The user-memory is reserved for programming a melody to be played back during paging operation.

A special mode must be activated to use the DTMF autodial memory features, and is covered on page 46. The  icon appears at the display center when this mode is active.

**\*89:DTMF AUTO DIAL**

- Press in on the joystick to see if the DTMF autodialer is set for auto or manual operation. Move left/right to select operation and press in on the joystick to save and exit.

**\*18:AUTODIAL MEMORY**

To store a DTMF Auto-Dial Memory:

- Press the joystick in so the display appears similar to that below. The small blinking digit indicates the displayed autodial memory. From the factory, DTMF Autodial memories are named DTMF 1 ~ DTMF 9 and USER EP (covered later), but can be renamed later with a name of your choice.
- Moving the joystick up/down cycles through the autodial memories. With the desired memory dis-

played, move the joystick to the right if you want to rename the memory while programming autodial digits, or else left to skip renaming the memory and go straight into programming the digits.

- The blinking underline shows the current digit's or character's place. Move up/down to select a number or character, then to the right to save it and move on to the next place. If you make a mistake, you can always move the joystick to the left to go back and correct any entries. Remember, the small number must be blinking before you can enter digits or characters.
- With the desired DTMF string appearing, press  to finish and exit.

To program the user-melody (for paging and CTCSS bell functions):

- Press the joystick up/down so that **USP** blinks in the memory box.
- To rename the memory, move the joystick to the right, or else move to the left to skip renaming and go directly to melody entry.
- With the first underline blinking, move up/down to select a note (C4-D7#) or rest (1/8 or 8/8), then to the right to save it and move on to the next place (up to 16 notes/places). The piano keyboard outlines the four octaves of notes available for entry.
- The small number appearing in the memory box indicates the serial place of the next note entry. For

example, *U 15* means you are entering the 15th note/rest of the melody. If you make a mistake, you can always move the joystick to the left to go back and correct any entries.

- After entering the desired DTMF melody, press  to finish and exit. To play back what you have just composed, proceed to the next entry.

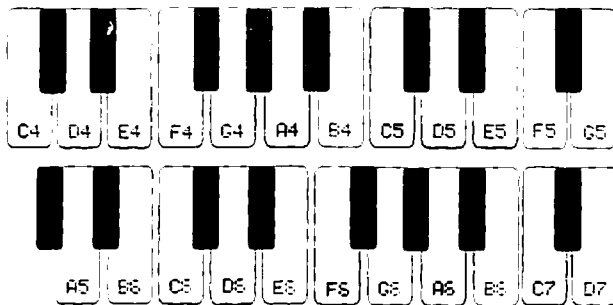

**\*11:DTMF MONITOR**

- You can play back the user-composed melody at any time from this entry by merely pressing the joystick in. The entire melody repeats each time the joystick is pressed.

**<MESSAGE SET> [4]**

The following entries determine how the transceiver responds and operates when sending and receiving DTMF messages. Refer to page 44 for details on message operation and configuring the following.

**\*12:MESSAGE FORMAT**

- Press in on the joystick to display the current message operation format. Move left/right to select MSG, MSG+ID or OFF.
- With the correct message format selected, press the joystick in again to save the entry and exit.

**\*13:MESSAGE WRITE**

A memory bank stores 10 transmit (outgoing) message slots, each up to 8 characters in length. The pre-programmed messages can be rewritten as follows:

- Press the joystick so the message display appears. The left field is the selected message slot number. Displayed at the right is the current message written into that memory slot.
- Press the joystick up/down to select slots, then to the right to move to the message field for writing.
- Move up/dwn to choose the first character, then move right to the next place. Repeat this again to complete the message. If you make a mistake

entering a character, move left to backstep to the incorrect entry, make the correction and continue.

- Move back to the slot number, select a new slot and write a new message if desired. When all message slots have been filled as desired, press the joystick in to save the entries and exit.

#### \*14: MESSAGE STORAGE

- Press in on the joystick to display the default storage format for received DTMF messages. Move left/right to select FILL or QUEUE, then press the joystick in again to save the entry and exit.

#### 15: MESSAGE CW MONITOR

- Press in on the joystick to display the default monitor setting. Move left/right to turn the CW monitor on or off, then press the joystick in again to save the selection and exit.

---

#### <PAGER SET> [8]

---

The following entries configure the transceiver for DTMF paging operation.

#### 16: PAGING CODE

- Press the joystick in so the paging code display appears, with the selected code channel blinking.

Code channels 1-6, C & P are selected by moving the joystick up/down. You can move between fields by pressing the joystick left/right. Note that code channel C cannot be written to. The setting in the last field (enable/disable) determines whether the transceiver responds to the selected 3-digit if received in a paging sequence or not.

- First select a 3-digit code for your personal ID and store it in code channel P.
- In the first field, move up/down to select channel P, then move right to jump to the 3-digit code field.
- Move up/down to choose the first digit, then move right to the next digits place. Repeat this again to complete the ID code, then move right to jump to the last field.
- Move up/down to disable or enable the code channel from paging operation. If you make a mistake entering a character, move left to backstep to the incorrect entry, make the correction and continue.



- With your ID entered, you can repeat this procedure to program the remaining code channels. After ID codes and settings are entered for each code channel, press in on the joystick to save the entry and exit.
- 17: PAGING TX DELAY**
- When calling stations using DTMF Paging or Code Squelch, particularly through repeaters, some may not receive your calls because their receiver squelch is not opening fast enough (after receiving your transmitted carrier) to allow all of the DTMF digits to be decoded. To correct this problem, you can set a longer delay (750 or 1000 ms) between the time the transmitter is keyed and the first DTMF digit is sent.
- Press the joystick in to display the current Tx delay in milliseconds.
- Move left/right to select the desired delay, then press in to save and exit.
- 18: ANSWER-BACK MODE**
- Two choices of automatic DTMF paging response are available from this entry:
  - *Answer-Back* - acknowledges a received page by "paging back" the calling station (just as if you manually selected their 3-digit code and pressed the PTT).
  - *Page Forwarding* - takes a received DTMF paging string and re-transmits the original sequence

- Move left/right to select the FLD or RNS-EK, then press in to save and exit.
- 19: PAGER RINGER**
- The ringer response to DTMF Paging calls depends on the configuration you select. Three types of DTMF ringer melodies are available:
  - Beep Melody (factory-programmed)
  - User-programmed Melody
  - CW (Morse Code) Ringer
- Press the joystick in to display the currently selected DTMF Paging ringer.
- Move left/right to select the BEEP, USER or CW, then press in to save and exit.
- 20: PAGING ALERT**
- The DTMF ringer can be enabled to sound only once, or else repeat the selected melody (or Morse announcement) every minute until the PTT is pressed.
- Press the joystick in to display the current ringer alert.

- Move left/right to select SINGLE or REPEAT, then press in to save and exit.

#### 21: RINGER REPETITION

The DTMF Paging ringer can be turned off, or else enabled to repeat the selected melody (or Morse announcement) 1, 3, 5 or 8 times when a call is received.

- Press the joystick in to display the currently selected ringer repetition.
- Move left/right to select 1, 3, 5, 8 or OFF, then press in to save and exit.

#### 22: PAGING MONITOR

- You can play back the selected DTMF Paging ringer melody (beep, user or CW) by pressing the joystick in while this is displayed. Move up/down to stop playback and exit.

#### 23: ONE TOUCH PAGER SET

Enable this to display the Code Memory number in place of the 100's-of-MHz frequency digit whenever DTMF Code Squelch, DTMF Paging, or Trigger Paging is enabled.

- Press the joystick in to display the current setting.
- Move left/right to select ON or OFF, then press in to save and exit.

---

#### <RINGER SET> [4]

---

The ringer response CTCSS Bell operation depends on the configuration you select. Three types of ringer melodies are available (note that the CTCSS Bell and DTMF alert ringers and their settings are *independent*):

- Beep Melody (factory-programmed)
- User-programmed Melody
- CW (Morse Code) Ringer

#### 24: RINGER TONE

- Press the joystick in to display the currently selected CTCSS Bell ringer.
- Move left/right to select the BEEP, USER or CW, then press in to save and exit.

#### 25: RINGER INTERVAL

- The CTCSS Bell ringer can be enabled to sound only once, or else repeat the selected melody (or Morse announcement) every minute until the PTT is pressed.
- Press the joystick in to display the current ringer alert.
- Move left/right to select SINGLE or REPEAT, then press in to save and exit.

## 26: RINGER REPETITION

The CTCSS Bell ringer can be turned off, or else enabled to repeat the selected melody (or Morse announcement) 1, 3, 5 or 8 times when a call is received.

- Press the joystick in to display the currently selected ringer repetition.
- Move left/right to select 1, 3, 5, 8 or OFF, then press in to save and exit.

## 27: RINGER MONITOR

- You can play back the selected CTCSS Bell ringer melody (beep, user or CW) by pressing the joystick in while this is displayed. Move up/dwn to stop playback and exit.

## &lt;MISC SET&gt; (5)

Various convenient features to enhance transceiver operation are configured within these menu entries.

## \*28: AUTO POWER OFF

The transceiver can be set to turn itself off after a pre-set period of inactivity (keys or PTT are not pressed).

- Press the joystick in to display the current APO status.
- Move up/dwn to select an inactivity period of 1-12 hours or OFF, then press the joystick in to save and exit.

## \*29: TIME-OUT TIMER

The transceiver can be set to unkey after a pre-set period of *continuous* transmission.

- Press the joystick in to display the current TOT status.
- Move up/dwn to select an inactivity period of 1-60 minutes or OFF, then press the joystick in to save and exit.

### \*30: LCD CONTRAST

LCD contrast can be continuously adjusted for maximum clarity.

- Press the joystick in to display the current contrast level.
- Move up/dwn to adjust the contrast to a comfortable level between 1~16, then press the joystick in to save and exit.

### \*31: DIMMER

The LCD backlighting has 6 brightness levels that can be adjusted manually, automatically (via the front panel ADS sensor) or turned off for best viewing under different lighting conditions.

- Press the joystick in to display the current backlighting level.
- Move up/dwn to adjust the backlight to a comfortable level between 1~6 (manual), 1-6 (auto), or OFF. Press the joystick in to save and exit.

### \*32: DC POWER CHECK

- Press the joystick in to check the present DC supply voltage.

### <FUNCTION SET> [12]

Other features that custom-configure transceiver operation and display appearance are included here.

### \*33: DIRECT FREQ ENTRY

- Press the joystick in and move left/right to turn the feature on or off. Press the joystick in to save and exit.

### \*34: KEYPAD BEEPER

- Press the joystick in and move left/right to turn the key beeper on or off. Press the joystick in to save and exit.

### \*35: SUB BAND OPERATION

- Press the joystick in to display the current sub band display configuration.
- Move left/right to turn the sub band display on/off, or else have the DC supply voltage displayed in place of the frequency. Press the joystick in to save and exit.

### \*36: INTEL BAND DISPLAY

- Press the joystick in to display the current IBD setting.
- Move left/right to turn Intelligent Band Display on/off, then press the joystick in to save and exit.

\*37: SCAN SPEED SELECT

- Press the joystick in and move left/right to select NORMAL or SLOW scan speed (see table below). Press the joystick in to save and exit.

Scan Speed		
	Normal	Slow
MR	20 ch/sec.	6 ch/sec.
VFO	33 steps/sec.	6 steps/sec.

38: SCAN RESUME MODE

- Press the joystick in to display the current scan resume mode.
- Move up/dwn to select one of four available modes (see page 33 for a detailed explanation), then press the joystick in to save and exit.

\*39: CW SPEED SET

- Press the joystick in and move left/right to select the desired CW playback speed. Press the joystick in to save and exit.

\*40: DATA JACK SELECT

- Press the joystick in and move left/right to select VHF or UHF operation via the rear panel DATA jack (used for TNC interconnection). Press the joystick in to save and exit.

\*41: DATA BAUD RATE

- Press the joystick in to display the current data rate configuration.
- Move left/right to select either 1200 baud or 9600 baud operation (see page 51 for a detailed explanation), then press the joystick in to save and exit.

42: A/N TAG DISPLAY

- Press the joystick in and move left/right to turn display of alphanumeric name tags on or off. Press the joystick in to save and exit.

43: FREQ DISPLAY

- Press the joystick in and move left/right to turn display of channel frequencies on or off. Press the joystick in to save and exit.

\*44: MENU SELECT

- Press the joystick in to display the selected language for the menu display. *Do not change this setting to prevent confusion.* Press the joystick in to exit.

## <LOCK SET> [2]

The keypad buttons, joystick and DIAL knob can each be "locked" (disabled), to prevent inadvertent adjustments. You will find  displayed at the left when any of these are locked. The PTT can also be locked to prevent transmitting accidentally, and ★ appears in the *right* display when this lock is active. *Note:* do not confuse the PTT lock with the *blinking* ★ in the *left* display, which indicates AM receive is on.

The keypad, joystick and DIAL knob locking switch is located just to the left of FS-10 joystick, and is labeled LOCK. Slide it upward to lock and down to unlock. PTT lock is enabled via menu selection.

### \*45: LOCK SELECT

- Press the joystick in to display the current locking scheme. To lock only joystick and DIAL knob input, select DIAL. To additionally disable all FS-10 unit buttons and controls, select BOTH. Press the joystick in to save and exit.

### \*45: PTT LOCK

- Press the joystick in and move left/right to turn the PTT lock on/off.

## <MUTE SET> [3]

This function mutes or disables audio from a selected band (channel) when two stations are received simultaneously.

### \*47: MUTE TIME

- Press the joystick in then move up/down to select 1-60 minutes mute duration or OFF for continuous mute.
- Press the joystick in to save and exit.

### \*48: MUTE LEVEL

- Press the joystick in then move up/down to select level 1 (pre-set mute) or level 2 (full mute).
- Press the joystick in to save and exit.

### \*49: AUTO MUTE

- Press the joystick in then move left/right to VHF or UHF muting, or else OFF to disable the auto mute function.
- Press the joystick in to save and exit.

<SPECT DISP SET> [3]

The following settings determine how signal activity appears when viewing the Spectra-Analyzer. Refer to pages 25-27 for a complete description of each entry and how settings affect the spectrum silhouette.

\*50: SIGNAL WIDTH

- Press the joystick in to display the signal width in pixels. Move left/right to select the desired width then press the joystick in to save and exit.

\*51: SIGNAL SPACING

- Press the joystick in to display the signal spacing (separation) in pixels. Move left/right to select the desired spacing then press the joystick in to save and exit.

\*52: SPAN MARKERS

- Press the joystick in to display the span marker calibration (in kHz). Select the desired bandwidth then press the joystick in to save and exit.

<AM MODE SET>

AM mode can be turned on to enable reception of aeronautical band transmission between 110-137 MHz in transceiver versions offering extended receive capability.

\*53: AM SET

- Press the joystick in to display if AM receive is enabled or not. Move left/right to turn AM mode on/off, then press the joystick in to save and exit.



# **YAESU**

*Performance without compromise.<sup>SM</sup>*

**YAESU MUSEN CO., LTD.**

C.P.O. Box 1500, Tokyo, Japan

**YAESU EUROPE B.V.**

Snipweg 3, 1118DN Schiphol, The Netherlands

**YAESU GERMANY GmbH**

Am Kronberger Hang 2, D-65824 Schwalbach, Germany

**YAESU UK LTD.**

Unit 2, Maple Grove Business Centre

Lawrence Rd., Hounslow, Middlesex, TW4 6DR, U.K.

**YAESU U.S.A.**

17210 Edwards Rd., Cerritos, CA 90703, U.S.A.

Copyright 1995

Yaesu Musen Co., Ltd.

All rights reserved.

No portion of this manual  
may be reproduced without  
the permission of  
Yaesu Musen Co., Ltd.

E05127500 (503k-OA)