



OWNER'S MANUAL

Road Star

XV17AV(C)

XV17AWV(C)

XV17AMV(C)

XV17ATV(C)

XV17ATMV(C)

LIT-11626-19-45

5VN-28199-12

EAU10041

 WARNING

The engine exhaust from this product contains chemicals known to the State of California to cause cancer, birth defects or other reproductive harm.

YAMAHA

LIT-CALIF-65-01

Congratulations on your purchase of the Yamaha Road Star™. This model is the result of Yamaha's vast experience in the production of fine sporting, touring, and pacesetting racing machines. It represents the high degree of craftsmanship and reliability that have made Yamaha a leader in these fields.



This manual will give you an understanding of the operation, inspection, and basic maintenance of this motorcycle. If you have any questions concerning the operation or maintenance of your motorcycle, please consult a Yamaha dealer.

The design and manufacture of this Yamaha motorcycle fully comply with the emissions standards for clean air applicable at the date of manufacture. Yamaha has met these standards without reducing the performance or economy of operation of the motorcycle. To maintain these high standards, it is important that you and your Yamaha dealer pay close attention to the recommended maintenance schedules and operating instructions contained within this manual.

IMPORTANT MANUAL INFORMATION

EAU10131

Particularly important information is distinguished in this manual by the following notations:

	The Safety Alert Symbol means ATTENTION! BECOME ALERT! YOUR SAFETY IS INVOLVED!
	Failure to follow WARNING instructions could result in severe injury or death to the motorcycle operator, a bystander or a person inspecting or repairing the motorcycle.
CAUTION:	A CAUTION indicates special precautions that must be taken to avoid damage to the motorcycle.
NOTE:	A NOTE provides key information to make procedures easier or clearer.

NOTE:

- This manual should be considered a permanent part of this motorcycle and should remain with it even if the motorcycle is subsequently sold.
- Yamaha continually seeks advancements in product design and quality. Therefore, while this manual contains the most current product information available at the time of printing, there may be minor discrepancies between your motorcycle and this manual. If you have any questions concerning this manual, please consult your Yamaha dealer.

EWA10010

WARNING

PLEASE READ THIS MANUAL AND THE “YOU AND YOUR MOTORCYCLE: RIDING TIPS” BOOKLET CAREFULLY AND COMPLETELY BEFORE OPERATING THIS MOTORCYCLE. DO NOT ATTEMPT TO OPERATE THIS MOTORCYCLE UNTIL YOU HAVE ATTAINED ADEQUATE KNOWLEDGE OF ITS CONTROLS AND OPERATING FEATURES

IMPORTANT MANUAL INFORMATION

AND UNTIL YOU HAVE BEEN TRAINED IN SAFE AND PROPER RIDING TECHNIQUES. REGULAR INSPECTIONS AND CAREFUL MAINTENANCE, ALONG WITH GOOD RIDING SKILLS, WILL ENSURE THAT YOU SAFELY ENJOY THE CAPABILITIES AND THE RELIABILITY OF THIS MOTORCYCLE.

*Product and specifications are subject to change without notice.

IMPORTANT MANUAL INFORMATION

EAU10192

AFFIX DEALER
LABEL HERE

**XV17AV(C)/XV17AWV(C)/XV17AMV(C)/XV17ATV(C)/
XV17ATMV(C)**

OWNER'S MANUAL

©2005 by Yamaha Motor Corporation, U.S.A.

1st edition, May 2005

All rights reserved.

**Any reprinting or unauthorized use
without the written permission of
Yamaha Motor Corporation, U.S.A.
is expressly prohibited.**

Printed in Japan.

P/N LIT-11626-19-45

TABLE OF CONTENTS

SAFETY INFORMATION	1-1	Saddlebags [XV17ATV(C)]	3-13	Engine oil and oil filter cartridge ...	6-10
Location of important labels	1-5	Sidecases [XV17ATMV(C)]	3-13	Transfer case oil	6-13
DESCRIPTION	2-1	Adjusting the shock absorber		Cleaning the air filter element	6-15
Left view	2-1	assembly	3-14	Carburetor	6-16
Right view	2-3	Sidestand	3-16	Checking the throttle cable free	
Controls and instruments	2-5	Ignition circuit cut-off system	3-17	play	6-17
INSTRUMENT AND CONTROL		PRE-OPERATION CHECKS	4-1	Valve clearance	6-17
FUNCTIONS	3-1	Pre-operation check list	4-2	Tires (For spoke wheel model)	6-17
Main switch/steering lock	3-1	OPERATION AND IMPORTANT		Tires (For cast wheel models)	6-19
Indicator and warning lights	3-2	RIDING POINTS	5-1	Spoke wheels	6-22
Speedometer unit	3-3	Starting and warming up a cold		Cast wheels	6-22
Self-diagnosis device	3-3	engine	5-1	Accessories and replacement	
Fuel gauge	3-4	Starting a warm engine	5-2	parts	6-22
Clock	3-4	Shifting	5-3	Adjusting the clutch lever free	
Handlebar switches	3-5	Engine break-in	5-4	play	6-23
Clutch lever	3-6	Parking	5-5	Adjusting the brake lever free	
Shift pedal	3-6	PERIODIC MAINTENANCE AND		play	6-24
Brake lever	3-6	MINOR REPAIR	6-1	Adjusting the rear brake light	
Brake pedal	3-7	PERIODIC MAINTENANCE	6-1	switch	6-25
Fuel tank cap	3-7	Owner's tool kit	6-1	Checking the front and rear brake	
Fuel	3-8	Periodic maintenance chart for the		pads	6-25
Fuel cock	3-9	emission control system	6-3	Checking the brake fluid level	6-26
Starter (choke) knob	3-10	General maintenance and		Changing the brake fluid	6-27
Locking the steering with a		lubrication chart	6-4	Drive belt slack	6-27
padlock	3-10	Removing and installing the		Checking and lubricating the	
Rider seat	3-10	panel	6-8	cables	6-29
Helmet holder	3-11	Checking the spark plugs	6-8	Checking and lubricating the	
Windshield		Canister (for California only)	6-10	throttle grip and cable	6-29
[XV17ATV(C)/XV17ATMV(C)]....	3-12			brake and shift pedals	6-29

TABLE OF CONTENTS

Checking and lubricating the brake and clutch levers	6-30
Checking and lubricating the sidesand	6-31
Lubricating the swingarm pivots ...	6-31
Lubricating the rear suspension ...	6-31
Checking the front fork	6-32
Checking the steering	6-32
Checking the wheel bearings	6-33
Battery	6-33
Replacing the fuses	6-35
Replacing the headlight bulb	6-36
Tail/brake light	6-37
Replacing a turn signal light bulb	6-38
Replacing a license plate light bulb	6-38
Supporting the motorcycle	6-39
Troubleshooting	6-39
Troubleshooting chart	6-40

Motorcycle noise regulation	9-4
Maintenance record	9-5
YAMAHA MOTOR CORPORATION, U.S.A. STREET AND ENDURO MOTORCYCLE LIMITED WARRANTY	9-7
YAMAHA EXTENDED SERVICE (Y.E.S.)	9-9

MOTORCYCLE CARE AND

STORAGE	7-1
Care	7-1
Storage	7-4

SPECIFICATIONS

CONSUMER INFORMATION	9-1
Identification numbers	9-1
Reporting safety defects	9-3

EAU10251

MOTORCYCLES ARE SINGLE TRACK VEHICLES. THEIR SAFE USE AND OPERATION ARE DEPENDENT UPON THE USE OF PROPER RIDING TECHNIQUES AS WELL AS THE EXPERTISE OF THE OPERATOR. EVERY OPERATOR SHOULD KNOW THE FOLLOWING REQUIREMENTS BEFORE RIDING THIS MOTORCYCLE.

HE OR SHE SHOULD:

- OBTAIN THOROUGH INSTRUCTIONS FROM A COMPETENT SOURCE ON ALL ASPECTS OF MOTORCYCLE OPERATION.
- OBSERVE THE WARNINGS AND MAINTENANCE REQUIREMENTS IN THE OWNER'S MANUAL.
- OBTAIN QUALIFIED TRAINING IN SAFE AND PROPER RIDING TECHNIQUES.
- OBTAIN PROFESSIONAL TECHNICAL SERVICE AS INDICATED BY THE OWNER'S MANUAL

AND/OR WHEN MADE NECESSARY BY MECHANICAL CONDITIONS.

Safe riding

- Always make pre-operation checks. Careful checks may help prevent an accident.
- This motorcycle is designed to carry the operator and a passenger.
- The failure of motorists to detect and recognize motorcycles in traffic is the predominating cause of automobile/motorcycle accidents. Many accidents have been caused by an automobile driver who did not see the motorcycle. Making yourself conspicuous appears to be very effective in reducing the chance of this type of accident.

Therefore:

- Wear a brightly colored jacket.
- Use extra caution when approaching and passing through intersections, since intersections are the most likely places for motorcycle accidents to occur.

- Ride where other motorists can see you. Avoid riding in another motorist's blind spot.
- Many motorcycle accidents involve inexperienced operators. In fact, many operators who have been involved in accidents do not even have a current motorcycle license.
- Make sure that you are qualified and that you only lend your motorcycle to other qualified operators.
- Know your skills and limits. Staying within your limits may help you to avoid an accident.
- We recommend that you practice riding your motorcycle where there is no traffic until you have become thoroughly familiar with the motorcycle and all of its controls.
- Many motorcycle accidents have been caused by error of the motorcycle operator. A typical error made by the operator is veering

SAFETY INFORMATION

1

wide on a turn due to EXCESSIVE SPEED or undercornering (insufficient lean angle for the speed).

- Always obey the speed limit and never travel faster than warranted by road and traffic conditions.
- Always signal before turning or changing lanes. Make sure that other motorists can see you.
- The posture of the operator and passenger is important for proper control.
 - The operator should keep both hands on the handlebar and both feet on the operator footrests during operation to maintain control of the motorcycle.
 - The passenger should always hold onto the operator, seat strap, or grab bar, if equipped, with both hands and keep both feet on the passenger footrests.
 - Never carry a passenger unless he or she can firmly place both feet on the passenger footrests.
- Never ride under the influence of alcohol or other drugs.

- This motorcycle is designed for on-road use only, therefore, it is not suitable for off-road use.

Protective apparel

The majority of fatalities from motorcycle accidents are the result of head injuries. The use of a safety helmet is the single most critical factor in the prevention or reduction of head injuries.

- Always wear an approved helmet.
- Wear a face shield or goggles. Wind in your unprotected eyes could contribute to an impairment of vision which could delay seeing a hazard.
- The use of a jacket, heavy boots, trousers, gloves, etc., is effective in preventing or reducing abrasions or lacerations.
- Never wear loose-fitting clothes, otherwise they could catch on the control levers, footrests, or wheels and cause injury or an accident.
- Never touch the engine or exhaust system during or after operation. They become very hot and can

cause burns. Always wear protective clothing that covers your legs, ankles, and feet.

- Passengers should also observe the precautions mentioned above.

Modifications

Modifications made to this motorcycle not approved by Yamaha, or the removal of original equipment, may render the motorcycle unsafe for use and may cause severe personal injury. Modifications may also make your motorcycle illegal to use.

Loading and accessories

Adding accessories or cargo to your motorcycle can adversely affect stability and handling if the weight distribution of the motorcycle is changed. To avoid the possibility of an accident, use extreme caution when adding cargo or accessories to your motorcycle. Use extra care when riding a motorcycle that has added cargo or accessories. Here are some general guidelines to follow if loading cargo or adding accessories to your motorcycle:

Loading

The total weight of the operator, passenger, accessories and cargo must not exceed the maximum load limit.

Maximum load:

XV17AMV 194 kg (428 lb)
XV17AMVC 194 kg (428 lb)
XV17ATMV 179 kg (395 lb)
XV17ATMVC 179 kg (395 lb)
XV17ATV 179 kg (395 lb)
XV17ATVC 179 kg (395 lb)
XV17AV 194 kg (428 lb)
XV17AVC 194 kg (428 lb)
XV17AWV 194 kg (428 lb)
XV17AWVC 194 kg (428 lb)

When loading within this weight limit, keep the following in mind:

- Cargo and accessory weight should be kept as low and close to the motorcycle as possible. Make sure to distribute the weight as evenly as possible on both sides of the motorcycle to minimize imbalance or instability.
- Shifting weights can create a sudden imbalance. Make sure that accessories and cargo are securely

attached to the motorcycle before riding. Check accessory mounts and cargo restraints frequently.

- Never attach any large or heavy items to the handlebar, front fork, or front fender. These items, including such cargo as sleeping bags, duffel bags, or tents, can create unstable handling or slow steering response.

Accessories

Genuine Yamaha accessories have been specifically designed for use on this motorcycle. Since Yamaha cannot test all other accessories that may be available, you must personally be responsible for the proper selection, installation and use of non-Yamaha accessories. Use extreme caution when selecting and installing any accessories.

Keep the following guidelines in mind, as well as those provided under “Loading” when mounting accessories.

- Never install accessories or carry cargo that would impair the performance of your motorcycle. Carefully inspect the accessory before using it to make sure that it does

not in any way reduce ground clearance or cornering clearance, limit suspension travel, steering travel or control operation, or obscure lights or reflectors.

- Accessories fitted to the handlebar or the front fork area can create instability due to improper weight distribution or aerodynamic changes. If accessories are added to the handlebar or front fork area, they must be as lightweight as possible and should be kept to a minimum.
- Bulky or large accessories may seriously affect the stability of the motorcycle due to aerodynamic effects. Wind may attempt to lift the motorcycle, or the motorcycle may become unstable in cross winds. These accessories may also cause instability when passing or being passed by large vehicles.
- Certain accessories can displace the operator from his or her normal riding position. This improper position limits the freedom of movement of the opera-

SAFETY INFORMATION

1

tor and may limit control ability, therefore, such accessories are not recommended.

- Use caution when adding electrical accessories. If electrical accessories exceed the capacity of the motorcycle's electrical system, an electric failure could result, which could cause a dangerous loss of lights or engine power.

Gasoline and exhaust gas

- **GASOLINE IS HIGHLY FLAMMABLE:**
 - Always turn the engine off when refueling.
 - Take care not to spill any gasoline on the engine or exhaust system when refueling.
 - Never refuel while smoking or in the vicinity of an open flame.
- Never start the engine or let it run for any length of time in a closed area. The exhaust fumes are poisonous and may cause loss of consciousness and death within a short time. Always operate your motorcycle in an area that has adequate ventilation.

- Always turn the engine off before leaving the motorcycle unattended and remove the key from the main switch. When parking the motorcycle, note the following:
 - The engine and exhaust system may be hot, therefore, park the motorcycle in a place where pedestrians or children are not likely to touch these hot areas.
 - Do not park the motorcycle on a slope or soft ground, otherwise it may fall over.
 - Do not park the motorcycle near a flammable source (e.g. a kerosene heater, or near an open flame), otherwise it could catch fire.
- When transporting the motorcycle in another vehicle, make sure that it is kept upright and that the fuel cock is turned to "ON" or "RES" (for vacuum type) / "OFF" (for manual type). If it should lean over, gasoline may leak out of the carburetor or fuel tank.
- If you should swallow any gasoline, inhale a lot of gasoline vapor, or allow gasoline to get into your

eyes, see your doctor immediately. If any gasoline spills on your skin or clothing, immediately wash the affected area with soap and water and change your clothes.

Location of important labels

Please read the following important labels carefully before operating this vehicle.

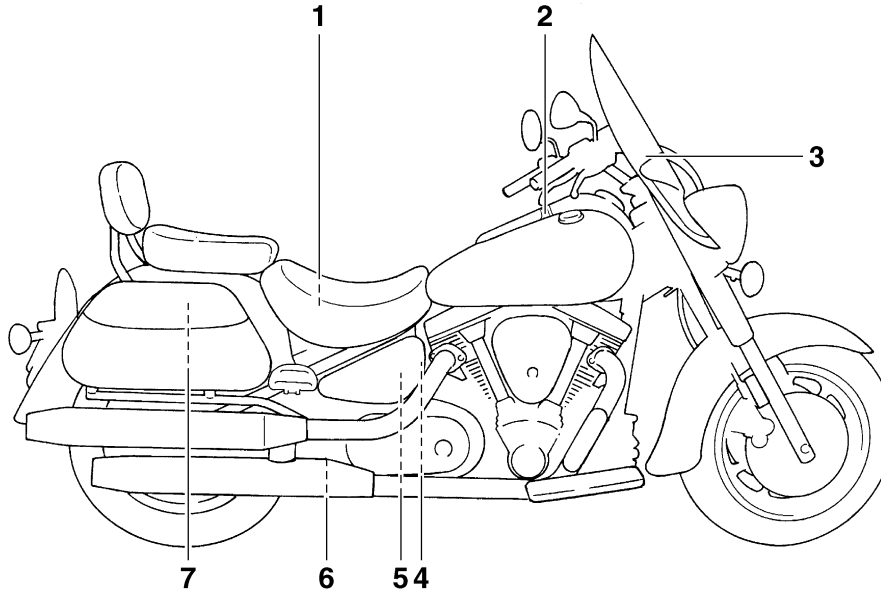

SAFETY INFORMATION

1

TIRE INFORMATION

Cold tire normal pressure should be set as follows.

- Up to 90 kg (198 lbs) load

FRONT : 250 kPa, (2.50 kgf/cm²), 36 psi
REAR : 250 kPa, (2.50 kgf/cm²), 36 psi

- 90 kg (198 lbs) ~ maximum load

FRONT : 250 kPa, (2.50 kgf/cm²), 36 psi
REAR : 280 kPa, (2.80 kgf/cm²), 41 psi

4NK-21668-A0

2

⚠ WARNING

- **BEFORE YOU OPERATE THIS VEHICLE, READ THE OWNER'S MANUAL AND ALL LABELS.**
- **ALWAYS WEAR AN APPROVED MOTORCYCLE HELMET, eye protection, and protective clothing.**

5GK-2118K-00

XV17ATV / XV17ATMV

3

CAUTION

Cleaning with alkaline or acid cleaner, gasoline or solvent will damage windshield. Use neutral detergent.

YAMAHA 4NL-F835Y-00

California only

4

VACUUM HOSE ROUTING

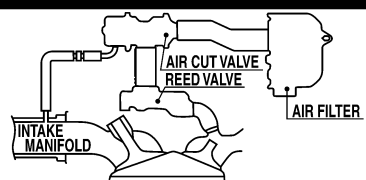

AIR CUT VALVE
REED VALVE
AIR FILTER
INTAKE MANIFOLD

4YN-21684-00

California only

5

EMISSION HOSE ROUTING

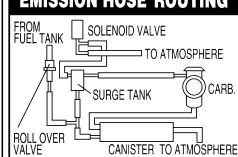

FROM FUEL TANK
SOLENOID VALVE
TO ATMOSPHERE
SURGE TANK
CARB.
ROLL-OVER VALVE
CANISTER TO ATMOSPHERE

4WM-21686-01

6

⚠ WARNING

This unit contains high pressure nitrogen gas. Mishandling can cause explosion.

- Read owner's manual for instructions.
- Do not incinerate, puncture or open.

4AA-22259-80

XV17ATV / XV17ATMV

7

⚠ WARNING

Improper loading can adversely affect handling.

- Do not exceed maximum load limit: 11 lb (5 kg) each saddlebag.
- Distribute weight evenly from side to side.
- Read the Owner's manual for important loading and tire pressure information.
- Total weight of rider, passenger, accessories, and cargo must not exceed the motorcycle load capacity shown in the Owner's Manual.
- Never ride above 80 mph (120 km/h) with saddlebags because handling could be affected. This maximum speed may be reduced by such factors as improper loading, poor tire or overall motorcycle conditions, poor road surfaces, or adverse weather conditions.

YAMAHA USA-SGA73-98-00

Left view

XV17AV(C)/XV17AWV(C)/XV17AMV(C)

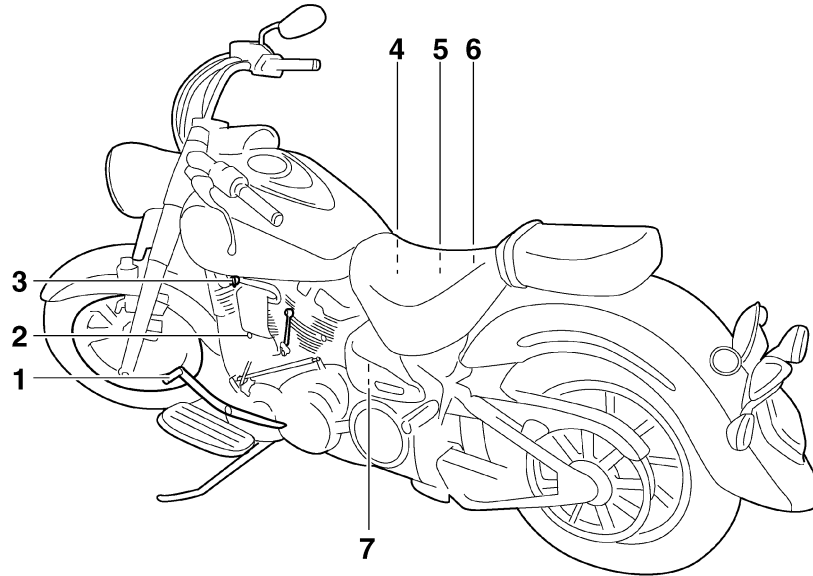

1. Shift pedal (page 3-6)
2. Starter (choke) knob (page 3-10)
3. Fuel cock (page 3-9)
4. Engine oil filler cap (page 6-10)
5. Battery (page 6-33)
6. Owner's tool kit (page 6-1)
7. Fuse (page 6-35)

DESCRIPTION

XV17ATV(C)/XV17ATMV(C)

2

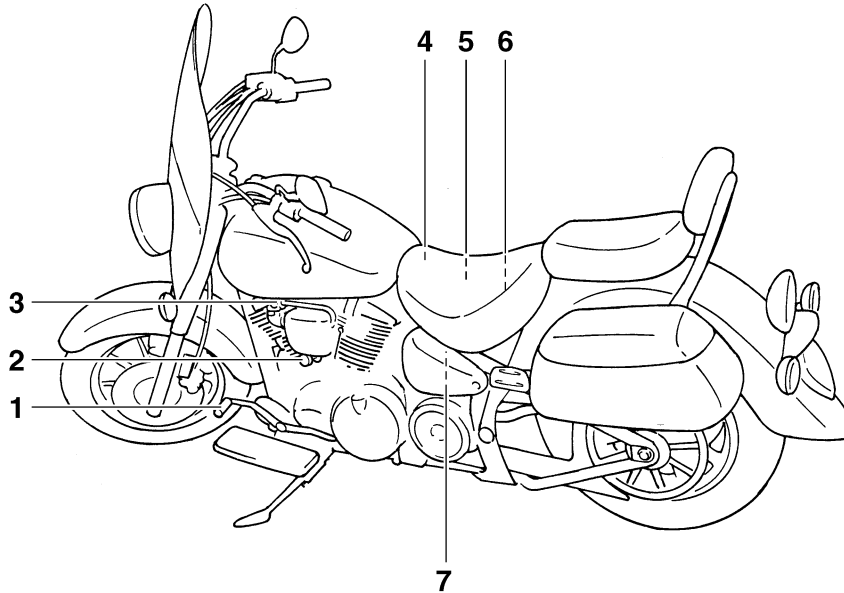

1. Shift pedal (page 3-6)
2. Starter (choke) knob (page 3-10)
3. Fuel cock (page 3-9)
4. Engine oil filler cap (page 6-10)
5. Battery (page 6-33)
6. Owner's tool kit (page 6-1)
7. Fuse (page 6-35)

Right view

XV17AV(C)/XV17AWV(C)/XV17AMV(C)

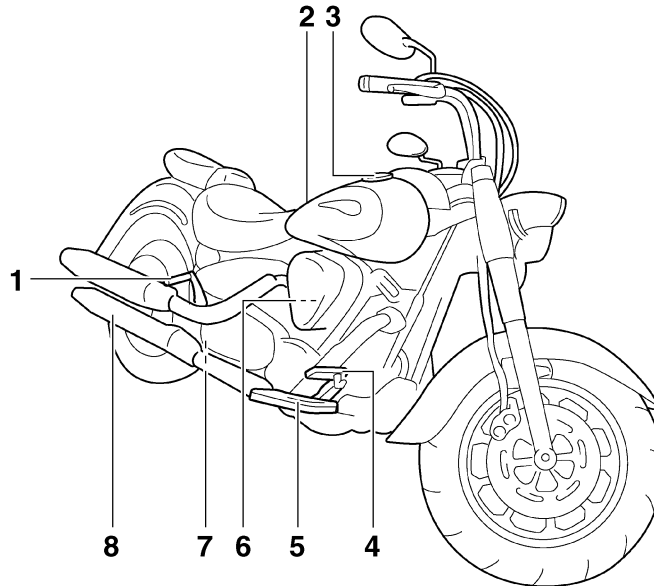

- 1. Passenger footrest
- 2. Fuel tank (page 3-7)
- 3. Fuel tank cap (page 3-7)
- 4. Brake pedal (page 3-7)
- 5. Rider footrest
- 6. Air filter element (page 6-15)
- 7. Shock absorber assembly spring preload adjusting nut (page 3-14)

8. Muffler

DESCRIPTION

XV17ATV(C)/XV17ATMV(C)

2

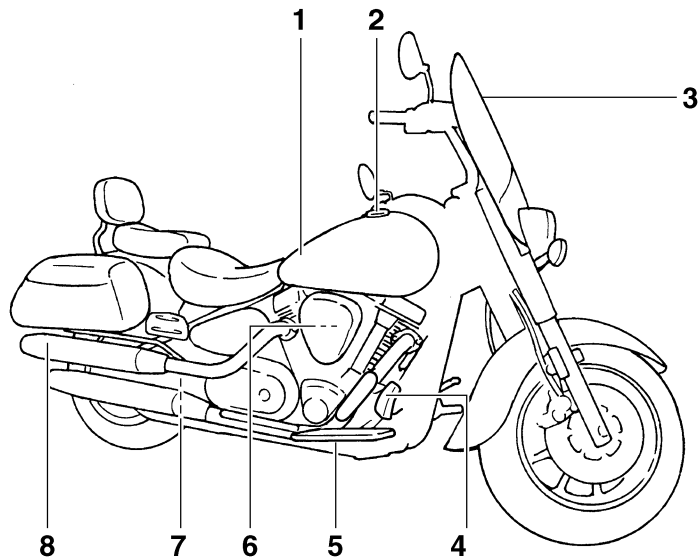

1. Fuel tank (page 3-7)
2. Fuel tank cap (page 3-7)
3. Windshield (page 3-12/3-5)
4. Brake pedal (page 3-7)
5. Rider footrest
6. Air filter element (page 6-15)
7. Shock absorber assembly spring preload adjusting nut (page 3-14)
8. Muffler

Controls and instruments

XV17AV(C)/XV17AWV(C)/XV17AMV(C)

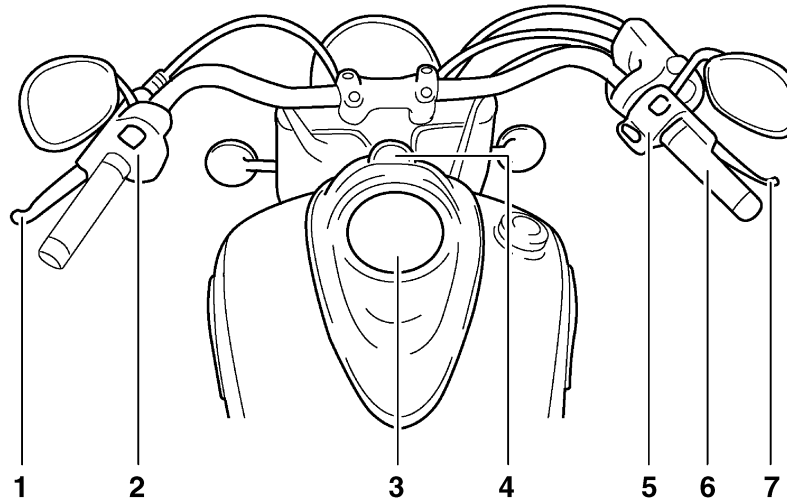

1. Clutch lever (page 3-6)
2. Left handlebar switches (page 3-5)
3. Speedometer unit (page 3-3)
4. Main switch/steering lock (page 3-1)
5. Right handlebar switches (page 3-5)
6. Throttle grip (page 6-17)
7. Brake lever (page 3-6)

DESCRIPTION

XV17ATV(C)/XV17ATMV(C)

2

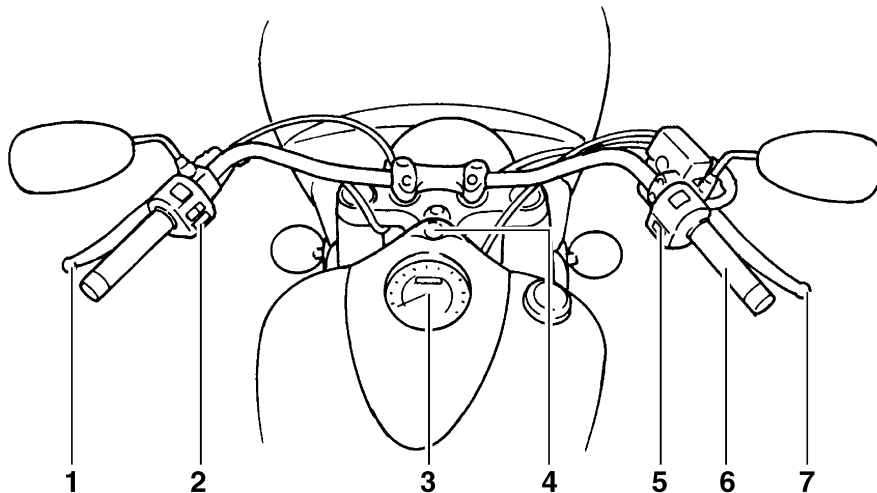

1. Clutch lever (page 3-6)
2. Left handlebar switches (page 3-5)
3. Speedometer unit (page 3-3)
4. Main switch/steering lock (page 3-1)
5. Right handlebar switches (page 3-5)
6. Throttle grip (page 6-17)
7. Brake lever (page 3-6)

INSTRUMENT AND CONTROL FUNCTIONS

Main switch/steering lock

EAU10460

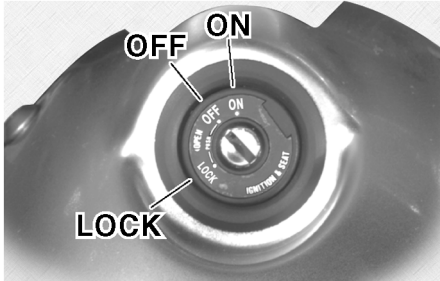

The main switch/steering lock controls the ignition and lighting systems, and is used to lock the steering. The various positions are described below.

ON

EAU10520

All electrical systems are supplied with power, and the headlight, meter lighting, taillight, license plate light and position lights come on, and the engine can be started. The key cannot be removed.

OFF

EAU10660

All electrical systems are off. The key can be removed.

LOCK

EAU10680

The steering is locked, and all electrical systems are off. The key can be removed.

To lock the steering

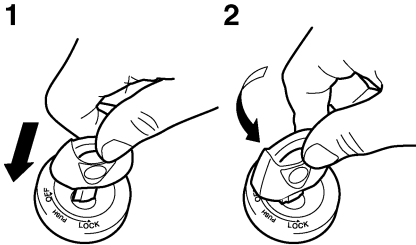

1. Push.
2. Turn.

1. Turn the handlebars all the way to the left.
2. Push the key in from the "OFF" position, and then turn it to "LOCK" while still pushing it.
3. Remove the key.

To unlock the steering

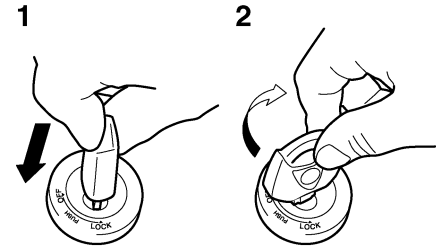

1. Push.
2. Turn.

Push the key in, and then turn it to "OFF" while still pushing it.

EWA10060





! WARNING

Never turn the key to "OFF" or "LOCK" while the vehicle is moving, otherwise the electrical systems will be switched off, which may result in loss of control or an accident. Make sure that the vehicle is stopped before turning the key to "OFF" or "LOCK".

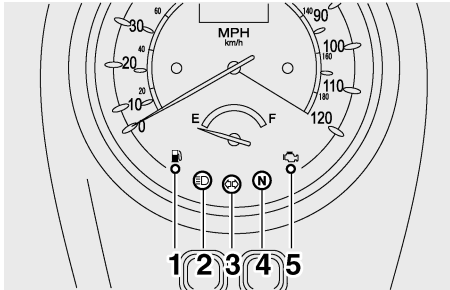
INSTRUMENT AND CONTROL FUNCTIONS

Indicator and warning lights EAU11003



1. Fuel level warning light “”
2. High beam indicator light “”
3. Turn signal indicator light “”
4. Neutral indicator light “**N**”
5. Engine trouble warning light “”

Turn signal indicator light “” EAU11020

This indicator light flashes when the turn signal switch is pushed to the left or right.

Neutral indicator light “**N**” EAU11060

This indicator light comes on when the transmission is in the neutral position.

High beam indicator light “” EAU11080

This indicator light comes on when the high beam of the headlight is switched on.

Fuel level warning light “” EAU38100

This warning light comes on when the fuel level drops below approximately 3.5 L (0.92 US gal) (0.77 Imp.gal). When this occurs, turn the fuel cock lever to the “RES” position and refuel as soon as possible.

NOTE: _____

This model is also equipped with a self-diagnosis device for the fuel level detection circuit. If the fuel level detection circuit is defective, the following cycle will be repeated until the malfunction is corrected: The fuel level warning light will flash eight times, and then go off for 3.0 seconds. If this occurs, have a Yamaha dealer check the vehicle.

Engine trouble warning light “” EAU11500

This warning light comes on or flashes when an electrical circuit monitoring the engine is defective. When this occurs, have a Yamaha dealer check the self-diagnosis system.

The electrical circuit of the warning light can be checked by turning the key to “ON”. If the warning light does not come on for a few seconds, then go off, have a Yamaha dealer check the electrical circuit.

EAU11701

Speedometer unit

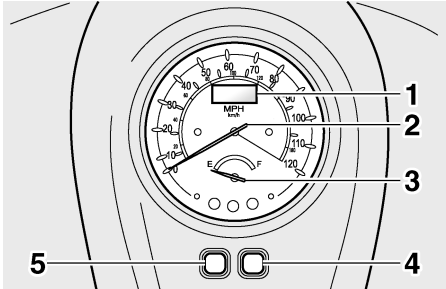

1. Odometer/tripmeter/clock
2. Speedometer
3. Fuel gauge
4. Set button
5. Mode button

The speedometer unit is equipped with a speedometer, an odometer and two tripmeters. The speedometer shows riding speed. The odometer shows the total distance traveled. The tripmeters show the distance traveled since they were last set to zero.

Pushing the mode button (left) switches the display between the odometer mode “ODO” and the tripmeter modes “TRIP A” and “TRIP B” in the following order:

ODO → TRIP A → TRIP B → ODO



To reset a tripmeter, select it by pushing the mode button (left), and then hold down the set button (right) for at least one second. The tripmeters can be used to estimate the distance that can be traveled with a full tank of fuel. This information will enable you to plan future fuel stops.

NOTE: _____

This model is not equipped with a tachometer; however, it has a built-in engine speed limiter, which prevents the engine speed from exceeding approximately 4800 r/min.

EAU12090

Self-diagnosis device

This model is equipped with a self-diagnosis device for various electrical circuits.

If any of those circuits are defective, the engine trouble warning light will come on or flash. If this occurs, have a Yamaha dealer check the vehicle.

ECA11170

CAUTION: _____

To prevent engine damage, be sure to consult a Yamaha dealer as soon as possible if this occurs.

INSTRUMENT AND CONTROL FUNCTIONS

3

Fuel gauge

EAU12110

The fuel gauge indicates the amount of fuel in the fuel tank. The needle moves towards “E” (Empty) as the fuel level decreases. When the needle reaches “E”, approximately 3.5 L (0.92 US gal) (0.77 Imp.gal) of fuel remain in the fuel tank. If this occurs, refuel as soon as possible.

NOTE:

Do not allow the fuel tank to empty itself completely.

Clock

EAU12211

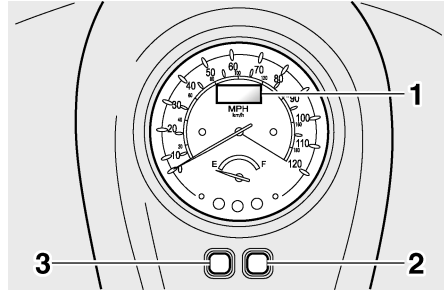

1. Clock
2. Set button
3. Mode button

The digital clock shows the time regardless of the main switch position.



To set the clock

1. Turn the key to “ON”.

2. Press both the set button (right) and the mode button (left) simultaneously until the hours and minutes flash.
3. Push the left button and only the hour display will flash.
4. Push the right button to change the hours.
5. Push the left button and only the minute display will flash.
6. Push the right button to change the minutes.
7. Push the left button and both the hours and minutes will flash.
8. Push the right button for two seconds to set the clock.

INSTRUMENT AND CONTROL FUNCTIONS

Handlebar switches

Left

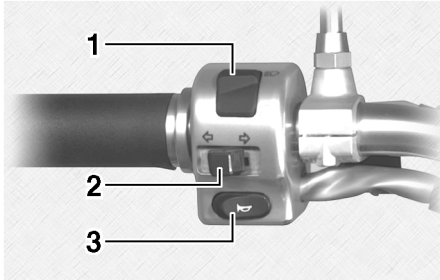

1. Dimmer switch “ $\equiv\text{O}/\equiv\text{O}$ ”
2. Turn signal switch “ \leftarrow/\rightarrow ”
3. Horn switch “ H ”

Right

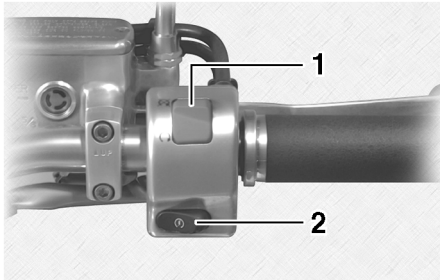

1. Engine stop switch “ O/X ”
2. Start switch “ S ”

EAU12343

Dimmer switch “ $\equiv\text{O}/\equiv\text{O}$ ”

Set this switch to “ $\equiv\text{O}$ ” for the high beam and to “ O ” for the low beam.

EAU12400

Turn signal switch “ \leftarrow/\rightarrow ”

To signal a right-hand turn, push this switch to “ \rightarrow ”. To signal a left-hand turn, push this switch to “ \leftarrow ”. When released, the switch returns to the center position.

EAU12430

Since this model is equipped with a self-canceling system, the turn signal lights will self-cancel after the vehicle has traveled both about 150 m (490 ft) and for approximately 15 seconds. However, the turn signal lights can also be canceled manually by pushing the switch in after it has returned to the center position.

NOTE: _____

The self-canceling system only operates when the vehicle is moving, so that the turn signal lights will not self-cancel while you are stopped at an intersection.

Horn switch “ H ”

Press this switch to sound the horn.

EAU12500

Engine stop switch “ O/X ”

Set this switch to “ O ” before starting the engine. Set this switch to “ X ” to stop the engine in case of an emergency, such as when the vehicle overturns or when the throttle cable is stuck.

EAU12660

Start switch “ S ”

Push this switch to crank the engine with the starter.

EAU12710

CAUTION: _____

See page 5-1 for starting instructions prior to starting the engine.

ECA10050

INSTRUMENT AND CONTROL FUNCTIONS

Clutch lever

EAU12820

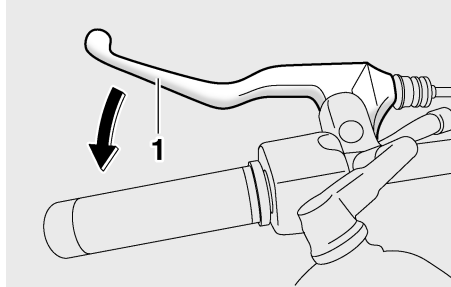

1. Clutch lever

The clutch lever is located at the left handlebar grip. To disengage the clutch, pull the lever toward the handlebar grip. To engage the clutch, release the lever. The lever should be pulled rapidly and released slowly for smooth clutch operation.

The clutch lever is equipped with a clutch switch, which is part of the ignition circuit cut-off system. (See page 3-17.)

Shift pedal

EAU12880

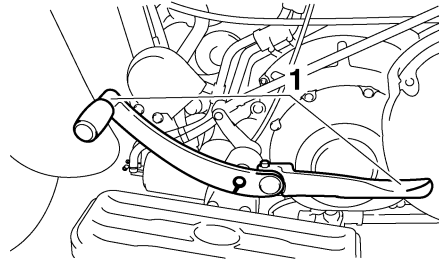

1. Shift pedal

The shift pedal is located on the left side of the engine and is used in combination with the clutch lever when shifting the gears of the 5-speed constant-mesh transmission equipped on this motorcycle.

NOTE: _____
Use your toes or heel to shift up and your toes to shift down.

Brake lever

EAU12890

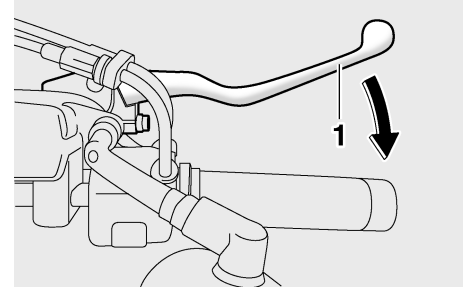

1. Brake lever

The brake lever is located at the right handlebar grip. To apply the front brake, pull the lever toward the handlebar grip.

INSTRUMENT AND CONTROL FUNCTIONS

Brake pedal

EAU12941

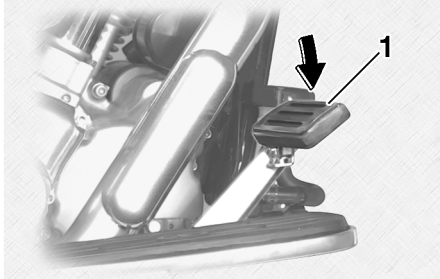

1. Brake pedal

The brake pedal is on the right side of the motorcycle. To apply the rear brake, press down on the brake pedal.

Fuel tank cap

EAU13120

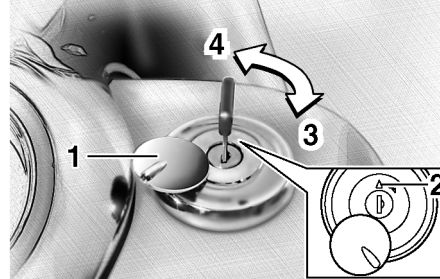

1. Fuel tank cap lock cover
2. “△” mark
3. Unlock.
4. Lock.

To remove the fuel tank cap

Slide the lock cover open, insert the key into the lock, and then turn it 1/4 turn clockwise. The lock will be released and the fuel tank cap can be removed.

To install the fuel tank cap

1. Insert the fuel tank cap into the tank opening with the key inserted in the lock and with the “△” mark facing forward.

2. Turn the key counterclockwise to the original position, remove it, and then close the lock cover.

NOTE: _____

The fuel tank cap cannot be installed unless the key is in the lock. In addition, the key cannot be removed if the cap is not properly installed and locked.

EWA10130

WARNING _____

Make sure that the fuel tank cap is properly installed before riding.

INSTRUMENT AND CONTROL FUNCTIONS

Fuel

EAU13210

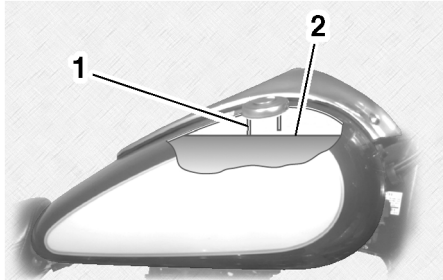

1. Fuel tank filler tube
2. Fuel level

Make sure that there is sufficient fuel in the tank. Fill the fuel tank to the bottom of the filler tube as shown.

EWA10880

⚠ WARNING

- Do not overfill the fuel tank, otherwise it may overflow when the fuel warms up and expands.
- Avoid spilling fuel on the hot engine.

ECA10070

CAUTION:

Immediately wipe off spilled fuel with a clean, dry, soft cloth, since fuel may deteriorate painted surfaces or plastic parts.

EAU13300

Recommended fuel:

UNLEADED GASOLINE ONLY

Fuel tank capacity:

20.0 L (5.28 US gal) (4.40 Imp.gal)

Fuel reserve amount:

3.5 L (0.92 US gal) (0.77 Imp.gal)

ECA11400

CAUTION:

Use only unleaded gasoline. The use of leaded gasoline will cause severe damage to internal engine parts, such as the valves and piston rings, as well as to the exhaust system.

Your Yamaha engine has been designed to use regular unleaded gasoline with a pump octane number $[(R+M)/2]$ of 86 or higher, or a research octane number of 91 or higher. If

knocking (or pinging) occurs, use a gasoline of a different brand or premium unleaded fuel. Use of unleaded fuel will extend spark plug life and reduce maintenance costs.

Gasohol

There are two types of gasohol: gasohol containing ethanol and that containing methanol. Gasohol containing ethanol can be used if the ethanol content does not exceed 10%. Gasohol containing methanol is not recommended by Yamaha because it can cause damage to the fuel system or vehicle performance problems.

INSTRUMENT AND CONTROL FUNCTIONS

EAU13560

Fuel cock

The fuel cock supplies fuel from the tank to the carburetor while filtering it also.

The fuel cock has three positions:

OFF



1. Pointed end positioned over "OFF"

With the lever in this position, fuel will not flow. Always return the lever to this position when the engine is not running.

ON

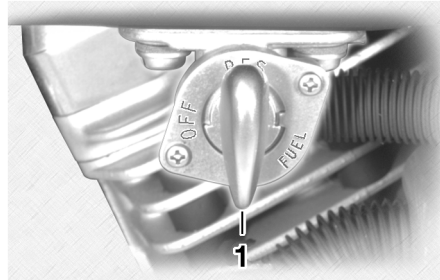

1. Pointed end positioned over "ON"

With the lever in this position, fuel flows to the carburetor. Normal riding is done with the lever in this position.

RES

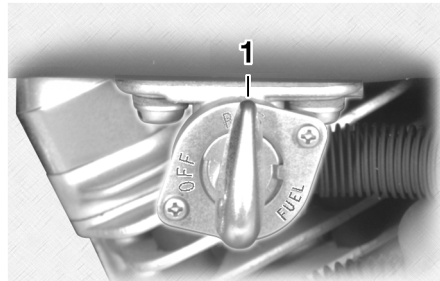

1. Pointed end positioned over "RES"

This indicates reserve. If you run out of fuel while riding, move the lever to this position. Fill the tank at the first opportunity. Be sure to set the lever back to "ON" after refueling!

INSTRUMENT AND CONTROL FUNCTIONS

Starter (choke) knob “”

EAU13600

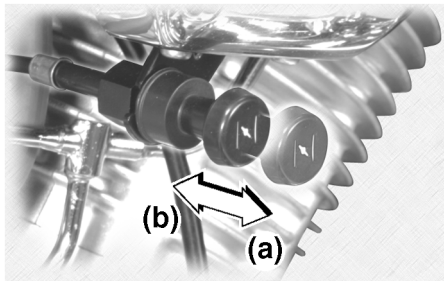

3

Starting a cold engine requires a richer air-fuel mixture, which is supplied by the starter (choke). Move the knob in direction (a) to turn on the starter (choke). Move the knob in direction (b) to turn off the starter (choke).

Locking the steering with a padlock

EAU13780

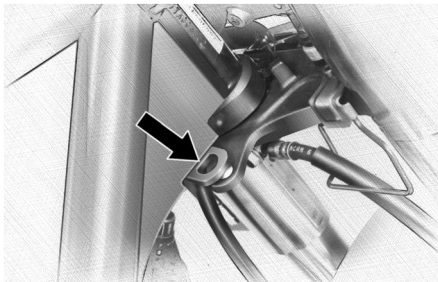

In addition to the main switch/steering lock, there are brackets on the right side of the steering head pipe for locking the steering with a padlock. To do so, turn the handlebar until the holes in the two brackets are aligned, and then lock the steering with a suitable padlock.

Rider seat

EAU14152

To remove the rider seat

1. Turn the key to “OFF”, and then turn it to “OPEN”.

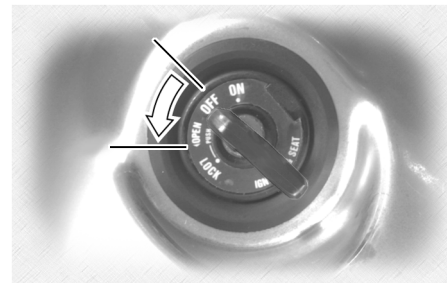

NOTE: _____
Do not push inward when turning the key.

2. Pull the rider seat off.

To install the rider seat

1. Insert the projection on the rear of the rider seat into the seat holder as shown, and then push the front of the seat down to lock it in place.

INSTRUMENT AND CONTROL FUNCTIONS

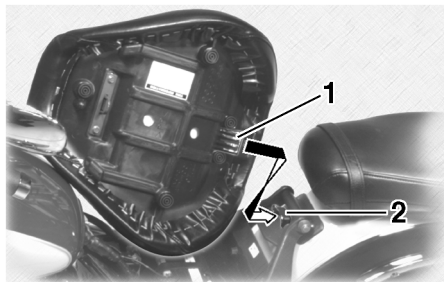

1. Projection
2. Seat holder

2. Remove the key from the main switch if the motorcycle will be left unattended.

NOTE: _____
Make sure that the rider seat is properly secured before riding.

Helmet holder

EAU14320

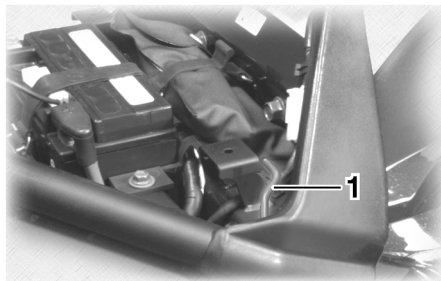

1. Helmet holder

The helmet holder is located under the rider seat.

To secure a helmet to the helmet holder

1. Remove the rider seat. (See page 3-10.)
2. Attach the helmet to the helmet holder, and then securely install the seat.

EWA10160

! WARNING

Never ride with a helmet attached to the helmet holder, since the helmet may hit objects, causing loss of control and possibly an accident.

INSTRUMENT AND CONTROL FUNCTIONS

EAU14580

Windshield

[XV17ATV(C)/XV17ATMV(C)]

To suit the rider's preference, the windshield angle can be adjusted and the height can be changed to one of two positions.

3

To adjust the windshield angle

1. Loosen the bolts on each side of the windshield.



1. Windshield
2. Bolt

2. Move the windshield to the desired angle.
3. Tighten the bolts to the specified torque.

To change the windshield height

1. Remove the bolts on each side of the windshield.
2. Move the windshield to the other position.
3. Install the bolts and tighten them to the specified torque.

Tightening torque:

Windshield bolt:
16 Nm (1.6 m·kgf, 12 ft·lbf)

4. Loosen the screws holding the windshield cover located above the headlight, position the cover close to the headlight without touching it, and then tighten the screws.

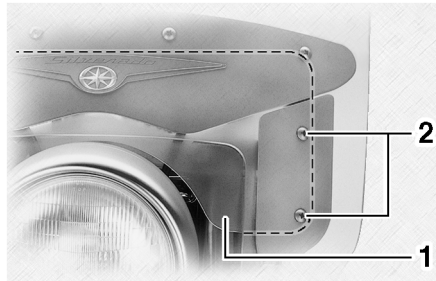

1. Windshield cover
2. Screw

EWA10920

! WARNING

After adjusting the windshield:

- Securely tighten the windshield bolts.
- Turn the handlebar to the left and right to make sure that the handlebar is not obstructed and that the windshield does not contact any other parts.
- Open the throttle and make sure that the throttle grip returns properly when released, otherwise an accident or injury could result.

INSTRUMENT AND CONTROL FUNCTIONS

Saddlebags [XV17ATV(C)]

EAU14613

EWA11111

WARNING

Improper loading or overloading can cause loss of control and possibly an accident or personal injury. See pages 1-5 and 6-17 for important loading and tire pressure information.

- Always securely close each saddlebag before riding.
- Distribute weight evenly on each side of the motorcycle.
- Do not exceed the load limit of 5 kg (11 lb) for each saddlebag.
- Do not exceed the maximum load of 179 kg (395 lb) for the vehicle.
- Do not exceed 120 km/h (80 mi/h) when riding with luggage in the sidecases, otherwise handling could be affected. Improper loading, poor tire or overall motorcycle conditions, poor road surfaces or adverse weather conditions may make it necessary to further reduce the riding speed.

To open a saddlebag

Unbuckle the belts and fold up the flap.

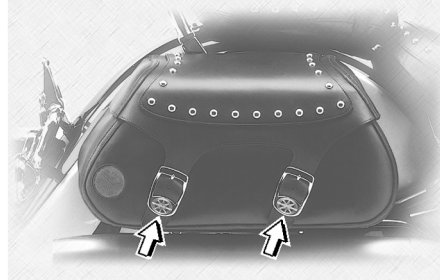

To close a saddlebag

Fold the flap down and buckle both belts securely.

NOTE:

For saddlebag cleaning and care, see page 7-1.

Sidecases [XV17ATMV(C)]

EAU35890

EWA12520

WARNING

Improper loading or overloading can cause loss of control and possibly an accident or personal injury. See pages 1-5 and 6-17 for important loading and tire pressure information.

- Always securely close the sidecases before riding.
- Distribute weight evenly on each side of the motorcycle.
- Do not exceed the load limit of 5 kg (11 lb) for each sidecase.
- Do not exceed the maximum load of 179 kg (395 lb) for the vehicle.
- Do not exceed 120 km/h (80 mi/h) when riding with luggage in the sidecases, otherwise handling could be affected. Improper loading, poor tire or overall motorcycle conditions, poor road surfaces or adverse weather conditions may make it necessary to further reduce the riding speed.

INSTRUMENT AND CONTROL FUNCTIONS

To open a sidecase

1. Insert the key into the lock, turn it counterclockwise, and then push it in.

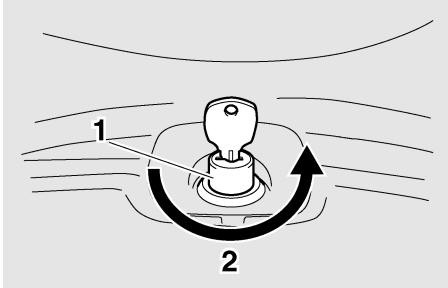

1. Sidecase lock
2. Unlock.

2. Fold the sidecase lid up.

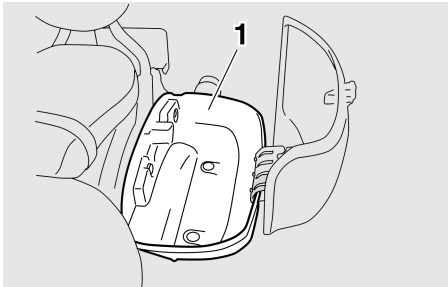

1. Storage compartment

To close a sidecase

1. Fold the sidecase lid down.
2. Turn the key clockwise, and then remove it.

NOTE: _____
Push the lid down so that the latch snaps into place.

ECA13090

CAUTION: _____
To avoid locking the key in, never lock either sidecase and remove the key from the lock before closing the lid.

EAU14811

Adjusting the shock absorber assembly

This shock absorber assembly is equipped with a spring preload adjusting nut.

ECA10100

CAUTION: _____
Never attempt to turn an adjusting mechanism beyond the maximum or minimum settings.

Adjust the spring preload as follows.

1. Loosen the locknut.

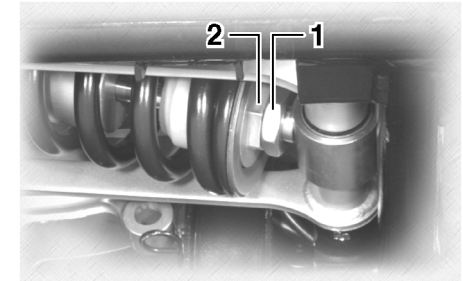

1. Locknut
2. Spring preload adjusting nut

2. To increase the spring preload and thereby harden the suspension, turn the adjusting nut in direction (a). To decrease the spring pre-

INSTRUMENT AND CONTROL FUNCTIONS

ECA10120

load and thereby soften the suspension, turn the adjusting nut in direction (a).
load and thereby stiffen the suspension, turn the adjusting nut in direction (b).

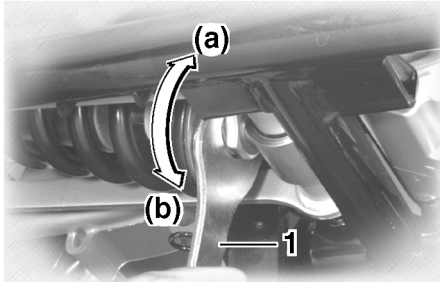

1. Special wrench

NOTE:

The spring preload setting is determined by measuring distance A, shown in the illustration. The shorter distance A is, the lower the spring preload; the longer distance A is, the higher the spring preload.

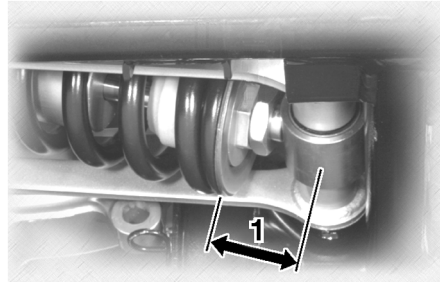

1. Distance A

Spring preload:

Minimum (soft):

Distance A = 42.5 mm (1.67 in)

Standard:

XV17AV(C)/XV17AWV(C)/

XV17AMV(C)

Distance A = 42.5 mm (1.67 in)

XV17ATV(C)/XV17ATMV(C)

Distance A = 45.5 mm (1.79 in)

Maximum (hard):

Distance A = 51.5 mm (2.03 in)

3. Tighten the locknut to the specified torque.

Tightening torque:

Locknut:

35 Nm (3.5 m·kgf, 25 ft·lbf)

CAUTION:

Always tighten the locknut against the adjusting nut, and then tighten the locknut to the specified torque.

EWA10220

WARNING

This shock absorber contains highly pressurized nitrogen gas. For proper handling, read and understand the following information before handling the shock absorber. The manufacturer cannot be held responsible for property damage or personal injury that may result from improper handling.

- Do not tamper with or attempt to open the gas cylinder.
- Do not subject the shock absorber to an open flame or other high heat sources, otherwise it may explode due to excessive gas pressure.
- Do not deform or damage the gas cylinder in any way, as this will result in poor damping performance.

3

INSTRUMENT AND CONTROL FUNCTIONS

- Always have a Yamaha dealer service the shock absorber.
-

Sidestand

EAU15301

The sidestand is located on the left side of the frame. Raise the sidestand or lower it with your foot while holding the vehicle upright.

NOTE:

The built-in sidestand switch is part of the ignition circuit cut-off system, which cuts the ignition in certain situations. (See further down for an explanation of the ignition circuit cut-off system.)

EWA10240



The vehicle must not be ridden with the sidestand down, or if the sidestand cannot be properly moved up (or does not stay up), otherwise the sidestand could contact the ground and distract the operator, resulting in a possible loss of control. Yamaha's ignition circuit cut-off system has been designed to assist the operator in fulfilling the responsibility of raising the sidestand before starting off. Therefore, check this system regularly as described

below and have a Yamaha dealer repair it if it does not function properly.

EAU15311

Ignition circuit cut-off system

The ignition circuit cut-off system (comprising the sidestand switch, clutch switch and neutral switch) has the following functions.

- It prevents starting when the transmission is in gear and the sidestand is up, but the clutch lever is not pulled.
- It prevents starting when the transmission is in gear and the clutch lever is pulled, but the sidestand is still down.
- It cuts the running engine when the transmission is in gear and the sidestand is moved down.

Periodically check the operation of the ignition circuit cut-off system according to the following procedure.

EWA10250



If a malfunction is noted, have a Yamaha dealer check the system before riding.

INSTRUMENT AND CONTROL FUNCTIONS

3

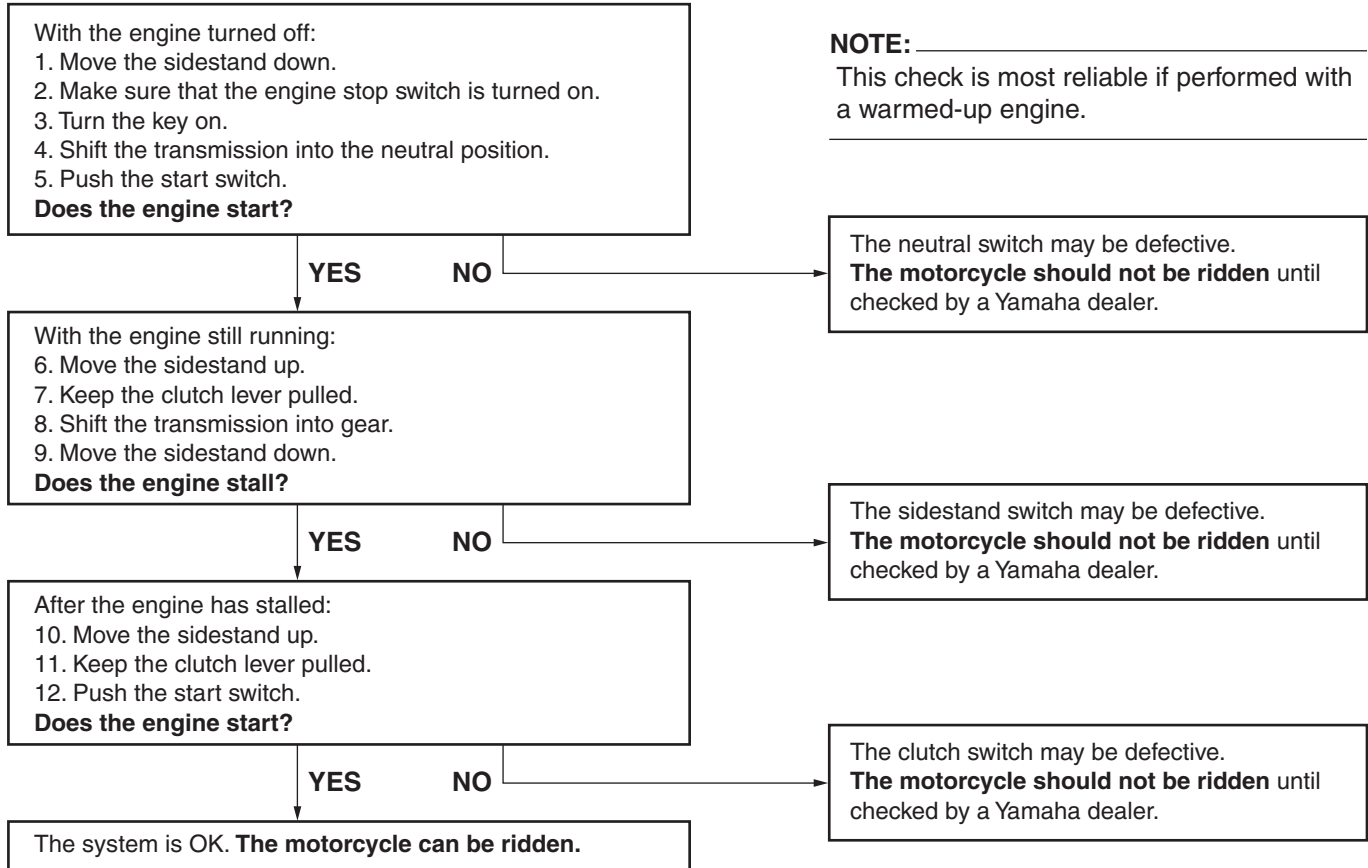

PRE-OPERATION CHECKS

EAU15591

The condition of a vehicle is the owner's responsibility. Vital components can start to deteriorate quickly and unexpectedly, even if the vehicle remains unused (for example, as a result of exposure to the elements). Any damage, fluid leakage or loss of tire air pressure could have serious consequences. Therefore, it is very important, in addition to a thorough visual inspection, to check the following points before each ride.

NOTE: _____

Pre-operation checks should be made each time the vehicle is used. Such an inspection can be accomplished in a very short time; and the added safety it assures is more than worth the time involved.

EWA11150



If any item in the Pre-operation check list is not working properly, have it inspected and repaired before operating the vehicle.

PRE-OPERATION CHECKS

EAU15603

Pre-operation check list

ITEM	CHECKS	PAGE
Fuel	<ul style="list-style-type: none">• Check fuel level in fuel tank.• Refuel if necessary.• Check fuel line for leakage.	3-8
Engine oil	<ul style="list-style-type: none">• Check oil level in engine.• If necessary, add recommended oil to specified level.• Check vehicle for oil leakage.	6-10
Transfer case oil	<ul style="list-style-type: none">• Check vehicle for oil leakage.	6-13
4 Front brake	<ul style="list-style-type: none">• Check operation.• If soft or spongy, have Yamaha dealer bleed hydraulic system.• Check lever free play.• Adjust if necessary.• Check brake pads for wear.• Replace if necessary.• Check fluid level in reservoir.• If necessary, add recommended brake fluid to specified level.• Check hydraulic system for leakage.	6-24, 6-25, 6-26
Rear brake	<ul style="list-style-type: none">• Check operation.• If soft or spongy, have Yamaha dealer bleed hydraulic system.• Check brake pads for wear.• Replace if necessary.• Check fluid level in reservoir.• If necessary, add recommended brake fluid to specified level.• Check hydraulic system for leakage.	6-25, 6-26
Clutch	<ul style="list-style-type: none">• Check operation.• Lubricate cable if necessary.• Check lever free play.• Adjust if necessary.	6-23

PRE-OPERATION CHECKS

ITEM	CHECKS	PAGE
Throttle grip	<ul style="list-style-type: none"> • Make sure that operation is smooth. • Check cable free play. • If necessary, have Yamaha dealer adjust cable free play and lubricate cable and grip housing. 	6-17, 6-29
Control cables	<ul style="list-style-type: none"> • Make sure that operation is smooth. • Lubricate if necessary. 	6-29
Wheels and tires	<ul style="list-style-type: none"> • Check for damage. • Check tire condition and tread depth. • Check air pressure. • Correct if necessary. 	6-17, 6-22
Brake and shift pedals	<ul style="list-style-type: none"> • Make sure that operation is smooth. • Lubricate pedal pivoting points if necessary. 	6-29
Brake and clutch levers	<ul style="list-style-type: none"> • Make sure that operation is smooth. • Lubricate lever pivoting points if necessary. 	6-30
Sidestand	<ul style="list-style-type: none"> • Make sure that operation is smooth. • Lubricate pivot if necessary. 	6-31
Chassis fasteners	<ul style="list-style-type: none"> • Make sure that all nuts, bolts and screws are properly tightened. • Tighten if necessary. 	—
Instruments, lights, signals and switches	<ul style="list-style-type: none"> • Check operation. • Correct if necessary. 	—
Sidestand switch	<ul style="list-style-type: none"> • Check operation of ignition circuit cut-off system. • If system is defective, have Yamaha dealer check vehicle. 	3-16

OPERATION AND IMPORTANT RIDING POINTS

EAU15950

EAU16390

EWA10270

WARNING

- **Become thoroughly familiar with all operating controls and their functions before riding. Consult a Yamaha dealer regarding any control or function that you do not thoroughly understand.**
- **Never start the engine or operate it in a closed area for any length of time. Exhaust fumes are poisonous, and inhaling them can cause loss of consciousness and death within a short time. Always make sure that there is adequate ventilation.**
- **Before starting out, make sure that the sidestand is up. If the sidestand is not raised completely, it could contact the ground and distract the operator, resulting in a possible loss of control.**

Starting and warming up a cold engine

In order for the ignition circuit cut-off system to enable starting, one of the following conditions must be met:

- The transmission is in the neutral position.
- The transmission is in gear with the clutch lever pulled and the sidestand up.

EWA10290

WARNING

- **Before starting the engine, check the function of the ignition circuit cut-off system according to the procedure described on page 3-17.**
- **Never ride with the sidestand down.**

1. Turn the fuel cock lever to “ON”.
2. Turn the key to “ON” and make sure that the engine stop switch is set to “○”.
3. Shift the transmission into the neutral position.

NOTE: _____

When the transmission is in the neutral position, the neutral indicator light should be on, otherwise have a Yamaha dealer check the electrical circuit.

4. Turn the starter (choke) on and completely close the throttle. (See page 3-10.)
5. Start the engine by pushing the start switch.

NOTE: _____

If the engine fails to start, release the start switch, wait a few seconds, and then try again. Each starting attempt should be as short as possible to preserve the battery. Do not crank the engine more than 10 seconds on any one attempt.

ECA11370

CAUTION: _____

The engine trouble warning light should come on when the key is turned to “ON”, and then go off after a few seconds. If the engine trouble warning light comes on or flashes

OPERATION AND IMPORTANT RIDING POINTS

after starting, immediately stop the engine, and have a Yamaha dealer check the self-diagnosis system.

6. After starting the engine, move the starter (choke) back halfway.

ECA11130

CAUTION:

For maximum engine life, always warm the engine up before starting off. Never accelerate hard when the engine is cold!

7. When the engine is warm, turn the starter (choke) off.

NOTE:

The engine is warm when it responds normally to the throttle with the starter (choke) turned off. To avoid the possibility of excessive exhaust emissions, never leave the starter (choke) on longer than necessary. The time necessary for starter (choke) use depends upon the ambient temperature. Temperatures above 10 °C (50 °F) require about 7 seconds of starter (choke) use and temperatures below 10 °C (50 °F) require about 35 seconds with the starter

(choke) turned on, then about 2.5 minutes with the starter (choke) in the half-way position.

Starting a warm engine

EAU16640

Follow the same procedure as for starting a cold engine with the exception that the starter (choke) is not required when the engine is warm.

OPERATION AND IMPORTANT RIDING POINTS

Shifting

EAU16671

ECA10260

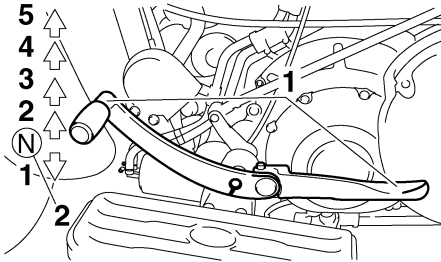

1. Shift pedal
2. Neutral position

Shifting gears lets you control the amount of engine power available for starting off, accelerating, climbing hills, etc.

The gear positions are shown in the illustration.

NOTE:

To shift the transmission into the neutral position, press the shift pedal down repeatedly until it reaches the end of its travel, and then slightly raise it.

CAUTION:

- Even with the transmission in the neutral position, do not coast for long periods of time with the engine off, and do not tow the motorcycle for long distances. The transmission is properly lubricated only when the engine is running. Inadequate lubrication may damage the transmission.
- Always use the clutch while changing gears to avoid damaging the engine, transmission, and drive train, which are not designed to withstand the shock of forced shifting.

To start out and accelerate

EAU16680

1. Pull the clutch lever to disengage the clutch.
2. Shift the transmission into first gear. The neutral indicator light should go out.
3. Open the throttle gradually, and at the same time, release the clutch lever slowly.

4. At the recommended shift points shown in the following table, close the throttle, and at the same time, quickly pull the clutch lever in.
5. Shift the transmission into second gear. (Make sure not to shift the transmission into the neutral position.)
6. Open the throttle part way and gradually release the clutch lever.
7. Follow the same procedure when shifting to the next higher gear.

NOTE:

Always shift gears at the recommended shift points.

To decelerate

EAU16700

1. Apply both the front and the rear brakes to slow the motorcycle.
2. Shift the transmission into first gear when the motorcycle reaches 25 km/h (16 mi/h). If the engine is about to stall or runs very roughly, pull the clutch lever in and use the brakes to stop the motorcycle.

OPERATION AND IMPORTANT RIDING POINTS

- Shift the transmission into the neutral position when the motorcycle is almost completely stopped. The neutral indicator light should come on.

EAU16720

Recommended shift points

The recommended shift points during acceleration and deceleration are shown in the table below.

Shift up points:

- 1st → 2nd: 20 km/h (13 mi/h)
- 2nd → 3rd: 30 km/h (19 mi/h)
- 3rd → 4th: 40 km/h (25 mi/h)
- 4th → 5th: 50 km/h (31 mi/h)

Shift down points:

- 5th → 4th: 25 km/h (16 mi/h)
- 4th → 3rd: 25 km/h (16 mi/h)
- 3rd → 2nd: 25 km/h (16 mi/h)
- 2nd → 1st: 25 km/h (16 mi/h)

Engine break-in

EAU16841

There is never a more important period in the life of your engine than the period between 0 and 1600 km (1000 mi). For this reason, you should read the following material carefully.

Since the engine is brand new, do not put an excessive load on it for the first 1600 km (1000 mi). The various parts in the engine wear and polish themselves to the correct operating clearances. During this period, prolonged full-throttle operation or any condition that might result in engine overheating must be avoided.

EAU17071

0–1000 km (0–600 mi)

Avoid prolonged operation above 1/3 throttle.

1000–1600 km (600–1000 mi)

Avoid prolonged operation above 1/2 throttle.

ECA10891

CAUTION:

After 1000 km (600 mi) of operation, the engine oil and transfer case oil must be changed, and the oil filter cartridge or element replaced.

1600 km (1000 mi) and beyond

The vehicle can now be operated normally.

ECA10270

CAUTION:

If any engine trouble should occur during the engine break-in period, immediately have a Yamaha dealer check the vehicle.

OPERATION AND IMPORTANT RIDING POINTS

EAU17170

Parking

When parking, stop the engine, remove the key from the main switch, and then turn the fuel cock lever to “OFF”.

EWA10310

WARNING

- **Since the engine and exhaust system can become very hot, park in a place where pedestrians or children are not likely to touch them.**
- **Do not park on a slope or on soft ground, otherwise the vehicle may overturn.**

PERIODIC MAINTENANCE AND MINOR REPAIR

EAU17231

Safety is an obligation of the owner. Periodic inspection, adjustment and lubrication will keep your vehicle in the safest and most efficient condition possible. The most important points of motorcycle inspection, adjustment, and lubrication are explained on the following pages.

Maintenance, replacement, or repair of the emission control devices and systems may be performed by any repair establishment or individual that is certified (if applicable).

EWA10320

WARNING

If you are not familiar with maintenance work, have a Yamaha dealer do it for you.

EAU17301

PERIODIC MAINTENANCE

PROPER PERIODIC MAINTENANCE OF YOUR VEHICLE IS IMPORTANT IN ORDER TO ENJOY LONG, PLEASURABLE SERVICE. ESPECIALLY IMPORTANT ARE THE MAINTENANCE SERVICES RELATED TO EMISSIONS CONTROL. THESE CONTROLS NOT ONLY FUNCTION TO ENSURE CLEANER AIR, BUT ARE ALSO VITAL TO PROPER ENGINE OPERATION AND MAXIMUM PERFORMANCE. IN THE FOLLOWING PERIODIC MAINTENANCE CHARTS, THE SERVICES RELATED TO EMISSIONS CONTROL ARE GROUPED SEPARATELY. THESE SERVICES REQUIRE SPECIALIZED DATA, KNOWLEDGE, AND EQUIPMENT. YAMAHA DEALERS ARE TRAINED AND EQUIPPED TO PERFORM THESE PARTICULAR SERVICES.

EAU17350

Owner's tool kit

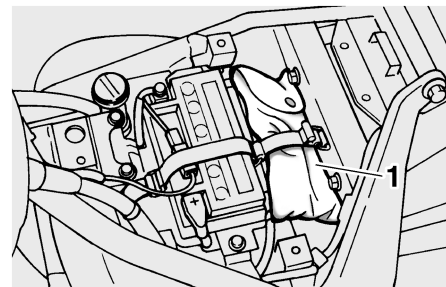

1. Owner's tool kit

The owner's tool kit is located under the rider seat. (See page 3-10.)

The service information included in this manual and the tools provided in the owner's tool kit are intended to assist you in the performance of preventive maintenance and minor repairs. However, additional tools such as a torque wrench may be necessary to perform certain maintenance work correctly.

NOTE:

If you do not have the tools or experience required for a particular job, have a Yamaha dealer perform it for you.

PERIODIC MAINTENANCE AND MINOR REPAIR

EWA10340

WARNING

Modifications not approved by Yamaha may cause loss of performance, excessive emissions, and render the vehicle unsafe for use. Consult a Yamaha dealer before attempting any changes.

PERIODIC MAINTENANCE AND MINOR REPAIR

EAU17600

Periodic maintenance chart for the emission control system

No.	ITEM	ROUTINE	INITIAL	ODOMETER READINGS				
			600 mi (1000 km) or 1 month	4000 mi (7000 km) or 6 months	8000 mi (13000 km) or 12 months	12000 mi (19000 km) or 18 months	16000 mi (25000 km) or 24 months	20000 mi (31000 km) or 30 months
1	* Fuel line	<ul style="list-style-type: none"> • Check fuel hoses for cracks or damage. • Replace if necessary. 		√	√	√	√	√
2	* Fuel filter	<ul style="list-style-type: none"> • Replace. 						Replace.
3	Spark plugs	<ul style="list-style-type: none"> • Check condition. • Adjust gap and clean. • Replace every 8000 mi (13000 km) or 12 months. 		√	Replace.	√	Replace.	√
4	* Valve clearance	<ul style="list-style-type: none"> • Check and adjust valve clearance when engine is cold. • Adjust if necessary. 	Every 16000 mi (25000 km)					
5	* Crankcase breather system	<ul style="list-style-type: none"> • Check breather hose for cracks or damage. • Replace if necessary. 		√	√	√	√	√
6	* Idle speed	<ul style="list-style-type: none"> • Check and adjust engine idle speed. 	√	√	√	√	√	√
7	* Exhaust system	<ul style="list-style-type: none"> • Check for leakage. • Tighten if necessary. • Replace gasket(s) if necessary. 	√	√	√	√	√	√
8	* Evaporative emission control system (For California only)	<ul style="list-style-type: none"> • Check control system for damage. • Replace if necessary. 				√		

* Since these items require special tools, data and technical skills, have a Yamaha dealer perform the service.

PERIODIC MAINTENANCE AND MINOR REPAIR

EAU32183

General maintenance and lubrication chart

No.	ITEM	ROUTINE	INITIAL	ODOMETER READINGS				
			600 mi (1000 km) or 1 month	4000 mi (7000 km) or 6 months	8000 mi (13000 km) or 12 months	12000 mi (19000 km) or 18 months	16000 mi (25000 km) or 24 months	20000 mi (31000 km) or 30 months
1	* Air filter element	<ul style="list-style-type: none"> Clean with compressed air. Replace if necessary. 		√	√	√	√	√
2	* Clutch	<ul style="list-style-type: none"> Check operation. Adjust or replace cable. 	√	√	√	√	√	√
3	* Front brake	<ul style="list-style-type: none"> Check operation, fluid level, and for fluid leakage. Replace brake pads if necessary. 	√	√	√	√	√	√
4	* Rear brake	<ul style="list-style-type: none"> Check operation, fluid level, and for fluid leakage. Replace brake pads if necessary. 	√	√	√	√	√	√
5	* Brake hoses	<ul style="list-style-type: none"> Check for cracks or damage. Replace. 		√	√	√	√	√
			Every 4 years					
6	* Wheels (For cast wheel models)	<ul style="list-style-type: none"> Check runout and for damage. Replace if necessary. 		√	√	√	√	√
7	* Wheels (For spoke wheel model)	<ul style="list-style-type: none"> Check runout, spoke tightness and for damage. Tighten spokes if necessary. 		√	√	√	√	√
8	* Tires	<ul style="list-style-type: none"> Check tread depth and for damage. Replace if necessary. Check air pressure. Correct if necessary. 		√	√	√	√	√

PERIODIC MAINTENANCE AND MINOR REPAIR

No.	ITEM	ROUTINE	INITIAL	ODOMETER READINGS						
			600 mi (1000 km) or 1 month	4000 mi (7000 km) or 6 months	8000 mi (13000 km) or 12 months	12000 mi (19000 km) or 18 months	16000 mi (25000 km) or 24 months	20000 mi (31000 km) or 30 months		
9	*	Wheel bearings	<ul style="list-style-type: none"> Check bearings for smooth operation. Replace if necessary. 		√	√	√	√	√	
10	*	Swingarm pivot bearings	<ul style="list-style-type: none"> Check bearing assemblies for looseness. Moderately repack with lithium-soap-based grease. 			√		Repack.		
11	*	Drive belt	<ul style="list-style-type: none"> Check belt tension. Adjust if necessary. 	√	Every 2500 mi (4000 km)					
12	*	Steering bearings	<ul style="list-style-type: none"> Check bearing assemblies for looseness. Moderately repack with lithium-soap-based grease every 16000 mi (25000 km) or 24 months. 	√	√	√	√	Repack.	√	
13	*	Chassis fasteners	<ul style="list-style-type: none"> Check all chassis fitting and fasteners. Correct if necessary. 		√	√	√	√	√	
14		Brake and clutch lever pivot shafts	<ul style="list-style-type: none"> Apply lithium-soap-based grease (all-purpose grease) lightly. 		√	√	√	√	√	
15		Brake and shift pedal pivot shafts	<ul style="list-style-type: none"> Apply lithium-soap-based grease (all-purpose grease) lightly. 		√	√	√	√	√	
16		Sidestand pivot	<ul style="list-style-type: none"> Check operation. Apply lithium-soap-based grease (all-purpose grease) lightly. 		√	√	√	√	√	
17	*	Sidestand switch	<ul style="list-style-type: none"> Check operation and replace if necessary. 	√	√	√	√	√	√	

PERIODIC MAINTENANCE AND MINOR REPAIR

No.	ITEM	ROUTINE	INITIAL	ODOMETER READINGS				
			600 mi (1000 km) or 1 month	4000 mi (7000 km) or 6 months	8000 mi (13000 km) or 12 months	12000 mi (19000 km) or 18 months	16000 mi (25000 km) or 24 months	20000 mi (31000 km) or 30 months
18	* Front fork	<ul style="list-style-type: none"> • Check operation and for oil leakage. • Replace if necessary. 		√	√	√	√	√
19	* Shock absorber assembly	<ul style="list-style-type: none"> • Check operation and for oil leakage. • Replace if necessary. 		√	√	√	√	√
20	* Rear suspension link pivots	<ul style="list-style-type: none"> • Apply lithium-soap-based grease lightly. 					√	
21	Engine oil	<ul style="list-style-type: none"> • Change (warm engine before draining). 	√	√	√	√	√	√
22	* Engine oil filter cartridge	<ul style="list-style-type: none"> • Replace. 	√		√		√	
23	* Transfer case oil	<ul style="list-style-type: none"> • Check for leakage. • Change at initial 600 mi (1000 km) or 1 month, and thereafter every 16000 mi (25000 km) or 24 months. 	Change.		√		Change.	
24	* Front and rear brake switches	<ul style="list-style-type: none"> • Check operation. 	√	√	√	√	√	√
25	* Control cables	<ul style="list-style-type: none"> • Apply Yamaha chain and cable lube or engine oil SAE 10W-30 thoroughly. 	√	√	√	√	√	√
26	* Throttle grip housing and cable	<ul style="list-style-type: none"> • Check operation and free play. • Adjust the throttle cable free play if necessary. • Lubricate the throttle grip housing and cable. 		√	√	√	√	√

PERIODIC MAINTENANCE AND MINOR REPAIR

No.	ITEM	ROUTINE	INITIAL	ODOMETER READINGS					
			600 mi (1000 km) or 1 month	4000 mi (7000 km) or 6 months	8000 mi (13000 km) or 12 months	12000 mi (19000 km) or 18 months	16000 mi (25000 km) or 24 months	20000 mi (31000 km) or 30 months	
27	* Lights, signals and switches	<ul style="list-style-type: none"> • Check operation. • Adjust headlight beam. 	√	√	√	√	√	√	

* Since these items require special tools, data and technical skills, have a Yamaha dealer perform the service.

NOTE:

From 24000 mi (37000 km) or 36 months, repeat the maintenance intervals starting from 8000 mi (13000 km) or 12 months.

EAU17630

NOTE:

- The air filter needs more frequent service if you are riding in unusually wet or dusty areas.
- Hydraulic brake service
 - After disassembling the brake master cylinders and calipers, always change the fluid. Regularly check the brake fluid levels and fill the reservoirs as required.
 - Every two years replace the internal components of the brake master cylinders and calipers, and change the brake fluid.
 - Replace the brake hoses every four years and if cracked or damaged.

PERIODIC MAINTENANCE AND MINOR REPAIR

Removing and installing the panel

EAU18751

The panel shown needs to be removed to perform some of the maintenance jobs described in this chapter. Refer to this section each time the panel needs to be removed and installed.

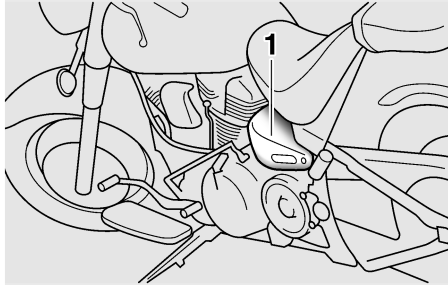

1. Panel A

Panel A

EAU19151

To remove the panel

Remove the bolt, and then pull the panel off as shown.

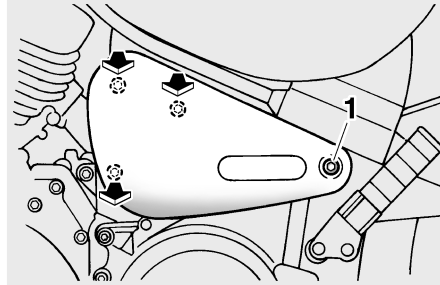

1. Bolt

To install the panel

Place the panel in the original position, and then install the bolt.

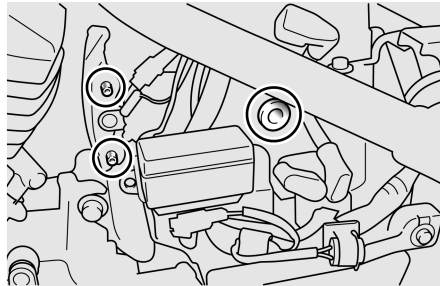

Checking the spark plugs

EAU19543

The spark plugs are important engine components, which are easy to check. Since heat and deposits will cause any spark plug to slowly erode, the spark plugs should be removed and checked in accordance with the periodic maintenance and lubrication chart. In addition, the condition of the spark plugs can reveal the condition of the engine.

To remove a spark plug

1. Remove the spark plug cap.

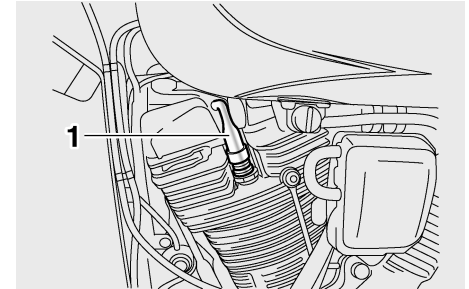

1. Spark plug cap

2. Remove the spark plug as shown, with the spark plug wrench included in the owner's tool kit.

PERIODIC MAINTENANCE AND MINOR REPAIR

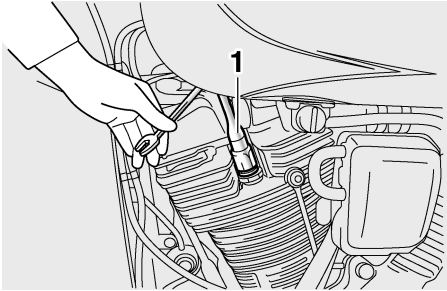

1. Spark plug wrench

To check the spark plugs

1. Check that the porcelain insulator around the center electrode on each spark plug is a medium-to-light tan (the ideal color when the vehicle is ridden normally).
2. Check that all spark plugs installed in the engine have the same color.

NOTE:

If any spark plug shows a distinctly different color, the engine could be defective. Do not attempt to diagnose such problems yourself. Instead, have a Yamaha dealer check the vehicle.

3. Check each spark plug for electrode erosion and excessive carbon or other deposits, and replace it if necessary.

Specified spark plug:
NGK/DPR7EA-9
DENSO/X22EPR-U9

To install a spark plug

1. Measure the spark plug gap with a wire thickness gauge and, if necessary, adjust the gap to specification.

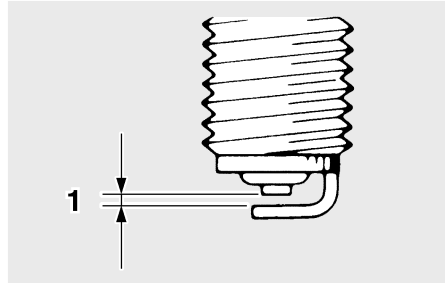

1. Spark plug gap

Spark plug gap:
0.8–0.9 mm (0.031–0.035 in)

2. Clean the surface of the spark plug gasket and its mating surface, and then wipe off any grime from the spark plug threads.
3. Install the spark plug with the spark plug wrench, and then tighten it to the specified torque.

Tightening torque:

Spark plug:
17.5 Nm (1.75 m-kgf, 12.7 ft-lbf)

NOTE:

If a torque wrench is not available when installing a spark plug, a good estimate of the correct torque is 1/4–1/2 turn past finger tight. However, the spark plug should be tightened to the specified torque as soon as possible.

4. Install the spark plug cap.

PERIODIC MAINTENANCE AND MINOR REPAIR

Canister (for California only)

EAU19681

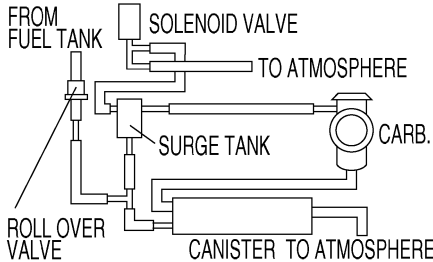

This model is equipped with a canister to prevent the discharging of fuel vapor into the atmosphere. Before operating this vehicle, make sure to check the following:

- Check each hose connection.
- Check each hose and canister for cracks or damage. Replace if damaged.
- Make sure that the canister breather is not blocked, and if necessary, clean it.

Engine oil and oil filter cartridge

EAU34080

The engine oil level should be checked before each ride. In addition, the oil must be changed and the oil filter cartridge replaced at the intervals specified in the periodic maintenance and lubrication chart.

To check the engine oil level

1. Place the vehicle on a level surface and hold it in an upright position.

NOTE:

Make sure that the vehicle is positioned straight up when checking the oil level. A slight tilt to the side can result in a false reading.

2. Remove the rider seat. (See page 3-10.)
3. Start the engine, warm it up until the engine oil has reached a normal temperature of 60 °C (140 °F), let it continue to idle for ten seconds, and then turn the engine off.

NOTE:

To achieve the proper engine oil temperature for an accurate oil level reading, the engine must have first completely cooled down, and then warmed up again for several minutes to normal operating temperature.

4. Wait a few minutes until the oil settles, remove the oil filler cap, wipe the dipstick clean, insert it back into the oil filler hole (without screwing it in), and then remove it again to check the oil level.

NOTE:

The engine oil should be between the minimum and maximum level marks.

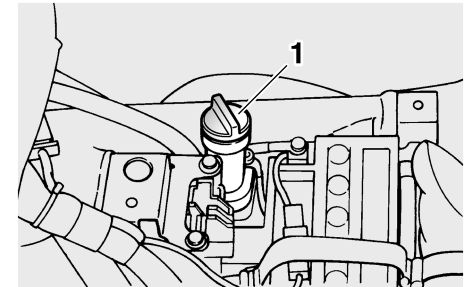

1. Engine oil filler cap

PERIODIC MAINTENANCE AND MINOR REPAIR

ECA10900

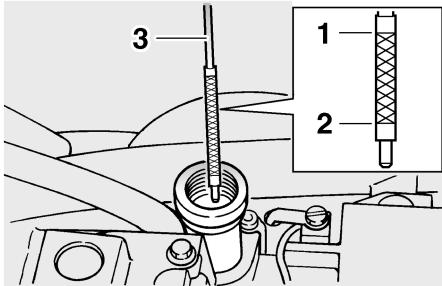

1. Maximum level mark
2. Minimum level mark
3. Dipstick

5. If the engine oil is at or below the minimum level mark, add sufficient oil of the recommended type to raise it to the correct level.

NOTE: When adding oil, be careful not to over-fill the engine oil tank; the oil level rises faster starting from the half level portion on the dipstick.

6. Insert the dipstick into the oil filler hole, and then tighten the oil filler cap.
7. Install the rider seat.

CAUTION:

Make sure that the oil filler cap is securely tightened, otherwise oil may seep out when the engine is running.

To change the engine oil (with or without oil filter cartridge replacement)

1. Remove the rider seat. (See page 3-10.)
2. Start the engine, warm it up for several minutes, and then turn it off.
3. Place an oil pan under the oil tank to collect the used oil.
4. Remove the engine oil filler cap and drain bolt to drain the oil from the oil tank.

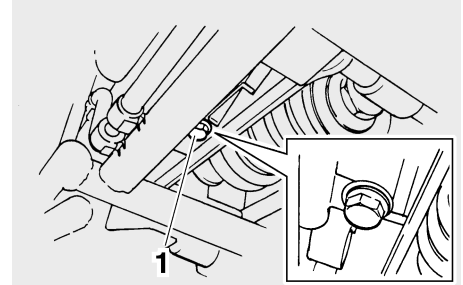

1. Engine oil drain bolt (oil tank)

5. Place an oil pan under the engine to collect the used oil.
6. Remove the engine oil drain bolt to drain the oil from the crankcase.

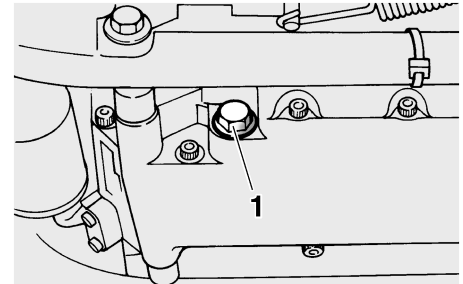

1. Engine oil drain bolt (crankcase)

PERIODIC MAINTENANCE AND MINOR REPAIR

NOTE: _____

Skip steps 7–9 if the oil filter cartridge is not being replaced.

7. Remove the oil filter cartridge with an oil filter wrench.

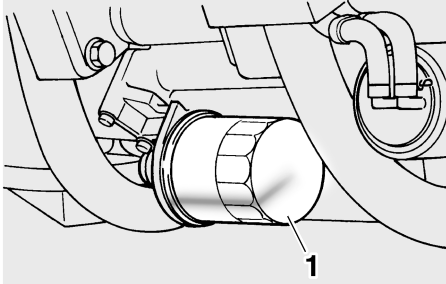

1. Oil filter cartridge

NOTE: _____

An oil filter wrench is available at a Yamaha dealer.

8. Apply a thin coat of engine oil to the O-ring of the new oil filter cartridge.

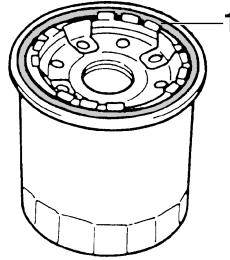

1. O-ring

NOTE: _____

Make sure that the O-ring is properly seated.

9. Install the new oil filter cartridge with an oil filter wrench, and then tighten it to the specified torque with a torque wrench.

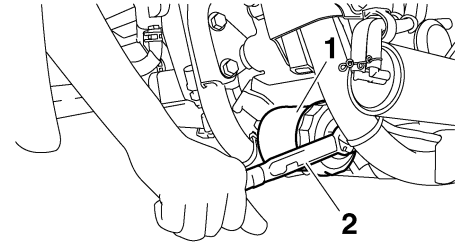

1. Oil filter cartridge
2. Torque wrench

Tightening torque:

Oil filter cartridge:
17 Nm (1.7 m·kgf, 12 ft·lbf)

10. Install the engine oil drain bolts, and then tighten them to the specified torque.

Tightening torque:

Engine oil drain bolt:
43 Nm (4.3 m·kgf, 31 ft·lbf)

11. Pour only 2.5 L (2.6 US qt) (2.2 Imp.qt) of the specified amount of recommended engine oil through the filler hole, insert the dipstick, and then tighten the oil filler cap.

PERIODIC MAINTENANCE AND MINOR REPAIR

EAU20042

12. Start the engine, rev it several times, and then turn it off.
13. Remove the engine oil filler cap, and then gradually fill the oil tank with the remaining oil quantity while regularly checking the oil level on the dipstick.

Recommended engine oil:

See page 8-1.

Oil quantity:

Without oil filter cartridge replacement:

3.70 L (3.91 US qt) (3.26 Imp.qt)

With oil filter cartridge replacement:

4.10 L (4.33 US qt) (3.61 Imp.qt)

ECA11620

CAUTION:

- **In order to prevent clutch slippage (since the engine oil also lubricates the clutch), do not mix any chemical additives. Do not use oils with a diesel specification of “CD” or oils of a higher quality than specified. In addition, do not use oils labeled “ENERGY CONSERVING II” or higher.**

● **Make sure that no foreign material enters the crankcase.**

14. Install the engine oil filler cap.
15. Start the engine, and then let it idle for several minutes while checking it for oil leakage. If oil is leaking, immediately turn the engine off and check for the cause.
16. Turn the engine off, and then check the oil level and correct it if necessary.
17. Install the rider seat.

Transfer case oil

The transfer case must be checked for oil leakage before each ride. If any leakage is found, have a Yamaha dealer check and repair the vehicle. In addition, the transfer case oil level should be checked and the oil must be changed at the intervals specified in the periodic maintenance and lubrication chart.

To check the transfer case oil level

1. Place the vehicle on a level surface and hold it in an upright position.

NOTE:

Make sure that the vehicle is positioned straight up when checking the oil level. A slight tilt to the side can result in a false reading.

2. Remove the oil check bolt, and then check the oil level in the transfer case.

NOTE:

The oil should be at the brim of the check hole.

PERIODIC MAINTENANCE AND MINOR REPAIR

3. If the oil is below the brim of the check hole, remove the oil filler cap, add sufficient oil of the recommended type to raise it to the correct level, and then install the oil filler cap.

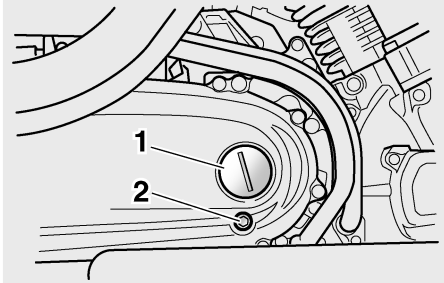

1. Transfer case oil filler cap
2. Transfer case oil level check bolt

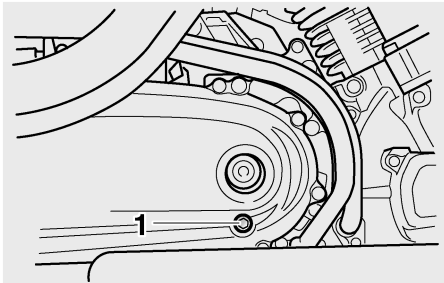

1. Transfer case oil check hole

4. Install the oil check bolt, and then tighten it to the specified torque.

Tightening torque:

Transfer case oil check bolt:
7.5 Nm (0.75 m·kgf, 5.4 ft·lbf)

To change the transfer case oil

1. Place an oil pan under the transfer case to collect the used oil.
2. Remove the drain bolt and the check bolt to drain the oil from the transfer case.

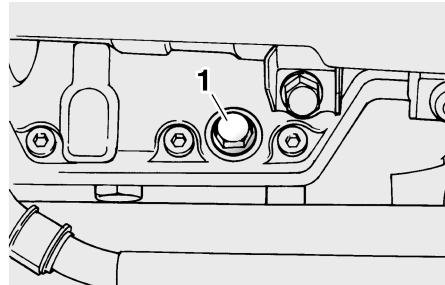

1. Transfer case oil drain bolt

3. Install the drain bolt and the check bolt, and then tighten the drain bolt to the specified torque.

Tightening torque:

Transfer case oil drain bolt:
17.5 Nm (1.75 m·kgf, 12.7 ft·lbf)

4. Remove the oil filler cap, add the specified amount of the recommended transfer case oil, and then install and tighten the oil filler cap.

Recommended transfer case oil:

See page 8-1.

Oil quantity:

0.40 L (0.42 US qt) (0.35 Imp.qt)

ECA10870

CAUTION:

Make sure that no foreign material enters the transfer case.

5. Start the engine and let it idle for several minutes while checking the transfer case for oil leakage. If oil is leaking, immediately turn the engine off and check for the cause.

PERIODIC MAINTENANCE AND MINOR REPAIR

EAU20655

Cleaning the air filter element

The air filter element should be cleaned at the intervals specified in the periodic maintenance and lubrication chart. Clean the air filter element more frequently if you are riding in unusually wet or dusty areas.

1. Remove the air filter case bolts.

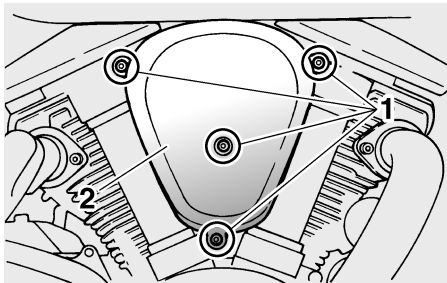

1. Bolt
2. Air filter case

2. Loosen the air filter case joint clamp screw, and then slightly pull the air filter case out.

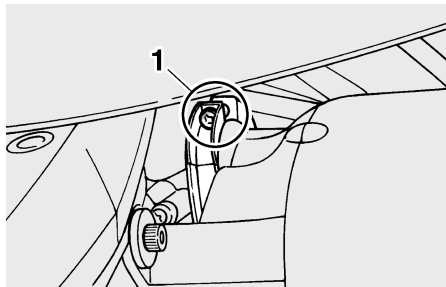

1. Air filter case joint clamp screw

3. Remove the air filter case cover by removing the screws.
4. Disconnect the hoses shown.

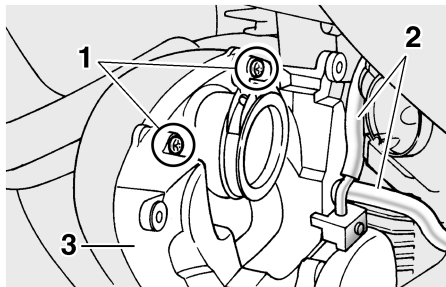

1. Screw
2. Hose
3. Air filter case cover

5. Remove the air filter element by removing the screws, and then disconnect the hose shown.

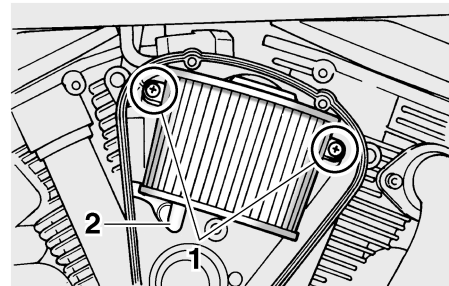

1. Screw
2. Hose

6. Lightly tap the air filter element to remove most of the dust and dirt, and then blow the remaining dirt out with compressed air as shown. If the air filter element is damaged, replace it.

PERIODIC MAINTENANCE AND MINOR REPAIR

EAU21251

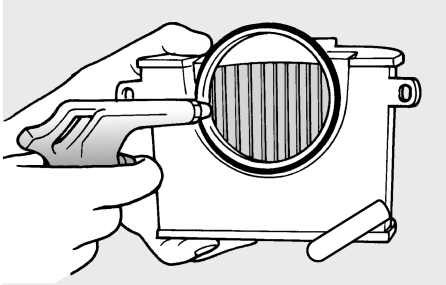

7. Install the air filter element by inserting it into the air filter case, then installing the screws, and then connect the hose shown.

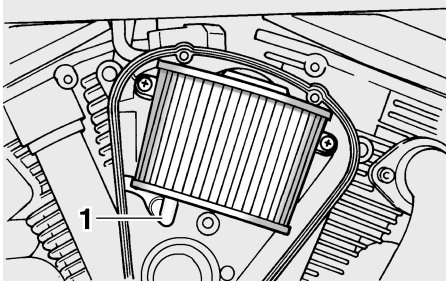

1. Hose

8. Install the air filter case cover by installing the screws.
9. Connect the hoses shown.

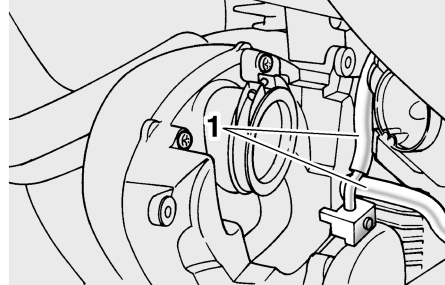

1. Hose

10. Push the air filter case onto the air filter case joint, and then tighten the clamp screw.
11. Install the air filter case bolts.

Carburetor

The carburetor is an important part of the engine and its emission control system, which requires very sophisticated adjustment. Therefore, carburetor adjustments should be left to Yamaha dealer, who has the necessary professional knowledge and experience.

Checking the throttle cable free play

EAU21381

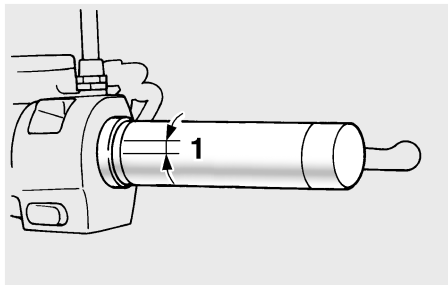

1. Throttle cable free play

The throttle cable free play should measure 4.0–6.0 mm (0.16–0.24 in) at the throttle grip. Periodically check the throttle cable free play and, if necessary, have a Yamaha dealer adjust it.

Valve clearance

EAU21401

The valve clearance changes with use, resulting in improper air-fuel mixture and/or engine noise. To prevent this from occurring, the valve clearance must be adjusted by a Yamaha dealer at the intervals specified in the periodic maintenance and lubrication chart.

Tires (For spoke wheel model)

EAU32520

To maximize the performance, durability, and safe operation of your motorcycle, note the following points regarding the specified tires.

Tire air pressure

The tire air pressure should be checked and, if necessary, adjusted before each ride.

EWA10500

⚠ WARNING

- The tire air pressure must be checked and adjusted on cold tires (i.e., when the temperature of the tires equals the ambient temperature).
- The tire air pressure must be adjusted in accordance with the riding speed and with the total weight of rider, passenger, cargo, and accessories approved for this model.

PERIODIC MAINTENANCE AND MINOR REPAIR

Tire air pressure (measured on cold tires):

0–90 kg (0–198 lb):

Front:

250 kPa (36 psi) (2.50 kgf/cm²)

Rear:

250 kPa (36 psi) (2.50 kgf/cm²)

XV17AV 90–194 kg (198–428 lb)

XV17AVC 90–194 kg (198–428 lb)

Front:

250 kPa (36 psi) (2.50 kgf/cm²)

Rear:

280 kPa (41 psi) (2.80 kgf/cm²)

Maximum load*:

XV17AV 194 kg (428 lb)

XV17AVC 194 kg (428 lb)

* Total weight of rider, passenger, cargo and accessories

EWA10510

⚠ WARNING

Proper loading of your vehicle is important for several characteristics of your vehicle, such as handling, braking, performance and safety. Do not carry loosely packed items that can shift. Securely pack your heaviest items close to the center of the vehicle, and distribute the weight evenly from side to side. Properly adjust the suspension for your load,

and check the condition and pressure of your tires. **NEVER OVERLOAD YOUR VEHICLE.** Make sure that the total weight of the cargo, rider, passenger, and accessories (cowling, saddlebags, etc. if approved for this model) does not exceed the maximum load of the vehicle. Operation of an overloaded vehicle could cause tire damage, an accident, or even injury.

Tire inspection

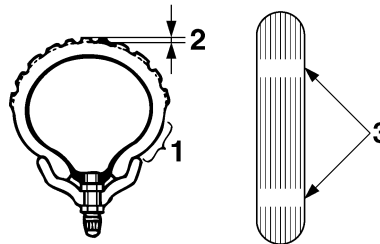

1. Tire sidewall
2. Tire tread depth
3. Tire wear indicator

Always check the tires before operating the motorcycle. If a tire tread shows crosswise lines (minimum tread depth),

if the tire has a nail or glass fragments in it, or if the sidewall is cracked, contact a Yamaha dealer immediately and have the tire replaced.

Minimum tire tread depth (front and rear):

1.0 mm (0.04 in)

EWA10560

⚠ WARNING

- It is dangerous to ride with a worn-out tire. When a tire tread begins to show crosswise lines, have a Yamaha dealer replace the tire immediately.
- The replacement of all wheel- and brake-related parts, including the tires, should be left to a Yamaha dealer, who has the necessary professional knowledge and experience.
- It is not recommended to patch a punctured tube. If unavoidable, however, patch the tube very carefully and replace it as soon as possible with a high-quality product.

PERIODIC MAINTENANCE AND MINOR REPAIR

Tire information

This motorcycle is equipped with spoke wheels and tube tires.

EWA10460

WARNING

- The front and rear tires should be of the same make and design, otherwise the handling characteristics of the vehicle cannot be guaranteed.
- After extensive tests, only the tires listed below have been approved for this model by Yamaha Motor Co., Ltd.

Front tire:

Size:

130/90-16M/C 67H

Manufacturer/model:

XV17AV BRIDGESTONE/G703M

XV17AVC BRIDGE-
STONE/G703M

XV17AV DUNLOP/D404F

XV17AVC DUNLOP/D404F

Rear tire:

Size:

150/80B16M/C 71H

Manufacturer/model:

XV17AV BRIDGESTONE/G702E

XV17AVC BRIDGESTONE/G702E

XV17AV DUNLOP/D404

XV17AVC DUNLOP/D404

EAU21421

Tires (For cast wheel models)

To ensure maximum performance, long service, and safe operation, note the following:

Tire air pressure

Always check and adjust the tire pressure before operating the motorcycle.

EWA11010

WARNING

Tire inflation pressure should be checked and adjusted when the temperature of the tire equals the ambient air temperature. Tire inflation pressure must be adjusted according to total weight of cargo, rider, passenger, and accessories (windshield, saddlebags, etc. if approved for this model).

PERIODIC MAINTENANCE AND MINOR REPAIR

Tire air pressure (measured on cold tires):

0–90 kg (0–198 lb):

Front:

250 kPa (36 psi) (2.50 kgf/cm²)

Rear:

250 kPa (36 psi) (2.50 kgf/cm²)

XV17AMV 90–194 kg (198–428 lb)

XV17AMVC 90–194 kg (198–428 lb)

XV17ATMV 90–179 kg (198–395 lb)

XV17ATMVC 90–179 kg (198–395 lb)

lb)

XV17ATV 90–179 kg (198–395 lb)

XV17ATVC 90–179 kg (198–395 lb)

XV17AWV 90–194 kg (198–428 lb)

XV17AWVC 90–194 kg (198–428 lb):

Front:

250 kPa (36 psi) (2.50 kgf/cm²)

Rear:

280 kPa (41 psi) (2.80 kgf/cm²)

Maximum load*:

XV17AMV 194 kg (428 lb)

XV17AMVC 194 kg (428 lb)

XV17ATMV 179 kg (395 lb)

XV17ATMVC 179 kg (395 lb)

XV17ATV 179 kg (395 lb)

XV17ATVC 179 kg (395 lb)

XV17AWV 194 kg (428 lb)

XV17AWVC 194 kg (428 lb)

* Total weight of rider, passenger, cargo and accessories

WARNING

EWA11020

Because loading has an enormous impact on the handling, braking, performance and safety characteristics of your motorcycle, you should keep the following precautions in mind.

- **NEVER OVERLOAD THE MOTORCYCLE!** Operation of an overloaded motorcycle may result in tire damage, loss of control, or severe injury. Make sure that the total weight of rider, passenger, cargo, and accessories does not exceed the specified maximum load for the vehicle.
- **Do not carry along loosely packed items, which can shift during a ride.**
- **Securely pack the heaviest items close to the center of the motorcycle and distribute the weight evenly on both sides.**
- **Adjust the suspension and tire air pressure with regard to the load.**

- **Check the tire condition and air pressure before each ride.**

Tire inspection

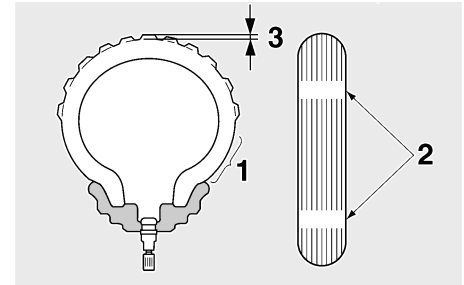

1. Tire sidewall
2. Tire wear indicator
3. Tire tread depth

Always check the tires before operating the motorcycle. If a tire tread shows crosswise line (minimum tread depth), if the tire has a nail or glass fragments in it, or if the sidewall is cracked, contact a Yamaha dealer immediately and have the tire replaced.

PERIODIC MAINTENANCE AND MINOR REPAIR

EWA10460

WARNING

- The front and rear tires should be of the same make and design, otherwise the handling characteristics of the vehicle cannot be guaranteed.
- After extensive tests, only the tires listed below have been approved for this model by Yamaha Motor Co., Ltd.

Front tire:

Size:

130/90-16M/C 67H

Manufacturer/model:

XV17AMV BRIDGE-

STONE/G703N

XV17AMVC BRIDGE-

STONE/G703N

XV17ATMV BRIDGESTONE/G703

XV17ATMVC BRIDGE-

STONE/G703

XV17ATV BRIDGESTONE/G703

XV17ATVC BRIDGESTONE/G703

XV17AWV BRIDGE-

STONE/G703N

XV17AWVC BRIDGE-

STONE/G703N

Rear tire:

Size:

150/80B16M/C 71H

Manufacturer/model:

XV17AMV BRIDGE-

STONE/G702N

XV17AMVC BRIDGE-

STONE/G702N

XV17ATMV BRIDGESTONE/G702

XV17ATMVC BRIDGE-

STONE/G702

XV17ATV BRIDGESTONE/G702

XV17ATVC BRIDGESTONE/G702

XV17AWV BRIDGE-

STONE/G702N

XV17AWVC BRIDGE-

STONE/G702N

Minimum tire tread depth (front and rear):

1.0 mm (0.04 in)

NOTE:

These limits may be different by regulation from country to country. If so, conform to the limits specified by the regulations of your own country.

EWA10580

WARNING

- It is dangerous to ride with a worn-out tire. When a tire tread begins to show crosswise lines, have a Yamaha dealer replace the tire immediately.
- The replacement of all wheel- and brake-related parts, including the tires, should be left to a Yamaha dealer, who has the necessary professional knowledge and experience.

PERIODIC MAINTENANCE AND MINOR REPAIR

Spoke wheels

EAU21940

To maximize the performance, durability, and safe operation of your motorcycle, note the following points regarding the specified wheels.

- The wheel rims should be checked for cracks, bends or warpage, and the spokes for looseness or damage before each ride. If any damage is found, have a Yamaha dealer replace the wheel. Do not attempt even the smallest repair to the wheel. A deformed or cracked wheel must be replaced.
- The wheel should be balanced whenever either the tire or wheel has been changed or replaced. An unbalanced wheel can result in poor performance, adverse handling characteristics, and a shortened tire life.
- Ride at moderate speeds after changing a tire since the tire surface must first be “broken in” for it to develop its optimal characteristics.

Cast wheels

EAU21960

To maximize the performance, durability, and safe operation of your vehicle, note the following points regarding the specified wheels.

- The wheel rims should be checked for cracks, bends or warpage before each ride. If any damage is found, have a Yamaha dealer replace the wheel. Do not attempt even the smallest repair to the wheel. A deformed or cracked wheel must be replaced.
- The wheel should be balanced whenever either the tire or wheel has been changed or replaced. An unbalanced wheel can result in poor performance, adverse handling characteristics, and a shortened tire life.
- Ride at moderate speeds after changing a tire since the tire surface must first be “broken in” for it to develop its optimal characteristics.

Accessories and replacement parts

EAU22011

EWA10621

WARNING

This vehicle is not designed to pull a trailer or to be attached to a sidecar. The accessories or replacement parts you choose for your vehicle should be designed specifically for this model, and they must be securely mounted to maintain the inherent stability of the original design. Genuine Yamaha Parts and Accessories are designed and tested to be compatible with your vehicle. Please consider Genuine Yamaha Parts and Accessories before making a purchase. Use of non-Yamaha-approved accessories or replacement parts may cause loss of handling stability and riding safety. Since Yamaha cannot control the quality of accessories or parts manufactured by other companies, Yamaha cannot be held liable for

PERIODIC MAINTENANCE AND MINOR REPAIR

any consequences caused by the use of items which have not been approved by Yamaha.

Adjusting the clutch lever free play

EAU22041

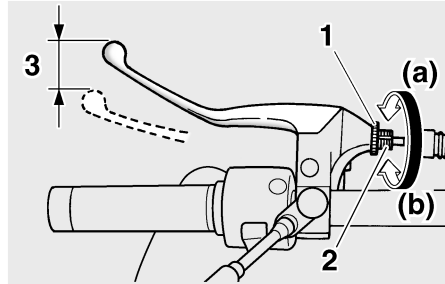

1. Locknut
2. Clutch lever free play adjusting bolt
3. Clutch lever free play

The clutch lever free play should measure 10.0–15.0 mm (0.39–0.59 in) as shown. Periodically check the clutch lever free play and, if necessary, adjust it as follows.

1. Loosen the locknut at the clutch lever.
2. To increase the clutch lever free play, turn the adjusting bolt in direction (a). To decrease the clutch lever free play, turn the adjusting bolt in direction (b).

NOTE: _____

If the specified clutch lever free play could be obtained as described above, tighten the locknut and skip the rest of the procedure, otherwise proceed as follows.

3. Fully turn the adjusting bolt at the clutch lever in direction (a) to loosen the clutch cable.
4. Loosen the locknut at the crankcase.

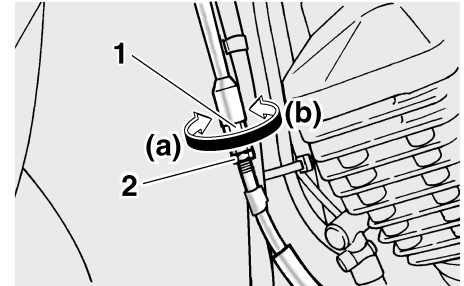

1. Clutch lever free play adjusting nut (crankcase)
2. Locknut (crankcase)

PERIODIC MAINTENANCE AND MINOR REPAIR

5. To increase the clutch lever free play, turn the adjusting nut in direction (a). To decrease the clutch lever free play, turn the adjusting nut in direction (b).
6. Tighten the locknut at the clutch lever and the crankcase.

Adjusting the brake lever free play

EAU22092

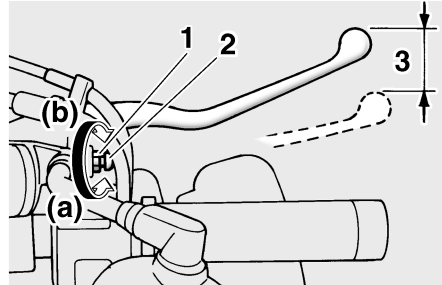

1. Locknut
2. Brake lever free play adjusting screw
3. Brake lever free play

The brake lever free play should measure 2.0–5.0 mm (0.08–0.20 in) as shown. Periodically check the brake lever free play and, if necessary, adjust it as follows.

1. Loosen the locknut at the brake lever.
2. To increase the brake lever free play, turn the adjusting screw in direction (a). To decrease the brake lever free play, turn the adjusting screw in direction (b).
3. Tighten the locknut.

⚠ WARNING

- After adjusting the brake lever free play, check the free play and make sure that the brake is working properly.
- A soft or spongy feeling in the brake lever can indicate the presence of air in the hydraulic system. If there is air in the hydraulic system, have a Yamaha dealer bleed the system before operating the motorcycle. Air in the hydraulic system will diminish the braking performance, which may result in loss of control and an accident.

EWA10630

Adjusting the rear brake light switch

EAU22270

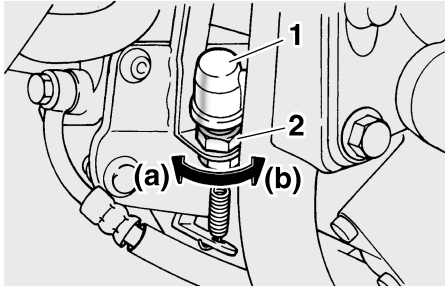

1. Rear brake light switch
2. Rear brake light switch adjusting nut

The rear brake light switch, which is activated by the brake pedal, is properly adjusted when the brake light comes on just before braking takes effect. If necessary, adjust the brake light switch as follows.

Turn the adjusting nut while holding the rear brake light switch in place. To make the brake light come on earlier, turn the adjusting nut in direction (a). To make the brake light come on later, turn the adjusting nut in direction (b).

Checking the front and rear brake pads

EAU22390

The front and rear brake pads must be checked for wear at the intervals specified in the periodic maintenance and lubrication chart.

Front brake pads

EAU36890

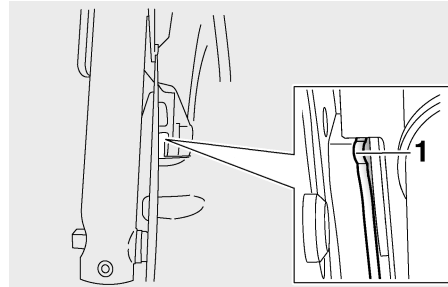

1. Brake pad wear indicator

Each front brake pad is provided with wear indicators, which allows you to check the brake pad wear without having to disassemble the brake. To check the brake pad wear, check the position of the wear indicators while applying the brake. If a brake pad has worn to

the point that a wear indicator almost touches the brake disc, have a Yamaha dealer replace the brake pads as a set.

Rear brake pads

EAU22470

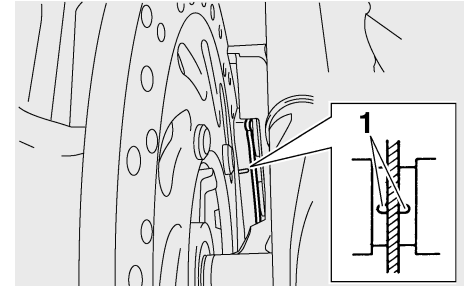

1. Brake pad wear indicator groove

Each rear brake pad is provided with a wear indicator groove, which allows you to check the brake pad wear without having to disassemble the brake. To check the brake pad wear, check the wear indicator groove. If a brake pad has worn to the point that the wear indicator groove has almost disappeared, have a Yamaha dealer replace the brake pads as a set.

PERIODIC MAINTENANCE AND MINOR REPAIR

Checking the brake fluid level

EAU22580

Front brake

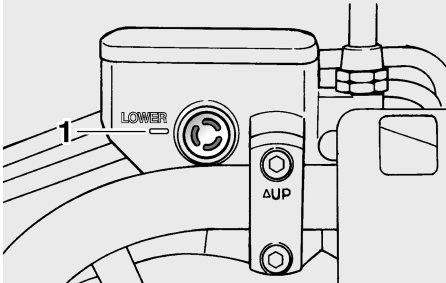

1. Minimum level mark

Rear brake

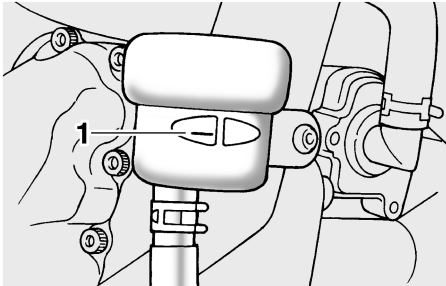

1. Minimum level mark

Insufficient brake fluid may allow air to enter the brake system, possibly causing it to become ineffective.

Before riding, check that the brake fluid is above the minimum level mark and replenish if necessary. A low brake fluid level may indicate worn brake pads and/or brake system leakage. If the brake fluid level is low, be sure to check the brake pads for wear and the brake system for leakage.

Observe these precautions:

- When checking the fluid level, make sure that the top of the brake fluid reservoir is level.
- Use only the recommended quality brake fluid, otherwise the rubber seals may deteriorate, causing leakage and poor braking performance.

Recommended brake fluid:
DOT 4

- Refill with the same type of brake fluid. Mixing fluids may result in a harmful chemical reaction and lead to poor braking performance.

- Be careful that water does not enter the brake fluid reservoir when refilling. Water will significantly lower the boiling point of the fluid and may result in vapor lock.
- Brake fluid may deteriorate painted surfaces or plastic parts. Always clean up spilled fluid immediately.
- As the brake pads wear, it is normal for the brake fluid level to gradually go down. However, if the brake fluid level goes down suddenly, have a Yamaha dealer check the cause.

PERIODIC MAINTENANCE AND MINOR REPAIR

Changing the brake fluid

EAU22730

Have a Yamaha dealer change the brake fluid at the intervals specified in the NOTE after the periodic maintenance and lubrication chart. In addition, have the oil seals of the master cylinders and calipers as well as the brake hoses replaced at the intervals listed below or whenever they are damaged or leaking.

- Oil seals: Replace every two years.
- Brake hoses: Replace every four years.

Drive belt slack

EAU23040

The drive belt slack should be checked and adjusted at the intervals specified in the periodic maintenance and lubrication chart.

To check the drive belt slack

EAU23062

1. Place the vehicle on the sidestand.
2. Note the current position of the drive belt using the marks near the drive belt check hole.

NOTE: _____

The marks near the drive belt check hole are 5 mm (0.2 in) apart.

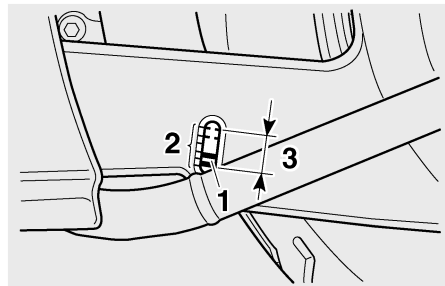

1. Drive belt
2. Marks
3. Drive belt slack

3. Note the position of the drive belt with a force of 45 N (4.5 kgf, 10 lbf) applied to the belt with a belt tension gauge as shown.

NOTE: _____

A belt tension gauge is available at a Yamaha dealer.

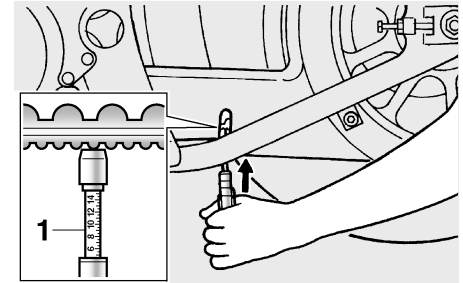

1. Belt tension gauge

4. Calculate the drive belt slack by subtracting the measurement noted in step 2 from the measurement noted in step 3.

Drive belt slack:
6.0–8.0 mm (0.24–0.31 in)

5. If the drive belt slack is incorrect, adjust it as follows.

PERIODIC MAINTENANCE AND MINOR REPAIR

EAU23070

To adjust the drive belt slack

1. Loosen the rear wheel axle nut and the brake caliper bracket bolt.

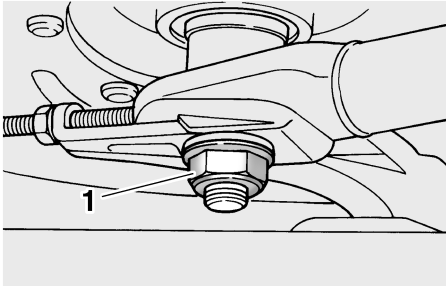

1. Axle nut

6

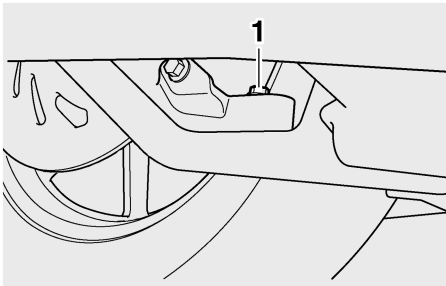

1. Brake caliper bracket bolt

2. Loosen the drive belt puller locknut on each side of the swingarm.

3. To tighten the drive belt, turn the adjusting bolt on each side of the swingarm in direction (a). To loosen the drive belt, turn the adjusting bolt on each side of the swingarm in direction (b), and then push the rear wheel forward.

NOTE:

Turn each adjusting bolt the same amount for proper wheel alignment.

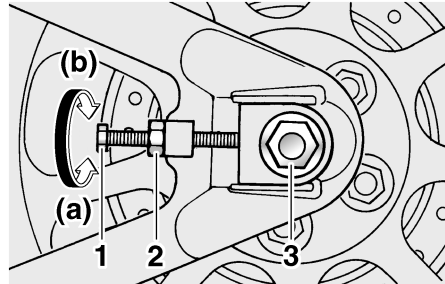

1. Drive belt slack adjusting bolt
2. Locknut
3. Wheel axle

4. Tighten the locknuts.

ECA10880

CAUTION:

Improper drive belt slack will overload the engine. Keep the drive belt slack within the specified range.

5. Tighten the axle nut and the brake caliper bracket bolt to the specified torques.

Tightening torques:

Axle nut:

150 Nm (15.0 m·kgf, 110 ft·lbf)

Brake caliper bracket bolt:

48 Nm (4.8 m·kgf, 35 ft·lbf)

PERIODIC MAINTENANCE AND MINOR REPAIR

Checking and lubricating the cables

EAU23090

The operation of all control cables and the condition of the cables should be checked before each ride, and the cables and cable ends should be lubricated if necessary. If a cable is damaged or does not move smoothly, have a Yamaha dealer check or replace it.

Recommended lubricant:

Yamaha Chain and Cable Lube or engine oil SAE 10W-30 (API SE)

EWA10710

WARNING

Damage to the outer housing of cables may result in internal rusting and cause interference with cable movement. Replace damaged cables as soon as possible to prevent unsafe conditions.

Checking and lubricating the throttle grip and cable

EAU23111

The operation of the throttle grip should be checked before each ride. In addition, the cable should be lubricated at the intervals specified in the periodic maintenance chart.

Checking and lubricating the brake and shift pedals

EAU23131

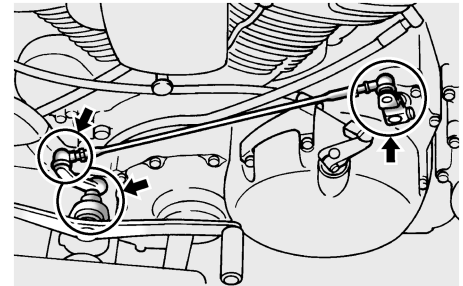
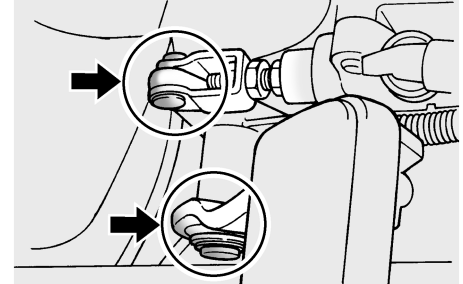

The operation of the brake and shift pedals should be checked before each ride, and the pedal pivots should be lubricated if necessary.

PERIODIC MAINTENANCE AND MINOR REPAIR

Recommended lubricant:

Lithium-soap-based grease (all-purpose grease)

Checking and lubricating the brake and clutch levers

EAU23140

Recommended lubricant:

Lithium-soap-based grease (all-purpose grease)

Brake lever

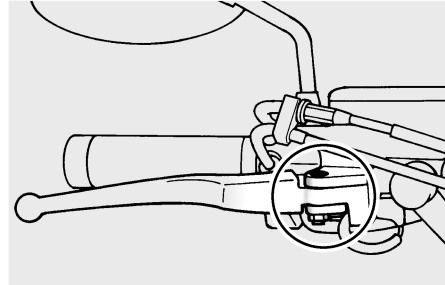

Clutch lever

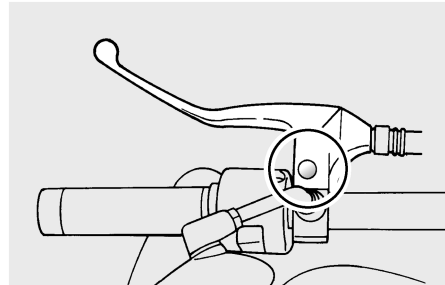

The operation of the brake and clutch levers should be checked before each ride, and the lever pivots should be lubricated if necessary.

PERIODIC MAINTENANCE AND MINOR REPAIR

Checking and lubricating the sidestand

EAU23200

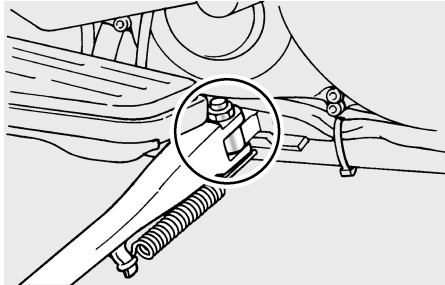

The operation of the sidestand should be checked before each ride, and the sidestand pivot and metal-to-metal contact surfaces should be lubricated if necessary.

EWA10730

WARNING

If the sidestand does not move up and down smoothly, have a Yamaha dealer check or repair it.

Recommended lubricant:

Lithium-soap-based grease (all-purpose grease)

Lubricating the swingarm pivots

EAUM1650

The swingarm pivots must be lubricated at the intervals specified in the periodic maintenance and lubrication chart.

Recommended lubricant:

Lithium-soap-based grease

Lubricating the rear suspension

EAU23250

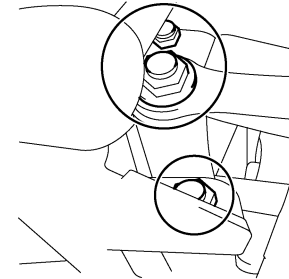

The pivoting points of the rear suspension must be lubricated at the intervals specified in the periodic maintenance and lubrication chart.

Recommended lubricant:

Lithium-soap-based grease

PERIODIC MAINTENANCE AND MINOR REPAIR

Checking the front fork

EAU23271

The condition and operation of the front fork must be checked as follows at the intervals specified in the periodic maintenance and lubrication chart.

To check the condition

EWA10750

WARNING

Securely support the vehicle so that there is no danger of it falling over.

Check the inner tubes for scratches, damage and excessive oil leakage.

To check the operation

1. Place the vehicle on a level surface and hold it in an upright position.
2. While applying the front brake, push down hard on the handlebars several times to check if the front fork compresses and rebounds smoothly.

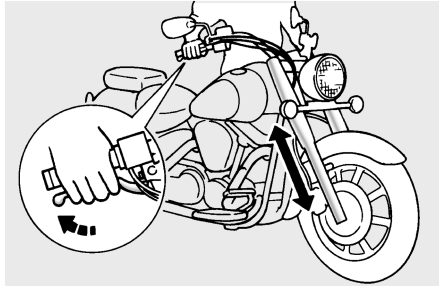

ECA10590

CAUTION:

If any damage is found or the front fork does not operate smoothly, have a Yamaha dealer check or repair it.

Checking the steering

EAU23280

Worn or loose steering bearings may cause danger. Therefore, the operation of the steering must be checked as follows at the intervals specified in the periodic maintenance and lubrication chart.

1. Place a stand under the engine to raise the front wheel off the ground.

EWA10750

WARNING

Securely support the vehicle so that there is no danger of it falling over.

2. Hold the lower ends of the front fork legs and try to move them forward and backward. If any free play can be felt, have a Yamaha dealer check or repair the steering.

PERIODIC MAINTENANCE AND MINOR REPAIR

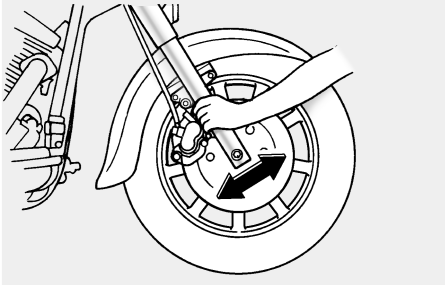

EAU23290

Checking the wheel bearings

The front and rear wheel bearings must be checked at the intervals specified in the periodic maintenance and lubrication chart. If there is play in the wheel hub or if the wheel does not turn smoothly, have a Yamaha dealer check the wheel bearings.

EAU23370

Battery

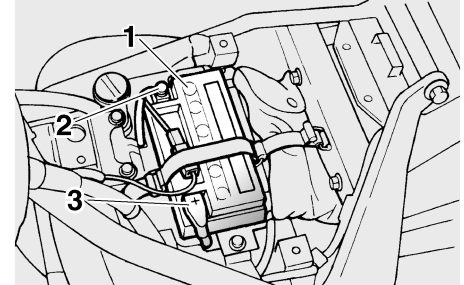

1. Battery
2. Negative battery terminal
3. Positive battery terminal

This model is equipped with a sealed-type (MF) battery, which does not require any maintenance. There is no need to check the electrolyte or to add distilled water.

ECA10620

CAUTION:

Never attempt to remove the battery cell seals, as this would permanently damage the battery.

PERIODIC MAINTENANCE AND MINOR REPAIR

EWA10760

WARNING

- **Electrolyte is poisonous and dangerous since it contains sulfuric acid, which causes severe burns. Avoid any contact with skin, eyes or clothing and always shield your eyes when working near batteries. In case of contact, administer the following FIRST AID.**
 - **EXTERNAL:** Flush with plenty of water.
 - **INTERNAL:** Drink large quantities of water or milk and immediately call a physician.
 - **EYES:** Flush with water for 15 minutes and seek prompt medical attention.
- **Batteries produce explosive hydrogen gas. Therefore, keep sparks, flames, cigarettes, etc., away from the battery and provide sufficient ventilation when charging it in an enclosed space.**

- **KEEP THIS AND ALL BATTERIES OUT OF THE REACH OF CHILDREN.**
-

To charge the battery

Have a Yamaha dealer charge the battery as soon as possible if it seems to have discharged. Keep in mind that the battery tends to discharge more quickly if the vehicle is equipped with optional electrical accessories.

To store the battery

1. If the vehicle will not be used for more than one month, remove the battery, fully charge it, and then place it in a cool, dry place.
2. If the battery will be stored for more than two months, check it at least once a month and fully charge it if necessary.
3. Fully charge the battery before installation.
4. After installation, make sure that the battery leads are properly connected to the battery terminals.

ECA10630

CAUTION:

- **Always keep the battery charged. Storing a discharged battery can cause permanent battery damage.**
 - **To charge a sealed-type (MF) battery, a special (constant-voltage) battery charger is required. Using a conventional battery charger will damage the battery. If you do not have access to a sealed-type (MF) battery charger, have a Yamaha dealer charge your battery.**
-

PERIODIC MAINTENANCE AND MINOR REPAIR

EAU23524

Replacing the fuses

The main fuse and the fuse box, which contains the fuses for the individual circuits, are located behind panel A. (See page 6-8.)

If a fuse is blown, replace it as follows.

1. Turn the key to "OFF" and turn off the electrical circuit in question.
2. Remove the blown fuse, and then install a new fuse of the specified amperage.

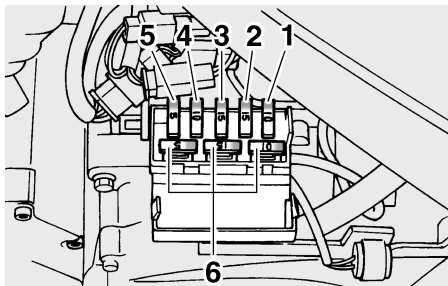

1. Signaling system fuse
2. Ignition fuse
3. Headlight fuse
4. Carburetor heater fuse
5. Backup fuse (for odometer and clock)
6. Spare fuse

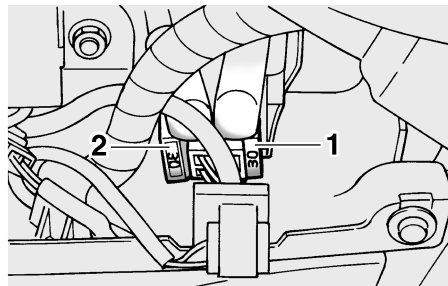

1. Main fuse
2. Spare main fuse

Specified fuses:

- Main fuse:
30.0 A
- Signaling system fuse:
10.0 A
- Ignition fuse:
15.0 A
- Headlight fuse:
XV17AMV 20.0 A
XV17AMVC 20.0 A
XV17ATMV 20.0 A
XV17ATMVC 20.0 A
XV17ATV 20.0 A
XV17ATVC 20.0 A
XV17AV 15.0 A
XV17AVC 15.0 A
XV17AWV 15.0 A
XV17AWVC 15.0 A
- Carburetor heater fuse:
10.0 A
- Backup fuse:
XV17AMV 10.0 A
XV17AMVC 10.0 A
XV17ATMV 10.0 A
XV17ATMVC 10.0 A
XV17ATV 10.0 A
XV17ATVC 10.0 A
XV17AV 5.0 A
XV17AVC 5.0 A
XV17AWV 5.0 A
XV17AWVC 5.0 A

PERIODIC MAINTENANCE AND MINOR REPAIR

ECA10640

EAU23792

CAUTION:

Do not use a fuse of a higher amperage rating than recommended to avoid causing extensive damage to the electrical system and possibly a fire.

3. Turn the key to "ON" and turn on the electrical circuit in question to check if the device operates.
4. If the fuse immediately blows again, have a Yamaha dealer check the electrical system.

Replacing the headlight bulb

This model is equipped with a quartz bulb headlight. If the headlight bulb burns out, replace it as follows.

1. Remove the headlight unit by removing the screws.

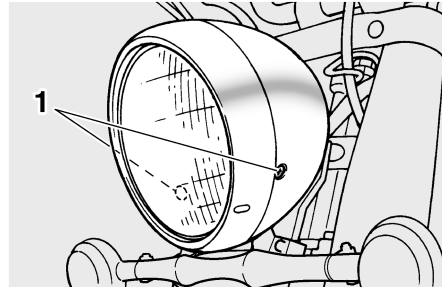

1. Screw

2. Disconnect the headlight coupler, and then remove the bulb cover.

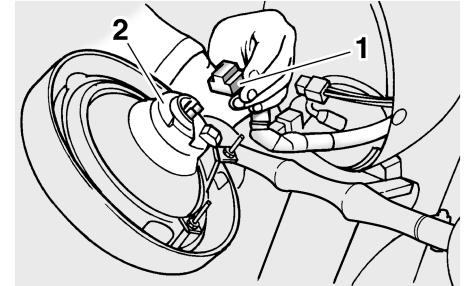

1. Headlight coupler
2. Headlight bulb cover

3. Unhook the headlight bulb holder, and then remove the defective bulb.

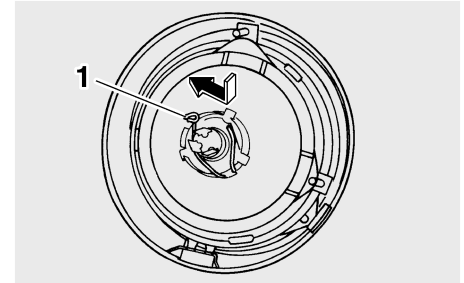

1. Headlight bulb holder

PERIODIC MAINTENANCE AND MINOR REPAIR

WARNING

EWA10790

Headlight bulbs get very hot. Therefore, keep flammable products away from a lit headlight bulb, and do not touch the bulb until it has cooled down.

4. Place a new headlight bulb into position, and then secure it with the bulb holder.

ECA10660

CAUTION:

Do not touch the glass part of the headlight bulb to keep it free from oil, otherwise the transparency of the glass, the luminosity of the bulb, and the bulb life will be adversely affected. Thoroughly clean off any dirt and fingerprints on the headlight bulb using a cloth moistened with alcohol or thinner.

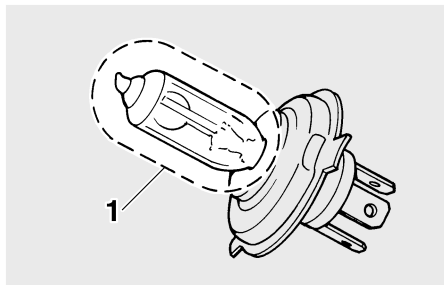

1. Do not touch the glass part of the bulb.
5. Install the headlight bulb cover, and then connect the coupler.
6. Install the headlight unit by installing the screws.
7. Have a Yamaha dealer adjust the headlight beam if necessary.

EAU24180

Tail/brake light

This model is equipped with an LED type of tail/brake light. If the tail/brake light does not come on, have a Yamaha dealer check it.

PERIODIC MAINTENANCE AND MINOR REPAIR

Replacing a turn signal light bulb

EAU24210

1. Remove the turn signal lens by removing the screws.

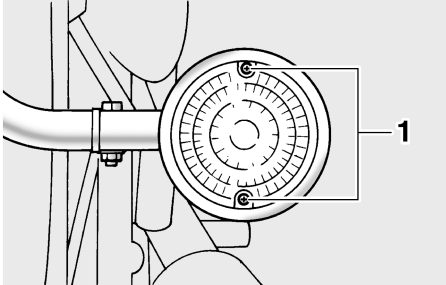

1. Screw

2. Remove the defective bulb by pushing it in and turning it counterclockwise.
3. Insert a new bulb into the socket, push it in, and then turn it clockwise until it stops.
4. Install the lens by installing the screws.

ECA10680

CAUTION:

Do not overtighten the screws, otherwise the lens may break.

Replacing a license plate light bulb

EAU31961

1. Remove the license plate light unit by removing the bolts.

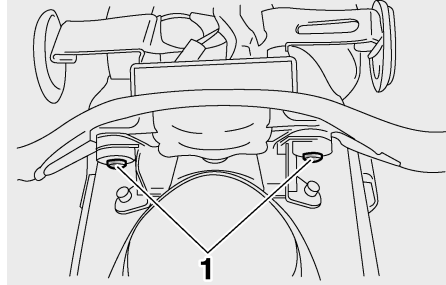

1. Bolt

2. Remove the license plate light socket (together with the bulb) by turning it counterclockwise, and then pulling it out.

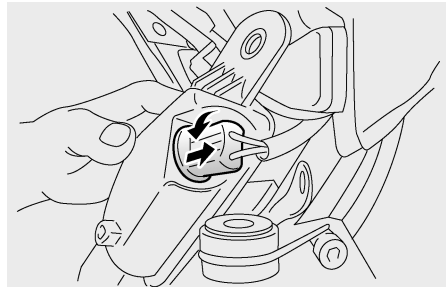

3. Remove the defective bulb by pulling it out.

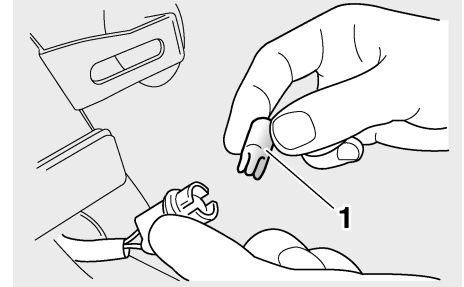

1. Bulb

4. Insert a new bulb into the socket.
5. Install the socket (together with the bulb) by pushing it in, and then turn it clockwise until it stops.
6. Install the license plate light unit by installing the bolts.

Supporting the motorcycle

EAU24350

Since this model is not equipped with a centerstand, follow these precautions when removing the front and rear wheel or performing other maintenance requiring the motorcycle to stand upright. Check that the motorcycle is in a stable and level position before starting any maintenance. A strong wooden box can be placed under the engine for added stability.

To service the front wheel

1. Stabilize the rear of the motorcycle by using a motorcycle stand or, if an additional motorcycle stand is not available, by placing a jack under the frame in front of the rear wheel.
2. Raise the front wheel off the ground by using a motorcycle stand.

To service the rear wheel

Raise the rear wheel off the ground by using a motorcycle stand or, if a motorcycle stand is not available, by placing

a jack either under each side of the frame in front of the rear wheel or under each side of the swingarm.

Troubleshooting

EAU25850

Although Yamaha motorcycles receive a thorough inspection before shipment from the factory, trouble may occur during operation. Any problem in the fuel, compression, or ignition systems, for example, can cause poor starting and loss of power.

The following troubleshooting chart represents a quick and easy procedure for checking these vital systems yourself. However, should your motorcycle require any repair, take it to a Yamaha dealer, whose skilled technicians have the necessary tools, experience, and know-how to service the motorcycle properly.

Use only genuine Yamaha replacement parts. Imitation parts may look like Yamaha parts, but they are often inferior, have a shorter service life and can lead to expensive repair bills.

PERIODIC MAINTENANCE AND MINOR REPAIR

EAU25891

Troubleshooting chart

EWA10840



WARNING

Keep away open flames and do not smoke while checking or working on the fuel system.

1. Fuel

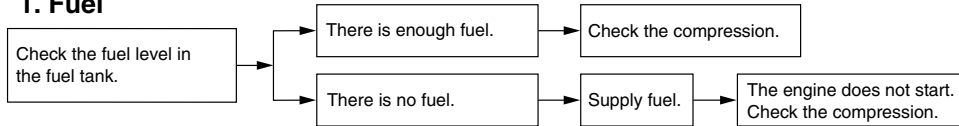

2. Compression

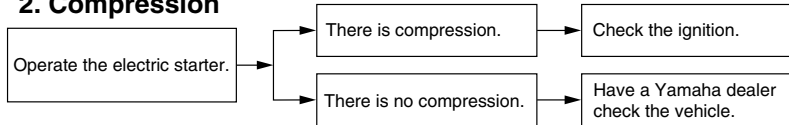

3. Ignition

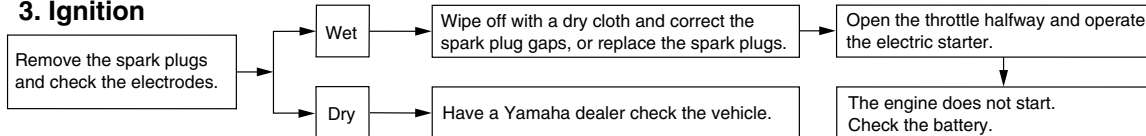

4. Battery

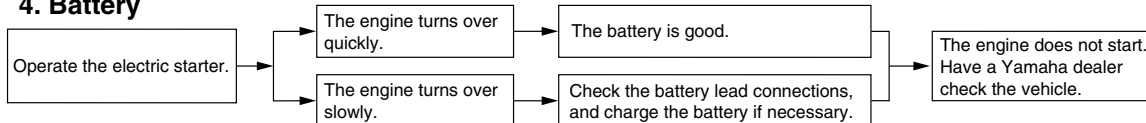

Care

EAU26082

While the open design of a motorcycle reveals the attractiveness of the technology, it also makes it more vulnerable. Rust and corrosion can develop even if high-quality components are used. A rusty exhaust pipe may go unnoticed on a car, however, it detracts from the overall appearance of a motorcycle. Frequent and proper care does not only comply with the terms of the warranty, but it will also keep your motorcycle looking good, extend its life and optimize its performance.

Before cleaning

1. Cover the muffler outlets with plastic bags after the engine has cooled down.
2. Make sure that all caps and covers as well as all electrical couplers and connectors, including the spark plug caps, are tightly installed.
3. Remove extremely stubborn dirt, like oil burnt onto the crankcase, with a degreasing agent and a brush, but never apply such prod-

ucts onto seals, gaskets, the drive belt and wheel axles. Always rinse the dirt and degreaser off with water.

Cleaning

ECA10770

CAUTION:

- **Avoid using strong acidic wheel cleaners, especially on spoked wheels. If such products are used on hard-to-remove dirt, do not leave the cleaner on the affected area any longer than instructed. Also, thoroughly rinse the area off with water, immediately dry it, and then apply a corrosion protection spray.**
- **Improper cleaning can damage windshields, cowlings, panels and other plastic parts. Use only a soft, clean cloth or sponge with mild detergent and water to clean plastic.**
- **Do not use any harsh chemical products on plastic parts. Be sure to avoid using cloths or sponges which have been in contact with strong or abrasive**

cleaning products, solvent or thinner, fuel (gasoline), rust removers or inhibitors, brake fluid, antifreeze or electrolyte.

- **Do not use high-pressure washers or steam-jet cleaners since they cause water seepage and deterioration in the following areas: seals (of wheel and swing-arm bearings, fork and brakes), electric components (couplers, connectors, instruments, switches and lights), breather hoses and vents.**
- **For motorcycles equipped with a windshield: Do not use strong cleaners or hard sponges as they will cause dulling or scratching. Some cleaning compounds for plastic may leave scratches on the windshield. Test the product on a small hidden part of the windshield to make sure that it does not leave any marks. If the windshield is scratched, use a quality plastic polishing compound after washing.**

MOTORCYCLE CARE AND STORAGE

After normal use

Remove dirt with warm water, a mild detergent, and a soft, clean sponge, and then rinse thoroughly with clean water. Use a toothbrush or bottlebrush for hard-to-reach areas. Stubborn dirt and insects will come off more easily if the area is covered with a wet cloth for a few minutes before cleaning.

After riding in the rain, near the sea or on salt-sprayed roads

Since sea salt or salt sprayed on roads during winter are extremely corrosive in combination with water, carry out the following steps after each ride in the rain, near the sea or on salt-sprayed roads.

NOTE: _____

Salt sprayed on roads in the winter may remain well into spring.

1. Clean the motorcycle with cold water and a mild detergent, after the engine has cooled down.

ECA10790

CAUTION: _____

Do not use warm water since it increases the corrosive action of the salt.

2. After drying the motorcycle, apply a corrosion protection spray on all metal, including chrome- and nickel-plated, surfaces to prevent corrosion.

Windshield cleaning

Avoid using any alkaline or strong acid cleaner, gasoline, brake fluid, or any other solvent. Clean the windshield with a cloth or sponge dampened with a neutral detergent, and after cleaning, thoroughly wash it off with water. For additional cleaning, use Yamaha Windshield Cleaner or other quality cleaner. Some cleaning compounds for plastics may leave scratches on surfaces of the windshield. Before using them, make a test by polishing an area which does not affect your visibility.

After cleaning

1. Dry the motorcycle with a chamois or an absorbing cloth.
2. Use a chrome polish to shine chrome, aluminum and stainless-steel parts, including the exhaust system. (Even the thermally induced discoloring of stainless-steel exhaust systems can be removed through polishing.)
3. To prevent corrosion, it is recommended to apply a corrosion protection spray on all metal, including chrome- and nickel-plated, surfaces.
4. Use spray oil as a universal cleaner to remove any remaining dirt.
5. Touch up minor paint damage caused by stones, etc.
6. Wax all painted and chrome-plated surfaces. Avoid combination cleaner waxes, many of which contain abrasives that may mar the paint or protective finish.
7. Let the motorcycle dry completely before storing or covering it.

EWA11130

WARNING

- **Make sure that there is no oil or wax on the brakes or tires.**
- **If necessary, clean the brake discs and brake linings with a regular brake disc cleaner or acetone, and wash the tires with warm water and a mild detergent. Before riding at higher speeds, test the motorcycle's braking performance and cornering behavior.**

ECA10950

CAUTION:

- **Apply spray oil and wax sparingly and make sure to wipe off any excess.**
- **Never apply oil or wax to the drive belt.**
- **Never apply oil or wax to any rubber and plastic parts, but treat them with a suitable care product.**
- **Avoid using abrasive polishing compounds as they will wear away the paint.**

NOTE: _____
Consult a Yamaha dealer for advice on what products to use.

Saddlebag cleaning and care

Clean the saddlebag on each side using a high-quality saddle soap. Rub the surface of the soap using a damp cloth or sponge to produce a lather, and then apply it to the surface of the saddlebags. Allow the lather to dry, and then polish the saddlebags with a soft cloth. If the saddlebags have been exposed to severe weather conditions and have become faded, or been scuffed, use a fine boot creme to return the leather to its original rich, even color. Exposure to the elements can dry out the leather over time. Therefore, an occasional application of a good quality mink oil is recommended to restore the leather and lift its water resistance. Make sure that the saddlebags are clean and dry before applying the mink oil. Using a soft cloth or a dauber, work a thin coat of mink oil into the leather

surface of the saddlebags. Wipe off any excess oil immediately and allow the saddlebags to dry for several hours.

MOTORCYCLE CARE AND STORAGE

Storage

EAU26270

Short-term

Always store your motorcycle in a cool, dry place and, if necessary, protect it against dust with a porous cover.

ECA10810

CAUTION:

- **Storing the motorcycle in a poorly ventilated room or covering it with a tarp, while it is still wet, will allow water and humidity to seep in and cause rust.**
- **To prevent corrosion, avoid damp cellars, stables (because of the presence of ammonia) and areas where strong chemicals are stored.**

Long-term

Before storing your motorcycle for several months:

1. Follow all the instructions in the “Care” section of this chapter.
2. For motorcycles equipped with a fuel cock that has an “OFF” position: Turn the fuel cock lever to “OFF”.

3. Drain the carburetor float chambers by loosening the drain bolts; this will prevent fuel deposits from building up. Pour the drained fuel into the fuel tank.
4. Fill up the fuel tank and add fuel stabilizer (if available) to prevent the fuel tank from rusting and the fuel from deteriorating.
5. Perform the following steps to protect the cylinders, piston rings, etc. from corrosion.
 - a. Remove the spark plug caps and spark plugs.
 - b. Pour a teaspoonful of engine oil into each spark plug bore.
 - c. Install the spark plug caps onto the spark plugs, and then place the spark plugs on the cylinder head so that the electrodes are grounded. (This will limit sparking during the next step.)
 - d. Turn the engine over several times with the starter. (This will coat the cylinder walls with oil.)
 - e. Remove the spark plug caps from the spark plugs, and then install the spark plugs and the spark plug caps.

WARNING

EWA10950

To prevent damage or injury from sparking, make sure to ground the spark plug electrodes while turning the engine over.

6. Lubricate all control cables and the pivoting points of all levers and pedals as well as of the side-stand/centerstand.
7. Check and, if necessary, correct the tire air pressure, and then lift the motorcycle so that both of its wheels are off the ground. Alternatively, turn the wheels a little every month in order to prevent the tires from becoming degraded in one spot.
8. Cover the muffler outlets with plastic bags to prevent moisture from entering them.
9. Remove the battery and fully charge it. Store it in a cool, dry place and charge it once a month. Do not store the battery in an excessively cold or warm place [less than 0 °C (30 °F) or more than 30

MOTORCYCLE CARE AND STORAGE

°C (90 °F)]. For more information on storing the battery, see page 6-33.

NOTE: _____
Make any necessary repairs before storing the motorcycle.

SPECIFICATIONS

Dimensions:

Overall length:

2500 mm (98.4 in)

Overall width:

980 mm (38.6 in)

Overall height:

XV17AMV 1140 mm (44.9 in)

XV17AMVC 1140 mm (44.9 in)

XV17ATMV 1500 mm (59.1 in)

XV17ATMVC 1500 mm (59.1 in)

XV17ATV 1500 mm (59.1 in)

XV17ATVC 1500 mm (59.1 in)

XV17AV 1140 mm (44.9 in)

XV17AVC 1140 mm (44.9 in)

XV17AWV 1140 mm (44.9 in)

XV17AWVC 1140 mm (44.9 in)

Seat height:

710 mm (28.0 in)

Wheelbase:

1688 mm (66.5 in)

Ground clearance:

145 mm (5.71 in)

Minimum turning radius:

3200 mm (126.0 in)

Weight:

With oil and fuel:

XV17AMV 334.0 kg (736 lb)

XV17AMVC 334.0 kg (736 lb)

XV17ATMV 349.0 kg (769 lb)

XV17ATMVC 349.0 kg (769 lb)

XV17ATV 349.0 kg (769 lb)

XV17ATVC 349.0 kg (769 lb)

XV17AV 334.0 kg (736 lb)

XV17AVC 334.0 kg (736 lb)

XV17AWV 334.0 kg (736 lb)

XV17AWVC 334.0 kg (736 lb)

Engine:

Engine type:

Air cooled 4-stroke, OHV

Cylinder arrangement:

V-type 2-cylinder

Displacement:

1670.0 cm³ (101.90 cu.in)

Bore × stroke:

97.0 × 113.0 mm (3.82 × 4.45 in)

Compression ratio:

8.36 :1

Starting system:

Electric starter

Lubrication system:

Dry sump

Engine oil:

Type:

YAMALUBE 4 (20W40) or SAE20W40

Recommended engine oil grade:

API service SE, SF, SG type or higher

Engine oil quantity:

Without oil filter cartridge replacement:

3.70 L (3.91 US qt) (3.26 Imp.qt)

With oil filter cartridge replacement:

4.10 L (4.33 US qt) (3.61 Imp.qt)

Transfer gear oil:

Type:

SAE80 API GL-4 Hypoid gear oil

Quantity:

0.40 L (0.42 US qt) (0.35 Imp.qt)

Air filter:

Air filter element:

Dry element

Fuel:

Recommended fuel:

Unleaded gasoline only

Fuel tank capacity:

20.0 L (5.28 US gal) (4.40 Imp.gal)

Fuel reserve amount:

3.5 L (0.92 US gal) (0.77 Imp.gal)

Carburetor:

Manufacturer:

MIKUNI

Type × quantity:

BSR40 x 1

Spark plug (s):

Manufacturer/model:

NGK/DPR7EA-9

Manufacturer/model:

DENSO/X22EPR-U9

Spark plug gap:

0.8–0.9 mm (0.031–0.035 in)

Clutch:

Clutch type:

Wet, multiple-disc

Transmission:

Primary reduction system:

Spur gear

Primary reduction ratio:

72/47 (1.532)

Secondary reduction system:

Belt drive

Secondary reduction ratio:

35/32 × 70/32 (2.393)

SPECIFICATIONS

Transmission type:
Constant mesh 5-speed

Operation:
Left foot operation

Gear ratio:
1st:
38/16 (2.375)
2nd:
30/19 (1.579)
3rd:
29/25 (1.160)
4th:
29/32 (0.906)
5th:
21/28 (0.750)

Chassis:

Frame type:
Double cradle
Caster angle:
32.00 °
Trail:
142.0 mm (5.59 in)

Front tire:

Type:
XV17AMV Tubeless
XV17AMVC Tubeless
XV17ATMV Tubeless
XV17ATMVC Tubeless
XV17ATV Tubeless
XV17ATVC Tubeless
XV17AV With tube
XV17AVC With tube
XV17AWV Tubeless
XV17AWVC Tubeless

Size:
130/90-16M/C 67H

Manufacturer/model:
XV17AMV BRIDGESTONE/G703N
XV17AMVC BRIDGESTONE/G703N
XV17ATMV BRIDGESTONE/G703
XV17ATMVC BRIDGESTONE/G703
XV17ATV BRIDGESTONE/G703
XV17ATVC BRIDGESTONE/G703
XV17AV BRIDGESTONE/G703M
XV17AVC BRIDGESTONE/G703M
XV17AWV BRIDGESTONE/G703N
XV17AWVC BRIDGESTONE/G703N

Manufacturer/model:
XV17AV DUNLOP/D404F
XV17AVC DUNLOP/D404F

Rear tire:

Type:
XV17AMV Tubeless
XV17AMVC Tubeless
XV17ATMV Tubeless
XV17ATMVC Tubeless
XV17ATV Tubeless
XV17ATVC Tubeless
XV17AV With tube
XV17AVC With tube
XV17AWV Tubeless
XV17AWVC Tubeless

Size:
150/80B16M/C 71H

Manufacturer/model:
XV17AMV BRIDGESTONE/G702N
XV17AMVC BRIDGESTONE/G702N
XV17ATMV BRIDGESTONE/G702

XV17ATMVC BRIDGESTONE/G702
XV17ATV BRIDGESTONE/G702
XV17ATVC BRIDGESTONE/G702
XV17AV BRIDGESTONE/G702E
XV17AVC BRIDGESTONE/G702E
XV17AWV BRIDGESTONE/G702N
XV17AWVC BRIDGESTONE/G702N

Manufacturer/model:
XV17AV DUNLOP/D404
XV17AVC DUNLOP/D404

Loading:

Maximum load:
XV17AMV 194 kg (428 lb)
XV17AMVC 194 kg (428 lb)
XV17ATMV 179 kg (395 lb)
XV17ATMVC 179 kg (395 lb)
XV17ATV 179 kg (395 lb)
XV17ATVC 179 kg (395 lb)
XV17AV 194 kg (428 lb)
XV17AVC 194 kg (428 lb)
XV17AWV 194 kg (428 lb)
XV17AWVC 194 kg (428 lb)
(Total weight of rider, passenger, cargo and accessories)

Tire air pressure (measured on cold tires):

Loading condition:
0–90 kg (0–198 lb)
Front:
250 kPa (36 psi) (2.50 kgf/cm²)
Rear:
250 kPa (36 psi) (2.50 kgf/cm²)

SPECIFICATIONS

Loading condition:

XV17AMV 90–194 kg (198–428 lb)
XV17AMVC 90–194 kg (198–428 lb)
XV17ATMV 90–179 kg (198–395 lb)
XV17ATMVC 90–179 kg (198–395 lb)
XV17ATV 90–179 kg (198–395 lb)
XV17ATVC 90–179 kg (198–395 lb)
XV17AV 90–194 kg (198–428 lb)
XV17AVC 90–194 kg (198–428 lb)
XV17AWV 90–194 kg (198–428 lb)
XV17AWVC 90–194 kg (198–428 lb)

Front:

250 kPa (36 psi) (2.50 kgf/cm²)

Rear:

280 kPa (41 psi) (2.80 kgf/cm²)

Front wheel:

Wheel type:

XV17AMV Cast wheel
XV17AMVC Cast wheel
XV17ATMV Cast wheel
XV17ATMVC Cast wheel
XV17ATV Cast wheel
XV17ATVC Cast wheel
XV17AV Spoke wheel
XV17AVC Spoke wheel
XV17AWV Cast wheel
XV17AWVC Cast wheel

Rim size:

16M/C x MT3.00

Rear wheel:

Wheel type:

XV17AMV Cast wheel
XV17AMVC Cast wheel
XV17ATMV Cast wheel

XV17ATMVC Cast wheel

XV17ATV Cast wheel

XV17ATVC Cast wheel

XV17AV Spoke wheel

XV17AVC Spoke wheel

XV17AWV Cast wheel

XV17AWVC Cast wheel

Rim size:

16M/C x MT3.50

Front brake:

Type:

Dual disc brake

Operation:

Right hand operation

Recommended fluid:

DOT 4

Rear brake:

Type:

Single disc brake

Operation:

Right foot operation

Recommended fluid:

DOT 4

Front suspension:

Type:

Telescopic fork

Spring/shock absorber type:

Coil spring/oil damper

Wheel travel:

140.0 mm (5.51 in)

Rear suspension:

Type:

Swingarm (link suspension)

Spring/shock absorber type:

Coil spring/gas-oil damper

Wheel travel:

110.0 mm (4.33 in)

Electrical system:

Ignition system:

Transistorized coil ignition (digital)

Charging system:

AC magneto

Battery:

Model:

YTX20L-BS

Voltage, capacity:

12 V, 18.0 Ah

Headlight:

Bulb type:

Halogen bulb

Bulb voltage, wattage × quantity:

Headlight:

12 V, 60 W/55.0 W × 1

Tail/brake light:

LED

Front turn signal/position light:

12 V, 23 W/8.0 W × 2

Rear turn signal light:

12 V, 21.0 W × 2

License plate light:

12 V, 5.0 W × 1

Meter lighting:

14 V, 0.56 W × 4

Neutral indicator light:

14 V, 1.12 W

High beam indicator light:

14 V, 1.12 W

Turn signal indicator light: 14 V, 1.12 W	XV17AVC 5.0 A XV17AWV 5.0 A
Fuel level warning light: LED	XV17AWVC 5.0 A
Engine trouble warning light: LED	

Fuses:

Main fuse: 30.0 A	
Headlight fuse:	
XV17AMV 20.0 A	
XV17AMVC 20.0 A	
XV17ATMV 20.0 A	
XV17ATMVC 20.0 A	
XV17ATV 20.0 A	
XV17ATVC 20.0 A	
XV17AV 15.0 A	
XV17AVC 15.0 A	
XV17AWV 15.0 A	
XV17AWVC 15.0 A	
Signaling system fuse: 10.0 A	
Ignition fuse: 15.0 A	
Carburetor heater fuse: 10.0 A	
Backup fuse:	
XV17AMV 10.0 A	
XV17AMVC 10.0 A	
XV17ATMV 10.0 A	
XV17ATMVC 10.0 A	
XV17ATV 10.0 A	
XV17ATVC 10.0 A	
XV17AV 5.0 A	

CONSUMER INFORMATION

EAU26351

Identification numbers

Record the key identification number, vehicle identification number and model label information in the spaces provided below for assistance when ordering spare parts from a Yamaha dealer or for reference in case the vehicle is stolen.

KEY IDENTIFICATION NUMBER:

VEHICLE IDENTIFICATION NUMBER:

MODEL LABEL INFORMATION:

Key identification number

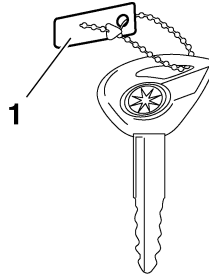

1. Key identification number

The key identification number is stamped into the key tag. Record this number in the space provided and use it for reference when ordering a new key.

EAU26381

Vehicle identification number

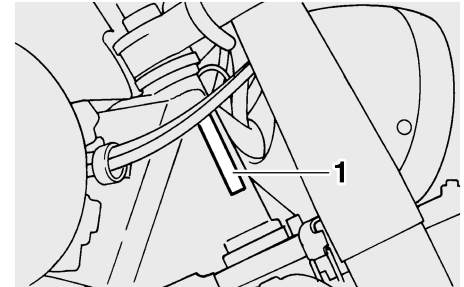

1. Vehicle identification number

The vehicle identification number is stamped into the steering head pipe. Record this number in the space provided.

NOTE: _____

The vehicle identification number is used to identify your motorcycle and may be used to register your motorcycle with the licensing authority in your area.

EAU26400

EAU26470

Model label

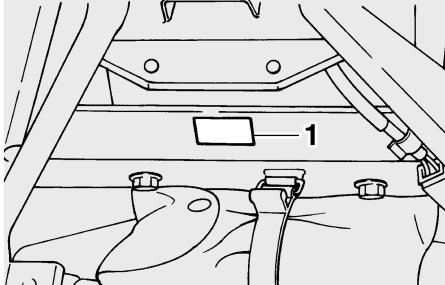

1. Model label

The model label is affixed to the frame under the rider seat. (See page 3-10.) Record the information on this label in the space provided. This information will be needed when ordering spare parts from a Yamaha dealer.

CONSUMER INFORMATION

EAU26550

Reporting safety defects

If you believe that your vehicle has a defect which could cause a crash or could cause injury or death, you should immediately inform the National Highway Traffic Safety Administration (NHTSA) in addition to notifying Yamaha Motor Corporation, U.S.A. If NHTSA receives similar complaints, it may open an investigation, and if it finds that a safety defect exists in a group of vehicles, it may order a recall and remedy campaign. However, NHTSA cannot become involved in individual problems between you, your dealer, or Yamaha Motor Corporation, U.S.A.

To contact NHTSA, you may either call the Auto Safety Hotline toll-free at 1-800-424-9393 (or 366-0123 in Washington, D.C. area) or write to: NHTSA, U.S. Department of Transportation, Washington, D.C. 20590. You can also obtain other information about motor vehicle safety from the Hotline.

Motorcycle noise regulation

TAMPERING WITH NOISE CONTROL SYSTEM PROHIBITED:

Federal law prohibits the following acts or the causing thereof: (1) The removal or rendering inoperative by any person other than for purposes of maintenance, repair, or replacement of any device or element of design incorporated into any new vehicle for the purpose of noise control prior to its sale or delivery to the ultimate purchaser or while it is in use or (2) the use of the vehicle after such device or element of design has been removed or rendered inoperative by any person.

“AMONG THOSE ACTS PRESUMED TO CONSTITUTE TAMPERING ARE THE ACTS LISTED BELOW”.

These acts include tampering with the following systems; i.e., modification, removal, etc.

Exhaust system

- Muffler
- Exhaust pipe
- Silencer

Intake system

- Air cleaner case
- Air cleaner element
- Intake duct

CONSUMER INFORMATION

EAU26632

Maintenance record

Copies of work orders and/or receipts for parts purchased and installed on your vehicle will be required to document that maintenance has been completed in accordance with the emissions warranty. The chart below is printed only as a reminder that maintenance work is required. It is not acceptable proof of maintenance work.

Maintenance interval	Date of service	Mileage	Servicing dealer name and address	Remarks
600 mi (1000 km) or 1 month				
4000 mi (7000 km) or 6 months				
8000 mi (13000 km) or 12 months				
12000 mi (19000 km) or 18 months				
16000 mi (25000 km) or 24 months				
20000 mi (31000 km) or 30 months				
24000 mi (37000 km) or 36 months				
28000 mi (43000 km) or 42 months				
32000 mi (49000 km) or 48 months				

CONSUMER INFORMATION

Maintenance interval	Date of service	Mileage	Servicing dealer name and address	Remarks
36000 mi (55000 km) or 54 months				
40000 mi (61000 km) or 60 months				

CONSUMER INFORMATION

EAU26661

YAMAHA MOTOR CORPORATION, U.S.A. STREET AND ENDURO MOTORCYCLE LIMITED WARRANTY

Yamaha Motor Corporation, U.S.A. hereby warrants each new model Yamaha motorcycle will be free from defects in material and workmanship for the period of time stated herein, subject to certain stated limitations.

THE PERIOD OF WARRANTY for Yamaha motorcycles originally equipped with headlight, stoplight, and turn signals shall be one (1) year from the date of purchase, with no mileage limitation.

MODELS EXCLUDED FROM WARRANTY include those used for non-Yamaha-authorized renting, leasing, or other commercial purposes, and TZ models.

DURING THE PERIOD OF WARRANTY any authorized Yamaha motorcycle dealer will, free of charge, repair or replace any part adjudged defective by Yamaha due to faulty workmanship or material from the factory. Parts used in warranty repairs will be warranted for the balance of the product's warranty period. All parts replaced under warranty become property of Yamaha Motor Corp. U.S.A.

GENERAL EXCLUSIONS from this warranty shall include any failures caused by:

- Competition or racing use.
- Installation of parts or accessories that are not qualitatively equivalent to genuine Yamaha parts.
- Abnormal strain, neglect, or abuse.
- Lack of proper maintenance.
- Accident or collision damage.
- Modification to original parts.

SPECIFIC EXCLUSIONS from this warranty shall include parts replaced due to normal wear or routine maintenance.

THE CUSTOMER'S RESPONSIBILITY under this warranty shall be to:

- Operate and maintain the motorcycle as specified in the appropriate Owner's Manual, and
- Give notice to an authorized Yamaha motorcycle dealer of any and all apparent defects within ten (10) days after discovery, and make the machine available at that time for inspection and repairs at such dealer's place of business.

WARRANTY TRANSFER: To transfer the warranty from the original purchaser to any subsequent purchaser, it is imperative that the machine be inspected and registered for warranty by an authorized Yamaha motorcycle dealer. In order for this warranty to remain in effect, this inspection and registration must take place within ten (10) days after transfer. An inspection and registration fee will be charged for this service.

EMISSIONS CONTROL SYSTEM WARRANTY

Yamaha Motor Corporation, U.S.A. also warrants to the ultimate purchaser and each subsequent purchaser of each Yamaha motorcycle covered by this warranty with a displacement of 50cc or greater, that the vehicle is designed, built, and equipped so as to conform at the time of sale with all U.S. emissions standards applicable at the time of manufacture and that it is free from defects in materials and workmanship which would cause it not to meet these standards within the periods listed immediately below. Failure other than those resulting from defects in material or workmanship which arise solely as a result of owner abuse and / or lack of proper maintenance are not covered by this warranty.

ENGINE DISPLACEMENT	PERIOD
50cc to 169cc	12,000 km (7,465 miles) or five years, whichever occurs first
170cc to 279cc	18,000 km (11,185 miles) or five years, whichever occurs first
280cc or over	30,000 km (18,641 miles) or five years, whichever occurs first

YAMAHA MOTOR CORPORATION, U.S.A. MAKES NO OTHER WARRANTY OF ANY KIND, EXPRESSED OR IMPLIED. ALL IMPLIED WARRANTIES OF MERCHANTABILITY AND FITNESS FOR A PARTICULAR PURPOSE WHICH EXCEED THE OBLIGATIONS AND TIME LIMITS STATED IN THIS WARRANTY ARE HEREBY DISCLAIMED BY YAMAHA MOTOR CORPORATION, U.S.A. AND EXCLUDED FROM THIS WARRANTY.

SOME STATES DO NOT ALLOW LIMITATIONS ON HOW LONG AN IMPLIED WARRANTY LASTS, SO THE ABOVE LIMITATION MAY NOT APPLY TO YOU. ALSO EXCLUDED FROM THIS WARRANTY ARE ANY INCIDENTAL OR CONSEQUENTIAL DAMAGES INCLUDING LOSS OF USE. SOME STATES DO NOT ALLOW THE EXCLUSION OR LIMITATION OF INCIDENTAL OR CONSEQUENTIAL DAMAGES, SO THE ABOVE EXCLUSION MAY NOT APPLY TO YOU.

THIS WARRANTY GIVES YOU SPECIFIC LEGAL RIGHTS, AND YOU MAY ALSO HAVE OTHER RIGHTS WHICH VARY FROM STATE TO STATE.

YAMAHA MOTOR CORPORATION, U.S.A.
P.O. Box 6555
Cypress, California 90630

WARRANTY QUESTIONS AND ANSWERS

- Q. What costs are my responsibility during the warranty period?
- A. The customer's responsibility includes all costs of normal maintenance services, non-warranty repairs, accident and collision damages, and oil, oil filters, air filters, spark plugs, and brake shoes.
- Q. What are some examples of "abnormal" strain, neglect, or abuse?
- A. These terms are general and overlap each other in areas. Specific examples include: Running the machine out of oil, sustained high-rpm, full-throttle, operating the machine with a broken or damaged part which causes another part to fail, damage or failure due to improper or careless transportation and or tie down. If you have any specific questions on operation or maintenance, please contact your dealer for advice.
- Q. Does the warranty cover incidental costs such as towing or transportation due to a failure?
- A. No. The warranty is limited to repair of the machine itself.
- Q. May I perform any or all of the recommended maintenance shown in the Owner's Manual instead of having the dealer do them?
- A. Yes, if you are a qualified mechanic and follow the procedures specified in the Owner's and Service Manual. We do recommend, however, that items requiring special tools or equipment be done by Yamaha Motorcycle dealer.
- Q. Will the warranty be void or cancelled if I do not operate or maintain my new motorcycle exactly as specified in the Owner's Manual?
- A. No. The warranty on a new motorcycle cannot be "voided" or "cancelled." **However, if a particular failure is caused by operation or maintenance other than as shown in the Owner's Manual, that failure may not be covered under warranty.**
- Q. What responsibility does my dealer have under this warranty?
- A. Each Yamaha Motorcycle dealer is expected to:
1. Completely set up every new machine before sale.
 2. Explain the operation, maintenance, and warranty requirements to your satisfaction at the time of sale, and upon your request at any later date.
 3. Each Yamaha Motorcycle dealer is held responsible for his setup, service and warranty repair work.
- Q. Is the warranty transferable to second owners?
- A. Yes. The remainder of the existing warranty can be transferred upon request. The unit has to be inspected and re-registered by an authorized Yamaha Motorcycle dealer for the policy to remain effective.

CUSTOMER SERVICE

If your machine requires warranty service, you must take it to any authorized Yamaha Motorcycle dealer within the continental United States. Be sure to bring your warranty registration card or other valid proof of the original date of purchase. If a question or problem arises regarding warranty, first contact the owner of the dealership. Since all warranty matters are handled at the dealer level, this person is in the best position to help you. If you are still not satisfied and require additional assistance, please write:

YAMAHA MOTOR CORPORATION U.S.A.
CUSTOMER RELATIONS DEPARTMENT
P.O. Box 6555
Cypress, California 90630

When contacting Yamaha Motor Corporation, U.S.A. don't forget to include any important information such as names, addresses, model, V.I.N. (frame number), dates, and receipts.

CHANGE OF ADDRESS

The federal government requires each manufacturer of a motor vehicle to maintain a complete, up-to-date list of all first purchasers against the possibility of a safety-related defect and recall. This list is compiled from the purchase registrations sent to Yamaha Motor Corporation, U.S.A. by the selling dealer at the time of your purchase.

If you should move after you have purchased your new motorcycle, please advise us of your new address by sending a postcard listing your motorcycle model name, V.I.N. (frame number), dealer number (or dealer's name) as it is shown on your warranty card, your name and new mailing address. Mail to:

YAMAHA MOTOR CORPORATION, U.S.A.
P.O. Box 6555
Cypress, California 90630
Attention: Warranty Department

This will ensure that Yamaha Motor Corporation, U.S.A. has an up-to-date registration record in accordance with federal law.

CONSUMER INFORMATION

EAU26750

YAMAHA EXTENDED SERVICE (Y.E.S.)

Keep your Yamaha protected even after your warranty expires with genuine Yamaha Extended Service (Y.E.S.).

- Y.E.S. is designed and administered by Yamaha Motor Corporation to provide maximum owner satisfaction. You get uninterrupted factory-backed coverage for extra peace of mind.
- Y.E.S. is flexible. You choose the plan that's right for you: 12 months, 24 months, 36 months or, on certain models, even 48 months beyond your warranty period.
- Y.E.S. is designed and administered by the same Yamaha people who handle your warranty – and it shows in the comprehensive coverage benefits. There are no mileage limitations. Coverage isn't limited to “moving parts” or the “drive train” like many other plans. And Y.E.S. covers manufacturing defects just like the warranty. See the sample contract at your Yamaha dealer to see how comforting uninterrupted factory-backed protection can be.
- You don't have to pay anything for covered repairs. There's no deductible to pay, and repairs aren't “pro-rated.” You don't have any “out-of-pocket” expenses for covered repairs.
- In addition, Travel and Recreation Interruption Protection (TRIP) is included at no extra cost. TRIP gives you up to \$150 reimbursement per occurrence for any reasonable expenses you incur because your Yamaha needs covered service: replacement vehicle rental, emergency towing, phone calls, even food and lodging when you are away from home. This superb coverage goes into effect when you purchase Y.E.S., so it applies to any warranty repairs as well as covered repairs during your entire Y.E.S. plan period.
- Y.E.S. coverage is honored at any authorized Yamaha dealer nationwide.
- Y.E.S. coverage is transferable to a new owner if you sell or trade-in. That can make your Yamaha much more valuable!

This excellent Y.E.S. plan coverage is only available to Yamaha owners like you, and only while your Yamaha is still within the Yamaha Limited Warranty period. So visit your authorized Yamaha dealer to get all the facts. He can show you how easy it is to protect your investment with Yamaha Extended Service.

CONSUMER INFORMATION

We urge you to act now. You'll get the excellent benefits of TRIP coverage right away, and you'll rest easy knowing you'll have strong factory-backed protection even after your Yamaha Limited Warranty expires.

A special note:

If visiting your dealer isn't convenient, contact Yamaha with your Primary ID number (your frame number). We'll be happy to help you get the Y.E.S. coverage you need.

Yamaha Service Marketing

P.O. Box 6555

Cypress, CA 90630

1-(866)-YES-EXTD (1-866-937-3983)

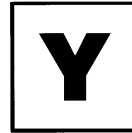

YAMAHA



EXTENDED

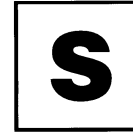

SERVICE

INDEX

- A**
Accessories and replacement parts 6-22
Air filter element, cleaning 6-15
- B**
Battery 6-33
Brake and clutch levers,
checking and lubricating 6-30
Brake and shift pedals,
checking and lubricating 6-29
Brake fluid, changing 6-27
Brake fluid level, checking 6-26
Brake lever 3-6
Brake lever free play, adjusting 6-24
Brake pedal 3-7
- C**
Cables, checking and lubricating 6-29
Canister (for California only) 6-10
Carburetor 6-16
Care 7-1
Clock 3-4
Clutch lever 3-6
Clutch lever free play, adjusting 6-23
- D**
Dimmer switch 3-5
Drive belt slack 6-27
- E**
Engine break-in 5-4
Engine oil and oil filter cartridge 6-10
Engine, starting a warm 5-2
Engine stop switch 3-5
Engine trouble warning light 3-2
- F**
Front and rear brake pads, checking 6-25
Front fork, checking 6-32
- Fuel 3-8
Fuel cock 3-9
Fuel gauge 3-4
Fuel level warning light 3-2
Fuel tank cap 3-7
Fuses, replacing 6-35
- H**
Handlebar switches 3-5
Headlight bulb, replacing 6-36
Helmet holder 3-11
High beam indicator light 3-2
Horn switch 3-5
- I**
Identification numbers 9-1
Ignition circuit cut-off system 3-17
Indicator and warning lights 3-2
- K**
Key identification number 9-1
- L**
Labels, location of 1-5
License plate light bulb, replacing 6-38
- M**
Main switch/steering lock 3-1
Maintenance and lubrication, periodic 6-4
Maintenance, emission control system... 6-3
Maintenance, periodic 6-1
Maintenance record 9-5
Model label 9-2
- N**
Neutral indicator light 3-2
Noise regulation 9-4
- P**
Panel, removing and installing 6-8
Parking 5-5
- Part locations 2-1
Pre-operation check list 4-2
- R**
Rear brake light switch, adjusting 6-25
Rear suspension, lubricating 6-31
Rider seat 3-10
- S**
Saddlebags [XV17ATV(C)] 3-13
Safety defects, reporting 9-3
Safety information 1-1
Self-diagnosis device 3-3
Shifting 5-3
Shift pedal 3-6
Shock absorber assembly, adjusting 3-14
Sidecases [XV17ATMV(C)] 3-13
Sidestand 3-16
Sidestand, checking and lubricating 6-31
Spark plugs, checking 6-8
Specifications 8-1
Speedometer unit 3-3
Starter (choke) knob 3-10
Starting and warming up a cold
engine 5-1
Start switch 3-5
Steering, checking 6-32
Steering, locking with a padlock 3-10
Storage 7-4
Supporting the motorcycle 6-39
Swingarm pivots, lubricating 6-31
- T**
Tail/brake light 6-37
Throttle cable free play, checking 6-17
Throttle grip and cable, checking and
lubricating 6-29

Tires (For cast wheel models)	6-19
Tires (For spoke wheel model)	6-17
Tool kit	6-1
Transfer case oil	6-13
Troubleshooting	6-39
Troubleshooting chart	6-40
Turn signal indicator light	3-2
Turn signal light bulb, replacing	6-38
Turn signal switch	3-5

V

Valve clearance	6-17
Vehicle identification number	9-1

W

Warranty, extended	9-9
Warranty, limited	9-7
Wheel bearings, checking	6-33
Wheels	6-22
Windshield	
[XV17ATV(C)/XV17ATMV(C)]	3-12

PROTECT YOUR INVESTMENT

Use Genuine YAMAHA Parts And Accessories

See your Authorized YAMAHA Dealer for a Genuine YAMAHA Service Manual.



YAMAHA MOTOR CO., LTD.

PRINTED ON RECYCLED PAPER

PRINTED IN JAPAN
2005.06-1.3×2 CR
(E)