

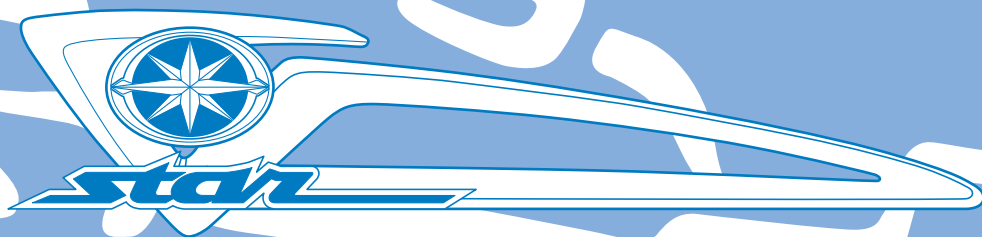

**OWNER'S MANUAL**



***XVS11V(C)***  
***XVS11AWV(C)***  
***XVS11ATV(C)***

**LIT-11626-19-71**

**3B8-28199-1R**

EAU10041

 **WARNING**

**The engine exhaust from this product contains chemicals known to the State of California to cause cancer, birth defects or other reproductive harm.**

YAMAHA

LIT-CALIF-65-01

Congratulations on your purchase of the Yamaha XVS11V(C)/XVS11AWV(C)/XVS11ATV(C). This model is the result of Yamaha's vast experience in the production of fine sporting, touring, and pacesetting racing machines. It represents the high degree of craftsmanship and reliability that have made Yamaha a leader in these fields.

This manual will give you an understanding of the operation, inspection, and basic maintenance of this motorcycle. If you have any questions concerning the operation or maintenance of your motorcycle, please consult a Yamaha dealer.

The design and manufacture of this Yamaha motorcycle fully comply with the emissions standards for clean air applicable at the date of manufacture. Yamaha has met these standards without reducing the performance or economy of operation of the motorcycle. To maintain these high standards, it is important that you and your Yamaha dealer pay close attention to the recommended maintenance schedules and operating instructions contained within this manual.



# IMPORTANT MANUAL INFORMATION

---

---

EAU10130

Particularly important information is distinguished in this manual by the following notations:

	<b>The Safety Alert Symbol means ATTENTION! BECOME ALERT! YOUR SAFETY IS INVOLVED!</b>
	<b>Failure to follow WARNING instructions could result in severe injury or death to the motorcycle operator, a bystander or a person inspecting or repairing the motorcycle.</b>
<b>CAUTION:</b>	<b>A CAUTION indicates special precautions that must be taken to avoid damage to the motorcycle.</b>
<b>NOTE:</b>	<b>A NOTE provides key information to make procedures easier or clearer.</b>

## NOTE:

- This manual should be considered a permanent part of this motorcycle and should remain with it even if the motorcycle is subsequently sold.
- Yamaha continually seeks advancements in product design and quality. Therefore, while this manual contains the most current product information available at the time of printing, there may be minor discrepancies between your motorcycle and this manual. If you have any questions concerning this manual, please consult your Yamaha dealer.

EWA10010

## WARNING

**PLEASE READ THIS MANUAL AND THE “YOU AND YOUR MOTORCYCLE: RIDING TIPS” BOOKLET CAREFULLY AND COMPLETELY BEFORE OPERATING THIS MOTORCYCLE. DO NOT ATTEMPT TO OPERATE THIS MOTORCYCLE UNTIL YOU HAVE ATTAINED ADEQUATE KNOWLEDGE OF ITS CONTROLS AND OPERATING FEATURES**



## **IMPORTANT MANUAL INFORMATION**

---

---

**AND UNTIL YOU HAVE BEEN TRAINED IN SAFE AND PROPER RIDING TECHNIQUES. REGULAR INSPECTIONS AND CAREFUL MAINTENANCE, ALONG WITH GOOD RIDING SKILLS, WILL ENSURE THAT YOU SAFELY ENJOY THE CAPABILITIES AND THE RELIABILITY OF THIS MOTORCYCLE.**

---

# IMPORTANT MANUAL INFORMATION

---

---

EAU10192

AFFIX DEALER  
LABEL HERE

**XVS11V(C)/XVS11AWV(C)/XVS11ATV(C)  
OWNER'S MANUAL**  
©2005 by Yamaha Motor Corporation, U.S.A.  
1st edition, June 2005  
All rights reserved.  
Any reprinting or unauthorized use  
without the written permission of  
Yamaha Motor Corporation, U.S.A.  
is expressly prohibited.  
Printed in Japan.  
P/N LIT-11626-19-71

# TABLE OF CONTENTS

<b>SAFETY INFORMATION</b> .....	1-1	Adjusting the shock absorber assembly .....	3-14	Final gear oil .....	6-12
Location of important labels .....	1-5	Luggage strap holders .....	3-16	Cleaning the air filter element .....	6-13
<b>DESCRIPTION</b> .....	2-1	Sidestand .....	3-16	Carburetors .....	6-14
Left view .....	2-1	Ignition circuit cut-off system .....	3-17	Checking the throttle cable free play .....	6-15
Right view .....	2-3	<b>PRE-OPERATION CHECKS</b> .....	4-1	Valve clearance .....	6-15
Controls and instruments .....	2-5	Pre-operation check list .....	4-2	Tires (XVS11V) .....	6-15
<b>INSTRUMENT AND CONTROL</b>		<b>OPERATION AND IMPORTANT</b>		Tires (XVS11AWV/XVS11ATV) ....	6-18
<b>FUNCTIONS</b> .....	3-1	<b>RIDING POINTS</b> .....	5-1	Spoke wheels (XVS11V) .....	6-20
Main switch/steering lock .....	3-1	Starting and warming up a cold engine .....	5-1	Cast wheels (XVS11AWV/XVS11ATV) .....	6-20
Indicator and warning lights .....	3-2	Starting a warm engine .....	5-2	Accessories and replacement parts .....	6-21
Speedometer unit .....	3-3	Shifting .....	5-3	Adjusting the clutch lever free play .....	6-22
Handlebar switches .....	3-3	Engine break-in .....	5-4	Adjusting the brake lever free play .....	6-22
Clutch lever .....	3-4	Parking .....	5-5	Adjusting the rear brake light switch .....	6-23
Shift pedal (XVS11V) .....	3-5	<b>PERIODIC MAINTENANCE AND</b>		Checking the front and rear brake pads .....	6-24
Shift pedal (XVS11AWV/XVS11ATV) .....	3-5	<b>MINOR REPAIR</b> .....	6-1	Checking the brake fluid level .....	6-24
Brake lever .....	3-5	PERIODIC MAINTENANCE .....	6-1	Changing the brake fluid .....	6-25
Brake pedal .....	3-6	Owner's tool kit .....	6-1	Checking and lubricating the cables .....	6-26
Fuel tank cap .....	3-6	Periodic maintenance chart for the emission control system .....	6-3	Checking and lubricating the throttle grip and cable .....	6-26
Fuel .....	3-7	General maintenance and lubrication chart .....	6-4	Checking and lubricating the brake and shift pedals .....	6-26
Catalytic converter (for California only) .....	3-8	Removing and installing the panel .....	6-8	Checking and lubricating the brake and clutch levers .....	6-27
Fuel cock .....	3-8	Checking the spark plugs .....	6-8		
Starter (choke) lever .....	3-9	Canister (for California only) .....	6-10		
Seats (XVS11V) .....	3-9	Engine oil .....	6-10		
Seats (XVS11AWV/XVS11ATV) .....	3-11				
Helmet holder .....	3-12				
Storage compartment .....	3-13				

# TABLE OF CONTENTS

---

Checking and lubricating the sidestand .....	6-27
Lubricating the swingarm pivots ...	6-28
Lubricating the rear suspension ...	6-28
Checking the front fork .....	6-28
Checking the steering .....	6-29
Checking the wheel bearings .....	6-30
Battery .....	6-30
Replacing the fuses .....	6-31
Replacing the headlight bulb .....	6-33
Replacing a turn signal light bulb or the tail/brake light bulb .....	6-34
Supporting the motorcycle .....	6-35
Troubleshooting .....	6-35
Troubleshooting chart .....	6-36

## **MOTORCYCLE CARE AND**

<b>STORAGE</b> .....	7-1
Care .....	7-1
Storage .....	7-3

## **SPECIFICATIONS** .....

<b>CONSUMER INFORMATION</b> .....	9-1
Identification numbers .....	9-1
Reporting safety defects .....	9-3
Motorcycle noise regulation .....	9-4
Maintenance record .....	9-5

YAMAHA MOTOR CORPORATION, U.S.A. STREET AND ENDURO MOTORCYCLE LIMITED WARRANTY .....	9-7
YAMAHA EXTENDED SERVICE (Y.E.S.) .....	9-9

EAU10251

MOTORCYCLES ARE SINGLE TRACK VEHICLES. THEIR SAFE USE AND OPERATION ARE DEPENDENT UPON THE USE OF PROPER RIDING TECHNIQUES AS WELL AS THE EXPERTISE OF THE OPERATOR. EVERY OPERATOR SHOULD KNOW THE FOLLOWING REQUIREMENTS BEFORE RIDING THIS MOTORCYCLE.

HE OR SHE SHOULD:

- OBTAIN THOROUGH INSTRUCTIONS FROM A COMPETENT SOURCE ON ALL ASPECTS OF MOTORCYCLE OPERATION.
- OBSERVE THE WARNINGS AND MAINTENANCE REQUIREMENTS IN THE OWNER'S MANUAL.
- OBTAIN QUALIFIED TRAINING IN SAFE AND PROPER RIDING TECHNIQUES.
- OBTAIN PROFESSIONAL TECHNICAL SERVICE AS INDICATED BY THE OWNER'S MANUAL

AND/OR WHEN MADE NECESSARY BY MECHANICAL CONDITIONS.

### Safe riding

- Always make pre-operation checks. Careful checks may help prevent an accident.
- This motorcycle is designed to carry the operator and a passenger.
- The failure of motorists to detect and recognize motorcycles in traffic is the predominating cause of automobile/motorcycle accidents. Many accidents have been caused by an automobile driver who did not see the motorcycle. Making yourself conspicuous appears to be very effective in reducing the chance of this type of accident.

### Therefore:

- Wear a brightly colored jacket.
- Use extra caution when approaching and passing through intersections, since intersections are the most likely places for motorcycle accidents to occur.

- Ride where other motorists can see you. Avoid riding in another motorist's blind spot.
- Many motorcycle accidents involve inexperienced operators. In fact, many operators who have been involved in accidents do not even have a current motorcycle license.
- Make sure that you are qualified and that you only lend your motorcycle to other qualified operators.
- Know your skills and limits. Staying within your limits may help you to avoid an accident.
- We recommend that you practice riding your motorcycle where there is no traffic until you have become thoroughly familiar with the motorcycle and all of its controls.
- Many motorcycle accidents have been caused by error of the motorcycle operator. A typical error made by the operator is veering

# SAFETY INFORMATION

---

1

wide on a turn due to EXCESSIVE SPEED or undercornering (insufficient lean angle for the speed).

- Always obey the speed limit and never travel faster than warranted by road and traffic conditions.
- Always signal before turning or changing lanes. Make sure that other motorists can see you.
- The posture of the operator and passenger is important for proper control.
  - The operator should keep both hands on the handlebar and both feet on the operator footrests during operation to maintain control of the motorcycle.
  - The passenger should always hold onto the operator, seat strap, or grab bar, if equipped, with both hands and keep both feet on the passenger footrests.
  - Never carry a passenger unless he or she can firmly place both feet on the passenger footrests.
- Never ride under the influence of alcohol or other drugs.

- This motorcycle is designed for on-road use only, therefore, it is not suitable for off-road use.

## **Protective apparel**

The majority of fatalities from motorcycle accidents are the result of head injuries. The use of a safety helmet is the single most critical factor in the prevention or reduction of head injuries.

- Always wear an approved helmet.
- Wear a face shield or goggles. Wind in your unprotected eyes could contribute to an impairment of vision which could delay seeing a hazard.
- The use of a jacket, heavy boots, trousers, gloves, etc., is effective in preventing or reducing abrasions or lacerations.
- Never wear loose-fitting clothes, otherwise they could catch on the control levers, footrests, or wheels and cause injury or an accident.
- Never touch the engine or exhaust system during or after operation. They become very hot and can

cause burns. Always wear protective clothing that covers your legs, ankles, and feet.

- Passengers should also observe the precautions mentioned above.

## **Modifications**

Modifications made to this motorcycle not approved by Yamaha, or the removal of original equipment, may render the motorcycle unsafe for use and may cause severe personal injury. Modifications may also make your motorcycle illegal to use.

## **Loading and accessories**

Adding accessories or cargo to your motorcycle can adversely affect stability and handling if the weight distribution of the motorcycle is changed. To avoid the possibility of an accident, use extreme caution when adding cargo or accessories to your motorcycle. Use extra care when riding a motorcycle that has added cargo or accessories. Here are some general guidelines to follow if loading cargo or adding accessories to your motorcycle:

## Loading

The total weight of the operator, passenger, accessories and cargo must not exceed the maximum load limit.

### **Maximum load:**

XVS11ATV 203 kg (448 lb)  
XVS11ATVC 200 kg (441 lb)  
XVS11AWV 203 kg (448 lb)  
XVS11AWVC 200 kg (441 lb)  
XVS11V 200 kg (441 lb)  
XVS11VC 197 kg (434 lb)

When loading within this weight limit, keep the following in mind:

- Cargo and accessory weight should be kept as low and close to the motorcycle as possible. Make sure to distribute the weight as evenly as possible on both sides of the motorcycle to minimize imbalance or instability.
- Shifting weights can create a sudden imbalance. Make sure that accessories and cargo are securely attached to the motorcycle before riding. Check accessory mounts and cargo restraints frequently.

- Never attach any large or heavy items to the handlebar, front fork, or front fender. These items, including such cargo as sleeping bags, duffel bags, or tents, can create unstable handling or slow steering response.

## Accessories

Genuine Yamaha accessories have been specifically designed for use on this motorcycle. Since Yamaha cannot test all other accessories that may be available, you must personally be responsible for the proper selection, installation and use of non-Yamaha accessories. Use extreme caution when selecting and installing any accessories.

Keep the following guidelines in mind, as well as those provided under “Loading” when mounting accessories.

- Never install accessories or carry cargo that would impair the performance of your motorcycle. Carefully inspect the accessory before using it to make sure that it does not in any way reduce ground clearance or cornering clearance,

limit suspension travel, steering travel or control operation, or obscure lights or reflectors.

- Accessories fitted to the handlebar or the front fork area can create instability due to improper weight distribution or aerodynamic changes. If accessories are added to the handlebar or front fork area, they must be as lightweight as possible and should be kept to a minimum.
- Bulky or large accessories may seriously affect the stability of the motorcycle due to aerodynamic effects. Wind may attempt to lift the motorcycle, or the motorcycle may become unstable in cross winds. These accessories may also cause instability when passing or being passed by large vehicles.
- Certain accessories can displace the operator from his or her normal riding position. This improper position limits the freedom of movement of the opera-

# SAFETY INFORMATION

1

tor and may limit control ability, therefore, such accessories are not recommended.

- Use caution when adding electrical accessories. If electrical accessories exceed the capacity of the motorcycle's electrical system, an electric failure could result, which could cause a dangerous loss of lights or engine power.

## **Gasoline and exhaust gas**

- **GASOLINE IS HIGHLY FLAMMABLE:**
  - Always turn the engine off when refueling.
  - Take care not to spill any gasoline on the engine or exhaust system when refueling.
  - Never refuel while smoking or in the vicinity of an open flame.
- Never start the engine or let it run for any length of time in a closed area. The exhaust fumes are poisonous and may cause loss of consciousness and death within a short time. Always operate your motorcycle in an area that has adequate ventilation.

- Always turn the engine off before leaving the motorcycle unattended and remove the key from the main switch. When parking the motorcycle, note the following:
  - The engine and exhaust system may be hot, therefore, park the motorcycle in a place where pedestrians or children are not likely to touch these hot areas.
  - Do not park the motorcycle on a slope or soft ground, otherwise it may fall over.
  - Do not park the motorcycle near a flammable source (e.g. a kerosene heater, or near an open flame), otherwise it could catch fire.
- When transporting the motorcycle in another vehicle, make sure that it is kept upright and that the fuel cock is turned to "ON" or "RES" (for vacuum type) / "OFF" (for manual type). If it should lean over, gasoline may leak out of the carburetor or fuel tank.
- If you should swallow any gasoline, inhale a lot of gasoline vapor, or allow gasoline to get into your

eyes, see your doctor immediately. If any gasoline spills on your skin or clothing, immediately wash the affected area with soap and water and change your clothes.



## Location of important labels

Please read the following important labels carefully before operating this vehicle.

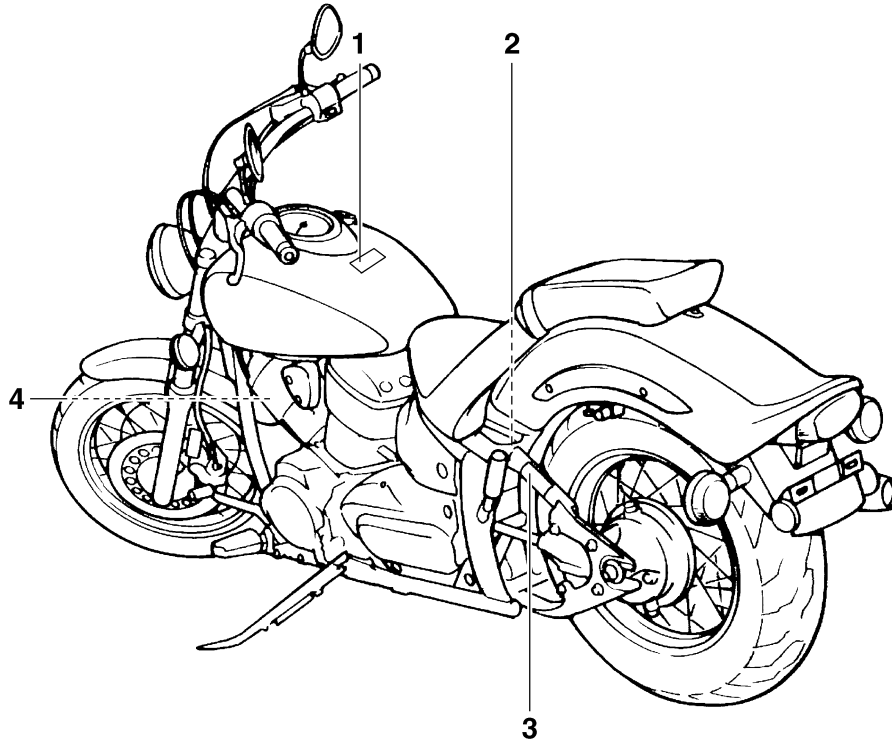

# SAFETY INFORMATION

1

1

**⚠ WARNING**

- BEFORE YOU OPERATE THIS VEHICLE, READ THE OWNER'S MANUAL AND ALL LABELS.
- ALWAYS WEAR AN APPROVED MOTORCYCLE HELMET, eye protection, and protective clothing.

5GK-2118K-00

2

**⚠ WARNING**

This unit contains high pressure nitrogen gas. Mishandling can cause explosion.

- Read owner's manual for instructions.
- Do not incinerate, puncture or open.

4AA-22259-80

4 California only

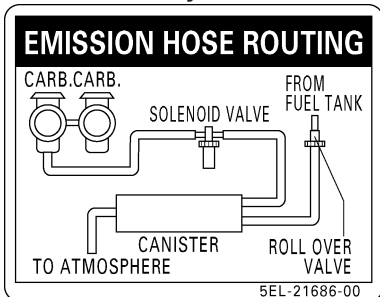

3 XVS11V

**TIRE INFORMATION**

Cold tire normal pressure should be set as follows.

- Up to 90 kg (198 lbs) load

**FRONT** : 200kPa, {2.00kgf/cm<sup>2</sup>}, 29psi

**REAR** : 225kPa, {2.25kgf/cm<sup>2</sup>}, 33psi

- 90 kg (198 lbs) ~ maximum load

**FRONT** : 225kPa, {2.25kgf/cm<sup>2</sup>}, 33psi

**REAR** : 250kPa, {2.50kgf/cm<sup>2</sup>}, 36psi

5EL-21668-00

3 XVS11AWV / XVS11ATV

**TIRE INFORMATION**

Cold tire normal pressure should be set as follows.

- Up to 90 kg (198 lbs) load

**FRONT** : 225 kPa, {2.25 kgf/cm<sup>2</sup>}, 33 psi

**REAR** : 250 kPa, {2.50 kgf/cm<sup>2</sup>}, 36 psi

- 90 kg (198 lbs) ~ maximum load

**FRONT** : 225 kPa, {2.25 kgf/cm<sup>2</sup>}, 33 psi

**REAR** : 250 kPa, {2.50 kgf/cm<sup>2</sup>}, 36 psi

5KS-21668-00

## Left view

### XVS11V

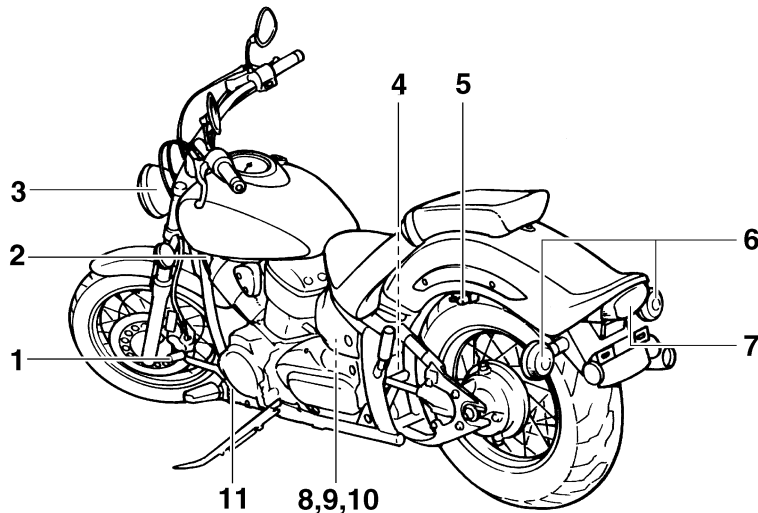

1. Shift pedal (page 3-5)

2. Fuel cock (page 3-8)

3. Headlight (page 6-33)

4. Shock absorber assembly spring preload adjusting ring (page 3-14)

5. Helmet holder (page 3-12)

6. Rear turn signal light (page 6-34)

7. Tail/brake light (page 6-34)

8. Storage compartment (page 3-13)

9. Owner's tool kit (page 6-1)

10. Fuse box (page 6-31)

11. Engine oil level check window (page 6-10)

# DESCRIPTION

---

## XVS11AWV/XVS11ATV

2

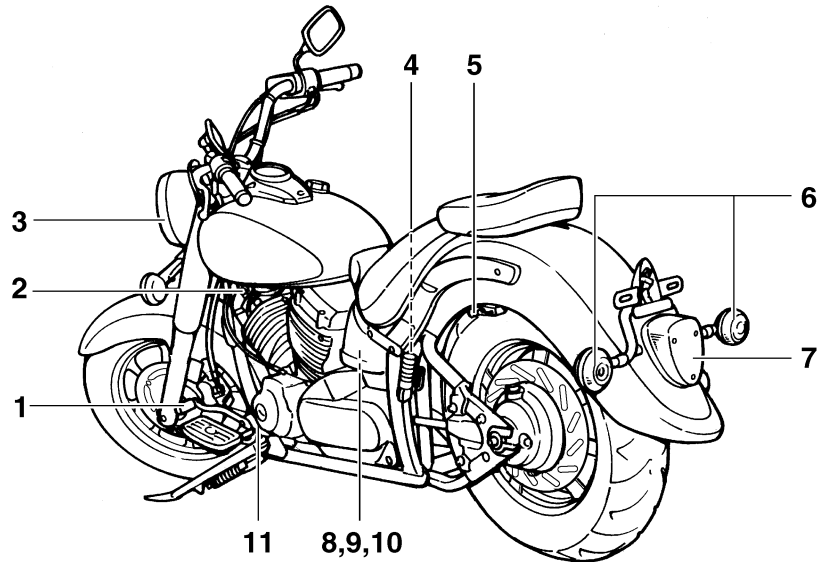

1. Shift pedal (page 3-5)
2. Fuel cock (page 3-8)
3. Headlight (page 6-33)
4. Shock absorber assembly spring preload adjusting ring (page 3-14)
5. Helmet holder (page 3-12)
6. Rear turn signal light (page 6-34)
7. Tail/brake light (page 6-34)
8. Storage compartment (page 3-13)
9. Owner's tool kit (page 6-1)
10. Fuse box (page 6-31)
11. Engine oil level check window (page 6-10)

## Right view

### XVS11V

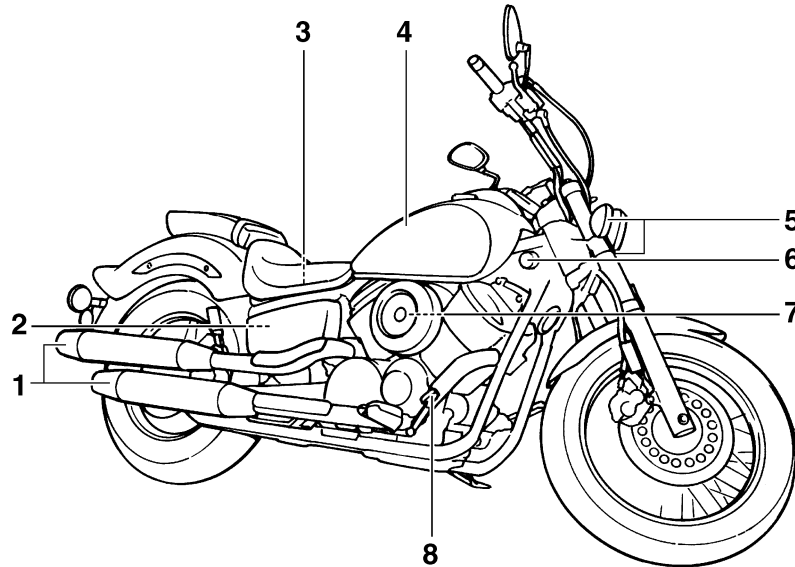

1. Muffler
2. Battery (page 6-30)
3. Main fuse (page 6-31)
4. Fuel tank (page 3-6)
5. Front turn signal/position lights (page 6-34)
6. Main switch/steering lock (page 3-1)
7. Air filter element (page 6-13)
8. Brake pedal (page 3-6)

# DESCRIPTION

XVS11AWV/XVS11ATV

2

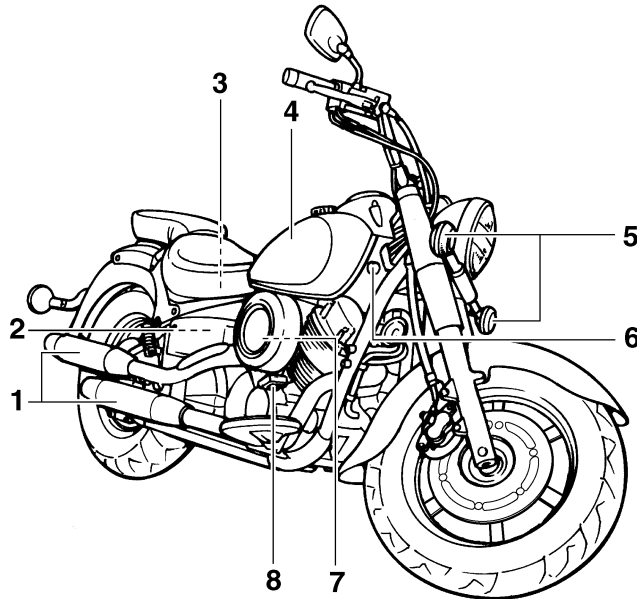

1. Muffler
2. Battery (page 6-30)
3. Main fuse (page 6-31)
4. Fuel tank (page 3-6)
5. Front turn signal/position lights (page 6-34)
6. Main switch/steering lock (page 3-1)
7. Air filter element (page 6-13)
8. Brake pedal (page 3-6)

## Controls and instruments

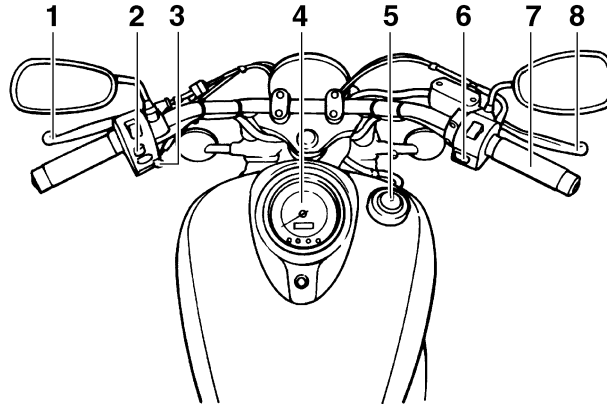

1. Clutch lever (page 3-4)
2. Left handlebar switches (page 3-3)
3. Starter (choke) lever (page 3-9)
4. Speedometer unit (page 3-3)
5. Fuel tank cap (page 3-6)
6. Right handlebar switches (page 3-3)
7. Throttle grip (page 6-15)
8. Brake lever (page 3-5)

# INSTRUMENT AND CONTROL FUNCTIONS

## Main switch/steering lock

EAU10460

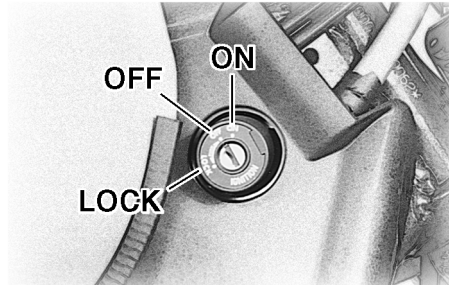

3

The main switch/steering lock controls the ignition and lighting systems, and is used to lock the steering. The various positions are described below.

### ON

EAU10510

All electrical systems are supplied with power, and the headlight, meter lighting, taillight and position lights come on, and the engine can be started. The key cannot be removed.

### OFF

EAU10660

All electrical systems are off. The key can be removed.

### LOCK

EAU10680

The steering is locked, and all electrical systems are off. The key can be removed.

### To lock the steering

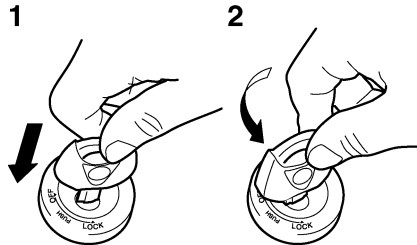

1. Push.
2. Turn.

1. Turn the handlebars all the way to the left.
2. Push the key in from the "OFF" position, and then turn it to "LOCK" while still pushing it.
3. Remove the key.

### To unlock the steering

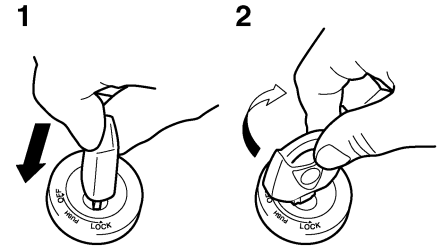

1. Push.
2. Turn.

Push the key in, and then turn it to "OFF" while still pushing it.

EWA10060

### **⚠ WARNING**



**Never turn the key to "OFF" or "LOCK" while the vehicle is moving, otherwise the electrical systems will be switched off, which may result in loss of control or an accident. Make sure that the vehicle is stopped before turning the key to "OFF" or "LOCK".**



# INSTRUMENT AND CONTROL FUNCTIONS

## Indicator and warning lights EAU11003



1. Oil level warning light “ 

## Turn signal indicator light “ This indicator light flashes when the turn signal switch is pushed to the left or right.

## Neutral indicator light “**N**” EAU11060

This indicator light comes on when the transmission is in the neutral position.

## High beam indicator light “ This indicator light comes on when the high beam of the headlight is switched on.

## Oil level warning light “ This warning light comes on when the engine oil level is low.

The electrical circuit of the warning light can be checked by turning the key to “ON”.

If the warning light does not come on for a few seconds, then go off, have a Yamaha dealer check the electrical circuit.

## NOTE: \_\_\_\_\_

Even if the oil level is sufficient, the warning light may flicker when riding on a slope or during sudden acceleration or deceleration, but this is not a malfunction.

---

## Engine trouble warning light “ This warning light comes on or flashes when an electrical circuit monitoring the engine is defective. When this occurs, have a Yamaha dealer check the self-diagnosis system.

The electrical circuit of the warning light can be checked by turning the key to “ON”. If the warning light does not come on for a few seconds, then go off, have a Yamaha dealer check the electrical circuit.

# INSTRUMENT AND CONTROL FUNCTIONS

## Speedometer unit

EAU11731

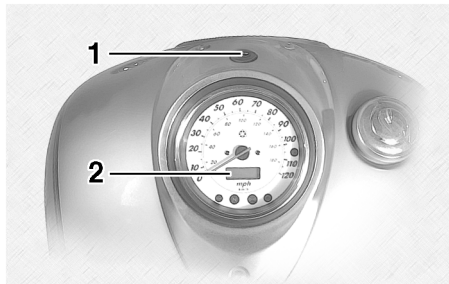

1. "TRIP" button
2. Odometer/tripmeter

The speedometer unit is equipped with a digital odometer and a tripmeter. The speedometer shows riding speed. The odometer shows the total distance traveled. The tripmeter shows the distance traveled since it was last set to zero.

Pushing the "TRIP" button switches the display between the odometer mode "ODO" and the tripmeter mode "TRIP".

To reset the tripmeter, select it by pushing the "TRIP" button, and then push the "TRIP" button again and hold it down for at least one second. The tripmeter can be used to estimate the dis-

tance that can be traveled with a full tank of fuel. This information will enable you to plan future fuel stops.

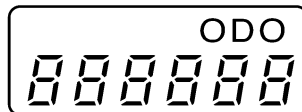
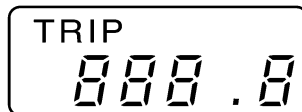

### NOTE:

This model is not equipped with a tachometer; however, it has a built-in speed limiter, which prevents the engine speed from exceeding approximately 6800 r/min and the vehicle speed from exceeding approximately 175 km/h (110 mi/h).

## Handlebar switches

EAU12343

### Left

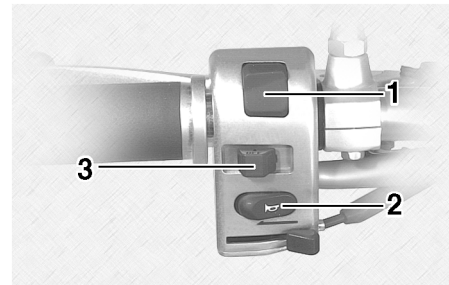

1. Dimmer switch "☰/☷"
2. Horn switch "📢"
3. Turn signal switch "↶/↷"

### Right





1. Engine stop switch "⊙/⊗"
2. Start switch "🌀"

# INSTRUMENT AND CONTROL FUNCTIONS



## Dimmer switch “/”

EAU12400

Set this switch to “” for the high beam and to “” for the low beam.

## Turn signal switch “/”

EAU12430

To signal a right-hand turn, push this switch to “”. To signal a left-hand turn, push this switch to “”. When released, the switch returns to the center position.

Since this model is equipped with a self-canceling system, the turn signal lights will self-cancel after the vehicle has traveled both about 150 m (490 ft) and for approximately 15 seconds. However, the turn signal lights can also be canceled manually by pushing the switch in after it has returned to the center position.

## NOTE: \_\_\_\_\_

The self-canceling system only operates when the vehicle is moving, so that the turn signal lights will not self-cancel while you are stopped at an intersection.



## Horn switch “”

EAU12500

Press this switch to sound the horn.

## Engine stop switch “/”

EAU12660

Set this switch to “” before starting the engine. Set this switch to “” to stop the engine in case of an emergency, such as when the vehicle overturns or when the throttle cable is stuck.

## Start switch “”

EAU12710

Push this switch to crank the engine with the starter.

## CAUTION: \_\_\_\_\_

**See page 5-1 for starting instructions prior to starting the engine.**

## Clutch lever

EAU12820

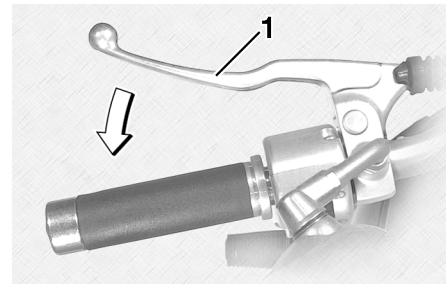

1. Clutch lever

The clutch lever is located at the left handlebar grip. To disengage the clutch, pull the lever toward the handlebar grip. To engage the clutch, release the lever. The lever should be pulled rapidly and released slowly for smooth clutch operation.

The clutch lever is equipped with a clutch switch, which is part of the ignition circuit cut-off system. (See page 3-17.)

# INSTRUMENT AND CONTROL FUNCTIONS

## Shift pedal (XVS11V)

EAU12870

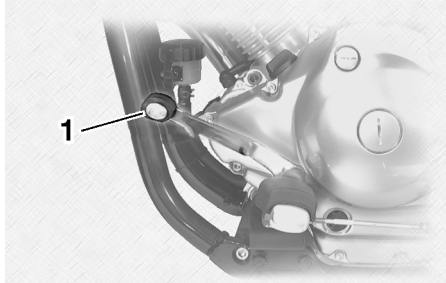

1. Shift pedal

The shift pedal is located on the left side of the engine and is used in combination with the clutch lever when shifting the gears of the 5-speed constant-mesh transmission equipped on this motorcycle.

## Shift pedal (XVS11AWV/XVS11ATV)

EAU12880

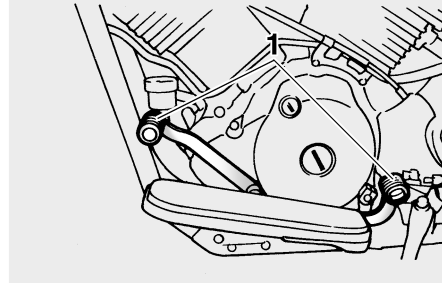

1. Shift pedal

The shift pedal is located on the left side of the engine and is used in combination with the clutch lever when shifting the gears of the 5-speed constant-mesh transmission equipped on this motorcycle.

### **NOTE:** \_\_\_\_\_

Use your toes or heel to shift up and your toes to shift down.

---

## Brake lever

EAU12890

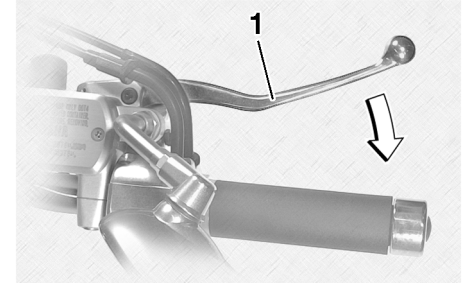

1. Brake lever

The brake lever is located at the right handlebar grip. To apply the front brake, pull the lever toward the handlebar grip.

# INSTRUMENT AND CONTROL FUNCTIONS

## Brake pedal

EAU12941

### XVS11V

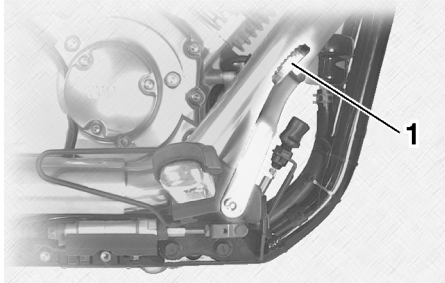

1. Brake pedal

### XVS11AWV/XVS11ATV

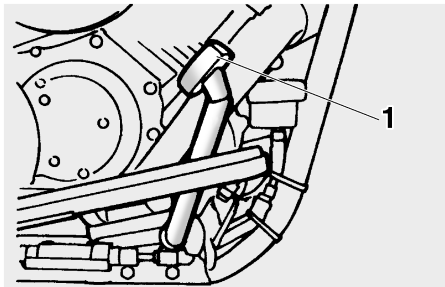

1. Brake pedal

The brake pedal is on the right side of the motorcycle. To apply the rear brake, press down on the brake pedal.

## Fuel tank cap

EAU13120

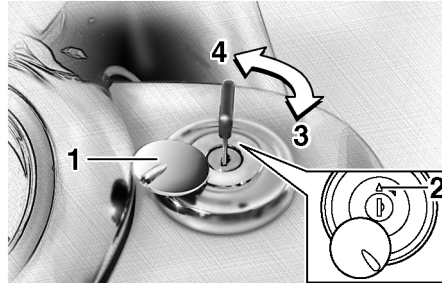

1. Fuel tank cap lock cover
2. "△" mark
3. Unlock.
4. Lock.

### To remove the fuel tank cap

Slide the lock cover open, insert the key into the lock, and then turn it 1/4 turn clockwise. The lock will be released and the fuel tank cap can be removed.

### To install the fuel tank cap

1. Insert the fuel tank cap into the tank opening with the key inserted in the lock and with the "△" mark facing forward.

2. Turn the key counterclockwise to the original position, remove it, and then close the lock cover.

**NOTE:** \_\_\_\_\_  
The fuel tank cap cannot be installed unless the key is in the lock. In addition, the key cannot be removed if the cap is not properly installed and locked.

EWA10130



**WARNING** \_\_\_\_\_  
**Make sure that the fuel tank cap is properly installed before riding.**

# INSTRUMENT AND CONTROL FUNCTIONS

## Fuel

EAU13210

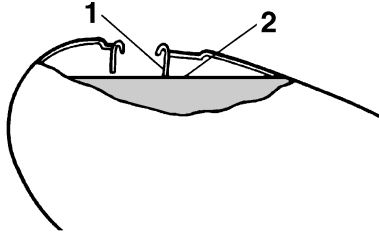

1. Fuel tank filler tube
2. Fuel level

Make sure that there is sufficient fuel in the tank. Fill the fuel tank to the bottom of the filler tube as shown.

EWA10880

### **⚠ WARNING**

- Do not overfill the fuel tank, otherwise it may overflow when the fuel warms up and expands.
- Avoid spilling fuel on the hot engine.

ECA10070

### **CAUTION:**

Immediately wipe off spilled fuel with a clean, dry, soft cloth, since fuel may deteriorate painted surfaces or plastic parts.

EAU13300

#### **Recommended fuel:**

UNLEADED GASOLINE ONLY

#### **Fuel tank capacity:**

17.0 L (4.49 US gal) (3.74 Imp.gal)

#### **Fuel reserve amount:**

4.5 L (1.19 US gal) (0.99 Imp.gal)

ECA11400

### **CAUTION:**

Use only unleaded gasoline. The use of leaded gasoline will cause severe damage to internal engine parts, such as the valves and piston rings, as well as to the exhaust system.

Your Yamaha engine has been designed to use regular unleaded gasoline with a pump octane number  $[(R+M)/2]$  of 86 or higher, or a research octane number of 91 or higher. If

knocking (or pinging) occurs, use a gasoline of a different brand or premium unleaded fuel. Use of unleaded fuel will extend spark plug life and reduce maintenance costs.

### **Gasohol**

There are two types of gasohol: gasohol containing ethanol and that containing methanol. Gasohol containing ethanol can be used if the ethanol content does not exceed 10%. Gasohol containing methanol is not recommended by Yamaha because it can cause damage to the fuel system or vehicle performance problems.

# INSTRUMENT AND CONTROL FUNCTIONS

## Catalytic converter (for California only)

EAU13441

This vehicle is equipped with catalytic converters in the exhaust system.

EWA10860

### **WARNING**

The exhaust system is hot after operation. Make sure that the exhaust system has cooled down before doing any maintenance work.

### **CAUTION:**

ECA10700

The following precautions must be observed to prevent a fire hazard or other damages.

- Use only unleaded gasoline. The use of leaded gasoline will cause unreparable damage to the catalytic converter.
- Never park the vehicle near possible fire hazards such as grass or other materials that easily burn.
- Do not allow the engine to idle too long.

## Fuel cock

EAU13550

The fuel cock supplies fuel from the tank to the carburetors while also filtering it.

The fuel cock lever positions are explained as follows and shown in the illustrations.

### OFF

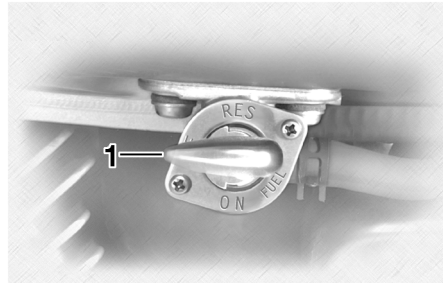

1. Pointed end positioned over "OFF"

With the fuel cock lever in this position, fuel will not flow. Always turn the fuel cock lever to this position when the engine is not running.

### ON

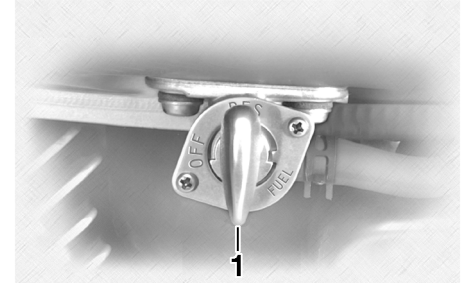

1. Pointed end positioned over "ON"

With the fuel cock lever in this position, fuel flows to the carburetors. Turn the fuel cock lever to this position when starting the engine and riding.

### RES

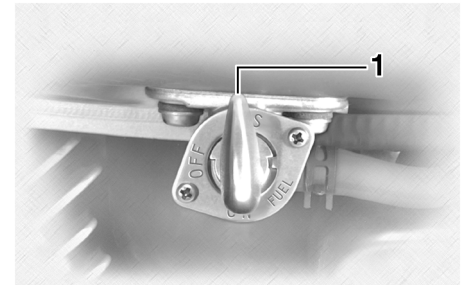

1. Pointed end positioned over "RES"

# INSTRUMENT AND CONTROL FUNCTIONS

This indicates reserve. With the fuel cock lever in this position, the fuel reserve is made available. Turn the fuel cock lever to this position if you run out of fuel while riding. When this occurs, refuel as soon as possible and be sure to turn the fuel cock lever back to “ON”!

3

## Starter (choke) lever “” EAU13610

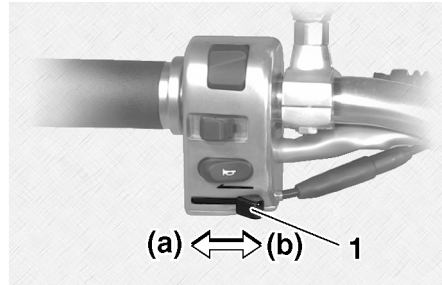

1. Starter (choke) lever “”

Starting a cold engine requires a richer air-fuel mixture, which is supplied by the starter (choke).

Move the lever in direction (a) to turn on the starter (choke).

Move the lever in direction (b) to turn off the starter (choke).

ECA10990

### **CAUTION:**

**Do not use the starter (choke) for more than 3 minutes as the exhaust pipe may discolor from excessive heat. In addition, extended use of the starter (choke) will cause after-burning. If this occurs, turn off the starter (choke).**

## Seats (XVS11V) EAU14213

### Passenger seat

To remove the passenger seat  
Remove the nut and washer, and then pull the passenger seat up.



1. Nut
2. Washer

### To install the passenger seat

1. Insert the projection on the front of the passenger seat into the seat holder as shown and place the seat in the original position.
2. Install the washer and nut, and then tighten the nut to the specified torque.



# INSTRUMENT AND CONTROL FUNCTIONS

## Tightening torque:

Passenger seat nut:  
13 Nm (1.3 m·kgf, 9.4 ft·lbf)

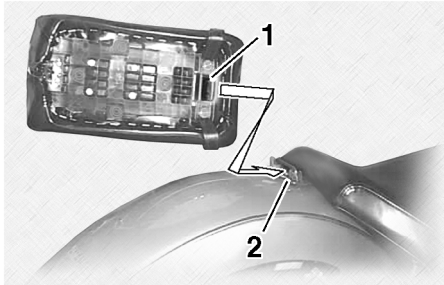

1. Projection
2. Seat holder

## Rider seat

### To remove the rider seat

1. Remove the passenger seat.
2. Remove the bolts and passenger seat holder, and then pull the rider seat up.

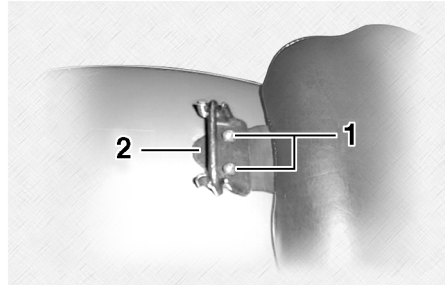

1. Bolt
2. Passenger seat holder

### To install the rider seat

1. Insert the projections on the front of the rider seat into the seat holders as shown, and then place the seat in the original position.

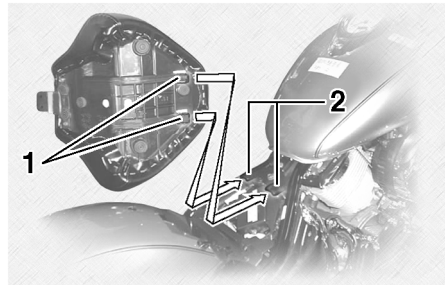

1. Projection
2. Seat holder

2. Install the passenger seat holder and bolts.
3. Install the passenger seat.

**NOTE:** \_\_\_\_\_  
Make sure that the seats are properly secured before riding.  
\_\_\_\_\_

# INSTRUMENT AND CONTROL FUNCTIONS

EAU14201

## Seats (XVS11AWV/XVS11ATV)

### Passenger seat

#### To remove the passenger seat

Remove the nut and washer, and then pull the passenger seat up.

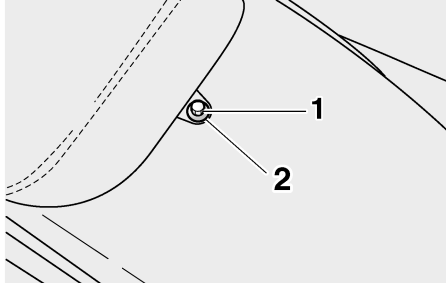

1. Nut
2. Washer

#### To install the passenger seat

1. Insert the projection on the front of the passenger seat into the holder as shown and place the seat in the original position.
2. Install the washer and nut, and then tighten the nut to the specified torque.

**Tightening torque:**  
Passenger seat nut:  
13 Nm (1.3 m·kgf, 9.4 ft·lbf)

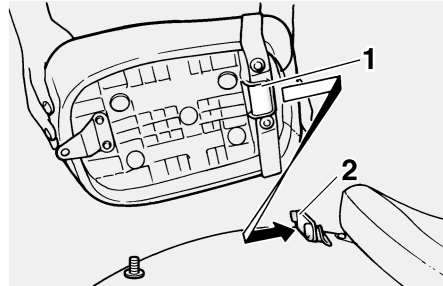

1. Projection
2. Seat holder

### Rider seat

#### To remove the rider seat

1. Remove the passenger seat.
2. Remove the bolt, and then pull the rider seat up.

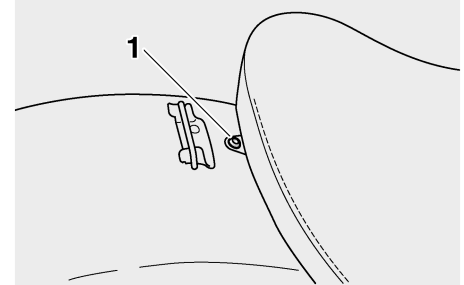

1. Bolt

#### To install the rider seat

1. Insert the projections on the front of the rider seat into the holders as shown, place the seat in the original position, and then install the bolt.

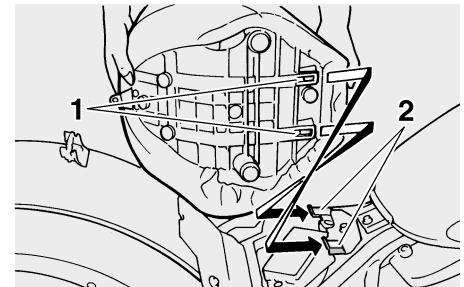

1. Projection
2. Seat holder

# INSTRUMENT AND CONTROL FUNCTIONS

2. Install the passenger seat.

**NOTE:** \_\_\_\_\_  
Make sure that the seats are properly secured before riding.

## Helmet holder

EAU14281

### XVS11V

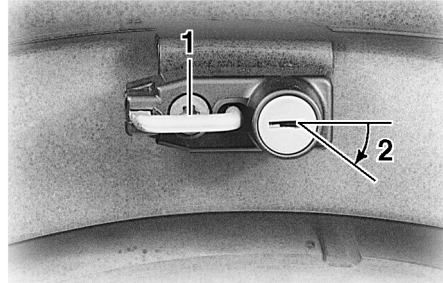

1. Helmet holder
2. Unlock.

To open the helmet holder, insert the key into the lock, and then turn the key as shown.

To lock the helmet holder, place it in the original position, and then remove the key.

EWA10160

### **! WARNING**

**Never ride with a helmet attached to the helmet holder, since the helmet may hit objects, causing loss of control and possibly an accident.**

3

### XVS11AWV/XVS11ATV

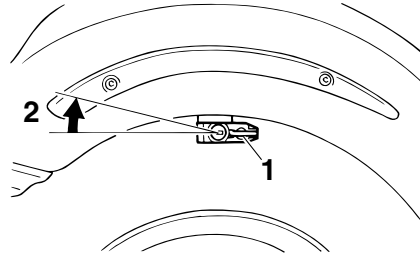

1. Helmet holder
2. Unlock.

# INSTRUMENT AND CONTROL FUNCTIONS

EAU14481

## Storage compartment

The storage compartment is located on the left side of the vehicle.

### To open the storage compartment

1. Slide the lock cover open, insert the key into the lock, and then turn it clockwise.

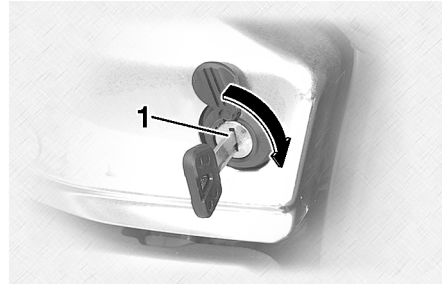

1. Storage compartment lock

2. Pull the storage compartment cover out as shown.

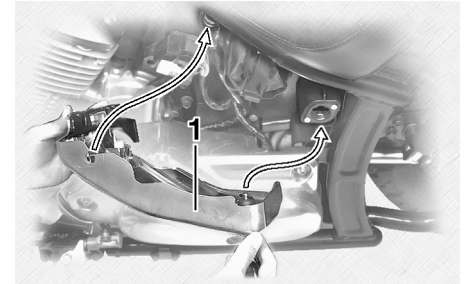

1. Storage compartment cover

2. Turn the key counterclockwise, remove it, and then close the lock cover.

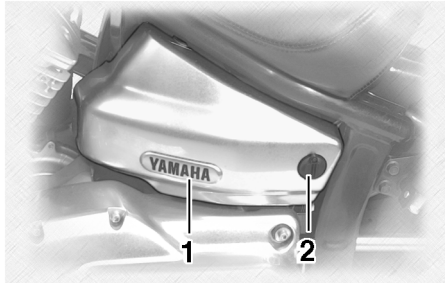

1. Storage compartment cover
2. Storage compartment lock cover

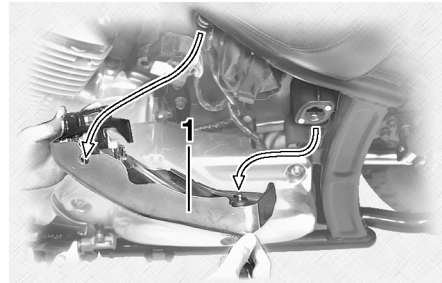

1. Storage compartment cover

### To close the storage compartment

1. Place the storage compartment cover in its original position as shown.

# INSTRUMENT AND CONTROL FUNCTIONS

## Adjusting the shock absorber assembly

EAU14671

The shock absorber assembly is located under the rider seat and is equipped with a spring preload adjusting ring.

ECA10100

### CAUTION:

Never attempt to turn an adjusting mechanism beyond the maximum or minimum settings.

Adjust the spring preload as follows.

1. Remove the rider seat. (See page 3-9.)
2. Remove each quick fastener from the ignitor unit panel by pushing the center in with a screwdriver, then pulling the fastener out.

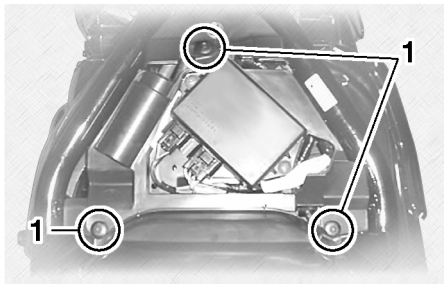

1. Quick fastener

3. Pull the ignitor unit panel out to the right.

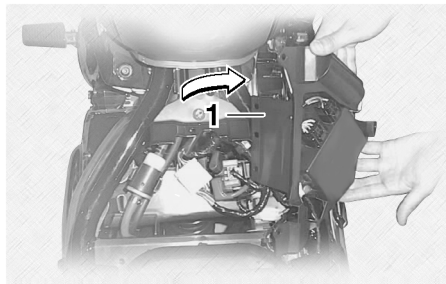

1. Ignitor unit panel

4. Remove the mudguard by removing each quick fastener.

### XVS11V

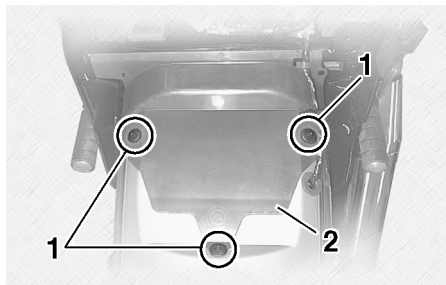

1. Quick fastener  
2. Mudguard

### XVS11AWV/XVS11ATV

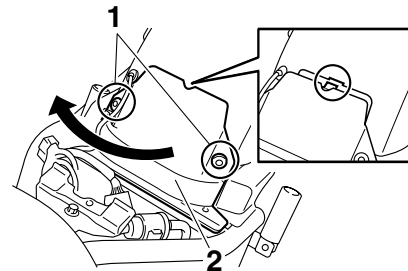

1. Quick fastener  
2. Mudguard

5. To increase the spring preload and thereby harden the suspension, turn the adjusting ring in direction (a). To decrease the spring preload and thereby soften the suspension, turn the adjusting ring in direction (b).

### NOTE:

- Align the appropriate notch in the adjusting ring with the position indicator on the shock absorber.
- Use the special wrench included in the owner's tool kit to make the adjustment.

# INSTRUMENT AND CONTROL FUNCTIONS

## XVS11V

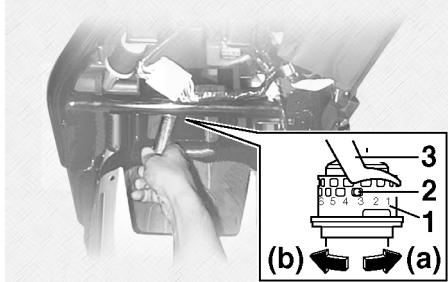

1. Spring preload adjusting ring
2. Position indicator
3. Special wrench

## XVS11AWV/XVS11ATV

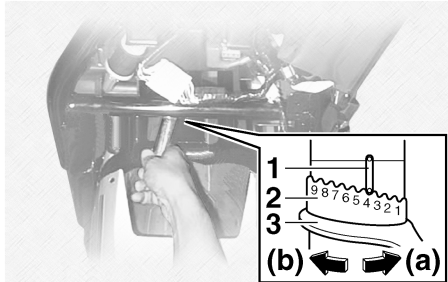

1. Position indicator
2. Spring preload adjusting ring
3. Special wrench

### Spring preload setting:

Minimum (soft):

1

Standard:

XVS11V 3

XVS11AWV 4

XVS11ATV 4

Maximum (hard):

XVS11V 7

XVS11AWV 9

XVS11ATV 9

6. Install the mudguard and ignitor unit panel by installing the quick fasteners.

### NOTE:

To install a quick fastener, push the pin back so that it will protrude from the fastener head, and then insert the fastener and push the protruding pin in until it is flush with the fastener head.

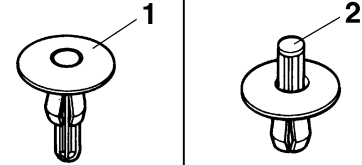

1. Quick fastener (after removal)
2. Quick fastener (before installation)
7. Install the rider seat.

EWA10220

### **WARNING**

This shock absorber contains highly pressurized nitrogen gas. For proper handling, read and understand the following information before handling the shock absorber. The manufacturer cannot be held responsible for property damage or personal injury that may result from improper handling.

- Do not tamper with or attempt to open the gas cylinder.

- Do not subject the shock absorber to an open flame or other high heat sources, otherwise it may explode due to excessive gas pressure.
- Do not deform or damage the gas cylinder in any way, as this will result in poor damping performance.
- Always have a Yamaha dealer service the shock absorber.

## Luggage strap holders

EAU15150

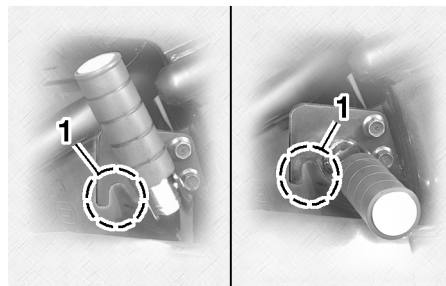

1. Luggage strap holder

There is a luggage strap holder on each passenger footrest.

## Sidestand

EAU15301

The sidestand is located on the left side of the frame. Raise the sidestand or lower it with your foot while holding the vehicle upright.

### NOTE:

The built-in sidestand switch is part of the ignition circuit cut-off system, which cuts the ignition in certain situations. (See further down for an explanation of the ignition circuit cut-off system.)

3

EWA10240

### **WARNING**

The vehicle must not be ridden with the sidestand down, or if the sidestand cannot be properly moved up (or does not stay up), otherwise the sidestand could contact the ground and distract the operator, resulting in a possible loss of control. Yamaha's ignition circuit cut-off system has been designed to assist the operator in fulfilling the responsibility of raising the sidestand before starting off. Therefore, check this system regularly as described

# INSTRUMENT AND CONTROL FUNCTIONS

---

below and have a Yamaha dealer repair it if it does not function properly.

---

3

EAU15311

## Ignition circuit cut-off system

The ignition circuit cut-off system (comprising the sidestand switch, clutch switch and neutral switch) has the following functions.

- It prevents starting when the transmission is in gear and the sidestand is up, but the clutch lever is not pulled.
- It prevents starting when the transmission is in gear and the clutch lever is pulled, but the sidestand is still down.
- It cuts the running engine when the transmission is in gear and the sidestand is moved down.

Periodically check the operation of the ignition circuit cut-off system according to the following procedure.

EWA10250



**If a malfunction is noted, have a Yamaha dealer check the system before riding.**

---



# INSTRUMENT AND CONTROL FUNCTIONS

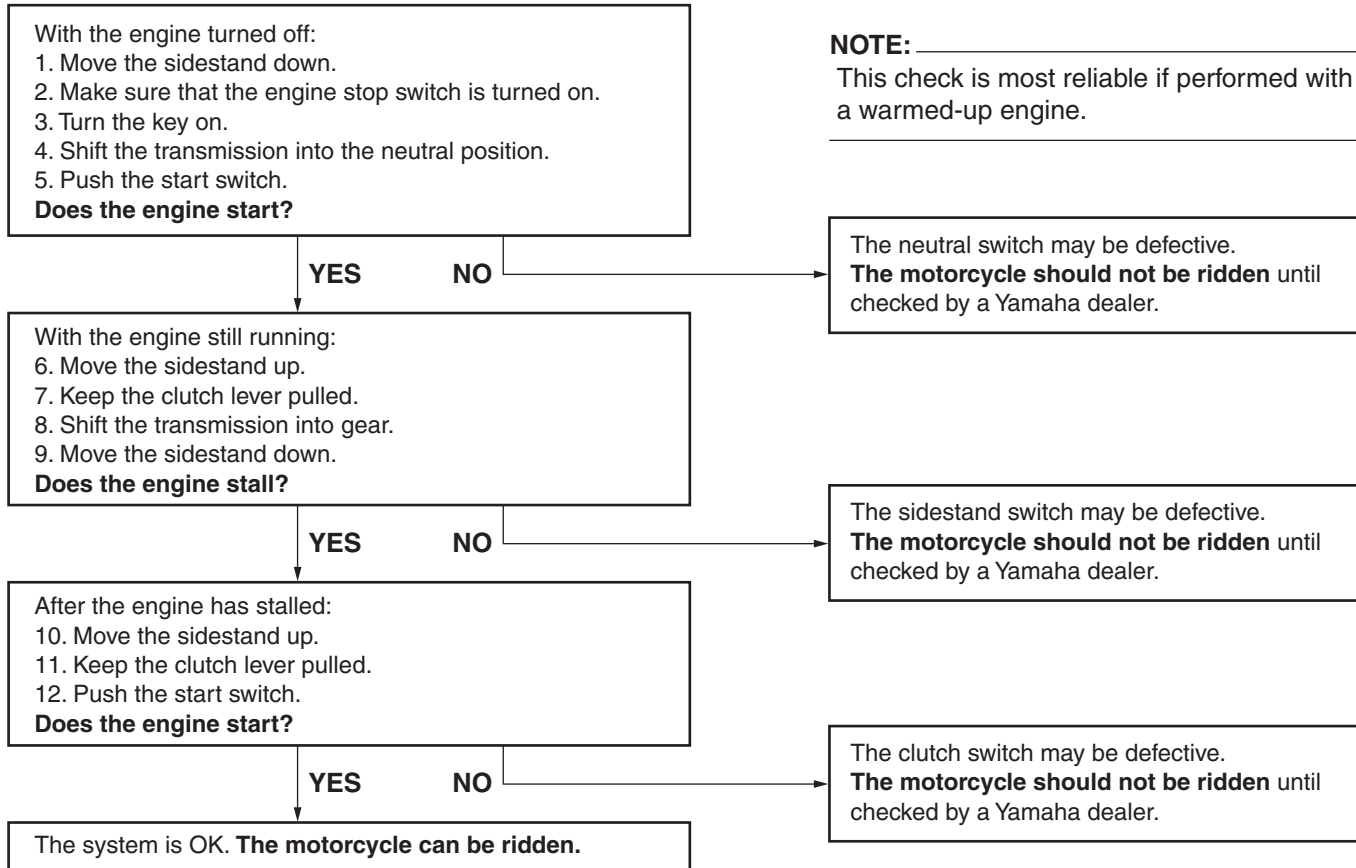

# PRE-OPERATION CHECKS

---

---

EAU15591

The condition of a vehicle is the owner's responsibility. Vital components can start to deteriorate quickly and unexpectedly, even if the vehicle remains unused (for example, as a result of exposure to the elements). Any damage, fluid leakage or loss of tire air pressure could have serious consequences. Therefore, it is very important, in addition to a thorough visual inspection, to check the following points before each ride.

## NOTE:

Pre-operation checks should be made each time the vehicle is used. Such an inspection can be accomplished in a very short time; and the added safety it assures is more than worth the time involved.

EWA11150

4



**If any item in the Pre-operation check list is not working properly, have it inspected and repaired before operating the vehicle.**

---

# PRE-OPERATION CHECKS

EAU15603

## Pre-operation check list

ITEM	CHECKS	PAGE
<b>Fuel</b>	<ul style="list-style-type: none"><li>• Check fuel level in fuel tank.</li><li>• Refuel if necessary.</li><li>• Check fuel line for leakage.</li></ul>	3-7
<b>Engine oil</b>	<ul style="list-style-type: none"><li>• Check oil level in engine.</li><li>• If necessary, add recommended oil to specified level.</li><li>• Check vehicle for oil leakage.</li></ul>	6-10
<b>Final gear oil</b>	<ul style="list-style-type: none"><li>• Check vehicle for oil leakage.</li></ul>	6-12
<b>Front brake</b>	<ul style="list-style-type: none"><li>• Check operation.</li><li>• If soft or spongy, have Yamaha dealer bleed hydraulic system.</li><li>• Check lever free play.</li><li>• Adjust if necessary.</li><li>• Check brake pads for wear.</li><li>• Replace if necessary.</li><li>• Check fluid level in reservoir.</li><li>• If necessary, add recommended brake fluid to specified level.</li><li>• Check hydraulic system for leakage.</li></ul>	6-22, 6-24, 6-24
<b>Rear brake</b>	<ul style="list-style-type: none"><li>• Check operation.</li><li>• If soft or spongy, have Yamaha dealer bleed hydraulic system.</li><li>• Check brake pads for wear.</li><li>• Replace if necessary.</li><li>• Check fluid level in reservoir.</li><li>• If necessary, add recommended brake fluid to specified level.</li><li>• Check hydraulic system for leakage.</li></ul>	6-24, 6-24
<b>Clutch</b>	<ul style="list-style-type: none"><li>• Check operation.</li><li>• Lubricate cable if necessary.</li><li>• Check lever free play.</li><li>• Adjust if necessary.</li></ul>	6-22

# PRE-OPERATION CHECKS

ITEM	CHECKS	PAGE
<b>Throttle grip</b>	<ul style="list-style-type: none"> <li>• Make sure that operation is smooth.</li> <li>• Check cable free play.</li> <li>• If necessary, have Yamaha dealer adjust cable free play and lubricate cable and grip housing.</li> </ul>	6-15, 6-26
<b>Control cables</b>	<ul style="list-style-type: none"> <li>• Make sure that operation is smooth.</li> <li>• Lubricate if necessary.</li> </ul>	6-26
<b>Wheels and tires</b>	<ul style="list-style-type: none"> <li>• Check for damage.</li> <li>• Check tire condition and tread depth.</li> <li>• Check air pressure.</li> <li>• Correct if necessary.</li> </ul>	6-15, 6-20
<b>Brake and shift pedals</b>	<ul style="list-style-type: none"> <li>• Make sure that operation is smooth.</li> <li>• Lubricate pedal pivoting points if necessary.</li> </ul>	6-26
<b>Brake and clutch levers</b>	<ul style="list-style-type: none"> <li>• Make sure that operation is smooth.</li> <li>• Lubricate lever pivoting points if necessary.</li> </ul>	6-27
<b>Sidestand</b>	<ul style="list-style-type: none"> <li>• Make sure that operation is smooth.</li> <li>• Lubricate pivot if necessary.</li> </ul>	6-27
<b>Chassis fasteners</b>	<ul style="list-style-type: none"> <li>• Make sure that all nuts, bolts and screws are properly tightened.</li> <li>• Tighten if necessary.</li> </ul>	—
<b>Instruments, lights, signals and switches</b>	<ul style="list-style-type: none"> <li>• Check operation.</li> <li>• Correct if necessary.</li> </ul>	—
<b>Sidestand switch</b>	<ul style="list-style-type: none"> <li>• Check operation of ignition circuit cut-off system.</li> <li>• If system is defective, have Yamaha dealer check vehicle.</li> </ul>	3-16

# OPERATION AND IMPORTANT RIDING POINTS

EAU15950

EWA10270

## **WARNING**

- **Become thoroughly familiar with all operating controls and their functions before riding. Consult a Yamaha dealer regarding any control or function that you do not thoroughly understand.**
- **Never start the engine or operate it in a closed area for any length of time. Exhaust fumes are poisonous, and inhaling them can cause loss of consciousness and death within a short time. Always make sure that there is adequate ventilation.**
- **Before starting out, make sure that the sidestand is up. If the sidestand is not raised completely, it could contact the ground and distract the operator, resulting in a possible loss of control.**

EAU16420

## **Starting and warming up a cold engine**

In order for the ignition circuit cut-off system to enable starting, one of the following conditions must be met:

- The transmission is in the neutral position.
- The transmission is in gear with the clutch lever pulled and the sidestand up.

EWA10290

## **WARNING**

- **Before starting the engine, check the function of the ignition circuit cut-off system according to the procedure described on page 3-17.**
- **Never ride with the sidestand down.**

1. Turn the fuel cock lever to “ON”.
2. Turn the key to “ON” and make sure that the engine stop switch is set to “○”.
3. Shift the transmission into the neutral position.

## **NOTE:** \_\_\_\_\_

When the transmission is in the neutral position, the neutral indicator light should be on, otherwise have a Yamaha dealer check the electrical circuit.

4. Turn the starter (choke) on and completely close the throttle. (See page 3-9.)
5. Start the engine by pushing the start switch.

## **NOTE:** \_\_\_\_\_

If the engine fails to start, release the start switch, wait a few seconds, and then try again. Each starting attempt should be as short as possible to preserve the battery. Do not crank the engine more than 10 seconds on any one attempt.

ECA11390

## **CAUTION:** \_\_\_\_\_

- **The oil level warning light should come on when the key is turned to “ON”, and then go off after two to three seconds. If the oil level warning light flickers or remains on after starting, imme-**

# OPERATION AND IMPORTANT RIDING POINTS

---

diately stop the engine, and then check the engine oil level and the vehicle for oil leakage. If necessary, add engine oil, and then check the warning light again. If the warning light does not come on when turning the key to “ON”, or if it does not go off after starting the engine with sufficient engine oil, have a Yamaha dealer check the electrical circuit.

5

- The engine trouble warning light should also come on when the key is turned to “ON”. If the warning light does not come on when the key is turned to “ON”, flashes or remains on after starting the engine, have a Yamaha dealer check the electrical circuit.

6. After starting the engine, move the starter (choke) back halfway.

ECA11130

## CAUTION:

**For maximum engine life, always warm the engine up before starting off. Never accelerate hard when the engine is cold!**

7. When the engine is warm, turn the starter (choke) off.

## NOTE:

The engine is warm when it responds normally to the throttle with the starter (choke) turned off. To avoid the possibility of excessive exhaust emissions, never leave the starter (choke) on longer than necessary. The time necessary for starter (choke) use depends upon the ambient temperature. Temperatures above 10 °C (50 °F) require about 7 seconds of starter (choke) use and temperatures below 10 °C (50 °F) require about 35 seconds with the starter (choke) turned on, then about 2.5 minutes with the starter (choke) in the half-way position.

EAU16640

## Starting a warm engine

Follow the same procedure as for starting a cold engine with the exception that the starter (choke) is not required when the engine is warm.

# OPERATION AND IMPORTANT RIDING POINTS

## Shifting

EAU16671

### XVS11V

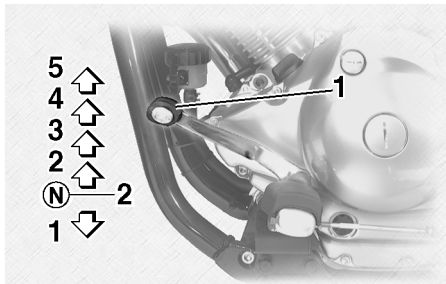

1. Shift pedal
2. Neutral position

### XVS11AWV/XVS11ATV

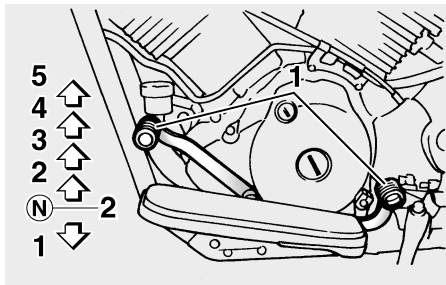

1. Shift pedal
2. Neutral position

Shifting gears lets you control the amount of engine power available for starting off, accelerating, climbing hills, etc.

The gear positions are shown in the illustration.

#### NOTE: \_\_\_\_\_

To shift the transmission into the neutral position, press the shift pedal down repeatedly until it reaches the end of its travel, and then slightly raise it.

ECA10260

#### CAUTION: \_\_\_\_\_

- **Even with the transmission in the neutral position, do not coast for long periods of time with the engine off, and do not tow the motorcycle for long distances. The transmission is properly lubricated only when the engine is running. Inadequate lubrication may damage the transmission.**
- **Always use the clutch while changing gears to avoid damaging the engine, transmission,**

**and drive train, which are not designed to withstand the shock of forced shifting.**

EAU16680

#### To start out and accelerate

1. Pull the clutch lever to disengage the clutch.
2. Shift the transmission into first gear. The neutral indicator light should go out.
3. Open the throttle gradually, and at the same time, release the clutch lever slowly.
4. At the recommended shift points shown in the following table, close the throttle, and at the same time, quickly pull the clutch lever in.
5. Shift the transmission into second gear. (Make sure not to shift the transmission into the neutral position.)
6. Open the throttle part way and gradually release the clutch lever.
7. Follow the same procedure when shifting to the next higher gear.

# OPERATION AND IMPORTANT RIDING POINTS

## NOTE: \_\_\_\_\_

Always shift gears at the recommended shift points.

\_\_\_\_\_

EAU16700

## To decelerate

1. Apply both the front and the rear brakes to slow the motorcycle.
2. Shift the transmission into first gear when the motorcycle reaches 25 km/h (15.5 mi/h). If the engine is about to stall or runs very roughly, pull the clutch lever in and use the brakes to stop the motorcycle.
3. Shift the transmission into the neutral position when the motorcycle is almost completely stopped. The neutral indicator light should come on.

EAU16720

## Recommended shift points

The recommended shift points during acceleration and deceleration are shown in the table below.

### Shift up points:

- 1st → 2nd: 20 km/h (12.4 mi/h)
- 2nd → 3rd: 30 km/h (18.6 mi/h)
- 3rd → 4th: 40 km/h (24.9 mi/h)
- 4th → 5th: 50 km/h (31.1 mi/h)

### Shift down points:

- 5th → 4th: 25 km/h (15.5 mi/h)
- 4th → 3rd: 25 km/h (15.5 mi/h)
- 3rd → 2nd: 25 km/h (15.5 mi/h)
- 2nd → 1st: 25 km/h (15.5 mi/h)

EAU16841

## Engine break-in

There is never a more important period in the life of your engine than the period between 0 and 1600 km (1000 mi). For this reason, you should read the following material carefully.

Since the engine is brand new, do not put an excessive load on it for the first 1600 km (1000 mi). The various parts in the engine wear and polish themselves to the correct operating clearances. During this period, prolonged full-throttle operation or any condition that might result in engine overheating must be avoided.

EAU17041

### 0–1000 km (0–600 mi)

Avoid prolonged operation above 1/3 throttle.

### 1000–1600 km (600–1000 mi)

Avoid prolonged operation above 1/2 throttle.



# OPERATION AND IMPORTANT RIDING POINTS

ECA10331

## CAUTION:

After 1000 km (600 mi) of operation, the engine oil and final gear oil must be changed, and the oil filter cartridge or element replaced.

## 1600 km (1000 mi) and beyond

The vehicle can now be operated normally.

ECA10270

## CAUTION:

If any engine trouble should occur during the engine break-in period, immediately have a Yamaha dealer check the vehicle.

EAU17180

## Parking

When parking, stop the engine, remove the key from the main switch, and then turn the fuel cock lever to “OFF”.

EWA10310

## WARNING

- Since the engine and exhaust system can become very hot, park in a place where pedestrians or children are not likely to touch them.
- Do not park on a slope or on soft ground, otherwise the vehicle may overturn.

ECA10380

## CAUTION:

Never park in an area where there are fire hazards such as grass or other flammable materials.

# PERIODIC MAINTENANCE AND MINOR REPAIR

EAU17231

EAU17301

EAU17440

Safety is an obligation of the owner. Periodic inspection, adjustment and lubrication will keep your vehicle in the safest and most efficient condition possible. The most important points of motorcycle inspection, adjustment, and lubrication are explained on the following pages.

**Maintenance, replacement, or repair of the emission control devices and systems may be performed by any repair establishment or individual that is certified (if applicable).**

EWA10320

## **WARNING**

**If you are not familiar with maintenance work, have a Yamaha dealer do it for you.**

## PERIODIC MAINTENANCE

PROPER PERIODIC MAINTENANCE OF YOUR VEHICLE IS IMPORTANT IN ORDER TO ENJOY LONG, PLEASURABLE SERVICE. ESPECIALLY IMPORTANT ARE THE MAINTENANCE SERVICES RELATED TO EMISSIONS CONTROL. THESE CONTROLS NOT ONLY FUNCTION TO ENSURE CLEANER AIR, BUT ARE ALSO VITAL TO PROPER ENGINE OPERATION AND MAXIMUM PERFORMANCE. IN THE FOLLOWING PERIODIC MAINTENANCE CHARTS, THE SERVICES RELATED TO EMISSIONS CONTROL ARE GROUPED SEPARATELY. THESE SERVICES REQUIRE SPECIALIZED DATA, KNOWLEDGE, AND EQUIPMENT. YAMAHA DEALERS ARE TRAINED AND EQUIPPED TO PERFORM THESE PARTICULAR SERVICES.

## Owner's tool kit



1. Owner's tool kit

The owner's tool kit is located inside the storage compartment. (See page 3-13.)

The service information included in this manual and the tools provided in the owner's tool kit are intended to assist you in the performance of preventive maintenance and minor repairs. However, additional tools such as a torque wrench may be necessary to perform certain maintenance work correctly.

### **NOTE:** \_\_\_\_\_

If you do not have the tools or experience required for a particular job, have a Yamaha dealer perform it for you.

# PERIODIC MAINTENANCE AND MINOR REPAIR

---

---

EWA10340

## **WARNING**

**Modifications not approved by Yamaha may cause loss of performance, excessive emissions, and render the vehicle unsafe for use. Consult a Yamaha dealer before attempting any changes.**

---

# PERIODIC MAINTENANCE AND MINOR REPAIR

EAU17600

## Periodic maintenance chart for the emission control system

No.	ITEM	ROUTINE	INITIAL	ODOMETER READINGS					
			600 mi (1000 km) or 1 month	4000 mi (7000 km) or 6 months	8000 mi (13000 km) or 12 months	12000 mi (19000 km) or 18 months	16000 mi (25000 km) or 24 months	20000 mi (31000 km) or 30 months	
1	* Fuel line	<ul style="list-style-type: none"> <li>Check fuel hoses for cracks or damage.</li> <li>Replace if necessary.</li> </ul>		√	√	√	√	√	√
2	* Fuel filter	<ul style="list-style-type: none"> <li>Replace.</li> </ul>							Replace.
3	Spark plugs	<ul style="list-style-type: none"> <li>Check condition.</li> <li>Adjust gap and clean.</li> <li>Replace every 8000 mi (13000 km) or 12 months.</li> </ul>		√	Replace.	√	Replace.	√	√
4	* Valve clearance	<ul style="list-style-type: none"> <li>Check and adjust valve clearance when engine is cold.</li> </ul>	√	√	√	√	√	√	√
5	* Crankcase breather system	<ul style="list-style-type: none"> <li>Check breather hose for cracks or damage.</li> <li>Replace if necessary.</li> </ul>		√	√	√	√	√	√
6	* Carburetor synchronization	<ul style="list-style-type: none"> <li>Adjust synchronization of carburetors.</li> </ul>	√	√	√	√	√	√	√
7	* Idle speed	<ul style="list-style-type: none"> <li>Check and adjust engine idle speed.</li> </ul>		√	√	√	√	√	√
8	* Exhaust system	<ul style="list-style-type: none"> <li>Check for leakage.</li> <li>Tighten if necessary.</li> <li>Replace gasket(s) if necessary.</li> </ul>		√	√	√	√	√	√
9	* Evaporative emission control system (For California only)	<ul style="list-style-type: none"> <li>Check control system for damage.</li> <li>Replace if necessary.</li> </ul>				√			

\* Since these items require special tools, data and technical skills, have a Yamaha dealer perform the service.

# PERIODIC MAINTENANCE AND MINOR REPAIR

EAU32183

## General maintenance and lubrication chart

No.	ITEM	ROUTINE	INITIAL	ODOMETER READINGS				
			600 mi (1000 km) or 1 month	4000 mi (7000 km) or 6 months	8000 mi (13000 km) or 12 months	12000 mi (19000 km) or 18 months	16000 mi (25000 km) or 24 months	20000 mi (31000 km) or 30 months
1	* Air filter element	<ul style="list-style-type: none"> <li>• Clean with compressed air.</li> <li>• Replace if necessary.</li> </ul>		√	√	√	√	√
2	* Clutch	<ul style="list-style-type: none"> <li>• Check operation.</li> <li>• Adjust or replace cable.</li> </ul>	√	√	√	√	√	√
3	* Front brake	<ul style="list-style-type: none"> <li>• Check operation, fluid level, and for fluid leakage.</li> <li>• Replace brake pads if necessary.</li> </ul>	√	√	√	√	√	√
4	* Rear brake	<ul style="list-style-type: none"> <li>• Check operation, fluid level, and for fluid leakage.</li> <li>• Replace brake pads if necessary.</li> </ul>	√	√	√	√	√	√
5	* Brake hoses	<ul style="list-style-type: none"> <li>• Check for cracks or damage.</li> </ul>		√	√	√	√	√
		<ul style="list-style-type: none"> <li>• Replace.</li> </ul>	Every 4 years					
6	* Wheels (XVS11V)	<ul style="list-style-type: none"> <li>• Check runout, spoke tightness and for damage.</li> <li>• Tighten spokes if necessary.</li> </ul>		√	√	√	√	√
7	* Wheels (XVS11AWV /XVS11ATV)	<ul style="list-style-type: none"> <li>• Check runout and for damage.</li> <li>• Replace if necessary.</li> </ul>		√	√	√	√	√
8	* Tires	<ul style="list-style-type: none"> <li>• Check tread depth and for damage.</li> <li>• Replace if necessary.</li> <li>• Check air pressure.</li> <li>• Correct if necessary.</li> </ul>		√	√	√	√	√

# PERIODIC MAINTENANCE AND MINOR REPAIR

No.	ITEM	ROUTINE	INITIAL	ODOMETER READINGS				
			600 mi (1000 km) or 1 month	4000 mi (7000 km) or 6 months	8000 mi (13000 km) or 12 months	12000 mi (19000 km) or 18 months	16000 mi (25000 km) or 24 months	20000 mi (31000 km) or 30 months
9	* Wheel bearings	<ul style="list-style-type: none"> <li>• Check bearings for smooth operation.</li> <li>• Replace if necessary.</li> </ul>		√	√	√	√	√
10	* Swingarm pivot bearings	<ul style="list-style-type: none"> <li>• Check bearing assemblies for looseness.</li> <li>• Moderately repack with lithium-soap-based grease.</li> </ul>			√		Repack.	
11	* Steering bearings	<ul style="list-style-type: none"> <li>• Check bearing assemblies for looseness.</li> <li>• Moderately repack with lithium-soap-based grease every 16000 mi (25000 km) or 24 months.</li> </ul>	√	√	√	√	Repack.	√
12	* Chassis fasteners	<ul style="list-style-type: none"> <li>• Check all chassis fitting and fasteners.</li> <li>• Correct if necessary.</li> </ul>		√	√	√	√	√
13	Brake and clutch lever pivot shafts	<ul style="list-style-type: none"> <li>• Apply lithium-soap-based grease (all-purpose grease) lightly.</li> </ul>		√	√	√	√	√
14	Brake and shift pedal pivot shafts	<ul style="list-style-type: none"> <li>• Apply lithium-soap-based grease (all-purpose grease) lightly.</li> </ul>		√	√	√	√	√
15	Sidestand pivot	<ul style="list-style-type: none"> <li>• Check operation.</li> <li>• Apply lithium-soap-based grease (all-purpose grease) lightly.</li> </ul>		√	√	√	√	√
16	* Sidestand switch	<ul style="list-style-type: none"> <li>• Check operation and replace if necessary.</li> </ul>	√	√	√	√	√	√
17	* Front fork	<ul style="list-style-type: none"> <li>• Check operation and for oil leakage.</li> <li>• Replace if necessary.</li> </ul>		√	√	√	√	√

# PERIODIC MAINTENANCE AND MINOR REPAIR

No.	ITEM	ROUTINE	INITIAL	ODOMETER READINGS					
			600 mi (1000 km) or 1 month	4000 mi (7000 km) or 6 months	8000 mi (13000 km) or 12 months	12000 mi (19000 km) or 18 months	16000 mi (25000 km) or 24 months	20000 mi (31000 km) or 30 months	
18	* Shock absorber assembly	<ul style="list-style-type: none"> <li>• Check operation and for oil leakage.</li> <li>• Replace if necessary.</li> </ul>		√	√	√	√	√	√
19	* Rear suspension link pivots	<ul style="list-style-type: none"> <li>• Apply lithium-soap-based grease lightly.</li> </ul>					√		
20	Engine oil	<ul style="list-style-type: none"> <li>• Change (warm engine before draining).</li> </ul>	√	√	√	√	√	√	√
21	* Engine oil filter element	<ul style="list-style-type: none"> <li>• Replace.</li> </ul>	√		√			√	
22	Final gear oil	<ul style="list-style-type: none"> <li>• Check oil level and for oil leakage.</li> <li>• Change at initial 600 mi (1000 km) or 1 month, and thereafter every 16000 mi (25000 km) or 24 months.</li> </ul>	Change.	√	√	√		Change.	√
23	* Control cables	<ul style="list-style-type: none"> <li>• Apply Yamaha chain and cable lube or engine oil SAE 10W-30 thoroughly.</li> </ul>	√	√	√	√	√	√	√
24	* Throttle grip housing and cable	<ul style="list-style-type: none"> <li>• Check operation and free play.</li> <li>• Adjust the throttle cable free play if necessary.</li> <li>• Lubricate the throttle grip housing and cable.</li> </ul>		√	√	√	√	√	√

\* Since these items require special tools, data and technical skills, have a Yamaha dealer perform the service.

**NOTE:**

From 24000 mi (37000 km) or 36 months, repeat the maintenance intervals starting from 8000 mi (13000 km) or 12 months.

# PERIODIC MAINTENANCE AND MINOR REPAIR

---

---

EAU17630

## NOTE:

---

- The air filter needs more frequent service if you are riding in unusually wet or dusty areas.
  - Hydraulic brake service
    - After disassembling the brake master cylinders and calipers, always change the fluid. Regularly check the brake fluid levels and fill the reservoirs as required.
    - Every two years replace the internal components of the brake master cylinders and calipers, and change the brake fluid.
    - Replace the brake hoses every four years and if cracked or damaged.
-



# PERIODIC MAINTENANCE AND MINOR REPAIR

## Removing and installing the panel

EAU18751

The panel shown needs to be removed to perform some of the maintenance jobs described in this chapter. Refer to this section each time the panel needs to be removed and installed.

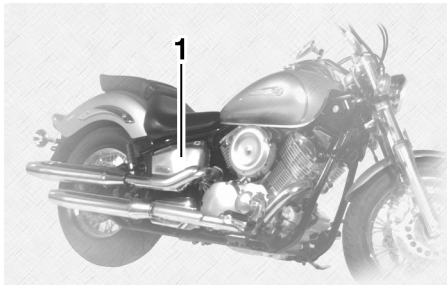

1. Panel A

## Panel A

EAU19151

### To remove the panel

Remove the bolt, and then pull the panel off as shown.



1. Bolt

### To install the panel

Place the panel in the original position, and then install the bolt.

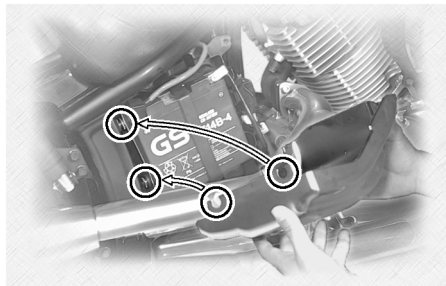

## Checking the spark plugs

EAU19551

The spark plugs are important engine components, which are easy to check. Since heat and deposits will cause any spark plug to slowly erode, the spark plugs should be removed and checked in accordance with the periodic maintenance and lubrication chart. In addition, the condition of the spark plugs can reveal the condition of the engine.

### To remove a spark plug

1. Remove the appropriate spark plug cover (rear right or front left) by pulling it off as shown.

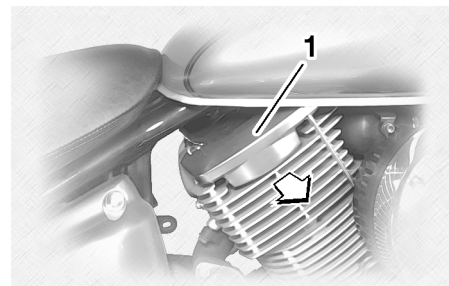

1. Spark plug cover

2. Remove the spark plug cap.

# PERIODIC MAINTENANCE AND MINOR REPAIR

3. Remove the spark plug as shown, with the spark plug wrench included in the owner's tool kit.

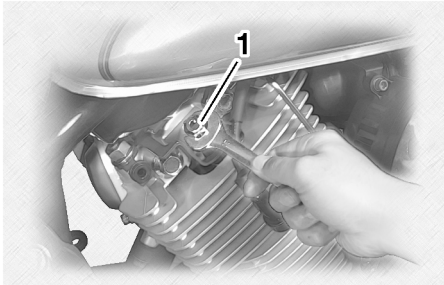

1. Spark plug wrench

6

## To check the spark plugs

1. Check that the porcelain insulator around the center electrode on each spark plug is a medium-to-light tan (the ideal color when the vehicle is ridden normally).
2. Check that all spark plugs installed in the engine have the same color.

## NOTE:

If any spark plug shows a distinctly different color, the engine could be defective. Do not attempt to diagnose such problems yourself. Instead, have a Yamaha dealer check the vehicle.

3. Check each spark plug for electrode erosion and excessive carbon or other deposits, and replace it if necessary.

**Specified spark plug:**  
NGK/BPR7ES  
DENSO/W22EPR-U

## To install a spark plug

1. Measure the spark plug gap with a wire thickness gauge and, if necessary, adjust the gap to specification.

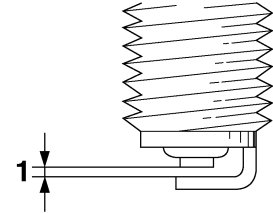

1. Spark plug gap

## Spark plug gap:

0.7–0.8 mm (0.028–0.031 in)

2. Clean the surface of the spark plug gasket and its mating surface, and then wipe off any grime from the spark plug threads.
3. Install the spark plug with the spark plug wrench, and then tighten it to the specified torque.

## Tightening torque:

Spark plug:  
20 Nm (2.0 m·kgf, 14.5 ft·lbf)

# PERIODIC MAINTENANCE AND MINOR REPAIR

EAU19672

EAU19822

## NOTE: \_\_\_\_\_

If a torque wrench is not available when installing a spark plug, a good estimate of the correct torque is 1/4–1/2 turn past finger tight. However, the spark plug should be tightened to the specified torque as soon as possible.

4. Install the spark plug cap.
5. Place the spark plug cover in the original position.

## Canister (for California only)

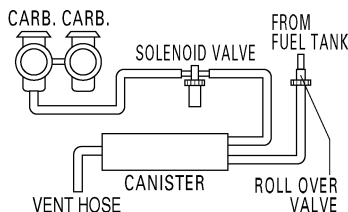

This model is equipped with a canister to prevent the discharging of fuel vapor into the atmosphere.

- Check each hose connection.
- Check each hose and canister for cracks or damage. Replace if damaged.
- Make sure the vent hose is not blocked. Clean it if necessary.

## Engine oil

The engine oil level should be checked before each ride. In addition, the oil must be changed and the oil filter element replaced at the intervals specified in the periodic maintenance and lubrication chart.

### To check the engine oil level

1. Place the vehicle on a level surface and hold it in an upright position.

## NOTE: \_\_\_\_\_

Make sure that the vehicle is positioned straight up when checking the oil level. A slight tilt to the side can result in a false reading.

2. Start the engine, warm it up for several minutes, and then turn it off.
3. Wait a few minutes until the oil settles, and then check the oil level through the check window located at the bottom-left side of the crankcase.

# PERIODIC MAINTENANCE AND MINOR REPAIR

## NOTE:

The engine oil should be between the minimum and maximum level marks.

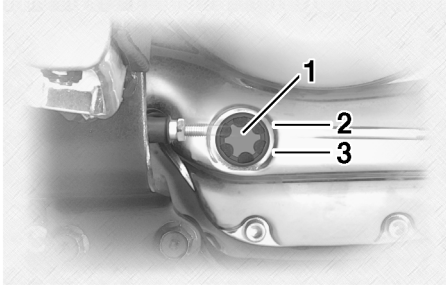

1. Engine oil level check window
2. Maximum level mark
3. Minimum level mark

4. If the engine oil is at or below the minimum level mark, add sufficient oil of the recommended type to raise it to the correct level.

## To change the engine oil

1. Start the engine, warm it up for several minutes, and then turn it off.
2. Place an oil pan under the engine to collect the used oil.

3. Remove the engine oil filler cap and drain bolt to drain the oil from the crankcase.

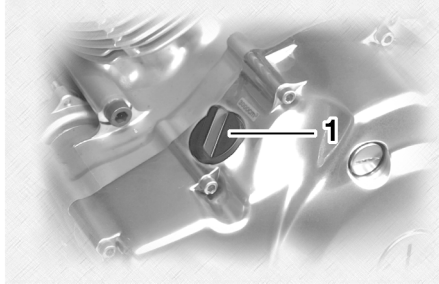

1. Engine oil filler cap

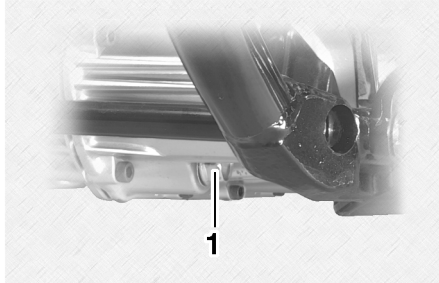

1. Engine oil drain bolt

4. Install the engine oil drain bolt, and then tighten it to the specified torque.

## NOTE:

Check the washer for damage and replace it if necessary.

### Tightening torque:

Engine oil drain bolt:  
43 Nm (4.3 m·kgf, 31 ft·lbf)

5. Add the specified amount of the recommended engine oil, and then install and tighten the oil filler cap.

### Recommended engine oil:

See page 8-1.

### Oil change quantity:

3.00 L (3.17 US qt) (2.64 Imp.qt)

ECA11620

## CAUTION:

- In order to prevent clutch slippage (since the engine oil also lubricates the clutch), do not mix any chemical additives. Do not use oils with a diesel specification of “CD” or oils of a higher quality than specified. In addition, do not use oils labeled “ENERGY CONSERVING II” or higher.

# PERIODIC MAINTENANCE AND MINOR REPAIR

- **Make sure that no foreign material enters the crankcase.**

6. Start the engine, and then let it idle for several minutes while checking it for oil leakage. If oil is leaking, immediately turn the engine off and check for the cause.

**NOTE:** \_\_\_\_\_

After the engine is started, the engine oil level warning light should go off if the oil level is sufficient.

ECA10400

**CAUTION:** \_\_\_\_\_

**If the oil level warning light flickers or remains on, immediately turn the engine off and have a Yamaha dealer check the vehicle.**

7. Turn the engine off, and then check the oil level and correct it if necessary.

**NOTE:** \_\_\_\_\_

Have a Yamaha dealer replace the oil filter element at the intervals specified in the periodic maintenance and lubrication chart.

## Final gear oil

The final gear case must be checked for oil leakage before each ride. If any leakage is found, have a Yamaha dealer check and repair the vehicle. In addition, the final gear oil level must be checked and the oil changed as follows at the intervals specified in the periodic maintenance and lubrication chart.

EAU20022

EWA10370

### **⚠ WARNING**

- **Make sure that no foreign material enters the final gear case.**
- **Make sure that no oil gets on the tire or wheel.**

### To check the final gear oil level

1. Place the vehicle on a level surface and hold it in an upright position.

**NOTE:** \_\_\_\_\_

- The final gear oil level must be checked on a cold engine.
- Make sure that the vehicle is positioned straight up when checking the oil level. A slight tilt to the side can result in a false reading.

2. Remove the oil filler bolt, and then check the oil level in the final gear case.

**NOTE:** \_\_\_\_\_

The oil level should be at the brim of the filler hole.

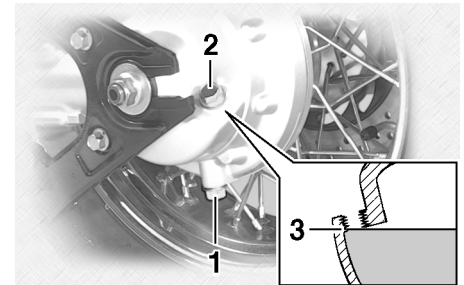

1. Final gear oil drain bolt
2. Final gear oil filler bolt
3. Correct oil level

3. If the oil is below the brim of the filler hole, add sufficient oil of the recommended type to raise it to the correct level.

### To change the final gear oil

1. Place an oil pan under the final gear case to collect the used oil.

# PERIODIC MAINTENANCE AND MINOR REPAIR

2. Remove the oil filler bolt and drain bolt to drain the oil from the final gear case.
3. Install the final gear oil drain bolt, and then tighten it to the specified torque.

## Tightening torque:

Final gear oil drain bolt:  
23 Nm (2.3 m·kgf, 17 ft·lbf)

4. Add the recommended final gear oil to the brim of the filler hole.

## Recommended final gear oil:

SAE80 API GL-4 Hypoid gear oil

## Oil quantity:

0.19 L (0.20 US qt) (0.17 Imp.qt)

## NOTE:

GL4 is a quality rating. Hypoid gear oils rated GL5 or GL6 may also be used.

5. Install the oil filler bolt, and then tighten it to the specified torque.

## Tightening torque:

Final gear oil filler bolt:  
23 Nm (2.3 m·kgf, 17 ft·lbf)

6. Check the final gear case for oil leakage. If oil is leaking, check for the cause.

## Cleaning the air filter element

EAU20670

The air filter element should be cleaned as follows at the intervals specified in the periodic maintenance and lubrication chart. Clean the air filter element more frequently if you are riding in unusually wet or dusty areas.

1. Remove the air filter case cover by removing the screws.

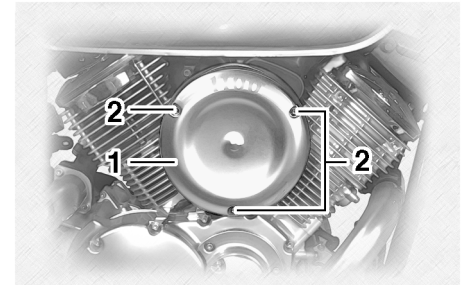

1. Air filter case cover

2. Screw

2. Pull the air filter element out.
3. Lightly tap the air filter element to remove most of the dust and dirt, and then blow the remaining dirt out with compressed air as shown. If the air filter element is damaged, replace it.



4. Insert the air filter element into the air filter case as shown.

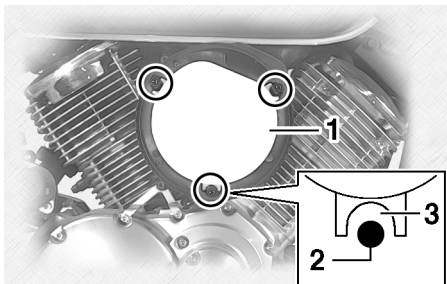

1. Air filter element
2. Projection
3. Slot

## CAUTION:

- Make sure that the air filter element is properly seated in the air filter case.
- The engine should never be operated without the air filter element installed, otherwise the piston(s) and/or cylinder(s) may become excessively worn.

5. Install the air filter case cover by installing the screws.

## Carburetors

The carburetors are important parts of the engine and emission control system, which require very sophisticated adjustment. Therefore, all carburetor adjustments should be left to a Yamaha dealer, who has the necessary professional knowledge and experience.

# PERIODIC MAINTENANCE AND MINOR REPAIR

## Checking the throttle cable free play

EAU21381

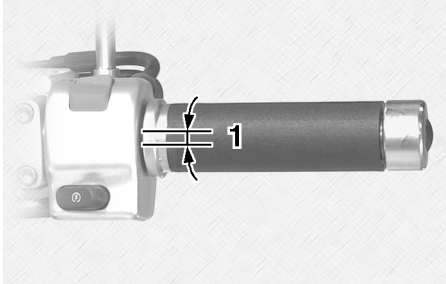

1. Throttle cable free play

The throttle cable free play should measure 4.0–6.0 mm (0.16–0.24 in) at the throttle grip. Periodically check the throttle cable free play and, if necessary, have a Yamaha dealer adjust it.

6

## Valve clearance

EAU21401

The valve clearance changes with use, resulting in improper air-fuel mixture and/or engine noise. To prevent this from occurring, the valve clearance must be adjusted by a Yamaha dealer at the intervals specified in the periodic maintenance and lubrication chart.

## Tires (XVS11V)

EAU32520

To maximize the performance, durability, and safe operation of your motorcycle, note the following points regarding the specified tires.

### Tire air pressure

The tire air pressure should be checked and, if necessary, adjusted before each ride.

EWA10500

### **⚠ WARNING**

- The tire air pressure must be checked and adjusted on cold tires (i.e., when the temperature of the tires equals the ambient temperature).
- The tire air pressure must be adjusted in accordance with the riding speed and with the total weight of rider, passenger, cargo, and accessories approved for this model.



# PERIODIC MAINTENANCE AND MINOR REPAIR

## Tire air pressure (measured on cold tires):

### 0–90 kg (0–198 lb):

Front:

XVS11V 200 kPa (29 psi) (2.00 kgf/cm<sup>2</sup>)

XVS11VC 200 kPa (29 psi)  
(2.00 kgf/cm<sup>2</sup>)

Rear:

XVS11V 225 kPa (33 psi) (2.25 kgf/cm<sup>2</sup>)

XVS11VC 225 kPa (33 psi)  
(2.25 kgf/cm<sup>2</sup>)

### XVS11V 90–200 kg (198–441 lb)

### XVS11VC 90–197 kg (198–434 lb):

Front:

225 kPa (33 psi) (2.25 kgf/cm<sup>2</sup>)

Rear:

250 kPa (36 psi) (2.50 kgf/cm<sup>2</sup>)

### Maximum load\*:

XVS11V 200 kg (441 lb)

XVS11VC 197 kg (434 lb)

\* Total weight of rider, passenger, cargo and accessories

EWA10510

## WARNING

Proper loading of your vehicle is important for several characteristics of your vehicle, such as handling, braking, performance and safety. Do not carry loosely packed items that

can shift. Securely pack your heaviest items close to the center of the vehicle, and distribute the weight evenly from side to side. Properly adjust the suspension for your load, and check the condition and pressure of your tires. **NEVER OVERLOAD YOUR VEHICLE.** Make sure that the total weight of the cargo, rider, passenger, and accessories (cowling, saddlebags, etc. if approved for this model) does not exceed the maximum load of the vehicle. Operation of an overloaded vehicle could cause tire damage, an accident, or even injury.

## Tire inspection

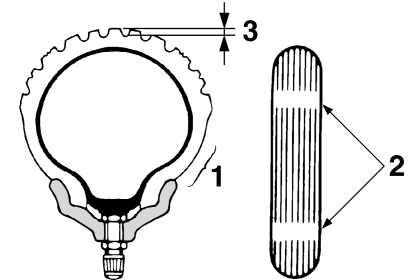

1. Tire sidewall
2. Tire wear indicator
3. Tire tread depth

Always check the tires before operating the motorcycle. If a tire tread shows crosswise lines (minimum tread depth), if the tire has a nail or glass fragments in it, or if the sidewall is cracked, contact a Yamaha dealer immediately and have the tire replaced.

### Minimum tire tread depth (front and rear):

1.0 mm (0.04 in)

# PERIODIC MAINTENANCE AND MINOR REPAIR

EWA10560

## WARNING

- It is dangerous to ride with a worn-out tire. When a tire tread begins to show crosswise lines, have a Yamaha dealer replace the tire immediately.
- The replacement of all wheel- and brake-related parts, including the tires, should be left to a Yamaha dealer, who has the necessary professional knowledge and experience.
- It is not recommended to patch a punctured tube. If unavoidable, however, patch the tube very carefully and replace it as soon as possible with a high-quality product.

EWA10460

## WARNING

- The front and rear tires should be of the same make and design, otherwise the handling characteristics of the vehicle cannot be guaranteed.
- After extensive tests, only the tires listed below have been approved for this model by Yamaha Motor Co., Ltd.

### Front tire:

Size:

XVS11V 110/90-18M/C 61S  
XVS11VC 110/90-18M/C 61S

Manufacturer/model:

XVS11V DUNLOP/K555F  
XVS11VC DUNLOP/K555F  
XVS11V BRIDGESTONE/EXE-DRA L309  
XVS11VC BRIDGESTONE/EXE-DRA L309

### Rear tire:

Size:

170/80-15M/C 77S

Manufacturer/model:

XVS11V DUNLOP/K555  
XVS11VC DUNLOP/K555  
XVS11V BRIDGESTONE/EXE-DRA G546G  
XVS11VC BRIDGESTONE/EXE-DRA G546G

6

### Tire information

This motorcycle is equipped with spoke wheels and tube tires.

# PERIODIC MAINTENANCE AND MINOR REPAIR

## Tires (XVS11AWV/XVS11ATV)

EAU32541

To maximize the performance, durability, and safe operation of your motorcycle, note the following points regarding the specified tires.

### Tire air pressure

The tire air pressure should be checked and, if necessary, adjusted before each ride.

EWA10500

#### **WARNING**

- The tire air pressure must be checked and adjusted on cold tires (i.e., when the temperature of the tires equals the ambient temperature).
- The tire air pressure must be adjusted in accordance with the riding speed and with the total weight of rider, passenger, cargo, and accessories approved for this model.

### Tire air pressure (measured on cold tires):

#### 0–90 kg (0–198 lb):

Front:

XVS11ATV 225 kPa (33 psi)  
(2.25 kgf/cm<sup>2</sup>)

XVS11ATVC 225 kPa (33 psi)  
(2.25 kgf/cm<sup>2</sup>)

XVS11AWV 225 kPa (33 psi)  
(2.25 kgf/cm<sup>2</sup>)

XVS11AWVC 225 kPa (33 psi)  
(2.25 kgf/cm<sup>2</sup>)

Rear:

XVS11ATV 250 kPa (36 psi)  
(2.50 kgf/cm<sup>2</sup>)

XVS11ATVC 250 kPa (36 psi)  
(2.50 kgf/cm<sup>2</sup>)

XVS11AWV 250 kPa (36 psi)  
(2.50 kgf/cm<sup>2</sup>)

XVS11AWVC 250 kPa (36 psi)  
(2.50 kgf/cm<sup>2</sup>)

**XVS11ATV 90–203 kg (198–448 lb)**  
**XVS11ATVC 90–200 kg (198–441 lb)**

**XVS11AWV 90–203 kg (198–448 lb)**  
**XVS11AWVC 90–200 kg (198–441 lb):**

Front:

225 kPa (33 psi) (2.25 kgf/cm<sup>2</sup>)

Rear:

250 kPa (36 psi) (2.50 kgf/cm<sup>2</sup>)

### Maximum load\*:

XVS11ATV 203 kg (448 lb)

XVS11ATVC 200 kg (441 lb)

XVS11AWV 203 kg (448 lb)

XVS11AWVC 200 kg (441 lb)

\* Total weight of rider, passenger, cargo and accessories

EWA10510

#### **WARNING**

**Proper loading of your vehicle is important for several characteristics of your vehicle, such as handling, braking, performance and safety. Do not carry loosely packed items that can shift. Securely pack your heaviest items close to the center of the vehicle, and distribute the weight evenly from side to side. Properly adjust the suspension for your load, and check the condition and pressure of your tires. NEVER OVERLOAD YOUR VEHICLE. Make sure that the total weight of the cargo, rider, passenger, and accessories (cowling, saddlebags, etc. if approved for this model) does not exceed the maximum load of the**

# PERIODIC MAINTENANCE AND MINOR REPAIR

vehicle. Operation of an overloaded vehicle could cause tire damage, an accident, or even injury.

## Tire inspection

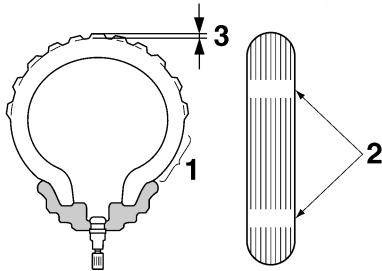

6

1. Tire sidewall
2. Tire wear indicator
3. Tire tread depth

Always check the tires before operating the motorcycle. If a tire tread shows crosswise lines (minimum tread depth), if the tire has a nail or glass fragments in it, or if the sidewall is cracked, contact a Yamaha dealer immediately and have the tire replaced.

**Minimum tire tread depth (front and rear):**

1.0 mm (0.04 in)

EWA10520

### **WARNING**

It is dangerous to ride with a worn-out tire. When a tire tread begins to show lines, have a Yamaha dealer replace the tire immediately. Brakes, tires and related wheel parts replacement should also be left to a Yamaha dealer.

## Tire information

This motorcycle is equipped with cast wheels and tubeless tires.

EWA10460

### **WARNING**

- The front and rear tires should be of the same make and design, otherwise the handling characteristics of the vehicle cannot be guaranteed.
- After extensive tests, only the tires listed below have been approved for this model by Yamaha Motor Co., Ltd.

## Front tire:

Size:

XVS11ATV 130/90-16M/C 67S  
XVS11ATVC 130/90-16M/C 67S  
XVS11AWV 130/90-16M/C 67S  
XVS11AWVC 130/90-16M/C 67S

Manufacturer/model:

XVS11ATV DUNLOP/D404F  
XVS11ATVC DUNLOP/D404F  
XVS11AWV DUNLOP/D404F  
XVS11AWVC DUNLOP/D404F  
XVS11ATV BRIDGESTONE/EXEDRA G703  
XVS11ATVC BRIDGESTONE/EXEDRA G703  
XVS11AWV BRIDGESTONE/EXEDRA G703  
XVS11AWVC BRIDGESTONE/EXEDRA G703

**Rear tire:****Size:**

170/80-15M/C 77S

**Manufacturer/model:**

XVS11ATV DUNLOP/D404G

XVS11ATVC DUNLOP/D404G

XVS11AWV DUNLOP/D404G

XVS11AWVC DUNLOP/D404G

XVS11ATV BRIDGESTONE/EXEDRA G702

XVS11ATVC BRIDGE-

STONE/EXEDRA G702

XVS11AWV BRIDGE-

STONE/EXEDRA G702

XVS11AWVC BRIDGE-

STONE/EXEDRA G702

**Spoke wheels (XVS11V)**

To maximize the performance, durability, and safe operation of your motorcycle, note the following points regarding the specified wheels.

- The wheel rims should be checked for cracks, bends or warpage, and the spokes for looseness or damage before each ride. If any damage is found, have a Yamaha dealer replace the wheel. Do not attempt even the smallest repair to the wheel. A deformed or cracked wheel must be replaced.
- The wheel should be balanced whenever either the tire or wheel has been changed or replaced. An unbalanced wheel can result in poor performance, adverse handling characteristics, and a shortened tire life.
- Ride at moderate speeds after changing a tire since the tire surface must first be “broken in” for it to develop its optimal characteristics.

**Cast wheels  
(XVS11AWV/XVS11ATV)**

To maximize the performance, durability, and safe operation of your motorcycle, note the following points regarding the specified wheels.

- The wheel rims should be checked for cracks, bends, warpage or damage before each ride. If any damage is found, have a Yamaha dealer replace the wheel. Do not attempt even the smallest repair to the wheel. A deformed or cracked wheel must be replaced.
- The wheel should be balanced whenever either the tire or wheel has been changed or replaced. An unbalanced wheel can result in poor performance, adverse handling characteristics, and a shortened tire life.
- Ride at moderate speeds after changing a tire since the tire surface must first be “broken in” for it to develop its optimal characteristics.

# PERIODIC MAINTENANCE AND MINOR REPAIR

---

- After repairing or replacing the rear tire, tighten the valve stem nut and locknut to the specified torques.

## Tightening torques:

Valve stem nut:

1.5 Nm (0.15 m·kgf, 1.08 ft·lbf)

Valve stem locknut:

3.0 Nm (0.30 m·kgf, 2.17 ft·lbf)

## Accessories and replacement parts

EAU22011

EWA10621



This vehicle is not designed to pull a trailer or to be attached to a sidecar. The accessories or replacement parts you choose for your vehicle should be designed specifically for this model, and they must be securely mounted to maintain the inherent stability of the original design. Genuine Yamaha Parts and Accessories are designed and tested to be compatible with your vehicle. Please consider Genuine Yamaha Parts and Accessories before making a purchase. Use of non-Yamaha-approved accessories or replacement parts may cause loss of handling stability and riding safety. Since Yamaha cannot control the quality of accessories or parts manufactured by other companies, Yamaha cannot be held liable for

any consequences caused by the use of items which have not been approved by Yamaha.

---

## Adjusting the clutch lever free play

EAU22020

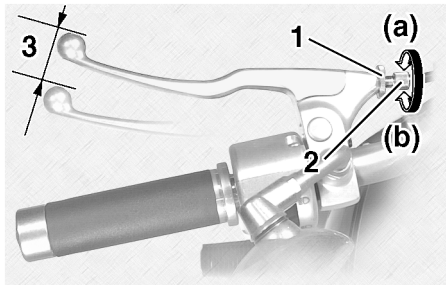

1. Locknut
2. Clutch lever free play adjusting bolt
3. Clutch lever free play

The clutch lever free play should measure 5.0–10.0 mm (0.20–0.39 in) as shown. Periodically check the clutch lever free play and, if necessary, adjust it as follows.

1. Loosen the locknut at the clutch lever.
2. To increase the clutch lever free play, turn the adjusting bolt in direction (a). To decrease the clutch lever free play, turn the adjusting bolt in direction (b).
3. Tighten the locknut.

**NOTE:** \_\_\_\_\_  
If the specified free play cannot be obtained as described above or if the clutch does not operate correctly, have a Yamaha dealer check the internal clutch mechanism.

---

## Adjusting the brake lever free play

EAU22092

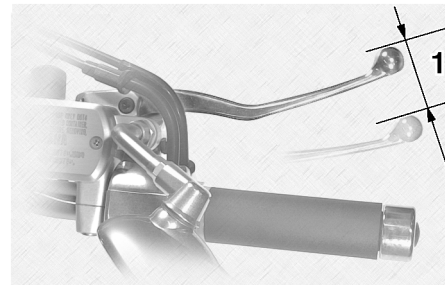

1. Brake lever free play

The brake lever free play should measure 5.0–8.0 mm (0.20–0.31 in) as shown. Periodically check the brake lever free play and, if necessary, adjust it as follows.

# PERIODIC MAINTENANCE AND MINOR REPAIR

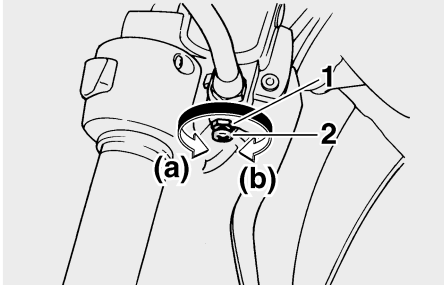

1. Locknut
2. Brake lever free play adjusting screw

1. Loosen the locknut at the brake lever.
2. To increase the brake lever free play, turn the adjusting screw in direction (a). To decrease the brake lever free play, turn the adjusting screw in direction (b).
3. Tighten the locknut.

EWA10630

## **⚠ WARNING**

- After adjusting the brake lever free play, check the free play and make sure that the brake is working properly.
- A soft or spongy feeling in the brake lever can indicate the presence of air in the hydraulic

system. If there is air in the hydraulic system, have a Yamaha dealer bleed the system before operating the motorcycle. Air in the hydraulic system will diminish the braking performance, which may result in loss of control and an accident.

## Adjusting the rear brake light switch EAU22270

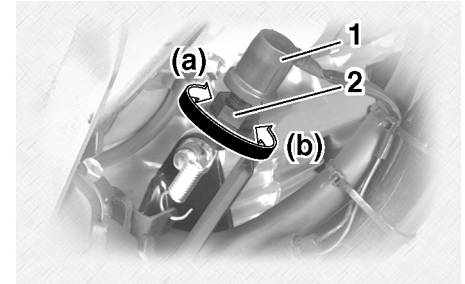

1. Rear brake light switch
2. Rear brake light switch adjusting nut

The rear brake light switch, which is activated by the brake pedal, is properly adjusted when the brake light comes on just before braking takes effect. If necessary, adjust the brake light switch as follows.

Turn the adjusting nut while holding the rear brake light switch in place. To make the brake light come on earlier, turn the adjusting nut in direction (a). To make the brake light come on later, turn the adjusting nut in direction (b).



# PERIODIC MAINTENANCE AND MINOR REPAIR

## Checking the front and rear brake pads

EAU22321

### Front brake

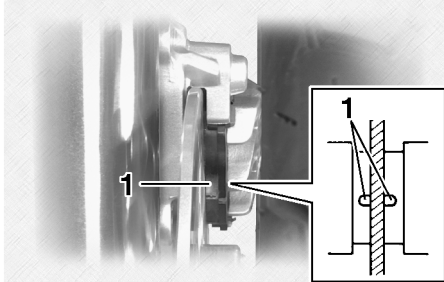

1. Brake pad wear indicator groove

### Rear brake

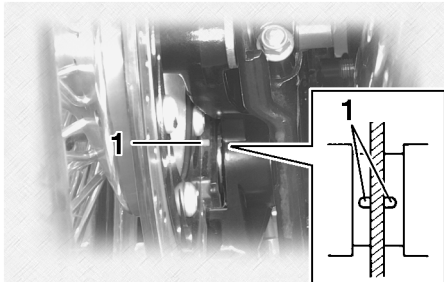

1. Brake pad wear indicator groove

The front and rear brake pads must be checked for wear at the intervals specified in the periodic maintenance and lubrication chart. Each brake pad is provided with a wear indicator groove, which allows you to check the brake pad wear without having to disassemble the brake. To check the brake pad wear, check the wear indicator grooves. If a brake pad has worn to the point that the wear indicator groove has almost disappeared, have a Yamaha dealer replace the brake pads as a set.

## Checking the brake fluid level

EAU22580

### Front brake

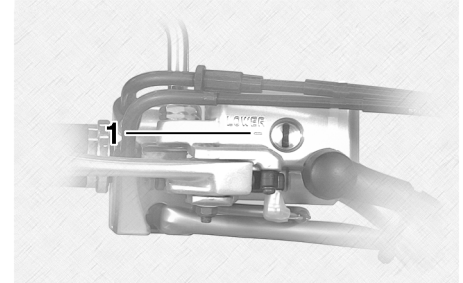

1. Minimum level mark

### Rear brake

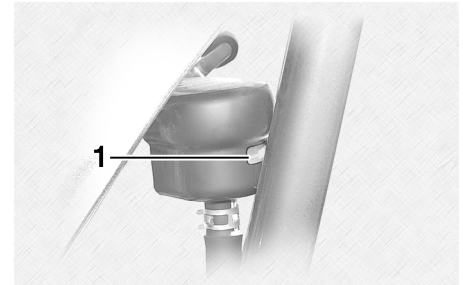

1. Minimum level mark

Insufficient brake fluid may allow air to enter the brake system, possibly causing it to become ineffective.

# PERIODIC MAINTENANCE AND MINOR REPAIR

EAU22730

Before riding, check that the brake fluid is above the minimum level mark and replenish if necessary. A low brake fluid level may indicate worn brake pads and/or brake system leakage. If the brake fluid level is low, be sure to check the brake pads for wear and the brake system for leakage.

Observe these precautions:

- When checking the fluid level, make sure that the top of the brake fluid reservoir is level.
- Use only the recommended quality brake fluid, otherwise the rubber seals may deteriorate, causing leakage and poor braking performance.

## Recommended brake fluid:

DOT 4

- Refill with the same type of brake fluid. Mixing fluids may result in a harmful chemical reaction and lead to poor braking performance.

- Be careful that water does not enter the brake fluid reservoir when refilling. Water will significantly lower the boiling point of the fluid and may result in vapor lock.
- Brake fluid may deteriorate painted surfaces or plastic parts. Always clean up spilled fluid immediately.
- As the brake pads wear, it is normal for the brake fluid level to gradually go down. However, if the brake fluid level goes down suddenly, have a Yamaha dealer check the cause.

## Changing the brake fluid

Have a Yamaha dealer change the brake fluid at the intervals specified in the NOTE after the periodic maintenance and lubrication chart. In addition, have the oil seals of the master cylinders and calipers as well as the brake hoses replaced at the intervals listed below or whenever they are damaged or leaking.

- Oil seals: Replace every two years.
- Brake hoses: Replace every four years.

# PERIODIC MAINTENANCE AND MINOR REPAIR

## Checking and lubricating the cables

EAU23090

The operation of all control cables and the condition of the cables should be checked before each ride, and the cables and cable ends should be lubricated if necessary. If a cable is damaged or does not move smoothly, have a Yamaha dealer check or replace it.

### Recommended lubricant:

Yamaha Chain and Cable Lube or engine oil SAE 10W-30 (API SE)

EWA10710

### WARNING

Damage to the outer housing of cables may result in internal rusting and cause interference with cable movement. Replace damaged cables as soon as possible to prevent unsafe conditions.

## Checking and lubricating the throttle grip and cable

EAU23111

The operation of the throttle grip should be checked before each ride. In addition, the cable should be lubricated at the intervals specified in the periodic maintenance chart.

## Checking and lubricating the brake and shift pedals

EAU23131

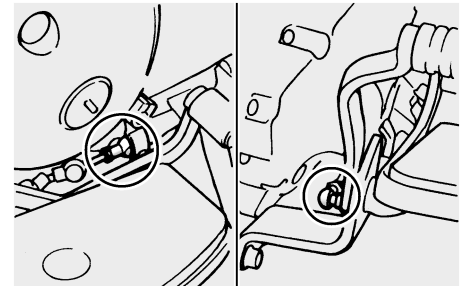
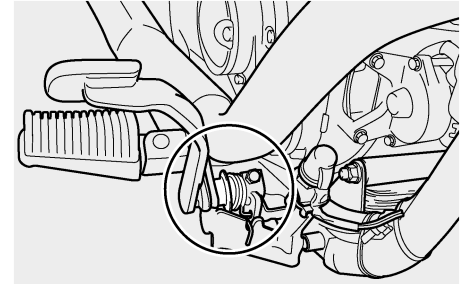

The operation of the brake and shift pedals should be checked before each ride, and the pedal pivots should be lubricated if necessary.

# PERIODIC MAINTENANCE AND MINOR REPAIR

## Recommended lubricant:

Lithium-soap-based grease (all-purpose grease)

## Checking and lubricating the brake and clutch levers

EAU23140

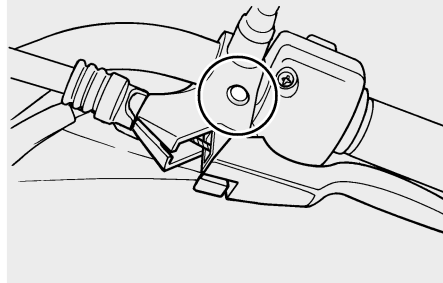

The operation of the brake and clutch levers should be checked before each ride, and the lever pivots should be lubricated if necessary.

## Recommended lubricant:

Lithium-soap-based grease (all-purpose grease)

## Checking and lubricating the sidestand

EAU23200

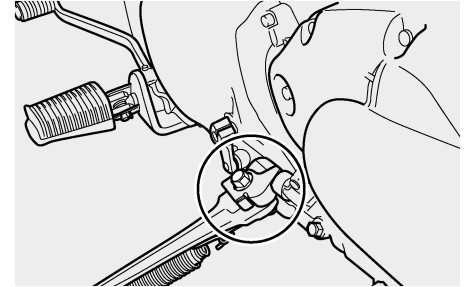

The operation of the sidestand should be checked before each ride, and the sidestand pivot and metal-to-metal contact surfaces should be lubricated if necessary.

## **⚠ WARNING**

**If the sidestand does not move up and down smoothly, have a Yamaha dealer check or repair it.**

EWA10730

## Recommended lubricant:

Lithium-soap-based grease (all-purpose grease)

# PERIODIC MAINTENANCE AND MINOR REPAIR

## Lubricating the swingarm pivots

EAUM1650

The swingarm pivots must be lubricated at the intervals specified in the periodic maintenance and lubrication chart.

**Recommended lubricant:**  
Lithium-soap-based grease

## Lubricating the rear suspension

EAU23250

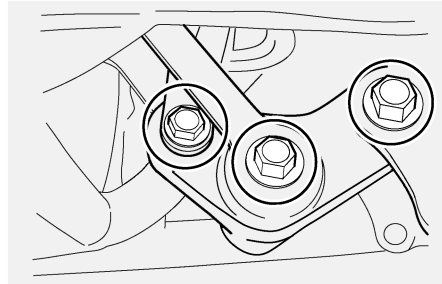

The pivoting points of the rear suspension must be lubricated at the intervals specified in the periodic maintenance and lubrication chart.

**Recommended lubricant:**  
Lithium-soap-based grease

## Checking the front fork

EAU23271

The condition and operation of the front fork must be checked as follows at the intervals specified in the periodic maintenance and lubrication chart.

### To check the condition

EWA10750

#### **⚠ WARNING**

**Securely support the vehicle so that there is no danger of it falling over.**

Check the inner tubes for scratches, damage and excessive oil leakage.

### To check the operation

1. Place the vehicle on a level surface and hold it in an upright position.
2. While applying the front brake, push down hard on the handlebars several times to check if the front fork compresses and rebounds smoothly.

# PERIODIC MAINTENANCE AND MINOR REPAIR

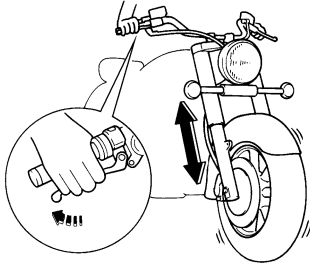

ECA10590

## CAUTION:

If any damage is found or the front fork does not operate smoothly, have a Yamaha dealer check or repair it.

6

## Checking the steering

EAU23280

Worn or loose steering bearings may cause danger. Therefore, the operation of the steering must be checked as follows at the intervals specified in the periodic maintenance and lubrication chart.

1. Place a stand under the engine to raise the front wheel off the ground.

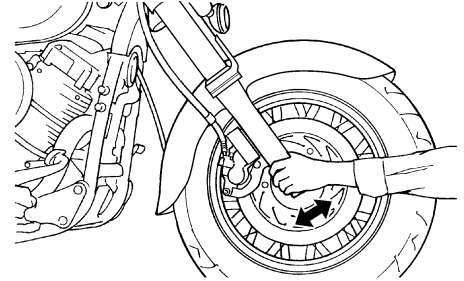

EWA10750

## ! WARNING

Securely support the vehicle so that there is no danger of it falling over.

2. Hold the lower ends of the front fork legs and try to move them forward and backward. If any free play can be felt, have a Yamaha dealer check or repair the steering.

EAU23290

## Checking the wheel bearings

The front and rear wheel bearings must be checked at the intervals specified in the periodic maintenance and lubrication chart. If there is play in the wheel hub or if the wheel does not turn smoothly, have a Yamaha dealer check the wheel bearings.

## Battery

EAU23380

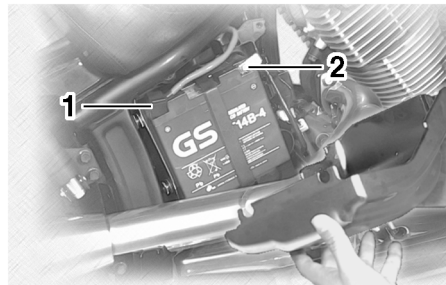

1. Positive battery terminal
2. Negative battery terminal

The battery is located behind panel A. (See page 6-8.)

This model is equipped with a sealed-type (MF) battery, which does not require any maintenance. There is no need to check the electrolyte or to add distilled water.

ECA10620

### CAUTION:

**Never attempt to remove the battery cell seals, as this would permanently damage the battery.**

EWA10760

### ⚠ WARNING

- **Electrolyte is poisonous and dangerous since it contains sulfuric acid, which causes severe burns. Avoid any contact with skin, eyes or clothing and always shield your eyes when working near batteries. In case of contact, administer the following FIRST AID.**
  - **EXTERNAL:** Flush with plenty of water.
  - **INTERNAL:** Drink large quantities of water or milk and immediately call a physician.
  - **EYES:** Flush with water for 15 minutes and seek prompt medical attention.
- **Batteries produce explosive hydrogen gas. Therefore, keep sparks, flames, cigarettes, etc., away from the battery and provide sufficient ventilation when charging it in an enclosed space.**

# PERIODIC MAINTENANCE AND MINOR REPAIR

- **KEEP THIS AND ALL BATTERIES OUT OF THE REACH OF CHILDREN.**

## To charge the battery

Have a Yamaha dealer charge the battery as soon as possible if it seems to have discharged. Keep in mind that the battery tends to discharge more quickly if the vehicle is equipped with optional electrical accessories.

## To store the battery

1. If the vehicle will not be used for more than one month, remove the battery, fully charge it, and then place it in a cool, dry place.
2. If the battery will be stored for more than two months, check it at least once a month and fully charge it if necessary.
3. Fully charge the battery before installation.
4. After installation, make sure that the battery leads are properly connected to the battery terminals.

ECA110630

## CAUTION:

- Always keep the battery charged. Storing a discharged battery can cause permanent battery damage.
- To charge a sealed-type (MF) battery, a special (constant-voltage) battery charger is required. Using a conventional battery charger will damage the battery. If you do not have access to a sealed-type (MF) battery charger, have a Yamaha dealer charge your battery.

EAU27102

## Replacing the fuses

The main fuse is located under the ignitor unit panel.

The fuse box, which contains the fuses for the individual circuits, is located inside the storage compartment. (See page 3-13.)

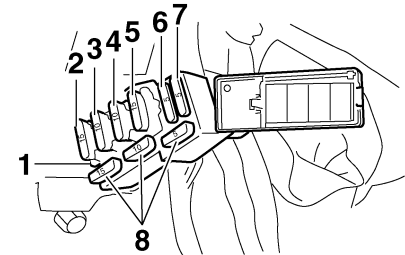

1. Fuse box
2. Headlight fuse
3. Signaling system fuse
4. Ignition fuse
5. Carburetor heater fuse
6. Ignitor unit fuse
7. Backup fuse (for odometer)
8. Spare fuse

If a fuse is blown, replace it as follows.



# PERIODIC MAINTENANCE AND MINOR REPAIR

**NOTE:** \_\_\_\_\_  
Include steps 1–3 and 8–9 only for the main fuse.

1. Remove the rider seat. (See page 3-9.)
2. Remove the quick fasteners shown by pushing the center in with a screwdriver, then pulling the fastener out.

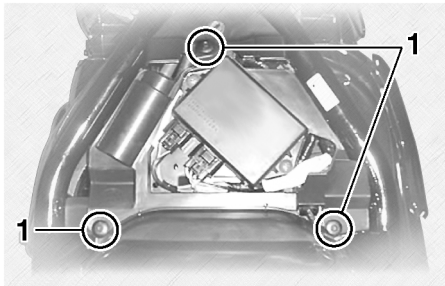

1. Quick fastener

3. Pull the ignitor unit panel outward to the right.

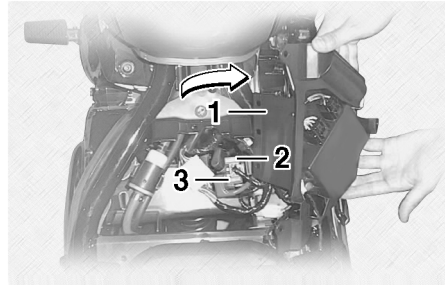

1. Ignitor unit panel
2. Spare main fuse
3. Main fuse
4. Turn the key to “OFF” and turn off the electrical circuit in question.
5. Remove the blown fuse, and then install a new fuse of the specified amperage.

## Specified fuses:

- Main fuse:  
30.0 A
- Backup fuse:  
5.0 A
- Ignition fuse:  
10.0 A
- Headlight fuse:  
15.0 A
- Carburetor heater fuse:  
15.0 A
- Signaling system fuse:  
10.0 A
- Ignitor unit fuse:  
5.0 A

ECA10640

## CAUTION:

**Do not use a fuse of a higher amperage rating than recommended to avoid causing extensive damage to the electrical system and possibly a fire.**

6. Turn the key to “ON” and turn on the electrical circuit in question to check if the device operates.
7. If the fuse immediately blows again, have a Yamaha dealer check the electrical system.

# PERIODIC MAINTENANCE AND MINOR REPAIR

- Place the ignitor unit panel in the original position and install the quick fasteners.

**NOTE:** \_\_\_\_\_

To install a quick fastener, push its pin back so that it will protrude from the fastener head, then insert the fastener and push the protruding pin in until it is flush with the fastener head.

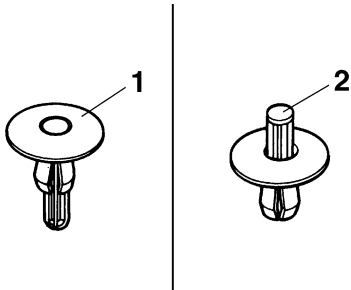

- Quick fastener (after removal)
- Quick fastener (before installation)

- Install the rider seat.

## Replacing the headlight bulb EAU23792

This model is equipped with a quartz bulb headlight. If the headlight bulb burns out, replace it as follows.

- Remove the headlight unit by removing the screws.

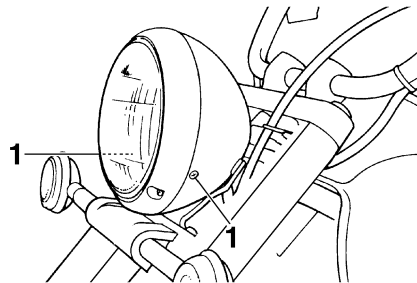

- Screw

- Disconnect the headlight coupler, and then remove the bulb cover.
- Unhook the headlight bulb holder, and then remove the defective bulb.

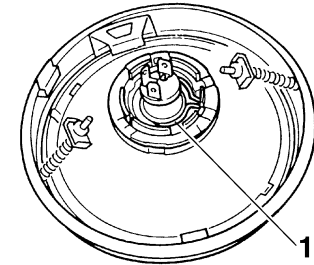

- Headlight bulb holder

EWA10790

### **⚠ WARNING**

Headlight bulbs get very hot. Therefore, keep flammable products away from a lit headlight bulb, and do not touch the bulb until it has cooled down.

- Place a new headlight bulb into position, and then secure it with the bulb holder.

ECA10660

### **CAUTION:** \_\_\_\_\_

Do not touch the glass part of the headlight bulb to keep it free from oil, otherwise the transparency of the glass, the luminosity of the bulb, and the bulb life will be adversely af-

# PERIODIC MAINTENANCE AND MINOR REPAIR

ected. Thoroughly clean off any dirt and fingerprints on the headlight bulb using a cloth moistened with alcohol or thinner.

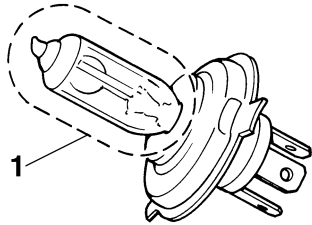

1. Do not touch the glass part of the bulb.
5. Install the headlight bulb cover, and then connect the coupler.
6. Install the headlight unit by installing the screws.
7. Have a Yamaha dealer adjust the headlight beam if necessary.

## Replacing a turn signal light bulb or the tail/brake light bulb

EAU24281

1. Remove the lens by removing the screws.

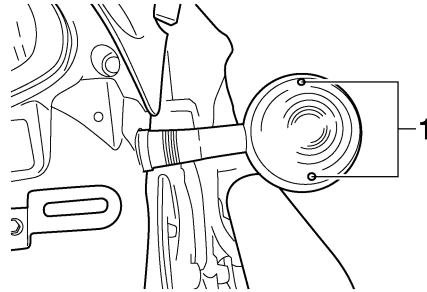

1. Screw

## XVS11V

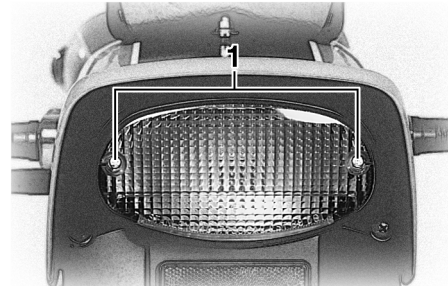

1. Screw

## XVS11AWV/XVS11ATV

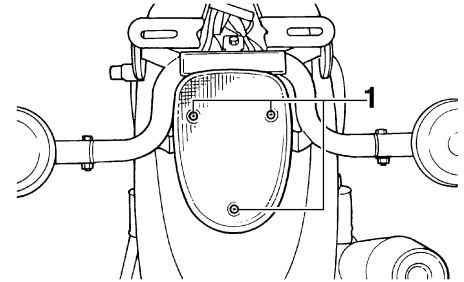

1. Screw
2. Remove the defective bulb by pushing it in and turning it counter-clockwise.
3. Insert a new bulb into the socket, push it in, and then turn it clockwise until it stops.
4. Install the lens by installing the screws.

ECA10680

### CAUTION:

Do not overtighten the screws, otherwise the lens may break.

# PERIODIC MAINTENANCE AND MINOR REPAIR

---

## Supporting the motorcycle

EAU24350

Since this model is not equipped with a centerstand, follow these precautions when removing the front and rear wheel or performing other maintenance requiring the motorcycle to stand upright. Check that the motorcycle is in a stable and level position before starting any maintenance. A strong wooden box can be placed under the engine for added stability.

## To service the front wheel

1. Stabilize the rear of the motorcycle by using a motorcycle stand or, if an additional motorcycle stand is not available, by placing a jack under the frame in front of the rear wheel.
2. Raise the front wheel off the ground by using a motorcycle stand.

## To service the rear wheel

Raise the rear wheel off the ground by using a motorcycle stand or, if a motorcycle stand is not available, by placing

a jack either under each side of the frame in front of the rear wheel or under each side of the swingarm.

## Troubleshooting

EAU25850

Although Yamaha motorcycles receive a thorough inspection before shipment from the factory, trouble may occur during operation. Any problem in the fuel, compression, or ignition systems, for example, can cause poor starting and loss of power.

The following troubleshooting chart represents a quick and easy procedure for checking these vital systems yourself. However, should your motorcycle require any repair, take it to a Yamaha dealer, whose skilled technicians have the necessary tools, experience, and know-how to service the motorcycle properly.

Use only genuine Yamaha replacement parts. Imitation parts may look like Yamaha parts, but they are often inferior, have a shorter service life and can lead to expensive repair bills.

# PERIODIC MAINTENANCE AND MINOR REPAIR

EAU25891

## Troubleshooting chart

EWA10840



**WARNING**

**Keep away open flames and do not smoke while checking or working on the fuel system.**

### 1. Fuel

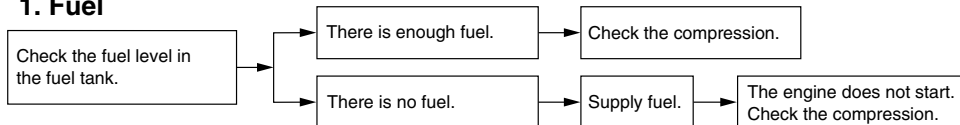

### 2. Compression

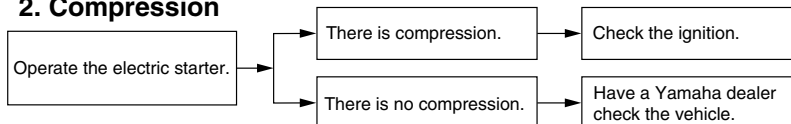

### 3. Ignition

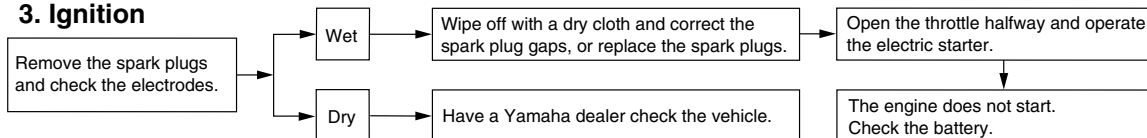

### 4. Battery

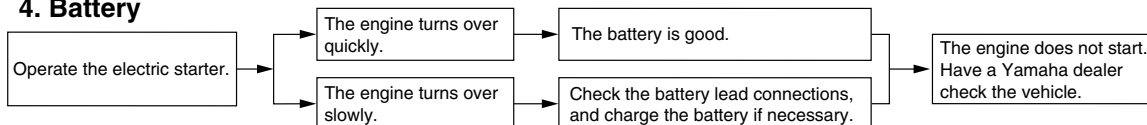

# MOTORCYCLE CARE AND STORAGE

---

EAU26060

## Care

While the open design of a motorcycle reveals the attractiveness of the technology, it also makes it more vulnerable. Rust and corrosion can develop even if high-quality components are used. A rusty exhaust pipe may go unnoticed on a car, however, it detracts from the overall appearance of a motorcycle. Frequent and proper care does not only comply with the terms of the warranty, but it will also keep your motorcycle looking good, extend its life and optimize its performance.

## Before cleaning

1. Cover the muffler outlets with plastic bags after the engine has cooled down.
2. Make sure that all caps and covers as well as all electrical couplers and connectors, including the spark plug caps, are tightly installed.
3. Remove extremely stubborn dirt, like oil burnt onto the crankcase, with a degreasing agent and a brush, but never apply such prod-

ucts onto seals, gaskets and wheel axles. Always rinse the dirt and degreaser off with water.

## Cleaning

ECA10770

### CAUTION:

- **Avoid using strong acidic wheel cleaners, especially on spoked wheels. If such products are used on hard-to-remove dirt, do not leave the cleaner on the affected area any longer than instructed. Also, thoroughly rinse the area off with water, immediately dry it, and then apply a corrosion protection spray.**
- **Improper cleaning can damage windshields, cowlings, panels and other plastic parts. Use only a soft, clean cloth or sponge with mild detergent and water to clean plastic.**
- **Do not use any harsh chemical products on plastic parts. Be sure to avoid using cloths or sponges which have been in contact with strong or abrasive cleaning products, solvent or**

thinner, fuel (gasoline), rust removers or inhibitors, brake fluid, antifreeze or electrolyte.

- **Do not use high-pressure washers or steam-jet cleaners since they cause water seepage and deterioration in the following areas: seals (of wheel and swing-arm bearings, fork and brakes), electric components (couplers, connectors, instruments, switches and lights), breather hoses and vents.**
  - **For motorcycles equipped with a windshield: Do not use strong cleaners or hard sponges as they will cause dulling or scratching. Some cleaning compounds for plastic may leave scratches on the windshield. Test the product on a small hidden part of the windshield to make sure that it does not leave any marks. If the windshield is scratched, use a quality plastic polishing compound after washing.**
-

# MOTORCYCLE CARE AND STORAGE

## After normal use

Remove dirt with warm water, a mild detergent, and a soft, clean sponge, and then rinse thoroughly with clean water. Use a toothbrush or bottlebrush for hard-to-reach areas. Stubborn dirt and insects will come off more easily if the area is covered with a wet cloth for a few minutes before cleaning.

## After riding in the rain, near the sea or on salt-sprayed roads

Since sea salt or salt sprayed on roads during winter are extremely corrosive in combination with water, carry out the following steps after each ride in the rain, near the sea or on salt-sprayed roads.

### **NOTE:** \_\_\_\_\_

Salt sprayed on roads in the winter may remain well into spring.

1. Clean the motorcycle with cold water and a mild detergent, after the engine has cooled down.

ECA10790

### **CAUTION:** \_\_\_\_\_

**Do not use warm water since it increases the corrosive action of the salt.**

2. After drying the motorcycle, apply a corrosion protection spray on all metal, including chrome- and nickel-plated, surfaces to prevent corrosion.

### **After cleaning**

1. Dry the motorcycle with a chamois or an absorbing cloth.
2. Use a chrome polish to shine chrome, aluminum and stainless-steel parts, including the exhaust system. (Even the thermally induced discoloring of stainless-steel exhaust systems can be removed through polishing.)
3. To prevent corrosion, it is recommended to apply a corrosion protection spray on all metal, including chrome- and nickel-plated, surfaces.
4. Use spray oil as a universal cleaner to remove any remaining dirt.

5. Touch up minor paint damage caused by stones, etc.
6. Wax all painted surfaces.
7. Let the motorcycle dry completely before storing or covering it.

EWA11130

### **! WARNING** \_\_\_\_\_

- **Make sure that there is no oil or wax on the brakes or tires.**
- **If necessary, clean the brake discs and brake linings with a regular brake disc cleaner or acetone, and wash the tires with warm water and a mild detergent. Before riding at higher speeds, test the motorcycle's braking performance and cornering behavior.**

ECA10800

### **CAUTION:** \_\_\_\_\_

- **Apply spray oil and wax sparingly and make sure to wipe off any excess.**
- **Never apply oil or wax to any rubber and plastic parts, but treat them with a suitable care product.**

# MOTORCYCLE CARE AND STORAGE

---

- **Avoid using abrasive polishing compounds as they will wear away the paint.**
- 

**NOTE:** \_\_\_\_\_  
Consult a Yamaha dealer for advice on what products to use.

---

## Storage

EAU26230

### Short-term

Always store your motorcycle in a cool, dry place and, if necessary, protect it against dust with a porous cover.

ECA10810

### **CAUTION:** \_\_\_\_\_

- **Storing the motorcycle in a poorly ventilated room or covering it with a tarp, while it is still wet, will allow water and humidity to seep in and cause rust.**
  - **To prevent corrosion, avoid damp cellars, stables (because of the presence of ammonia) and areas where strong chemicals are stored.**
- 

### Long-term

Before storing your motorcycle for several months:

1. Follow all the instructions in the “Care” section of this chapter.
2. For motorcycles equipped with a fuel cock that has an “OFF” position: Turn the fuel cock lever to “OFF”.

3. Drain the carburetor float chambers by loosening the drain bolts; this will prevent fuel deposits from building up. Pour the drained fuel into the fuel tank.
4. Fill up the fuel tank and add fuel stabilizer (if available) to prevent the fuel tank from rusting and the fuel from deteriorating.
5. Perform the following steps to protect the cylinders, piston rings, etc. from corrosion.
  - a. Remove the spark plug caps and spark plugs.
  - b. Pour a teaspoonful of engine oil into each spark plug bore.
  - c. Install the spark plug caps onto the spark plugs, and then place the spark plugs on the cylinder head so that the electrodes are grounded. (This will limit sparking during the next step.)
  - d. Turn the engine over several times with the starter. (This will coat the cylinder walls with oil.)
  - e. Remove the spark plug caps from the spark plugs, and then install the spark plugs and the spark plug caps.



# MOTORCYCLE CARE AND STORAGE

EWA10950



**To prevent damage or injury from sparking, make sure to ground the spark plug electrodes while turning the engine over.**

6. Lubricate all control cables and the pivoting points of all levers and pedals as well as of the side-stand/centerstand.
7. Check and, if necessary, correct the tire air pressure, and then lift the motorcycle so that both of its wheels are off the ground. Alternatively, turn the wheels a little every month in order to prevent the tires from becoming degraded in one spot.
8. Cover the muffler outlets with plastic bags to prevent moisture from entering them.
9. Remove the battery and fully charge it. Store it in a cool, dry place and charge it once a month. Do not store the battery in an excessively cold or warm place [less than 0 °C (30 °F) or more than 30

°C (90 °F)]. For more information on storing the battery, see page 6-30.

**NOTE:** \_\_\_\_\_  
Make any necessary repairs before storing the motorcycle.

# SPECIFICATIONS

## Dimensions:

### Overall length:

XVS11ATV 2460 mm (96.9 in)  
XVS11ATVC 2460 mm (96.9 in)  
XVS11AWV 2460 mm (96.9 in)  
XVS11AWVC 2460 mm (96.9 in)  
XVS11V 2405 mm (94.7 in)  
XVS11VC 2405 mm (94.7 in)

### Overall width:

XVS11ATV 945 mm (37.2 in)  
XVS11ATVC 945 mm (37.2 in)  
XVS11AWV 945 mm (37.2 in)  
XVS11AWVC 945 mm (37.2 in)  
XVS11V 895 mm (35.2 in)  
XVS11VC 895 mm (35.2 in)

### Overall height:

1095 mm (43.1 in)

### Seat height:

XVS11ATV 710 mm (28.0 in)  
XVS11ATVC 710 mm (28.0 in)  
XVS11AWV 710 mm (28.0 in)  
XVS11AWVC 710 mm (28.0 in)  
XVS11V 690 mm (27.2 in)  
XVS11VC 690 mm (27.2 in)

### Wheelbase:

XVS11ATV 1645 mm (64.8 in)  
XVS11ATVC 1645 mm (64.8 in)  
XVS11AWV 1645 mm (64.8 in)  
XVS11AWVC 1645 mm (64.8 in)  
XVS11V 1640 mm (64.6 in)  
XVS11VC 1640 mm (64.6 in)

### Ground clearance:

XVS11ATV 140 mm (5.51 in)  
XVS11ATVC 140 mm (5.51 in)  
XVS11AWV 140 mm (5.51 in)  
XVS11AWVC 140 mm (5.51 in)  
XVS11V 145 mm (5.71 in)  
XVS11VC 145 mm (5.71 in)

### Minimum turning radius:

XVS11ATV 3400 mm (133.9 in)  
XVS11ATVC 3400 mm (133.9 in)  
XVS11AWV 3400 mm (133.9 in)  
XVS11AWVC 3400 mm (133.9 in)  
XVS11V 3200 mm (126.0 in)  
XVS11VC 3200 mm (126.0 in)

## Weight:

### With oil and fuel:

XVS11ATV 285.0 kg (628 lb)  
XVS11ATVC 288.0 kg (635 lb)  
XVS11AWV 285.0 kg (628 lb)  
XVS11AWVC 288.0 kg (635 lb)  
XVS11V 275.0 kg (606 lb)  
XVS11VC 278.0 kg (613 lb)

## Engine:

### Engine type:

Air cooled 4-stroke, SOHC

### Cylinder arrangement:

V-type 2-cylinder

### Displacement:

1063.0 cm<sup>3</sup> (64.86 cu.in)

### Bore × stroke:

95.0 × 75.0 mm (3.74 × 2.95 in)

### Compression ratio:

8.30 :1

### Starting system:

Electric starter

### Lubrication system:

Wet sump

## Engine oil:

### Type:

YAMALUBE 4, SAE10W30 or SAE20W40

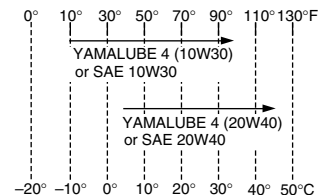

### Recommended engine oil grade:

API service SE, SF, SG type or higher

### Engine oil quantity:

Without oil filter element replacement:

3.00 L (3.17 US qt) (2.64 Imp.qt)

With oil filter element replacement:

3.10 L (3.28 US qt) (2.73 Imp.qt)

## Final gear oil:

### Type:

SAE80 API GL-4 Hypoid gear oil

### Quantity:

0.19 L (0.20 US qt) (0.17 Imp.qt)

## Air filter:

Air filter element:

Dry element

<b>Fuel:</b>	<b>Operation:</b>	<b>Size:</b>
Recommended fuel:	Left foot operation	XVS11ATV 130/90-16M/C 67S
Unleaded gasoline only	<b>Gear ratio:</b>	XVS11ATVC 130/90-16M/C 67S
<b>Fuel tank capacity:</b>	1st:	XVS11AWV 130/90-16M/C 67S
17.0 L (4.49 US gal) (3.74 Imp.gal)	40/17 (2.353)	XVS11AWVC 130/90-16M/C 67S
<b>Fuel reserve amount:</b>	2nd:	XVS11V 110/90-18M/C 61S
4.5 L (1.19 US gal) (0.99 Imp.gal)	40/24 (1.667)	XVS11VC 110/90-18M/C 61S
<b>Carburetor:</b>	3rd:	<b>Manufacturer/model:</b>
<b>Manufacturer:</b>	36/28 (1.286)	XVS11ATV DUNLOP/D404F
MIKUNI	4th:	XVS11ATVC DUNLOP/D404F
<b>Type × quantity:</b>	32/31 (1.032)	XVS11AWV DUNLOP/D404F
BSR37 x 2	5th:	XVS11AWVC DUNLOP/D404F
<b>Spark plug (s):</b>	29/34 (0.853)	XVS11V DUNLOP/K555F
<b>Manufacturer/model:</b>	<b>Chassis:</b>	XVS11VC DUNLOP/K555F
NGK/BPR7ES	<b>Frame type:</b>	<b>Manufacturer/model:</b>
<b>Manufacturer/model:</b>	Double cradle	XVS11ATV BRIDGESTONE/EXEDRA
DENSO/W22EPR-U	<b>Caster angle:</b>	G703
<b>Spark plug gap:</b>	33.00 °	XVS11ATVC BRIDGESTONE/EXEDRA
0.7–0.8 mm (0.028–0.031 in)	<b>Trail:</b>	G703
<b>Clutch:</b>	XVS11ATV 132.0 mm (5.20 in)	XVS11AWV BRIDGESTONE/EXEDRA
<b>Clutch type:</b>	XVS11ATVC 132.0 mm (5.20 in)	G703
Wet, multiple-disc	XVS11AWV 132.0 mm (5.20 in)	XVS11AWVC BRIDGESTONE/EXEDRA
<b>Transmission:</b>	XVS11AWVC 132.0 mm (5.20 in)	G703
<b>Primary reduction system:</b>	XVS11V 136.0 mm (5.35 in)	XVS11V BRIDGESTONE/EXEDRA L309
Spur gear	XVS11VC 136.0 mm (5.35 in)	XVS11VC BRIDGESTONE/EXEDRA L309
<b>Primary reduction ratio:</b>	<b>Front tire:</b>	<b>Rear tire:</b>
78/47 (1.660)	<b>Type:</b>	XVS11ATV Tubeless
<b>Secondary reduction system:</b>	XVS11ATV Tubeless	XVS11ATVC Tubeless
Shaft drive	XVS11ATVC Tubeless	XVS11AWV Tubeless
<b>Secondary reduction ratio:</b>	XVS11AWV Tubeless	XVS11AWVC Tubeless
44/47 × 19/18 × 32/11 (2.875)	XVS11AWVC Tubeless	XVS11V With tube
<b>Transmission type:</b>	XVS11V With tube	XVS11VC With tube
Constant mesh 5-speed	XVS11VC With tube	

# SPECIFICATIONS

## Size:

170/80-15M/C 77S

## Manufacturer/model:

XVS11ATV DUNLOP/D404G  
XVS11ATVC DUNLOP/D404G  
XVS11AWV DUNLOP/D404G  
XVS11AWVC DUNLOP/D404G  
XVS11V DUNLOP/K555  
XVS11VC DUNLOP/K555

## Manufacturer/model:

XVS11ATV BRIDGESTONE/EXEDRA  
G702  
XVS11ATVC BRIDGESTONE/EXEDRA  
G702  
XVS11AWV BRIDGESTONE/EXEDRA  
G702  
XVS11AWVC BRIDGESTONE/EXEDRA  
G702  
XVS11V BRIDGESTONE/EXEDRA  
G546G  
XVS11VC BRIDGESTONE/EXEDRA  
G546G

## Loading:

### Maximum load:

XVS11ATV 203 kg (448 lb)  
XVS11ATVC 200 kg (441 lb)  
XVS11AWV 203 kg (448 lb)  
XVS11AWVC 200 kg (441 lb)  
XVS11V 200 kg (441 lb)  
XVS11VC 197 kg (434 lb)  
(Total weight of rider, passenger, cargo and accessories)

## Tire air pressure (measured on cold tires):

### Loading condition:

0–90 kg (0–198 lb)

#### Front:

XVS11ATV 225 kPa (33 psi) (2.25 kgf/cm<sup>2</sup>)  
XVS11ATVC 225 kPa (33 psi) (2.25 kgf/cm<sup>2</sup>)

XVS11AWV 225 kPa (33 psi) (2.25 kgf/cm<sup>2</sup>)

XVS11AWVC 225 kPa (33 psi) (2.25 kgf/cm<sup>2</sup>)

XVS11V 200 kPa (29 psi) (2.00 kgf/cm<sup>2</sup>)

XVS11VC 200 kPa (29 psi) (2.00 kgf/cm<sup>2</sup>)

#### Rear:

XVS11ATV 250 kPa (36 psi) (2.50 kgf/cm<sup>2</sup>)

XVS11ATVC 250 kPa (36 psi) (2.50 kgf/cm<sup>2</sup>)

XVS11AWV 250 kPa (36 psi) (2.50 kgf/cm<sup>2</sup>)

XVS11AWVC 250 kPa (36 psi) (2.50 kgf/cm<sup>2</sup>)

XVS11V 225 kPa (33 psi) (2.25 kgf/cm<sup>2</sup>)

XVS11VC 225 kPa (33 psi) (2.25 kgf/cm<sup>2</sup>)

### Loading condition:

XVS11ATV 90–203 kg (198–448 lb)

XVS11ATVC 90–200 kg (198–441 lb)

XVS11AWV 90–203 kg (198–448 lb)

XVS11AWVC 90–200 kg (198–441 lb)

XVS11V 90–200 kg (198–441 lb)

XVS11VC 90–197 kg (198–434 lb)

#### Front:

225 kPa (33 psi) (2.25 kgf/cm<sup>2</sup>)

#### Rear:

250 kPa (36 psi) (2.50 kgf/cm<sup>2</sup>)

## Front wheel:

### Wheel type:

XVS11ATV Cast wheel  
XVS11ATVC Cast wheel  
XVS11AWV Cast wheel  
XVS11AWVC Cast wheel  
XVS11V Spoke wheel  
XVS11VC Spoke wheel

### Rim size:

XVS11ATV 16M/C x MT3.00  
XVS11ATVC 16M/C x MT3.00  
XVS11AWV 16M/C x MT3.00  
XVS11AWVC 16M/C x MT3.00  
XVS11V 18x2.15  
XVS11VC 18x2.15

## Rear wheel:

### Wheel type:

XVS11ATV Cast wheel  
XVS11ATVC Cast wheel  
XVS11AWV Cast wheel  
XVS11AWVC Cast wheel  
XVS11V Spoke wheel  
XVS11VC Spoke wheel

### Rim size:

15M/C x MT4.50

## Front brake:

- Type:
  - Dual disc brake
- Operation:
  - Right hand operation
- Recommended fluid:
  - DOT 4

## Rear brake:

- Type:
  - Single disc brake
- Operation:
  - Right foot operation
- Recommended fluid:
  - DOT 4

## Front suspension:

- Type:
  - Telescopic fork
- Spring/shock absorber type:
  - Coil spring/oil damper
- Wheel travel:
  - 140.0 mm (5.51 in)

## Rear suspension:

- Type:
  - Swingarm (link suspension)
- Spring/shock absorber type:
  - Coil spring/gas-oil damper
- Wheel travel:
  - 113.0 mm (4.45 in)

## Electrical system:

- Ignition system:
  - Transistorized coil ignition (digital)
- Charging system:
  - AC magneto

## Battery:

- Model:
  - GT14B-4
- Voltage, capacity:
  - 12 V, 12.0 Ah

## Headlight:

- Bulb type:
  - Halogen bulb

## Bulb voltage, wattage × quantity:

- Headlight:
  - 12 V, 60 W/55.0 W × 1
- Tail/brake light:
  - 12 V, 8.0 W/27.0 W × 1
- Front turn signal/position light:
  - 12 V, 23 W/8.0 W × 2
- Rear turn signal light:
  - 12 V, 21.0 W × 2
- Meter lighting:
  - 14 V, 1.4 W × 2
- Neutral indicator light:
  - 12 V, 1.7 W × 1
- High beam indicator light:
  - 12 V, 1.7 W × 1
- Oil level warning light:
  - 12 V, 1.7 W × 1
- Turn signal indicator light:
  - 12 V, 1.7 W × 1
- Engine trouble warning light:
  - 12 V, 1.7 W × 1

## Fuses:

- Main fuse:
  - 30.0 A
- Headlight fuse:
  - 15.0 A

- Signaling system fuse:
  - 10.0 A
- Ignition fuse:
  - 10.0 A
- Carburetor heater fuse:
  - 15.0 A
- Ignitor unit fuse:
  - 5.0 A
- Backup fuse:
  - 5.0 A

# CONSUMER INFORMATION

EAU26351

## Identification numbers

Record the key identification number, vehicle identification number and model label information in the spaces provided below for assistance when ordering spare parts from a Yamaha dealer or for reference in case the vehicle is stolen.

KEY IDENTIFICATION NUMBER:

VEHICLE IDENTIFICATION NUMBER:

MODEL LABEL INFORMATION:

## Key identification number

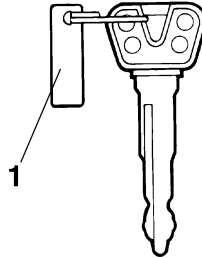

1. Key identification number

The key identification number is stamped into the key tag. Record this number in the space provided and use it for reference when ordering a new key.

EAU26381

## Vehicle identification number

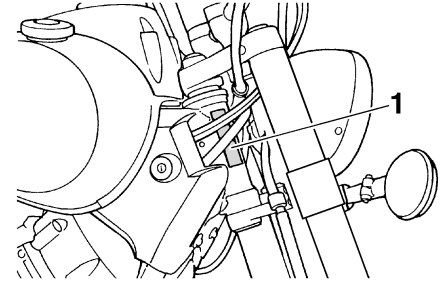

1. Vehicle identification number

The vehicle identification number is stamped into the steering head pipe. Record this number in the space provided.

**NOTE:** \_\_\_\_\_

The vehicle identification number is used to identify your motorcycle and may be used to register your motorcycle with the licensing authority in your area.

\_\_\_\_\_

EAU26400

EAU26470

## Model label

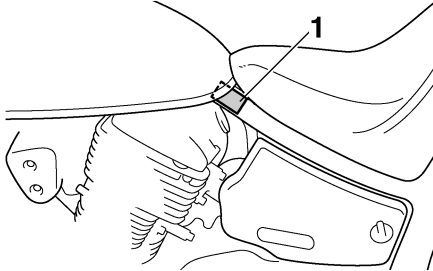

### 1. Model label

The model label is affixed to the frame under the rider seat. (See page 3-9.) Record the information on this label in the space provided. This information will be needed when ordering spare parts from a Yamaha dealer.

# CONSUMER INFORMATION

---

---

EAU26550

## Reporting safety defects

If you believe that your vehicle has a defect which could cause a crash or could cause injury or death, you should immediately inform the National Highway Traffic Safety Administration (NHTSA) in addition to notifying Yamaha Motor Corporation, U.S.A. If NHTSA receives similar complaints, it may open an investigation, and if it finds that a safety defect exists in a group of vehicles, it may order a recall and remedy campaign. However, NHTSA cannot become involved in individual problems between you, your dealer, or Yamaha Motor Corporation, U.S.A.

To contact NHTSA, you may either call the Auto Safety Hotline toll-free at 1-800-424-9393 (or 366-0123 in Washington, D.C. area) or write to: NHTSA, U.S. Department of Transportation, Washington, D.C. 20590. You can also obtain other information about motor vehicle safety from the Hotline.



## Motorcycle noise regulation

### TAMPERING WITH NOISE CONTROL SYSTEM PROHIBITED:

Federal law prohibits the following acts or the causing thereof: (1) The removal or rendering inoperative by any person other than for purposes of maintenance, repair, or replacement of any device or element of design incorporated into any new vehicle for the purpose of noise control prior to its sale or delivery to the ultimate purchaser or while it is in use or (2) the use of the vehicle after such device or element of design has been removed or rendered inoperative by any person.

“AMONG THOSE ACTS PRESUMED TO CONSTITUTE TAMPERING ARE THE ACTS LISTED BELOW”.

These acts include tampering with the following systems; i.e., modification, removal, etc.

#### Exhaust system

- Muffler
- Exhaust pipe
- Silencer

#### Intake system

- Air cleaner case
- Air cleaner element
- Intake duct

# CONSUMER INFORMATION

EAU26632

## Maintenance record

Copies of work orders and/or receipts for parts purchased and installed on your vehicle will be required to document that maintenance has been completed in accordance with the emissions warranty. The chart below is printed only as a reminder that maintenance work is required. It is not acceptable proof of maintenance work.

Maintenance interval	Date of service	Mileage	Servicing dealer name and address	Remarks
600 mi (1000 km) or 1 month				
4000 mi (7000 km) or 6 months				
8000 mi (13000 km) or 12 months				
12000 mi (19000 km) or 18 months				
16000 mi (25000 km) or 24 months				
20000 mi (31000 km) or 30 months				
24000 mi (37000 km) or 36 months				
28000 mi (43000 km) or 42 months				
32000 mi (49000 km) or 48 months				

# CONSUMER INFORMATION

Maintenance interval	Date of service	Mileage	Servicing dealer name and address	Remarks
36000 mi (55000 km) or 54 months				
40000 mi (61000 km) or 60 months				

# CONSUMER INFORMATION

EAU26661

## YAMAHA MOTOR CORPORATION, U.S.A. STREET AND ENDURO MOTORCYCLE LIMITED WARRANTY

Yamaha Motor Corporation, U.S.A. hereby warrants each new model Yamaha motorcycle will be free from defects in material and workmanship for the period of time stated herein, subject to certain stated limitations.

**THE PERIOD OF WARRANTY** for Yamaha motorcycles originally equipped with headlight, stoplight, and turn signals shall be one (1) year from the date of purchase, with no mileage limitation.

**MODELS EXCLUDED FROM WARRANTY** include those used for non-Yamaha-authorized renting, leasing, or other commercial purposes, and TZ models.

**DURING THE PERIOD OF WARRANTY** any authorized Yamaha motorcycle dealer will, free of charge, repair or replace any part adjudged defective by Yamaha due to faulty workmanship or material from the factory. Parts used in warranty repairs will be warranted for the balance of the product's warranty period. All parts replaced under warranty become property of Yamaha Motor Corp. U.S.A.

**GENERAL EXCLUSIONS** from this warranty shall include any failures caused by:

- a. Competition or racing use.
- b. Installation of parts or accessories that are not qualitatively equivalent to genuine Yamaha parts.
- c. Abnormal strain, neglect, or abuse.
- d. Lack of proper maintenance.
- e. Accident or collision damage.
- f. Modification to original parts.

**SPECIFIC EXCLUSIONS** from this warranty shall include parts replaced due to normal wear or routine maintenance.

**THE CUSTOMER'S RESPONSIBILITY** under this warranty shall be to:

1. Operate and maintain the motorcycle as specified in the appropriate Owner's Manual, and
2. Give notice to an authorized Yamaha motorcycle dealer of any and all apparent defects within ten (10) days after discovery, and make the machine available at that time for inspection and repairs at such dealer's place of business.

**WARRANTY TRANSFER:** To transfer the warranty from the original purchaser to any subsequent purchaser, it is imperative that the machine be inspected and registered for warranty by an authorized Yamaha motorcycle dealer. In order for this warranty to remain in effect, this inspection and registration must take place within ten (10) days after transfer. An inspection and registration fee will be charged for this service.

### EMISSIONS CONTROL SYSTEM WARRANTY

Yamaha Motor Corporation, U.S.A. also warrants to the ultimate purchaser and each subsequent purchaser of each Yamaha motorcycle covered by this warranty with a displacement of 50cc or greater, that the vehicle is designed, built, and equipped so as to conform at the time of sale with all U.S. emissions standards applicable at the time of manufacture and that it is free from defects in materials and workmanship which would cause it not to meet these standards within the periods listed immediately below. Failure other than those resulting from defects in material or workmanship which arise solely as a result of owner abuse and / or lack of proper maintenance are not covered by this warranty.

ENGINE DISPLACEMENT	PERIOD
50cc to 169cc	12,000 km (7,465 miles) or five years, whichever occurs first
170cc to 279cc	18,000 km (11,185 miles) or five years, whichever occurs first
280cc or over	30,000 km (18,641 miles) or five years, whichever occurs first

**YAMAHA MOTOR CORPORATION, U.S.A. MAKES NO OTHER WARRANTY OF ANY KIND, EXPRESSED OR IMPLIED. ALL IMPLIED WARRANTIES OF MERCHANTABILITY AND FITNESS FOR A PARTICULAR PURPOSE WHICH EXCEED THE OBLIGATIONS AND TIME LIMITS STATED IN THIS WARRANTY ARE HEREBY DISCLAIMED BY YAMAHA MOTOR CORPORATION, U.S.A. AND EXCLUDED FROM THIS WARRANTY.**

**SOME STATES DO NOT ALLOW LIMITATIONS ON HOW LONG AN IMPLIED WARRANTY LASTS, SO THE ABOVE LIMITATION MAY NOT APPLY TO YOU. ALSO EXCLUDED FROM THIS WARRANTY ARE ANY INCIDENTAL OR CONSEQUENTIAL DAMAGES INCLUDING LOSS OF USE. SOME STATES DO NOT ALLOW THE EXCLUSION OR LIMITATION OF INCIDENTAL OR CONSEQUENTIAL DAMAGES, SO THE ABOVE EXCLUSION MAY NOT APPLY TO YOU.**

**THIS WARRANTY GIVES YOU SPECIFIC LEGAL RIGHTS, AND YOU MAY ALSO HAVE OTHER RIGHTS WHICH VARY FROM STATE TO STATE.**

YAMAHA MOTOR CORPORATION, U.S.A.  
P.O. Box 6555  
Cypress, California 90630

## WARRANTY QUESTIONS AND ANSWERS

- Q. What costs are my responsibility during the warranty period?
- A. The customer's responsibility includes all costs of normal maintenance services, non-warranty repairs, accident and collision damages, and oil, oil filters, air filters, spark plugs, and brake shoes.
- Q. What are some examples of "abnormal" strain, neglect, or abuse?
- A. These terms are general and overlap each other in areas. Specific examples include: Running the machine out of oil, sustained high-rpm, full-throttle, operating the machine with a broken or damaged part which causes another part to fail, damage or failure due to improper or careless transportation and or tie down. If you have any specific questions on operation or maintenance, please contact your dealer for advice.
- Q. Does the warranty cover incidental costs such as towing or transportation due to a failure?
- A. No. The warranty is limited to repair of the machine itself.
- Q. May I perform any or all of the recommended maintenance shown in the Owner's Manual instead of having the dealer do them?
- A. Yes, if you are a qualified mechanic and follow the procedures specified in the Owner's and Service Manual. We do recommend, however, that items requiring special tools or equipment be done by Yamaha Motorcycle dealer.
- Q. Will the warranty be void or cancelled if I do not operate or maintain my new motorcycle exactly as specified in the Owner's Manual?
- A. No. The warranty on a new motorcycle cannot be "voided" or "cancelled." **However, if a particular failure is caused by operation or maintenance other than as shown in the Owner's Manual, that failure may not be covered under warranty.**
- Q. What responsibility does my dealer have under this warranty?
- A. Each Yamaha Motorcycle dealer is expected to:
1. Completely set up every new machine before sale.
  2. Explain the operation, maintenance, and warranty requirements to your satisfaction at the time of sale, and upon your request at any later date.
  3. Each Yamaha Motorcycle dealer is held responsible for his setup, service and warranty repair work.
- Q. Is the warranty transferable to second owners?
- A. Yes. The remainder of the existing warranty can be transferred upon request. The unit has to be inspected and re-registered by an authorized Yamaha Motorcycle dealer for the policy to remain effective.

## CUSTOMER SERVICE

If your machine requires warranty service, you must take it to any authorized Yamaha Motorcycle dealer within the continental United States. Be sure to bring your warranty registration card or other valid proof of the original date of purchase. If a question or problem arises regarding warranty, first contact the owner of the dealership. Since all warranty matters are handled at the dealer level, this person is in the best position to help you. If you are still not satisfied and require additional assistance, please write:

YAMAHA MOTOR CORPORATION U.S.A.  
CUSTOMER RELATIONS DEPARTMENT  
P.O. Box 6555  
Cypress, California 90630

When contacting Yamaha Motor Corporation, U.S.A. don't forget to include any important information such as names, addresses, model, V.I.N. (frame number), dates, and receipts.

## CHANGE OF ADDRESS

The federal government requires each manufacturer of a motor vehicle to maintain a complete, up-to-date list of all first purchasers against the possibility of a safety-related defect and recall. This list is compiled from the purchase registrations sent to Yamaha Motor Corporation, U.S.A. by the selling dealer at the time of your purchase.

If you should move after you have purchased your new motorcycle, please advise us of your new address by sending a postcard listing your motorcycle model name, V.I.N. (frame number), dealer number (or dealer's name) as it is shown on your warranty card, your name and new mailing address. Mail to:

YAMAHA MOTOR CORPORATION, U.S.A.  
P.O. Box 6555  
Cypress, California 90630  
Attention: Warranty Department

This will ensure that Yamaha Motor Corporation, U.S.A. has an up-to-date registration record in accordance with federal law.

# CONSUMER INFORMATION

---

EAU26750

## YAMAHA EXTENDED SERVICE (Y.E.S.)

Keep your Yamaha protected even after your warranty expires with genuine Yamaha Extended Service (Y.E.S.).

- Y.E.S. is designed and administered by Yamaha Motor Corporation to provide maximum owner satisfaction. You get uninterrupted factory-backed coverage for extra peace of mind.
- Y.E.S. is flexible. You choose the plan that's right for you: 12 months, 24 months, 36 months or, on certain models, even 48 months beyond your warranty period.
- Y.E.S. is designed and administered by the same Yamaha people who handle your warranty – and it shows in the comprehensive coverage benefits. There are no mileage limitations. Coverage isn't limited to “moving parts” or the “drive train” like many other plans. And Y.E.S. covers manufacturing defects just like the warranty. See the sample contract at your Yamaha dealer to see how comforting uninterrupted factory-backed protection can be.
- You don't have to pay anything for covered repairs. There's no deductible to pay, and repairs aren't “pro-rated.” You don't have any “out-of-pocket” expenses for covered repairs.
- In addition, Travel and Recreation Interruption Protection (TRIP) is included at no extra cost. TRIP gives you up to \$150 reimbursement per occurrence for any reasonable expenses you incur because your Yamaha needs covered service: replacement vehicle rental, emergency towing, phone calls, even food and lodging when you are away from home. This superb coverage goes into effect when you purchase Y.E.S., so it applies to any warranty repairs as well as covered repairs during your entire Y.E.S. plan period.
- Y.E.S. coverage is honored at any authorized Yamaha dealer nationwide.
- Y.E.S. coverage is transferable to a new owner if you sell or trade-in. That can make your Yamaha much more valuable!

This excellent Y.E.S. plan coverage is only available to Yamaha owners like you, and only while your Yamaha is still within the Yamaha Limited Warranty period. So visit your authorized Yamaha dealer to get all the facts. He can show you how easy it is to protect your investment with Yamaha Extended Service.

# CONSUMER INFORMATION

---

We urge you to act now. You'll get the excellent benefits of TRIP coverage right away, and you'll rest easy knowing you'll have strong factory-backed protection even after your Yamaha Limited Warranty expires.

A special note:

If visiting your dealer isn't convenient, contact Yamaha with your Primary ID number (your frame number). We'll be happy to help you get the Y.E.S. coverage you need.

Yamaha Service Marketing

P.O. Box 6555

Cypress, CA 90630

1-(866)-YES-EXTD (1-866-937-3983)

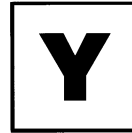

**YAMAHA**



**EXTENDED**

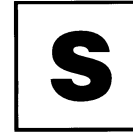

**SERVICE**

# INDEX

---

## A

- Accessories and replacement parts ..... 6-21
- Air filter element, cleaning ..... 6-13

## B

- Battery ..... 6-30
- Brake and clutch levers,  
checking and lubricating ..... 6-27
- Brake and shift pedals,  
checking and lubricating ..... 6-26
- Brake fluid, changing ..... 6-25
- Brake fluid level, checking ..... 6-24
- Brake lever ..... 3-5
- Brake lever free play, adjusting ..... 6-22
- Brake pedal ..... 3-6

## C

- Cables, checking and lubricating ..... 6-26
- Canister (for California only) ..... 6-10
- Carburetors ..... 6-14
- Care ..... 7-1
- Catalytic converter  
(for California only) ..... 3-8
- Clutch lever ..... 3-4
- Clutch lever free play, adjusting ..... 6-22

## D

- Dimmer switch ..... 3-4

## E

- Engine break-in ..... 5-4
- Engine oil ..... 6-10
- Engine, starting a warm ..... 5-2
- Engine stop switch ..... 3-4
- Engine trouble warning light ..... 3-2

## F

- Final gear oil ..... 6-12
- Front and rear brake pads, checking .... 6-24

- Front fork, checking ..... 6-28
- Fuel ..... 3-7
- Fuel cock ..... 3-8
- Fuel tank cap ..... 3-6
- Fuses, replacing ..... 6-31

## H

- Handlebar switches ..... 3-3
- Headlight bulb, replacing ..... 6-33
- Helmet holder ..... 3-12
- High beam indicator light ..... 3-2
- Horn switch ..... 3-4

## I

- Identification numbers ..... 9-1
- Ignition circuit cut-off system ..... 3-17
- Indicator and warning lights ..... 3-2

## K

- Key identification number ..... 9-1

## L

- Labels, location of ..... 1-5
- Luggage strap holders ..... 3-16

## M

- Main switch/steering lock ..... 3-1
- Maintenance and lubrication,  
periodic ..... 6-4
- Maintenance, emission control  
system ..... 6-3
- Maintenance, periodic ..... 6-1
- Maintenance record ..... 9-5
- Model label ..... 9-2

## N

- Neutral indicator light ..... 3-2
- Noise regulation ..... 9-4

## O

- Oil level warning light ..... 3-2

## P

- Panel, removing and installing ..... 6-8
- Parking ..... 5-5
- Part locations ..... 2-1
- Pre-operation check list ..... 4-2

## R

- Rear brake light switch, adjusting ..... 6-23
- Rear suspension, lubricating ..... 6-28

## S

- Safety defects, reporting ..... 9-3
- Safety information ..... 1-1
- Seats (XVS11AWV/XVS11ATV) ..... 3-11
- Seats (XVS11V) ..... 3-9
- Shifting ..... 5-3
- Shift pedal (XVS11AWV/XVS11ATV) ..... 3-5
- Shift pedal (XVS11V) ..... 3-5
- Shock absorber assembly, adjusting .... 3-14
- Sidestand ..... 3-16
- Sidestand, checking and lubricating ..... 6-27
- Spark plugs, checking ..... 6-8
- Specifications ..... 8-1
- Speedometer unit ..... 3-3
- Starter (choke) lever ..... 3-9
- Starting and warming up a cold  
engine ..... 5-1
- Start switch ..... 3-4
- Steering, checking ..... 6-29
- Storage ..... 7-3
- Storage compartment ..... 3-13
- Supporting the motorcycle ..... 6-35
- Swingarm pivots, lubricating ..... 6-28

## T

- Throttle cable free play, checking ..... 6-15



Throttle grip and cable, checking and lubricating.....	6-26
Tires (XVS11AWV/XVS11ATV).....	6-18
Tires (XVS11V).....	6-15
Tool kit.....	6-1
Troubleshooting.....	6-35
Troubleshooting chart.....	6-36
Turn signal indicator light.....	3-2
Turn signal light bulb or tail/brake light bulb, replacing .....	6-34
Turn signal switch.....	3-4

## **V**

Valve clearance .....	6-15
Vehicle identification number.....	9-1

## **W**

Warranty, extended .....	9-9
Warranty, limited.....	9-7
Wheel bearings, checking .....	6-30
Wheels (XVS11AWV/XVS11ATV).....	6-20
Wheels (XVS11V).....	6-20

***PROTECT YOUR INVESTMENT***

***Use Genuine YAMAHA Parts And Accessories***

***See your Authorized YAMAHA Dealer for a Genuine YAMAHA Service Manual.***



**YAMAHA**

YAMAHA MOTOR CO., LTD.

PRINTED ON RECYCLED PAPER

PRINTED IN JAPAN  
2005.06-3.8×1 CR  
(E)