



## OWNER'S MANUAL



***XVZ13CTW(C)***  
***XVZ13CTMW(C)***

EAU10041

** WARNING**

**The engine exhaust from this product contains chemicals known to the State of California to cause cancer, birth defects or other reproductive harm.**

YAMAHA

LIT-CALIF-65-01

Congratulations on your purchase of the Yamaha Royal Star™ Series. This model is the result of Yamaha's vast experience in the production of fine sporting, touring, and pacesetting racing machines. It represents the high degree of craftsmanship and reliability that have made Yamaha a leader in these fields.

This manual will give you an understanding of the operation, inspection, and basic maintenance of this motorcycle. If you have any questions concerning the operation or maintenance of your motorcycle, please consult a Yamaha dealer.

The design and manufacture of this Yamaha motorcycle fully comply with the emissions standards for clean air applicable at the date of manufacture. Yamaha has met these standards without reducing the performance or economy of operation of the motorcycle. To maintain these high standards, it is important that you and your Yamaha dealer pay close attention to the recommended maintenance schedules and operating instructions contained within this manual.



# IMPORTANT MANUAL INFORMATION

---

---

EAU10131

Particularly important information is distinguished in this manual by the following notations:

	<b>The Safety Alert Symbol means ATTENTION! BECOME ALERT! YOUR SAFETY IS INVOLVED!</b>
	<b>Failure to follow WARNING instructions could result in severe injury or death to the motorcycle operator, a bystander or a person inspecting or repairing the motorcycle.</b>
<b>CAUTION:</b>	<b>A CAUTION indicates special precautions that must be taken to avoid damage to the motorcycle.</b>
<b>NOTE:</b>	<b>A NOTE provides key information to make procedures easier or clearer.</b>

## NOTE:

- This manual should be considered a permanent part of this motorcycle and should remain with it even if the motorcycle is subsequently sold.
- Yamaha continually seeks advancements in product design and quality. Therefore, while this manual contains the most current product information available at the time of printing, there may be minor discrepancies between your motorcycle and this manual. If you have any questions concerning this manual, please consult your Yamaha dealer.

EWA10010

## **WARNING**

**PLEASE READ THIS MANUAL AND THE “YOU AND YOUR MOTORCYCLE: RIDING TIPS” BOOKLET CAREFULLY AND COMPLETELY BEFORE OPERATING THIS MOTORCYCLE. DO NOT ATTEMPT TO OPERATE THIS MOTORCYCLE UNTIL YOU HAVE ATTAINED ADEQUATE KNOWLEDGE OF ITS CONTROLS AND OPERATING FEATURES**

## **IMPORTANT MANUAL INFORMATION**

---

---

**AND UNTIL YOU HAVE BEEN TRAINED IN SAFE AND PROPER RIDING TECHNIQUES. REGULAR INSPECTIONS AND CAREFUL MAINTENANCE, ALONG WITH GOOD RIDING SKILLS, WILL ENSURE THAT YOU SAFELY ENJOY THE CAPABILITIES AND THE RELIABILITY OF THIS MOTORCYCLE.**

---

\*Product and specifications are subject to change without notice.

# IMPORTANT MANUAL INFORMATION

---

---

EAU10192

AFFIX DEALER  
LABEL HERE

**XVZ13CTW(C)/XVZ13CTMW(C)  
OWNER'S MANUAL**  
©2006 by Yamaha Motor Corporation, U.S.A.  
1st edition, May 2006  
All rights reserved.  
Any reprinting or unauthorized use  
without the written permission of  
Yamaha Motor Corporation, U.S.A.  
is expressly prohibited.  
Printed in Japan.  
P/N LIT-11626-20-23

# TABLE OF CONTENTS

<b>SAFETY INFORMATION</b> .....	1-1	Adjusting the shock absorber assembly .....	3-17	Final gear oil .....	6-15
Location of important labels .....	1-5	Sidestand .....	3-18	Coolant .....	6-16
<b>DESCRIPTION</b> .....	2-1	Ignition circuit cut-off system .....	3-19	Cleaning the air filter elements .....	6-18
Left view .....	2-1	Auxiliary DC connector .....	3-21	Carburetors .....	6-20
Right view .....	2-2	<b>PRE-OPERATION CHECKS</b> .....	4-1	Checking the throttle cable free play .....	6-20
Controls and instruments .....	2-3	Pre-operation check list .....	4-2	Valve clearance .....	6-20
<b>INSTRUMENT AND CONTROL</b>		<b>OPERATION AND IMPORTANT</b>		Tires .....	6-21
<b>FUNCTIONS</b> .....	3-1	<b>RIDING POINTS</b> .....	5-1	Cast wheels .....	6-22
Main switch/steering lock .....	3-1	Starting and warming up a cold engine .....	5-1	Accessories and replacement parts .....	6-23
Indicator and warning lights .....	3-2	Starting a warm engine .....	5-3	Clutch lever .....	6-24
Speedometer unit .....	3-3	Shifting .....	5-3	Adjusting the brake lever free play .....	6-24
Cruise control system .....	3-5	Engine break-in .....	5-4	Adjusting the rear brake light switch .....	6-25
Handlebar switches .....	3-6	Parking .....	5-5	Checking the front and rear brake pads .....	6-25
Clutch lever .....	3-7	<b>PERIODIC MAINTENANCE AND</b>		Checking the brake and clutch fluid levels .....	6-26
Shift pedal .....	3-8	<b>MINOR REPAIR</b> .....	6-1	Changing the brake and clutch fluids .....	6-27
Brake lever .....	3-8	PERIODIC MAINTENANCE .....	6-1	Checking and lubricating the cables .....	6-27
Brake pedal .....	3-8	Owner's tool kit .....	6-1	Checking and lubricating the throttle grip and cable .....	6-28
Fuel tank cap .....	3-9	Periodic maintenance chart for the emission control system .....	6-3	Checking and lubricating the brake and shift pedals .....	6-28
Fuel .....	3-9	General maintenance and lubrication chart .....	6-4	Checking and lubricating the brake and clutch levers .....	6-29
Fuel cock .....	3-10	Removing and installing cowlings and panels .....	6-8		
Starter (choke) knob .....	3-11	Checking the spark plugs .....	6-11		
Locking the steering with a padlock .....	3-12	Canister (for California only) .....	6-12		
Rider seat .....	3-12	Engine oil and oil filter cartridge ...	6-12		
Passenger backrest .....	3-13				
Helmet holder .....	3-14				
Windshield .....	3-15				
Sidescases .....	3-16				
Adjusting the front fork .....	3-17				

# TABLE OF CONTENTS

---

---

Checking and lubricating the sidestand .....	6-29
Lubricating the swingarm pivots ...	6-29
Lubricating the rear suspension ...	6-30
Checking the front fork .....	6-30
Checking the steering .....	6-31
Checking the wheel bearings .....	6-31
Battery .....	6-32
Replacing the fuses .....	6-33
Replacing the headlight bulb .....	6-35
Replacing a turn signal light bulb or the tail/brake light bulb .....	6-36
Supporting the motorcycle .....	6-37
Troubleshooting .....	6-37
Troubleshooting charts .....	6-38

## **MOTORCYCLE CARE AND**

<b>STORAGE</b> .....	7-1
Cleaning .....	7-1
Storage .....	7-2

## **SPECIFICATIONS** .....

8-1

## **CONSUMER INFORMATION**.....

Identification numbers .....	9-1
Reporting safety defects .....	9-3
Motorcycle noise regulation .....	9-4
Maintenance record .....	9-5
YAMAHA MOTOR CORPORATION, U.S.A. ROYAL STAR™ SERIES LIMITED WARRANTY .....	9-7

EAU10251

MOTORCYCLES ARE SINGLE TRACK VEHICLES. THEIR SAFE USE AND OPERATION ARE DEPENDENT UPON THE USE OF PROPER RIDING TECHNIQUES AS WELL AS THE EXPERTISE OF THE OPERATOR. EVERY OPERATOR SHOULD KNOW THE FOLLOWING REQUIREMENTS BEFORE RIDING THIS MOTORCYCLE.

HE OR SHE SHOULD:

- OBTAIN THOROUGH INSTRUCTIONS FROM A COMPETENT SOURCE ON ALL ASPECTS OF MOTORCYCLE OPERATION.
- OBSERVE THE WARNINGS AND MAINTENANCE REQUIREMENTS IN THE OWNER'S MANUAL.
- OBTAIN QUALIFIED TRAINING IN SAFE AND PROPER RIDING TECHNIQUES.
- OBTAIN PROFESSIONAL TECHNICAL SERVICE AS INDICATED BY THE OWNER'S MANUAL

AND/OR WHEN MADE NECESSARY BY MECHANICAL CONDITIONS.

### Safe riding

- Always make pre-operation checks. Careful checks may help prevent an accident.
- This motorcycle is designed to carry the operator and a passenger.
- The failure of motorists to detect and recognize motorcycles in traffic is the predominating cause of automobile/motorcycle accidents. Many accidents have been caused by an automobile driver who did not see the motorcycle. Making yourself conspicuous appears to be very effective in reducing the chance of this type of accident.

### Therefore:

- Wear a brightly colored jacket.
- Use extra caution when approaching and passing through intersections, since intersections are the most likely places for motorcycle accidents to occur.

- Ride where other motorists can see you. Avoid riding in another motorist's blind spot.
- Many motorcycle accidents involve inexperienced operators. In fact, many operators who have been involved in accidents do not even have a current motorcycle license.
- Make sure that you are qualified and that you only lend your motorcycle to other qualified operators.
- Know your skills and limits. Staying within your limits may help you to avoid an accident.
- We recommend that you practice riding your motorcycle where there is no traffic until you have become thoroughly familiar with the motorcycle and all of its controls.
- Many motorcycle accidents have been caused by error of the motorcycle operator. A typical error made by the operator is veering

# SAFETY INFORMATION

1

wide on a turn due to EXCESSIVE SPEED or undercornering (insufficient lean angle for the speed).

- Always obey the speed limit and never travel faster than warranted by road and traffic conditions.
- Always signal before turning or changing lanes. Make sure that other motorists can see you.
- The posture of the operator and passenger is important for proper control.
  - The operator should keep both hands on the handlebar and both feet on the operator footrests during operation to maintain control of the motorcycle.
  - The passenger should always hold onto the operator, seat strap, or grab bar, if equipped, with both hands and keep both feet on the passenger footrests.
  - Never carry a passenger unless he or she can firmly place both feet on the passenger footrests.
- Never ride under the influence of alcohol or other drugs.

- This motorcycle is designed for on-road use only, therefore, it is not suitable for off-road use.

## **Protective apparel**

The majority of fatalities from motorcycle accidents are the result of head injuries. The use of a safety helmet is the single most critical factor in the prevention or reduction of head injuries.

- Always wear an approved helmet.
- Wear a face shield or goggles. Wind in your unprotected eyes could contribute to an impairment of vision which could delay seeing a hazard.
- The use of a jacket, heavy boots, trousers, gloves, etc., is effective in preventing or reducing abrasions or lacerations.
- Never wear loose-fitting clothes, otherwise they could catch on the control levers, footrests, or wheels and cause injury or an accident.
- Never touch the engine or exhaust system during or after operation. They become very hot and can

cause burns. Always wear protective clothing that covers your legs, ankles, and feet.

- Passengers should also observe the precautions mentioned above.

## **Modifications**

Modifications made to this motorcycle not approved by Yamaha, or the removal of original equipment, may render the motorcycle unsafe for use and may cause severe personal injury. Modifications may also make your motorcycle illegal to use.

## **Loading and accessories**

Adding accessories or cargo to your motorcycle can adversely affect stability and handling if the weight distribution of the motorcycle is changed. To avoid the possibility of an accident, use extreme caution when adding cargo or accessories to your motorcycle. Use extra care when riding a motorcycle that has added cargo or accessories. Here are some general guidelines to follow if loading cargo or adding accessories to your motorcycle:

### Loading

The total weight of the operator, passenger, accessories and cargo must not exceed the maximum load limit.

**Maximum load:**  
201 kg (443 lb)

When loading within this weight limit, keep the following in mind:

- Cargo and accessory weight should be kept as low and close to the motorcycle as possible. Make sure to distribute the weight as evenly as possible on both sides of the motorcycle to minimize imbalance or instability.
- Shifting weights can create a sudden imbalance. Make sure that accessories and cargo are securely attached to the motorcycle before riding. Check accessory mounts and cargo restraints frequently.
- Never attach any large or heavy items to the handlebar, front fork, or front fender. These items, including such cargo as sleeping

bags, duffel bags, or tents, can create unstable handling or slow steering response.

### Accessories

Genuine Yamaha accessories have been specifically designed for use on this motorcycle. Since Yamaha cannot test all other accessories that may be available, you must personally be responsible for the proper selection, installation and use of non-Yamaha accessories. Use extreme caution when selecting and installing any accessories.

Keep the following guidelines in mind, as well as those provided under “Loading” when mounting accessories.

- Never install accessories or carry cargo that would impair the performance of your motorcycle. Carefully inspect the accessory before using it to make sure that it does not in any way reduce ground clearance or cornering clearance,

limit suspension travel, steering travel or control operation, or obscure lights or reflectors.

- Accessories fitted to the handlebar or the front fork area can create instability due to improper weight distribution or aerodynamic changes. If accessories are added to the handlebar or front fork area, they must be as lightweight as possible and should be kept to a minimum.
- Bulky or large accessories may seriously affect the stability of the motorcycle due to aerodynamic effects. Wind may attempt to lift the motorcycle, or the motorcycle may become unstable in cross winds. These accessories may also cause instability when passing or being passed by large vehicles.
- Certain accessories can displace the operator from his or her normal riding position. This improper position limits the freedom of movement of the opera-

# SAFETY INFORMATION

1

tor and may limit control ability, therefore, such accessories are not recommended.

- Use caution when adding electrical accessories. If electrical accessories exceed the capacity of the motorcycle's electrical system, an electric failure could result, which could cause a dangerous loss of lights or engine power.

## **Gasoline and exhaust gas**

- **GASOLINE IS HIGHLY FLAMMABLE:**
  - Always turn the engine off when refueling.
  - Take care not to spill any gasoline on the engine or exhaust system when refueling.
  - Never refuel while smoking or in the vicinity of an open flame.
- Never start the engine or let it run for any length of time in a closed area. The exhaust fumes are poisonous and may cause loss of consciousness and death within a short time. Always operate your motorcycle in an area that has adequate ventilation.

- Always turn the engine off before leaving the motorcycle unattended and remove the key from the main switch. When parking the motorcycle, note the following:
  - The engine and exhaust system may be hot, therefore, park the motorcycle in a place where pedestrians or children are not likely to touch these hot areas.
  - Do not park the motorcycle on a slope or soft ground, otherwise it may fall over.
  - Do not park the motorcycle near a flammable source (e.g. a kerosene heater, or near an open flame), otherwise it could catch fire.
- When transporting the motorcycle in another vehicle, make sure that it is kept upright and that the fuel cock is turned to "ON" or "RES" (for vacuum type) / "OFF" (for manual type). If it should lean over, gasoline may leak out of the carburetor or fuel tank.
- If you should swallow any gasoline, inhale a lot of gasoline vapor, or allow gasoline to get into your

eyes, see your doctor immediately. If any gasoline spills on your skin or clothing, immediately wash the affected area with soap and water and change your clothes.

## Location of important labels

Please read the following important labels carefully before operating this vehicle.

1

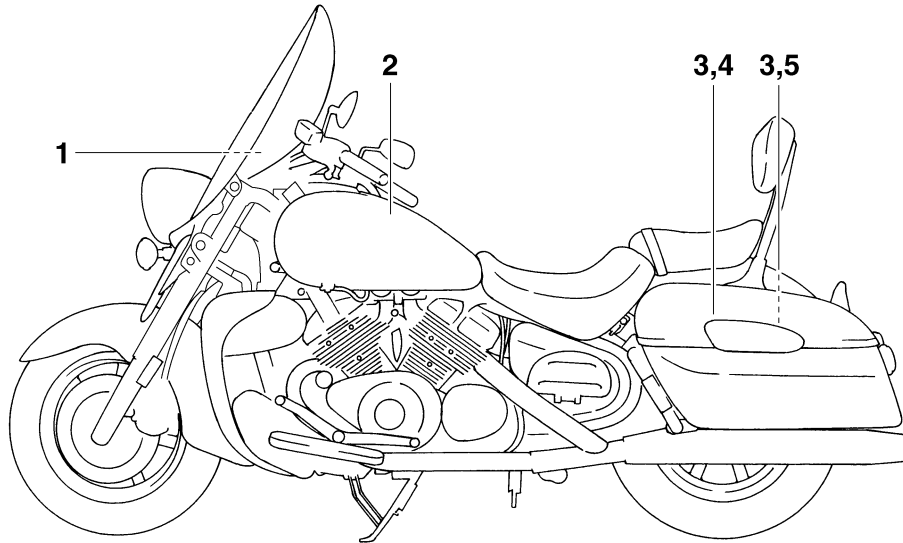

# SAFETY INFORMATION

1

**1**

**CAUTION**

- Cleaning with alkaline or acid cleaner, gasoline or solvent will damage windshield.
- Use neutral detergent.

5JW-00  
(5JW-2835Y-00)

2

**WARNING**

- **BEFORE YOU OPERATE THIS VEHICLE, READ THE OWNER'S MANUAL AND ALL LABELS.**
- **ALWAYS WEAR AN APPROVED MOTORCYCLE HELMET, eye protection, and protective clothing.**

5GK-2118K-00

3

**WARNING**

Improper loading can adversely affect handling.

- Do not exceed maximum load limit : 9 kg (20lb) each saddlebag.
- Distribute weight evenly from side to side.
- Read the Owner's manual for important loading and tire pressure information.
- Total weight of rider, passenger, accessories, and cargo must not exceed the motorcycle load capacity shown in the Owner's Manual.
- Never ride above 120km/h (80 mph) with saddlebags because handling could be affected. This maximum speed may be reduced by such factors as improper loading, poor tire or overall motorcycle conditions, poor road surfaces, or adverse weather conditions.

1DE-28446-00

4

**TIRE INFORMATION**

Cold tire normal pressure should be set as follows.

- Up to 90 kg (198 lbs) load

**FRONT** : 250 kPa, (2.50 kgf/cm<sup>2</sup>), 36 psi  
**REAR** : 250 kPa, (2.50 kgf/cm<sup>2</sup>), 36 psi

- 90 kg (198 lbs) ~ maximum load

**FRONT** : 250 kPa, (2.50 kgf/cm<sup>2</sup>), 36 psi  
**REAR** : 280 kPa, (2.80 kgf/cm<sup>2</sup>), 41 psi

4NK-21668-A0

## 5 CALIFORNIA ONLY

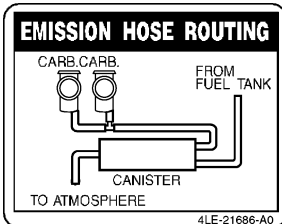

## Left view

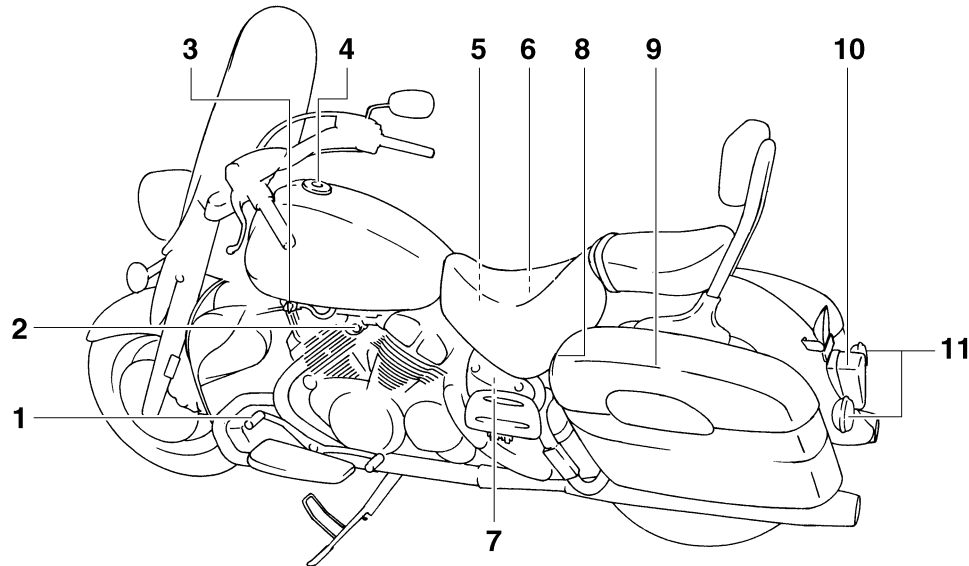

1. Shift pedal (page 3-8)
2. Starter (choke) knob (page 3-11)
3. Fuel cock (page 3-10)
4. Fuel tank cap (page 3-9)
5. Battery (page 6-32)
6. Coolant reservoir (page 6-16)
7. Fuse box 2 (page 6-33)
8. Helmet holder (page 3-14)

9. Sidecase (page 3-16)
10. Tail/brake light (page 6-36)
11. Rear turn signal light (page 6-36)

# DESCRIPTION

EAU10420

## Right view

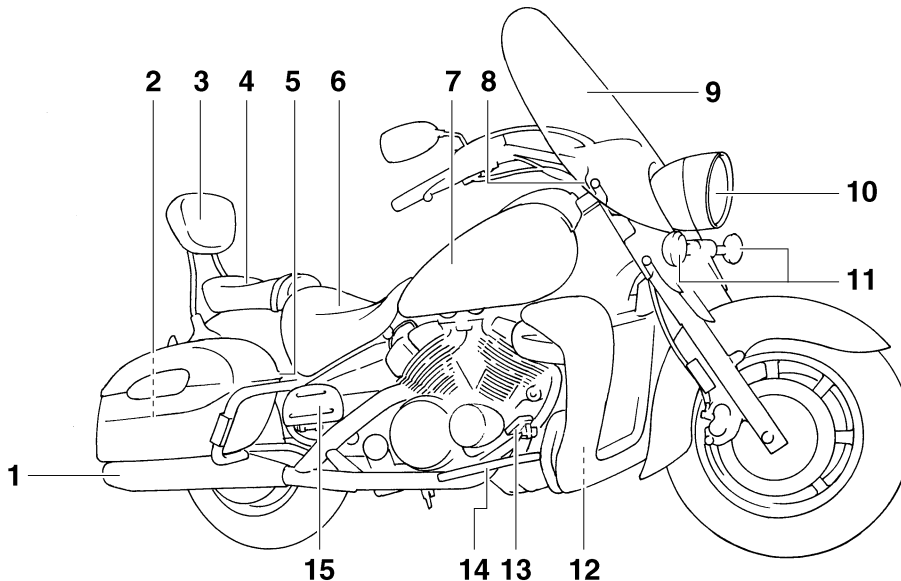

2

- |                                                  |                                                   |
|--------------------------------------------------|---------------------------------------------------|
| 1. Muffler                                       | 9. Windshield (page 3-15)                         |
| 2. Owner's tool kit (page 6-1)                   | 10. Headlight (page 6-35)                         |
| 3. Passenger backrest (page 3-13)                | 11. Front turn signal/position lights (page 6-36) |
| 4. Passenger seat (page 3-12)                    | 12. Fuse box 1 (page 6-33)                        |
| 5. Shock absorber assembly air valve (page 3-17) | 13. Brake pedal (page 3-8)                        |
| 6. Rider seat (page 3-12)                        | 14. Rider footrest                                |
| 7. Fuel tank (page 3-9)                          | 15. Passenger footrest                            |
| 8. Front fork air valve (page 3-17)              |                                                   |

## Controls and instruments

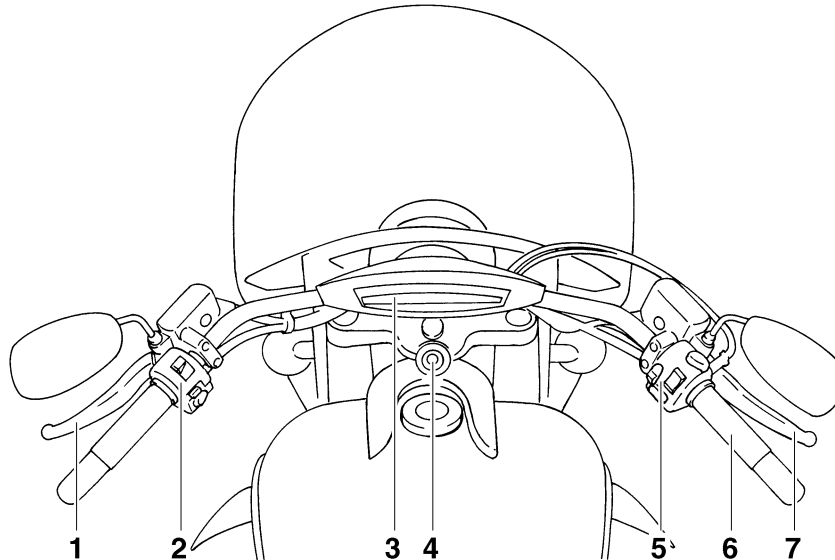

1. Clutch lever (page 3-7)
2. Left handlebar switches (page 3-6)
3. Speedometer unit (page 3-3)
4. Main switch/steering lock (page 3-1)
5. Right handlebar switches (page 3-6)
6. Throttle grip (page 6-20)
7. Brake lever (page 3-8)

# INSTRUMENT AND CONTROL FUNCTIONS

## Main switch/steering lock

EAU10460

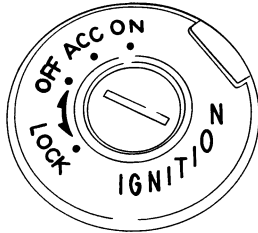

The main switch/steering lock controls the ignition and lighting systems, and is used to lock the steering. The various positions are described below.

### ON

EAU10510

All electrical systems are supplied with power, and the headlight, meter lighting, taillight and position lights come on, and the engine can be started. The key cannot be removed.

### OFF

EAU10660

All electrical systems are off. The key can be removed.

### LOCK

EAU10690

The steering is locked, and all electrical systems are off. The key can be removed.

### To lock the steering

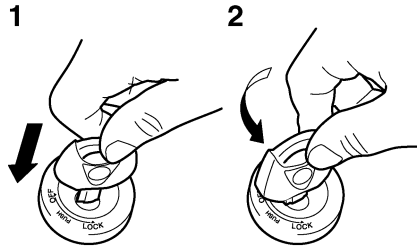

1. Push.
2. Turn.

1. Turn the handlebars all the way to the left or right.
2. Push the key in from the “OFF” position, and then turn it to “LOCK” while still pushing it.
3. Remove the key.

### To unlock the steering

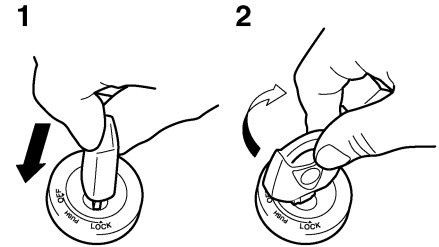

1. Push.
2. Turn.

Push the key into the main switch, and then turn it to “OFF” while still pushing it.

### **⚠ WARNING**

EWA10060

**Never turn the key to “OFF” or “LOCK” while the vehicle is moving, otherwise the electrical systems will be switched off, which may result in loss of control or an accident. Make sure that the vehicle is stopped before turning the key to “OFF” or “LOCK”.**

# INSTRUMENT AND CONTROL FUNCTIONS

## ACC (Accessory)

The auxiliary DC connector can be used in this position. Do not use the accessory position for an extended period of time, otherwise the battery may discharge.





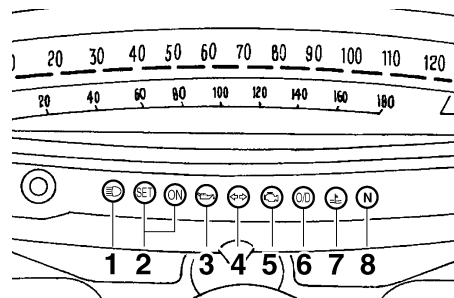

The key cannot be removed.

EAU35141

## Indicator and warning lights



EAU11003

1. High beam indicator light “”
2. Cruise control indicator lights
3. Oil level warning light “”
4. Turn signal indicator light “ ”
5. Engine trouble warning light “”
6. Overdrive indicator light “O/D”
7. Coolant temperature warning light “”
8. Neutral indicator light “N”

## Turn signal indicator light “ ”

EAU11020

This indicator light flashes when the turn signal switch is pushed to the left or right.

## Neutral indicator light “N”

EAU11060

This indicator light comes on when the transmission is in the neutral position.

## High beam indicator light “”

EAU11080

This indicator light comes on when the high beam of the headlight is switched on.

## Oil level warning light “”

EAU1120

This warning light comes on when the engine oil level is low.

The electrical circuit of the warning light can be checked by turning the key to “ON”.

If the warning light does not come on for a few seconds, then go off, have a Yamaha dealer check the electrical circuit.

## NOTE: \_\_\_\_\_

Even if the oil level is sufficient, the warning light may flicker when riding on a slope or during sudden acceleration or deceleration, but this is not a malfunction.

## Cruise control indicator lights

EAU11380

See page 3-5 for an explanation of these indicator lights.

# INSTRUMENT AND CONTROL FUNCTIONS

3

## Coolant temperature warning light “”

EAU11440

This warning light comes on when the engine overheats. When this occurs, stop the engine immediately and allow the engine to cool.

The electrical circuit of the warning light can be checked by turning the key to “ON”.

If the warning light does not come on for a few seconds, then go off, have a Yamaha dealer check the electrical circuit.

ECA10020

### CAUTION:

**Do not operate the engine if it is overheated.**

## Overdrive indicator light “”

EAU11450

This indicator light comes on when the transmission is in overdrive (5th gear).

## Engine trouble warning light “”

EAU11480

This warning light comes on when an electrical circuit monitoring the engine is defective. When this occurs, have a Yamaha dealer check the self-diagnosis system.

The electrical circuit of the warning light can be checked by turning the key to “ON”. If the warning light does not come on for a few seconds, then go off, have a Yamaha dealer check the electrical circuit.

## Speedometer unit

EAU35151

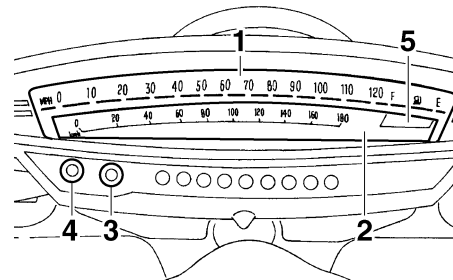

1. Speedometer
2. Odometer/tripmeter/fuel reserve tripmeter/clock
3. “RESET” button
4. “SELECT” button
5. Fuel meter

The speedometer unit is equipped with the following:

- a digital speedometer (which shows riding speed)
- an odometer (which shows the total distance traveled)
- two tripmeters (which show the distance traveled since they were last set to zero)
- a fuel reserve tripmeter (which shows the distance traveled on the fuel reserve)

- a clock
- a fuel meter

## Odometer and tripmeter modes

Pushing the “SELECT” button switches the display between the odometer mode “ODO” and the tripmeter modes “TRIP 1” and “TRIP 2” in the following order:

ODO → TRIP 1 → TRIP 2 → ODO

If the fuel level warning light comes on (see page 3-2), the odometer display will automatically change to the fuel reserve tripmeter mode “TRIP F” and start counting the distance traveled from that point. In that case, pushing the “SELECT” button switches the display between the various tripmeter and odometer modes in the following order: TRIP F → TRIP 1 → TRIP 2 → ODO → TRIP F

To reset a tripmeter, select it by pushing the “SELECT” button, and then push the “RESET” button. If you do not reset the fuel reserve tripmeter manually, it will reset itself automatically and the display will return to “TRIP 1” after refueling and traveling 5 km (3 mi).

**NOTE:** \_\_\_\_\_  
After resetting the fuel reserve tripmeter, the display will return to the prior mode.

## Clock mode

To change the display to the clock mode, push the “SELECT” button for at least two seconds.

To change the display back to the odometer and tripmeter modes, push the “SELECT” button.

### To set the clock:

1. Push both the “SELECT” and “RESET” buttons for at least two seconds.
2. When the hour digits start flashing, push the “RESET” button to set the hours.
3. Push the “SELECT” button, and the minute digits will start flashing.
4. Push the “RESET” button to set the minutes.
5. Push the “SELECT” button to start the clock.

**NOTE:** \_\_\_\_\_  
After setting the clock, be sure to push the “SELECT” button before turning the key to “OFF”, otherwise the clock will not be set.

## Fuel meter

The fuel meter indicates the amount of fuel in the fuel tank. The display segments of the fuel meter disappear towards “E” (Empty) as the fuel level decreases. When the last segment on the right starts flashing, refuel as soon as possible. When the key is turned to “ON”, all of the display segments of the fuel meter will appear one after the other and then disappear in order to test the electrical circuit.

**NOTE:** \_\_\_\_\_  
This fuel meter is equipped with a self-diagnosis system. If the electrical circuit is defective, all the display segments will start flashing. If this occurs, have a Yamaha dealer check the electrical circuit.

# INSTRUMENT AND CONTROL FUNCTIONS

EAU35161

## Cruise control system

This model is equipped with a cruise control system designed to maintain a set traveling speed.

### Activating and setting the cruise control system

The cruise control system can only be activated when riding in 4th or 5th gear at speeds between 50 km/h (30 mi/h) and 130 km/h (80 mi/h).

#### To activate and set the cruise control system:

1. Push the “CRUISE” switch to the “ACT” (activate) position and then release the switch. The “ON” indicator light will come on.

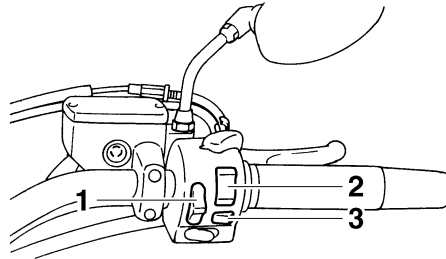

1. “CRUISE” switch
2. Cruise control switch
3. “CANCEL” switch

2. Press the “SET/DEC” (set/decelerate) side of the cruise control switch to activate the cruise control system. The “SET” indicator light comes on.
3. Set the desired traveling speed as follows. Press the “RES/ACC” (resume/accelerate) side of the cruise control switch to increase the set speed or the “SET/DEC” side to decrease the speed.

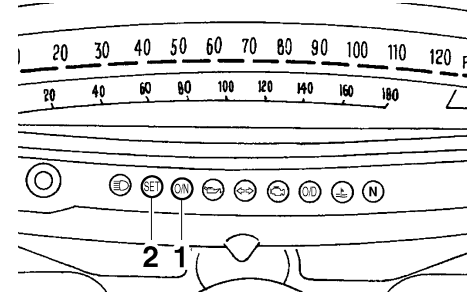

1. “ON” indicator light
2. “SET” indicator light

#### **NOTE:**

Pressing the cruise control switch once will change the speed in increments of 1.6 km/h (1 mi/h). Holding the cruise control switch down will increase or decrease the speed continuously until the switch is released.

The traveling speed can be set to a maximum of 130 km/h (80 mi/h) and a minimum of 50 km/h (30 mi/h).

When the cruise control system is activated and the throttle grip is turned to increase the speed by up to 8 km/h (5 mi/h), the cruise control system will return to the set speed after the throttle grip is released. However, if the speed

# INSTRUMENT AND CONTROL FUNCTIONS

EAU12345

is increased by more than 8 km/h (5 mi/h), the cruise control system will be deactivated until the traveling speed is within 8 km/h (5 mi/h) of the set speed.

## Deactivating the cruise control system

Applying the front or rear brake or disengaging the clutch will automatically deactivate the cruise control system. Push the “CANCEL” switch to manually deactivate the cruise control system. The “SET” indicator light will go off.

## NOTE:

Traveling speed decreases as soon as the cruise control system is deactivated; unless the throttle grip is turned.

Push the “RES/ACC” side of the cruise control switch to reactivate the system. The traveling speed will return to the previously set speed. Once the cruise control system is reactivated, the “SET” indicator light will come on.

Push the “CRUISE” switch to the “OFF” position to completely cancel the cruise control system. The “ON” indicator light will go off until the cruise control system is activated again.

## NOTE:

Even if the “CRUISE” switch is in the “ON” position, turning the main switch to “OFF” when the vehicle is stopped will also completely cancel the cruise control system.

## WARNING



EWA12550

**If the cruise control system is defective, the “SET” indicator light will flash. If this occurs, turn the cruise control system off and have a Yamaha dealer check the electrical system.**

## Handlebar switches

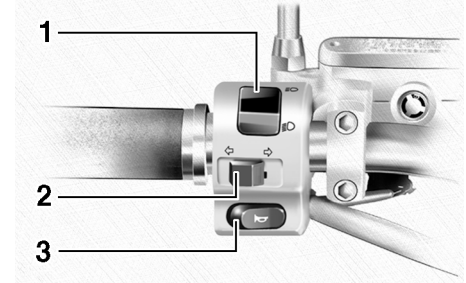

### Left

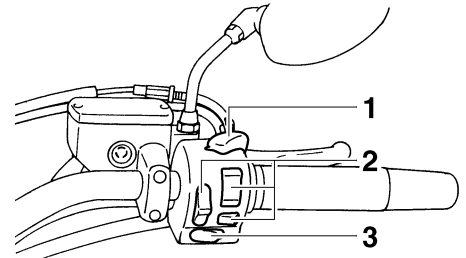

1. Dimmer switch “/”
2. Turn signal switch “/”
3. Horn switch “”

### Right





1. Engine stop switch “/”
2. Cruise control switches
3. Start switch “”

# INSTRUMENT AND CONTROL FUNCTIONS



## Dimmer switch “/”

EAU12400

Set this switch to “” for the high beam and to “” for the low beam.

## Turn signal switch “/”

EAU12430

To signal a right-hand turn, push this switch to “”. To signal a left-hand turn, push this switch to “”. When released, the switch returns to the center position.

Since this model is equipped with a self-canceling system, the turn signal lights will self-cancel after the vehicle has traveled both about 150 m (490 ft) and for approximately 15 seconds. However, the turn signal lights can also be canceled manually by pushing the switch in after it has returned to the center position.

## NOTE: \_\_\_\_\_

The self-canceling system only operates when the vehicle is moving, so that the turn signal lights will not self-cancel while you are stopped at an intersection.



## Horn switch “”

EAU12500

Press this switch to sound the horn.

## Engine stop switch “/”

EAU12660

Set this switch to “” before starting the engine. Set this switch to “” to stop the engine in case of an emergency, such as when the vehicle overturns or when the throttle cable is stuck.

## Start switch “”

EAU12710

Push this switch to crank the engine with the starter.

## CAUTION: \_\_\_\_\_

**See page 5-1 for starting instructions prior to starting the engine.**

ECA10050

## Cruise control switches

EAU12780

See page 3-5 for an explanation of the cruise control system.

## Clutch lever

EAU12820

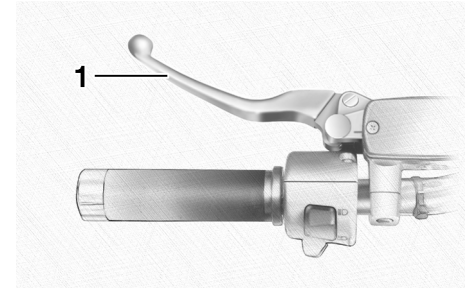

1. Clutch lever

The clutch lever is located at the left handlebar grip. To disengage the clutch, pull the lever toward the handlebar grip. To engage the clutch, release the lever. The lever should be pulled rapidly and released slowly for smooth clutch operation.

The clutch lever is equipped with a clutch switch, which is part of the ignition circuit cut-off system. (See page 3-19.)

# INSTRUMENT AND CONTROL FUNCTIONS

## Shift pedal

EAU12880

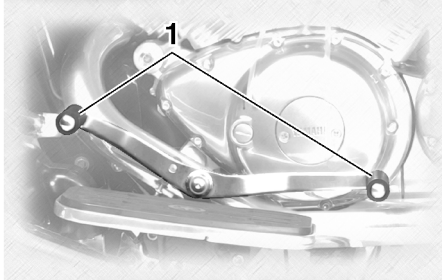

1. Shift pedal

The shift pedal is located on the left side of the engine and is used in combination with the clutch lever when shifting the gears of the 5-speed constant-mesh transmission equipped on this motorcycle.

**NOTE:** \_\_\_\_\_  
Use your toes or heel to shift up and your toes to shift down.  
\_\_\_\_\_

## Brake lever

EAU12890



1. Brake lever

The brake lever is located at the right handlebar grip. To apply the front brake, pull the lever toward the handlebar grip.

## Brake pedal

EAU12941

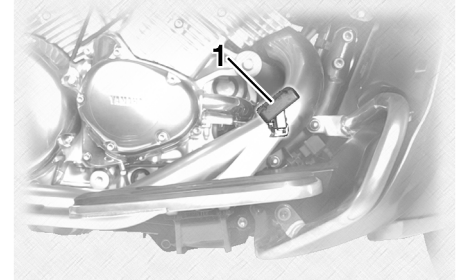

1. Brake pedal

The brake pedal is on the right side of the motorcycle. To apply the rear brake, press down on the brake pedal.

# INSTRUMENT AND CONTROL FUNCTIONS

## Fuel tank cap

EAU13120

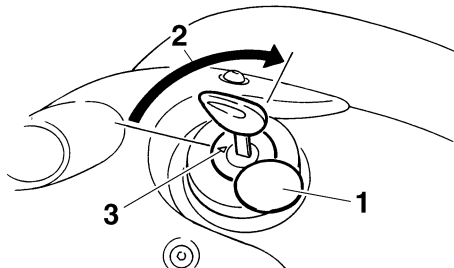

1. Fuel tank cap lock cover
2. Unlock.
3. “△” mark

### To remove the fuel tank cap

Slide the lock cover open, insert the key into the lock, and then turn it 1/4 turn clockwise. The lock will be released and the fuel tank cap can be removed.

### To install the fuel tank cap

1. Insert the fuel tank cap into the tank opening with the key inserted in the lock and with the “△” mark facing forward.
2. Turn the key counterclockwise to the original position, remove it, and then close the lock cover.

### NOTE: \_\_\_\_\_

The fuel tank cap cannot be installed unless the key is in the lock. In addition, the key cannot be removed if the cap is not properly installed and locked.

EWA10130



**WARNING** \_\_\_\_\_  
**Make sure that the fuel tank cap is properly installed before riding.**

## Fuel

EAU13211

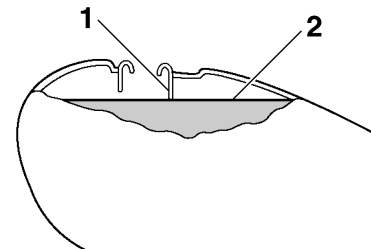

1. Fuel tank filler tube
2. Fuel level

Make sure that there is sufficient fuel in the tank. Fill the fuel tank to the bottom of the filler tube as shown.

EWA10880



- WARNING** \_\_\_\_\_
- Do not overfill the fuel tank, otherwise it may overflow when the fuel warms up and expands.
  - Avoid spilling fuel on the hot engine.

ECA10070

## CAUTION:

**Immediately wipe off spilled fuel with a clean, dry, soft cloth, since fuel may deteriorate painted surfaces or plastic parts.**

EAU13300

### Recommended fuel:

UNLEADED GASOLINE ONLY

### Fuel tank capacity:

20.0 L (5.28 US gal) (4.40 Imp.gal)

### Fuel reserve amount:

3.9 L (1.03 US gal) (0.86 Imp.gal)

ECA11400

## CAUTION:

**Use only unleaded gasoline. The use of leaded gasoline will cause severe damage to internal engine parts, such as the valves and piston rings, as well as to the exhaust system.**

Your Yamaha engine has been designed to use regular unleaded gasoline with a pump octane number [(R+M)/2] of 86 or higher, or a research octane number of 91 or higher. If

knocking (or pinging) occurs, use a gasoline of a different brand or premium unleaded fuel. Use of unleaded fuel will extend spark plug life and reduce maintenance costs.

### Gasohol

There are two types of gasohol: gasohol containing ethanol and that containing methanol. Gasohol containing ethanol can be used if the ethanol content does not exceed 10%. Gasohol containing methanol is not recommended by Yamaha because it can cause damage to the fuel system or vehicle performance problems.

EAU13550

## Fuel cock

The fuel cock supplies fuel from the tank to the carburetors while also filtering it.

The fuel cock lever positions are explained as follows and shown in the illustrations.

## OFF

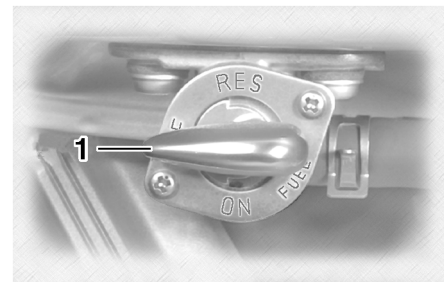

1. Pointed end positioned over "OFF"

With the fuel cock lever in this position, fuel will not flow. Always turn the fuel cock lever to this position when the engine is not running.

# INSTRUMENT AND CONTROL FUNCTIONS

## ON

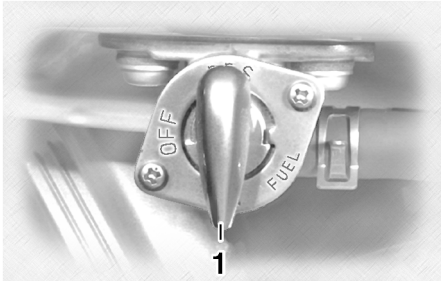

1. Pointed end positioned over "ON"

With the fuel cock lever in this position, fuel flows to the carburetors. Turn the fuel cock lever to this position when starting the engine and riding.

## RES

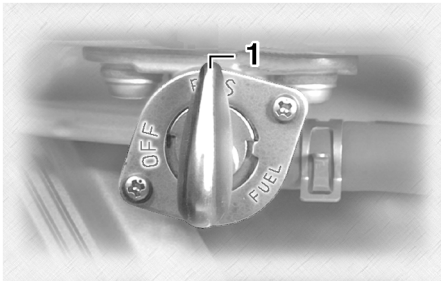

1. Pointed end positioned over "RES"

This indicates reserve. With the fuel cock lever in this position, the fuel reserve is made available. Turn the fuel cock lever to this position if you run out of fuel while riding. When this occurs, refuel as soon as possible and be sure to turn the fuel cock lever back to "ON"!

## Starter (choke) knob " |>| " EAU13600

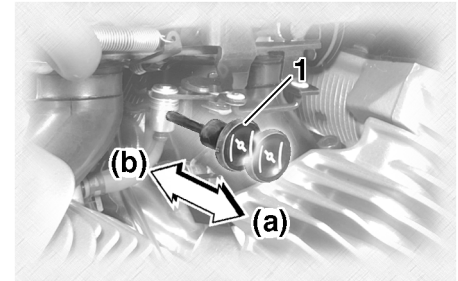

1. Starter (choke) knob " |>| "

Starting a cold engine requires a richer air-fuel mixture, which is supplied by the starter (choke).

Move the knob in direction (a) to turn on the starter (choke).

Move the knob in direction (b) to turn off the starter (choke).

## Locking the steering with a padlock

EAU13780



In addition to the main switch/steering lock, there are brackets on the right side of the steering head pipe for locking the steering with a padlock. To do so, turn the handlebar until the holes in the two brackets are aligned, and then lock the steering with a suitable padlock.

## Rider seat

EAU35170

### To remove the rider seat

Remove the bolts, and then pull the rider seat up.

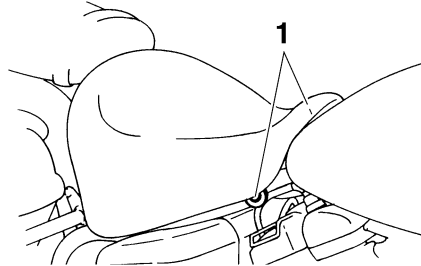

1. Bolt

### To install the rider seat

Insert the projection on the rear of the rider seat into the seat holder as shown, place the seat in the original position, and then tighten the bolts.

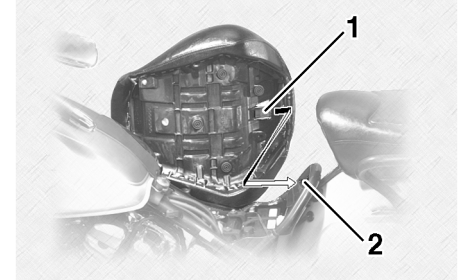

1. Projection
2. Seat holder

### NOTE:

Make sure that the rider seat is properly secured before riding.

# INSTRUMENT AND CONTROL FUNCTIONS

EAU35791

## Passenger backrest

### To remove the backrest

1. Push the lever on each side of the backrest downward.

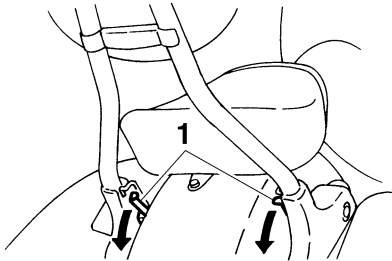

1. Backrest lever

2. Push the backrest forward until it stops, then lift it upward and remove it by pulling it to the rear as shown.

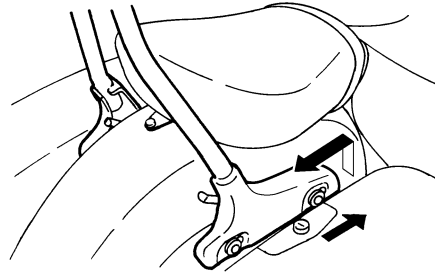

### To install the backrest

Place the backrest in the original position, then pull it backward until it stops and the levers snap locking it into place.

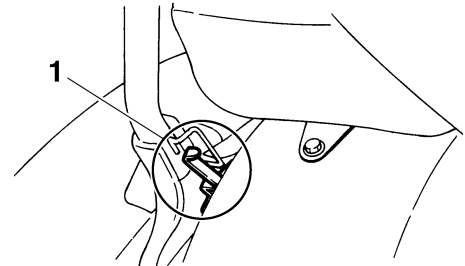
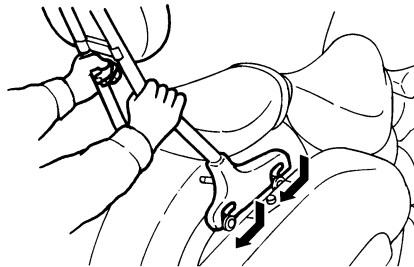

1. Locked position

EWA12561

### **⚠ WARNING**

**A loose backrest could cause an accident.**

**After installing the backrest, check that both levers are fully locked into place.**

## Helmet holder

A helmet holding cable is provided in the left sidecase to secure a helmet to the helmet holder.

### To secure a helmet to the helmet holder

1. To open the helmet holder, insert the key into the helmet holder lock, and then turn the key as shown.

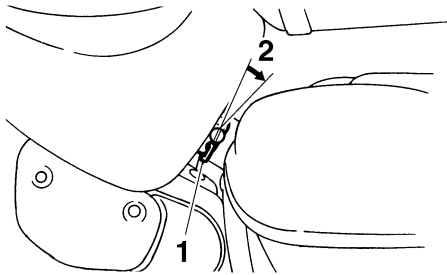

1. Helmet holder
2. Unlock.

2. Remove the helmet holding cable from the left sidecase. (See page 3-16.)

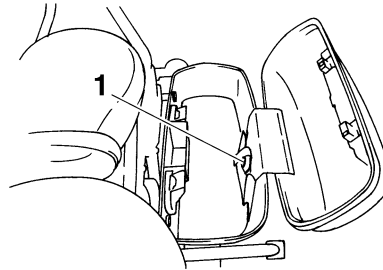

1. Helmet holding cable
3. Pass the helmet holding cable through the buckle on the helmet strap, and then hook the cable loops over the helmet holder.
4. Place the helmet holder in the original position, and then remove the key.

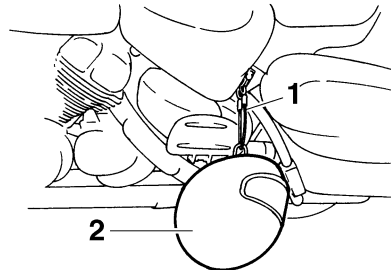

1. Helmet holding cable
2. Helmet

## WARNING

Never ride with a helmet attached to a helmet holder, since the helmet may hit objects, causing loss of control and possibly an accident.

### To release the helmet from the helmet holder

1. Open the helmet holder, remove the helmet holding cable from the helmet holder and the helmet, and then close the helmet holder.
2. Place the helmet holding cable in the left sidecase.

# INSTRUMENT AND CONTROL FUNCTIONS

EAU35221

## Windshield

### To remove the windshield

1. Push the lever on each side of the windshield forward.

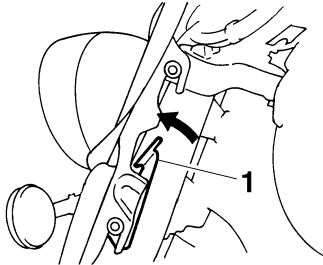

1. Windshield lever

2. To remove the windshield, pull it upward as shown.

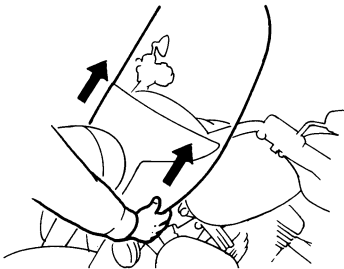

### To install the windshield

1. Place the windshield in the original position as shown.

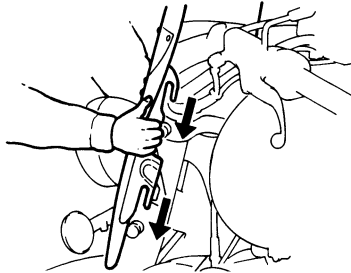

2. Push the lever on each side of the windshield backward onto its fastener to lock it into place.

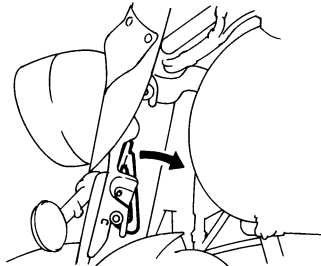

EWA12541

## **! WARNING**

A loose windshield could cause an accident.

- Be sure the slot in each lever is securely fitted onto its fastener.
- Be sure to pull both levers fully backward to lock the windshield into place.

## Sidecases

EAU35210

EWA12520

### WARNING

Improper loading or overloading can cause loss of control and possibly an accident or personal injury. See pages 1-5 and 6-21 for important loading and tire pressure information.

- Always securely close the sidecases before riding.
- Distribute weight evenly on each side of the motorcycle.
- Do not exceed the load limit of 9 kg (20 lb) for each sidecase.
- Do not exceed the maximum load of 201 kg (443 lb) for the vehicle.
- Do not exceed 120 km/h (80 mi/h) when riding with luggage in the sidecases, otherwise handling could be affected. Improper loading, poor tire or overall motorcycle conditions, poor road surfaces or adverse weather conditions may make it necessary to further reduce the riding speed.

### To open a sidecase

1. Insert the key into the lock, turn it counterclockwise, and then push it in.

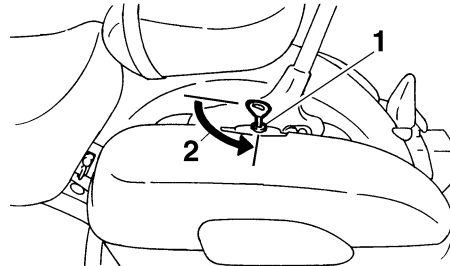

1. Sidecase lock
2. Unlock.

2. Fold the sidecase lid up.

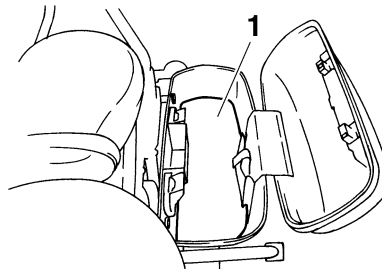

1. Storage compartment

### To close a sidecase

1. Fold the sidecase lid down.
2. Turn the key clockwise, and then remove it.

### NOTE:

Push both sides of the lid down so that both latches snap into place.

ECA13090

### CAUTION:

To avoid locking the key in, never lock either sidecase and remove the key from the lock before closing the lid.

# INSTRUMENT AND CONTROL FUNCTIONS

## Adjusting the front fork

EAU14651

This front fork is equipped with air valves for adjusting the spring rate.

EWA10180

### **WARNING**

**Always adjust both fork legs equally, otherwise poor handling and loss of stability may result.**

3

Adjust the spring rate as follows.

1. Place the vehicle on the sidestand.

### **NOTE:**

When checking and adjusting the air pressure, there should be no weight on the vehicle.

2. Remove the air valve cap from each fork leg.

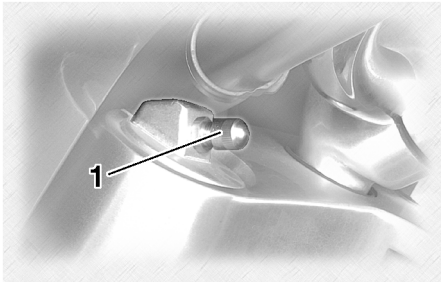

1. Front fork air valve cap

3. Check the air pressure in each fork leg using a low-pressure air gauge. A low-pressure air gauge is available at a Yamaha dealer.
4. To increase the spring rate and thereby harden the suspension, increase the air pressure with an air pump. To decrease the spring rate and thereby soften the suspension, decrease the air pressure by pushing each valve stem down.

### **Spring rate:**

Minimum (soft):

Air pressure = 0 kPa (0 psi) (0 kgf/cm<sup>2</sup>)

Standard:

Air pressure = 0 kPa (0 psi) (0 kgf/cm<sup>2</sup>)

Maximum (hard):

Air pressure = 50 kPa (7.1 psi) (0.5 kgf/cm<sup>2</sup>)

ECA10090

### **CAUTION:**

**Never exceed the maximum air pressure, otherwise the front fork oil seals may become damaged.**

5. Securely install the air valve caps.

## Adjusting the shock absorber assembly

EAU14800

This shock absorber assembly is equipped with an air valve for adjusting the spring rate.

ECA10100

### **CAUTION:**

**Never attempt to turn an adjusting mechanism beyond the maximum or minimum settings.**

Adjust the spring rate as follows.

1. Place the vehicle on the sidestand.

### **NOTE:**

When checking and adjusting the air pressure, there should be no weight on the vehicle.

2. Remove the air valve cap.

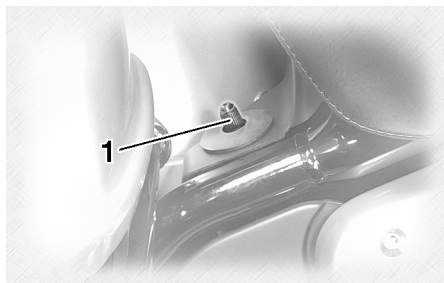

1. Shock absorber assembly air valve cap

3. Check the air pressure with the air pressure gauge included in the owner's tool kit.
4. To increase the spring rate and thereby harden the suspension, increase the air pressure with an air pump. To decrease the spring rate and thereby soften the suspension, decrease the air pressure by pushing the valve stem down.

## Spring rate:

Minimum (soft):

Air pressure = 0 kPa (0 psi) (0 kgf/cm<sup>2</sup>)

Standard:

Air pressure = 0 kPa (0 psi) (0 kgf/cm<sup>2</sup>)

Maximum (hard):

Air pressure = 400 kPa (57 psi) (4.0 kgf/cm<sup>2</sup>)

ECA11090

## CAUTION:

**Never exceed the maximum air pressure, otherwise the oil seal may become damaged.**

5. Securely install the air valve cap.

## Sidestand

The sidestand is located on the left side of the frame. Raise the sidestand or lower it with your foot while holding the vehicle upright.

## NOTE:

The built-in sidestand switch is part of the ignition circuit cut-off system, which cuts the ignition in certain situations. (See further down for an explanation of the ignition circuit cut-off system.)

EWA10240

## WARNING

**The vehicle must not be ridden with the sidestand down, or if the sidestand cannot be properly moved up (or does not stay up), otherwise the sidestand could contact the ground and distract the operator, resulting in a possible loss of control. Yamaha's ignition circuit cut-off system has been designed to assist the operator in fulfilling the responsibility of raising the sidestand before starting off. Therefore, check this system regularly as described**

# INSTRUMENT AND CONTROL FUNCTIONS

---

below and have a Yamaha dealer repair it if it does not function properly.

---

3

EAU15311

## Ignition circuit cut-off system

The ignition circuit cut-off system (comprising the sidestand switch, clutch switch and neutral switch) has the following functions.

- It prevents starting when the transmission is in gear and the sidestand is up, but the clutch lever is not pulled.
- It prevents starting when the transmission is in gear and the clutch lever is pulled, but the sidestand is still down.
- It cuts the running engine when the transmission is in gear and the sidestand is moved down.

Periodically check the operation of the ignition circuit cut-off system according to the following procedure.

EWA10250



**If a malfunction is noted, have a Yamaha dealer check the system before riding.**

---

# INSTRUMENT AND CONTROL FUNCTIONS

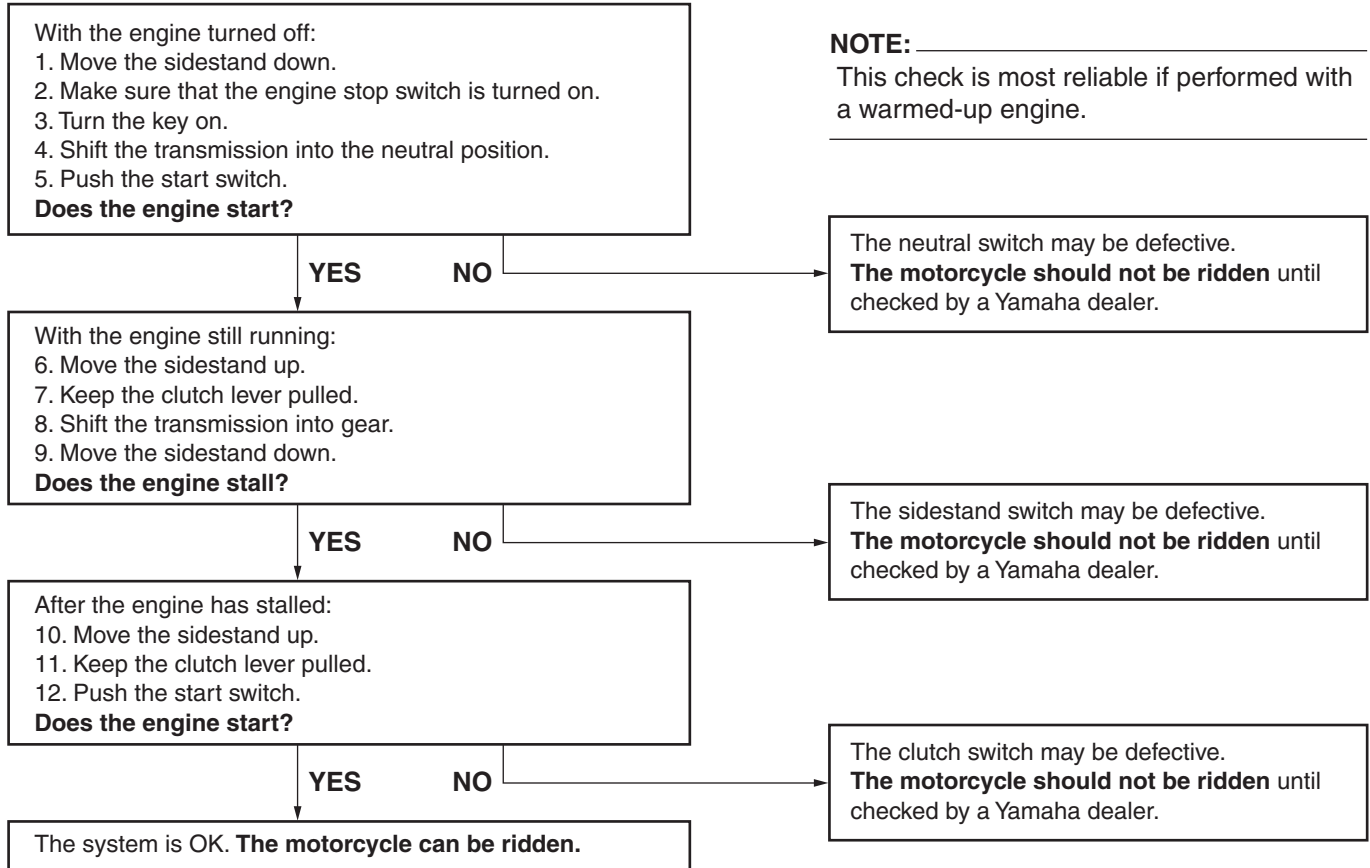

# INSTRUMENT AND CONTROL FUNCTIONS

---

## Auxiliary DC connector

EAU35201

EWA12531

3

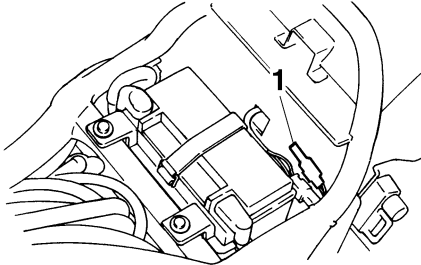

### **WARNING**

To prevent electrical shock or short-circuiting, make sure that the cap is installed when the auxiliary DC connector is not being used.

---

### 1. Auxiliary DC connector

A 12-V accessory connected to the auxiliary DC connector under the rider seat can be used when the key is in the “ACC” or “ON” position.

ECA13101

### **CAUTION:**

The accessory connected to the auxiliary DC connector should not be used with the engine turned off, and the load must never exceed 5 A or 60 W, otherwise the battery may discharge.

---

# PRE-OPERATION CHECKS

---

---

EAU15591

The condition of a vehicle is the owner's responsibility. Vital components can start to deteriorate quickly and unexpectedly, even if the vehicle remains unused (for example, as a result of exposure to the elements). Any damage, fluid leakage or loss of tire air pressure could have serious consequences. Therefore, it is very important, in addition to a thorough visual inspection, to check the following points before each ride.

**NOTE:** \_\_\_\_\_

Pre-operation checks should be made each time the vehicle is used. Such an inspection can be accomplished in a very short time; and the added safety it assures is more than worth the time involved.

---

EWA11150



**If any item in the Pre-operation check list is not working properly, have it inspected and repaired before operating the vehicle.**

---

# PRE-OPERATION CHECKS

EAU15605

## Pre-operation check list

ITEM	CHECKS	PAGE
<b>Fuel</b>	<ul style="list-style-type: none"><li>• Check fuel level in fuel tank.</li><li>• Refuel if necessary.</li><li>• Check fuel line for leakage.</li></ul>	3-9
<b>Engine oil</b>	<ul style="list-style-type: none"><li>• Check oil level in engine.</li><li>• If necessary, add recommended oil to specified level.</li><li>• Check vehicle for oil leakage.</li></ul>	6-12
<b>Final gear oil</b>	<ul style="list-style-type: none"><li>• Check vehicle for oil leakage.</li></ul>	6-15
<b>Coolant</b>	<ul style="list-style-type: none"><li>• Check coolant level in reservoir.</li><li>• If necessary, add recommended coolant to specified level.</li><li>• Check cooling system for leakage.</li></ul>	6-16
<b>Front brake</b>	<ul style="list-style-type: none"><li>• Check operation.</li><li>• If soft or spongy, have Yamaha dealer bleed hydraulic system.</li><li>• Check lever free play.</li><li>• Adjust if necessary.</li><li>• Check brake pads for wear.</li><li>• Replace if necessary.</li><li>• Check fluid level in reservoir.</li><li>• If necessary, add recommended brake fluid to specified level.</li><li>• Check hydraulic system for leakage.</li></ul>	6-24, 6-25, 6-26
<b>Rear brake</b>	<ul style="list-style-type: none"><li>• Check operation.</li><li>• If soft or spongy, have Yamaha dealer bleed hydraulic system.</li><li>• Check brake pads for wear.</li><li>• Replace if necessary.</li><li>• Check fluid level in reservoir.</li><li>• If necessary, add recommended brake fluid to specified level.</li><li>• Check hydraulic system for leakage.</li></ul>	6-25, 6-26

4

# PRE-OPERATION CHECKS

ITEM	CHECKS	PAGE
<b>Clutch</b>	<ul style="list-style-type: none"> <li>• Check operation.</li> <li>• If soft or spongy, have Yamaha dealer bleed hydraulic system.</li> <li>• Check fluid level in reservoir.</li> <li>• If necessary, add recommended fluid to specified level.</li> <li>• Check hydraulic system for leakage.</li> </ul>	6-24, 6-26
<b>Throttle grip</b>	<ul style="list-style-type: none"> <li>• Make sure that operation is smooth.</li> <li>• Check cable free play.</li> <li>• If necessary, have Yamaha dealer adjust cable free play and lubricate cable and grip housing.</li> </ul>	6-20, 6-28
<b>Control cables</b>	<ul style="list-style-type: none"> <li>• Make sure that operation is smooth.</li> <li>• Lubricate if necessary.</li> </ul>	6-27
<b>Wheels and tires</b>	<ul style="list-style-type: none"> <li>• Check for damage.</li> <li>• Check tire condition and tread depth.</li> <li>• Check air pressure.</li> <li>• Correct if necessary.</li> </ul>	6-21, 6-22
<b>Brake and shift pedals</b>	<ul style="list-style-type: none"> <li>• Make sure that operation is smooth.</li> <li>• Lubricate pedal pivoting points if necessary.</li> </ul>	6-28
<b>Brake and clutch levers</b>	<ul style="list-style-type: none"> <li>• Make sure that operation is smooth.</li> <li>• Lubricate lever pivoting points if necessary.</li> </ul>	6-29
<b>Sidestand</b>	<ul style="list-style-type: none"> <li>• Make sure that operation is smooth.</li> <li>• Lubricate pivot if necessary.</li> </ul>	6-29
<b>Chassis fasteners</b>	<ul style="list-style-type: none"> <li>• Make sure that all nuts, bolts and screws are properly tightened.</li> <li>• Tighten if necessary.</li> </ul>	—
<b>Instruments, lights, signals and switches</b>	<ul style="list-style-type: none"> <li>• Check operation.</li> <li>• Correct if necessary.</li> </ul>	—
<b>Sidestand switch</b>	<ul style="list-style-type: none"> <li>• Check operation of ignition circuit cut-off system.</li> <li>• If system is defective, have Yamaha dealer check vehicle.</li> </ul>	3-18

# OPERATION AND IMPORTANT RIDING POINTS

EAU15950

EAU38000

EWA10270

## WARNING

- Become thoroughly familiar with all operating controls and their functions before riding. Consult a Yamaha dealer regarding any control or function that you do not thoroughly understand.
- Never start the engine or operate it in a closed area for any length of time. Exhaust fumes are poisonous, and inhaling them can cause loss of consciousness and death within a short time. Always make sure that there is adequate ventilation.
- Before starting out, make sure that the sidestand is up. If the sidestand is not raised completely, it could contact the ground and distract the operator, resulting in a possible loss of control.

## Starting and warming up a cold engine

In order for the ignition circuit cut-off system to enable starting, one of the following conditions must be met:

- The transmission is in the neutral position.
- The transmission is in gear with the clutch lever pulled and the sidestand up.

EWA10290

## WARNING

- Before starting the engine, check the function of the ignition circuit cut-off system according to the procedure described on page 3-19.
- Never ride with the sidestand down.

1. Turn the fuel cock lever to “ON”.
2. Turn the key to “ON” and make sure that the engine stop switch is set to “○”.
3. Shift the transmission into the neutral position.

## NOTE: \_\_\_\_\_

When the transmission is in the neutral position, the neutral indicator light should be on, otherwise have a Yamaha dealer check the electrical circuit.

4. Turn the starter (choke) on and completely close the throttle. (See page 3-11.)
5. Start the engine by pushing the start switch.

## NOTE: \_\_\_\_\_

If the engine fails to start, release the start switch, wait a few seconds, and then try again. Each starting attempt should be as short as possible to preserve the battery. Do not crank the engine more than 10 seconds on any one attempt.

ECA15240

## CAUTION: \_\_\_\_\_

- The oil level warning light should come on when the key is turned to “ON”, and then go off after two to three seconds. If the oil level warning light flickers or remains on after starting, imme-

# OPERATION AND IMPORTANT RIDING POINTS

diately stop the engine, and then check the engine oil level and the vehicle for oil leakage. If necessary, add engine oil, and then check the warning light again. If the warning light does not come on when turning the key to “ON”, or if it does not go off after starting the engine with sufficient engine oil, have a Yamaha dealer check the electrical circuit.

- The coolant temperature warning light should come on when the key is turned to “ON”, and then go off after two to three seconds. If the coolant temperature warning light flickers or remains on after starting, immediately stop the engine and have a Yamaha dealer check the electrical circuit.
- The engine trouble warning light should also come on when the key is turned to “ON”. If the warning light does not come on when the key is turned to “ON”, flashes or remains on after

starting the engine, have a Yamaha dealer check the electrical circuit.

6. After starting the engine, move the starter (choke) back halfway.

ECA11130

## CAUTION:

**For maximum engine life, always warm the engine up before starting off. Never accelerate hard when the engine is cold!**

7. When the engine is warm, turn the starter (choke) off.

## NOTE:

The engine is warm when it responds normally to the throttle with the starter (choke) turned off. To avoid the possibility of excessive exhaust emissions, never leave the starter (choke) on longer than necessary. The time necessary for starter (choke) use depends upon the ambient temperature. Temperatures above 10 °C (50 °F) require about 7 seconds of starter (choke) use and temperatures below 10 °C (50 °F) require about 35 seconds with the starter

(choke) turned on, then about 2.5 minutes with the starter (choke) in the half-way position.

# OPERATION AND IMPORTANT RIDING POINTS

EAU16640

## Starting a warm engine

Follow the same procedure as for starting a cold engine with the exception that the starter (choke) is not required when the engine is warm.

EAU16671

## Shifting

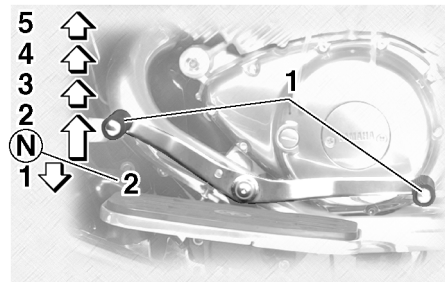

1. Shift pedal
2. Neutral position

Shifting gears lets you control the amount of engine power available for starting off, accelerating, climbing hills, etc.

The gear positions are shown in the illustration.

### NOTE:

To shift the transmission into the neutral position, press the shift pedal down repeatedly until it reaches the end of its travel, and then slightly raise it.

ECA10260

### CAUTION:

- Even with the transmission in the neutral position, do not coast for long periods of time with the engine off, and do not tow the motorcycle for long distances. The transmission is properly lubricated only when the engine is running. Inadequate lubrication may damage the transmission.
- Always use the clutch while changing gears to avoid damaging the engine, transmission, and drive train, which are not designed to withstand the shock of forced shifting.

EAU16680

### To start out and accelerate

1. Pull the clutch lever to disengage the clutch.
2. Shift the transmission into first gear. The neutral indicator light should go out.
3. Open the throttle gradually, and at the same time, release the clutch lever slowly.

# OPERATION AND IMPORTANT RIDING POINTS

4. At the recommended shift points shown in the following table, close the throttle, and at the same time, quickly pull the clutch lever in.
5. Shift the transmission into second gear. (Make sure not to shift the transmission into the neutral position.)
6. Open the throttle part way and gradually release the clutch lever.
7. Follow the same procedure when shifting to the next higher gear.

**NOTE:** \_\_\_\_\_  
Always shift gears at the recommended shift points.

EAU16700

## To decelerate

1. Apply both the front and the rear brakes to slow the motorcycle.
2. Shift the transmission into first gear when the motorcycle reaches 25 km/h (16 mi/h). If the engine is about to stall or runs very roughly, pull the clutch lever in and use the brakes to stop the motorcycle.

3. Shift the transmission into the neutral position when the motorcycle is almost completely stopped. The neutral indicator light should come on.

EAU16720

## Recommended shift points

The recommended shift points during acceleration and deceleration are shown in the table below.

### Shift up points:

- 1st → 2nd: 20 km/h (13 mi/h)
- 2nd → 3rd: 30 km/h (19 mi/h)
- 3rd → 4th: 40 km/h (25 mi/h)
- 4th → 5th: 50 km/h (31 mi/h)

### Shift down points:

- 5th → 4th: 25 km/h (16 mi/h)
- 4th → 3rd: 25 km/h (16 mi/h)
- 3rd → 2nd: 25 km/h (16 mi/h)
- 2nd → 1st: 25 km/h (16 mi/h)

EAU16841

## Engine break-in

There is never a more important period in the life of your engine than the period between 0 and 1600 km (1000 mi). For this reason, you should read the following material carefully.

Since the engine is brand new, do not put an excessive load on it for the first 1600 km (1000 mi). The various parts in the engine wear and polish themselves to the correct operating clearances. During this period, prolonged full-throttle operation or any condition that might result in engine overheating must be avoided.

EAU17041

## 0–1000 km (0–600 mi)

Avoid prolonged operation above 1/3 throttle.

## 1000–1600 km (600–1000 mi)

Avoid prolonged operation above 1/2 throttle.

# OPERATION AND IMPORTANT RIDING POINTS

---

ECA10331

## CAUTION:

After 1000 km (600 mi) of operation, the engine oil and final gear oil must be changed, and the oil filter cartridge or element replaced.

## 1600 km (1000 mi) and beyond

The vehicle can now be operated normally.

ECA10270

## CAUTION:

If any engine trouble should occur during the engine break-in period, immediately have a Yamaha dealer check the vehicle.

EAU17170

## Parking

When parking, stop the engine, remove the key from the main switch, and then turn the fuel cock lever to “OFF”.

EWA10310

## WARNING

- Since the engine and exhaust system can become very hot, park in a place where pedestrians or children are not likely to touch them.
- Do not park on a slope or on soft ground, otherwise the vehicle may overturn.

# PERIODIC MAINTENANCE AND MINOR REPAIR

EAU17231

Safety is an obligation of the owner. Periodic inspection, adjustment and lubrication will keep your vehicle in the safest and most efficient condition possible. The most important points of motorcycle inspection, adjustment, and lubrication are explained on the following pages.

**Maintenance, replacement, or repair of the emission control devices and systems may be performed by any repair establishment or individual that is certified (if applicable).**

EWA10320



**If you are not familiar with maintenance work, have a Yamaha dealer do it for you.**

EAU17301

## PERIODIC MAINTENANCE

PROPER PERIODIC MAINTENANCE OF YOUR VEHICLE IS IMPORTANT IN ORDER TO ENJOY LONG, PLEASURABLE SERVICE. ESPECIALLY IMPORTANT ARE THE MAINTENANCE SERVICES RELATED TO EMISSIONS CONTROL. THESE CONTROLS NOT ONLY FUNCTION TO ENSURE CLEANER AIR, BUT ARE ALSO VITAL TO PROPER ENGINE OPERATION AND MAXIMUM PERFORMANCE. IN THE FOLLOWING PERIODIC MAINTENANCE CHARTS, THE SERVICES RELATED TO EMISSIONS CONTROL ARE GROUPED SEPARATELY. THESE SERVICES REQUIRE SPECIALIZED DATA, KNOWLEDGE, AND EQUIPMENT. YAMAHA DEALERS ARE TRAINED AND EQUIPPED TO PERFORM THESE PARTICULAR SERVICES.

EAU35800

## Owner's tool kit

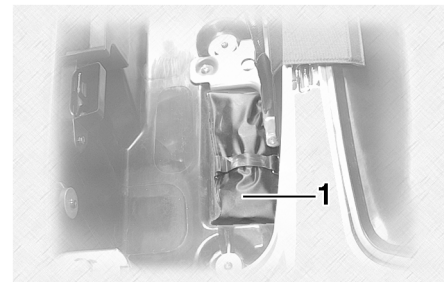

1. Owner's tool kit

The owner's tool kit is located inside the right sidecase. (See page 3-16.)

The service information included in this manual and the tools provided in the owner's tool kit are intended to assist you in the performance of preventive maintenance and minor repairs. However, additional tools such as a torque wrench may be necessary to perform certain maintenance work correctly.

### **NOTE:** \_\_\_\_\_

If you do not have the tools or experience required for a particular job, have a Yamaha dealer perform it for you.

# PERIODIC MAINTENANCE AND MINOR REPAIR

---

EWA10340

## **WARNING**

**Modifications not approved by Yamaha may cause loss of performance, excessive emissions, and render the vehicle unsafe for use. Consult a Yamaha dealer before attempting any changes.**

---

# PERIODIC MAINTENANCE AND MINOR REPAIR

EAU17600

## Periodic maintenance chart for the emission control system

No.	ITEM	ROUTINE	INITIAL	ODOMETER READINGS					
			600 mi (1000 km) or 1 month	4000 mi (7000 km) or 6 months	8000 mi (13000 km) or 12 months	12000 mi (19000 km) or 18 months	16000 mi (25000 km) or 24 months	20000 mi (31000 km) or 30 months	
1	* Fuel line	<ul style="list-style-type: none"> <li>• Check fuel hoses for cracks or damage.</li> <li>• Replace if necessary.</li> </ul>		√	√	√	√	√	
2	* Fuel filter	<ul style="list-style-type: none"> <li>• Replace.</li> </ul>						Replace.	
3	Spark plugs	<ul style="list-style-type: none"> <li>• Check condition.</li> <li>• Adjust gap and clean.</li> <li>• Replace every 8000 mi (13000 km) or 12 months.</li> </ul>		√	Replace.	√	Replace.	√	
4	* Valve clearance	<ul style="list-style-type: none"> <li>• Check and adjust valve clearance when engine is cold.</li> </ul>	Every 26600 mi (42000 km)						
5	* Crankcase breather system	<ul style="list-style-type: none"> <li>• Check breather hose for cracks or damage.</li> <li>• Replace if necessary.</li> </ul>		√	√	√	√	√	
6	* Carburetor synchronization	<ul style="list-style-type: none"> <li>• Adjust synchronization of carburetors.</li> </ul>	√	√	√	√	√	√	
7	* Idle speed	<ul style="list-style-type: none"> <li>• Check and adjust engine idle speed.</li> </ul>	√	√	√	√	√	√	
8	* Exhaust system	<ul style="list-style-type: none"> <li>• Check for leakage.</li> <li>• Tighten if necessary.</li> <li>• Replace gasket(s) if necessary.</li> </ul>		√	√	√	√	√	
9	* Evaporative emission control system (For California only)	<ul style="list-style-type: none"> <li>• Check control system for damage.</li> <li>• Replace if necessary.</li> </ul>				√			

\* Since these items require special tools, data and technical skills, have a Yamaha dealer perform the service.

# PERIODIC MAINTENANCE AND MINOR REPAIR

EAU32183

## General maintenance and lubrication chart

No.	ITEM	ROUTINE	INITIAL	ODOMETER READINGS				
			600 mi (1000 km) or 1 month	4000 mi (7000 km) or 6 months	8000 mi (13000 km) or 12 months	12000 mi (19000 km) or 18 months	16000 mi (25000 km) or 24 months	20000 mi (31000 km) or 30 months
1	* Air filter elements	<ul style="list-style-type: none"> <li>Clean with compressed air.</li> <li>Replace if necessary.</li> </ul>		√	√	√	√	√
2	* Clutch	<ul style="list-style-type: none"> <li>Check operation and fluid leakage.</li> <li>Correct if necessary.</li> </ul>	√	√	√	√	√	√
3	* Front brake	<ul style="list-style-type: none"> <li>Check operation, fluid level, and for fluid leakage.</li> <li>Replace brake pads if necessary.</li> </ul>	√	√	√	√	√	√
4	* Rear brake	<ul style="list-style-type: none"> <li>Check operation, fluid level, and for fluid leakage.</li> <li>Replace brake pads if necessary.</li> </ul>	√	√	√	√	√	√
5	* Brake hoses	<ul style="list-style-type: none"> <li>Check for cracks or damage.</li> <li>Replace.</li> </ul>		√	√	√	√	√
			Every 4 years					
6	* Wheels	<ul style="list-style-type: none"> <li>Check runout and for damage.</li> <li>Replace if necessary.</li> </ul>		√	√	√	√	√
7	* Tires	<ul style="list-style-type: none"> <li>Check tread depth and for damage.</li> <li>Replace if necessary.</li> <li>Check air pressure.</li> <li>Correct if necessary.</li> </ul>		√	√	√	√	√
8	* Wheel bearings	<ul style="list-style-type: none"> <li>Check bearings for smooth operation.</li> <li>Replace if necessary.</li> </ul>		√	√	√	√	√

6

# PERIODIC MAINTENANCE AND MINOR REPAIR

No.	ITEM	ROUTINE	INITIAL	ODOMETER READINGS					
			600 mi (1000 km) or 1 month	4000 mi (7000 km) or 6 months	8000 mi (13000 km) or 12 months	12000 mi (19000 km) or 18 months	16000 mi (25000 km) or 24 months	20000 mi (31000 km) or 30 months	
9	* Swingarm pivot bearings	<ul style="list-style-type: none"> <li>• Check bearing assemblies for looseness.</li> <li>• Moderately repack with lithium-soap-based grease.</li> </ul>			√			Repack.	
10	* Steering bearings	<ul style="list-style-type: none"> <li>• Check bearing assemblies for looseness.</li> <li>• Moderately repack with lithium-soap-based grease every 16000 mi (25000 km) or 24 months.</li> </ul>	√	√	√	√		Repack.	√
11	* Chassis fasteners	<ul style="list-style-type: none"> <li>• Check all chassis fitting and fasteners.</li> <li>• Correct if necessary.</li> </ul>		√	√	√		√	√
12	<b>Brake and clutch lever pivot shafts</b>	<ul style="list-style-type: none"> <li>• Apply lithium-soap-based grease (all-purpose grease) lightly.</li> </ul>		√	√	√		√	√
13	<b>Brake and shift pedal pivot shafts</b>	<ul style="list-style-type: none"> <li>• Apply lithium-soap-based grease (all-purpose grease) lightly.</li> </ul>		√	√	√		√	√
14	<b>Sidestand pivot</b>	<ul style="list-style-type: none"> <li>• Check operation.</li> <li>• Apply lithium-soap-based grease (all-purpose grease) lightly.</li> </ul>		√	√	√		√	√
15	* Sidestand switch	<ul style="list-style-type: none"> <li>• Check operation and replace if necessary.</li> </ul>	√	√	√	√		√	√
16	* Front fork	<ul style="list-style-type: none"> <li>• Check operation and for oil leakage.</li> <li>• Replace if necessary.</li> </ul>		√	√	√		√	√
17	* Shock absorber assembly	<ul style="list-style-type: none"> <li>• Check operation and for oil leakage.</li> <li>• Replace if necessary.</li> </ul>		√	√	√		√	√

# PERIODIC MAINTENANCE AND MINOR REPAIR

No.	ITEM	ROUTINE	INITIAL	ODOMETER READINGS				
			600 mi (1000 km) or 1 month	4000 mi (7000 km) or 6 months	8000 mi (13000 km) or 12 months	12000 mi (19000 km) or 18 months	16000 mi (25000 km) or 24 months	20000 mi (31000 km) or 30 months
18	* Rear suspension link pivots	<ul style="list-style-type: none"> <li>Apply lithium-soap-based grease lightly.</li> </ul>					√	
19	Engine oil	<ul style="list-style-type: none"> <li>Change (warm engine before draining).</li> </ul>	√	√	√	√	√	√
20	* Engine oil filter cartridge	<ul style="list-style-type: none"> <li>Replace.</li> </ul>	√		√		√	
21	* Cooling system	<ul style="list-style-type: none"> <li>Check hoses for cracks or damage.</li> <li>Replace if necessary.</li> </ul>		√	√	√	√	√
		<ul style="list-style-type: none"> <li>Change with ethylene glycol anti-freeze coolant every 24 months.</li> </ul>					Change.	
22	Final gear oil	<ul style="list-style-type: none"> <li>Check oil level and for oil leakage.</li> <li>Change at initial 600 mi (1000 km) or 1 month, and thereafter every 16000 mi (25000 km) or 24 months.</li> </ul>	Change.	√	√	√	Change.	√
23	* Front and rear brake switches	<ul style="list-style-type: none"> <li>Check operation.</li> </ul>	√	√	√	√	√	√
24	* Control cables	<ul style="list-style-type: none"> <li>Apply Yamaha chain and cable lube or engine oil SAE 10W-30 thoroughly.</li> </ul>	√	√	√	√	√	√
25	* Throttle grip housing and cable	<ul style="list-style-type: none"> <li>Check operation and free play.</li> <li>Adjust the throttle cable free play if necessary.</li> <li>Lubricate the throttle grip housing and cable.</li> </ul>		√	√	√	√	√

# PERIODIC MAINTENANCE AND MINOR REPAIR

No.	ITEM	ROUTINE	INITIAL	ODOMETER READINGS				
			600 mi (1000 km) or 1 month	4000 mi (7000 km) or 6 months	8000 mi (13000 km) or 12 months	12000 mi (19000 km) or 18 months	16000 mi (25000 km) or 24 months	20000 mi (31000 km) or 30 months
26	* Lights, signals and switches	<ul style="list-style-type: none"> <li>• Check operation.</li> <li>• Adjust headlight beam.</li> </ul>	√	√	√	√	√	√

\* Since these items require special tools, data and technical skills, have a Yamaha dealer perform the service.

**NOTE:**

From 24000 mi (37000 km) or 36 months, repeat the maintenance intervals starting from 8000 mi (13000 km) or 12 months.

EAU17660

**NOTE:**

- The air filter needs more frequent service if you are riding in unusually wet or dusty areas.
- Hydraulic brake and clutch systems
  - After disassembling the brake or clutch master cylinders, caliper cylinders or clutch release cylinder, always change the fluid. Regularly check the brake and clutch fluid levels and fill the reservoirs as required.
  - Replace the oil seals on the inner parts of the brake or clutch master cylinders, caliper cylinders and clutch release cylinder every two years.
  - Replace the brake and clutch hoses every four years or if cracked or damaged.

# PERIODIC MAINTENANCE AND MINOR REPAIR

## Removing and installing cowlings and panels

EAU18712

The cowlings and panels shown need to be removed to perform some of the maintenance jobs described in this chapter. Refer to this section each time a cowling or panel needs to be removed and installed.

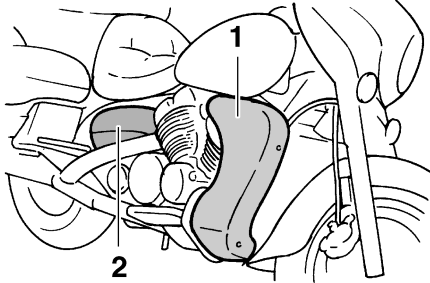

1. Cowling A
2. Panel A

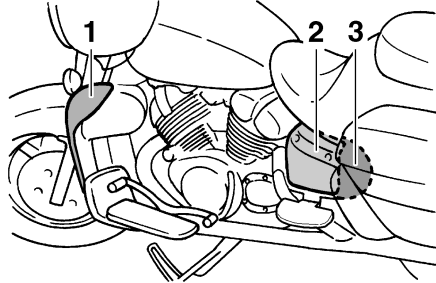

1. Cowling B
2. Panel B
3. Panel C

### Cowling A

EAU35841

#### To remove the cowling

1. Remove the bolts.
2. Remove the quick fastener screw by turning it 1/4 turn counterclockwise, and then take the cowling off.

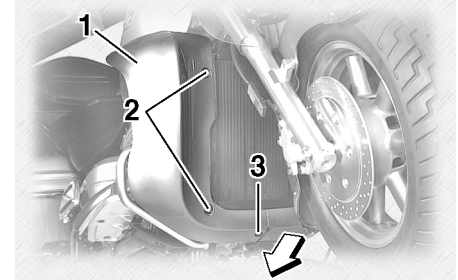

1. Cowling A
2. Bolt
3. Quick fastener screw



1. Bolt

#### To install the cowling

Place the cowling in the original position, and then install the quick fastener screw and the bolts.

# PERIODIC MAINTENANCE AND MINOR REPAIR

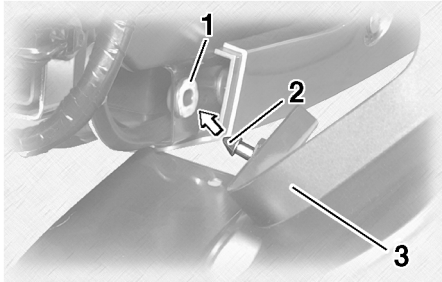

1. Grommet
2. Projection
3. Cowling A

**NOTE:** \_\_\_\_\_  
Make sure that the projection fits into the grommet.

## Cowling B

EAU35850

### To remove the cowling

1. Remove cowling A.
2. Remove the bolts, and then pull the cowling off as shown.

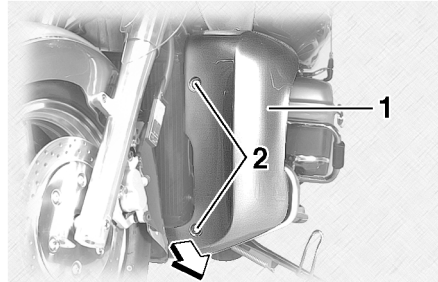

1. Cowling B
2. Bolt

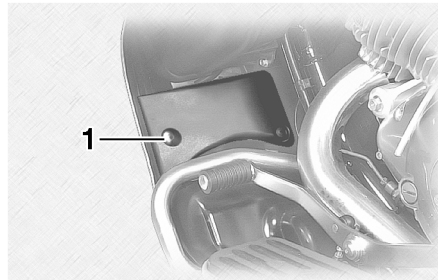

1. Bolt

### To install the cowling

1. Place the cowling in the original position, and then install the bolts.

**NOTE:** \_\_\_\_\_  
Make sure that the projection fits into the grommet.

2. Install cowling A.

## Panels A and B

EAU35860

### To remove one of the panels

Remove the bolt, and then pull the panel off as shown.

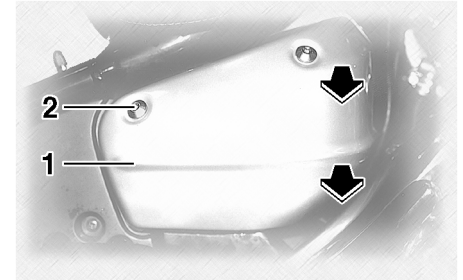

1. Panel A
2. Bolt

# PERIODIC MAINTENANCE AND MINOR REPAIR

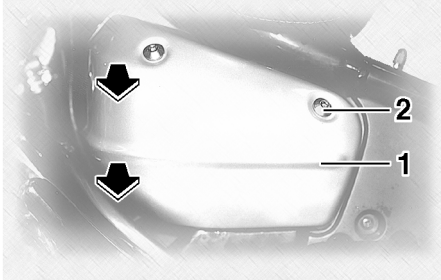

1. Panel B
2. Bolt

## To install the panel

Place the panel in the original position, and then install the bolt.

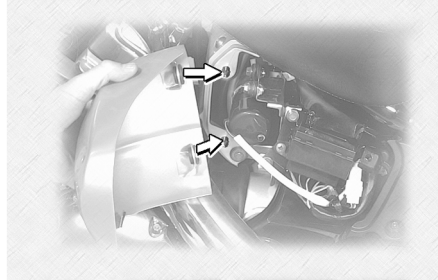
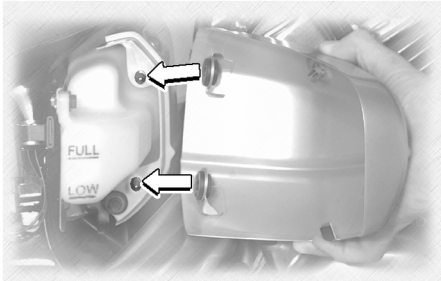

## **Panel C**

EAU19332

## To remove the panel

1. Remove the left passenger footrest by removing the bolts.
2. Remove the screw, and then pull the panel off as shown.

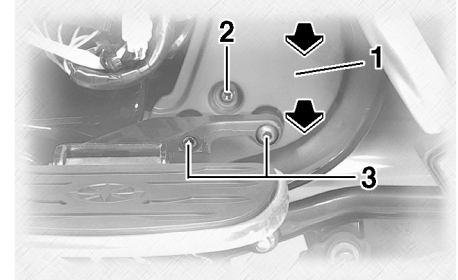

1. Panel C
2. Screw
3. Bolt

## To install the panel

1. Place the panel in the original position, and then install the screw.

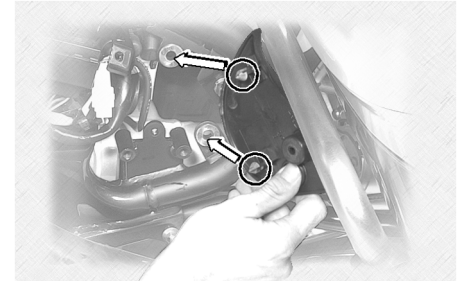

2. Install the passenger footrest by installing the bolts.

# PERIODIC MAINTENANCE AND MINOR REPAIR

EAU19544

## Checking the spark plugs

The spark plugs are important engine components, which are easy to check. Since heat and deposits will cause any spark plug to slowly erode, the spark plugs should be removed and checked in accordance with the periodic maintenance and lubrication chart. In addition, the condition of the spark plugs can reveal the condition of the engine.

### To remove a spark plug

1. Remove the spark plug cap.

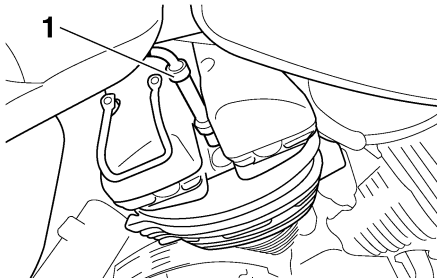

1. Spark plug cap

2. Remove the spark plug as shown, with the spark plug wrench included in the owner's tool kit.

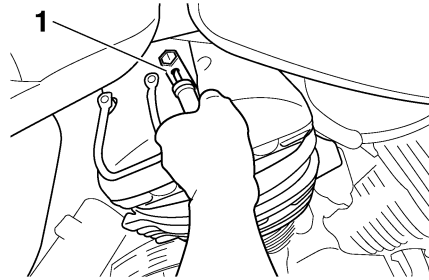

1. Spark plug wrench

### To check the spark plugs

1. Check that the porcelain insulator around the center electrode on each spark plug is a medium-to-light tan (the ideal color when the vehicle is ridden normally).
2. Check that all spark plugs installed in the engine have the same color.

#### NOTE:

If any spark plug shows a distinctly different color, the engine could be operating improperly. Do not attempt to diagnose such problems yourself. Instead, have a Yamaha dealer check the vehicle.

3. Check each spark plug for electrode erosion and excessive carbon or other deposits, and replace it if necessary.

#### Specified spark plug:

NGK/DPR8EA-9  
DENSO/X24EPR-U9

### To install a spark plug

1. Measure the spark plug gap with a wire thickness gauge and, if necessary, adjust the gap to specification.

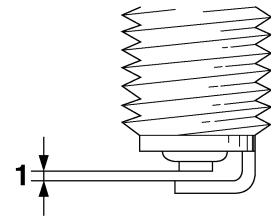

1. Spark plug gap

#### Spark plug gap:

0.8–0.9 mm (0.031–0.035 in)

# PERIODIC MAINTENANCE AND MINOR REPAIR

2. Clean the surface of the spark plug gasket and its mating surface, and then wipe off any grime from the spark plug threads.
3. Install the spark plug with the spark plug wrench, and then tighten it to the specified torque.

## Tightening torque:

Spark plug:

17.5 Nm (1.75 m·kgf, 12.7 ft·lbf)

## NOTE:

If a torque wrench is not available when installing a spark plug, a good estimate of the correct torque is 1/4–1/2 turn past finger tight. However, the spark plug should be tightened to the specified torque as soon as possible.

4. Install the spark plug cap.

## Canister (for California only)

EAU19672

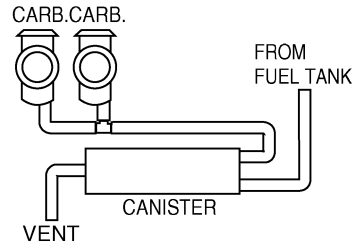

This model is equipped with a canister to prevent the discharging of fuel vapor into the atmosphere.

- Check each hose connection.
- Check each hose and canister for cracks or damage. Replace if damaged.
- Make sure the vent hose is not blocked. Clean it if necessary.

## Engine oil and oil filter cartridge

EAU19902

The engine oil level should be checked before each ride. In addition, the oil must be changed and the oil filter cartridge replaced at the intervals specified in the periodic maintenance and lubrication chart.

## To check the engine oil level

1. Place the vehicle on a level surface and hold it in an upright position.

## NOTE:

Make sure that the vehicle is positioned straight up when checking the oil level. A slight tilt to the side can result in a false reading.

2. Start the engine, warm it up for several minutes, and then turn it off.
3. Wait a few minutes until the oil settles, and then check the oil level through the check window located at the bottom-right side of the crankcase.

# PERIODIC MAINTENANCE AND MINOR REPAIR

**NOTE:** \_\_\_\_\_  
The engine oil should be between the minimum and maximum level marks.

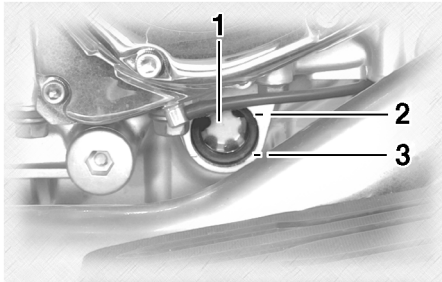

1. Engine oil level check window
2. Maximum level mark
3. Minimum level mark

4. If the engine oil is below the minimum level mark, add sufficient oil of the recommended type to raise it to the correct level.

## To change the engine oil (with or without oil filter cartridge replacement)

1. Start the engine, warm it up for several minutes, and then turn it off.

2. Place an oil pan under the engine to collect the used oil.
3. Remove the engine oil filler cap and drain bolt to drain the oil from the crankcase.

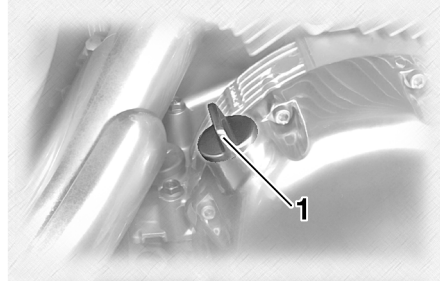

1. Engine oil filler cap

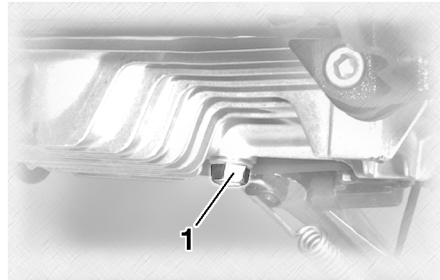

1. Engine oil drain bolt

**NOTE:** \_\_\_\_\_  
Skip steps 4–6 if the oil filter cartridge is not being replaced.

4. Remove the oil filter cartridge with an oil filter wrench.

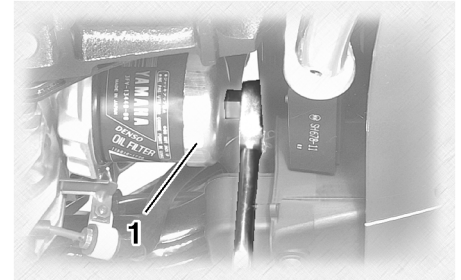

1. Oil filter wrench

**NOTE:** \_\_\_\_\_  
An oil filter wrench is available at a Yamaha dealer.

5. Apply a thin coat of engine oil to the O-ring of the new oil filter cartridge.

# PERIODIC MAINTENANCE AND MINOR REPAIR

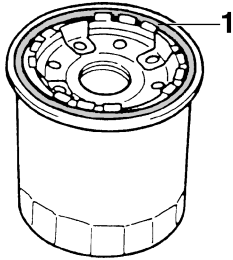

1. O-ring

## NOTE:

Make sure that the O-ring is properly seated.

6. Install the new oil filter cartridge with an oil filter wrench, and then tighten it to the specified torque with a torque wrench.

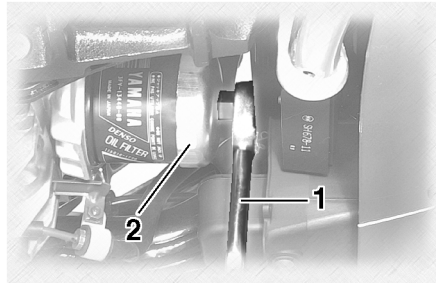

1. Torque wrench
2. Oil filter wrench

## Tightening torque:

Oil filter cartridge:  
17 Nm (1.7 m·kgf, 12 ft·lbf)

7. Install the engine oil drain bolt, and then tighten it to the specified torque.

## Tightening torque:

Engine oil drain bolt:  
43 Nm (4.3 m·kgf, 31 ft·lbf)

8. Add the specified amount of the recommended engine oil, and then install and tighten the oil filler cap.

## Recommended engine oil:

See page 8-1.

## Oil quantity:

Without oil filter cartridge replacement:

3.50 L (3.70 US qt) (3.08 Imp. qt)

With oil filter cartridge replacement:

3.70 L (3.91 US qt) (3.26 Imp. qt)

ECA11620

## CAUTION:

- In order to prevent clutch slippage (since the engine oil also lubricates the clutch), do not mix any chemical additives. Do not use oils with a diesel specification of “CD” or oils of a higher quality than specified. In addition, do not use oils labeled “ENERGY CONSERVING II” or higher.
- Make sure that no foreign material enters the crankcase.

9. Start the engine, and then let it idle for several minutes while checking it for oil leakage. If oil is leaking, immediately turn the engine off and check for the cause.

# PERIODIC MAINTENANCE AND MINOR REPAIR

## NOTE: \_\_\_\_\_

After the engine is started, the engine oil level warning light should go off if the oil level is sufficient.

ECA10400

## CAUTION: \_\_\_\_\_

**If the oil level warning light flickers or remains on, immediately turn the engine off and have a Yamaha dealer check the vehicle.**

10. Turn the engine off, and then check the oil level and correct it if necessary.

## Final gear oil

The final gear case must be checked for oil leakage before each ride. If any leakage is found, have a Yamaha dealer check and repair the vehicle. In addition, the final gear oil level must be checked and the oil changed as follows at the intervals specified in the periodic maintenance and lubrication chart.

EAU20022

EWA10370

## WARNING

- Make sure that no foreign material enters the final gear case.
- Make sure that no oil gets on the tire or wheel.

## To check the final gear oil level

1. Place the vehicle on a level surface and hold it in an upright position.

## NOTE: \_\_\_\_\_

- The final gear oil level must be checked on a cold engine.
- Make sure that the vehicle is positioned straight up when checking the oil level. A slight tilt to the side can result in a false reading.

2. Remove the oil filler bolt, and then check the oil level in the final gear case.

## NOTE: \_\_\_\_\_

The oil level should be at the brim of the filler hole.

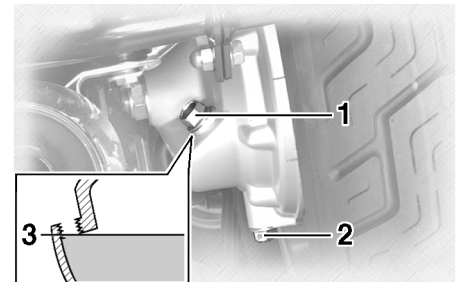

1. Final gear oil filler bolt
2. Final gear oil drain bolt
3. Correct oil level

3. If the oil is below the brim of the filler hole, add sufficient oil of the recommended type to raise it to the correct level.

## To change the final gear oil

1. Place an oil pan under the final gear case to collect the used oil.

# PERIODIC MAINTENANCE AND MINOR REPAIR

2. Remove the oil filler bolt and drain bolt to drain the oil from the final gear case.
3. Install the final gear oil drain bolt, and then tighten it to the specified torque.

**Tightening torque:**

Final gear oil drain bolt:  
23 Nm (2.3 m-kgf, 17 ft-lbf)

4. Add the recommended final gear oil to the brim of the filler hole.

**Recommended final gear oil:**

SAE80 API GL-4 Hypoid gear oil

**Oil quantity:**

0.20 L (0.21 US qt) (0.18 Imp.qt)

**NOTE:** \_\_\_\_\_

GL4 is a quality rating. Hypoid gear oils rated GL5 or GL6 may also be used.

5. Install the oil filler bolt, and then tighten it to the specified torque.

**Tightening torque:**

Final gear oil filler bolt:  
23 Nm (2.3 m-kgf, 17 ft-lbf)

6. Check the final gear case for oil leakage. If oil is leaking, check for the cause.

## Coolant

EAU20070

The coolant level should be checked before each ride. In addition, the coolant must be changed at the intervals specified in the periodic maintenance and lubrication chart.

EAU20212

### To check the coolant level

1. Place the vehicle on a level surface and hold it in an upright position.
2. Remove panel A. (See page 6-8.)

**NOTE:** \_\_\_\_\_

- The coolant level must be checked on a cold engine since the level varies with engine temperature.
- Make sure that the vehicle is positioned straight up when checking the coolant level. A slight tilt to the side can result in a false reading.

3. Check the coolant level in the coolant reservoir.

**NOTE:** \_\_\_\_\_

The coolant should be between the minimum and maximum level marks.

# PERIODIC MAINTENANCE AND MINOR REPAIR

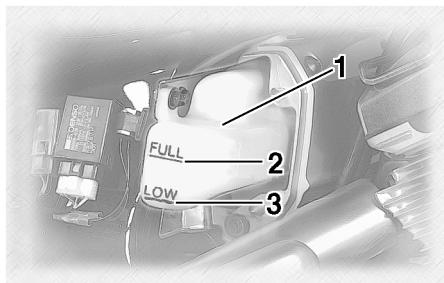

1. Coolant reservoir
2. Maximum level mark
3. Minimum level mark

4. If the coolant is at or below the minimum level mark, remove the rider seat (See page 3-12.), open the reservoir cap, add coolant to the maximum level mark, and then close the reservoir cap and install the rider seat.

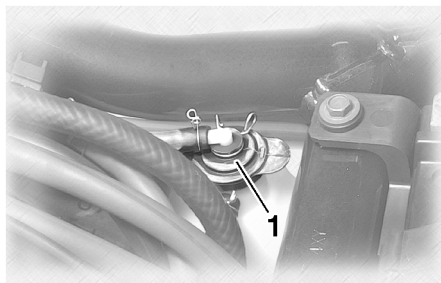

1. Coolant reservoir cap

**Coolant reservoir capacity (up to the maximum level mark):**

0.35 L (0.37 US qt) (0.31 Imp.qt)

ECA10471

## CAUTION:

- If coolant is not available, use distilled water or soft tap water instead. Do not use hard water or salt water since it is harmful to the engine.
- If water has been used instead of coolant, replace it with coolant as soon as possible, otherwise the cooling system will not be protected against frost and corrosion.

- If water has been added to the coolant, have a Yamaha dealer check the antifreeze content of the coolant as soon as possible, otherwise the effectiveness of the coolant will be reduced.

EWA10380

## ! WARNING

Never attempt to remove the radiator cap when the engine is hot.

5. Install the panel.

## NOTE:

- The radiator fan is automatically switched on or off according to the coolant temperature in the radiator.
- If the engine overheats, see page 6-38 for further instructions.

EAU33030

## Changing the coolant

EWA10380

## ! WARNING

Never attempt to remove the radiator cap when the engine is hot.

# PERIODIC MAINTENANCE AND MINOR REPAIR

The coolant must be changed at the intervals specified in the periodic maintenance and lubrication chart. Have a Yamaha dealer change the coolant.

## Cleaning the air filter elements EAU35193

The air filter elements should be cleaned at the intervals specified in the periodic maintenance and lubrication chart. Clean the air filter elements more frequently if you are riding in unusually wet or dusty areas.

1. Remove cowlings A and B. (See page 6-8.)

**NOTE:** \_\_\_\_\_  
Continue as follows for each air filter element.

2. Remove the air filter case bolts.

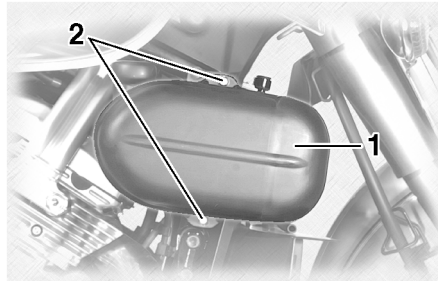

1. Air filter case
2. Bolt

3. Loosen the air filter case joint clamp screw, and then pull the air filter case off.

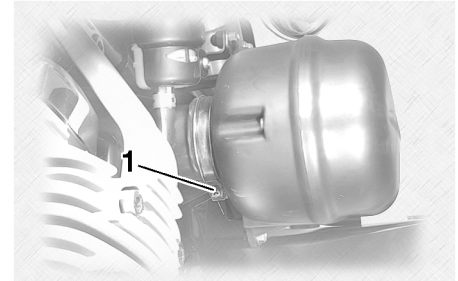

1. Air filter case joint clamp screw

4. Remove the air filter case cover by removing the screws.

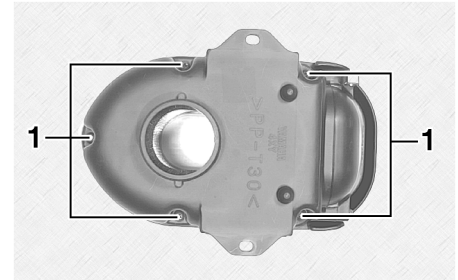

1. Screw

5. Remove the air filter element by removing the screws.

# PERIODIC MAINTENANCE AND MINOR REPAIR

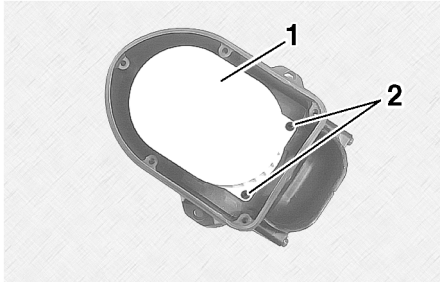

1. Air filter element
2. Screw

6. Lightly tap the air filter element to remove most of the dust and dirt, and then blow the remaining dirt out with compressed air as shown. If the air filter element is damaged, replace it.

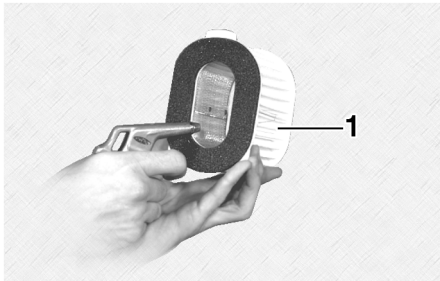

1. Air filter element

7. Install the air filter element by fitting the projection on the air filter element into the holder in the air filter case, then tightening the screws.

ECA10480

## CAUTION:

- Make sure that the air filter element is properly seated in the air filter case.
- The engine should never be operated without the air filter element installed, otherwise the piston(s) and/or cylinder(s) may become excessively worn.

8. Install the air filter case cover by installing the screws.
9. Push the air filter case onto the air filter case joint, and then tighten the clamp screw.
10. Install the air filter case bolts.
11. Install the cowlings.

## NOTE:

Make sure that the carburetor air vent hose is routed as shown.

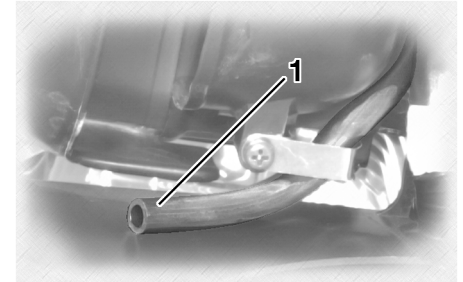

1. Carburetor air vent hose

# PERIODIC MAINTENANCE AND MINOR REPAIR

## Carburetors

EAU21271

The carburetors are important parts of the engine and emission control system, which require very sophisticated adjustment. Therefore, all carburetor adjustments should be left to a Yamaha dealer, who has the necessary professional knowledge and experience.

## Checking the throttle cable free play

EAU21381

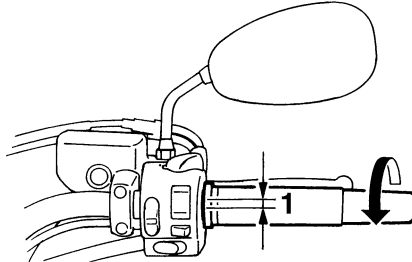

### 1. Throttle cable free play

The throttle cable free play should measure 4.0–6.0 mm (0.16–0.24 in) at the throttle grip. Periodically check the throttle cable free play and, if necessary, have a Yamaha dealer adjust it.

## Valve clearance

EAU21401

The valve clearance changes with use, resulting in improper air-fuel mixture and/or engine noise. To prevent this from occurring, the valve clearance must be adjusted by a Yamaha dealer at the intervals specified in the periodic maintenance and lubrication chart.

## Tires

EAU32541

To maximize the performance, durability, and safe operation of your motorcycle, note the following points regarding the specified tires.

### Tire air pressure

The tire air pressure should be checked and, if necessary, adjusted before each ride.

EWA10500

#### **WARNING**

- The tire air pressure must be checked and adjusted on cold tires (i.e., when the temperature of the tires equals the ambient temperature).
- The tire air pressure must be adjusted in accordance with the riding speed and with the total weight of rider, passenger, cargo, and accessories approved for this model.

### Tire air pressure (measured on cold tires):

#### 0–90 kg (0–198 lb):

Front:

250 kPa (36 psi) (2.50 kgf/cm<sup>2</sup>)

Rear:

250 kPa (36 psi) (2.50 kgf/cm<sup>2</sup>)

#### 90–201 kg (198–443 lb):

Front:

250 kPa (36 psi) (2.50 kgf/cm<sup>2</sup>)

Rear:

280 kPa (41 psi) (2.80 kgf/cm<sup>2</sup>)

#### Maximum load\*:

201 kg (443 lb)

\* Total weight of rider, passenger, cargo and accessories

EWA10510

#### **WARNING**

Proper loading of your vehicle is important for several characteristics of your vehicle, such as handling, braking, performance and safety. Do not carry loosely packed items that can shift. Securely pack your heaviest items close to the center of the vehicle, and distribute the weight evenly from side to side. Properly adjust the suspension for your load, and check the condition and pressure of your tires. **NEVER OVER-**

**LOAD YOUR VEHICLE.** Make sure that the total weight of the cargo, rider, passenger, and accessories (cowling, saddlebags, etc. if approved for this model) does not exceed the maximum load of the vehicle. Operation of an overloaded vehicle could cause tire damage, an accident, or even injury.

### Tire inspection

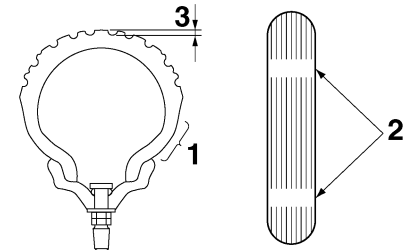

1. Tire sidewall
2. Tire wear indicator
3. Tire tread depth

Always check the tires before operating the motorcycle. If a tire tread shows crosswise lines (minimum tread depth), if the tire has a nail or glass fragments

# PERIODIC MAINTENANCE AND MINOR REPAIR

in it, or if the sidewall is cracked, contact a Yamaha dealer immediately and have the tire replaced.

**Minimum tire tread depth (front and rear):**  
1.0 mm (0.04 in)

EWA10520

## **WARNING**

**It is dangerous to ride with a worn-out tire. When a tire tread begins to show lines, have a Yamaha dealer replace the tire immediately. Brakes, tires and related wheel parts replacement should also be left to a Yamaha dealer.**

6

## **Tire information**

This motorcycle is equipped with cast wheels and tubeless tires.

EWA10460

## **WARNING**

- **The front and rear tires should be of the same make and design, otherwise the handling characteristics of the vehicle cannot be guaranteed.**

- **After extensive tests, only the tires listed below have been approved for this model by Yamaha Motor Co., Ltd.**

### **Front tire:**

Size:  
150/80-16M/C 71H  
Manufacturer/model:  
BRIDGESTONE/G705G

### **Rear tire:**

Size:  
150/90B15M/C 74H  
Manufacturer/model:  
BRIDGESTONE/G702G

EAU21992

## **Cast wheels**

To maximize the performance, durability, and safe operation of your vehicle, note the following points regarding the specified wheels.

- The wheel rims should be checked for cracks, bends, warpage or damage before each ride. If any damage is found, have a Yamaha dealer replace the wheel. Do not attempt even the smallest repair to the wheel. A deformed or cracked wheel must be replaced.
- The wheel should be balanced whenever either the tire or wheel has been changed or replaced. An unbalanced wheel can result in poor performance, adverse handling characteristics, and a shortened tire life.
- Ride at moderate speeds after changing a tire since the tire surface must first be “broken in” for it to develop its optimal characteristics.
- After repairing or replacing the rear tire, tighten the valve stem nut and locknut to the specified torques.

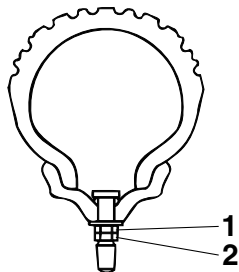

1. Valve stem nut
2. Valve stem locknut

## Tightening torques:

Valve stem nut:

1.6 Nm (0.16 m·kgf, 1.16 ft·lbf)

Valve stem locknut:

1.6 Nm (0.16 m·kgf, 1.16 ft·lbf)

## Accessories and replacement parts

EAU22011

EWA10621

### **⚠ WARNING**

This vehicle is not designed to pull a trailer or to be attached to a sidecar. The accessories or replacement parts you choose for your vehicle should be designed specifically for this model, and they must be securely mounted to maintain the inherent stability of the original design. Genuine Yamaha Parts and Accessories are designed and tested to be compatible with your vehicle. Please consider Genuine Yamaha Parts and Accessories before making a purchase. Use of non-Yamaha-approved accessories or replacement parts may cause loss of handling stability and riding safety. Since Yamaha cannot control the quality of accessories or parts manufactured by other companies, Yamaha cannot be held liable for

any consequences caused by the use of items which have not been approved by Yamaha.

# PERIODIC MAINTENANCE AND MINOR REPAIR

## Clutch lever

EAU22072

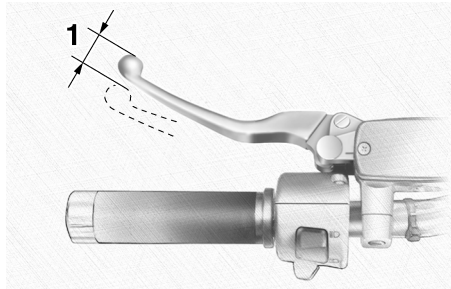

1. Clutch lever free play

Since this model is equipped with a hydraulic clutch, adjusting the clutch lever free play is not needed. However, it is necessary to check the clutch fluid level and check the hydraulic system for leakage before each ride. If the clutch lever free play does become excessive, and shifting becomes rough or clutch slippage occurs, causing poor acceleration, there may be air in the clutch system. If there is air in the hydraulic system, have a Yamaha dealer bleed the system before operating the motorcycle.

## Adjusting the brake lever free play

EAU22092

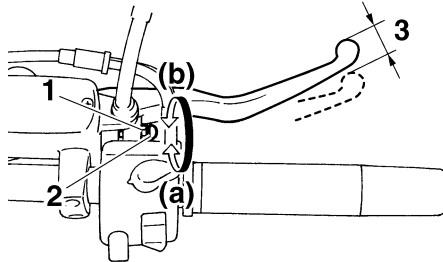

1. Locknut
2. Brake lever free play adjusting screw
3. Brake lever free play

The brake lever free play should measure 2.0–5.0 mm (0.08–0.20 in) as shown. Periodically check the brake lever free play and, if necessary, adjust it as follows.

1. Loosen the locknut at the brake lever.
2. To increase the brake lever free play, turn the adjusting screw in direction (a). To decrease the brake lever free play, turn the adjusting screw in direction (b).
3. Tighten the locknut.

## **⚠ WARNING**

- After adjusting the brake lever free play, check the free play and make sure that the brake is working properly.
- A soft or spongy feeling in the brake lever can indicate the presence of air in the hydraulic system. If there is air in the hydraulic system, have a Yamaha dealer bleed the system before operating the motorcycle. Air in the hydraulic system will diminish the braking performance, which may result in loss of control and an accident.

EWA10630

# PERIODIC MAINTENANCE AND MINOR REPAIR

## Adjusting the rear brake light switch

EAU22280

The rear brake light switch, which is activated by the brake pedal, is properly adjusted when the brake light comes on just before braking takes effect. Since the brake light switch is a component of the cruise control system, it must be adjusted by a Yamaha dealer, who has the necessary professional knowledge and experience.

## Checking the front and rear brake pads

EAU22390

The front and rear brake pads must be checked for wear at the intervals specified in the periodic maintenance and lubrication chart.

### Front brake pads

EAU22430

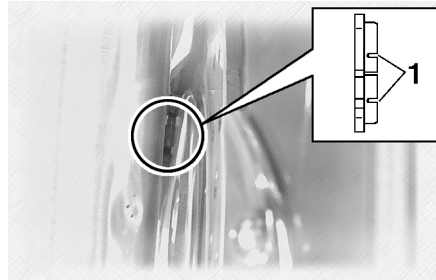

1. Brake pad wear indicator groove

Each front brake pad is provided with wear indicator grooves, which allow you to check the brake pad wear without having to disassemble the brake. To check the brake pad wear, check the wear indicator grooves. If a brake pad has worn to the point that the wear

indicator grooves have almost disappeared, have a Yamaha dealer replace the brake pads as a set.

### Rear brake pads

EAU22470

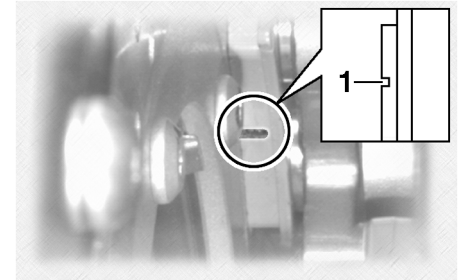

1. Brake pad wear indicator groove

Each rear brake pad is provided with a wear indicator groove, which allows you to check the brake pad wear without having to disassemble the brake. To check the brake pad wear, check the wear indicator groove. If a brake pad has worn to the point that the wear indicator groove has almost disappeared, have a Yamaha dealer replace the brake pads as a set.

# PERIODIC MAINTENANCE AND MINOR REPAIR

EAU22660

## Checking the brake and clutch fluid levels

### Front brake

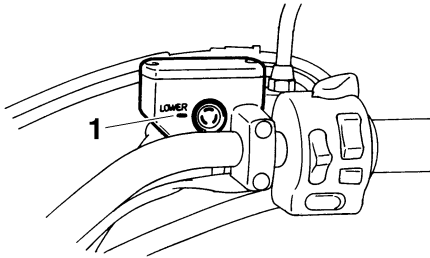

1. Minimum level mark

### Clutch

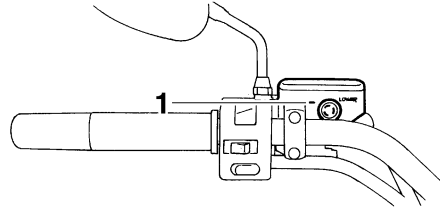

1. Minimum level mark

Insufficient brake or clutch fluid may allow air to enter the brake or clutch systems, possibly causing them to become ineffective.

Before riding, check that the brake and clutch fluids are above the minimum level marks and replenish if necessary. A low brake or clutch fluid level may indicate brake or clutch system leakage and/or worn brake pads. If the brake or clutch levels are low, be sure to check the brake or clutch systems for leakage and the brake pads for wear.

Observe these precautions:

- When checking the brake and clutch fluid levels, make sure that the top of each reservoir is level.

- Use only the recommended quality brake fluid, otherwise the rubber seals may deteriorate, causing leakage and poor braking or clutch performance.

### Recommended brake and clutch fluid:

DOT 4 brake fluid

- Refill with the same type of brake fluid. Mixing fluids may result in a harmful chemical reaction and lead to poor braking or clutch performance.
- Be careful that water does not enter the brake or clutch fluid reservoir when refilling. Water will significantly lower the boiling point of the fluid and may result in vapor lock.
- Brake fluid may deteriorate painted surfaces or plastic parts. Always clean up spilled fluid immediately.
- As the brake pads wear, it is normal for the brake fluid level to gradually go down. However, if the

6

### Rear brake

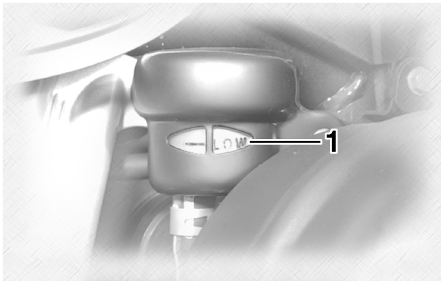

1. Minimum level mark

# PERIODIC MAINTENANCE AND MINOR REPAIR

brake fluid level goes down suddenly, have a Yamaha dealer check the cause.

## Changing the brake and clutch fluids

Have a Yamaha dealer change the brake and clutch fluids at the intervals specified in the NOTE after the periodic maintenance and lubrication chart. In addition, have the oil seals of the brake and clutch master cylinders and calipers as well as the brake and clutch hoses replaced at the intervals listed below or whenever they are damaged or leaking.

- Oil seals: Replace every two years.
- Brake and clutch hoses: Replace every four years.

EAU22750

## Checking and lubricating the cables

The operation of all control cables and the condition of the cables should be checked before each ride, and the cables and cable ends should be lubricated if necessary. If a cable is damaged or does not move smoothly, have a Yamaha dealer check or replace it.

EAU23091

### Recommended lubricant:

Yamaha Chain and Cable Lube or engine oil SAE 10W-30

EWA10710

### **WARNING**

**Damage to the outer housing of cables may result in internal rusting and cause interference with cable movement. Replace damaged cables as soon as possible to prevent unsafe conditions.**

# PERIODIC MAINTENANCE AND MINOR REPAIR

## Checking and lubricating the throttle grip and cable

EAU23111

The operation of the throttle grip should be checked before each ride. In addition, the cable should be lubricated at the intervals specified in the periodic maintenance chart.

## Checking and lubricating the brake and shift pedals

EAU23131

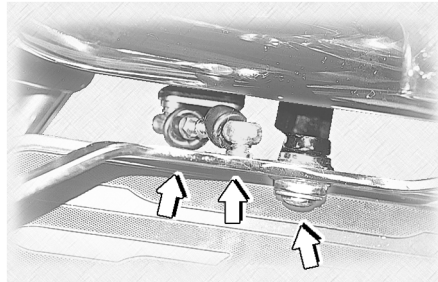
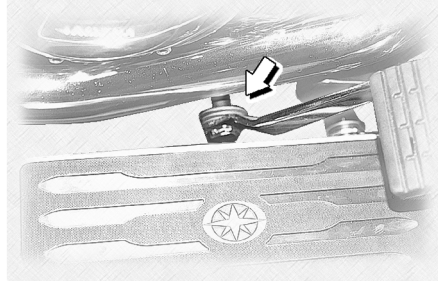

### Recommended lubricant:

Lithium-soap-based grease (all-purpose grease)

The operation of the brake and shift pedals should be checked before each ride, and the pedal pivots should be lubricated if necessary.

# PERIODIC MAINTENANCE AND MINOR REPAIR

## Checking and lubricating the brake and clutch levers

EAU23140

### Clutch lever

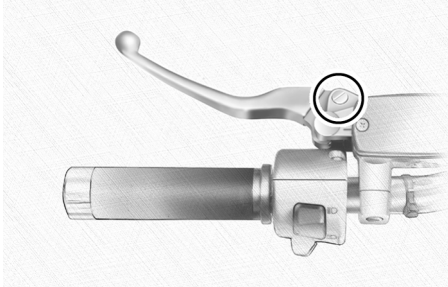

The operation of the brake and clutch levers should be checked before each ride, and the lever pivots should be lubricated if necessary.

#### Recommended lubricant:

Lithium-soap-based grease (all-purpose grease)

## Checking and lubricating the sidestand

EAU23200

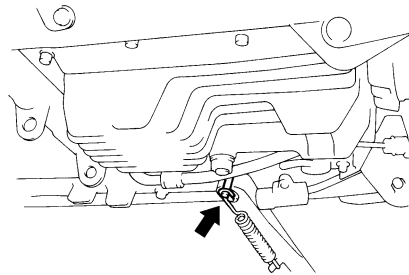

The operation of the sidestand should be checked before each ride, and the sidestand pivot and metal-to-metal contact surfaces should be lubricated if necessary.

EWA10730

### **⚠ WARNING**

**If the sidestand does not move up and down smoothly, have a Yamaha dealer check or repair it.**

#### Recommended lubricant:

Lithium-soap-based grease (all-purpose grease)

## Lubricating the swingarm pivots

EAUM1650

The swingarm pivots must be lubricated at the intervals specified in the periodic maintenance and lubrication chart.

#### Recommended lubricant:

Lithium-soap-based grease

# PERIODIC MAINTENANCE AND MINOR REPAIR

## Lubricating the rear suspension

EAU23250

The pivoting points of the rear suspension must be lubricated at the intervals specified in the periodic maintenance and lubrication chart.

**Recommended lubricant:**  
Lithium-soap-based grease

## Checking the front fork

EAU23271

The condition and operation of the front fork must be checked as follows at the intervals specified in the periodic maintenance and lubrication chart.

### To check the condition

EWA10750



**Securely support the vehicle so that there is no danger of it falling over.**

Check the inner tubes for scratches, damage and excessive oil leakage.

### To check the operation

1. Place the vehicle on a level surface and hold it in an upright position.
2. While applying the front brake, push down hard on the handlebars several times to check if the front fork compresses and rebounds smoothly.

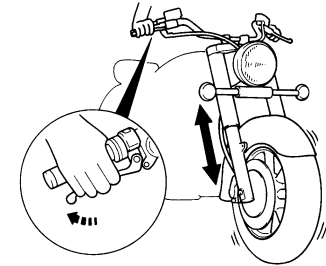

ECA10590

### CAUTION:

**If any damage is found or the front fork does not operate smoothly, have a Yamaha dealer check or repair it.**

EAU23280

## Checking the steering

Worn or loose steering bearings may cause danger. Therefore, the operation of the steering must be checked as follows at the intervals specified in the periodic maintenance and lubrication chart.

1. Place a stand under the engine to raise the front wheel off the ground.

EWA10750



**WARNING**

**Securely support the vehicle so that there is no danger of it falling over.**

2. Hold the lower ends of the front fork legs and try to move them forward and backward. If any free play can be felt, have a Yamaha dealer check or repair the steering.



EAU23290

## Checking the wheel bearings

The front and rear wheel bearings must be checked at the intervals specified in the periodic maintenance and lubrication chart. If there is play in the wheel hub or if the wheel does not turn smoothly, have a Yamaha dealer check the wheel bearings.

# PERIODIC MAINTENANCE AND MINOR REPAIR

## Battery

EAU23370

EWA10760

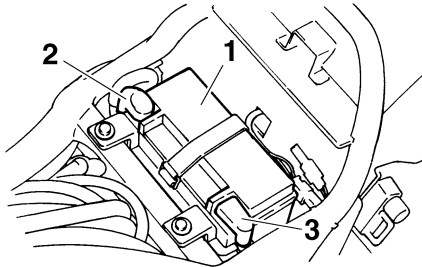

1. Battery
2. Negative battery terminal
3. Positive battery terminal

6

This model is equipped with a sealed-type (MF) battery, which does not require any maintenance. There is no need to check the electrolyte or to add distilled water.

ECA10620

### CAUTION:

**Never attempt to remove the battery cell seals, as this would permanently damage the battery.**

### WARNING

- **Electrolyte is poisonous and dangerous since it contains sulfuric acid, which causes severe burns. Avoid any contact with skin, eyes or clothing and always shield your eyes when working near batteries. In case of contact, administer the following FIRST AID.**
  - **EXTERNAL:** Flush with plenty of water.
  - **INTERNAL:** Drink large quantities of water or milk and immediately call a physician.
  - **EYES:** Flush with water for 15 minutes and seek prompt medical attention.
- **Batteries produce explosive hydrogen gas. Therefore, keep sparks, flames, cigarettes, etc., away from the battery and provide sufficient ventilation when charging it in an enclosed space.**

- **KEEP THIS AND ALL BATTERIES OUT OF THE REACH OF CHILDREN.**

### To charge the battery

Have a Yamaha dealer charge the battery as soon as possible if it seems to have discharged. Keep in mind that the battery tends to discharge more quickly if the vehicle is equipped with optional electrical accessories.

### To store the battery

1. If the vehicle will not be used for more than one month, remove the battery, fully charge it, and then place it in a cool, dry place.
2. If the battery will be stored for more than two months, check it at least once a month and fully charge it if necessary.
3. Fully charge the battery before installation.
4. After installation, make sure that the battery leads are properly connected to the battery terminals.

# PERIODIC MAINTENANCE AND MINOR REPAIR

ECA10630

## CAUTION:

- Always keep the battery charged. Storing a discharged battery can cause permanent battery damage.
- To charge a sealed-type (MF) battery, a special (constant-voltage) battery charger is required. Using a conventional battery charger will damage the battery. If you do not have access to a sealed-type (MF) battery charger, have a Yamaha dealer charge your battery.

EAU23663

## Replacing the fuses

The main fuse is located behind panel C. (See page 6-8.)

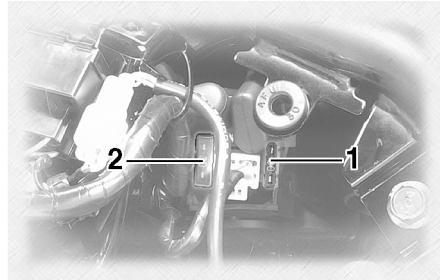

1. Main fuse
2. Spare main fuse

Fuse box 1 is located behind cowling A. (See page 6-8.)

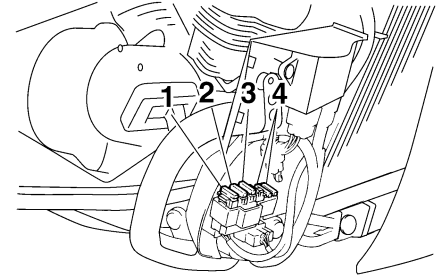

1. Cruise control fuse
2. Carburetor heater fuse
3. Auxiliary DC connector fuse
4. Spare fuse

Fuse box 2 is located behind panel B. (See page 6-8.)

# PERIODIC MAINTENANCE AND MINOR REPAIR

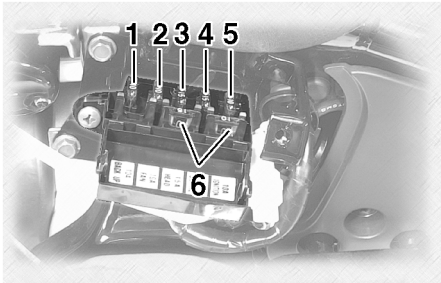

1. Backup fuse (for odometer and clock)
2. Radiator fan fuse
3. Headlight fuse
4. Signaling system fuse
5. Ignition fuse
6. Spare fuse

6

If a fuse is blown, replace it as follows.

1. Turn the key to “OFF” and turn off the electrical circuit in question.
2. Remove the blown fuse, and then install a new fuse of the specified amperage.

## Specified fuses:

- Main fuse:  
30.0 A
- Cruise control fuse:  
10.0 A
- Carburetor heater fuse:  
15.0 A
- Auxiliary DC connector fuse:  
5.0 A
- Ignition fuse:  
10.0 A
- Signaling system fuse:  
15.0 A
- Headlight fuse:  
15.0 A
- Radiator fan fuse:  
10.0 A
- Backup fuse:  
10.0 A

ECA10640

## CAUTION:

**Do not use a fuse of a higher amperage rating than recommended to avoid causing extensive damage to the electrical system and possibly a fire.**

3. Turn the key to “ON” and turn on the electrical circuit in question to check if the device operates.

4. If the fuse immediately blows again, have a Yamaha dealer check the electrical system.

# PERIODIC MAINTENANCE AND MINOR REPAIR

EAU23792

## Replacing the headlight bulb

This model is equipped with a quartz bulb headlight. If the headlight bulb burns out, replace it as follows.

1. Remove the headlight unit by removing the screws.

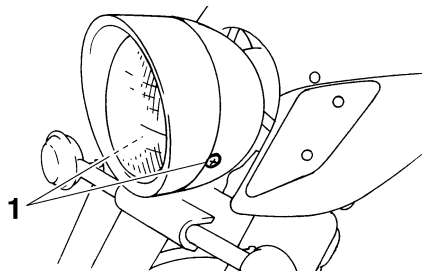

1. Screw

2. Disconnect the headlight coupler, and then remove the bulb cover.

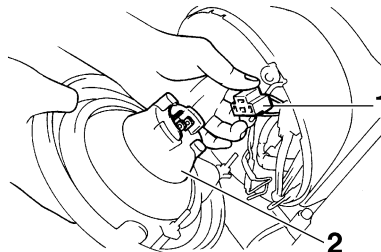

1. Headlight coupler
2. Headlight bulb cover

3. Unhook the headlight bulb holder, and then remove the defective bulb.

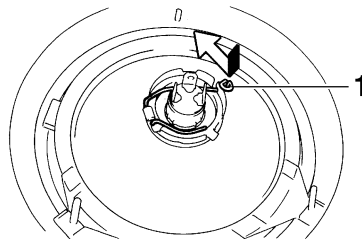

1. Headlight bulb holder

EWA10790

## WARNING

Headlight bulbs get very hot. Therefore, keep flammable products away from a lit headlight bulb, and do not touch the bulb until it has cooled down.

4. Place a new headlight bulb into position, and then secure it with the bulb holder.

ECA10660

## CAUTION:

Do not touch the glass part of the headlight bulb to keep it free from oil, otherwise the transparency of the glass, the luminosity of the bulb, and the bulb life will be adversely affected. Thoroughly clean off any dirt and fingerprints on the headlight bulb using a cloth moistened with alcohol or thinner.

# PERIODIC MAINTENANCE AND MINOR REPAIR

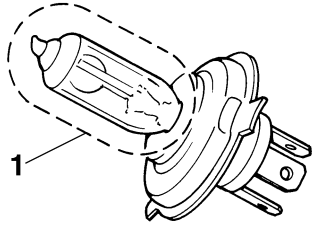

1. Do not touch the glass part of the bulb.
5. Install the headlight bulb cover, and then connect the coupler.
6. Install the headlight unit by installing the screws.
7. Have a Yamaha dealer adjust the headlight beam if necessary.

## Replacing a turn signal light bulb or the tail/brake light bulb

EAU24281

1. Remove the lens by removing the screws.

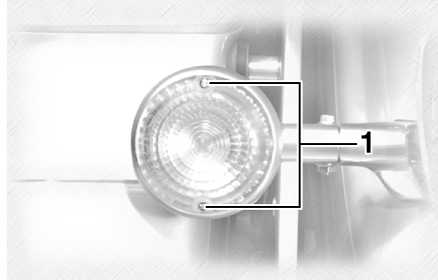

1. Screw

2. Remove the defective bulb by pushing it in and turning it counter-clockwise.
3. Insert a new bulb into the socket, push it in, and then turn it clockwise until it stops.
4. Install the lens by installing the screws.

ECA10680

### **CAUTION:**

**Do not overtighten the screws, otherwise the lens may break.**

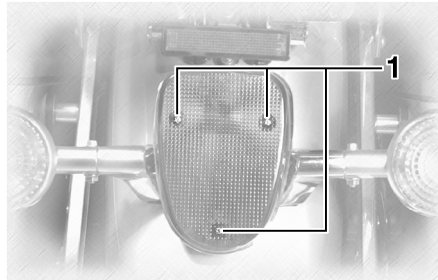

1. Screw

## Supporting the motorcycle

EAU24350

Since this model is not equipped with a centerstand, follow these precautions when removing the front and rear wheel or performing other maintenance requiring the motorcycle to stand upright. Check that the motorcycle is in a stable and level position before starting any maintenance. A strong wooden box can be placed under the engine for added stability.

### To service the front wheel

1. Stabilize the rear of the motorcycle by using a motorcycle stand or, if an additional motorcycle stand is not available, by placing a jack under the frame in front of the rear wheel.
2. Raise the front wheel off the ground by using a motorcycle stand.

### To service the rear wheel

Raise the rear wheel off the ground by using a motorcycle stand or, if a motorcycle stand is not available, by placing

a jack either under each side of the frame in front of the rear wheel or under each side of the swingarm.

## Troubleshooting

EAU25870

Although Yamaha motorcycles receive a thorough inspection before shipment from the factory, trouble may occur during operation. Any problem in the fuel, compression, or ignition systems, for example, can cause poor starting and loss of power.

The following troubleshooting charts represent quick and easy procedures for checking these vital systems yourself. However, should your motorcycle require any repair, take it to a Yamaha dealer, whose skilled technicians have the necessary tools, experience, and know-how to service the motorcycle properly.

Use only genuine Yamaha replacement parts. Imitation parts may look like Yamaha parts, but they are often inferior, have a shorter service life and can lead to expensive repair bills.

# PERIODIC MAINTENANCE AND MINOR REPAIR

EAU25911

## Troubleshooting charts

### Starting problems or poor engine performance

EWA10840



**WARNING**

Keep away open flames and do not smoke while checking or working on the fuel system.

#### 1. Fuel

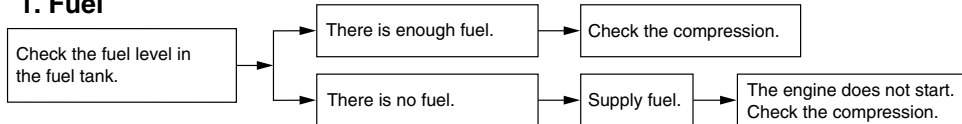

#### 2. Compression

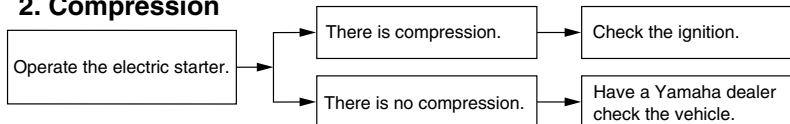

#### 3. Ignition

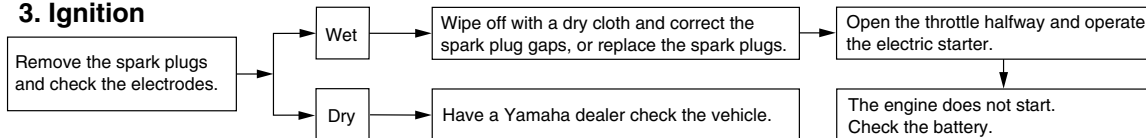

#### 4. Battery

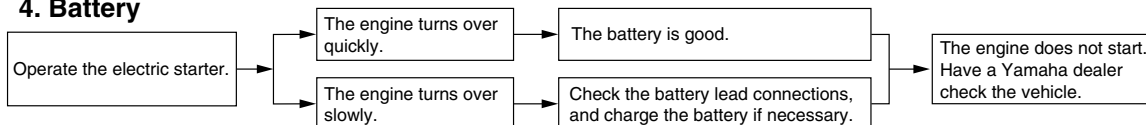

# PERIODIC MAINTENANCE AND MINOR REPAIR

## Engine overheating

EWA10400

### WARNING

- Do not remove the radiator cap when the engine and radiator are hot. Scalding hot fluid and steam may be blown out under pressure, which could cause serious injury. Be sure to wait until the engine has cooled.
- After removing the radiator cap retaining bolt, place a thick rag, like a towel, over the radiator cap, and then slowly rotate the cap counterclockwise to the detent to allow any residual pressure to escape. When the hissing sound has stopped, press down on the cap while turning it counterclockwise, and then remove the cap.

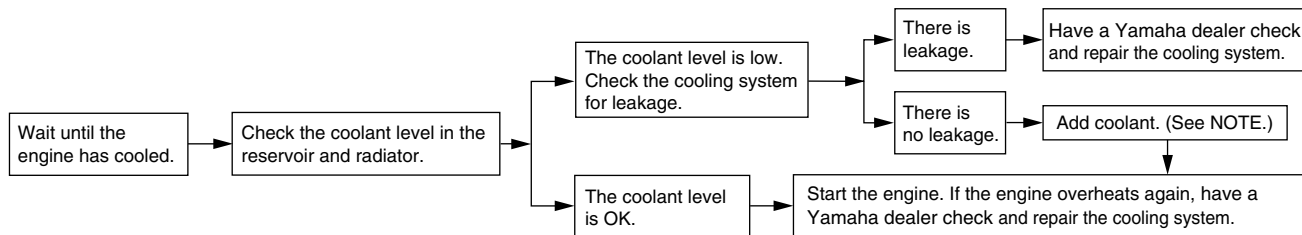

### NOTE:

If coolant is not available, tap water can be temporarily used instead, provided that it is changed to the recommended coolant as soon as possible.

# MOTORCYCLE CARE AND STORAGE

---

## Cleaning

Frequent, thorough cleaning of your motorcycle not only enhances its appearance, but also improves its performance and extends its life.

EAU38010

ECA10730

### CAUTION:

---

- **Improper cleaning can damage the windshield, cowlings, panels and other plastic parts. Use only a soft, clean cloth or sponge with mild detergent and water to clean plastic. If the windshield is scratched, use a quality plastic polishing compound after washing.**
  - **Do not use any harsh chemical products on plastic parts. Make sure to avoid using cloths or sponges which have been in contact with strong or abrasive cleaning products, solvent or thinner, fuel (gasoline), rust removers or inhibitors, brake fluid, antifreeze or electrolyte.**
- 

## Before cleaning the motorcycle

1. Cover the muffler outlets, to prevent water entry, with plastic bags and strong rubber bands.
2. Make sure that the spark plugs and all caps and covers are properly installed.
3. Apply Yamaha Mud and Grease Release or another high-quality degreaser to the crankcase, to remove any excessive grease, with a paintbrush. Do not apply degreaser to the wheel axles.

## Cleaning the motorcycle

1. Rinse any dirt and degreaser off with a garden hose, using only enough pressure to do the job.

ECA15250

### CAUTION:

---

- **Do not use high-pressure washers, since excessive high pressure may cause water seepage and deterioration of wheel bearings, the front fork, brakes, transmission seals, sidecases, and electrical parts.**

- **Many expensive repair bills have resulted from improper high-pressure washer applications, such as those available at coin-operated car washers.**
- 

2. Once the majority of the dirt has been hosed off, wash all surfaces with warm water and a mild detergent. Use a toothbrush or bottlebrush to get into those hard-to-reach places.
3. Rinse the motorcycle off immediately with clean water and dry all surfaces with a chamois, clean towel, or soft absorbent cloth.
4. Clean the seat with Yamaha Protectant or another high-quality vinyl upholstery cleaner to keep the cover pliable and glossy.

## Cleaning the windshield

Avoid using any alkaline or strong acid cleaner, gasoline, brake fluid, or any other solvent. Clean the windshield with a cloth or sponge dampened with a mild detergent, and then wash it off thoroughly with water. For additional cleaning, use Yamaha Windshield Cleaner

# MOTORCYCLE CARE AND STORAGE

or another high-quality windshield cleaner. Some cleaning compounds for plastics may leave scratches on the windshield. Before using such cleaners, test an area of the windshield which does not affect your visibility and which cannot be easily recognized.

## After cleaning the motorcycle

Apply Yamaha Silicone Wax or another high-quality automotive-type wax on all painted and chrome-plated surfaces. Avoid combination cleaner-waxes, since many contain abrasives that may mar the paint or protective finish. When finished, start the engine and let it idle for several minutes.

## Storage

Long term storage (60 days or more) of your motorcycle will require some preventive measures to guard against deterioration. After the motorcycle has been thoroughly cleaned, prepare it for storage as follows:

1. Fill the fuel tank with fresh fuel and add the following amount of Yamaha Fuel Conditioner and Stabilizer or another high-quality fuel stabilizer:

1 fluid oz per gallon or 7.5 ml per liter

Operate the engine for several minutes to insure the newly conditioned fuel enters the entire fuel system and carburetors.

### NOTE:

Use of Yamaha Fuel Conditioner and Stabilizer eliminates the need to drain the fuel system. If necessary, have a Yamaha dealer drain the fuel system.

2. Remove the spark plugs and pour about one tablespoon of SAE 10W-30 or SAE 20W-40 engine oil in each spark plug bore. Install the

spark plugs and ground the spark plug leads to prevent sparking while turning the engine over several times to coat the cylinder walls with oil.

### WARNING

**To prevent sparking, make sure to remove the spark plug leads and ground them before using the starter motor to crank the engine.**

3. Lubricate all control cables.

### NOTE:

Use a Yamaha Power Cable Luber and Yamaha Lube Zall or another high-quality equivalent to pressure-lubricate the cables and to purge out any moisture between the inner and outer cables.

4. Block the frame up so that both of its wheels are off the ground.
5. Cover the exhaust pipes with plastic bags to prevent moisture from entering them.

EAU26290

EWA10850

# MOTORCYCLE CARE AND STORAGE

---

6. If storing in a humid or salt-air atmosphere, coat all exposed metal surfaces with a light film of oil. Do not apply oil to any rubber parts or the seat cover.
7. Remove the battery and fully charge it. Store it in a cool, dry place and charge it once a month. Do not store the battery in an excessively cold or warm place [less than 0 °C (30 °F) or more than 30 °C (90 °F)]. For more information on storing the battery, see page 6-32.

**NOTE:** \_\_\_\_\_

If necessary, make repairs before storing the motorcycle.

---

## Dimensions:

- Overall length:  
2505 mm (98.6 in)
- Overall width:  
1010 mm (39.8 in)
- Overall height:  
1525 mm (60.0 in)
- Seat height:  
740 mm (29.1 in)
- Wheelbase:  
1715 mm (67.5 in)
- Ground clearance:  
150 mm (5.91 in)
- Minimum turning radius:  
3500 mm (137.8 in)

## Weight:

- With oil and fuel:  
383.0 kg (844 lb)

## Engine:

- Engine type:  
Liquid cooled 4-stroke, DOHC
- Cylinder arrangement:  
V-type 4-cylinder
- Displacement:  
1294.0 cm<sup>3</sup>
- Bore × stroke:  
79.0 × 66.0 mm (3.11 × 2.60 in)
- Compression ratio:  
10.00 :1
- Starting system:  
Electric starter
- Lubrication system:  
Wet sump

## Engine oil:

- Type:  
YAMALUBE 4, SAE10W30 or SAE20W40

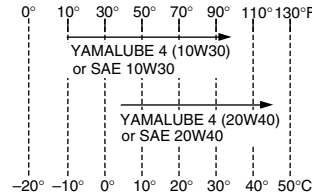

- Recommended engine oil grade:  
API service SG type or higher, JASO standard MA
- Engine oil quantity:  
Without oil filter cartridge replacement:  
3.50 L (3.70 US qt) (3.08 Imp.qt)  
With oil filter cartridge replacement:  
3.70 L (3.91 US qt) (3.26 Imp.qt)

## Final gear oil:

- Type:  
SAE80 API GL-4 Hypoid gear oil
- Quantity:  
0.20 L (0.21 US qt) (0.18 Imp.qt)

## Cooling system:

- Coolant reservoir capacity (up to the maximum level mark):  
0.35 L (0.37 US qt) (0.31 Imp.qt)
- Radiator capacity (including all routes):  
3.50 L (3.70 US qt) (3.08 Imp.qt)

## Air filter:

- Air filter element:  
Dry element

## Fuel:

- Recommended fuel:  
Unleaded gasoline only
- Fuel tank capacity:  
20.0 L (5.28 US gal) (4.40 Imp.gal)
- Fuel reserve amount:  
3.9 L (1.03 US gal) (0.86 Imp.gal)

## Carburetor:

- Manufacturer:  
MIKUNI
- Type × quantity:  
BDSR32 x 4

## Spark plug (s):

- Manufacturer/model:  
NGK/DPR8EA-9
- Manufacturer/model:  
DENSO/X24EPR-U9
- Spark plug gap:  
0.8–0.9 mm (0.031–0.035 in)

## Clutch:

- Clutch type:  
Wet, multiple-disc

## Transmission:

- Primary reduction system:  
Spur gear
- Primary reduction ratio:  
87/49 (1.776)
- Secondary reduction system:  
Shaft drive
- Secondary reduction ratio:  
21/27 × 33/10 (2.567)

# SPECIFICATIONS

Transmission type:  
Constant mesh 5-speed

Operation:  
Left foot operation

Gear ratio:  
1st:  
43/17 (2.529)  
2nd:  
31/19 (1.632)  
3rd:  
30/25 (1.200)  
4th:  
24/25 (0.960)  
5th:  
22/28 (0.786)

## Chassis:

Frame type:  
Double cradle  
Caster angle:  
28.83 °  
Trail:  
131.0 mm (5.16 in)

## Front tire:

Type:  
Tubeless  
Size:  
150/80-16M/C 71H  
Manufacturer/model:  
BRIDGESTONE/G705G

## Rear tire:

Type:  
Tubeless  
Size:  
150/90B15M/C 74H

Manufacturer/model:  
BRIDGESTONE/G702G

## Loading:

Maximum load:  
201 kg (443 lb)  
(Total weight of rider, passenger, cargo and accessories)

## Tire air pressure (measured on cold tires):

Loading condition:  
0–90 kg (0–198 lb)  
Front:  
250 kPa (36 psi) (2.50 kgf/cm<sup>2</sup>)  
Rear:  
250 kPa (36 psi) (2.50 kgf/cm<sup>2</sup>)  
Loading condition:  
90–201 kg (198–443 lb)  
Front:  
250 kPa (36 psi) (2.50 kgf/cm<sup>2</sup>)  
Rear:  
280 kPa (41 psi) (2.80 kgf/cm<sup>2</sup>)

## Front wheel:

Wheel type:  
Cast wheel  
Rim size:  
16M/C x MT3.50

## Rear wheel:

Wheel type:  
Cast wheel  
Rim size:  
15M/C x MT4.00

## Front brake:

Type:  
Dual disc brake

Operation:  
Right hand operation

Recommended fluid:  
DOT 4

## Rear brake:

Type:  
Single disc brake  
Operation:  
Right foot operation  
Recommended fluid:  
DOT 4

## Front suspension:

Type:  
Telescopic fork  
Spring/shock absorber type:  
Coil-air spring/oil damper  
Wheel travel:  
140.0 mm (5.51 in)

## Rear suspension:

Type:  
Swingarm (link suspension)  
Spring/shock absorber type:  
Coil-air spring/oil damper  
Wheel travel:  
105.0 mm (4.13 in)

## Electrical system:

Ignition system:  
Transistorized coil ignition (digital)  
Charging system:  
AC magneto

## Battery:

Model:  
YTX20L-BS

Voltage, capacity:  
12 V, 18.0 Ah

## Headlight:

Bulb type:  
Halogen bulb

## Bulb voltage, wattage × quantity:

Headlight:  
12 V, 60 W/55.0 W × 1

Tail/brake light:  
12 V, 8.0 W/27.0 W × 1

Front turn signal/position light:  
12 V, 23 W/8.0 W × 2

Rear turn signal light:  
12 V, 21.0 W × 2

Meter lighting:  
LED

Neutral indicator light:  
LED

High beam indicator light:  
LED

Oil level warning light:  
LED

Turn signal indicator light:  
LED

Coolant temperature warning light:  
LED

Engine trouble warning light:  
LED

Overdrive indicator light:  
LED

Cruise control "SET" indicator light:  
LED

Cruise control "ON" indicator light:  
LED

## Fuses:

Main fuse:  
30.0 A

Headlight fuse:  
15.0 A

Signaling system fuse:  
15.0 A

Ignition fuse:  
10.0 A

Radiator fan fuse:  
10.0 A

Carburetor heater fuse:  
15.0 A

Cruise control fuse:  
10.0 A

Auxiliary DC connector fuse:  
5.0 A

Backup fuse:  
10.0 A

# CONSUMER INFORMATION

EAU26351

## Identification numbers

Record the key identification number, vehicle identification number and model label information in the spaces provided below for assistance when ordering spare parts from a Yamaha dealer or for reference in case the vehicle is stolen.

KEY IDENTIFICATION NUMBER:

VEHICLE IDENTIFICATION NUMBER:

MODEL LABEL INFORMATION:

## Key identification number

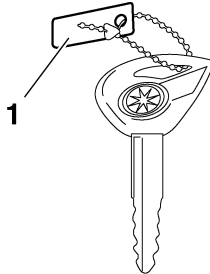

1. Key identification number

The key identification number is stamped into the key tag. Record this number in the space provided and use it for reference when ordering a new key.

EAU26381

## Vehicle identification number

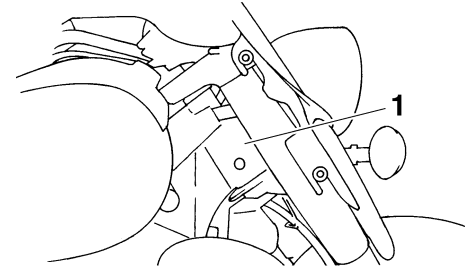

1. Vehicle identification number

The vehicle identification number is stamped into the steering head pipe. Record this number in the space provided.

**NOTE:** \_\_\_\_\_

The vehicle identification number is used to identify your motorcycle and may be used to register your motorcycle with the licensing authority in your area.

\_\_\_\_\_

EAU26400

EAU26470

## Model label

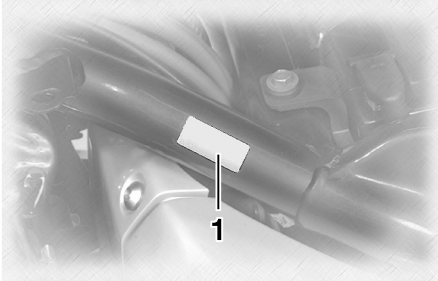

### 1. Model label

The model label is affixed to the frame under the rider seat. (See page 3-12.) Record the information on this label in the space provided. This information will be needed when ordering spare parts from a Yamaha dealer.

# CONSUMER INFORMATION

---

---

EAU26550

## Reporting safety defects

If you believe that your vehicle has a defect which could cause a crash or could cause injury or death, you should immediately inform the National Highway Traffic Safety Administration (NHTSA) in addition to notifying Yamaha Motor Corporation, U.S.A. If NHTSA receives similar complaints, it may open an investigation, and if it finds that a safety defect exists in a group of vehicles, it may order a recall and remedy campaign. However, NHTSA cannot become involved in individual problems between you, your dealer, or Yamaha Motor Corporation, U.S.A.

To contact NHTSA, you may either call the Auto Safety Hotline toll-free at 1-800-424-9393 (or 366-0123 in Washington, D.C. area) or write to: NHTSA, U.S. Department of Transportation, Washington, D.C. 20590. You can also obtain other information about motor vehicle safety from the Hotline.

## Motorcycle noise regulation

### TAMPERING WITH NOISE CONTROL SYSTEM PROHIBITED:

Federal law prohibits the following acts or the causing thereof: (1) The removal or rendering inoperative by any person other than for purposes of maintenance, repair, or replacement of any device or element of design incorporated into any new vehicle for the purpose of noise control prior to its sale or delivery to the ultimate purchaser or while it is in use or (2) the use of the vehicle after such device or element of design has been removed or rendered inoperative by any person.

“AMONG THOSE ACTS PRESUMED TO CONSTITUTE TAMPERING ARE THE ACTS LISTED BELOW”.

These acts include tampering with the following systems; i.e., modification, removal, etc.

#### **Exhaust system**

- Muffler
- Exhaust pipe
- Silencer

#### **Intake system**

- Air cleaner case
- Air cleaner element
- Intake duct

# CONSUMER INFORMATION

EAU26632

## Maintenance record

Copies of work orders and/or receipts for parts purchased and installed on your vehicle will be required to document that maintenance has been completed in accordance with the emissions warranty. The chart below is printed only as a reminder that maintenance work is required. It is not acceptable proof of maintenance work.

Maintenance interval	Date of service	Mileage	Servicing dealer name and address	Remarks
600 mi (1000 km) or 1 month				
4000 mi (7000 km) or 6 months				
8000 mi (13000 km) or 12 months				
12000 mi (19000 km) or 18 months				
16000 mi (25000 km) or 24 months				
20000 mi (31000 km) or 30 months				
24000 mi (37000 km) or 36 months				
28000 mi (43000 km) or 42 months				
32000 mi (49000 km) or 48 months				

# CONSUMER INFORMATION

Maintenance interval	Date of service	Mileage	Servicing dealer name and address	Remarks
36000 mi (55000 km) or 54 months				
40000 mi (61000 km) or 60 months				

# CONSUMER INFORMATION

## YAMAHA MOTOR CORPORATION, U.S.A. ROYAL STAR™ SERIES LIMITED WARRANTY

EAU26693

Yamaha Motor Corporation, U.S.A. hereby warrants that each new Yamaha Royal Star Series motorcycle purchased from an authorized Yamaha motorcycle dealer in the continental United States will be free from defects in material or workmanship for the period of time stated herein, subject to certain stated limitations.

**THE PERIOD OF WARRANTY** for the Yamaha Royal Star Series including windshield, saddlebags, and mounting hardware installed as original equipment, shall be five (5) years from the date of purchase, regardless of mileage.

**MODELS EXCLUDED FROM WARRANTY** include those used for non-Yamaha-authorized renting, leasing, or other commercial purposes.

**DURING THE PERIOD OF WARRANTY** any authorized Yamaha motorcycle dealer will, free of charge, repair or replace any part adjudged defective by Yamaha due to faulty workmanship or material from the factory. Parts used in warranty repairs will be warranted for the balance of the product's warranty period. All parts replaced under warranty become property of Yamaha Motor Corporation, U.S.A..

**GENERAL EXCLUSIONS** from this warranty shall include any failures caused by:

- a. Competition or racing use.
- b. Installation of parts or accessories that are not qualitatively equivalent to genuine Yamaha parts.
- c. Abnormal strain, neglect, or abuse.
- d. Lack of proper maintenance or storage.
- e. Accident or collision damage.
- f. Modification to original parts.
- g. Damage due to improper transportation.

**SPECIFIC EXCLUSIONS** from this warranty shall include:

1. The cost of parts and labor for routine maintenance or normal wear and tear. Examples include periodic oil changes and lubrication, filter cleaning and replacement, spark plugs, tuneups, coolant, and brake and clutch adjustment.
2. Battery deterioration caused by improper maintenance and/or storage.

**THE CUSTOMER'S RESPONSIBILITY** under this warranty shall be to:

Operate and maintain the Royal Star Series as specified in the appropriate Owner's Manual, and Give notice to an authorized Yamaha motorcycle dealer of any and all apparent defects within ten (10) days after discovery, and make the machine available at that time for inspection and repairs at such dealer's place of business.

### WARRANTY TRANSFER

To transfer the warranty from the original purchaser to any subsequent purchaser, it is imperative that the machine be inspected and registered for warranty by an authorized Yamaha motorcycle dealer. In order for this warranty to remain in effect, this inspection and registration must take place within ten (10) days after transfer of ownership to the subsequent purchaser. A reasonable dealer-imposed fee may be charged for the inspection.

### EMISSIONS CONTROL SYSTEM WARRANTY

Yamaha Motor Corporation, U.S.A. also warrants to the ultimate purchaser and each subsequent purchaser of each Royal Star Series that the vehicle is designed, built, and equipped so as to conform at the time of sale with all U.S. emissions standards applicable at the time of manufacture, and that it is free from defects in materials and workmanship which would cause it not to meet these standards for 18,642 miles (30,000 km) or five years, whichever occurs first. Failures other than those resulting from defects in material or workmanship which arise solely as a result of owner abuse and/or lack of proper maintenance are not covered by this warranty.

**YAMAHA MOTOR CORPORATION, U.S.A. MAKES NO OTHER WARRANTY OF ANY KIND, EXPRESSED OR IMPLIED. ALL IMPLIED WARRANTIES OF MERCHANTABILITY AND FITNESS FOR A PARTICULAR PURPOSE WHICH EXCEED THE OBLIGATIONS AND TIME LIMITS STATED IN THIS WARRANTY ARE HEREBY DISCLAIMED BY YAMAHA MOTOR CORPORATION, U.S.A. AND EXCLUDED FROM THIS WARRANTY.**

**SOME STATES DO NOT ALLOW LIMITATIONS ON HOW LONG AN IMPLIED WARRANTY LASTS, SO THE ABOVE LIMITATION MAY NOT APPLY TO YOU. ALSO EXCLUDED FROM THIS WARRANTY ARE ANY INCIDENTAL OR CONSEQUENTIAL DAMAGES INCLUDING LOSS OF USE. SOME STATES DO NOT ALLOW THE EXCLUSION OR LIMITATION OF INCIDENTAL OR CONSEQUENTIAL DAMAGES, SO THE ABOVE EXCLUSIONS MAY NOT APPLY TO YOU.**

**THIS WARRANTY GIVES YOU SPECIFIC LEGAL RIGHTS, AND YOU MAY ALSO HAVE OTHER RIGHTS WHICH VARY FROM STATE TO STATE.**

YAMAHA MOTOR CORPORATION, U.S.A.  
Post Office Box 6555  
Cypress, CA 90630

## WARRANTY QUESTIONS AND ANSWERS

- Q. What costs are my responsibility during the warranty period?
- A. The customer's responsibility includes all costs of normal maintenance services, non-warranty repairs, accident and collision damage, and oil, oil filters, air filters, spark plugs, and brake shoes or pads.
- Q. What are some examples of "abnormal" strain, neglect, or abuse?
- A. These terms are general and overlap each other in areas. Specific examples include: Running the machine out of oil, sustained high-rpm, full-throttle use; operating the machine with a broken or damaged part which causes another part to fail; damage or failure due to improper or careless transportation and or tie down; and so on. If you have any specific questions on operation or maintenance, please contact your dealer for advice.
- Q. Does the warranty cover incidental costs such as towing or transportation due to a failure?
- A. No. The warranty is limited to repair of the machine itself.
- Q. May I perform any or all of the recommended maintenance shown in the Owner's Manual instead of having the dealer do them?
- A. Yes, if you are a qualified mechanic and follow the procedures specified in the Owner's and Service Manual. We do recommend, however, that items requiring special tools or equipment be done by Yamaha motorcycle dealer.
- Q. Will the warranty be void or cancelled if I do not operate or maintain my new motorcycle exactly as specified in the Owner's Manual?
- A. No. The warranty on a new motorcycle cannot be "voided" or "cancelled". **However, if a particular failure is caused by operation or maintenance other than as shown in the Owner's Manual, that failure may not be covered under warranty.**
- Q. What responsibility does my dealer have under this warranty?
- A. Each Yamaha Motorcycle dealer is expected to:
1. Completely set up every new machine before sale.
  2. Explain the operation, maintenance, and warranty requirements to your satisfaction at the time of sale, and upon your request at any later date. In addition, each Yamaha motorcycle dealer is held responsible for his setup, service and warranty repair work.
- Q. Is the warranty transferable to second owners?
- A. Yes. The remainder of the existing warranty can be transferred upon request. The unit has to be inspected and re-registered by an authorized Yamaha motorcycle dealer for the warranty coverage to remain effective.

## CUSTOMER SERVICE

If your machine requires warranty service, you must take it to any authorized Yamaha motorcycle dealer within the continental United States. Be sure to bring your warranty registration identification or other valid proof of the original date of purchase. If a question or problem arises regarding warranty, first contact the owner of the dealership. Since all warranty matters are handled at the dealer level, this person is in the best position to help you. If you are still not satisfied and require additional assistance, please write:

YAMAHA MOTOR CORPORATION U.S.A.  
CUSTOMER RELATIONS DEPARTMENT  
P.O. Box 6555  
Cypress, California 90630

When contacting Yamaha Motor Corporation, U.S.A. don't forget to include any important information such as names, addresses, model, V.I.N. (frame number), dates, and receipts.

## CHANGE OF ADDRESS

The federal government requires each manufacturer of a motor vehicle to maintain a complete, up-to-date list of all first purchasers against the possibility of a safety-related defect and recall. This list is compiled from the purchase registrations sent to Yamaha Motor Corporation, U.S.A. by the selling dealer at the time of your purchase.

If you should move after you have purchased your new motorcycle, please advise us of your new address by sending a postcard listing your motorcycle model name, V.I.N. (frame number), dealer number (or dealer's name) as it is shown on your warranty identification, your name and new mailing address.

Mail to:

YAMAHA MOTOR CORPORATION, U.S.A.  
P.O. Box 6555  
Cypress, California 90630  
Attention: Warranty Department

This will ensure that Yamaha Motor Corporation, U.S.A. has an up-to-date registration record in accordance with federal law.

# INDEX

---

## A

- Accessories and replacement parts ..... 6-23
- Air filter elements, cleaning ..... 6-18
- Auxiliary DC connector ..... 3-21

## B

- Battery ..... 6-32
- Brake and clutch fluid levels,  
checking ..... 6-26
- Brake and clutch fluids, changing ..... 6-27
- Brake and clutch levers, checking and  
lubricating ..... 6-29
- Brake and shift pedals, checking and  
lubricating ..... 6-28
- Brake lever ..... 3-8
- Brake lever free play, adjusting ..... 6-24
- Brake pedal ..... 3-8

## C

- Cables, checking and lubricating ..... 6-27
- Canister (for California only) ..... 6-12
- Carburetors ..... 6-20
- Cleaning ..... 7-1
- Clutch lever ..... 3-7, 6-24
- Coolant ..... 6-16
- Coolant temperature warning light ..... 3-3
- Cowlings and panels, removing and  
installing ..... 6-8
- Cruise control indicator lights ..... 3-2
- Cruise control switches ..... 3-7
- Cruise control system ..... 3-5

## D

- Dimmer switch ..... 3-7

## E

- Engine break-in ..... 5-4
- Engine oil and oil filter cartridge ..... 6-12

- Engine, starting a warm ..... 5-3
- Engine stop switch ..... 3-7
- Engine trouble warning light ..... 3-3

## F

- Final gear oil ..... 6-15
- Front and rear brake pads, checking .... 6-25
- Front fork, adjusting ..... 3-17
- Front fork, checking ..... 6-30
- Fuel ..... 3-9
- Fuel cock ..... 3-10
- Fuel tank cap ..... 3-9
- Fuses, replacing ..... 6-33

## H

- Handlebar switches ..... 3-6
- Headlight bulb, replacing ..... 6-35
- Helmet holder ..... 3-14
- High beam indicator light ..... 3-2
- Horn switch ..... 3-7

## I

- Identification numbers ..... 9-1
- Ignition circuit cut-off system ..... 3-19
- Indicator and warning lights ..... 3-2

## K

- Key identification number ..... 9-1

## L

- Labels, location of ..... 1-5

## M

- Main switch/steering lock ..... 3-1
- Maintenance and lubrication, periodic .... 6-4
- Maintenance, emission control  
system ..... 6-3
- Maintenance, periodic ..... 6-1
- Maintenance record ..... 9-5
- Model label ..... 9-2

## N

- Neutral indicator light ..... 3-2
- Noise regulation ..... 9-4

## O

- Oil level warning light ..... 3-2
- Overdrive indicator light ..... 3-3

## P

- Parking ..... 5-5
- Part locations ..... 2-1
- Passenger backrest ..... 3-13
- Pre-operation check list ..... 4-2

## R

- Rear brake light switch, adjusting ..... 6-25
- Rear suspension, lubricating ..... 6-30
- Rider seat ..... 3-12

## S

- Safety defects, reporting ..... 9-3
- Safety information ..... 1-1
- Shifting ..... 5-3
- Shift pedal ..... 3-8
- Shock absorber assembly, adjusting .... 3-17
- Sidescases ..... 3-16
- Sidestand ..... 3-18
- Sidestand, checking and lubricating ..... 6-29
- Spark plugs, checking ..... 6-11
- Specifications ..... 8-1
- Speedometer unit ..... 3-3
- Starter (choke) knob ..... 3-11
- Starting and warming up a cold  
engine ..... 5-1
- Start switch ..... 3-7
- Steering, checking ..... 6-31
- Steering, locking with a padlock ..... 3-12
- Storage ..... 7-2

Supporting the motorcycle ..... 6-37  
Swingarm pivots, lubricating ..... 6-29

## T

Throttle cable free play, checking ..... 6-20  
Throttle grip and cable, checking and  
lubricating ..... 6-28  
Tires ..... 6-21  
Tool kit ..... 6-1  
Troubleshooting ..... 6-37  
Troubleshooting charts ..... 6-38  
Turn signal indicator light ..... 3-2  
Turn signal light bulb or tail/brake  
light bulb, replacing ..... 6-36  
Turn signal switch ..... 3-7

## V

Valve clearance ..... 6-20  
Vehicle identification number ..... 9-1

## W

Warranty, limited ..... 9-7  
Wheel bearings, checking ..... 6-31  
Wheels ..... 6-22  
Windshield ..... 3-15

***PROTECT YOUR INVESTMENT***

***Use Genuine YAMAHA Parts And Accessories***

***See your Authorized YAMAHA Dealer for a Genuine YAMAHA Service Manual.***



YAMAHA MOTOR CO., LTD.

PRINTED ON RECYCLED PAPER

PRINTED IN JAPAN  
2006.05-0.3×1 CR  
(E)