



INTERNAL
E-IDE/ATAPI
3200E-VK World

English

Deutsch

Français

Español

CD-R/RW DRIVE

CRW3200E SERIES

OWNER'S MANUAL
BEDIENUNGSANLEITUNG
MODE D'EMPLOI
MANUAL DE INSTRUCCIONES

24x10x40
CD-R CD-RW CD-ROM

COMPACT
disc
ReWritable High Speed



FCC INFORMATION

COMPLIANCE INFORMATION STATEMENT

(DECLARATION OF CONFORMITY PROCEDURE)

Responsible Party: Yamaha Electronics Corporation, USA.
Address: 6660 Orangethorpe Avenue
Buena Park, CA 90620
Telephone: 714-522-9105
Fax: 714-670-0108
Type of Equipment: CD Recordable/Rewritable Drive
Model Name: CRW3200
CRW3200NB

This device complies with Part 15 of the FCC Rules.

Operation is subject to the following conditions:

- 1) this device may not cause harmful interference, and
- 2) this device must accept any interference received including interference that may cause undesired operation.

See user manual instructions if interference to radio reception is suspected.

FCC INFORMATION (U.S.A.)

1. IMPORTANT NOTICE: DO NOT MODIFY THIS UNIT!

This product, when installed as indicated in the instructions contained in this manual, meets FCC requirements. Modifications not expressly approved by Yamaha may void your authority, granted by the FCC, to use the product.

2. IMPORTANT: When connecting this product to accessories and/or another product use only high quality shielded cables. Cable/s supplied with this product **MUST** be used. Follow all installation instructions. Failure to follow instructions could void your FCC authorization to use this product in the USA.

3. NOTE: This product has been tested and found to comply with the requirements listed in FCC Regulations, Part 15 for Class "B" digital devices. Compliance with these requirements provides a reasonable level of assurance that your use of this product in a residential environment will not result in harmful interference with other electronic devices. This equipment generates/uses radio frequencies and, if not installed and used according to the instructions found in the users manual, may cause interference harmful to the operation of other electronic devices. Compliance with FCC regulations does not guarantee that interference will not occur in all installations. If this product is found to be the source of interference, which can be determined by turning the product "OFF" and "ON", please try to eliminate the problem by using one of the following measures:
Relocate either this product or the device that is being affected by the interference.
Utilize power outlets that are on different branch (circuit breaker or fuse) circuits or install AC line filter/s.
In the case of radio or TV interference, relocate/reorient the antenna. If the antenna lead-in is 300 ohm ribbon lead, change the lead-in to coaxial type cable.

If these corrective measures do not produce satisfactory results, please contact the local retailer authorized to distribute this type of product. If you can not locate the appropriate retailer, please contact Yamaha Electronics Corporation, USA, 6660 Orangethorpe Avenue, Buena Park, CA 90620 U.S.A.

LASER INFORMATION

Laser Product Class: Class 1
Laser Diode Properties
Wavelength: 780 – 787 nm
Pulse Durations and Max. Output at the lens of the Laser Pickup Unit
Read Mode: 0.85 mW (Continuous)
Write Mode: Max. 48 mW
 (for 212 ns, Min. Cycle 57.9 ns)

Laserprodukt-Klasse: Klasse 1
Eigenschaften der Laserdiode
Wellenlänge: 780 – 787 nm
Impulsdauer und max. Ausgang an der Linse der Laser-Abtasteinheit
Lesemodus: 0,85 mW (kontinuierlich)
Schreibmodus: Max. 48 mW
 (für 212 ns, Zyklusmin. 57,9 ns)

Classe du produit laser: Classe 1
Caractéristiques de la diode laser
Longueur d'onde: 780 – 787 nm
Durée des impulsions et sortie maximum depuis la lentille du bloc capteur optique
Mode de lecture: 0,85 mW (continue)
Mode de gravure: max. 48 mW
 (pour 212 ns, cycle min. 57,9 ns)

Clase de producto láser: Clase 1
Propiedades del diodo láser
Longitud de onda: 780 – 787 nm
Duración del pulso y potencia de salida máxima en el objetivo de la unidad captora láser
Modo de lectura: 0,85 mW (continua)
Modo de escritura: máx. 48 mW
 (para 212 ns, ciclo mínimo 57,9 ns)

CLASS 1 LASER PRODUCT
 LASER KLASSE 1 PRODUKT
 LUOKAN 1 LASERLAITE
 KLASS 1 LASER APPARAT
 PRODUIT LASER DE CLASSE 1

DANGER - VISIBLE AND / OR INVISIBLE LASER RADIATION WHEN OPEN. AVOID DIRECT EXPOSURE TO BEAM.

COMPLIES WITH 21 CFR CHAPTER 1, SUBCHAPTER J.

CAUTION
 Use of controls or adjustments or performance of procedures other than those specified herein may result in hazardous radiation exposure.

ACHTUNG
 Halten Sie sich beim Bedienen und Einstellen der Bedienungselemente sowie bei der Bedienungsabfolge an die Anleitung, da sonst gefährliche Strahlen austreten können.

ATTENTION
 L'emploi de commandes, de réglages ou un choix de procédures différents des spécifications de cette brochure peut entraîner une exposition à d'éventuelles radiations pouvant être dangereuses.

PRECAUCION
 El usar los controles o ajustar o realizar procedimientos diferentes a los especificados aquí resultará en peligrosas exposiciones a la radiación.

VARO! AVATTAESSA JA SUOJALUKITUS OHITETTAESSA OLET ALTTINA NÄKYMÄTTÖMÄLLE LASERSÄTEILYLLE. ÄLÄ KATSO SÄTEESEEN.

VARNING! OSYNLIG LASERSTRÅLNING NÄR DENNA DEL ÄR ÖPPNAD OCH SPÄRREN ÄR URKOPPLAD. BETRAKTA EJ STRÅLEN. STRÅLEN ÄR FARLIG.

CAUTION - VISIBLE AND / OR INVISIBLE LASER RADIATION WHEN OPEN. AVOID EXPOSURE TO BEAM.
 VARNING - SYNLIG OCH / ELLER OSYNLIG LASERSTRÅLNING NÄR DENNA DEL ÄR ÖPPNAD. STRÅLEN ÄR FARLIG.
 VARO ! AVATTAESSA OLET ALTTIINA NÄKYMÄTTÖMÄLLE JA / TAI NÄKYMÄTTÖMÄLLE LASERSÄTEILYLLE. ÄLÄ KATSO SÄTEESEEN.
 VARNING - SYNLIG OCH / ELLER OSYNLIG LASERSTRÅLNING NÄR DENNA DEL ÄR ÖPPNAD. BETRAKTA EJ STRÅLEN.
 VORSICHT ! SICHTBARE UND / ODER UNSICHTBARE LASERSTRAHLUNG WENN ABECKUNG GEÖFFNET. NICHT DEM STRAHL AUSSETZEN.
 ATTENTION - RADIATION VISIBLE ET / OU INVISIBLE LORSQUE L'APPAREIL EST OUVERT. EVITEZ TOUTE EXPOSITION AU FAISCEAU.

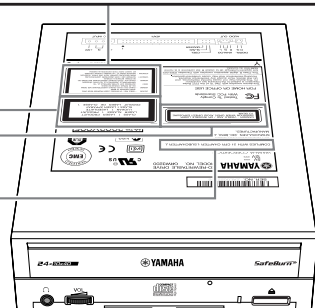



INTERNAL
E-IDE/ATAPI
3200E-VK World

CD-R/RW DRIVE

CRW3200E SERIES

24x10x40
CD-R CD-RW CD-ROM



OWNER'S MANUAL

SAFETY PRECAUTIONS

PLEASE READ THE FOLLOWING WARNINGS AND CAUTIONS CAREFULLY TO PREVENT PERSONAL INJURY AND DAMAGE TO THE DEVICE.

These precautions explain how to use the device properly and safely, thereby preventing injury to yourself and others. This section has been sub-divided into a WARNING section and a CAUTION section, according to the likelihood and nature of any potential injuries or damage inflicted. They relate to your personal safety, and also help you prevent the risk of damage to the device. Please read these sections carefully prior to proceeding.

WARNING

Always follow these basic precautions to avoid short-circuit, damage, fire, or other hazards, and to avoid serious injury or fatal accident from electrical shock.

- Do not attempt to open or disassemble the device to avoid the risk of electrical shock, fire, or malfunction.
- Do not look directly at the laser source to avoid the risk of eye damage or blindness.
- Do not insert fingers or foreign objects into the device to avoid the risk of electrical shock, fire, malfunction, or personal injury.
- Do not expose the device to high humidity or place liquid containers such as a flower vase on the device to avoid the risk of electrical shock, fire, or malfunction.
- Do not expose the device to temperature outside the range 5 – 40 °C (41 – 104 °F) to avoid the risk of fire, deformation of the device panel, or malfunction.
- Do not expose the device to dusty place to avoid the risk of fire or malfunction.
- Always follow the owner's manual to set up or connect the devices properly to avoid the risk of electrical shock, fire, malfunction, or personal injury.
- If unusual smells, sounds or smoke come from the device, or if foreign objects such as liquid get into the device, turn off and unplug the computer immediately to avoid the risk of electrical shock, fire, or malfunction. Contact the store of purchase or your nearest Yamaha dealer (listed at the back of this manual).

- Be sure that the computer is electrically grounded to avoid the risk of electrical shock.
- Prior to cleaning the drive, always unplug the computer or do not handle the plug with wet hands to avoid the risk of electrical shock.



CAUTION

Always follow these basic precautions to avoid physical injury to yourself or others, and damage to the device or other property.

- Always unplug the computer if it will not be used for a prolonged period of time or if there is possibility of lightning, to avoid the risk of electrical shock, fire, or short-circuit.
- Do not use the device near other electrical appliances such as televisions, radios, or speakers to avoid the risk of interferences between each other.
- Do not place the computer unstably to avoid the risk of malfunction or personal injury by its falling down.
- Do not place the device with a possibility of excessive vibration to avoid the risk of damage to written data or malfunction.
- Place the device horizontally to avoid the risk of damage to written data.
- Prior to transporting the device, remove the disc from the disc tray to avoid the risk of damage to written data.
- Use soft, dry cloths to wipe the device. Do not use benzene, paint thinner, detergents, or chemically treated wiped cloths, and do not place vinyl, plastic, or rubber objects on the device to avoid the risk of malfunction or damage to surface of the device.
- Do not rest your weight on or place heavy objects on the device, and do not apply excessive force to the buttons, switches, or connectors to avoid the risk of damage to the device or personal injury.
- Do not listen to audio with headphones at high volume for prolonged period of time to avoid auditory disorder.

- Prior to turning on the computer, always minimize the volume to avoid auditory disorder by a sudden burst of sound at high volume.
- Do not place the device near magnets or anything magnetized such as a display to avoid the risk of interferences between each other.
- Have the device serviced regularly to avoid internal dust buildup that can cause malfunction, damage or fire. For service information and service charges, contact the store of purchase or your nearest Yamaha dealer (listed at the back of this manual).
- This drive is for use only with movable equipment, weighing less than 18 kg.

WARRANTY

YAMAHA AND ITS SUPPLIERS ACCEPT NO LIABILITY FOR ANY PROBLEMS THAT OCCUR AS A RESULT OF ANY OPERATIONS CARRIED OUT OTHER THAN THOSE STATED IN THE MANUAL THAT COMES WITH THIS PRODUCT, OR THE LOSS OR THE DAMAGE OF ANY DATA CAUSED AS A RESULT OF USING THIS PRODUCT.

Precautions for Transportation

Transporting the device unfixed may damage its internal mechanism or circuits.

- Remove the disc from the disc tray of the device.
- Put the device in the original box.

Prior to use, check that the complete accessories are included. (Refer to the original box.)

To reduce power consumption of the CRW3200E drive, set your computer to power saving mode. (P. 36)

©2001 YAMAHA CORPORATION. All Rights Reserved.

This document may not, in whole or in part, be copied, photocopied, reproduced, translated, transmitted, or reduced to any electronic medium of machine readable form without prior consent in writing from Yamaha.

Windows is a registered trademark of Microsoft Corporation.

SafeBurn™ is a trademark of Yamaha Corporation.

All other trademarks are the property of their respective companies.

Table of Contents

Features of the CRW3200E Drive	1
Names and Functions of Parts	2
Front Panel.....	2
Rear Panel.....	3
Precautions on Use.....	4
Handling Discs	4
Copyright	4
Disclaimer of Indemnity.....	4
Useable discs	5
System Requirements	7
Preparing the CRW3200E Drive	8
Serial Number.....	8
1 Decide the Installation Method.....	9
2 Set the Jumper Switch	14
3 Install the CRW3200E Drive.....	16
4 Check Recognition of the CRW3200E Drive.....	22
5 Install CD Writing Software.....	25
Loading/Ejecting a Disc	26
Troubleshooting.....	28
Firmware.....	34
CRW3200E Drive Specifications	35
Technical Notes.....	38
Buffer Underrun Protection Function.....	38
Writing Methods.....	38

For details about how to install and use the CD writing software, refer to the documentation that comes with it.

- The information contained in this manual is subject to change without prior notice.
- Reproduction of this manual, either in part or in full, is expressly forbidden.

Features of the CRW3200E Drive

High speed writing/reading

The CRW3200E drive supports up to 24X-speed writing for CD-R discs, and up to 10X-speed writing/rewriting for CD-RW discs. In addition, the drive supports data reading and digital audio data extraction at up to 40X speed.

Tip

- The Partial CAV method permits 24X-speed writing for CD-R discs.
- The CLV method and the 4X – 10X Full CAV method permit 10X-speed writing/rewriting for CD-RW discs.

SafeBurn™ (Enhanced stability writing technology)

The generous 8MB buffer memory provides sufficient data storage to enable stable disc writing at high speeds. Even if data transfer from the computer is interrupted, the Buffer Underrun Protection function is activated to save CD-R discs from a writing error. (P. 38)
“Optimum Write Speed Control” adjusts the writing speed to the optimum rate for every CD-R disc automatically. You can set the maximum writing speed with your CD writing software.

Note

- Optimum Write Speed Control can be activated when the maximum writing speed is set at 12X or more.
- The minimum writing speed to be automatically selected is 8X. Manually set the optimum writing speed if a writing speed supported by a disc is less than 8X.

High fidelity digital audio

The CRW3200E drive supports extraction of digital audio data at up to 40X speed using CD writing software, as well as recording digital audio with high fidelity even at 24X-speed writing. For higher quality audio, the CRW3200E drive provides a digital audio output jack which can be connected to the sound card with an SPDIF (digital audio) input jack, if your computer has one installed, with an optional digital audio cable.

Audio Master Quality Recording (High quality audio writing mode)

Audio Master Quality Recording enables you to create high quality audio CDs. This mode is available for CD-R discs with a capacity of 650MB and 700MB. (P. 40)

Note

Audio CDs that are created with Audio Master Quality Recording may not be played back on certain audio recorders and CD-R/RW drives.

CD-MRW (CD Mount Rainier ReWriting)

CD-MRW is a new standard of packet writing. Compared to the ordinary packet writing, CD-MRW provides many useful functions such as background formatting. (P. 40)

Names and Functions of Parts

Front Panel

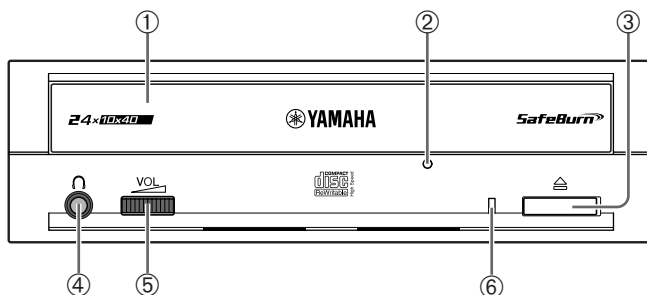

① Disc tray

Holds the disc. It is opened or closed by pressing the eject button. (P. 26)

② Manual eject hole

Forcibly opens the disc tray when the tray cannot be opened by pressing the eject button. (P. 27)

③ Eject button

Press to open or close the disc tray. (P. 26)

④ Headphone jack

Connects headphones or external speakers to the drive; has stereo mini-jack specifications.

⑤ Headphone volume dial

Controls the volume of the headphones. The volume increases as the dial is turned to the right.

⑥ LED

Indicates the operational status of the CRW3200E drive by its colors and blinking patterns.

Lights or blinks blue

- Lights: Standby (with disc)
- Blinks: Opening/Closing disc tray, or reading disc information (TOC)
- Blinks rapidly: Playback audio
- Blinks irregularly: Reading data

Lights or blinks purple

- Lights: Standby (no disc) or the disc tray is open
- Blinks: Accessing for writing or test writing
- Blinks rapidly: Writing

Blinks orange

- Malfunction

Off

- Power saving (operated via computer setting)

Rear Panel

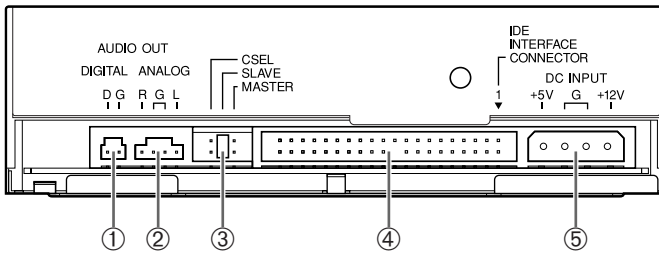

① DIGITAL AUDIO OUT

Connects to the sound card in the computer if the sound card has an SPDIF (digital audio) input jack using an optional digital audio cable. (P. 20)

② ANALOG AUDIO OUT

Connects to the sound card in the computer using the included audio cable. (P. 19)

③ Jumper switch

Insert a plastic shunt into the switch to set the connection of the IDE to master or slave. The switch is set at slave by default. (P. 14)

④ IDE INTERFACE CONNECTOR

Connects the included 40-pin IDE cable. (P. 17)

⑤ DC INPUT

Connects the 4-pin internal power cable of the computer. (P. 21)

Precautions on Use

Handling Discs

To avoid trouble, such as writing errors, loss of recorded data, and malfunction of the drive, take the following precautions when handling discs.

- Do not place discs in a hot or damp place or where they will be exposed to direct sunlight.
- Do not touch the disc surface. Hold the disc by the edge when handling it.
- Remove dust and dirt from the disc surface. Use an air spray to remove dust. The disc surface may be scratched if strongly wiped with a dry cloth.
- Do not stick labels to the disc surface or write anything on it except where designated.
- Do not clean discs with chemicals or detergents.
- Do not bend or drop discs.

Copyright

It is prohibited by law to duplicate copyright material for non-personal use without the prior consent of the copyright holder. When copying material with your CD-R/RW drive, take due care not to infringe the copyright.

Disclaimer of Indemnity

- Yamaha assumes no liability for the loss of any profits incurred as a result of the loss or corruption of data written on a CD-R or CD-RW, for any loss or damage caused by or arising out of extraordinary circumstances (including circumstances that Yamaha has foreseen or could foresee), nor for any damages incurred or claimed by a third party.
- After handling important data, make a comparison between the original and the copied data (to confirm that the data has been copied properly).
- In no event shall Yamaha be liable for any damage to discs due to a Buffer Underrun Error (P. 38) or for any other reason, or the inability to use distributed discs with your drive.
- Yamaha assumes no liability for the inability to write/playback discs because of their format.

Useable discs

Discs that can be written on

The CRW3200E drive can write on the following discs.

For the latest information about discs previously checked for compatibility with the drive, refer to the YAMAHA CD-R/RW Drive website URL:

<http://www.yamaha.co.jp/english/product/computer/>



CD-R discs

- The CRW3200E drive can write at 1X, 2X, 4X, 8X, 12X, 16X or 24X speed.
- CD-R discs can be played back on a CD-ROM drive or a CD player.



Note

- 24X-speed writing is enabled with Partial CAV method. (P. 6)
- Check the writing speeds your disc supports prior to writing.



CD-RW discs

- The CRW3200E drive can write/rewrite at 2X or 4X speed.
- CD-RW discs can be read/played back on a device (e.g. CD-ROM drive) that supports “CD-RW” discs.

Note

Some discs support only 2X speed.



High Speed CD-RW discs

- The CRW3200E drive can write/rewrite at 4X, 8X or 10X speed.
- High Speed CD-RW discs can be read/played back on a CD-RW drive that bears the High Speed CD-RW logo or a device (e.g. CD-ROM drive) that supports “CD-RW” discs.

Note

- When using the packet writing method (P. 40) for writing/rewriting onto High Speed CD-RW discs, you can select the 4X – 10X Full CAV method. For more information refer to the documentation that comes with your CD writing software. (Your CD writing software must support the Full CAV method, as does the CD Writing software that comes with the CRW3200E drive.)
- The Full CAV method is recommended when opening and editing a file on a CD-RW disc with an application.
- In order to write, erase, read or play back High Speed CD-RW discs, use a CD-R/RW drive that bears the High Speed CD-RW logo. When using a CD-ROM drive to read/play back High Speed CD-RW discs, use a drive that supports CD-RW discs.

If these discs are used with a CD-R/RW drive not bearing the High Speed CD-RW logo, the discs may not be recognized, resulting in a computer not operating properly or other malfunctions occurring.

Refer to the YAMAHA website below prior to attempting to read/play back these discs on a YAMAHA CD-R/RW drive not bearing the High Speed CD-RW logo.

URL: <http://www.yamaha.co.jp/english/product/computer/>

Partial CAV (Constant Angular Velocity)

The CLV (Constant Linear Velocity) method is generally used to write data on a CD-R disc. In writing using the CLV method, the disc rotation speed is adjusted to keep the data writing speed (data transfer rate) constant on all parts of the disc.

In contrast, the CAV (Constant Angular Velocity) method exercises control so as to keep the disc rotation speed constant. Since the CAV method makes it possible to substantially increase the maximum data transfer rate without straining of the drive, it is adopted today for most CD-ROM drives.

CD formats define the constant linear density of written data so that the amount of written data per disc rotation will increase as the writing point moves from the inner track to the outer track.

With the CAV method, therefore, data is transferred at a higher rate when it is written on the outer tracks of the disc. To achieve 24X-speed writing, the CRW3200E drive employs the Partial CAV method, which is a combination of the CAV method for inner tracks and the CLV method for outer tracks.

The Partial CAV method controls the disc rotation speed so that the CRW3200E drive starts writing at 18X speed on inner tracks, increasing the speed to 24X as the read/write head moves outward and holds the speed at 24X on outer tracks.

Tip

The CRW3200E drive supports 8cm discs.

Note

Use only circular discs. Do not use any irregular shaped discs such as heart-shaped or star-shaped discs to avoid the risk of malfunction.

System Requirements

The CRW3200E drive is designed to operate in the following computer environment. If your computer does not meet these requirements, the CRW3200E drive may not write at the maximum speed.

Computer (PC/AT compatible)

- CPU: Pentium II-class or higher, 300 MHz or faster
- RAM: 32MB (64MB or more is recommended)
64 MB or more is required (128 MB is recommended) for Windows 2000 Professional, while 128 MB or more is required (256 MB is recommended) for Windows XP.
- An empty 5 ¼-inch drive bay (for installing the CRW3200E drive as an additional drive into the computer)
- Hard drive space

Writing data on a CD-R/RW disc requires 50MB to 100MB of free space as a working area on the hard drive. When writing data on a CD-R/RW disc after creating an image file, there must be enough free space on the hard drive to store the image file in addition to the working area (a total of up to 900MB). However, hard drive space for image files is not required when directly writing onto a CD-R/RW disc from a hard drive or CD-ROM using the CRW3200E drive (on-the-fly writing).

Image file

You can collect the data files to be written on a CD-R/RW disc into a single image file.

The image file is useful for writing the same data onto multiple discs. For details, refer to the documentation that comes with the CD writing software.

Operating system (OS)

Windows 95 (OSR2 or later), Windows 98, Windows 98 Second Edition, Windows Me, Windows 2000 Professional, or Windows XP.

CD writing software

The CRW3200E drive requires CD writing software to write onto a CD-R/RW disc. The CD writing software is included. If using other CD writing software, be sure that the CD writing software supports the CRW3200E drive.

For details about installing and using the CD writing software, refer to the documentation that comes with the CD writing software.

Preparing the CRW3200E Drive

Preparing tools

- **Phillips screwdriver:** Use the proper screwdriver for the screws to install the CRW3200E drive into the computer.
- **Narrow pliers:** Insert and remove the included plastic shunt for the jumper switch.

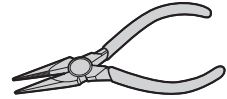
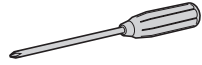

Serial Number

The serial number is printed on the label on the top of your CRW3200E drive. When you have a question about the drive, or need user support services, the serial number is required.

Please write the serial number down in the space below prior to installing the CRW3200E drive into your computer. It will be difficult to check the serial number after installation.

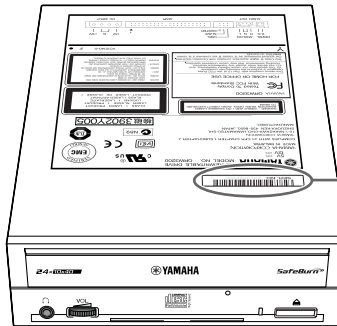

Serial number
(10 characters: 3 letters +
7 numbers)

Serial Number										
---------------	--	--	--	--	--	--	--	--	--	--

The following describes how to install the CRW3200E drive on the computer by taking a tower-type computer for example.

Note

The methods of removing the computer cover or panels and installing an internal device vary depending on the computer model. Refer to the documentation that comes with the computer.

1 Decide the Installation Method

Check the connection of any IDE device installed to decide the installation method of the CRW3200E drive.

Note

- The CRW3200E drive supports Ultra ATA/33. Even if the motherboard and the hard drive support Ultra ATA/66 or Ultra ATA/100, they are operated by Ultra ATA/33 as long as they are connected to the CRW3200E drive by the same IDE cable or the included 40-pin IDE cable.
- Install the CRW3200E drive horizontally.

1 Turn off and unplug the computer.

While the computer is turned on, it is dangerous to handle the internal computer devices due to the risk of an electrical shock. There is also a risk of damaging the CRW3200E drive, the computer, etc. Be sure to unplug the computer prior to handling any internal computer device.

2 Remove all peripheral devices and cables connected to the computer prior to removing the computer cover.

Clothes and body can become charged with static electricity.

Discharge any static electricity by touching a metallic part of the case or power unit.

For more information, refer to the documentation that comes with the computer.

Installing the CRW3200E drive as an additional drive

Check the IDE channel (primary/secondary and master/slave) connecting the CRW3200E drive. (P. 12 – 13)

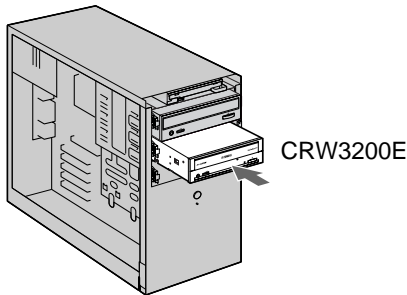

Note

An empty 5 1/4-inch drive bay is required to install the CRW3200E drive.

Replacing an existing IDE device with the CRW3200E drive

Connect the CRW3200E drive to the cable that was previously connected to the existing IDE device.

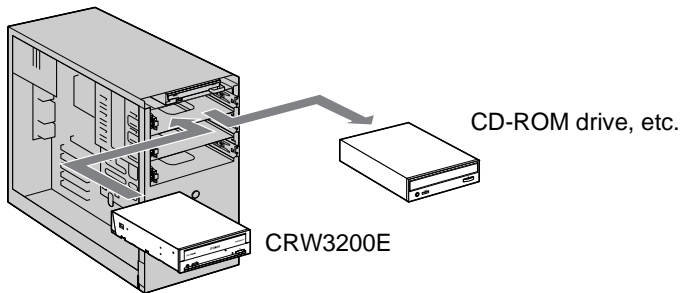

Note

When replacing a SCSI device, such as a SCSI type CD-ROM drive, do not connect the CRW3200E drive to the cable that was previously connected to that SCSI device. Use the included 40-pin IDE cable to connect the CRW3200E drive to the computer.

Examples of connecting the CRW3200E drive

The following describes how to connect the CRW3200E drive for example recommended by Yamaha.

Example 1: As a secondary slave (For additional drive)

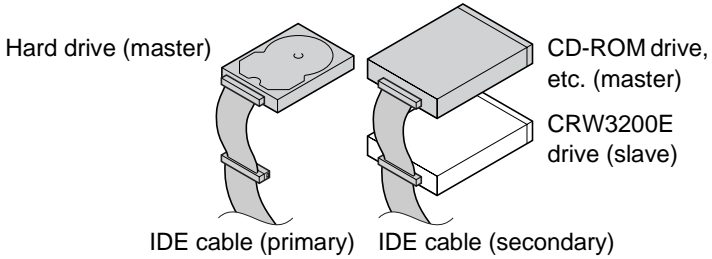

Example 2: As a secondary master (For replacing the existing drive with the CRW3200E drive)

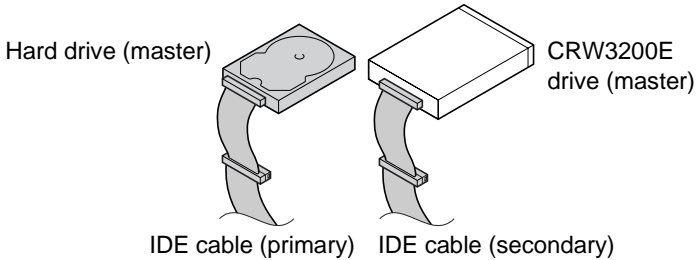

For the best performance of the CRW3200E drive, Yamaha recommends that the drive be connected as the sole secondary master.

Note

- The CRW3200E drive is set at slave by default. If you connect the drive as the sole secondary master, set the drive to master.
- If you connect an IDE device solely to an IDE cable, set the device to master and connect the drive to the end of the cable.
- If you start up the operating system from a SCSI hard drive, etc., there may be no IDE device connected to the primary. In such a case, Yamaha recommends that the CRW3200E drive be connected as the primary master.
- You may find that the IDE cable has one connector when you try to connect the removed device to another connector. In such a case, you are required to prepare an IDE cable with two connectors.
- You may have to change the master/slave setting to connect the removed device to another connector. For more details, refer to the documentation that comes with the device or refer to the manufacturer's website.

E-IDE

E-IDE (Enhanced-IDE) is a standard for connecting computers to IDE devices such as hard discs, CD-ROMs and CD-R/RW drives. Most computers have two IDE connectors (primary and secondary). Each connector can be connected to two devices with an IDE cable.

Two IDE devices connected by one IDE cable are called "master" and "slave."

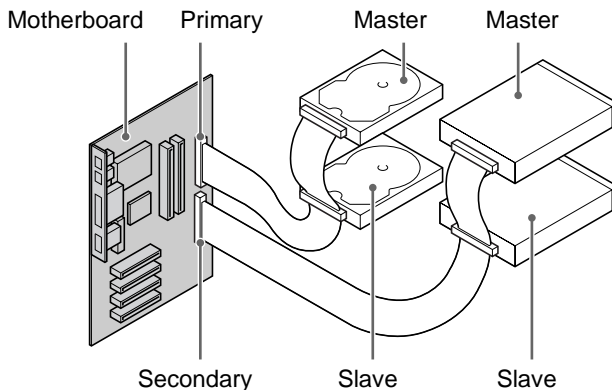

Continued on next page

The setting methods for most IDE devices are as follows.

- **Hard drive:** Change the setting with the jumper switch on the circuit board on the rear panel or the hard drive bottom panel. You have to set the cable select (CSEL) on some hard drives.
- **CD-ROMs, etc.:** Change the setting with the jumper switch on the rear panel.

Note

- When you use the IDE device as a master, connect the device to the connector at the end of the IDE cable, or when you use the device as a slave, connect the device to the middle of the cable.
- When you connect two IDE devices to one IDE cable, assign each as master or slave respectively. The CRW3200E drive is set at slave by default.

2 Set the Jumper Switch

Refer to the examples of connecting the CRW3200E drive on page 11, and set the CRW3200E drive to master/slave to support your computer environment.

Use narrow pliers to set the plastic shunt at the jumper switch on the rear panel.

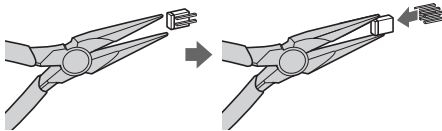

The position into which the plastic shunt is inserted varies due to the settings.

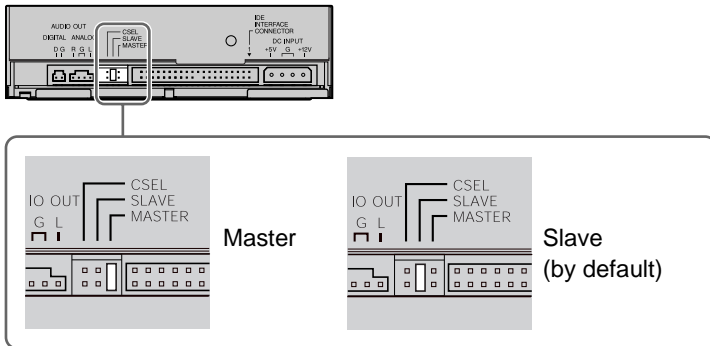

The CRW3200E drive is set at slave by default.

When replacing an IDE device (master) with the CRW3200E drive, set the drive to master.

Continued on next page

Note

- The function of a plastic shunt is to electrically connect the jumper switch contacts. Inserting and removing the pin turn the settings on and off.
- Be sure to turn off the computer prior to setting the jumper switch.

Cable Select (CSEL)

If your computer supports a cable select function, insert a plastic shunt into the cable select (CSEL) jumper switch so that the computer will automatically adjust the CRW3200E drive setting to master or slave.

If you have any problems with the CRW3200E drive when set to cable select (CSEL), set the drive to master or slave.

Refer to the documentation that comes with your computer to find out if it supports cable select (CSEL) function.

3 Install the CRW3200E Drive

The following describes how to install the CRW3200E drive as an additional drive for example.

1 Secure the installation location.

Installing the CRW3200E drive as an additional drive

Remove the front cover from the 5 ¼-inch drive bay.

Replacing

Remove all cables connected to the CD-ROM or other devices to be replaced. Then remove the device itself from the computer.

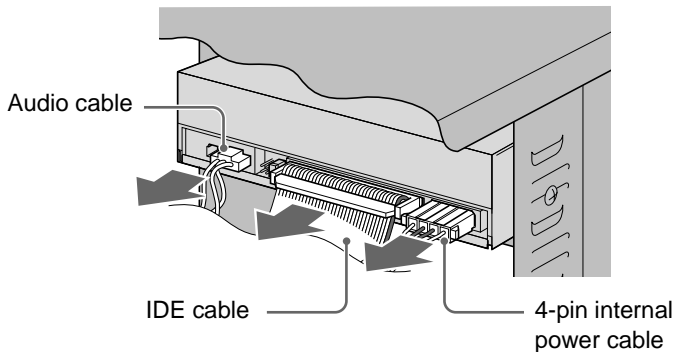

Note

- Be careful not to damage the various cables connected to the rear panel of the CD-ROM drive.
- The audio cable is usually caught by the hook at the top of the connector. Release the hook and remove the connector without using excessive force.
- Do not apply excessive force to the CD-ROM drive or cables.
- Hold the cable by the connector to remove the cable. Pulling the cable itself with excessive force may damage the wires inside.

2 Install the CRW3200E drive carefully into the drive bay and temporarily fasten the screws by hand.

Be sure that there is enough space to connect the 4-pin internal power cable, 40-pin IDE cable, and audio cable prior to temporarily fastening the included four screws to the fixed position.

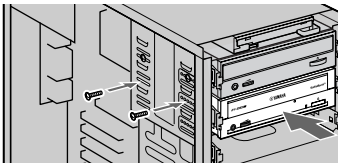

Install the CRW3200E drive carefully into the drive bay from the front

Note

Do not apply excessive force to the CRW3200E drive.

3 Connect the included 40-pin IDE cable.

Connect the included 40-pin IDE cable to the IDE connector on the motherboard and the IDE interface connector on the rear panel of the CRW3200E drive. Be sure that the colored wire is connected to the first pin of the IDE connector, as shown in the diagram below.

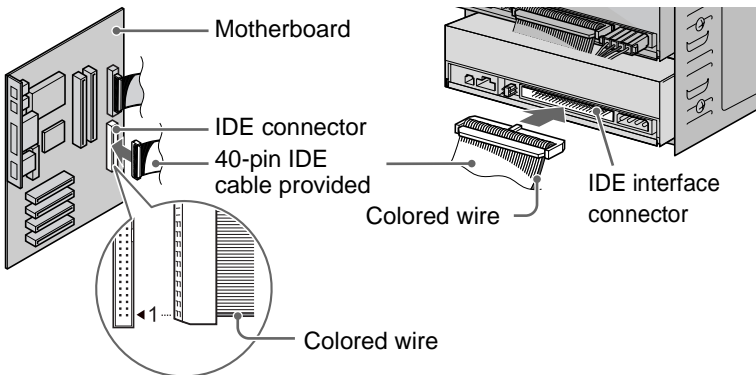

Note

- IDE devices supporting Ultra ATA/66 or Ultra ATA/100 do not operate with the included 40-pin IDE cable. Prepare proper IDE cables for those IDE devices.
- You can use an IDE cable that supports Ultra ATA/66 to connect to the CRW3200E drive.
- Use an IDE cable no longer than 45.7 cm (18 in.).
- When two IDE devices are connected to one IDE cable, be sure to assign each as master/slave respectively.

4 **Connect an audio cable if necessary.**

The sound card of the computer enables you to listen to audio CDs played back on the CRW3200E drive. There are two methods to connect the CRW3200E drive and the sound card: analog connection and digital connection.

Audio CD playback

- Audio is available from the headphones or speakers connected to the headphone jack on the front panel of the CRW3200E drive (this is convenient for the computer without a sound card). In such a case, connecting an audio cable is not required.
- An audio cable is not required to extract an image file from an audio CD since data is transferred via the IDE cable.
- If the CRW3200E drive is installed as an additional drive and the CD-ROM drive or DVD-ROM drive is already connected to the sound card, Yamaha recommends that audio CDs be played back by the existing drive.

Continued on next page

Analog connection

Connect one end of the included audio cable (the end with one connector) to the analog audio output jack on the rear panel of the CRW3200E drive. Be sure that the connector is in the correct direction prior to connecting it. There are two types of connectors at the other end of the audio cable. Select the one that fits the sound card: Vertical connector (PH) and Horizontal connector (MPC).

Check the direction of the connector vertically and horizontally prior to connecting it to the sound card. (Only use one of the two connectors, and leave the other free.)

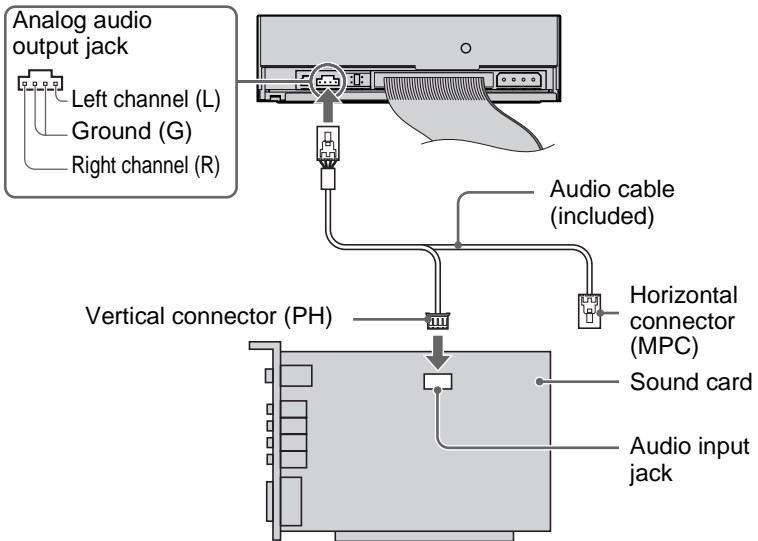

Note

- Some sound cards have more than one audio input jack, including those which do not support the specification of the CRW3200E drive.
- If you cannot hear playback audio from the speakers, refer to the documentation that comes with the sound card.

Digital connection

Digital connection enables you to enjoy higher quality audio with less distortion since the digital signals recorded on the audio CD are output to the sound card with high fidelity.

Connect the digital audio output jack of the CRW3200E drive and the SPDIF (digital audio) input jack of the sound card with a digital audio cable. Be sure that the connector is in the correct direction prior to connecting it.

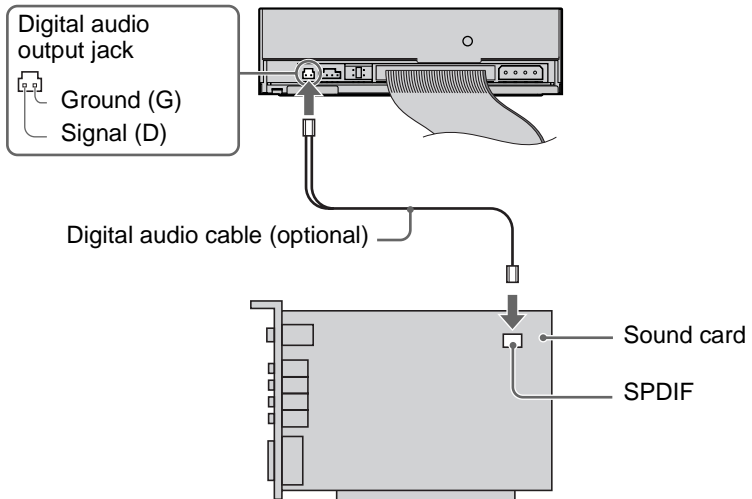

Note

A digital audio cable with a proper connector and a sound card with an SPDIF (digital audio) input jack are required.

- 5** Connect the 4-pin internal power cable of the computer (+12V and +5V) to the power connector on the rear panel of the CRW3200E drive.

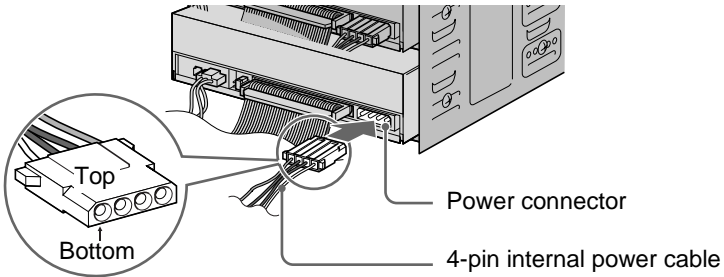

Note

The 4-pin internal power cable cannot be connected if it is upside down. If the connector does not connect easily, check that it is in the correct direction.

- 6** Tighten four screws which fastened by hand.

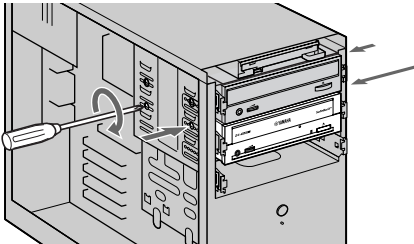

- 7** Attach the computer cover and reconnect the peripheral devices and cables as before.
-

4 Check Recognition of the CRW3200E Drive

1 Plug in and turn on the computer.

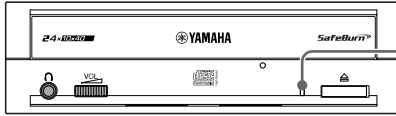

LED blinks blue, then lights purple.

Check that the LED on the front panel blinks blue, and then lights purple.

2 Check that the CRW3200E drive is properly recognized by Windows.

The operation varies depending on your operating system.

When using Windows 95/98/98 Second Edition/Me

- 1 Select **Start** on the taskbar, then **Settings, Control Panel, System,** and **Device Manager** tab. The **Device Manager** dialog box appears.

Note

For Windows Me, if the **System** icon is not found in the **Control Panel** window, click **view all Control Panel options** on the left side of the window.

- 2 If there is **+** to the left of **CD-ROM**, click **+**.

YAMAHA CRW3200E should be shown when the CRW3200E drive has been recognized properly.

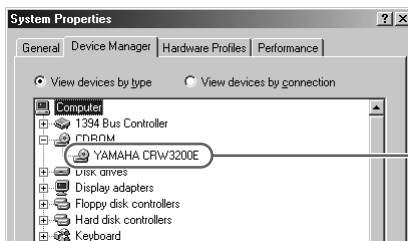



“YAMAHA CRW3200E” is shown.

Continued on next page

If the drive name is not shown or there is  or  mark.

The CRW3200E drive has not been recognized properly. Check the cable connections and the master/slave settings of the IDE devices connected to the computer.

When using Windows 2000 Professional



- 1 Select **Start** on the taskbar, then **Settings, Control Panel, Hardware** tab, and **Device manager**. The **Device Manager** dialog box appears.
- 2 If there is  to the left of **DVD/CD-ROM Drive**, click .
YAMAHA CRW3200E should be shown when the CRW3200E drive has been recognized properly.

When using Windows XP

- 1 Select **Start** on the taskbar, then **Control Panel, System, Hardware** tab, and **Device manager**. The **Device Manager** dialog box appears.

Note

If the **System** icon is not found in the **Control Panel** window, click **Switch to Classic View** on the left side of the window.

- 2 If there is  to the left of **DVD/CD-ROM Drive**, click .
YAMAHA CRW3200E should be shown when the CRW3200E drive has been recognized properly.

3 Change the DMA setting.

The DMA setting may not be displayed, depending on your computer. In such a case, you can use the CRW3200E drive without changing the DMA setting.

Tip

To maximize the performance of the CRW3200E drive, Yamaha recommends that you also change the DMA setting of your hard drive.

When using Windows 95/98/98 Second Edition/Me

- 1 In the **Device manager** dialog box (P. 22), select **YAMAHA CRW3200E Properties** and then **Settings** tab.
- 2 Check the “DMA”.

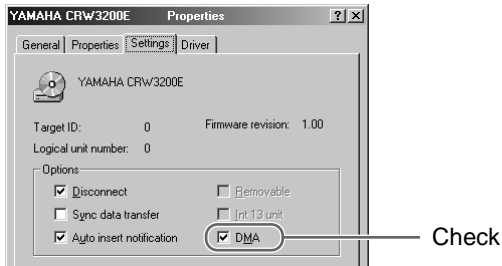

Note

The CRW3200E drive operation may become unstable, depending on your computer environment. In such a case, uncheck the “DMA”. The “Simultaneous Data Transfer” setting does not affect CRW3200E drive operation.

When using Windows 2000 Professional/XP

- 1 Log on to the administrator account.
- 2 In the **Device manager** dialog box (P. 23), select the IDE channel (primary/secondary) connected to the CRW3200E drive and then **Detailed Settings** tab.
- 3 Set to **Transfer Mode**.

Continued on next page

Recommended DMA settings (transfer mode settings)

OS	Recommended	Remarks
Windows 95/98/ 98 Second Edition/Me	On	Off if operation becomes unstable
Windows 2000 Professional/XP	DMA mode	PIO mode if operation becomes unstable

DMA (Direct Memory Access)

DMA is a method that transfers data between various peripheral devices (e.g., a hard drive, CD-R/RW drive, etc.) and the computer memory without going through the CPU in the computer. Using DMA transfer increases not only the data transfer speed but also the processing speed by decreasing straining of the CPU.

5 Install CD Writing Software

Install the included CD writing software on your computer.

For details on how to install CD writing software, refer to the documentation that comes with it.

Loading/Ejecting a Disc

Prior to the operation, check that the computer is turned on.

1 Open the disc tray by pressing the eject button.



Press the eject button.

2 Place the disc onto the disc tray properly with its label facing upward.

Or remove the disc from the disc tray carefully so not to damage it.

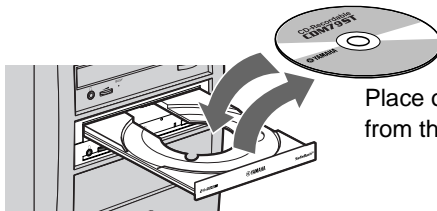

Place or remove the disc onto/
from the disc tray properly.

3 Close the disc tray by pressing the eject button or by gently pushing the disc tray into the computer.

Note

- Place or remove the disc after the disc tray has fully opened. Do not push or pull the disc tray with applying excessive force to avoid damage to the drive or the disc.
- The disc tray does not open while the application software prohibits ejecting, including when the drive accesses the disc.

Manually Ejecting a Disc

If the disc tray fails to open for some reason, such as a power failure, follow the steps below to remove the disc from the drive.

Note

Frequent use of this operation may cause malfunction of the drive.

-
- 1 Prepare a thin pin-like object, such as a straightened paper clip.**

Use an object less than 2 mm in diameter and more than 3 cm in length.

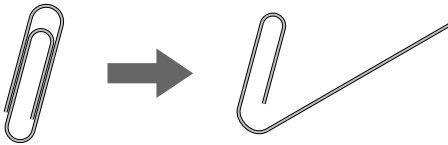

-
- 2 Turn off the computer.**

-
- 3 Insert the thin pin-like object straight into the manual eject hole, and push it in.**

When the disc tray opens, remove the disc.

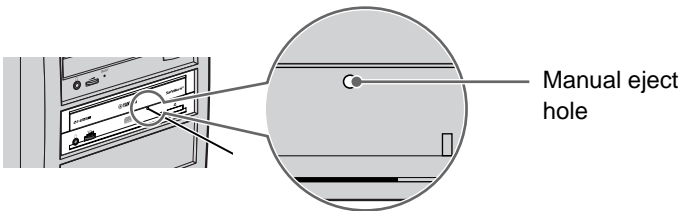

-
- 4 Turn on the computer, and close the disc tray.**
-

Troubleshooting

Refer to the YAMAHA CD-R/RW Drive website for the latest support data, including information on troubleshooting.

YAMAHA CD-R/RW Drive website URL:

<http://www.yamaha.co.jp/english/product/computer/>

Europe:

<http://www.yamaha-it.de/>

1 The CRW3200E drive is not turned on. (The front panel LED does not light.)

- **Is the computer turned on?**

Turn on the computer.

- **Is the 4-pin internal power cable connected properly to the CRW3200E drive?**

Turn off the computer, and remove the computer cover. Check that the connector of the 4-pin internal power cable is connected to the CRW3200E drive in the correct direction, and that the 4-pin internal power cable is fully connected. (P. 9, 21)

- **If the CRW3200E drive is connected to another 4-pin internal power cable that properly conducts power to another device, is the CRW3200E drive turned on?**

Turn off the computer. Be sure that the CRW3200E drive is connected to another 4-pin internal power cable that properly conducts power to another device, and check that the CRW3200E drive is turned on when turning on the computer. (P. 9, 21)

If the drive is turned on, the computer's power unit may be damaged.

If the drive is not turned on, contact the store of purchase or your nearest Yamaha dealer (listed at the back of this manual).

2 The CRW3200E drive is not recognized by the operating system. (P. 22)

- **Is the IDE cable connected properly to the CRW3200E drive?**

Turn off the computer and remove the computer cover. Check that the connector of the IDE cable connected to the CRW3200E drive is in the correct direction, and that the IDE cable is fully connected. (P. 9, 17)

Then check that the pins of the IDE interface connector of the CRW3200E drive are not bent.

- **Is the IDE cable connected properly to the motherboard?**

Check that the connector of the IDE cable is connected to the motherboard in the correct direction, and that the IDE cable is fully connected. (P. 17)

- **Is each IDE device set respectively?**

When one IDE device is connected to one IDE cable, be sure that the device is set to master or CSEL.

When two IDE devices are connected to one IDE cable, be sure that both devices are not set to master (or slave).

When the CRW3200E drive is set to CSEL, reset it to master or slave. (P. 14)

When you have the problem even if each IDE device is set properly as above, contact the store of purchase or your nearest Yamaha dealer (listed at the back of this manual).

3 The disc tray does not open when you press the eject button.

- **Is the CRW3200E drive turned on?**

(Does the LED on the front panel light?)

Refer to “The CRW3200E drive is not turned on (The front panel LED does not light).” (Troubleshooting Item 1)

- **Is any CD writing software being used?**

Some CD writing software prohibits ejecting while accessing. (If you are using such a software program, the disc tray does not open even if the eject button is pressed.) In such a case, follow the steps in the software window to eject the disc, or quit the CD writing software prior to pressing the eject button.

- **Is the disc tray opened when the computer is restarted?**

Quit all running application software, restart your computer, and press the eject button of the CRW3200E drive.

- **Is the disc tray opened if the IDE cable is removed from the CRW3200E drive?**

Turn off the computer and remove the IDE cable from the IDE interface terminal on the rear panel of the CRW3200E drive. (P. 9, 17)

Restart the computer, and press the eject button of the CRW3200E drive once again.

-
- **Turn off the computer, and remove the disc following “Manually Ejecting a Disc.” (P. 27).**

If the disc tray is caught in the drive and does not come out, or if it cannot be opened or closed using the eject button after it is pulled out manually, contact the store of purchase or your nearest Yamaha dealer (listed at the back of this manual).

4 The disc is ejected without order (or it comes out spontaneously).

- **Is the disc set properly (horizontally) on the disc tray?**

Set the disc properly, and close the disc tray.

- **Is the disc dusty or dirty?**

Remove dust or dirt from the disc using an air spray or a dry soft cloth. To avoid damaging discs, wipe the disc gently from the center perpendicular to the edge of the disc.

- **Does the drive accept other discs (audio CD, CD-ROM, blank CD-R disc, etc.)?**

If a specific disc is ejected, the disc itself may be damaged or deformed.

If all discs are ejected, contact the store of purchase or your nearest Yamaha dealer (listed at the back of this manual).

5 No data can be read from a disc.

- **Is the disc ejected without order?**

Refer to “The disc is ejected without order (or it comes out spontaneously).” (Troubleshooting Item 4)

- **Is the disc useable with the drive? (P. 5, 35)**

Be sure that the disc is compatible with the CRW3200E drive.

- **Is the disc dusty or dirty?**

Remove dust or dirt from the disc using an air spray or a dry soft cloth. To avoid damaging discs, wipe the disc gently from the center perpendicular to the edge of the disc.

- **Can data be read from other discs (audio CD, CD-ROM, etc.)?**

If no data can be read from a specific disc, data may be written in a format that the drive cannot recognize, or the disc itself may be damaged or deformed. Note that no data can be read from blank discs, and the CRW3200E drive infrequently fail to read data correctly from a disc even if the disc is compatible with the drive.

- **Does the LED on the front panel of the CRW3200E drive light correctly when a disc is inserted?**

When a disc is inserted, the LED will blink blue for a moment and then light blue. (P. 2)

If no data can be read from a specific disc, data may be written in a format that the drive cannot recognize, or the disc may be damaged or deformed.

If the LED on the front panel remains purple (stating that the drive cannot recognize the disc) no matter what type of disc is inserted, contact the store of purchase or your nearest Yamaha dealer (listed at the back of this manual).

6 The playback of an audio CD (CD-DA) cannot be heard.

Check that the volume is not set to the minimum level.

If you cannot hear the playback audio from headphones or external speakers connected to your computer, be sure that the audio cable is properly connected to the CRW3200E drive and the sound card. (P. 19, 20)

For Windows Me/XP, change the settings as follows. (If Windows Media Player 7.0 or later is used with Windows Me/XP, this problem can happen since the digital playback option is activated by default setting.)

For Windows Me

- 1 In the **Device manager** dialog box (P. 22), select **YAMAHA CRW3200E Properties** and then **Properties** tab.
- 2 Uncheck the “Enable digital CD audio for this CD-ROM device” under “Digital CD Playback.”

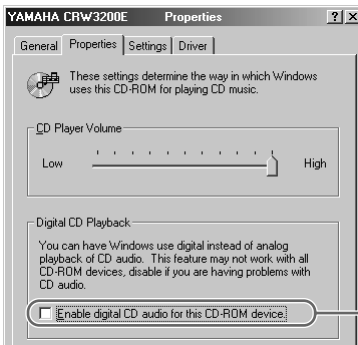

Uncheck
(This screen is an example on Windows Me.)

- 3 Start “Windows Media Player.” In the menu bar, select **Tools, Options** and **CD Audio** tab.
- 4 Uncheck the “Digital playback” in the “Playback Settings” item.

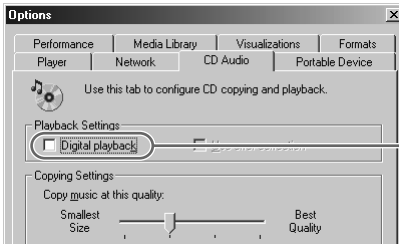

Uncheck
(This screen is an
example on Windows
Media Player 7.0.)

For Windows XP

- 1 Follow the steps 1 and 2 on the page 31, and uncheck the “Enable digital CD audio for this CD-ROM device.”
- 2 Start “Windows Media Player.” In the menu bar, select **Tools, Options, Devices** tab, **CD-RW Drive**, and **Properties**.
- 3 Select “Analog” in the “Playback” item.

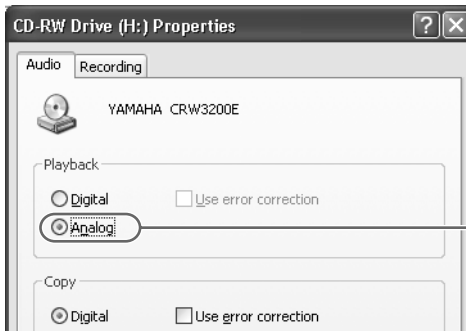

Select
(This screen is an
example on Windows
Media Player 8.0.)

- 7 **No data can be read from any CDs, a disc is ejected spontaneously, or the LED remains purple when a disc is inserted. (The LED does not change from lighting purple to blinking blue and then lighting blue.) (P. 2)**

Remove the IDE cable from the CRW3200E drive while the 4-pin internal power cable is connected to the drive, and insert the disc once again. If no data can be read from a specific disc or a specific disc is ejected, the disc itself may be damaged or deformed.

If the LED remains purple or a disc is ejected, no matter what type of disc (e.g., an audio CD, CD-ROM or blank CD, etc.) is inserted, contact the store of purchase or your nearest Yamaha dealer (listed at the back of this manual).

8 The error message “Buffer Underrun” is displayed.

If your CD writing software supports Buffer Underrun Protection, you must activate it. For more details, refer to the documentation that comes with your CD writing software.

To prevent the occurrence of a buffer underrun and to increase the efficiency of data writing, try the following:

- Reduce the data writing speed.
- Create an image file on the hard drive.
- Optimize the hard drive. (Defragmentation)
- Do not start any application software including screen savers during data writing.
- Deactivate the power management for the hard drive.
- Set the data transfer mode of any IDE device such as a hard drive or CD-ROM drive to DMA. (P. 23)
- Deactivate the Windows Active Desktop.
- Quit all memory-resident software programs.
- Check your CD writing software settings with the documentation that comes with it.

Note

A writing error may happen if the drive is vibrated while data is being written on a CD-R or a CD-RW disc.

9 Other problems

● Isn't more than one CD writing software installed on your computer?

Installing more than one CD writing software on a computer may cause instability of operation. (The CD writing software that come with the CRW3200E drive can be used together without problems.)

● CD writing software must support the CRW3200E drive in order to recognize the drive.

Contact the manufacturer of your CD writing software to see whether the software supports the CRW3200E drive.

● Is the power capacity of your computer sufficient?

The computer may not operate due to insufficient power capacity.

Check the specifications of your computer and its current environment. The power consumption of the CRW3200E drive is 11 W during writing/reading.

Firmware

Firmware refers to the operating software designed for your CD-R/RW drive. It is stored in the drive's flash memory so that it can be rewritten.

To enhance operation reliability, Yamaha continues improving the firmware and makes updates available on the internet. You can find information about the latest firmware at the YAMAHA CD-R/RW Drive website.

YAMAHA CD-R/RW Drive website

URL: <http://www.yamaha.co.jp/english/product/computer/>

Europe: <http://www.yamaha-it.de/>

These websites contain the latest YAMAHA CD-R/RW drive user support information including information about the firmware.

Refer to the website regularly to check the latest information.

Checking the firmware version in your CRW3200E drive

For Windows 95/98/98 Second Edition/Me

In the **Device Manager** dialog box (P. 22), select **YAMAHA CRW3200E** to display the **YAMAHA CRW3200E properties** dialog box, and then select the **Settings** tab.

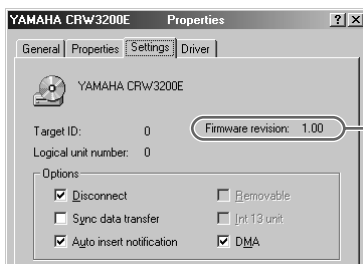

The revision number shown here varies depending on the version of the firmware in the drive as set at default. (This screen is an example on Windows Me.)

For Windows 2000 Professional/XP

The firmware version cannot be displayed using **Device Manager**. Use your CD writing software to check the firmware version.

CRW3200E Drive Specifications

Supported Formats

	Write	Read	Play back ^{*4}
CD-DA	●	●	●
CD TEXT	●	●	●
CD-ROM ^{*1}	●	●	●
Mixed Mode CD-ROM (CD-ROM+CD-DA)	●	●	●
CD-ROM XA ^{*1}	●	●	●
Photo CD ^{*1}	● ^{*2 *3}	●	●
Video CD	●	●	●
CD-i	●	● ^{*3}	—
CD EXTRA ^{*1}	●	●	●

^{*1} includes multisession

^{*2} proper disc required

^{*3} proper application software required

^{*4} proper application software may be required depending on the format

Writing Methods

Disc-at-Once (DAO)
 Session-at-Once (SAO)
 Track-at-Once (TAO)
 Packet Writing
 Audio Master Quality Recording (High quality audio writing mode)
 CD-MRW (CD Mount Rainier Rewriting)

Writing/Reading Speed

Writing	CD-R	1X, 2X, 4X, 8X, 12X, 16X (CLV), 24X (18X – 24X Partial CAV)
	CD-RW	2X, 4X, 8X, 10X (CLV), 4X – 10X Full CAV (Packet writing)
Reading	40X (max.) Full CAV	
	Note) • DATA: 40X (max.)	<ul style="list-style-type: none"> • CD-DA: 40X (max.) in audio extraction • CD-DA: 1X only in audio playback • Video CD: 10X (max.) • Session closed disc: 40X (max.) • Session unclosed disc: 12X (max.)
CD-R	1X, 2X, 4X, 8X, 12X, 16X, 24X (18X – 24X Partial CAV)	writing: CD-R discs specified in Orange Book Part 2, Ver. 3.1. Note) Use a CD-R disc that matches the writing speed.
CD-RW	2X or 4X writing:	Orange Book Part 3, Vol.1, Version 2.0-compliant discs
	4X, 8X, 10X, 4X – 10X Full CAV (Packet writing) writing:	Orange Book Part 3, Vol.2, Version 1.0-compliant discs
	Note) For 2X writing, Book Part 3, Vol.1, Version 1.0-compliant discs can be used.	

Data Capacity	700 MB (with a 79-minute disc) 650 MB (with a 74-minute disc) 550 MB (with a 63-minute disc)
Maximum recording time in Audio Master Quality Recording	68 min. (700 MB) 63 min. (650 MB)
Data Transfer Rate (Mode 1)	1X: 150 KB/sec. 12X: 1,800 KB/sec. 2X: 300 KB/sec. 16X: 2,400 KB/sec. 4X: 600 KB/sec. 24X: 3,600 KB/sec. 8X: 1,200 KB/sec. 32X: 4,800 KB/sec. 10X: 1,500 KB/sec. 40X: 6,000 KB/sec.
Interface	Enhanced IDE (E-IDE) /ATAPI
Burst Transfer Rate	Program I/O (PIO) mode 4: 16.7 MB/sec Multi-word DMA mode 2: 16.7 MB/sec Ultra DMA mode 2: 33.3 MB/sec (Ultra ATA/33)
Data Buffer Size	8 MB (3,176 sectors)
Average Access Time	130 msec. (random access)
Sector Size	2,048 – 2,448 bytes
Installing Style	Horizontal
Disc Loading Type	Front auto-loading tray type
Audio Out	Analog (Line Out specifications) • Frequency Band: 20 – 20,000 Hz • Output level: 700 mVrms Digital • SPDIF format • Output level: TTL
Power Consumption	11 W (writing/playback) 4 W (standby) 1 W (during power saving, operated by the computer's power saving mode)
Power Supply	+5 VDC ±5% +12 VDC ±10%
Operating Environment	Temperature : 5 – 40 °C Humidity : 25 – 80% RH (no condensation)
Dimensions	Width : 148.0 mm Height : 42.6 mm Depth : 198.1 mm
Weight	0.9 kg

Safety/EMC Compliance

The CRW3200E drive conforms to the following specifications.

Country/ Region	Compliance Specifications			Remarks
	Standard	Item	Name and Number	
USA	Safety	Electricity	UL60950	Information Technology Equipment
		Laser	21CFR1040.10 FDA Chapter 1, Subchapter J	Class I Laser Equipment
	EMC/EMI	Emission	47CFR15 FCC Part 15, Subpart B	Class B Computing Device
Canada	Safety	Electricity	CSA C22.2 No. 60950	Information Technology Equipment
	EMC/EMI	Emission	ICES-003	Class B Computing Device
EU	Safety	Electricity	EN60950	Information Technology Equipment
		Laser	EN60825	Class 1 Laser Product
	EMC/EMI	Emission	EN55022	Class B Equipment
		Immunity	EN55024	Residential, Commercial and Light Industrial Areas
Australia New Zealand	EMC/EMI	Emission	AS/NZ 3548	Class B Equipment
Taiwan	EMC/EMI	Emission	CNS13438	Class B Equipment
Japan	EMC/EMI	Emission	VCCI	Class B Equipment

Note that the specifications of the CRW3200E drive are subject to change without notice due to improvements.

Technical Notes

Buffer Underrun Protection Function

CD-R/RW drives are equipped with a buffer memory, which temporarily stores data that is being transferred. When the buffer memory becomes empty due to a delay of data transfer for any reason, a writing error happens. Such condition is defined as buffer underrun, and such an error is defined as a buffer underrun error.

Buffer underrun protection is featured in the CRW3200E drive.

When a buffer underrun almost happens, buffer underrun protection temporarily suspends the writing process. Writing resumes when enough data has accumulated in the buffer memory. Buffer Underrun Protection in the CRW3200E drive is extremely accurate, resulting in seamless recording before and after suspension.

Test writing

Test writing is a function to check for the possible occurrence of buffer underrun in your computer environment. The included CD writing software operates the test writing function that cannot operate when buffer underrun protection is activated (default). The buffer underrun protection should first be deactivated to use test writing.

Writing Methods

Disc-at-Once (DAO)

This method is used to write all data onto a disc in one operation. It writes multiple pieces of data without placing a space between data, starting with the innermost track of the disc. Once data is written by this method, no data can be added to the same disc even if there is free space available on the disc. This method is useful for making a backup copy of an entire CD.

Track-at-Once (TAO)

This method is used to write data on a disc on a track-by-track basis. A track can be defined as the smallest unit of area that contains an ordinary program, image file, text file, etc. This method enables you to add data to the same disc, one track of data at a time, as long as there is free space available on the disc. A disc that contains data written in several sessions is defined as a multi-session disc. An area that records data and management information (Lead-in/Lead-out) is defined as a session. Lead-in and Lead-out are signals written for stating the starting and ending points of one session.

Note

Ordinary audio CD players can only play back single-session discs or the first session on a multi-session disc. Do not record audio data on the second and subsequent sessions.

Session-at-Once (SAO)

This method is used to write data on a disc on a session-by-session basis. Unlike Track-at-Once described above, Session-at-Once enables you to record multiple tracks onto a disc at a time. CD EXTRA, for example, uses this method to write multiple pieces of audio data (or multiple tracks) in the first session and information required for computers in the second session. This method enables you to add data into the same disc, one session at a time, as long as there is free space available on the disc. A disc that contains data written in several sessions by this method is defined as a multi-session disc, like a disc written by the Track-at-Once method.

Packet Writing

This method is used to record data onto a disc on a file-by-file basis. This method divides a track into small segments called “packets” so that data can be written on a packet-by-packet basis, which means that you can write data in much the same way as you copy data to a floppy or hard drive. Since the data can be written easily, packet writing is proper to daily data backup. Packet writing also enables you to add packets to a disc as long as there is free space available on the disc.

Note

- Discs need to be formatted for packet writing prior to use.
- Formatting a CD-RW disc using packet writing software reduces its storage capacity by about 100 MB since packet writing requires exclusive space for itself.
- For CD-R discs, deleting data means masking data but not actually removing data. Therefore, actual free space in a CD-R never be increased even if data is deleted.

Audio Master Quality Recording (High quality audio writing mode)

This method enables you to record high quality data that can be played back with the 1.4m/s linear velocity.

Note

- Audio Master Quality Recording (High quality audio writing mode) is enabled with the 4X speed Disc-at-Once writing method.
- Maximum recording time is 63 minutes for a 650 MB CD-R disc and 68 minutes for a 700 MB CD-R disc.

CD-MRW (CD Mount Rainier ReWriting)

This method is a new standard of packet writing for a CD-RW disc and supports defect control by the drive, background formatting, and disc ejecting during formatting. It enables you to use a CD-RW disc like a floppy disk.

Note

Formatting a CD-RW disc using CD-MRW reduces its storage capacity by about 150 MB since CD-MRW requires exclusive disc space.

Distributors and Head Offices / Vertriebs- und Hauptgeschäftsstelle Distributeurs et sièges sociaux / Distribuidores y Casas matrices

If you have any questions, please contact the store of purchase or your nearest Yamaha dealer listed below. Contact Yamaha Corporation Japan from outside of the listed countries.

Falls Sie weitere Fragen haben, wenden Sie sich an Ihren Fachhändler oder den örtlichen Yamaha-Händler (eine Liste der Yamaha-Händler befindet sich am Ende dieses Handbuchs). Aus anderen Ländern als den aufgeführten wenden Sie sich an Yamaha Corporation Japan.

Si vous avez des questions à poser, veuillez prendre contact avec le magasin où vous avez fait l'achat de l'appareil ou un revendeur de matériel Yamaha le plus proche de votre domicile parmi ceux énumérés ci-dessous. Prenez contact avec Yamaha Corporation Japan si vous ne vous trouvez pas dans un des pays mentionnés:

Si tiene alguna duda, póngase en contacto con el establecimiento de adquisición o con su representante Yamaha más cercano indicado a continuación. En caso de países no contemplados en la lista, póngase en contacto con Yamaha Corporation Japan:

EUROPE, EASTERN EUROPE and RUSSIA

**Yamaha Elektronik Europa GmbH
IT-Sales Division**

Siemensstrasse 22-34,
D-25462 Rellingen, GERMANY
URL: <http://www.yamaha-it.de/>

TEL: +80092624222

(AUSTRIA, BELGIUM, DENMARK, FINLAND,
FRANCE, GERMANY, HUNGARY, ICELAND,
IRELAND, ITALY, LUXEMBOURG,
NETHERLANDS, NORWAY, PORTUGAL, SPAIN,
SWEDEN, SWITZERLAND, UNITED KINGDOM)

TEL: +80093067
(MONACO)

If you are calling from outside the countries mentioned
above, or if you can't get through on the Yamaha toll-
free number, use the following number instead:

TEL: +3214400793

U.S.A.

Yamaha Electronics Corporation, USA

6660 Orangethorpe Avenue,
Buena Park, CA 90620, U.S.A.

TEL: +1 714 522 9105

FAX: +1 714 670 0108

URL: <http://www.yamaha.com/>

CANADA

Yamaha Canada Music Ltd.

135 Milner Avenue, Scarborough,
Ontario M1S 3R1, CANADA

TEL: +1 416 298 5664

FAX: +1 416 292 0732

URL: <http://www.yamaha.ca/>

AUSTRALIA

Yamaha Music Australia Pty., Ltd.

Level 1, 99 Queensbridge Street
Southbank, Victoria 3006

AUSTRALIA

TEL: +61 3 9693 5111

FAX: +61 3 9699 2332

SINGAPORE, MALAYSIA, KOREA, THAILAND, PHILIPPINES, INDIA, VIETNAM, CAMBODIA, MYANMAR, INDONESIA and IRAN

Yamaha Electronics Asia Pte Ltd.

138 Cecil Street

#05-02/03 Cecil Court, Singapore 069538 SINGAPORE

TEL: +65 223 3992

FAX: +65 223 9810

TAIWAN

Yamaha KHS Music Co., Ltd.

11F, No.150, Tun Hua North Rd.

Taipei, TAIWAN R.O.C.

TEL: +886 2 2713 8999

FAX: +886 2 2713 8666

URL: <http://www.yamahakhs.com/>

JAPAN

Yamaha Corporation

AV & IT Business Group

IT Sales & Marketing Division

10-1 Nakazawa-cho, Hamamatsu-shi, Shizuoka-ken
430-8650, JAPAN

TEL: +81 53 460 3433

FAX: +81 53 460 3489

URL: <http://www.yamaha.co.jp/english/>

