



Clavinova[®]

CVP-509 / 505 / 503 / 501

Owner's Manual

Thank you for purchasing this Yamaha Clavinova!

We recommend that you read this manual carefully so that you can fully take advantage of the advanced and convenient functions of the instrument.

We also recommend that you keep this manual in a safe and handy place for future reference.

Before using the instrument, be sure to read "PRECAUTIONS" on pages 6-7.

IMPORTANT —Check your power supply—

Make sure that your local AC mains voltage matches the voltage specified on the name plate on the bottom panel. In some areas a voltage selector may be provided on the bottom panel of the main keyboard unit near the power cord. Make sure that the voltage selector is set for the voltage in your area. The voltage selector is set at 240V when the unit is initially shipped. To change the setting use a "minus" screwdriver to rotate the selector dial so that the correct voltage appears next to the pointer on the panel.

For information on assembling the keyboard stand, refer to the instructions at the end of this manual.

SPECIAL MESSAGE SECTION

PRODUCT SAFETY MARKINGS: Yamaha electronic products may have either labels similar to the graphics shown below or molded/stamped facsimiles of these graphics on the enclosure. The explanation of these graphics appears on this page. Please observe all cautions indicated on this page and those indicated in the safety instruction section.

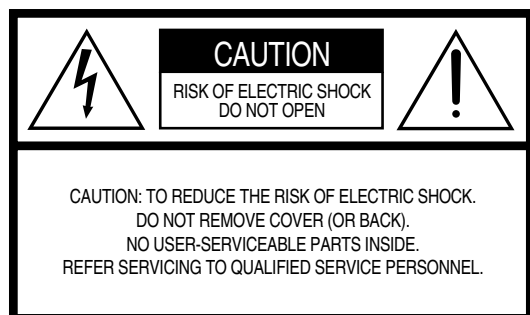

See bottom of Keyboard enclosure for graphic symbol markings.



The exclamation point within the equilateral triangle is intended to alert the user to the presence of important operating and maintenance (servicing) instructions in the literature accompanying the product.

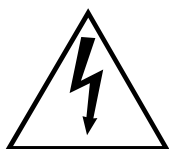

The lightning flash with arrowhead symbol, within the equilateral triangle, is intended to alert the user to the presence of uninsulated “dangerous voltage” within the product’s enclosure that may be of sufficient magnitude to constitute a risk of electrical shock.

IMPORTANT NOTICE: All Yamaha electronic products are tested and approved by an independent safety testing laboratory in order that you may be sure that when it is properly installed and used in its normal and customary manner, all foreseeable risks have been eliminated. DO NOT modify this unit or commission others to do so unless specifically authorized by Yamaha. Product performance and/or safety standards may be diminished. Claims filed under the expressed warranty may be denied if the unit is/has been modified. Implied warranties may also be affected.

SPECIFICATIONS SUBJECT TO CHANGE: The information contained in this manual is believed to be correct at the time of printing. However, Yamaha reserves the right to change or modify any of the specifications without notice or obligation to update existing units.

ENVIRONMENTAL ISSUES: Yamaha strives to produce products that are both user safe and environmentally friendly. We sincerely believe that our products and the production methods used to produce them, meet these goals. In keeping with both the letter and the spirit of the law, we want you to be aware of the following:

Battery Notice: This product MAY contain a small non-rechargeable battery which (if applicable) is soldered in place. The average life span of this type of battery is approximately five years. When replacement becomes necessary, contact a qualified service representative to perform the replacement.

Warning: Do not attempt to recharge, disassemble, or incinerate this type of battery. Keep all batteries away from children. Dispose of used batteries promptly and as regulated by applicable laws. Note: In some areas, the servicer is required by law to return the defective parts. However, you do have the option of having the servicer dispose of these parts for you.

Disposal Notice: Should this product become damaged beyond repair, or for some reason its useful life is considered to be at an end, please observe all local, state, and federal regulations that relate to the disposal of products that contain lead, batteries, plastics, etc.

NOTICE: Service charges incurred due to lack of knowledge relating to how a function or effect works (when the unit is operating as designed) are not covered by the manufacturer’s warranty, and are therefore the owners responsibility. Please study this manual carefully and consult your dealer before requesting service.

NAME PLATE LOCATION: The graphic below indicates the location of the name plate. The model number, serial number, power requirements, etc., are located on this plate. You should record the model number, serial number, and the date of purchase in the spaces provided below and retain this manual as a permanent record of your purchase.

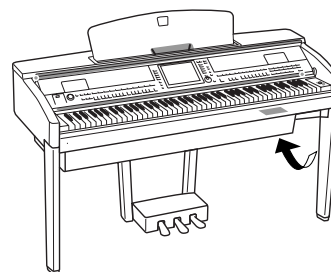

Model _____

Serial No. _____

Purchase Date _____

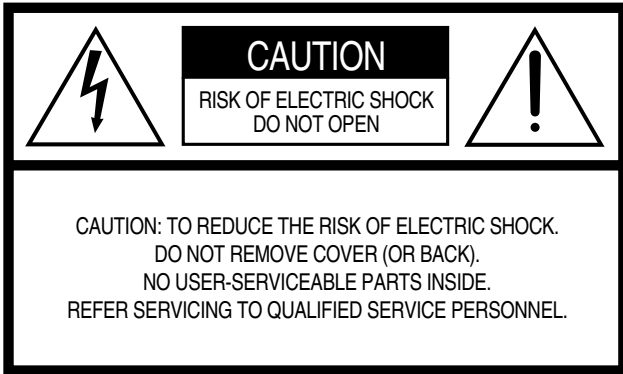

The above warning is located on the bottom of the unit.

Explanation of Graphical Symbols

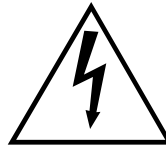

The lightning flash with arrowhead symbol within an equilateral triangle is intended to alert the user to the presence of uninsulated “dangerous voltage” within the product’s enclosure that may be of sufficient magnitude to constitute a risk of electric shock to persons.



The exclamation point within an equilateral triangle is intended to alert the user to the presence of important operating and maintenance (servicing) instructions in the literature accompanying the product.

IMPORTANT SAFETY INSTRUCTIONS

- 1 Read these instructions.
- 2 Keep these instructions.
- 3 Heed all warnings.
- 4 Follow all instructions.
- 5 Do not use this apparatus near water.
- 6 Clean only with dry cloth.
- 7 Do not block any ventilation openings. Install in accordance with the manufacturer’s instructions.
- 8 Do not install near any heat sources such as radiators, heat registers, stoves, or other apparatus (including amplifiers) that produce heat.
- 9 Do not defeat the safety purpose of the polarized or grounding-type plug. A polarized plug has two blades with one wider than the other. A grounding type plug has two blades and a third grounding prong. The wide blade or the third prong are provided for your safety. If the provided plug does not fit into your outlet, consult an electrician for replacement of the obsolete outlet.
- 10 Protect the power cord from being walked on or pinched particularly at plugs, convenience receptacles, and the point where they exit from the apparatus.
- 11 Only use attachments/accessories specified by the manufacturer.
- 12 Use only with the cart, stand, tripod, bracket, or table specified by the manufacturer, or sold with the apparatus. When a cart is used, use caution when moving the cart/apparatus combination to avoid injury from tip-over.
- 13 Unplug this apparatus during lightning storms or when unused for long periods of time.
- 14 Refer all servicing to qualified service personnel. Servicing is required when the apparatus has been damaged in any way, such as power-supply cord or plug is damaged, liquid has been spilled or objects have fallen into the apparatus, the apparatus has been exposed to rain or moisture, does not operate normally, or has been dropped.



WARNING

TO REDUCE THE RISK OF FIRE OR ELECTRIC SHOCK, DO NOT EXPOSE THIS APPARATUS TO RAIN OR MOISTURE.

(UL60065_03)

Information for Users on Collection and Disposal of Old Equipment



This symbol on the products, packaging, and/or accompanying documents means that used electrical and electronic products should not be mixed with general household waste.

For proper treatment, recovery and recycling of old products, please take them to applicable collection points, in accordance with your national legislation and the Directives 2002/96/EC.

By disposing of these products correctly, you will help to save valuable resources and prevent any potential negative effects on human health and the environment which could otherwise arise from inappropriate waste handling.

For more information about collection and recycling of old products, please contact your local municipality, your waste disposal service or the point of sale where you purchased the items.

[For business users in the European Union]

If you wish to discard electrical and electronic equipment, please contact your dealer or supplier for further information.

[Information on Disposal in other Countries outside the European Union]

This symbol is only valid in the European Union. If you wish to discard these items, please contact your local authorities or dealer and ask for the correct method of disposal.

Welcome to Clavinova

True Acoustic Piano Feel *Chapter 1 Perform the piano songs by Clavinova*

The Sound of Full Concert Grand Piano – Pure CF Sampling

This instrument features samples from Yamaha's most renowned full concert grand piano, the CFIIS, and employs meticulous processing and adjustment of each sample to achieve an extraordinarily realistic grand piano sound. You can conveniently call this up by a single panel button press. Enjoy the exceptionally expressive and delicate sound, with full, natural dynamic range.

Authentic Acoustic Piano-like Touch

Just as on an actual grand piano, the lower keys are heavy in touch and the higher keys are light, with all the natural gradations in between. The CVP-509/505/503 provide the performance functions and expressive power found only on grand pianos, such as having repeated plays of the same note perfectly articulated, even when playing at high speed or with partial key release.

The Acoustic Ambience of a Grand Piano—with the iAFC Feature (only CVP-509)page 34

By setting the iAFC (Instrumental Active Field Control) effect properly, you can enjoy the sound expand around you—as if you're playing on stage in a concert hall—providing a remarkably natural sound heretofore only found on acoustic instruments, and an overall sound which is deeper and more resonant through use of the damper pedal.

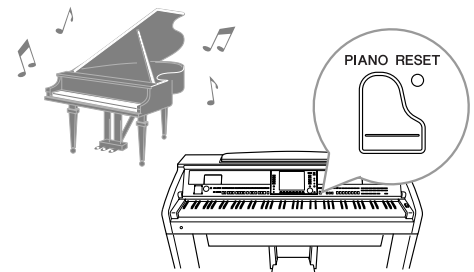

Play a Wide Variety of Instrument Voices *Chapter 2 Voices*

The instrument gives you not only various realistic piano Voices, but also features an exceptionally wide variety of authentic instruments, both acoustic and electronic.

VOICE CONTROL

<input type="radio"/> PIANO	<input type="radio"/> E.PIANO	<input type="radio"/> STRINGS	<input type="radio"/> GUITAR & BASS	<input type="radio"/> SAXOPHONE	<input type="radio"/> FLUTE & WOODWIND	<input type="radio"/> ORGAN
<input type="radio"/> RUMPET	<input type="radio"/> BRASS	<input type="radio"/> ACCORDION	<input type="radio"/> CHOIR & PAD	<input type="radio"/> SYNTH & FX	<input type="radio"/> PERC. & DRUM KIT	<input type="radio"/> ORGAN FLUTES



Perform Along with a Backing Band *Chapter 3 Styles*

Playing a chord with your left hand automatically plays the auto accompaniment backing (Style function). Select an accompaniment style — such as pop, jazz, Latin, and various other music genres in the world — and let the instrument be your backing band!



STYLE CONTROL

<input type="radio"/> POP&ROCK	<input type="radio"/> BALLAD	<input type="radio"/> DANCE	<input type="radio"/> SWING&JAZZ	<input type="radio"/> R & B	<input type="radio"/> COUNTRY	<input type="radio"/> LATIN	<input type="radio"/> BALLROOM	<input type="radio"/> ENTERTAINMENT	<input type="radio"/> WORLD	<input type="radio"/> PIANIST						
<input type="radio"/> ACMP ON/OFF	<input type="radio"/> AUTO FILL IN	<input type="radio"/> INTRO I	<input type="radio"/> INTRO II	<input type="radio"/> INTRO III	<input type="radio"/> MAIN VARIATION A	<input type="radio"/> MAIN VARIATION B	<input type="radio"/> MAIN VARIATION C	<input type="radio"/> MAIN VARIATION D	<input type="radio"/> BREAK	<input type="radio"/> ENDING/ril. I	<input type="radio"/> ENDING/ril. II	<input type="radio"/> ENDING/ril. III	<input type="radio"/> SYNC STOP	<input type="radio"/> SYNC START	<input type="radio"/> START/STOP	<input type="radio"/> MUSIC FINDER

Play Along with Song Data *Chapter 4 Songs*

Playing Back Songspage 59

Play along with a Song data, and fill out your solo performance with the sounds of an entire band or orchestra. Enjoy a wide variety of songs — commercially available music data or preset songs.

Guide functionpage 64

The key guide lamps are also helpful in learning and practicing, since they indicate the notes you should play, when you should play them, and how long you should hold them down.

Displaying Music Scorepage 62

While playing back a Song, you can have the music score (notation) automatically shown on the display — an exceptionally convenient tool for learning and practicing pieces.

Recording Your Performancepage 66

The instrument lets you easily record your own performance and save it to internal memory or a USB flash memory. The instrument also lets you listen back to your performance, and further edit it or utilize it for your music production.

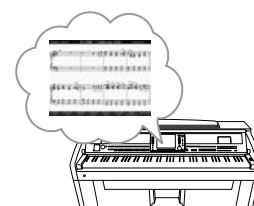

Call Up the Ideal Voice and Style for Each Song *Chapter 5 Music Finder*

By using the convenient Music Finder function, you can call up the ideal panel settings including the most suitable Voice, Style, effects, etc. for each song. By registering the Song/audio data saved in various places into Music Finder, the instrument can call up song data easily from the song title. Moreover, the Music Finder Plus function gives you the capability, by connecting the instrument to the Internet, of searching for and adding desired panel settings and song data via the Internet to the instrument.

Audio Playing and Recording from USB Flash Memory (CVP-509/505/503)

Audio files (WAV or MP3*) stored to USB flash memory can be played back on the instrument.

Moreover, you can record your performance as audio data to a USB flash memory device.

Connect a microphone to the instrument and enjoy recording your singing along with the keyboard performance.

* The MP3 format is supported only by the CVP-509/505.

Chapter 7 USB Audio

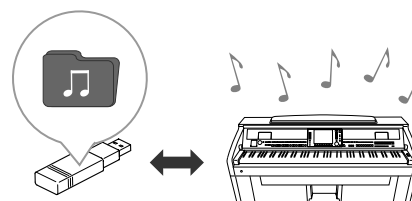

Connect Directly to the Internet *Chapter 9 Internet Direct Connection*

The instrument also connects directly to the Internet, letting you download Song and Style data from special websites, and save them to internal memory or a USB storage device.

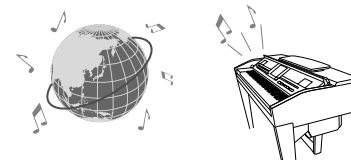

PRECAUTIONS

PLEASE READ CAREFULLY BEFORE PROCEEDING

* Please keep this manual in a safe place for future reference.



WARNING

Always follow the basic precautions listed below to avoid the possibility of serious injury or even death from electrical shock, short-circuiting, damages, fire or other hazards. These precautions include, but are not limited to, the following:

Power supply/Power cord

- Only use the voltage specified as correct for the instrument. The required voltage is printed on the name plate of the instrument.
- Check the electric plug periodically and remove any dirt or dust which may have accumulated on it.
- Use only the supplied power cord/plug.
- Do not place the power cord near heat sources such as heaters or radiators, and do not excessively bend or otherwise damage the cord, place heavy objects on it, or place it in a position where anyone could walk on, trip over, or roll anything over it.

Do not open

- Do not open the instrument or attempt to disassemble the internal parts or modify them in any way. The instrument contains no user-serviceable parts. If it should appear to be malfunctioning, discontinue use immediately and have it inspected by qualified Yamaha service personnel.

Water warning

- Do not expose the instrument to rain, use it near water or in damp or wet conditions, or place containers on it containing liquids which might spill into any openings. If any liquid such as water seeps into the instrument, turn off the power immediately and unplug the power cord from the AC outlet. Then have the instrument inspected by qualified Yamaha service personnel.
- Never insert or remove an electric plug with wet hands.

Fire warning

- Do not put burning items, such as candles, on the unit. A burning item may fall over and cause a fire.

If you notice any abnormality

- If the power cord or plug becomes frayed or damaged, or if there is a sudden loss of sound during use of the instrument, or if any unusual smells or smoke should appear to be caused by it, immediately turn off the power switch, disconnect the electric plug from the outlet, and have the instrument inspected by qualified Yamaha service personnel.



CAUTION

Always follow the basic precautions listed below to avoid the possibility of physical injury to you or others, or damage to the instrument or other property. These precautions include, but are not limited to, the following:

Power supply/Power cord

- When removing the electric plug from the instrument or an outlet, always hold the plug itself and not the cord. Pulling by the cord can damage it.
- Remove the electric plug from the outlet when the instrument is not to be used for extended periods of time, or during electrical storms.
- Do not connect the instrument to an electrical outlet using a multiple-connector. Doing so can result in lower sound quality, or possibly cause overheating in the outlet.

Assembly

- Read carefully the attached documentation explaining the assembly process. Failure to assemble the instrument in the proper sequence might result in damage to the instrument or even injury.

Location

- Do not expose the instrument to excessive dust or vibrations, or extreme cold or heat (such as in direct sunlight, near a heater, or in a car during the day) to prevent the possibility of panel disfiguration or damage to the internal components.
- Do not use the instrument in the vicinity of a TV, radio, stereo equipment, mobile phone, or other electric devices. Otherwise, the instrument, TV, or radio may generate noise.
- Do not place the instrument in an unstable position where it might accidentally fall over.
- Before moving the instrument, remove all connected cables.
- When setting up the product, make sure that the AC outlet you are using is easily accessible. If some trouble or malfunction occurs, immediately turn off the power switch and disconnect the plug from the outlet. Even when the power switch is turned off, electricity is still flowing to the product at the minimum level. When you are not using the product for a long time, make sure to unplug the power cord from the wall AC outlet.
- Do not place the instrument against a wall (allow at least 3 cm/one-inch from the wall), since this can cause inadequate air circulation, and possibly result in the instrument overheating.

Connections

- Before connecting the instrument to other electronic components, turn off the power for all components. Before turning the power on or off for all components, set all volume levels to minimum. Also, be sure to set the volumes of all components at their minimum levels and gradually raise the volume controls while playing the instrument to set the desired listening level.

Maintenance

- In the case of a model with a polished finish, gently remove dust and dirt with a soft cloth. Do not wipe too hard since small particles of dirt can scratch the instrument's finish.
- When cleaning the instrument, use a soft, dry or slightly damp cloth. Do not use paint thinners, solvents, cleaning fluids, or chemical-impregnated wiping cloths.
- During extreme changes in temperature or humidity, condensation may occur and water may collect on the surface of the instrument. If water is left, the wooden parts may absorb the water and be damaged. Make sure to wipe any water off immediately with a soft cloth.

Handling caution

- Take care that the key cover does not pinch your fingers, and do not insert a finger or hand in any gaps on the key cover or instrument.
- Never insert or drop paper, metallic, or other objects into the gaps on the key cover, panel or keyboard. If this happens, turn off the power immediately and unplug the power cord from the AC outlet. Then have the instrument inspected by qualified Yamaha service personnel.
- Do not place vinyl, plastic or rubber objects on the instrument, since this might discolor the panel or keyboard.
- In the case of a model with a polished finish, bumping the surface of the instrument with metal, porcelain, or other hard objects can cause the finish to crack or peel. Use caution.
- Do not rest your weight on, or place heavy objects on the instrument, and do not use excessive force on the buttons, switches or connectors.
- Do not use the instrument/device or headphones for a long period of time at a high or uncomfortable volume level, since this can cause permanent hearing loss. If you experience any hearing loss or ringing in the ears, consult a physician.

Using the bench (If included)

- Do not place the bench in an unstable position where it might accidentally fall over.
- Do not play carelessly with or stand on the bench. Using it as a tool or step-ladder or for any other purpose might result in accident or injury.
- Only one person should sit on the bench at a time, in order to prevent the possibility of accident or injury.
- Do not attempt to adjust the bench height while sitting on the bench, since this can cause excessive force to be imposed on the adjustment mechanism, possibly resulting in damage to the mechanism or even injury.
- If the bench screws become loose due to extensive long-term use, tighten them periodically using the included tool.

Saving data

Saving and backing up your data

- Edited Songs/Styles/Voices and MIDI settings are lost when you turn off the power to the instrument. Save the data to the USER tab display (page 68), USB storage device (USB flash memory/floppy disk, etc).
- Data in the USER tab display may be lost due to malfunction or incorrect operation. Save important data to a USB storage device.

When you change settings in a display page and then exit from that page, Data other than above (edited Songs/Styles/Voices and MIDI settings, etc.) is automatically stored. However, this edited data is lost if you turn off the power without properly exiting from the relevant display.

Backing up the USB storage device

- To protect against data loss through media damage, we recommend that you save your important data onto two USB storage devices.

Yamaha cannot be held responsible for damage caused by improper use or modifications to the instrument, or data that is lost or destroyed.



Always turn the power off when the instrument is not in use.

Notices and Information

Copyright Notices

- Copying of the commercially available musical data including but not limited to MIDI data and/or audio data is strictly prohibited except for your personal use.
- This product incorporates and bundles computer programs and contents in which Yamaha owns copyrights or with respect to which it has license to use others' copyrights. Such copyrighted materials include, without limitation, all computer software, style files, MIDI files, WAVE data, musical scores and sound recordings. Any unauthorized use of such programs and contents outside of personal use is not permitted under relevant laws.
Any violation of copyright has legal consequences. **DON'T MAKE, DISTRIBUTE OR USE ILLEGAL COPIES.**

Information about functions/data bundled in the instrument

- Some of the preset songs have been edited for length or arrangement, and may not be exactly the same as the original.
- This device is capable of using various types/formats of music data by optimizing them to the proper format music data for use with the device in advance. As a result, this device may not play them back precisely as their producers or composers originally intended.
- The bitmap fonts used in this instrument have been provided by and are the property of Ricoh Co., Ltd.
- This product utilizes NF, an embedded Internet browser from ACCESS Co., Ltd. NF may not be separated from this product, nor may it be sold, lent or transferred in any way. Also, NF may not be reverse-engineered, reverse-compiled, reverse-assembled or copied. 
- This software includes a module developed by the Independent JPEG Group.
- The photos of the harpsichord, bandoneon, hackbrett, music box, dulcimer and cimbalom, shown in the displays of the Clavinova, are courtesy of the Gakkigaku Shiryokan (Collection for Organology), Kunitachi College of Music.
- The following instruments, shown in the displays of the Clavinova, are on display at the Hamamatsu Museum of Musical Instruments: balafon, gender, kalimba, kanoon, santur, gamelan gong, harp, hand bell, bagpipe, banjo, carillon, mandolin, oud, pan flute, pungi, rabab, shanai, sitar, steel drum, and tambra.
- (CVP-509/505/503) This product is manufactured under license of U.S. Patents No.5231671, No.5301259, No.5428708, and No.5567901 from IVL Audio Inc.
- (CVP-509/505) MPEG Layer-3 audio coding technology licensed from Fraunhofer IIS and Thomson. 

Included Accessories

- Accessory CD-ROM for Windows
- Owner's Manual
- Data List
- Accessory CD-ROM for Windows Installation Guide
- "50 greats for the Piano" Music Book
- My Yamaha Product User Registration

*The PRODUCT ID on the sheet will be needed when you fill out the User Registration form.

The following item may be included or optional, depending on your locale:

- Bench

The instrument is compatible with the following formats.



"GM (General MIDI)" is one of the most common Voice allocation formats. "GM System Level 2" is a standard specification that enhances the original "GM" and improves Song data compatibility. It provides for increased polyphony, greater Voice selection, expanded Voice parameters, and integrated effect processing.



XG is a major enhancement of the GM System Level 1 format, and was developed by Yamaha specifically to provide more Voices and variations, as well as greater expressive control over Voices and effects, and to ensure compatibility of data well into the future.



GS was developed by the Roland Corporation. In the same way as Yamaha XG, GS is a major enhancement of the GM specifically to provide more Voices and Drum kits and their variations, as well as greater expressive control over Voices and effects.



The Yamaha XF format enhances the SMF (Standard MIDI File) standard with greater functionality and open-ended expandability for the future. This instrument is capable of displaying lyrics when an XF file containing lyric data is played.



"SFF (Style File Format)" is an original Style file format by Yamaha which uses a unique conversion system to provide high-quality automatic accompaniment based on a wide range of chord types. "SFF GE (Guitar Edition)" is an enhanced format of SFF, which features improved note transposition for guitar tracks.



(CVP-509/505/503)
VH (Vocal Harmony) employs the digital signal processing technology to automatically add appropriate vocal harmonies to a lead vocal line sung by the user.



(CVP-509)
"AEM" is the trademark of Yamaha's leading-edge tone generation technology. For information on AEM, refer to page 41.

About the Manuals

This instrument has the following documents and instructional materials.

Included Documents



Owner's Manual (this book)

Provides overall explanations of the Clavinova basic functions. See "How to use this Owner's Manual" below.



Data List

Contains various important preset content lists such as Voices, Styles, Effects, as well as MIDI-related information.



Installation Guide

Provides introduction to the contents of the supplied CD-ROM and explains how to install the included software.

Online Materials (Downloadable from the web)

The following instructional materials are available for downloading from the Yamaha Manual Library. Access the Yamaha Manual Library, then enter your model name (CVP-509, for example) in the Model Name area to search the manuals.

Yamaha Manual Library <http://www.yamaha.co.jp/manual/>



Reference Manual (only in English, French, German and Spanish)

Explains advanced features of the instrument, not explained in the Owner's Manual. For example, you can learn how to create original Styles or Songs, or find detailed explanations of specific parameters.



Internet Connection Guide (only in English, French, German and Spanish)

Explains how to connect the instrument to the Internet in detail, in order to use the Internet Direct Connection function.



MIDI Basics (only in English, French, German and Spanish)

If you want to know more about MIDI and how to use it, refer to this introductory book.

How to use this Owner's Manual

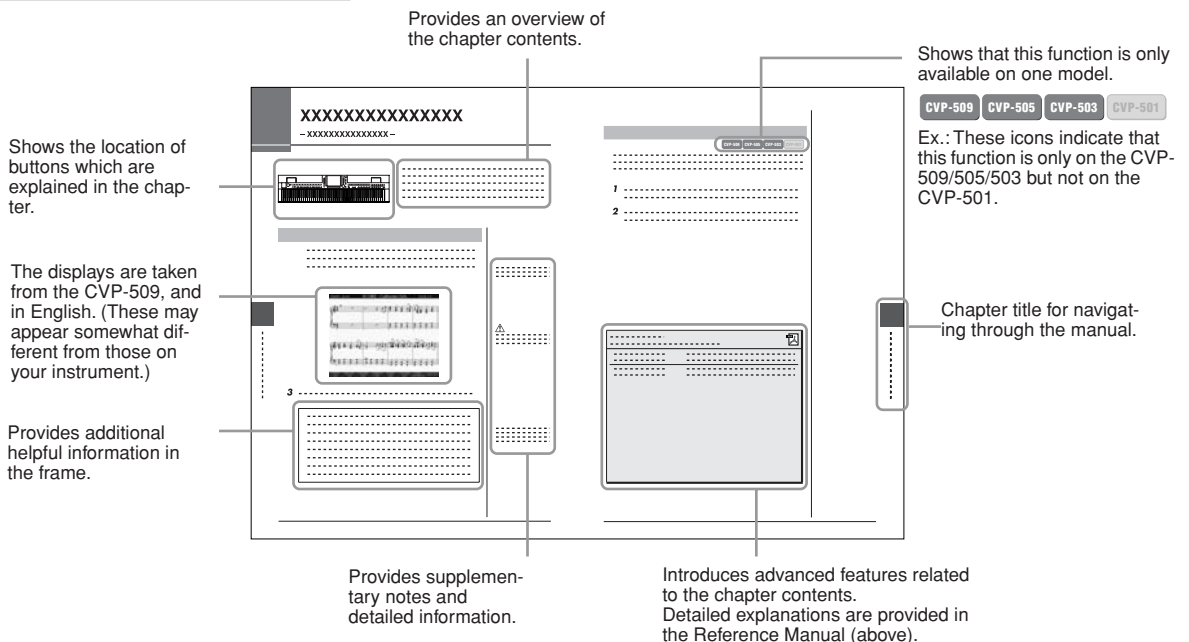

- The illustrations and LCD screens as shown in this manual are for instructional purposes only, and may appear somewhat different from those on your instrument.
- The example Operation Guide displays shown in this Manual are taken from the CVP-509, and in English.
- The company names and product names in this manual are the trademarks or registered trademarks of their respective companies.

Contents

Welcome to Clavinova	4
Notices and Information	8
Included Accessories	9
About the Manuals	10
Panel Controls	12
Starting Up	14
Powering Up	14
Using the Music Rest	15
Using Headphones	16
Changing the Display Language	17
Adjusting the Contrast of the Display <small>CVP-503 CVP-501</small>	17
Showing the Owner Name in the Opening Display	18
Playing the Demos	18
Display-based Controls	20
The Messages Shown in the Display	23
Instant Selection of the Displays — Direct Access	23
Main Display Configuration	24
File Selection Display Configuration	26
Entering Characters	27
Restoring the Factory-programmed Settings	29
Data Backup	29
1 Perform the piano songs by Clavinova	30
One-touch Piano Play	30
Setting the touch sensitivity of the keyboard	31
Using the Pedals	32
Using the Metronome	33
Enhancing the Acoustic Realism of the Sound (iAFC) <small>CVP-500</small>	34
Maintenance	36
2 Voices – Playing the keyboard –	37
Playing Preset Voices	37
Transposing the Pitch of the Keyboard	42
Adding Articulation Effects to Super Articulation Voices	43
Applying Voice Effects	44
Creating Your Original Organ Flutes Voices	46
3 Styles – Playing Rhythm and Accompaniment –	48
Playing Only the Rhythm Channels of a Style	48
Playing a Style with the Auto Accompaniment	49
Operating Style Playback	52
Calling up the Panel Settings to Match the Style (Repertoire)	54
Appropriate Panel Settings for the Selected Style (One Touch Setting)	55
Turning Style Parts On/Off and Changing Voices	57
Adjusting the Volume Balance Between the Style and Keyboard	58
4 Songs – Playing, Practice and Recording Songs –	59
Playback of Songs	59
Displaying Music Notation (Score)	62
Displaying Lyrics (Text)	63
Turning Song Channels On/Off	64
One-handed Practice with the Guide Lamps	64
Repeat Playback	65
Recording Your Performance (Quick Recording)	66
Saving Files	68
File Management	69
5 Music Finder – Calling Up Ideal Setups (Voice, Style, etc.) for Each Song –	73
Selecting the Desired Song from among the Panel Settings	75
Searching the Panel Settings	76
Registering the Song/Audio data (SONG/AUDIO)	77
6 Registration Memory – Saving and Recalling Custom Panel Setups –	79
Registering Your Panel Setups	79
Saving the Registration Memory as a Bank file	80
7 USB Audio (CVP-509/505/503) – Playback and Recording Audio Files –	83
Playing Back Audio Files	83
Recording Your Performance as Audio	86
8 Mixing Console – Editing the Volume and Tonal Balance –	88
Basic Procedure	88
Changing Voices and Adjusting Panning/Volume for Each Part	90
Applying Effects to Each Part	92
Adjusting the Overall Volume Using the Master Compressor <small>CVP-500</small>	93
9 Internet Direct Connection – Connecting the Clavinova Directly to the Internet –	95
Entering the Internet Direct Connection Function	95
Connecting the Instrument to the Internet	95
Operations in the Special Website	97
10 Connections – Using Your Instrument with Other Devices –	99
Connecting Audio Devices	100
Connecting an External Monitor <small>CVP-500 CVP-505</small>	101
Connecting a Microphone or Guitar <small>CVP-500 CVP-505 CVP-503</small>	102
Connecting a Footswitch/Foot Controller	105
Connecting a USB Storage Device	106
Connecting to the Internet	107
Connecting to a Computer	108
Connecting External MIDI Devices	109
11 Utility – Making Global Settings –	110
Basic Procedure	110
CVP-509/505: Keyboard Stand Assembly	111
CVP-503: Keyboard Stand Assembly	114
CVP-501: Keyboard Stand Assembly	116
Installing the Floppy Disk Drive (Optional) (CVP-509/505)	118
Handling the Floppy Disk Drive (FDD) and Floppy Disks	119
Troubleshooting	120
Panel Button Chart	123
Specifications	125
Index	128

Panel Controls

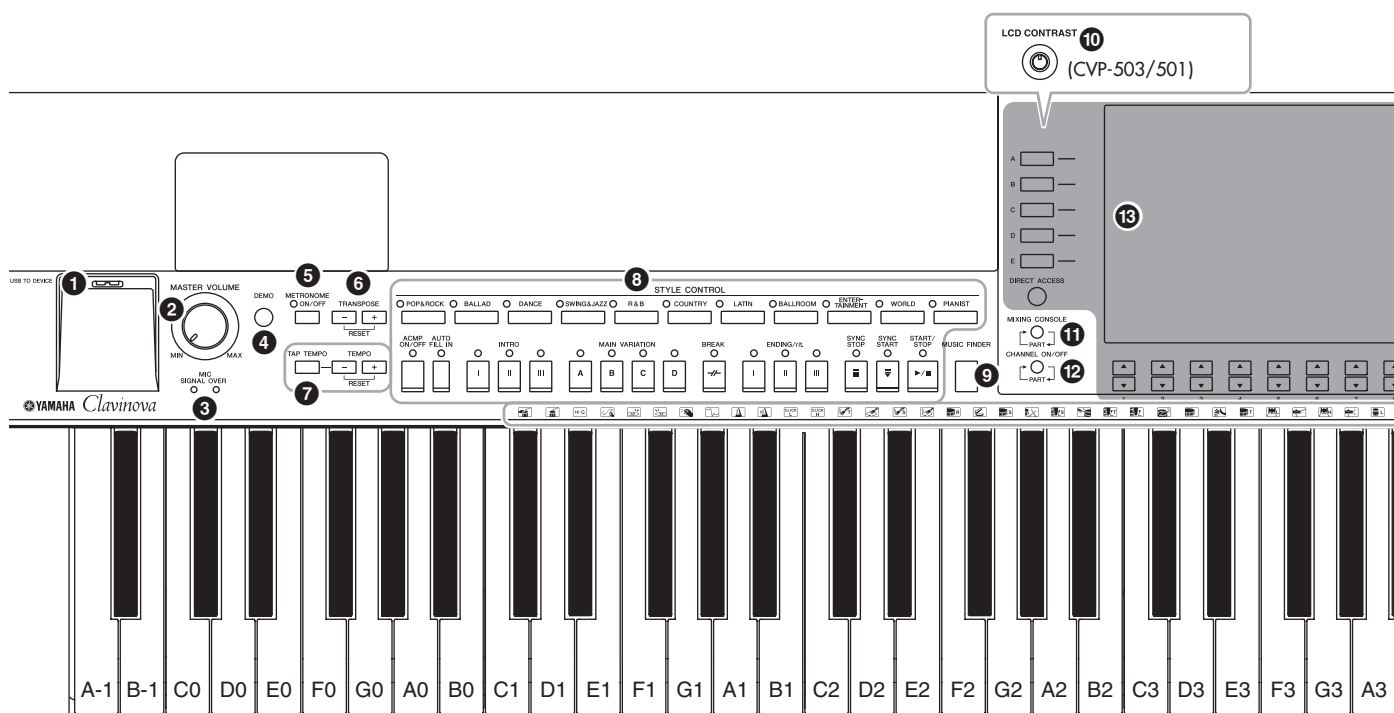

- 1 [USB TO DEVICE] terminal**Page 106
For connecting a USB storage device.
- 2 [MASTER VOLUME] control**Page 15
Adjusts the overall volume.
- 3 MIC [SIGNAL]/[OVER] lamps (CVP-509/505/503)**Page 102
These indicate the input level of the connected microphone.
- 4 [DEMO] button**Page 18
Plays the Demos.
- 5 [METRONOME ON/OFF] button**Page 33
Turns the metronome sound on or off.
- 6 TRANSPOSE buttons**Page 42
These transpose the pitch in semitone steps.
- 7 [TAP TEMPO]/TEMPO buttons**Page 53
These control the tempo for Style, Song and Metronome playback.
- 8 STYLE CONTROL buttons**Page 48
These select a Style and control Style playback.
- 9 [MUSIC FINDER] button**Page 73
Searches the appropriate panel settings or desired song.
- 10 [LCD CONTRAST] knob (CVP-503/501)**Page 17
Adjusts the LCD contrast.
- 11 [MIXING CONSOLE] button**Page 88
Controls over aspects of keyboard, Style and Song parts.
- 12 [CHANNEL ON/OFF] button**.....Page 57, 64
Turns channels of Style/Song on or off.
- 13 LCD and related controls**.....Page 20
- 14 [USB] button** Page 26, 83
Loads certain data to the USB storage device and allows you to record your performance to the USB storage device in audio format.
- 15 [FUNCTION] button (See Reference Manual on website.)**
Lets you make some advanced settings and create your original Styles and Songs.
- 16 PART ON/OFF buttons** Page 39
Turns the keyboard parts on or off.
- 17 [INTERNET] button** Page 95
Accesses to Internet website.
- 18 SONG CONTROL buttons** Page 59
These select a Song and control Song playback.
- 19 [PIANO RESET] button**..... Page 30
Recalls the grand piano settings.
- 20 REGISTRATION MEMORY buttons**..... Page 79
These register and recall panel setups.
- 21 VOICE CONTROL buttons**..... Page 37
These select a Voice.
- 22 ONE TOUCH SETTING buttons**..... Page 55
These call up the appropriate panel settings for the Style.
- 23 [VOICE EFFECT] button** Page 44
Applies some effects to the keyboard performance.
- 24 Power switch** Page 14
Turns the instrument's power on or off.
- 25 Drum Kit icons** Page 40
These indicate drum instruments assigned to each key when the Standard Kit 1 is selected.

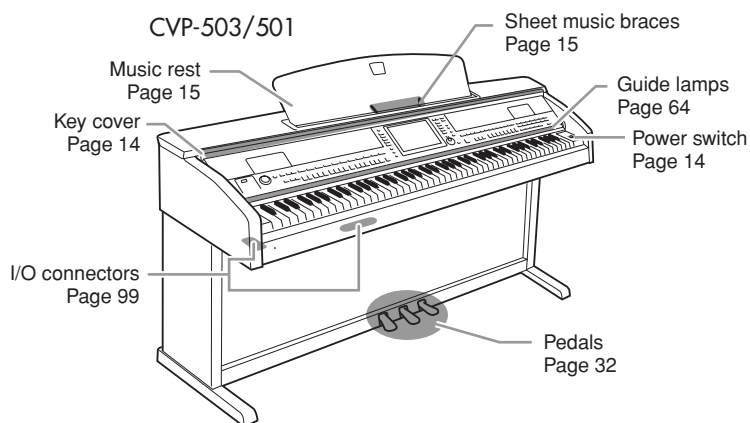
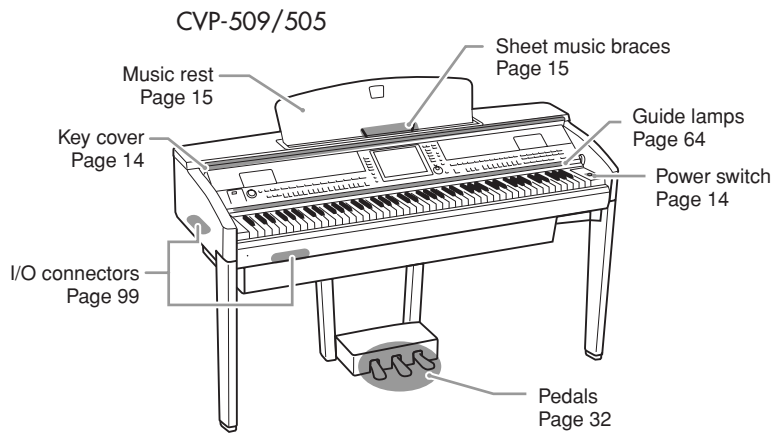
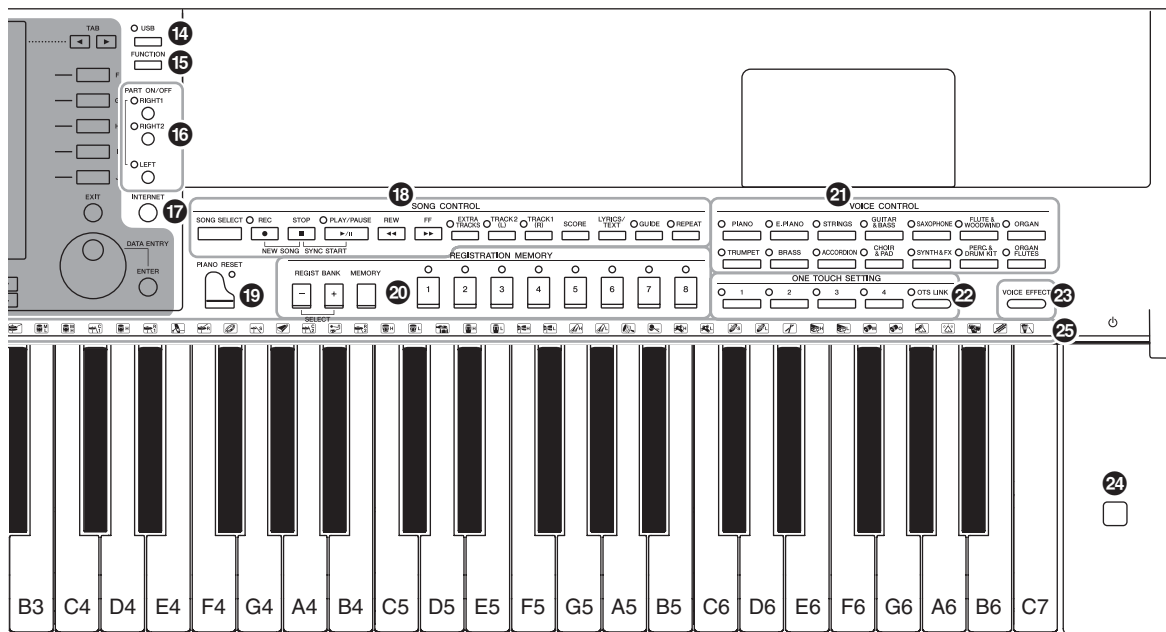

Starting Up

Powering Up

1 Connect the power cable.

First insert the plug of the power cable into the AC connector on the instrument, then plug the other end of the cable into the proper AC outlet on the wall.

1-1
CVP-509/505

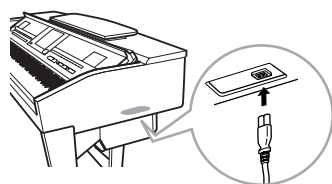

CVP-503/501

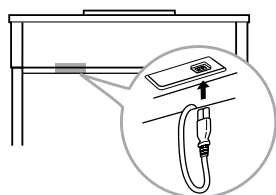

1-2

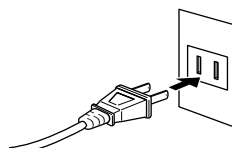

The shape of the plug and outlet differ depending on locale.)

2 Open the key cover.

CVP-509/505/503: Using the hand grip on the front, lift open the key cover.

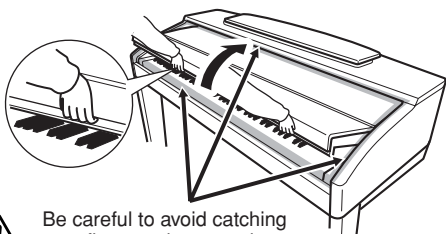

Be careful to avoid catching your fingers when opening the cover.

CVP-501: Lift the cover slightly, then push and slide it open.



Be careful to avoid catching your fingers when opening the cover.

3 Turn the power on.

The display located in the center of the front panel and the power indicator located below the left end of the keyboard lights up.

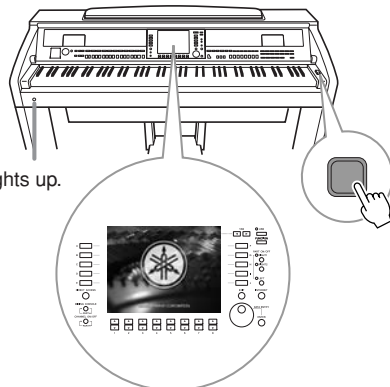

The power indicator lights up.

CAUTION

Hold the cover with both hands when opening or closing it. Do not release it until it is fully opened or closed. Be careful to avoid catching fingers (yours or others, especially children's) between the cover and the unit.

CAUTION

Do not place objects such as a piece of metal or paper on top of the key cover. Small objects placed on the key cover may fall inside the unit when the cover is opened and may be nearly impossible to remove. This could cause electric shock, short circuit, fire or other serious damage to the instrument.

4 Adjust the volume.

While playing the keyboard, adjust the volume level by using the [MASTER VOLUME] located at the left of the panel.

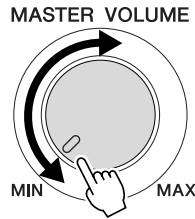

5 After you use the instrument, press the power switch to turn the power off.

The screen and the power indicator turn off.

6 Close the key cover.

CVP-509/505/503: Grip the metal rim at the top of the panel, and close the key cover.

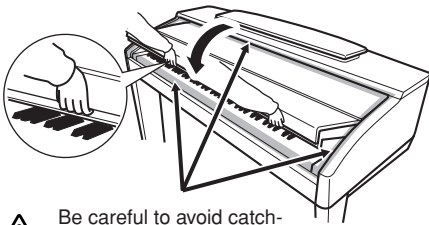

Be careful to avoid catching your fingers when closing the cover.

CVP-501: Slide the cover toward you and gently lower the cover over the keys.

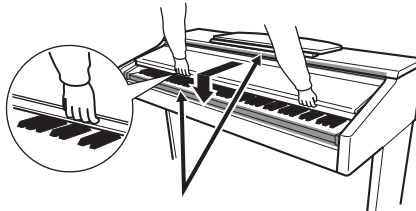

Be careful to avoid catching your fingers when closing the cover.

CAUTION

Even when the power switch is turned off, electricity is still flowing to the instrument at the minimum level. When you are not using the instrument for a long time, make sure you unplug the power cable from the wall AC outlet.

Using the Music Rest

CVP-509/505/503

Pull the music rest toward yourself as far as it will go. When raised, the music rest is fixed at a certain angle and cannot be adjusted.

The braces allow you to hold the pages of music books in place.

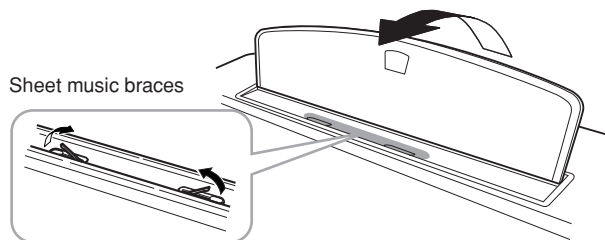

To lower the music rest, lift the music rest slightly, then turn it back slowly.

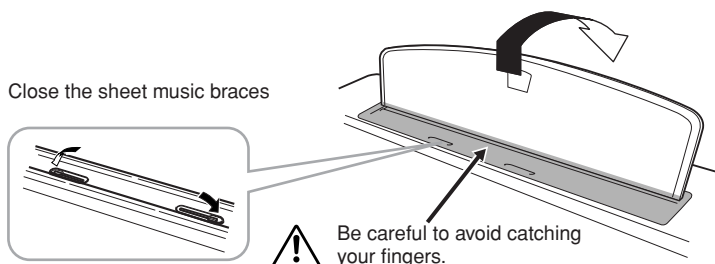

Close the sheet music braces



Be careful to avoid catching your fingers.

CAUTION

When raising or lowering the music rest, do not release your hands from the music rest until it is all the way up or down.

CAUTION

Before lowering the music rest, close the sheet music braces. The music rest will not close unless the sheet music braces are also closed.

CVP-501

First pull the music rest up and toward yourself as far as it will go, flip down the two metal supports at the left and right on the rear of the music rest, then lower the music rest so that it rests on the metal supports.

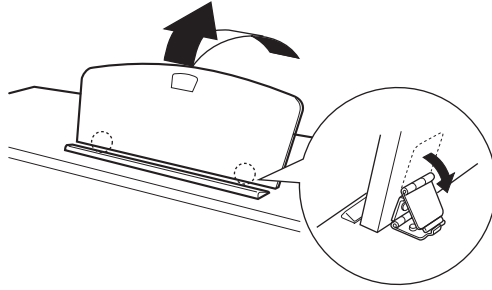

To lower the music rest, first pull the music rest toward yourself as far as it will go, raise the two metal supports, then gently lower the music rest backward until it is all the way down.

Using Headphones

Connect a pair of headphones to one of the [PHONES] jacks located on the bottom left of the instrument.

Two sets of standard stereo headphones can be connected. (If you are using only one pair of headphones, you can plug them into either of these jacks.)

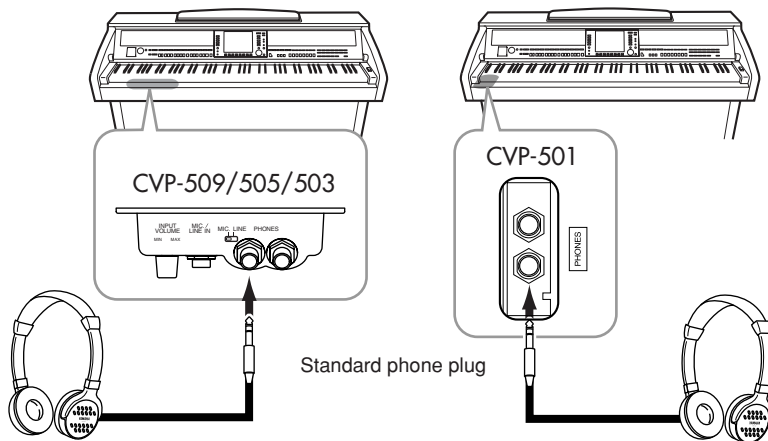

Using the Headphone Hanger

A headphone hanger is included in the instrument package so that you can hang the headphones on the instrument. Install the headphone hanger using included two screws (4 x 10mm) as shown in the figure.

CVP-509/505

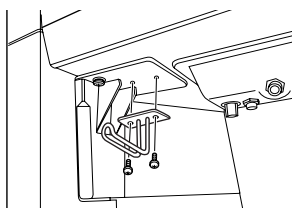

CVP-503/501

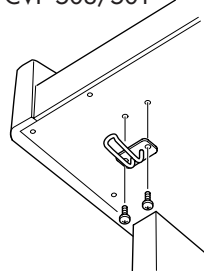

CAUTION

Do not try to use the music rest in a half-raised position.

CAUTION

Do not listen with the headphones at high volume for long periods of time. Doing so may cause hearing loss.

CAUTION

Do not hang anything other than the headphones on the hanger. Otherwise, the instrument or the hanger may be damaged.

Changing the Display Language

This determines the language used in the display for messages, file names, and character input.

1 Call up the operation display.

[FUNCTION] → [J] UTILITY → TAB [◀][▶] OWNER

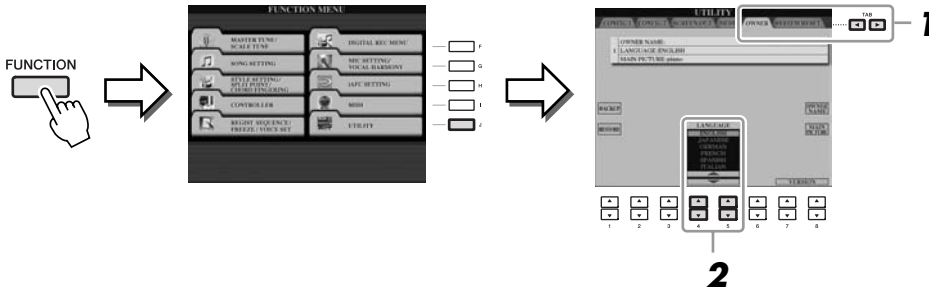

2 Use the [4 ▲▼]/[5 ▲▼] buttons to select the desired language.

Adjusting the Contrast of the Display

CVP-509 CVP-505 CVP-503 CVP-501

You can adjust the contrast of the display by turning the [LCD CONTRAST] knob located to the left of the display.

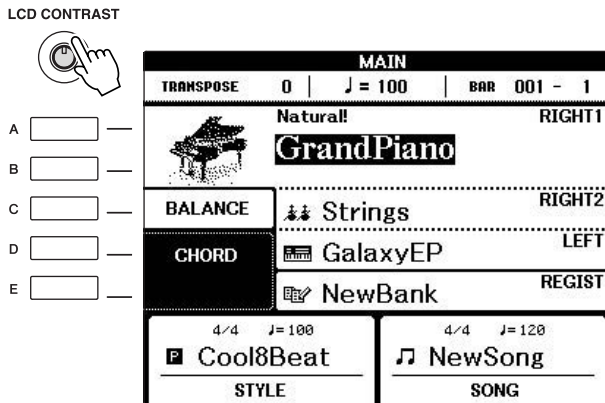

NOTE

Throughout this manual, arrows are used in the instructions, indicating in shorthand the process of calling up certain displays and functions.

NOTE

Since the color display of the CVP-509/505 has a high level of visibility, no contrast adjustment function is necessary.

Showing the Owner Name in the Opening Display

You can have your name appear in the opening display (the display that appears when the power is turned on).

1 Call up the operation display.

[FUNCTION] → [J] UTILITY → TAB [◀][▶] OWNER

2 Press the [I] (OWNER NAME) button to call up the Owner Name display.

Refer to page 27 for character-entry details.



NOTE

(CVP-509/505) If desired, you can also change the background picture in the Main display by pressing the [J] (MAIN PICTURE) button in step 2 here.

Display the version number

To check the version number of this instrument, press the [7 ▲▼]/[8 ▲▼] (VERSION) buttons in the display in step 1 above. Press the [EXIT] button or [8 ▲▼] button to return to the original display.

Playing the Demos

The Demos provide helpful, easy-to-understand introductions to the features and functions as well as sound demonstrations.

1 Press the [DEMO] button to start the Demos.

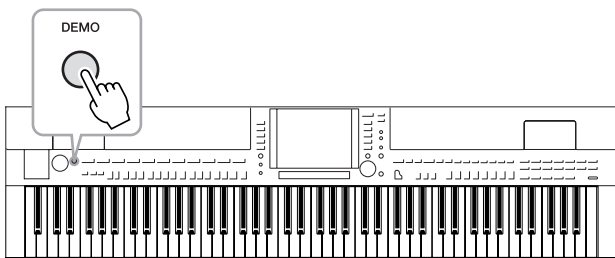

Overview Demo will play back continuously, calling up the various displays in sequence.

2 Press the [7 ▲▼]/[8 ▲▼] (SKIP OVERVIEW) buttons in the Demo display to call up the specific Demo menu.

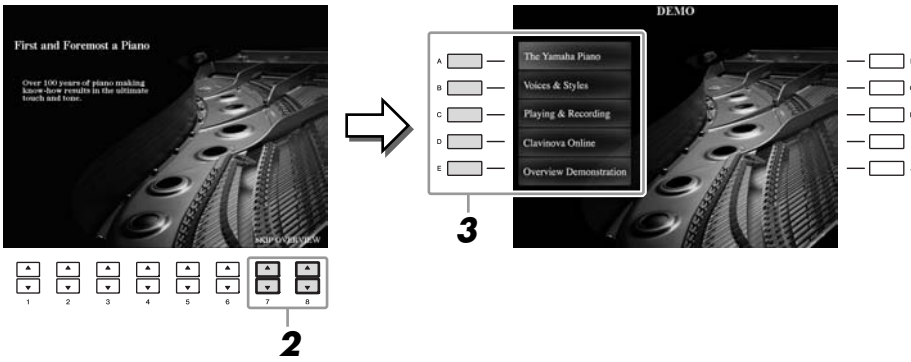

3 Press one of the [A] – [D] buttons to show a specific Demo.

Pressing the [E] button returns to the display of step 2.

The sub menus are shown at the bottom of the display. Press one of the [1 ▲▼] – [8 ▲▼] buttons corresponding to the sub menu.

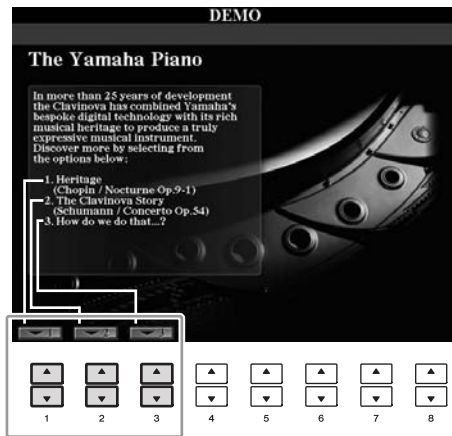

4 Press the [EXIT] button several times to exit from the Demos.

NOTE

The demo menu differs depending on your instrument.

NOTE

To return to the higher level menu, press the [EXIT] button.

Display-based Controls

The LCD provides comprehensive at-a-glance information on all current settings. The displayed menu can be selected or changed by the controls around the LCD.

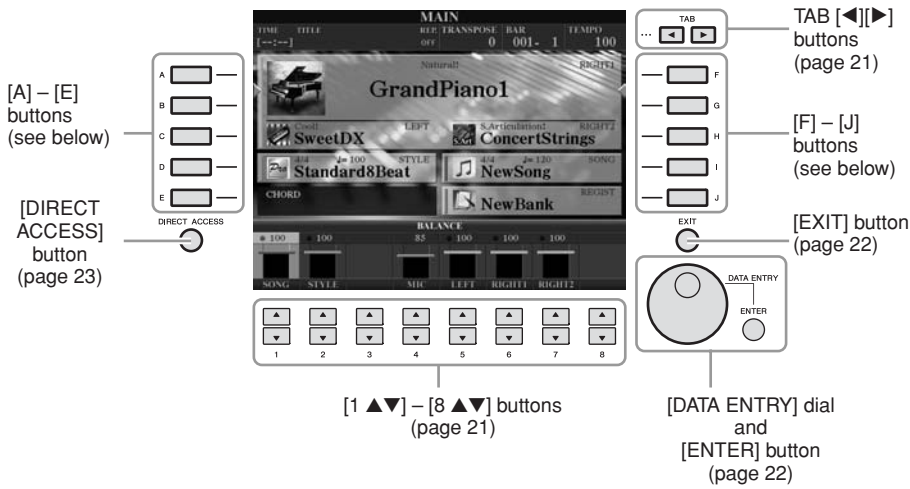

[A] – [J] buttons

The [A] – [J] buttons are used to select the corresponding menu.

• Example 1



In the File Selection display (page 26), the [A] – [J] buttons can be used to select the corresponding respective files.

• Example 2



TAB [◀][▶] buttons

These buttons are used mainly to change the Pages of displays that have “tabs” at the top.



[1 ▲▼] – [8 ▲▼] buttons

The [1 ▲▼] – [8 ▲▼] buttons are used to make selections or adjust settings (up or down correspondingly) for functions shown directly above them.



If a menu appears in this section of the display, use the [1 ▲] – [8 ▲] buttons.

If a menu appears in this section of the display, use the [1 ▼] – [8 ▼] buttons.

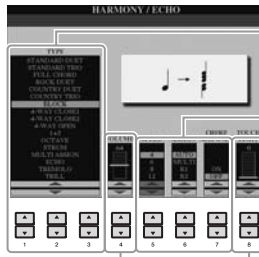

If list of the menu appears, use the [1 ▲▼] – [8 ▲▼] button to select the desired item.

If a parameter appears in slider (or knob) form, use the [1 ▲▼] – [8 ▲▼] button to adjust the value.

[DATA ENTRY] dial and [ENTER] button

Depending on the selected LCD display, the [DATA ENTRY] dial can be used in the following two ways.

• Selecting files (Voice, Style, Song, and so on)

When one of the File Selection displays (page 26) is shown, you can use the [DATA ENTRY] dial and the [ENTER] button to select a file (Voice, Style, Song, and so on).

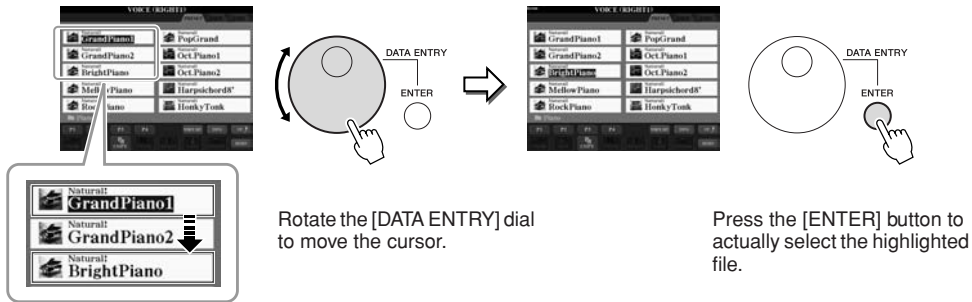

• Adjusting the parameter values

You can conveniently use the [DATA ENTRY] dial in tandem with the [1 ▲▼] – [8 ▲▼] buttons to adjust parameters indicated in the display.

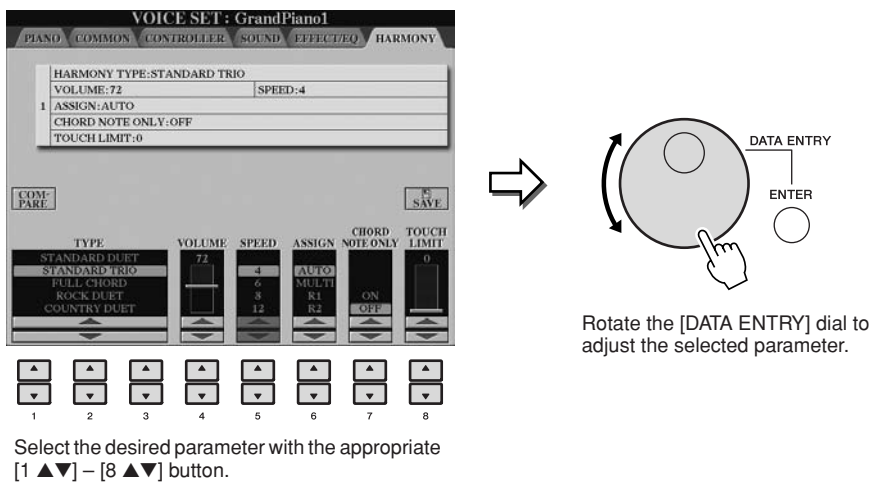

This convenient technique also works well with pop-up parameters such as Tempo and Transpose. Simply press the appropriate button (ex., TEMPO [+]), then rotate the [DATA ENTRY] dial and press [ENTER] to close the window.

[EXIT] button

Pressing the [EXIT] button returns you to the previously indicated display.

Pressing the [EXIT] button several times returns to the default Main display (page 24).



The Messages Shown in the Display

A message (information or confirmation dialog) sometimes appears on the screen to facilitate operation. When the message appears, simply press the appropriate button.



Instant Selection of the Displays — Direct Access

With the convenient Direct Access function, you can instantly call up the desired display — with just a single additional button press.

1 Press the [DIRECT ACCESS] button.

A message appears in the display prompting you to press the appropriate button.

2 Press the button or pedal corresponding to the desired setting display to instantly call up that display.

For example, pressing the [GUIDE] button calls up the display in which the Guide mode can be set.

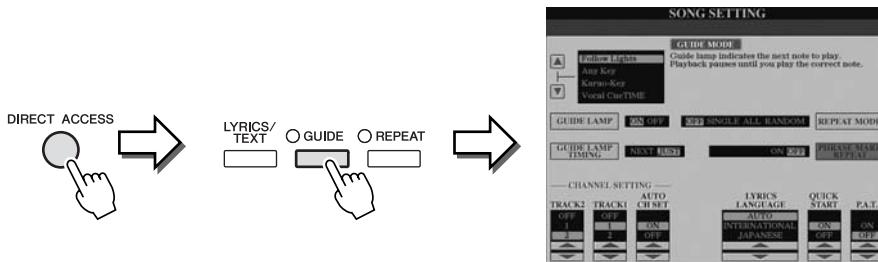

Refer to the separate Data List for a list of the displays that can be called up with the Direct Access function.

Main Display Configuration

The display that appears when the power is turned on is the Main display. The Main display shows the current basic settings such as the currently selected Voice and Style, allowing you to see them at a single glance. The Main display is the one you'll usually see when you play the keyboard.

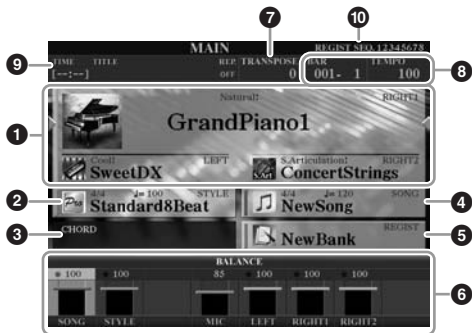

CVP-509/505/503

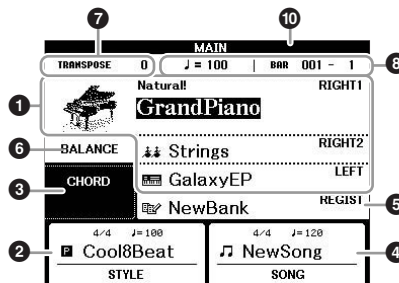

CVP-501

1 Voice name

Displays the Voice names currently selected for RIGHT 1, RIGHT 2 and LEFT parts (page 37). Pressing one of the [A] – [C] and [F] – [I] buttons calls up the Voice Selection display for each part.

2 Style name and related information

Displays the currently selected Style name, time signature and tempo. Pressing the [D] button (CVP-509/505/503) or one of the [1 ▲▼] – [4 ▲▼] buttons (CVP-501) calls up the Style Selection display (page 48).

3 Current chord name

When the [ACMP ON/OFF] button is set to on, the chord specified in the chord section of the keyboard will be displayed. When the Song containing the chord data is played, the current chord name will be displayed.

4 Song name and related information

Displays the currently selected Song name, time signature and tempo. Pressing the [I] button (CVP-509/505/503) or one of the [5 ▲▼] – [8 ▲▼] buttons (CVP-501) calls up the Song Selection display (page 59).

5 Registration Memory Bank name

Displays the currently selected Registration Memory Bank name and Registration Memory number (CVP-509/505/503). Pressing the [J] button calls up the Registration Memory Bank Selection display (page 80).

6 Volume Balance

Displays the volume balance among the parts. When you use the CVP- 501, pressing the [C] button calls up the volume balance display. Adjust the volume balance among the parts by using the [1 ▲▼] – [7 ▲▼] buttons.

7 Transpose

Displays the amount of transposition in semitone units (page 42).

NOTE

The corresponding button for each Voice part differs depending on your instrument.

NOTE

When the Left Hold function (page 45) is ON, an "H" indication appear

NOTE

If the Volume Balance display is not shown, press the [EXIT] button to show the Volume Balance display.

8 TEMPO/BAR/BEAT

Displays the current position (tempo/bar/beat) in Style playback or Song playback.

9 USB Audio information (CVP-509/505/503)

Displays information for the selected audio file (file name, time, etc.) While recording, a “REC” indication appears.

10 Registration Sequence

Appears when the Registration Sequence (page 82) is active.

NOTE

For detailed information about the Registration Sequence, refer to the Reference manual on the website.

File Selection Display Configuration

The File Selection display is for selecting Voice, Styles, and other data. The File Selection display appears when you press one of the VOICE or STYLE category selection buttons, SONG [SELECT] button, etc.



1 Location (drive) of data

- PRESET** Location where pre-programmed (preset) data is stored.
- USER** Location where recorded or edited data is saved.
- USB** Location where data on USB storage device (USB flash memory, floppy disk, etc.) is saved. This appears only when USB storage device(s) is connected to the [USB TO DEVICE] terminal (page 106).

2 Selectable data (files)

The files that can be selected on this display are shown. If more than 10 files exist, the page numbers (P1, P2 ...) are shown below the files. Pressing the corresponding button changes the display page. When other pages follow, the "Next" button appears, and for the previous page, the "Prev." button appears.

3 File/folder operation menu

You can save and manage your data files (copy, move, delete, etc.) from this menu. For detailed instructions, refer to pages 68 – 71.

NOTE

Hereafter in this manual, any USB storage device such as USB flash memory, floppy disk drive, etc. will be referred to as "USB storage device."

NOTE

The data, both pre-programmed and your own original, are saved as "files."

NOTE

You can open the File Selection display for a specified file from the [USB] button. [USB] → [A] SONG/[B] STYLE/[C] REGIST/[F] VOICE.

Closing the current folder and calling up the next highest level folder

In the PRESET display, several data (files) are contained together in a folder. You can also organize your original data in the USER/USB display by creating several new folders (page 69).

To close the current folder and call up the next highest level folder, press the [8 ▲] (UP) button.

Example of the PRESET Voice Selection display

The PRESET Voice files are categorized and contained in appropriate folders.

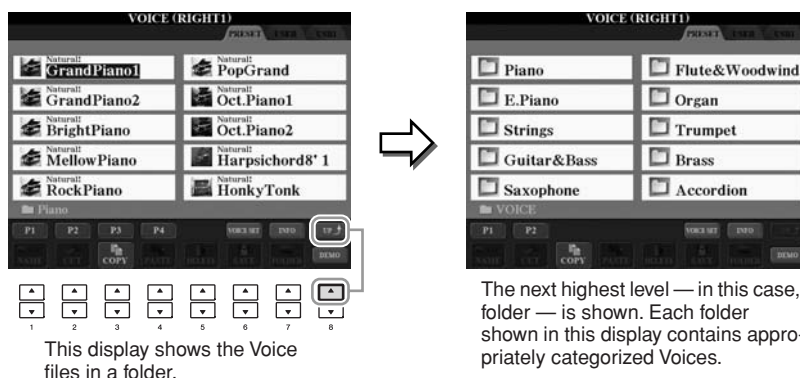

Entering Characters

The instructions that follow show you how to enter characters for naming your files/folders, inputting keywords, etc. Entering characters should be done in the display shown below.

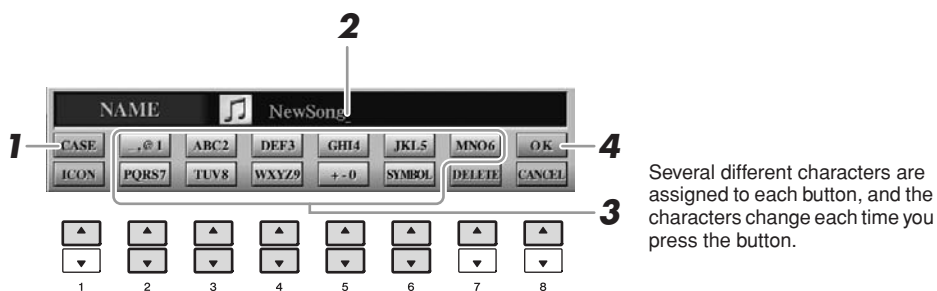

1 Change the type of character by pressing the [1 ▲] button.

If you select a language other than Japanese as the Language (page 17), the following different types of characters are available:

- **CASE** capital letters, numbers, marks
- **case** lowercase letters, numbers, marks

If you select Japanese as the Language (page 17), the following different types of characters and sizes can be entered:

NOTE

Depending on the display for character entry you are working in, some types of characters cannot be entered."

- **かな漢 (kana-kan)** Hiragana and Kanji, marks (full size)
- **カナ (kana)** Katakana (normal size), marks (full size)
- **か (kana)** Katakana (half size), marks (half size)
- **A B C** Alphabet (capital and small letters, full size), numbers (full size), marks (full size)
- **ABC** Alphabet (capital and small letters, half size), numbers (half size), marks (half size)

2 Use the [DATA ENTRY] dial to move the cursor to the desired position.

3 Press the [2 ▲▼] – [6 ▲▼] and [7 ▲] buttons, corresponding to the character you wish to enter.

To actually enter the selected character, move the cursor or press another letter-input button. Alternately, you can wait for a short time and the characters will be entered automatically.

For details on entering characters, refer to “Other character-entry operations” below.

4 Press the [8 ▲] (OK) button to actually enter the new name and return to the previous display.

Other character-entry operations

• Deleting characters

Move the cursor to the character you wish to delete by using the [DATA ENTRY] dial, and press the [7 ▼] (DELETE) button. To delete all characters on the line at once, press and hold the [7 ▼] (DELETE) button.

• Entering special character marks (Japanese “<濁点>” and “<半濁点>”)

Select a character to which a character mark is to be added and press the [6 ▼] button before actual entry of the character.

• Entering marks or space

1. Press the [6 ▼] (SYMBOL) button to call up the mark list.
2. Use the [DATA ENTRY] dial to move the cursor to the desired mark or space, then press the [8 ▲] (OK) button.

• Converting into Kanji (Japanese language)

When the entered “hiragana” characters are shown in reverse display (highlighted), press the [1 ▲]/[ENTER] button one or several times to convert the characters into the appropriate kanji. You can change the reversed area by using the [DATA ENTRY] dial. To actually enter the change, press the [1 ▼]/[8 ▲] (OK) button.

To change the converted kanji back to “hiragana,” press the [7 ▼] (DELETE) button. To clear the reversed area at once, press the [8 ▼] (CANCEL) button.

• Selecting custom icons for files (shown at left of file name)

1. Press the [1 ▼] (ICON) button to call up the ICON SELECT display.
2. Select the icon by using the [A] – [J] buttons, [3 ▲▼] – [5 ▲▼] buttons or [DATA ENTRY] dial. The ICON display includes several pages. Press the TAB [◀][▶] buttons to select different pages.
3. Press the [8 ▲] (OK) button to apply the selected icon.

NOTE

Even if you select Japanese as the Language, when you enter the characters in the lyrics editing display, the Internet Setting display, or website, the type of characters “CASE”/“case” may be entered.

NOTE

When entering a password for a website or the WEP key for wireless LAN connection, the characters are converted to asterisks (*) for security purposes.

NOTE

To cancel the character-entering operation, press the [8 ▼] (CANCEL) button.

NOTE

The file name can contain up to 41 characters and the folder name can contain up to 50 characters.

NOTE

In the case of characters which are not accompanied by special character marks (with the exception of kanakan and half-size katakana), you can call up the mark list by pressing the [6 ▼] button after selecting a character (before actual entry of a character).

NOTE

To cancel the operation, press the [8 ▼] (CANCEL) button.

Restoring the Factory-programmed Settings

While holding the C7 key (right-most key on the keyboard), turn the power on. This restores the all settings (except Internet Settings, etc.) to the factory default.

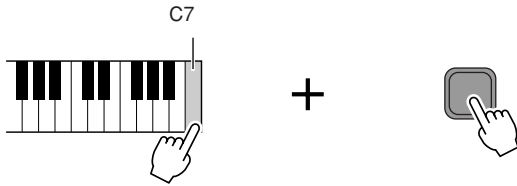

You can also restore a specified setting to the factory default value, or save/load your own reset settings. Call up the operation display: [FUNCTION] → [J] UTILITY → TAB [◀][▶] SYSTEM RESET. For details, refer to the Reference Manual on the website.

Data Backup

This procedure backs up all data stored in USER drive (except Protected Songs) and all settings including Internet Direct Connection settings.

For maximum data security Yamaha recommends that you copy or save your important data to a USB storage device. This provides a convenient backup if the internal memory is damaged.

1 Insert/connect the backup USB storage device (destination).

2 Call up the operation display.

[FUNCTION] → [J] UTILITY → TAB [◀][▶] OWNER



3 Press the [D] (BACKUP) button to save the data to the USB storage device.

To restore the data, press the [E] (RESTORE) button in this display. When the operation is complete, the instrument will be restarted automatically.

NOTE

If you want to initialize only the Registration Memory setting (page 79), turn the power on while holding the B6 key.

NOTE

To reset the Internet Settings, call up the operation display: [INTERNET] → [5 ▼] SETTING → [A] NETWORK SETTINGS → [E] INITIALIZE SET UP.

NOTE

Before using a USB storage device, be sure to read "Connecting a USB Storage Device" on page 106.

NOTE

Completing the backup/restore operation may take a few minutes.

CAUTION

Move the Protected Songs which are saved to the USER display before restoring. If the Songs are not moved, the operation deletes the data.

NOTE

To save the Song, Style, Registration Memory Bank and Voice independently, execute the Copy and Paste operation from the File Selection display (page 70).

NOTE

To save the Music Finder Record, Effect, MIDI Template and System File, call up the operation display: [FUNCTION] → [J] UTILITY → TAB [◀][▶] SYSTEM RESET. For more information, refer to the Reference Manual on the website.

Perform the piano songs by Clavinova

Here, we'll call up and play the piano voice. You can play the piano voice using the pedals or metronome.

1

One-touch Piano Play

This convenient, easy-to-use feature completely and automatically reconfigures the entire instrument for optimum piano performance. No matter what settings you've made from the panel, you can instantly call up the piano settings by a single button press.

Press the piano-shaped [PIANO RESET] button.

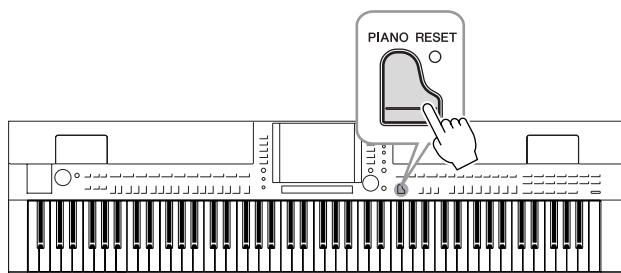

Piano Lock Function

The convenient Piano Lock function lets you “lock” the piano so that you don’t inadvertently change the settings by pressing another button on the panel. Once locked, the instrument stays in the piano mode, even if other buttons are pressed — preventing you from accidentally playing other sound during your piano performance.

1 Press and hold down the [PIANO RESET] button for three seconds or longer.

A message appears prompting you to enable Piano Lock.

2 Press the [F] (OK) button to enable Piano Lock.

To turn Piano Lock off, press and hold down the [PIANO RESET] button again for three seconds or longer.

Setting the touch sensitivity of the keyboard

You can adjust the touch response of the instrument (how the sound responds to the way you play the keys). This setting does not change the weight of the keyboard. The touch sensitivity type becomes the common setting for all Voices.

1 Call up the operation display.

[FUNCTION] → [D] CONTROLLER → TAB [◀][▶] KEYBOARD/PANEL
→ [A] 1 INITIAL TOUCH

2 Use the [1 ▲▼]/[2 ▲▼] buttons to specify the touch response.

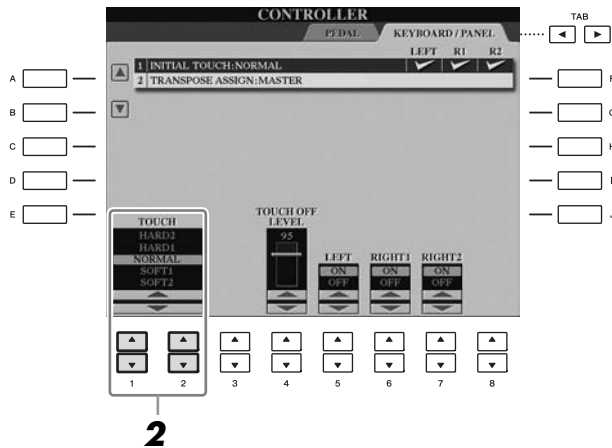

- **HARD 2**.....Requires strong playing to produce high volume. Best for players with a heavy touch.
- **HARD 1**.....Requires moderately strong playing for high volume.
- **NORMAL** Standard touch response.
- **SOFT 1** Produces high volume with moderate playing strength.
- **SOFT 2** Produces relatively high volume even with light playing strength. Best for players with a light touch.

NOTE

When you do not want to apply touch sensitivity, set Touch to OFF for the corresponding parts by using the [5 ▼]– [7 ▼] buttons. When Touch is set to OFF, you can specify the fixed volume level by using the [4 ▲▼] buttons.

NOTE

The touch sensitivity settings may have no effect with certain Voices.

Using the Pedals

The instrument features three pedals.

CVP-509/505

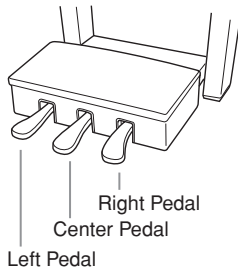

CVP-503/501

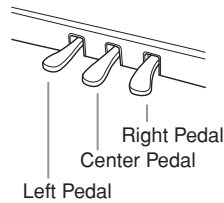

• Right Pedal (Damper Pedal)

This pedal performs the same function as the damper pedal on an actual acoustic piano, letting you sustain the sound of the Voices even after releasing the keys. The right pedal can be used to control the half pedal effect.

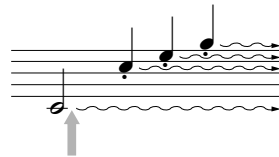
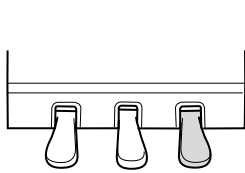

When you press the right pedal here, the notes you play before you release the pedal have a longer sustain.

• Center Pedal (Sostenuto Pedal)

When the Piano Voice is selected, if you play a note or chord on the keyboard and press this pedal while holding the note(s), the notes will sustain as long as the pedal is held. All subsequent notes will not sustain. When a Voice other than piano is selected, a specific function appropriate for the Voice is automatically assigned to the center pedal.

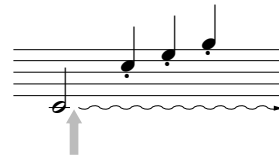
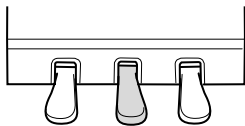

When you press the center pedal here while holding the note(s), the notes will sustain as long as you hold the pedal.

• Left Pedal

When the Piano Voice is selected, pressing this pedal reduces the volume and slightly changes the timbre of the notes you play. When a Voice other than piano is selected, a specific function appropriate for the Voice is automatically assigned to the center pedal.

Making Settings for the Pedals

You can assign one of the various functions to the three pedals or an optional foot controller/footswitch, doing things like controlling the Super Articulation Voices or starting and stopping the Song (page 105).

Even when you assign a certain function to a pedal, pressing the [PIANO RESET] button restores the pedal function to the default settings above.

NOTE

Half-pedal: While playing the piano with Sustain and you want to slightly mute the sustained sound, release the pedal from maximum position to half position.

NOTE

Certain Voices, such as [STRINGS] or [BRASS], sustain continuously when the right/center pedal is pressed.

NOTE

Certain Voices such as drum kits may not be affected by use of the right/center pedal.

NOTE

You can adjust the depth of the left pedal effect.
Voice Selection display → [6 ▲]
VOICE SET → TAB [◀|▶] CONTROLLER → [A]/[B] LEFT PEDAL
For details, refer to the Reference Manual on the website.

Using the Metronome

The metronome provides a click sound, giving you an accurate tempo guide when you practice, or letting you hear and check how a specific tempo sounds. Press the [METRONOME ON/OFF] button to start/stop the metronome.

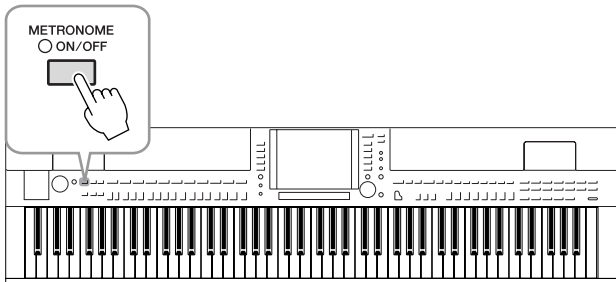

Adjusting the Metronome Tempo

- 1 Press the TEMPO [-]/[+] button to call up the pop-up tempo setting display.

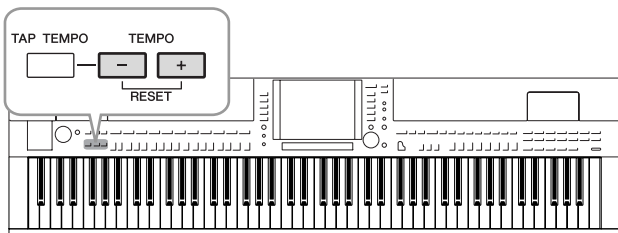

- 2 Use the TEMPO [-]/[+] buttons to set the tempo.

Pressing and holding either button lets you continuously increase or decrease the value.

You can also use the [DATA ENTRY] dial to adjust the value.

To reset the tempo, press the TEMPO [-]/[+] buttons simultaneously.

- 3 Press the [EXIT] button to close the Tempo display.

NOTE

The number in the display indicates how many quarter-note beats there are in one minute.

NOTE

You can also change the time signature and volume of the metronome sound:

[FUNCTION] → [J] UTILITY → TAB [◀|▶] CONFIG 1 → [B] 2 METRONOME

For details, refer to the Reference Manual on the website.

Enhancing the Acoustic Realism of the Sound (iAFC)

CVP-509 CVP-505 CVP-503 CVP-501

When iAFC is engaged, the instrument will sound deeper and more resonant, similar to an acoustic musical instrument. This lets you experience the ambience and reverberation that are characteristic of performing on stage or simulates the sustain sound that occur when you press the damper pedal of a grand piano.

1 Call up the operation display.

[FUNCTION] → [H] iAFC SETTING

2 Press the [D] button to turn the iAFC on.

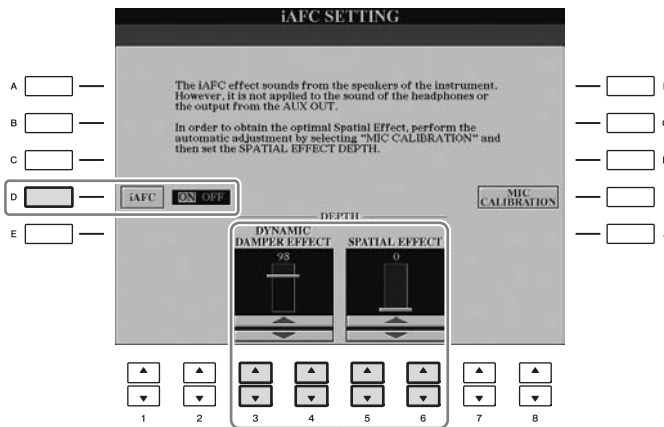

3 Use the [3 ▲▼] – [6 ▲▼] buttons to adjust the iAFC effect depth.

<p>[3 ▲▼]/ [4 ▲▼]</p>	<p>DYNAMIC DAMPER EFFECT</p>	<p>This simulates the sustain sound that occurs when you press the damper pedal of a grand piano. The microphone is not used, but the sound produced within the instrument is processed to create a spacious sensation.</p>
<p>[5 ▲▼]/ [6 ▲▼]</p>	<p>SPATIAL EFFECT</p>	<p>Spatial Effect creates a sense of reverberation and spaciousness by picking up the output sound using internal microphones and output the sound from the speaker on the rear of the instrument. The spread and spaciousness of the sound is different depending on the depth. The default setting for the depth is 0. For lower depth settings: This creates the resonance and enhances the acoustic realism of the sound that is characteristic of acoustic instruments by creating a virtual soundboard. For deeper depth settings: The sound of the instrument itself and the sound of singing and other instruments played nearby is picked up by internal microphones, and processed to simulate the spatial characteristics of performing together on stage.</p>

⚠ CAUTION

When using iAFC, do not block or cover the speaker located on the rear panel of the instrument. The optimal iAFC effect cannot be obtained if this speaker is blocked.

NOTE

iAFC uses Yamaha's EMR (Electronic Microphone Rotator) technology to ensure stability against acoustic feedback.

1

Perform the piano songs by Clavinova

4 If you've set the depth of SPATIAL EFFECT to a value other than 0, press the [I] (MIC CALIBRATION) button to call up the calibration display.

The MIC CALIBRATION display appears. In this display, you can adjust the sensitivity and response of iAFC so that the optimal iAFC effect will be obtained.

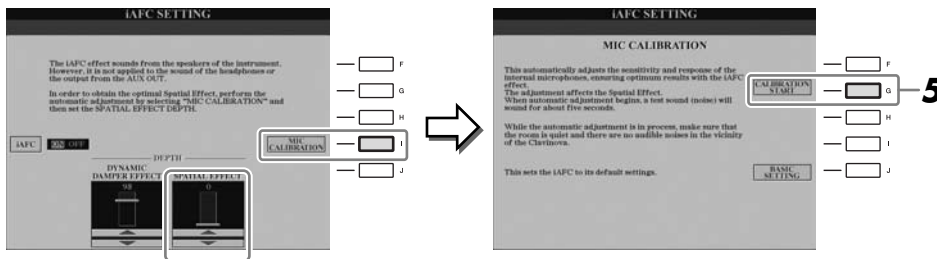

5 Press the [G] (CALIBRATION START) button to begin calibration.

When automatic adjust begins, a test sound (noise) will sound for about five seconds. While automatic adjustment is being performed, do not make audible noises in the vicinity of the Clavinova.

NOTE

If you are using headphones, disconnect the headphones before adjusting iAFC calibration.

NOTE

If desired, you can restore the default calibration setting by pressing the [J] (BASIC SETTING) button in step 4.

Maintenance

To keep your Clavinova in optimum condition, we recommend that you periodically follow the maintenance points below.

■ Instrument and Bench Maintenance

- When cleaning the instrument, use a soft, dry or slightly damp cloth.

⚠ CAUTION

Do not use paint thinners, solvents, cleaning fluids, or chemical-impregnated wiping cloths.

If you are using a model with a polished finish, gently remove dust and dirt with a soft cloth. Do not wipe too hard since small particles of dirt can scratch the instrument's finish.

To keep the surface polished, apply commercially available piano polisher to a soft cloth and wipe the instrument's surface with it. Then, polish it with a separate cloth. Before using any piano polisher, make sure to read the instructions for proper usage.

- Tighten the screws of the instrument and bench periodically.

■ Bench Height Adjustment

The bench height can be adjusted by rotating the handle. Rotating clockwise heightens the bench. (Before shipment, the handle is firmly fastened.)

■ Pedal Cleaning

As with an acoustic piano, pedals may become tarnished across the ages. When this occurs, polish the pedal with a compound designed for piano pedals. Before using the compound, make sure to read the instructions for proper usage.

⚠ CAUTION

Do not use paint thinners, solvents, cleaning fluids, or chemical-impregnated wiping cloths. Otherwise, the pedal may become discolored or degraded.

■ Tuning

Unlike an acoustic piano, the instrument does not need to be tuned. It always stays perfectly in tune.

■ Transporting

If you move to another location, you can transport the instrument along with other belongings. You can move the unit as it is (assembled) or you can disassemble the unit down to the condition it was in when you first took it out of the box. Transport the keyboard horizontally. Do not lean it up against a wall or stand it up on its side. Do not subject the instrument to excessive vibration or shock.

When transporting the assembled instrument, make sure all screws are properly tightened and have not been loosened by moving the instrument.

(CVP-509) After transporting the instrument, do the following to ensure optimum performance of the iAFC function (page 34).

- Place the Clavinova so that its rear panel is at least 10 cm away from the wall.
- (When using the SPATIAL EFFECT) Perform the automatic adjustment of the iAFC function.

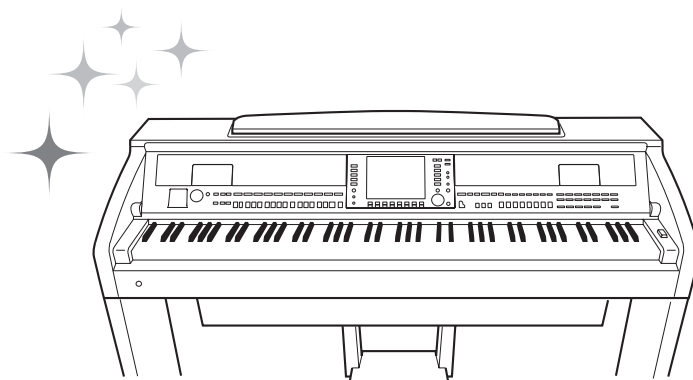

Voices

– Playing the keyboard –

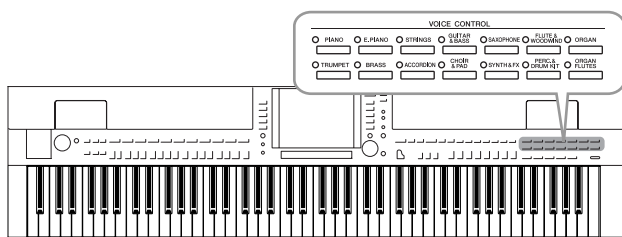

The instrument features a wide variety of exceptionally realistic instrumental Voices, including piano, guitar, strings, brass, wind instruments and more.

Playing Preset Voices

Selecting a Voice (RIGHT 1) and playing the keyboard

- 1 Press one of the [A]/[B]/[F]/[G] (RIGHT 1) buttons on the Main display.

Make sure that the PART ON/OFF [RIGHT1] button is also turned on. If it is turned off, the right-hand part will not sound.



- 2 Press one of the VOICE category selection buttons to select a Voice category and call up the Voice Selection display.

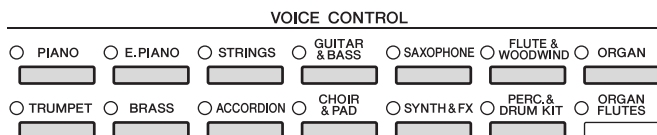

The preset Voices are categorized and contained in appropriate folders. Voice category selection buttons on the panel correspond to the categories of the preset Voices. For example, press the [STRINGS] button to display various strings Voices.

NOTE

For the Voice part, see page 39.

NOTE

For more information on the VOICE category selection buttons, refer to page 40.

3 Press one of the [A] – [J] buttons to select the desired Voice.

To call up the other display pages, press one of the [1 ▲] – [5 ▲] buttons or press the same VOICE button again.



To listen to the demo phrases for each Voice

Press the [8 ▼] (DEMO) button to start the Demo for the selected Voice. To stop the demo, press the [8 ▼] button again.

4 Play the keyboard.

Playing Two Voices Simultaneously

1 Make sure that PART ON/OFF [RIGHT 1] button is turned on.

2 Press the PART ON/OFF [RIGHT 2] button to turn it on.

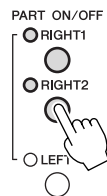

3 Press one of the VOICE category selection buttons to call up the Voice Selection display for the Right 2 part.

4 Press one of the [A] – [J] buttons to select the desired Voice.

5 Play the keyboard.

The Voice selected for RIGHT 1 (page 37) and the Voice selected here are sounded simultaneously in a layer.

Quickly selecting Voices for Right 1 and 2 parts

You can quickly select the Right 1 and 2 part Voices, just from the Voice category selection buttons. Press and hold one Voice button, then press another. The Voice of the first pressed button is automatically set for the Right 1 part, while the Voice of the second pressed button is set for the Right 2 part.

NOTE

(CVP-509/505) You can call up the information for the selected Voice by pressing the [7 ▲] (INFO) button. (Some Voices do not have the information display.) To close the information display, press the [EXIT] button.

NOTE

The Voice type and its defining characteristics are indicated above the Preset Voice name. For details on the characteristics, see page 40 and the Reference Manual.

NOTE

You can save the settings to Registration Memory. See page 79.

Playing Different Voices with the Left and Right Hands

- 1 Make sure that the PART ON/OFF [RIGHT 1] and/or [RIGHT 2] buttons are turned on.
- 2 Press the PART ON/OFF [LEFT] button to turn it on.

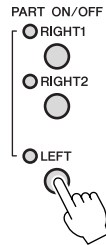

- 3 Press one of the VOICE category selection buttons to call up the Voice Selection display for the Left part.
- 4 Press one of the [A] – [J] buttons to select the desired Voice.
- 5 Play the keyboard.

The notes you play with your left hand sound one Voice (LEFT Voice selected above), while the notes you play with your right sound a different Voices (RIGHT 1 and 2 Voices).



Keyboard Parts

Voices can be assigned independently to each of the three keyboard parts: Right 1, Right 2 and Left. You can combine these parts by using the PART ON/OFF buttons to create a rich, ensemble sound.

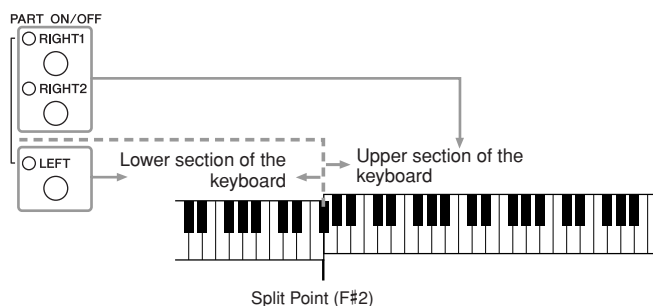

When the LEFT part is off, the RIGHT 1 and 2 Voices can be played over the entire keyboard. When the LEFT part is on, keys lower than F#2 (the Split Point) are set for playing the LEFT part and those higher than the Split Point are set for playing the RIGHT 1 and 2 parts.

You can confirm the currently selected part on the Main display. (CVP-509/505) For the part selected, “◀” or “▶” is displayed next to the Voice name.

NOTE

You can save the settings to Registration Memory. See page 79.

NOTE

To change the Split Point, press: [FUNCTION] → [C] STYLE SETTING/ SPLIT POINT/CHORD FINGERING → TAB [◀][▶] SPLIT POINT. For more information, refer to the Reference Manual on the website.

Voice Types

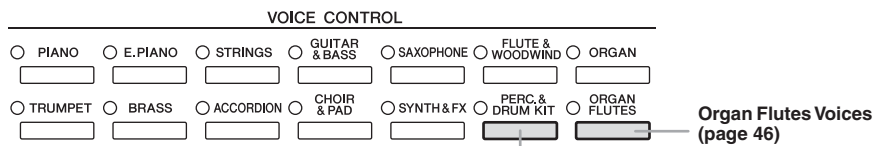

Percussion/Drum Voices

When one of the Voices is selected from this button, you can play various drums and percussion instruments or SFX (sound effects) sounds on the keyboard. Details are given in the Drum List of the separate Data List.

Organ Flutes Voices
(page 46)

• Voice Characteristics

The Voice type and its defining characteristics are indicated above the Voice name—Live!, Cool!, Sweet!, etc. For detailed explanation, refer to the Reference Manual.

In this section, only MegaVoice and Super Articulation Voices (SA and SA2) are explained. These Voices have special characteristics you should be aware of, and they require specific performance techniques to bring out all of their expressive qualities.

MegaVoices (CVP-509/505/503)

What makes MegaVoices special is their use of velocity switching. Each velocity range (the measure of your playing strength) has a completely different sound. For example, a guitar MegaVoice includes the sounds of various performance techniques. In conventional instruments, different Voices having those sounds would be called up via MIDI and played in combination to achieve the desired effect. However, now with MegaVoices, a convincing guitar part can be played with just a single Voice, using specific velocity values to play the desired sounds. Because of the complex nature of these Voices and the precise velocities need to play the sounds, they're not intended for playing from the keyboard. They are, however, very useful and convenient when creating MIDI data—especially when you want to avoid using several different Voices just for a single instrument part.

Super Articulation Voices (CVP-509/505)

The word “articulation” in music usually refers to the transition or continuity between notes. This is often reflected in specific performance techniques, such as staccato, legato and slur. Two types of Voices—Super Articulation (SA) Voices and Super Articulation 2 (SA2) Voices—enable you to create these subtle musical expressions, simply by how you play. (SA2 Voices are available only on the CVP-509.)

• SA Voices (S.Articulation!)

The SA Voices provide many of same benefits as the MegaVoices, but with greater playability and expressive control in real time.

For example, with the Saxophone Voice, if you play a C and then a D in a very legato way, you will hear the note change seamlessly, as though a saxophone player played it in a single breath. Similarly with the Concert Guitar Voice, the D note would sound as a “hammer on,” without the string being plucked again.

Depending on how you play, other effects such as shake or breath noises (for the Trumpet Voice), or finger noises (for the Guitar Voice) will be produced.

NOTE

MegaVoices, SA and SA2 Voices are only compatible with other models which have those types of Voices installed. Any Song or Style data you've created on the instrument using these Voices will not sound properly when played back on other instruments.

NOTE

MegaVoices, SA and SA2 Voices sound differently depending on the keyboard range, velocity, touch, etc. Hence, if you apply HARMONY/ECHO effect, change the transpose setting or change the Voice Set parameters, unexpected or undesired sounds may result.

• **SA2 Voices (S. Articulation2!) (CVP-509)**

Mainly for wind instrument Voices, a special Yamaha technology called AEM has been used, which features detailed samples of special expressive techniques used on those specific instruments—to bend or slide into notes, to “join” different notes together, or to add expressive nuances at the end of a note, etc.

You can add these articulations by playing legato or staccato, or by jumping in pitch by around an octave. For example, using the Clarinet Voice, if you hold a C note and play the B♭ above, you’ll hear a glissando up to the B♭. Some “note off” effects are also produced automatically when you hold a note for over a certain time.

You can also use the pedals to add articulations to the SA and SA2 Voices (page 43). For details on how to best play each SA and SA2 Voice, call up the information window (pressing the [7 ▲] (INFO) button in the Voice Selection display).

AEM Technology

When you play the piano, pressing a “C” key produces a definite and relatively fixed C note. When you play a wind instrument, however, a single fingering may produce several different sounds depending on the breath strength, the note length, the adding of trills or bend effects, and other performance techniques. Also, when playing two notes continuously—for example “C” and “D”—these two notes will be smoothly joined, and not sound independent as they would on a piano.

AEM (Articulation Element Modeling) is the technology for simulating this characteristic of instruments. During performance, the most appropriate sound samples are selected in sequence in real time, from huge quantities of sampled data. They are smoothly joined and sounded—as would naturally occur on an actual acoustic instrument.

This technology to smoothly join different samples enables the application of realistic vibrato. Conventionally on electronic musical instruments, vibrato is applied by moving the pitch periodically. AEM technology goes much further by analyzing and disaggregating the sampled vibrato waves, and smoothly joins the disaggregated data in real time during your performance.

NOTE

The characteristics of SA2 Voices (default vibrato setting and articulation effects applied by the pedals) are effective for real-time performance; however, these effects may not be completely reproduced when you play back a Song which has been recorded using SA2 Voices.

Transposing the Pitch of the Keyboard

The TRANSPOSE [-]/[+] buttons transpose the overall pitch of the instrument (the keyboard sound, Style playback, Song playback, and so on) in semitone steps. Press the [+] and [-] buttons simultaneously to instantly reset the transpose value to 0.

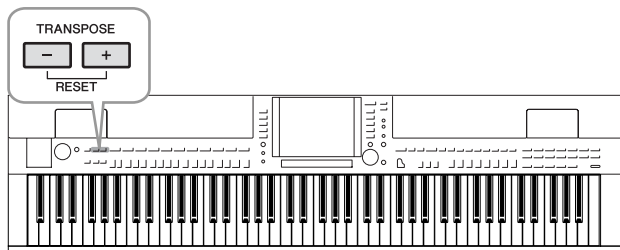

2

Voices – Playing the keyboard –

Default Pitch setting

By default, the reference pitch of the entire instrument is set to 440.0 Hz, and the scale to equal temperament. You can change the pitch and scale from [FUNCTION] → [A] MASTER TUNE/SCALE TUNE.

You can also adjust the pitch for each part (keyboard parts, Style parts and Song parts) on the TUNE page of the Mixing Console display (page 88). For details, refer to the Reference Manual on the website.

NOTE

The Transpose functions do not affect the Drum Kit or SFX Kit Voices.

NOTE

You can also change the transpose settings in the MIXING CONSOLE display: [MIXING CONSOLE] → TAB [◀][▶] TUNE → [1 ▲▼] – [3 ▲▼] TRANSPOSE.

NOTE

Hz (Hertz): This unit of measurement refers to the frequency of a sound and represents the number of times a sound wave vibrates in a second.

Adding Articulation Effects to Super Articulation Voices

CVP-509 CVP-505 CVP-503 CVP-501

With the center/left pedals, you can add articulation effects and characteristic instrument performance sounds to your playing. When you select a SA or SA2 Voice, the function of center and left pedals are switched to control articulation effects.

Three examples of effects are introduced to the following. The applied articulation effect differs depending on the selected Voice. For details, refer to the Information display called up by pressing the [7 ▲] (INFO) button on the Voice Selection display.

- Pressing a pedal triggers different playing effects, separate from your keyboard playing. For example, pressing a pedal for a saxophone Voice can produce breath noises or key noises, while doing the same for a guitar Voice can produce fret noises or body-tapping sounds. You can effectively intersperse these into the notes as you play.

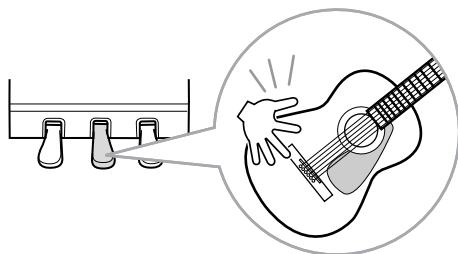

- Playing the keyboard while pressing a pedal changes the nature of Voice. For example, in the case of the nylon guitar Voice, pressing the corresponding pedal lets you play harmonics for the guitar Voice. Releasing the pedal returns the Voice to normal.
- When an SA2 Voice is selected (CVP-509), pressing a pedal and playing/releasing a note enables you to add articulation effects, such as bend up/down, glissando up/down, brass fall, etc.

NOTE

SA2 Voices are available only on the CVP-509. SA Voices are available only on the CVP-509/505.

NOTE

Pedal functions are automatically changed depending on the selected Voice. However, if you need to, you can lock the pedal function so that it does not change automatically. [FUNCTION] → [D] CONTROLLER → [H] DEPEND ON R1 VOICE.

NOTE

Keeping with the realistic response of the original instruments, the effects applied vary depending on the range you are playing in.

NOTE

When you select SA/SA2 Voices for two or more keyboard parts, pressing a pedal simultaneously affects all parts on which SA/SA2 Voices are selected.

Applying Voice Effects

The instrument features a sophisticated multi-processor effect system which can add extraordinary depth and expression to your sound.

- 1 Call up the operation display.**
[DIRECT ACCESS] → [EXIT]
- 2 Select the desired part for which you want to add effects.**

CVP-509/505/503



CVP-501



- 3 Press the [VOICE EFFECT] button to call up the VOICE EFFECT display.**

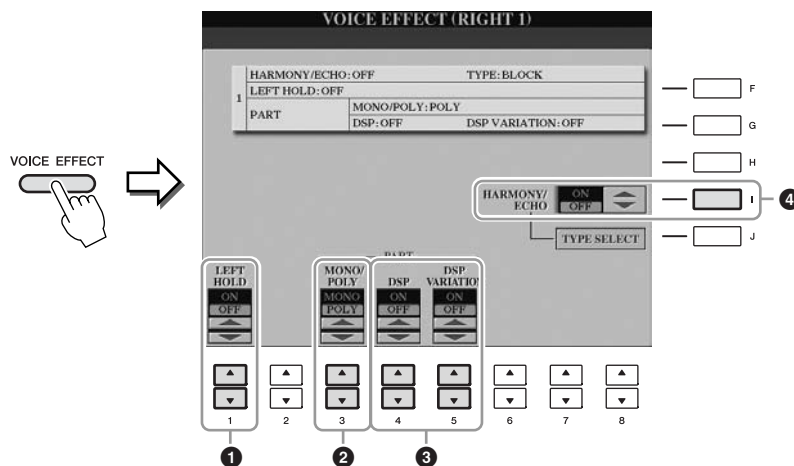

4 Use the [1 ▲▼], [3 ▲▼] – [5 ▲▼] and [I] buttons to apply effects to the Voices.

1	[1 ▲▼]	LEFT HOLD	<p>This function causes the LEFT part Voice to be held even when the keys are released. Non-decaying Voices such as strings are held continuously, while decay-type Voices such as piano decay more slowly (as if the sustain pedal has been pressed).</p> <p>When the Left Hold is ON, an “H” indication appears in the Main display.</p>
2	[3 ▲▼]	MONO/POLY	<p>This determines whether the part’s Voice is played monophonically (only one note at a time) or polyphonically. Using the MONO mode lets you play single, lead sounds (such as brass instruments) more realistically. It also lets you expressively control the Portamento effect (depending on the selected Voice) by playing legato.</p>
3	[4 ▲▼]/ [5 ▲▼]	DSP/DSP VARIATION	<p>With the digital effects built into the instrument, you can add ambience and depth to your music in a variety of ways—various effect types, such as chorus and delay are included.</p> <ul style="list-style-type: none"> • The DSP switch is used to turn the DSP (Digital Signal Processor) effect on or off for the currently selected keyboard part. • The DSP Variation switch is used to change between variations of the DSP effect. You could use this while you play, for example, to change the rotating speed (slow/fast) of the rotary speaker effect.
4	[I]	HARMONY/ ECHO	<p>When this is set to ON, the Harmony/Echo effects are applied to the right-hand Voices depending on the chord played with your left hand. For details, refer to the Reference Manual on the website.</p>

NOTE

Portamento is a function that creates a smooth transition in pitch from the first note played on the keyboard to the next.

NOTE

“DSP” stands for Digital Signal Processor (or Processing). DSP changes and enhances the audio signal in the digital realm to produce a wide range of effects.

NOTE

The effect type can be changed. On the Voice Selection display, select [6▲] (VOICE SET) → TAB [◀][▶] EFFECT/EQ → [A]/[B] 2 DSP.

NOTE

Depending on the harmony/echo type, harmony will be applied regardless of the chord played with your left hand.

Creating Your Original Organ Flutes Voices

The instrument uses advanced digital technology to recreate the legendary sound of vintage organs. Just as on a traditional organ, you can create your own sound by increasing and decreasing the levels of the flute footages.

1 Press the [ORGAN FLUTES] button.

The FOOTAGE Page of the Organ Flutes Voice is called up.

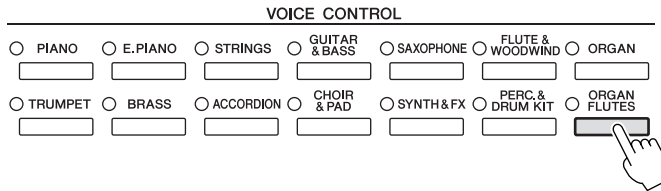

2 Use the [1 ▲▼] – [8 ▲▼] buttons to adjust the footage settings.

The footage settings determine the basic sound of the organ flutes.

The [1 ▲▼] buttons control two footages: 16' and 5 1/3'. Pressing the [D] button switches between these two footages.



If you want, you can select the Organ type, change the Rotary Speaker speed and adjust the Vibrato setting, by using the [A] – [C] and [F] – [H] buttons.

NOTE

The term "footage" is a reference to the sound generation of traditional pipe organs, in which the sound is produced by pipes of different lengths (in feet).

NOTE

About the VOLUME/ATTACK Page and EFFECT/EQ Page, see the Reference Manual on the website.

1	[A]/[B]	ORGAN TYPE	Specifies the type of organ tone generation to be simulated: Sine or Vintage.
2	[C]	ROTARY SP SPEED	Alternately switches between the slow and fast rotary speaker speeds when a rotary speaker effect is selected for the Organ Flutes (DSP TYPE parameter in the EFFECT/EQ Page), and the DSP is turned on (page 44).
3	[F]	VIBRATO OFF	Alternately turns the vibrato effect for the Organ Flutes Voice ON or OFF.
	[G]	VIBRATO ON	
4	[H]	VIBRATO DEPTH	Sets the Vibrato depth to one of three levels: 1 (low), 2 (mid), or 3 (high).
5	[I]	PRESETS	Opens the File Selection display of the Organ Flute Voices for selecting a preset Organ Flutes Voice.

- 3** Press the [I] (PRESETS) button to call up the Organ Flutes Voice Selection display.
- 4** Use the TAB [◀][▶] buttons to select the location to which your Organ Flutes Voice will be saved.
- 5** Press the [6 ▼] (SAVE) button to call up the Save display.
- 6** Save your Organ Flutes Voice by following the procedure on page 68.

⚠ CAUTION

The setting will be lost if you select another Voice or turn the power to the instrument off without executing the Save operation.

Advanced Features

Refer to the Reference Manual on the website, **Chapter 2**.



Selecting GM/XG or other Voices from the Panel:	Voice Selection display → [8 ▲](UP) → [2 ▲] (P2)
Selecting the Harmony/Echo type:	[VOICE EFFECT] → [J] TYPE SELECT
Pitch-related settings	
• Fine-tuning the pitch of the entire instrument:	[FUNCTION] → [A] MASTER TUNE/SCALE TUNE → TAB [◀][▶] MASTER TUNE
• Scale Tuning:	[FUNCTION] → [A] MASTER TUNE/SCALE TUNE → TAB [◀][▶] SCALE TUNE
• Changing the part assignment of the TRANSPOSE buttons:	[FUNCTION] → [D] CONTROLLER → TAB [◀][▶] KEYBOARD/PANEL → [A]/[B] 2 TRANSPOSE ASSIGN
Editing Voices (Voice Set):	Voice Selection display → [6 ▲] (VOICE SET)
Disabling automatic selection of Voice Sets (effects, etc.):	[FUNCTION] → [E] REGIST SEQUENCE/FREEZE/VOICE SET → TAB [◀][▶] VOICE SET
Editing Organ Flutes parameters:	[ORGAN FLUTES] → TAB [◀][▶] VOLUME/ATTACK or EFFECT/EQ

Styles

– Playing Rhythm and Accompaniment –

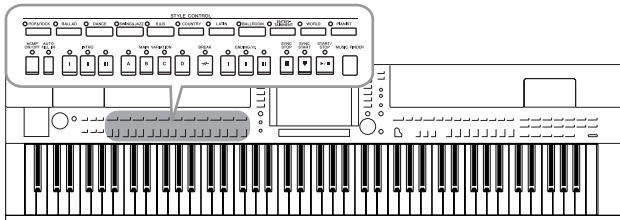

The instrument features a variety of accompaniment and rhythmic backing patterns (called “Styles”) in a variety of different musical genres including pop, jazz, and many others. The Style features Auto Accompaniment, letting you produce automatic accompaniment playback simply by playing “chords” with your left hand. This lets you automatically recreate the sound of a full band or orchestra—even if you’re playing by yourself.

3

Playing Only the Rhythm Channels of a Style

Rhythm is one of the most important parts of a Style. Try to play the melody along with just the rhythm. You can sound different rhythms for each Style. Keep in mind, however, that not all Styles contain rhythm channels.

- 1 Press one of the **STYLE** category selection buttons to call up the Style Selection display.



- 2 Press one of the [A] – [J] buttons to select the desired Style.

Pressing one of the [1▲] – [4▲] buttons or pressing the same STYLE button again can call up the other display page.



- 3 Confirm that the [ACMP ON/OFF] button is off.

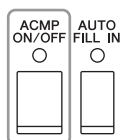

NOTE

The rhythm does not sound for some Styles. When you want to use any of these Styles, always make sure that [ACMP ON/OFF] is turned on.

- 4 Press the **STYLE CONTROL [START/STOP]** button to play back the rhythm channels.

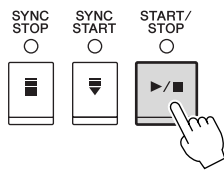

Try playing the keyboard along with the rhythm.
To stop the rhythm, press the **STYLE CONTROL [START/STOP]** button again.

Playing a Style with the Auto Accompaniment

- 1 Select a Style (steps 1 – 2 on page 48).
- 2 Press the **[ACMP ON/OFF]** button to turn on the Auto Accompaniment.

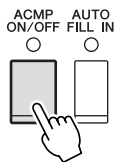

The specific left-hand section of the keyboard (page 39) becomes the Chord section, and chords played in this section are automatically detected and used as a basis for fully automatic accompaniment with the selected Style.

- 3 Press the **[SYNC START]** button to enable synchronized start.

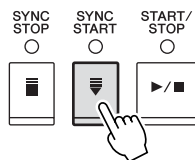

- 4 As soon as you play a chord with your left hand, the selected Style starts.
Try playing chords with your left hand and play melody with your right hand.
- 5 Press the **[START/STOP]** button to stop Style playback.

NOTE

For information on chords, see page 51.

NOTE

You can transpose the Style (accompaniment). See page 42.

Style Characteristics

The Style type and its defining characteristics are indicated on the Preset Style icon.



- **Pro (P):** These Styles provide professional and exciting arrangements combined with perfect playability. The resulting accompaniment exactly follows the chords of the player. As a result, your chord changes and colorful harmonies are instantly transformed into lifelike musical accompaniment.
- **Session (S):** These Styles provide even greater realism and authentic backing by mixing in original chord types and changes, as well as special riffs with chord changes, with the Main sections. These have been programmed to add “spice” and a professional touch to your performances of certain songs and in certain genres. Keep in mind, however, that the Styles may not necessarily be appropriate—or even harmonically correct—for all songs and for all chord playing. In some cases for example, playing a simple major triad for a country song may result in a “jazzy” seventh chord, or playing an on-bass chord may result in inappropriate or unexpected accompaniment.
- **Free Play (F) (CVP-509/505):** These Styles are characterized by rubato performance. You can perform freely with remarkably expressive accompaniment, without being constrained by a strict tempo.
- **Pianist (P):** These special Styles provide piano-only accompaniment. Just by playing the proper chords with your left hand, you can automatically add complicated, professional-sounding arpeggios and bass/chord patterns.











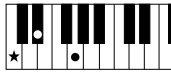
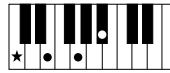
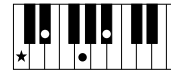
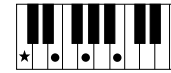

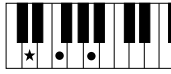
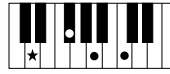



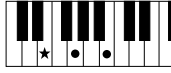
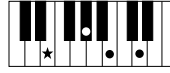











Style file compatibility

The CVP-509/505/503/501 uses the SFF GE file format (page 9). The CVP-509/505/503/501 can play back existing SFF files, but they will be saved in the SFF GE format when the file is saved (or pasted) in the CVP-509/505/503/501. Please keep in mind that the saved file can only be played back on instruments that are compatible with the SFF GE format.

Chords

For users who are unfamiliar with chords, this handy chart features common chords for your quick reference. Since there are many useful chords and many different ways to use them musically, refer to commercially available chord books for further details.

★ Indicates the root note.

Major	Minor	Seventh	Minor Seventh	Major Seventh
C 	Cm 	C7 	Cm7 	CM7 
D 	Dm 	D7 	Dm7 	DM7 
E 	Em 	E7 	Em7 	EM7 
F 	Fm 	F7 	Fm7 	FM7 
G 	Gm 	G7 	Gm7 	GM7 
A 	Am 	A7 	Am7 	AM7 
B 	Bm 	B7 	Bm7 	BM7 

Changing the Chord Fingering Type

By changing the chord fingering type, you can automatically produce appropriate accompaniment even if you don't press all of the notes which comprise a chord. Chord fingering type can be changed from: [FUNCTION] → [C] STYLE SETTING/SPLIT POINT/CHORD FINGERING → TAB [◀][▶] CHORD FINGERING.

Following types can be selected, for example.

• Single Finger

This method lets you easily play chords in the accompaniment range of the keyboard using only one, two or three fingers.

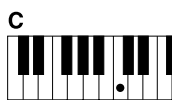

Major chord

Press the root key only.

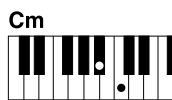

Minor chord

Simultaneously press the root key and a black key to its left.

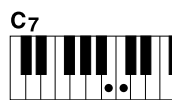

Seventh chord

Simultaneously press the root key and a white key to its left.



Minor seventh chord

Simultaneously press the root key and both a white and black key to its left.

• AI Full Keyboard

Playing just about anything, anywhere on the keyboard using both hands – like playing the piano – produces appropriate accompaniment. You don't have to worry about specifying the chords. (Depending on the song arrangement, AI Full Keyboard may not always produce appropriate accompaniment.)

For other types, refer to the Reference Manual on the website.

Operating Style Playback

To Start/Stop Playing

• [START/STOP] button

Style starts playing back as soon as the [START/STOP] button is pressed. To stop playback, press the button again.

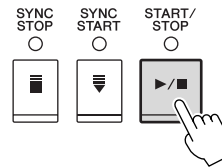

• [SYNC START] button

This puts the Style playback in “standby.” The Style starts playing back when you press any note on the keyboard (when [ACMP ON/OFF] is off) or you play a chord with your left hand (when [ACMP ON/OFF] is on). During the Style playback, pressing this button stops playing and puts the playback in “standby.”

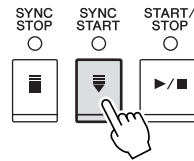

• [SYNC STOP] button

You can start and stop the Style anytime you want by simply playing or releasing the keys in the chord section of the keyboard. Make sure that the [ACMP ON/OFF] button is on, press the [SYNC STOP] button, then play the keyboard.

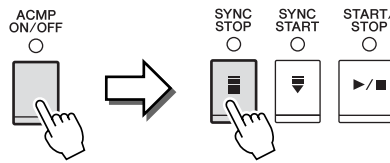

• INTRO [I] – [III] buttons

The instrument features three different Intro sections to add an introduction before starting the Style playback. After pressing one of the INTRO [I] – [III] buttons, start playback by using the [START/STOP] button or [SYNC START] button. When the Intro finishes playing, the Style playback automatically shifts to the Main section.

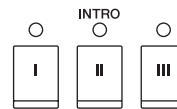

• ENDING/rit. [I] – [III] buttons

The instrument features three different Ending sections to add an ending before stopping Style playback. When you press one of the ENDING [I] – [III] buttons while Style is playing back, the Style will automatically stop after the ending is played. You can have the ending gradually slow down (ritardando) by pressing the same ENDING button once again, while the ending is playing.

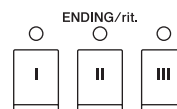

About the lamp status of the section buttons (INTRO/MAIN VARIATION/BREAK/ENDING)

- **Red:** The section is currently selected.
- **Red (flashing):** The section will be played next, following the currently selected section.
*The Main [A]-[D] buttons also flash red during fill-in playback.
- **Green:** The section contains data but not currently selected.
- **Off:** The section contains no data and cannot be played.

NOTE

When the fingering mode is set to “Full Keyboard” or “AI Full Keyboard,” Synchro Stop cannot be turned on.

To change the fingering mode:
[FUNCTION] → [C] STYLE SETTING/
SPLIT POINT/CHORD FINGERING →
TAB [◀][▶] CHORD FINGERING.

NOTE

If you press the ENDING/rit. [I] button when the Style is playing, a fill-in automatically plays before the ENDING/rit [I].

Changing Pattern Variation (Sections) During Style playback

Each Style features four different Main sections, four Fill-in sections and a Break section. By using these sections effectively, you can easily make your performance sound more dynamic and professional. The section can be freely changed while the Style is playing back.

• MAIN VARIATION [A] – [D] buttons

Press one of the MAIN VARIATION [A] – [D] buttons to select the desired Main section (the button lights in red). Each is an accompaniment pattern of a few measures and it plays indefinitely. Pressing the selected MAIN VARIATION button again plays an appropriate fill-in pattern to spice up the rhythm and break the repetition. After the fill-in finishes playing, it leads smoothly into the Main section.

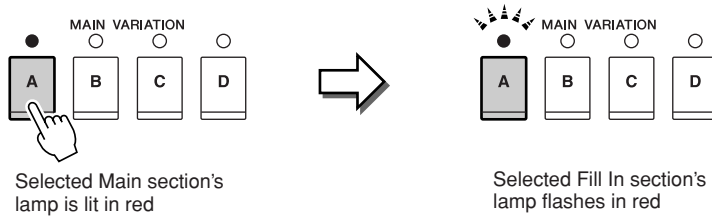

AUTO FILL function

When the [AUTO FILL IN] button is turned on, pressing any of the Main [A] – [D] buttons as you play automatically plays fill-in section.



• [BREAK] button

This lets you add dynamic breaks in the rhythm of the accompaniment. Press the [BREAK] button during Style playback. When the one-measure Break pattern finishes playing, the Style playback automatically shifts to the Main section.

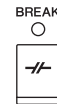

Adjusting the Tempo

• TEMPO [-]/[+] buttons

By pressing the TEMPO [-] or [+] button, you can decrease/increase the tempo over a range of 5 – 500. While the TEMPO pop-up is shown on the display, you can also use the [DATA ENTRY] dial to adjust the value.



Pressing the TEMPO [-]/[+] buttons simultaneously resets the tempo to the default value.

• [TAP TEMPO] button

During Style playback, you can change the tempo by tapping the [TAP TEMPO] button twice at the desired tempo. When the Style is stopped, tapping the [TAP TEMPO] button (four times for a 4/4 time signature) starts Style playback at the tempo you tapped.

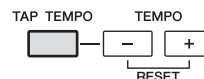

Calling up the Panel Settings to Match the Style (Repertoire)

The convenient Repertoire function automatically calls up the most appropriate panel settings (Voice number, etc.) for the currently selected Style.

Before using the Repertoire function, you need to import Music Finder records (see instructions on page 73).

1 Select the desired Style from the Style Selection display (steps 1 – 2 on page 48).

2 Press the [5 ▲] (REPETOIRE) button.

Various appropriate panel settings matching the selected Style will be shown in the display.

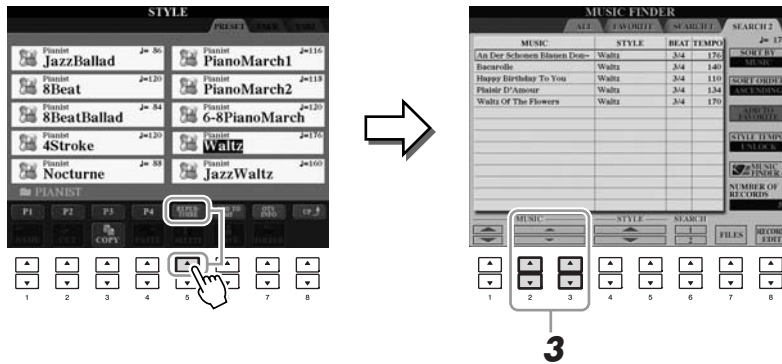

3 Use the [2 ▲▼] – [3 ▲▼] buttons to select the desired panel setting.

NOTE

The settings shown here are Music Finder Records. You can choose additional settings by using the Music Finder feature (page 76).

NOTE

Depending on the particular selected Style, there may not be any panel settings in the Repertoire function.

Appropriate Panel Settings for the Selected Style (One Touch Setting)

One Touch Setting is a powerful and convenient feature that automatically calls up the most appropriate panel settings (Voices or effects, etc.) for the currently selected Style, with the touch of a single button. If you've already decided which Style you wish to use, you can have One Touch Setting automatically select the appropriate Voice for you.

1 Select a Style (steps 1 – 2 on page 48).

2 Press one of the ONE TOUCH SETTING [1] – [4] buttons.

Not only does this instantly call up all the settings (Voices, effects, etc.) that match the current Style, it also automatically turns on ACMP and SYNC START, so that you can immediately start playing the Style.

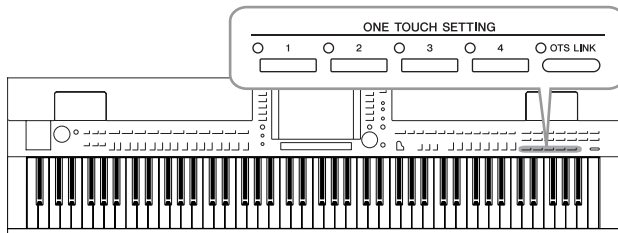

3 As soon as you play a chord with your left hand, the selected Style starts.

Each Style has four One Touch Setting setups. Press other ONE TOUCH SETTING [1] – [4] button to try out other setups.

Automatically changing One Touch Settings with the Main sections

The convenient OTS (One Touch Setting) Link function lets you automatically have One Touch Settings change when you select a different Main section (A – D). The Main sections A, B, C and D correspond to One Touch Settings 1, 2, 3 and 4 respectively. To use the OTS Link function, turn the [OTS LINK] button on.



NOTE

You can also create your own One Touch Setting setups. For details, refer to the Reference Manual on the website.

NOTE

You can change the timing in which the One Touch Settings change with MAIN VARIATION [A] – [D] change. Refer to the Reference Manual on the website.

Confirming the One Touch Setting contents

You can check the information of the One Touch Setting [1] – [4] assigned to currently selected Style.

1 In the Style Selection display, press the [7 ▲] (OTS INFO.) button to call up the Information display.

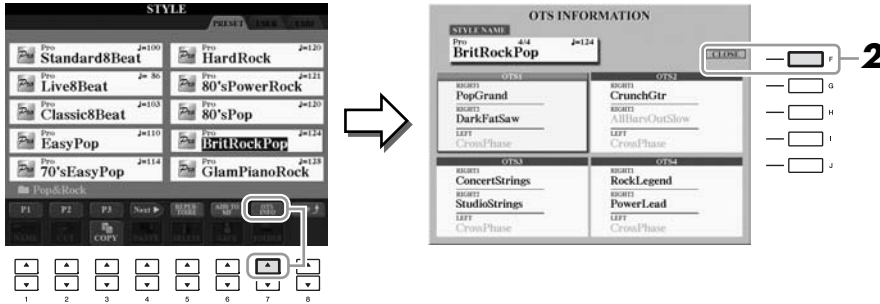

2 Press the [F] (CLOSE) button to close the Information display.

NOTE

You can also call up the Information display by pressing the [DIRECT ACCESS] button then pressing one of the ONE TOUCH SETTING [1] – [4] buttons.

Turning Style Parts On/Off and Changing Voices

A Style contains eight channels: RHY1 (Rhythm 1) – PHR2 (Phrase 2) below. You can add variations and change the feeling of a Style by selectively turning channels on/off as the Style plays.

Style channels

- **RHY1/2 (Rhythm 1/2):** These are the basic parts of the Style, containing the drum and percussion rhythm patterns.
- **BASS:** The bass part uses various appropriate instrument sounds to match the Style.
- **CHD1/2 (Chord 1/ 2):** These are the rhythmic chord backing, commonly used with piano or guitar Voices.
- **PAD:** This part is used for sustained instruments such as strings, organ, choir, etc.
- **PHR1/2 (Phrase1/2):** These parts are used for punchy brass stabs, arpeggiated chords, and other extras that make the accompaniment more interesting.

- 1** Press the [CHANNEL ON/OFF] button once or twice to call up the CHANNEL ON/OFF (STYLE) display.

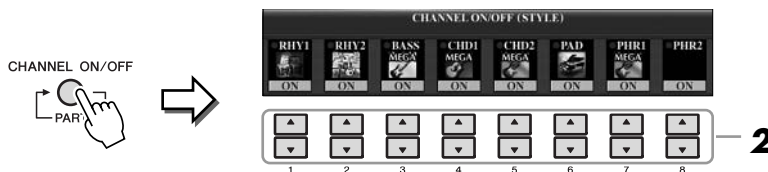

- 2** Press the [1 ▼] – [8 ▼] buttons to turn the channels on or off.

To listen to only one channel by itself, hold down the appropriate button for the channel to set the channel to SOLO. To cancel SOLO, simply press the appropriate channel button again.

Changing the Voice for each channel

If necessary, press the [1 ▲] – [8 ▲] buttons to change the Voice for the corresponding channel.

The Voice Selection display is called up from which you can select the Voice to be used for the channel. See page 37.

- 3** Press the [EXIT] button to close the CHANNEL ON/OFF display.

NOTE

You can save the settings here to Registration Memory. See page 79.

Adjusting the Volume Balance Between the Style and Keyboard

You can adjust the volume balance between Style playback and the sound you play on the keyboard.

1 Call up the Main display.

[DIRECT ACCESS] → [EXIT]

(CVP-509/505/503) The Balance display is indicated at the bottom of the Main display.

(CVP-501) Open the Balance display by pressing the [C] button.

2 Adjust the Style volume by using the [2 ▲▼] buttons and the keyboard volume by using the [5 ▲▼] – [7 ▲▼] buttons.

Using the [1 ▲▼] – [7 ▲▼] buttons, you can adjust the volume of Song, Style, MIC (for the CVP-509/505/503) and keyboard parts.

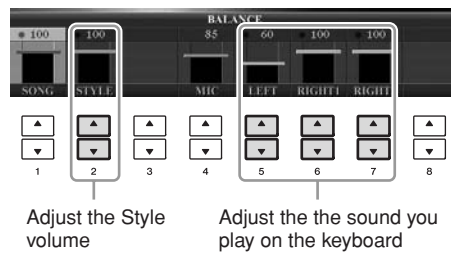

NOTE

(CVP-509/505/503) When the Balance display is not indicated, press the [EXIT] button.

NOTE

In the Mixing Console display, you can adjust the volume for each Style part. See page 91.

3

Advanced Features

Refer to the Reference Manual on the website, **Chapter 3**.



Selecting the Chord Fingering type:

[FUNCTION] → [C] STYLE SETTING/
SPLIT POINT/CHORD FINGERING →
TAB [◀][▶] CHORD FINGERING

Style playback related settings:

[FUNCTION] → [C] STYLE SETTING/
SPLIT POINT/CHORD FINGERING →
TAB [◀][▶] STYLE SETTING

Split Point settings:

[FUNCTION] → [C] STYLE SETTING/
SPLIT POINT/CHORD FINGERING →
TAB [◀][▶] SPLIT POINT

Memorizing the Original One Touch Setting:

[MEMORY] + ONE TOUCH SETTING [1]
– [4]

Creating/Editing Styles (Style Creator):

[FUNCTION] → [F] DIGITAL REC MENU
→ [B] STYLE CREATOR

- Realtime Recording: → TAB [◀][▶] BASIC
- Step Recording: → TAB [◀][▶] EDIT → [G] STEP REC
- Style Assembly: → TAB [◀][▶] ASSEMBLY
- Editing the Rhythmic Feel: → TAB [◀][▶] GROOVE
- Editing Data for Each Channel: → TAB [◀][▶] CHANNEL
- Making Style File Format Settings: → TAB [◀][▶] PARAMETER

Songs

– Playing, Practice and Recording Songs –

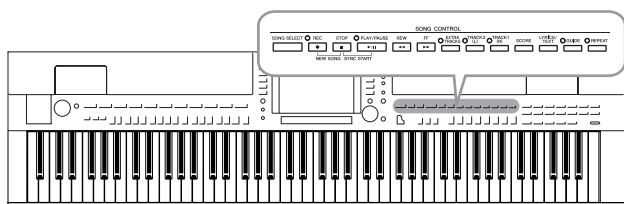

For the Clavinova, “Song” refers to the MIDI songs which include preset songs, commercially available MIDI format files, etc. Not only can you play back a Song and listen to it, but you can also play the keyboard along with Song playback and record your own performance as a Song.

Playback of Songs

You can play back the following types of Songs.

- Preset Songs (in the PRESET Page of the Song Selection display)
- Your own recorded Songs (see page 66 for instructions on recording)
- Commercially available Song data: SMF (Standard MIDI File) or ESEQ

1 Press the [SONG SELECT] button to call up the Song Selection display.

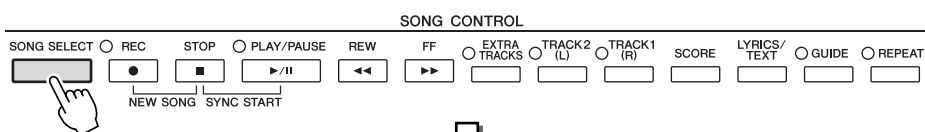

2 Press the TAB [◀][▶] buttons to select the location of the desired Song.

If you want to playback of Song in the USB storage device, connect the USB storage device containing MIDI Song data to the [USB TO DEVICE] terminal beforehand.

3 If you select “PRESET” tab in step 2, select a Song category by using the [A] – [J] buttons.

The preset Songs are categorized and contained in appropriate folders.

4 Select the desired Song by using the [A] – [J] buttons.

You can also select a Song by using the [DATA ENTRY] dial, then press the [ENTER] button to execute.

NOTE

For information on compatible data formats, refer to page 9.

NOTE

You can instantly jump back to the Main display by “double-clicking” on one of the [A] – [J] buttons.

5 Press the SONG [PLAY/PAUSE] button to start playback.

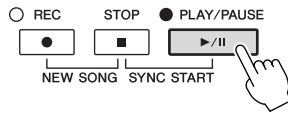

Queuing the next Song for playback

While a Song is playing back, you can queue up the next Song for playback. This is convenient for chaining it to the next Song smoothly during stage performance. Select the Song you want play next in the Song Selection display, while a Song is playing back. The “NEXT” indication appears at the upper right of the corresponding Song name. To cancel this setting, press the [8▼] (NEXT CANCEL) button.

6 Press the SONG [STOP] button to stop playback.

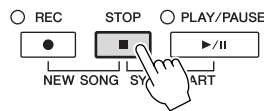

Operations During Playback

• Synchro Start

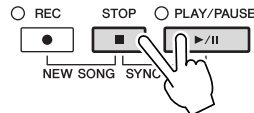

You can start playback as soon as you start playing the keyboard. While playback is stopped, hold down the SONG [STOP] button and press the [PLAY/PAUSE] button.

To cancel the Synchro Start function, hold down the SONG [STOP] button and press the [PLAY/PAUSE] button once again.

• Pause

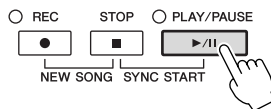

Press the [PLAY/PAUSE] button. Pressing it again resumes Song playback from the current position.

• **Rewind/Fast Forward**



Press the [REW] or [FF] button once to move back/forward one measure. Hold the [REW] or [FF] button to scroll backward/forward continuously.

Pressing the [REW] or [FF] button calls up a pop-up window showing the current measure number (or Phrase Mark number) in the display. While the Song Position pop-up is shown on the display, you can also use the [DATA ENTRY] dial to adjust the value.

For Songs not containing Phrase Marks

SONG POSITION

BAR : 001

For Songs containing Phrase Marks

SONG POSITION 001

◀
PHRASE MARK
▶

You can switch between BAR and PHRASE MARK by pressing the [E] button.

• **Adjusting the Tempo**

Same procedure as with Style tempo. See page 53.

Restrictions for protected Songs

Commercially available Song data may be copy protected to prevent illegal copying or accidental erasure. They are marked by the indications at the upper left side of the file names. The indications and relevant restrictions are detailed below.

- **Prot. 1:** Indicates Preset Songs saved to the User tab display and Disklavier Piano Soft Songs. These cannot be copied/moved/saved to external devices.
- **Prot. 2 Orig:** Indicates Yamaha-protection-formatted Songs. These cannot be copied. These can be moved/saved only to the User drive and USB storage devices with ID.
- **Prot. 2 Edit:** Indicates edited “Prot. 2 Orig” Songs. Make sure to save these to the same folder containing the corresponding “Prot. 2 Orig” Song. These cannot be copied. These can be moved/saved only to the User drive and USB storage devices with ID.

Note for “Prot. 2 Orig” and “Prot. 2 Edit” Song file operation

Make sure to save the “Prot. 2 Edit” Song to the same folder containing its original “Prot. 2 Orig” Song. Otherwise the “Prot. 2 Edit” Song cannot be played back. Also, if you move a “Prot. 2 Edit” Song, be sure to move its original “Prot. 2 Orig” Song to the same location (folder) at the same time. For information about compatible USB storage devices for saving protected Songs, visit the Yamaha website.

NOTE

Phrase Mark is a pre-programmed marker in a certain Song data, which specifies a certain location in the Song.

NOTE

You can adjust the Song volume balance between the Song and Keyboard. See page 58. In the Mixing Console display, you can adjust the volume for each Song part. See page 91.

NOTE

You can also turn the specific part(s) on or off. See page 64.

NOTE

You can transpose the Song playback. See page 42.

Displaying Music Notation (Score)

You can view the music notation (score) of the selected Song. We suggest that you read through the music notation before starting to practice.

1 Select a Song (steps 1 – 4 on page 59).

2 Press the [SCORE] button to call up the Score display.

You can look through the entire notation by using the TAB [◀][▶] buttons when the Song playback is stopped.

As starting playback, the “ball” bounces along through the score, indicating the current position.

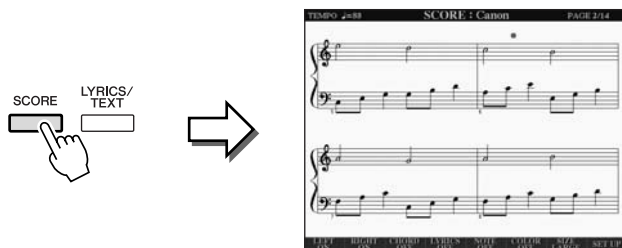

You can change the displayed notation style by using the [1 ▲▼] – [8 ▲▼] buttons. For details, refer to the Reference manual on the website.

NOTE

The instrument can display the music notation of commercially-available music data or your recorded Songs.

NOTE

The displayed notation is generated by the instrument based on the Song data. As a result, it may not be exactly the same as commercially available sheet music of the same song — especially when displaying notation of complicated passages or many short notes.

Displaying Lyrics (Text)

When the selected Song contains lyric data, you can view it on the instrument's display during playback.

- 1 Select a Song (steps 1 – 4 on page 59).**
- 2 Press the [LYRICS/TEXT] button (CVP-509/505/503) / [LYRICS] button (CVP-501) to call up the Lyrics display.**

When the Song data contains lyrics data, the lyrics are shown on the display. You can look through the entire lyrics by using the TAB [◀][▶] buttons when the Song playback is stopped.

As Song playback starts, the color of the lyrics changes, indicating the current position.



Displaying Text

CVP-509 CVP-505 CVP-503 CVP-501

Even if the Song doesn't contain lyrics data, you can view the lyrics on the display by loading the text file (.txt) created on a computer via USB storage device. This feature enables various useful possibilities, such as the showing of lyrics, chord names, and text notes.

- 1 When the Lyrics display is shown, press the [1 ▲▼] (TEXT) button to display the text.**
- 2 Press the [5 ▲▼]/[6 ▲▼] (TEXT FILE) button to call up the Text selection display.**
- 3 Select the desired text file.**

To return to the Lyrics display, press the [1 ▲▼] (LYRICS) button again.

For more information about the Lyrics/Text display, refer to the Reference manual on the website.

NOTE

(CVP-509/505) The Lyrics (text) can be displayed on the external monitor. See page 101.

Turning Song Channels On/Off

A Song consists of 16 separate channels. You can independently turn each channel of the selected Song playback on or off.

- 1 Press the [CHANNEL ON/OFF] button once or twice to call up the CHANNEL ON/OFF (SONG) display.

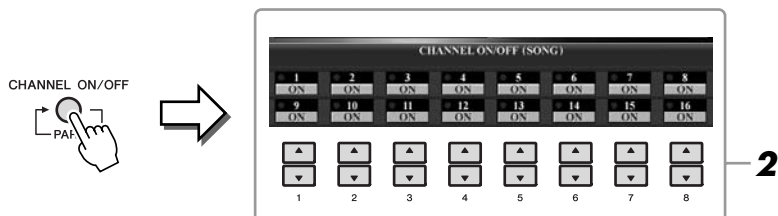

- 2 Use the [1 ▲▼] – [8 ▲▼] button to turn each channel on or off.

If you want to play back only one particular channel (solo playback), press and hold down one of the [1 ▲▼] – [8 ▲▼] buttons corresponding to the desired channel. Only the selected channel is turned to on and others are off. To cancel solo playback, press the same button again.

4

One-handed Practice with the Guide Lamps

The key guide lamps indicate the notes you should play, when you should play them, and how long you should hold them down. You can also practice at your own pace — since the accompaniment waits for you to play the notes correctly. Here, mute the right-hand part and try practicing the part using the guide lamps.

- 1 Select a Song and call up the Score display (page 62).

- 2 Turn the [GUIDE] button on.



- 3 Press the [TRACK 1 (R)] button to mute the right-hand part.

The indicator of the [TRACK 1 (R)] button goes out. You can now play that part by yourself.

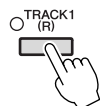

- 4 Press the SONG [PLAY/PAUSE] button to start playback.

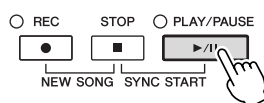

Practice the muted part using the guide lamps.

After your practice, turn the [GUIDE] button off.

NOTE

The guide lamps light in red for the white keys and green for the black keys.

NOTE

Usually, CH 1 is assigned to [TRACK 1 (R)] button, CH 2 is assigned to [TRACK 2 (L)] button, and CH 3 – 16 are assigned to the [EXTRA TRACKS] button.

Other guide functions

There are additional functions in the Guide features, for practicing the timing of playing the keys (Any Key mode) or for Karaoke.

[FUNCTION] → [B] SONG SETTING → [A]/[B] GUIDE MODE

For more information, refer to the Reference Manual on the website.

Repeat Playback

The Song Repeat functions can be used to repeatedly play back a Song or a specific range of measures in a Song. This is useful for repeated practicing of difficult-to-play phrases.

To repeat a Song, turn the [REPEAT] button on and playback the desired Song. Turning the [REPEAT] button off cancels Repeat playback.



Specifying a Range of Measures and Playing them Back Repeatedly (A-B Repeat)

- 1 Select a Song (steps 1 – 4 on page 59).
- 2 Press the SONG [PLAY/PAUSE] button to start playback.
- 3 Specify the repeat range.

Press the [REPEAT] button at the starting point (A) of the range to be repeated. Press the [REPEAT] button again at the ending point (B). After an automatic lead-in (to help guide you into the phrase), the range from Point A to Point B is played back repeatedly.

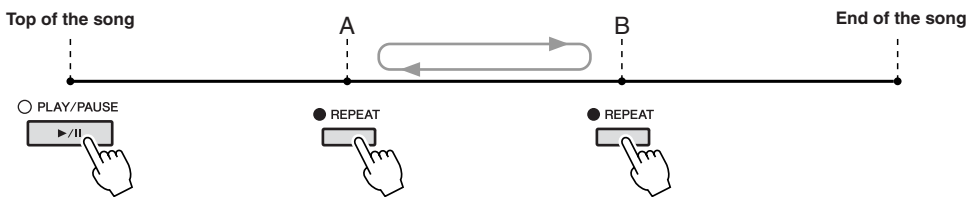

- 4 To stop playback, press the SONG [STOP] button.
The Song position will return to Point A.
- 5 Press the [REPEAT] button to turn off Repeat playback.

Specifying the repeat range while Songs are stopped

1. Press the [FF] button to advance to the Point A location.
2. Press the [REPEAT] button to specify Point A.
3. Press the [FF] button to advance to the Point B location.
4. Press the [REPEAT] button again to specify Point B.

NOTE

You can play multiple Songs repeatedly: [FUNCTION] → [B] SONG SETTING → [H] REPEAT MODE.

NOTE

Specifying only Point A results in repeat playback between Point A and the end of the Song.

NOTE

When you want to repeat from the top of the song to middle of the song:
1 Press the [REPEAT] button, then start Song playback.
2 Press the [REPEAT] button again at the ending point (B).

Recording Your Performance (Quick Recording)

You can record all parts of your performance at once or each part (right-hand, left-hand and Style playback) independently. This is an effective practice tool, allowing you to easily compare your own performance to the original song you are practicing. Before starting recording, make the desired panel settings for your keyboard performance — selecting a Voice, Style, etc.

1 Press the SONG [REC] button and the [STOP] button simultaneously.

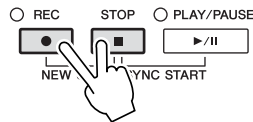

A blank Song for recording is automatically set.

2 Press the SONG [REC] button.

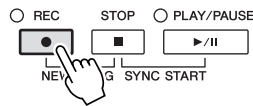

Recording a specific part

In place of step 2, pressing the SONG [TRACK 1 (R)] (or [TRACK 2 (L)]) button while holding the [REC] button enables you to record only the right-hand (or left-hand) part.

Pressing the [EXTRA TRACKS] button while holding the [REC] button enables recording of only Style playback.

3 Start recording.

Recording begins automatically as soon as you play a note on the keyboard or start Style playback.

4 Press the SONG [STOP] button to stop recording.

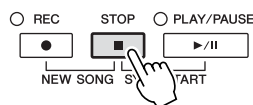

A message prompting you to save the recorded performance appears. To close the message, press the [EXIT] button.

5 Press the SONG [PLAY/PAUSE] button to play back the recorded performance.

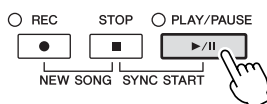

NOTE

For Quick Recording, each part will be recorded to the following channels.

Keyboard parts: Ch. 1-3

Style parts: Ch. 9-16

6 Save the recorded performance as a Song.

Press the [SONG SELECT] button to call up the Song Selection display. The recorded Song can be saved in the Song Selection display. Refer to “Saving Files” on page 68 for instructions.

CAUTION

The recorded Song will be lost if you change to another Song or you turn the power off without executing the save operation.

Multi Track Recording

A Song consists of 16 separate channels. With this method, you can record data to each channel independently, one by one. You can also freely change the channel/part assignments with the Multi Track recording.

The procedure is basically the same as that of “Recording Your Performance (Quick Recording)” on page 66, with the following instructions substituted for step 2 above.

While holding down the SONG [REC] button, press the [1 ▲▼] – [8 ▲▼] buttons to set the desired channels to “REC.” Then assign the desired part to the channel by using the [C]/[D] buttons.

If you want to record the Right 1 part to channel 1, for example, press the [1 ▲] button while holding down the [REC] button to set the channel 1 to “REC.” Then use the [C]/[D] buttons to select “RIGHT 1.”

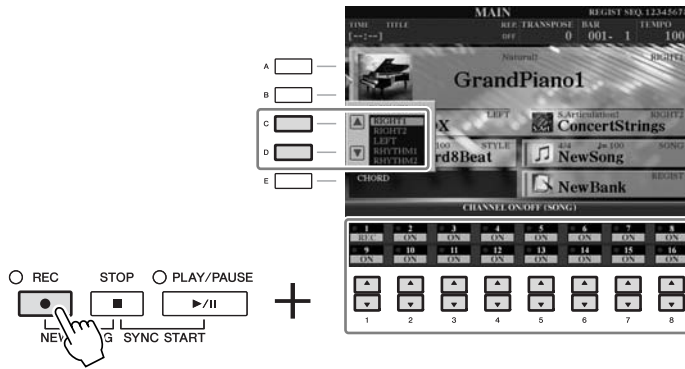

After proceeding with steps 3 – 5, re-select other channels and record other parts as desired.

Saving Files

This operation lets you save your original data (such as Songs you've recorded and Voices you've edited) to a file. The explanations here apply when you save your recorded performance as a Song file.

- 1** In the file selection display, select the appropriate tab (USER or USB) to which you want to save the data by using the TAB [◀][▶] buttons.

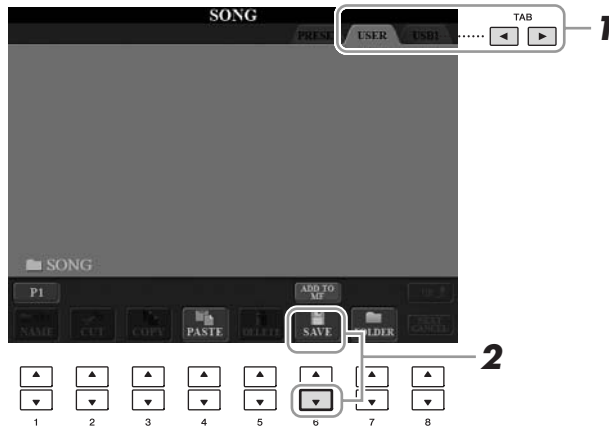

- 2** Press the [6 ▼] (SAVE) button to call up the file naming display.



- 3** Enter the file name (page 27).

Even if you skip this step, you can rename the file at any time after saving (page 70).

- 4** Press the [8 ▲] (OK) button to save the file.

The saved file will be automatically located at the appropriate position among the files in alphabetical order.

NOTE

If you want to cancel the Save operation, press the [8 ▼] (CANCEL) button.

File Management

If you've saved a lot of files to a USB flash memory or USER drive, it may be difficult to find the desired file quickly. To make it easier to find the files you want, you can organize your files in folders, rename the files, delete unnecessary files, etc. These operations are done in the File Selection display.

Creating a New Folder

This operation lets you create new folders. Folders can be created, named and organized as desired, making it easier to find and select your original data.

- 1** In the file selection display, select the appropriate tab (USER or USB) to which you want to save the data by using the TAB [◀][▶] buttons.

If you want to create a new folder within the existing folder, also select the folder here.

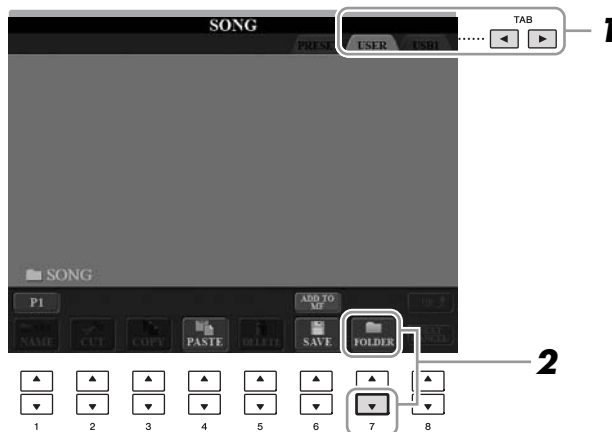

- 2** Press the [7 ▼] (FOLDER) button to call up the naming display for a new folder.



- 3** Input the name of the new folder (see page 27).

NOTE

A new folder cannot be made in the PRESET tab.

NOTE

The maximum number of files/folders which can be stored in a folder is 250.

NOTE

In the USER tab display, folder directories can contain up to four levels. The maximum total number of files/folders which can be stored differs depending on the file size and the length of the file/folder names.

NOTE

The following marks cannot be entered for a file/folder name.
¥ / : * ? " < > |

Renaming Files/Folders

This operation lets you rename files/folders.

1 Call up the display containing the file/folder you want to rename.

2 Press the [1 ▼] (NAME) button.

The pop-up window for the Rename operation appears at the bottom of the display.

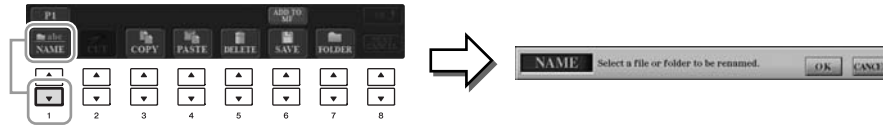

3 Press one of the [A] – [J] buttons corresponding to the desired file/folder.

4 Press the [7 ▼] (OK) button to confirm the file/folder selection.

5 Input the name (characters) of the selected file or folder (page 27).

The renamed file/ folder appears on the display at the appropriate position among the files in alphabetical order.

NOTE

Files in the PRESET tab cannot be renamed.

NOTE

To cancel the Rename operation, press the [8 ▼] (CANCEL) button.

Copying or Moving Files

This operation lets you copy or cut a file and paste it to another location (folder). You can also copy a folder (but not move it) by using the same procedure.

1 Call up the display containing the file/folder you want to copy.

2 Press the [3 ▼] (COPY) button to copy or [2 ▼] (CUT) to move.

The pop-up window for the Copy/Cut operation appears at the bottom of the display.

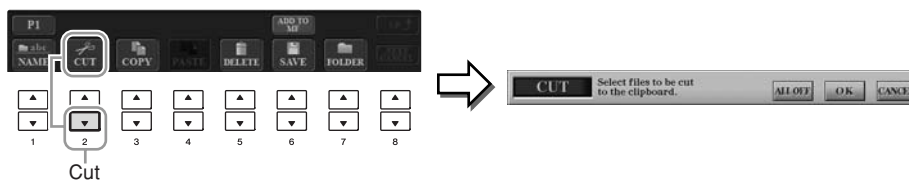
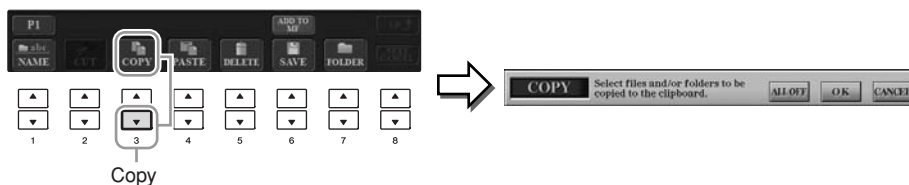

NOTE

Files in the PRESET tab cannot be moved. They can only be copied.

3 Press one of the [A] – [J] buttons corresponding to the desired file/folder.

To cancel the selection, press the same [A] – [J] button again.
Press the [6 ▼] (ALL) button to select all files/folders indicated on the current display including the other pages. To cancel the selection, press the [6 ▼] (ALL OFF) button again.

4 Press the [7 ▼] (OK) button to confirm the file/folder selection.

5 Select the destination tab (USER or USB) to paste the file/folder, by using the TAB [◀][▶] buttons.

If necessary, select the destination folder by using the [A] – [J] buttons.

6 Press the [4 ▼] (PASTE) button to paste the file/folder selected in step 3.

The pasted file/folder appears on the display at the appropriate position among the files in alphabetical order.

NOTE

To cancel the Copy operation, press the [8 ▼] (CANCEL) button.

Deleting Files/Folders

This operation lets you delete a file/folder.

1 Call up the display containing the file/folder you want to delete.

2 Press the [5 ▼] (DELETE) button.

The pop-up window for the Delete operation appears at the bottom of the display.

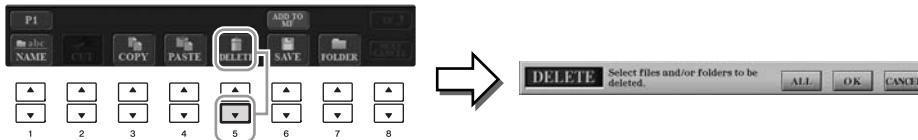

3 Press one of the [A] – [J] buttons corresponding to the desired file/ folder.

To cancel the selection, press the same [A] – [J] button again.
Press the [6 ▼] (ALL) button to select all files/folders indicated on the current display including the other pages. To cancel the selection, press the [6 ▼] (ALL OFF) button again.

4 Press the [7 ▼] (OK) button to confirm the file/folder selection.

5 Follow the on-display instructions.

- **YES** Delete the file/folder
- **YES ALL** Delete all selected files/folders
- **NO** Leave the file/folder as is without deleting
- **CANCEL** Cancel the Delete operation

NOTE

Files in the PRESET tab cannot be deleted.

NOTE

To cancel the Delete operation, press the [8 ▼] (CANCEL) button.

Advanced Features

Refer to the Reference Manual on the website, **Chapter 4**.



Editing Music Notation settings:	[SCORE] → [1 ▲▼] – [8 ▲▼] buttons
Editing Lyrics/Text display settings (CVP-509/505/503):	[LYRICS/TEXT] → [1 ▲▼] – [8 ▲▼] buttons
Using the Auto Accompaniment Features with the Song Playback:	[ACMP ON/OFF] → STYLE CONTROL [SYNC START] → SONG [STOP] + [PLAY/PAUSE] → STYLE CONTROL [START/STOP]
Song Playback related parameters:	[FUNCTION] → [B] SONG SETTING
<ul style="list-style-type: none"> • Keyboard and Vocal Practice Using the Guide Function: • Playing Backing Parts with the Performance Assistant Technology: 	<ul style="list-style-type: none"> → [A]/[B] GUIDE MODE → [8 ▲▼] P.A.T.
Creating/Editing Songs (Song Creator):	[FUNCTION] → [F] DIGITAL REC MENU → [A] SONG CREATOR
<ul style="list-style-type: none"> • Recording Melodies (Step Recording): • Recording Chords (Step Recording): • Re-Recording a Specific Section—Punch In/Out: • Editing Channel Events: • Editing Chord events, Notes, System Exclusive events and Lyrics: 	<ul style="list-style-type: none"> → TAB [◀][▶] 1-16 → TAB [◀][▶] CHORD → TAB [◀][▶] REC MODE → TAB [◀][▶] CHANNEL → TAB [◀][▶] CHORD, 1-16, SYS/EX. or LYRICS

Music Finder

– Calling Up Ideal Setups (Voice, Style, etc.) for Each Song –

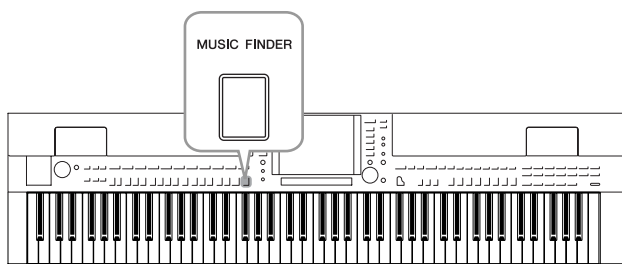

If you want to play in a certain genre of music but don't know which Style and Voice settings would be appropriate, the convenient Music Finder function can help you out. Simply select the desired music genre (or song title) from among the Music Finder panel settings, and the instrument automatically makes all appropriate panel settings to let you play in that music style. Moreover, by registering the Song/Audio data saved in various places into Music Finder, the instrument can easily call up the relevant data from the song title. The Music Finder Plus function gives you the added capability, by connecting the instrument to the Internet, of searching for and adding desired panel settings and song data via the Internet to the instrument.

Loading panel settings from the website

As a factory default, some sample records (panel settings) are provided in the Music Finder. By downloading many panel settings from Yamaha website and importing them to the instrument, you can use the Music Finder function more conveniently and effectively. Moreover, the Repertoire function (page 54) can also be enhanced by importing the panel settings. Before using the Music Finder function, we recommend that you load the panel settings from the website following the instructions below. <http://services.music.yamaha.com/musicfinder/>

- 1 Download the Music Finder panel settings file from the website to the USB storage device.
- 2 Connect the USB storage device which contains the panel settings file to the [USB TO DEVICE] terminal of the instrument.
- 3 Press the [MUSIC FINDER] button to call up the MUSIC FINDER display.

MUSIC FINDER

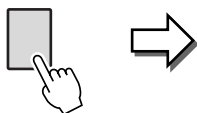

MUSIC FINDER			
MUSIC	STYLE	BEAT	TEMPO
A Musical Joke	PopClassics	4/4	124
Abide With Me	ClassicPianoBld	4/4	72
Aida Triumph March	OrchestralMarch	4/4	112
Air On The G String	BaroqueAir	4/4	69
Air On The G String	Chillout1	4/4	68
Air On The G String	ClassicPianoBld	4/4	68
Aloha Oe	Hawaiian	4/4	102
Amapola	60'sGuitarPop	4/4	138
Amapola	Rumba	4/4	112
Amapola	SlowOrchBld	4/4	46
Amboss Polka	PartyPolka	4/4	116
American Patrol	BigBandFast2	4/4	186
An Der Schonen Blauen Don-	VienneseWaltz1	3/4	174
An Der Schonen Blauen Don-	Waltz	3/4	176

- 4 Press the [7 ▲▼] (FILES) button to call up the File Selection display.

NOTE

Before using a USB storage device, be sure to read "Connecting a USB Storage Device" on page 106.

CAUTION

Replacing automatically overwrites all your records (panel settings/song data shown in the MUSIC FINDER display). Make sure that all important data has been saved to the USER or USB in the File Section display (step 4 as described at left).

- 5** Use the TAB [◀][▶] buttons to call up the USB display containing the panel settings file downloaded from the website.



- 6** Press the button which corresponds to the file to display the message for selecting REPLACE/APPEND of the panel settings.

- 7** Press the [F] (REPLACE) button to delete all records currently in the instrument and replace them with the records of the selected file.

Press the [G] (YES) button at the confirmation prompt.

- 8** Press the [F] (YES) button in the message display (indicating completion of the replace operation) to call up the MUSIC FINDER display.

By checking the number of records in the MUSIC FINDER display, you can confirm the record has been replaced.

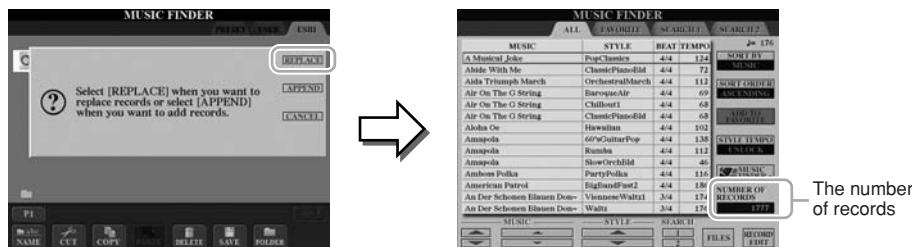

NOTE

Even after replacing the Music Finder records, you can restore them to their original factory settings by selecting the "MusicFinderPreset" file in PRE-SET display of the step.

About the Music Finder Records

MUSIC	STYLE	BEAT TEMPO	NUMBER OF RECORDS
Voces Of Spring	VietneseWaltz1	3/4 186	176
Waltz Of The Flowers	VietneseWaltz1	3/4 180	
Wiener Eilat	VietneseWaltz1	3/4 186	
An Der Schönen Elbauen Don-	Waltz	3/4 175	
Baccarolle	Waltz	3/4 140	
Happy Birthday To You	Waltz	3/4 110	
Flair D'Amour	Waltz	3/4 134	
Waltz Of The Flowers	Waltz	3/4 170	
Mourning Into Dancing	WorshipFast	4/4 117	
Ave Maria	(SONG)		
Canon	(SONG)		
Petite Suite 1.Ein Bastron	(SONG)		
Audio_001	(AUDIO)		
Audio_002	(AUDIO)		

Each data which can be called up from the MUSIC FINDER display is called a "record." There are three following different records.

- **Panel Settings**
Setting data, such as Styles, Voices, etc.
- **Song (SONG)**
Song data which is registered to the Music Finder from the Song Selection display (page 59)
- **Audio (AUDIO) (CVP-509/505/503)**
Audio data which is registered to the Music Finder from the USB Audio Selection display (page 84)

NOTE

For information on registering the Song/Audio data to the Music Finder, refer to page 77.

Selecting the Desired Song from among the Panel Settings

- 1 Press the [MUSIC FINDER] button to call up the MUSIC FINDER display.

In the ALL display, all the records are shown.

Shows the song title and information of the Style assigned to the panel settings.

MUSIC FINDER				
ALL		FAVORITE	SEARCH 1	SEARCH 2
MUSIC	STYLE	BEAT	TEMPO	J= 176
A Musical Joke	PopClassics	4/4	124	
Abide With Me	ClassicPianoBld	4/4	72	
Aida Triumph March	OrchestralMarch	4/4	112	
Air On The G String	BaroqueAir	4/4	69	
Air On The G String	Chillout1	4/4	68	
Air On The G String	ClassicPianoBld	4/4	68	
Aloha Oe	Hawaiian	4/4	102	
Amapola	60'sGuitarPop	4/4	138	
Amapola	Rumba	4/4	112	
Amapola	SlowOrchBld	4/4	46	
Amboss Polka	PartyPolka	4/4	116	
American Patrol	BigBandFast2	4/4	186	
An Der Schonen Blauen Don-	VienneseWaltz1	3/4	174	
An Der Schonen Blauen Don-	Waltz	3/4	176	

- 2 Use the [2 ▲▼]/[3 ▲▼] buttons to select the desired Panel Settings.

You can also use the [DATA ENTRY] dial and the [ENTER] button.

Sorting the records

Press [F] (SORT BY) button to sort the records by MUSIC, STYLE, BEAT and TEMPO. Press the [G] (SORT ORDER) button to change the order of the records (ascending or descending).

When sorting records by MUSIC, you can use the [1 ▲▼] button to skip up or down through the songs alphabetically. When sorting records by STYLE, you can use the [4 ▲▼]/[5 ▲▼] button to skip up or down through the Styles alphabetically. Simultaneously press the [▲] and [▼] buttons to move the cursor to the first record.

- 3 Play the chords in the left-hand section of the keyboard.

NOTE

Refer to page 78 for information on selecting SONG and AUDIO records.

NOTE

If you want to avoid changing the Tempo during Style playback when selecting another record, turn on the Tempo Lock function by pressing the [I] (STYLE TEMPO) button in the Music Finder display.

Searching the Panel Settings

You can search the records by specifying a song name or keyword, using the Search function of the Music Finder.

1 From the ALL page of the MUSIC FINDER display, press the [6 ▲] (SEARCH 1) button to call up the Search display.

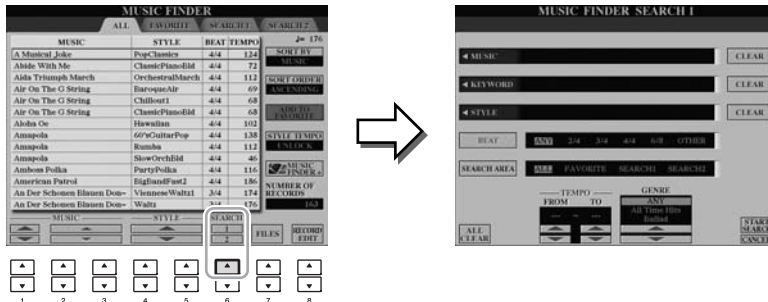

2 Enter the search criteria.

[A]	MUSIC	Searches by song name. Pressing the [A] button calls up the pop-up window to enter the song name. To clear the entered Music, press the [F] (CLEAR) button.
[B]	KEYWORD	Searches by keyword. Pressing the [B] button calls up the pop-up window to enter the keyword. To clear the entered Keyword, press the [G] (CLEAR) button.
[C]	STYLE	Searches by Style. Pressing the [C] button calls up the Style Selection display. After selecting the desired Style, press the [EXIT] button to return back to the Search display. To clear the entered Style, press the [H] (CLEAR) button.
[D]	BEAT	Specifies the time signature for the search. All beat settings are included in the search if you select ANY.
[E]	SEARCH AREA	Selects a specific location (the tab of the upper part of the MUSIC FINDER display) for searching.
[1 ▲▼]	ALL CLEAR	Clears all entered search criteria.
[3 ▲▼]	TEMPO FROM	Sets the range of the tempo you want to use for the search.
[4 ▲▼]	TEMPO TO	
[5 ▲▼]/ [6 ▲▼]	GENRE	Selects the desired music genre.

To cancel searching, press the [8 ▼] (CANCEL) button.

3 Press the [8 ▲] (START SEARCH) button to start the search.

The Search 1 display appears, showing the results of the search.

5

Music Finder – Calling Up Ideal Setups (Voice, Style, etc.) for Each Song –

NOTE

You can search several different Keywords simultaneously by inserting a separator (comma) between each.

NOTE

If you select a beat of 2/4 or 6/8, a Style suitable for performing a song in 2/4 and 6/8 beat can be searched, but the actual Style is created by using a 4/4 beat.

NOTE

When searching Song/Audio files (page 74), it is necessary to set the search criteria as follows.

STYLE: Blank
BEAT: ANY
TEMPO: "----" - "----"

NOTE

If you wish to search another criteria, press the [6 ▼] (SEARCH 2) button in the Music Finder display. The search result is displayed in the SEARCH 2 display.

Registering the Song/Audio data (SONG/AUDIO)

By registering the Song/Audio data saved in various places (Song Selection display: page 59; USB Audio Selection display (CVP-509/505/503): page 84) into Music Finder, the instrument can call up song data easily from the song title.

1 Display the Song data.

Song data (SONG) in the Song Selection display

Press the [SONG SELECT] button to display the song data (Song file) in the Song Selection display.



Song data (AUDIO) in the USB Audio Selection display (CVP-509/505/503)

1-1 Press the [USB] button to call up the Playback display (AUDIO PLAYER display).

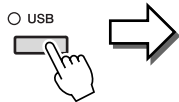

1-2 Press the [8 ▲▼] (FILE SELECT) button to display the song data (Audio file) in the connected USB storage device.

2 Press the [A] – [J] buttons corresponding to the desired file.



3 Press the [6 ▲] (ADD TO MF) button to register the selected data to Music Finder.

The display automatically changes to the Music Finder Record Edit display.

4 Press [8 ▲] (OK) button to start the registration.

Press the [8 ▼] (CANCEL) button to cancel the registration.

NOTE

If you want to register the Song/Audio data of the USB storage device, connect the USB storage device containing the data to the [USB TO DEVICE] terminal.

NOTE

Before using a USB storage device, be sure to read "Connecting a USB Storage Device" on page 106.

5 Check the song data (SONG/AUDIO) is added in the MUSIC FINDER display.

The song data is shown as SONG or AUDIO in the STYLE column.



Recalling the registered song data from Music Finder

You can recall the registered song data in the same way as done in the “Selecting the Desired Song from among the Panel Settings” (page 75) and “Searching the Panel Settings” (page 76).

- To play back the recalled Song data, press the SONG [PLAY/PAUSE] button after selecting the SONG record.
- To play back the recalled audio data, press the [USB] button, then press the [2 ▲▼] (▶/||) button after selecting the AUDIO record.

NOTE

If you want to play back Song/Audio data in the USB storage device, connect the USB storage device containing the data to the [USB TO DEVICE] terminal beforehand.

Added convenience using the Internet (Music Finder+)

This service gives you the capability, by connecting the instrument to the Internet, of searching for and adding desired panel settings and song data via the Internet to the instrument. Let's connect the instrument to the Internet, and press the [J] (MUSIC FINDER+) button on the MUSIC FINDER display!



For more details about this service, refer to the following website.

<http://services.music.yamaha.com/musicfinder/>

NOTE

The available contents of the Music Finder Plus service are subject to change.

Advanced Features

Refer to the Reference Manual on the website, **Chapter 5**.



Creating a Set of Favorite Records: [MUSIC FINDER] → TAB [◀|▶] ALL → [H] (ADD TO FAVORITE)

Editing Records: [MUSIC FINDER] → [8 ▲▼] (RECORD EDIT)

Saving the Record as a Single File: [MUSIC FINDER] → [7 ▲▼] (FILES)

Viewing Record Information on the Internet (MUSIC FINDER Plus): [MUSIC FINDER] → [J] (MUSIC FINDER +)

Registration Memory

– Saving and Recalling Custom Panel Setups –

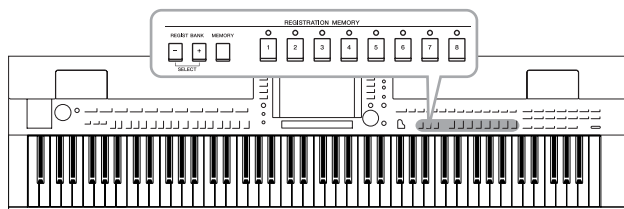

The Registration Memory function allows you to save (or “register”) virtually all panel settings to a Registration Memory button, and then instantly recall your custom panel settings by simply pressing a single button. The registered settings for eight Registration Memory buttons should be saved as a single Bank (file).

Registering Your Panel Setups

- 1 Set up the panel controls (such as Voice, Style, effects, and so on) as desired.**

Refer to the separate Data List for a list of parameters that can be registered with the Registration Memory function.

- 2 Press the [MEMORY] button in the REGISTRATION MEMORY section.**

The display for selecting the items to be registered appears.

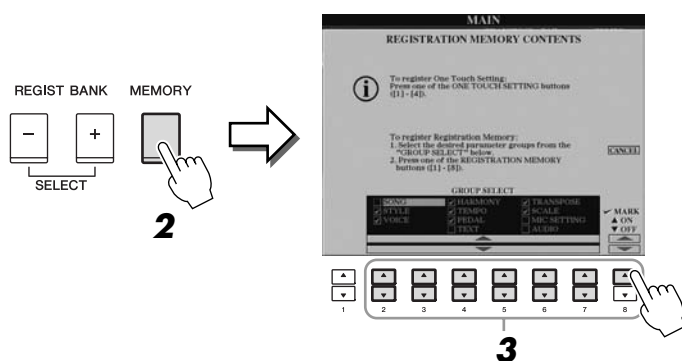

- 3 Determine the items you want to register.**

Select the desired item by using the [2▲▼] – [7▲▼] buttons, then enter or remove the checkmark by using the [8▲] (MARK ON)/ [8▼] (MARK OFF) buttons.

To cancel the operation, press the [I] (CANCEL) button.

4 Press one of the REGISTRATION MEMORY [1] – [8] buttons to which you wish to memorize the panel setup.

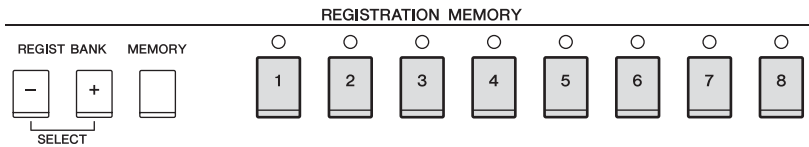

The memorized button becomes red, which indicates the number button contains data and its number is selected.

About the lamp status

- **Red:** Data registered and currently selected
- **Green:** Data registered but not currently selected
- **Off:** No data registered

5 Register various panel setups to other buttons by repeating steps 1 – 4.

The registered panel setups can be recalled by simply pressing the desired number button.

CAUTION

If you select the button whose lamp is lit in red or green here, the panel setup previously memorized to the button will be erased and replaced by the new settings.

NOTE

The panel setups registered in the numbered buttons are preserved even when you turn off the power. If you want to delete all the eight current panel setups, turn the power on while holding the B6 key (right-most B key on the keyboard).

Saving the Registration Memory as a Bank file

You can save all the eight registered panel setups as a single Registration Memory Bank file.

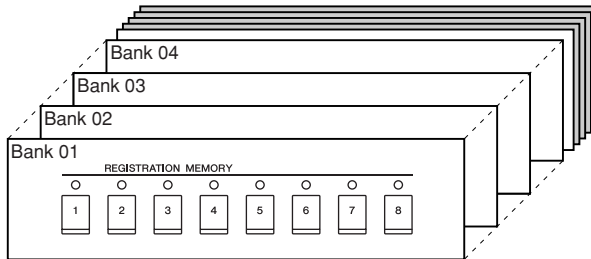

1 Press the REGIST BANK [+] and [-] buttons simultaneously to call up the Registration Bank Selection Display.

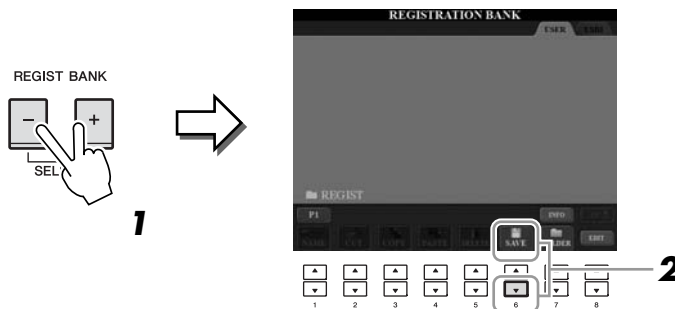

2 Press the [6 ▼] (SAVE) button to save the Bank file.

For instructions on saving, refer to page 68.

NOTE

In general, Registration Memory data (Bank files) is compatible among the models CVP-509/505/503/501. However, the data may not be perfectly compatible, depending on the specifications of each model.

Recalling a Registered Panel Setup

The saved Registration Memory Bank files can be recalled by using the REGIST BANK [-]/[+] buttons or the following procedure.

- 1 Press the REGIST BANK [+] and [-] buttons simultaneously to call up the REGISTRATION BANK Selection Display.

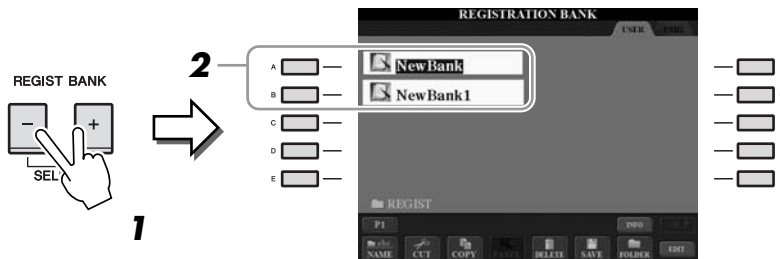

- 2 Press one of the [A] – [J] buttons to select a Bank.

You can also use the [DATA ENTRY] dial and the [ENTER] button to select a Bank.

- 3 Press one of the green-lit numbered buttons ([1] – [8]) in the Registration Memory section.

Confirming the Registration Memory Information

You can call up the information display to take a look which Voices and Style are memorized to the [1] – [8] buttons of a Registration Memory Bank.

- 1 Simultaneously press the REGIST BANK [+] and [-] buttons to call up the Registration Bank Selection display, then use the [A] – [J] buttons to select the desired Bank.
- 2 Press the [7▲] (INFO.) button to call up the information display.

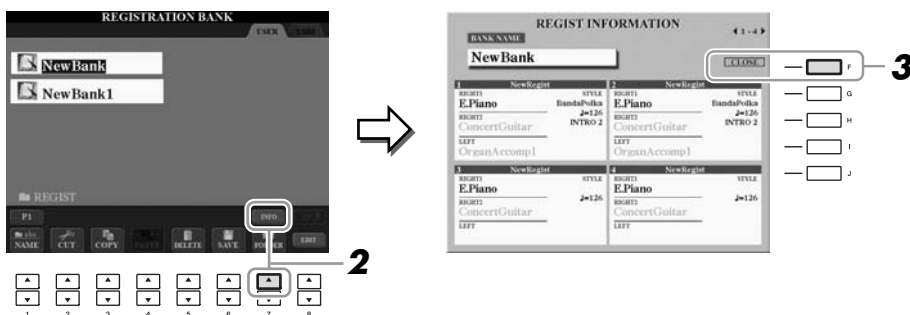

By using the TAB [◀][▶] buttons, you can switch between the two information display pages: information for the Registration Memory [1] – [4] buttons and information for the [5] – [8] buttons.

- 3 Press the [F] (CLOSE) button to close the information display.

NOTE

When recalling the setups including Song/Style file selection from a USB storage device, make sure that the appropriate USB storage device including the registered Song/Style is connected into the [USB TO DEVICE] terminal.

NOTE

You can instantly call up the information display of the currently selected Registration Memory Bank by pressing the [DIRECT ACCESS] button and one of the REGISTRATION MEMORY [1] – [8] buttons in sequence.

NOTE

If some Voice part is set to off (CVP-509/505), the Voice name for corresponding part is shown in gray. (On the CVP-503/501, the Voice part name for corresponding part is shown in gray.)

Advanced Features

Refer to the Reference Manual on the website, **Chapter 6**.



Disabling recall of specific items:	[FUNCTION] → [E] REGIST SEQUENCE/FREEZE/ VOICE SET → TAB [◀][▶] FREEZE
Calling up Registration Memory numbers in order:	[FUNCTION] → [E] REGIST SEQUENCE/FREEZE/ VOICE SET → TAB [◀][▶] REGISTRATION SEQUENCE

USB Audio (CVP-509/505/503)

– Playback and Recording Audio Files –

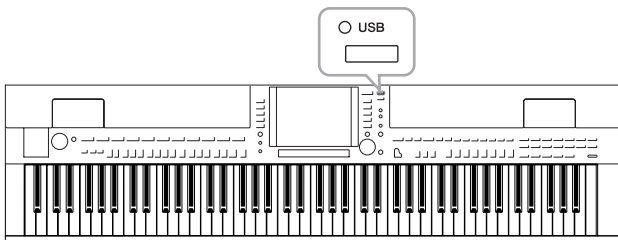

The convenient USB Audio function allows you to play back audio files (WAV or MP3) stored to a USB flash memory device—directly from the instrument. Moreover, since you can record your performances and recordings as audio data (.WAV) to a USB flash memory device, it is possible to play back the files on computer, share them with your friends, and record your own CDs to enjoy as well.

Playing Back Audio Files

CVP-509 CVP-505 CVP-503 CVP-501

Try playing back audio files from USB flash memory on this instrument.

File formats that can be played back

.wav	44.1 kHz sample rate, 16 bit resolution, stereo	CVP-509 CVP-505 CVP-503
.mp3	44.1/48.0 kHz sample rate, 64-320 kbps and variable bit rate, mono/stereo	CVP-509 CVP-505

Connect the USB flash memory device containing the audio files to play back to the [USB TO DEVICE] terminal.

- 1 Press the [USB] button to call up the Playback display (AUDIO PLAYER display).

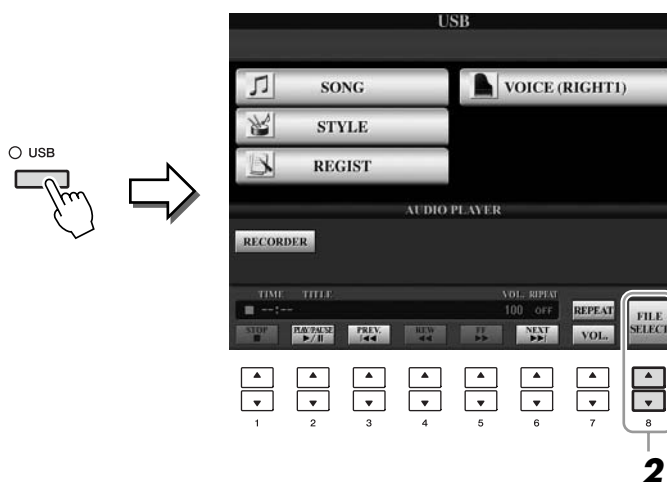

- 2 Press the [8 ▲▼] (FILE SELECT) button to display the audio files saved to the connected USB flash memory.

NOTE

The instrument cannot be play back DRM protected files.

NOTE

Before using a USB flash memory, be sure to read "Connecting a USB Storage Device" on page 106.

- Press one of the [A] – [J] buttons corresponding to the file you want to listen to.



- Press the [EXIT] button to return to the Playback display (AUDIO PLAYER display).

- Press the [2 ▲▼] (▶/||) button to play back.

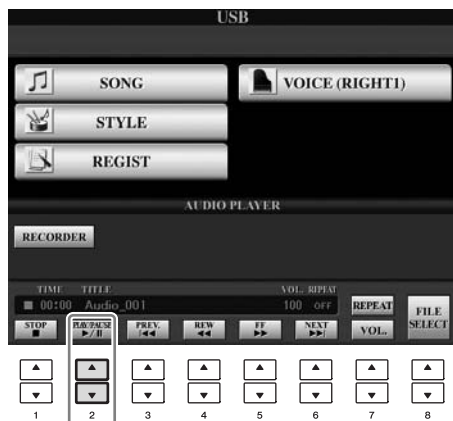

CAUTION

Never attempt to disconnect the USB flash memory or turn the power off during playback. Doing so may corrupt the USB flash memory data.

Playback-related Operations

You can stop, pause, select, rewind, and forward by using the [1 ▲▼] – [6 ▲▼] buttons. Moreover, you can set the REPEAT mode by pressing the [7 ▲] button and adjust the volume by pressing the [7 ▼] button.

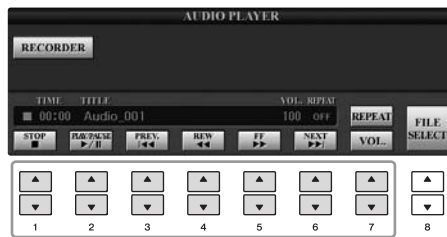

• Playing back audio files repeatedly

Press the [7 ▲] (REPEAT) button then set the REPEAT mode of the audio file by using the [7 ▲▼] buttons. To close the setting display, press the [8 ▲▼] (CLOSE) button.

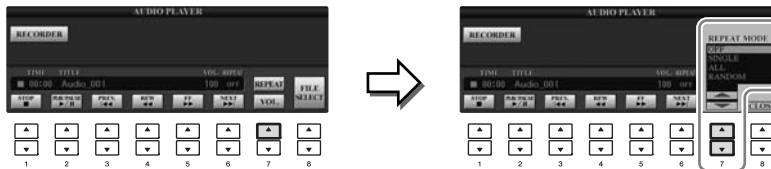

- OFF** Plays through the selected file, then stops.
- SINGLE** Plays through the selected file repeatedly.
- ALL** Continues playback through all the files in the folder containing the current file repeatedly.
- RANDOM** Randomly and repeatedly plays back all files in the folder containing the current file.

• Adjusting volume for audio playback

Press the [7 ▼] (VOL.) button then adjust the volume for audio files by using the [7 ▲▼] buttons. To close the setting display, press the [8 ▲▼] (CLOSE) button.

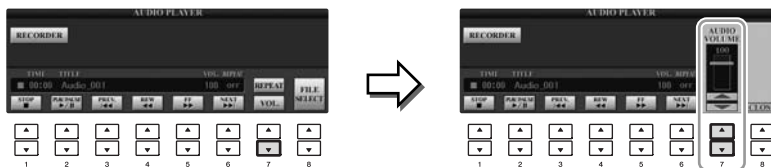

Recording Your Performance as Audio

CVP-509 CVP-505 CVP-503 CVP-501

Try recording your performance as audio data (WAV file) to a USB flash memory. For example, you can record an ensemble performance of guitar and keyboard together or record yourself singing along with song playback by connecting a guitar, microphone or other device to the instrument. The maximum amount of recording time is 80 minutes per recording, though this may differ depending on the capacity of the particular USB flash memory.

The following sounds can be recorded.

- Internal tone generator of the instrument.
Keyboard parts (Right 1, Right 2, Left), Song parts, Style parts.
- Input from a microphone, guitar or other instrument (via the [MIC./LINE IN] jack).
- Input from another audio device, such as a CD player, MP3 player or the like (via the [MIC./LINE IN] jack).

The recorded data using this function is saved as:

- Stereo WAV data
- 44.1 kHz sample rate/16 bit resolution

- 1** Connect the USB flash memory to the [USB TO DEVICE] terminal.
- 2** Set the desired Voice, etc. which you want to use for your performance. (For information setting the Voice, see page 37; for setting the Style, see page 48; for connecting a microphone, see page 102.)
- 3** Press the [USB] button.



- 4** Press the [E] (RECORDER) button to call up the Recording display (USB AUDIO RECORDER display).



NOTE

To record your performance by USB Audio function, use the compatible USB flash memory. Before using a USB flash memory, be sure to read "Connecting a USB Storage Device" on page 106.

NOTE

Input from the [AUX IN] jacks cannot be recorded.

NOTE

Songs protected by copyright, such as preset songs, and the metronome sound cannot be recorded. Moreover, the iAFC effect (CVP-509 only; page 34) does not affect the recording.

NOTE

Recording methods on the instrument include MIDI recording as well as audio recording (page 65).

NOTE

The USB storage device of "USB1" is selected as the recording destination when multiple USB storage devices are connected. The destination is skipped when "USB1" is a floppy disk drive.

Check the information of the USB flash memory as a recording destination

On the display of step 4, press the [E] (PROPERTY) button to check the number of the USB flash memory device, memory size of the device, available recording space on the device, and available time for recording.



Press the [F] (OK)/[EXIT] button to close the PROPERTY display.

5 Start recording by pressing the [J] (REC) button, then start your performance.

When recording begins, the elapsed recording time is shown on the right side of the Recording display.



6 Stop recording by pressing the [J] (STOP) button.

The file name is automatically named, and a message indicating the file name is displayed.



CAUTION

Never attempt to disconnect the USB flash memory or turn the power off during playback. Doing so may corrupt the USB flash memory data or the recording data.

NOTE

Even if you make a mistake in your performance, you cannot overwrite an existing file. Delete the recorded file on the File Selection display, then record your performance again.

NOTE

The recording operation continues, even if you close the Recording display by pushing the [EXIT] button. Press the [E] (RECORDER) button to call up the Recording display again, then stop the recording by pressing the [J] (STOP) button.

Mixing Console

– Editing the Volume and Tonal Balance –

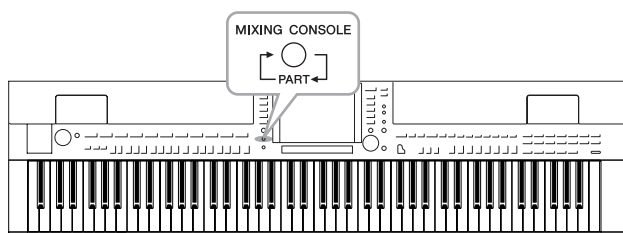

The Mixing Console gives you intuitive control over aspects of the keyboard parts and Song/Style channels, including volume balance and the timbre of the sounds. It lets you adjust the levels and stereo position (pan) of each Voice to set the optimum balance and stereo image, and lets you set how the effects are applied.

Basic Procedure

- 1 Press the [MIXING CONSOLE] button to call up the MIXING CONSOLE display.

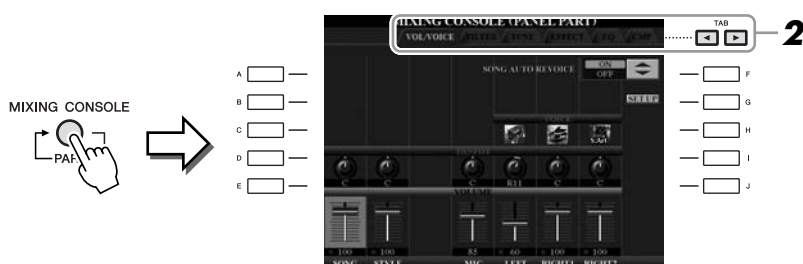

- 2 Use the TAB [◀][▶] buttons to call up the desired page.

For details about each display Page, refer to the Reference Manual on the website.

- **VOL/VOICE**

Changes the Voice for each part and adjusts panning and volume for each part (page 90). Using the Auto Revoice function, you can also convert the sound of commercially available XG song to the special sound using this instrument's special Voices.

- **FILTER**

Adjusts the Harmonic Content (resonance) and sound brightness.

- **TUNE**

Pitch-related settings (tuning, transpose, etc.).

- **EFFECT**

Selects effect type and adjusts its depth for each part (page 92).

- **EQ**

Adjusts equalization parameters to correct the tone or timbre of the sound.

- **CMP (CVP-509)**

This is the Master Compressor setting which determines the dynamics of overall sound. See page 93.

NOTE

The Master Compressor is not applied to USB audio playback and Metronome sound.

3 Press the [MIXING CONSOLE] button repeatedly to call up the MIXING CONSOLE display for the relevant parts.

The part name is indicated at the top of the display.

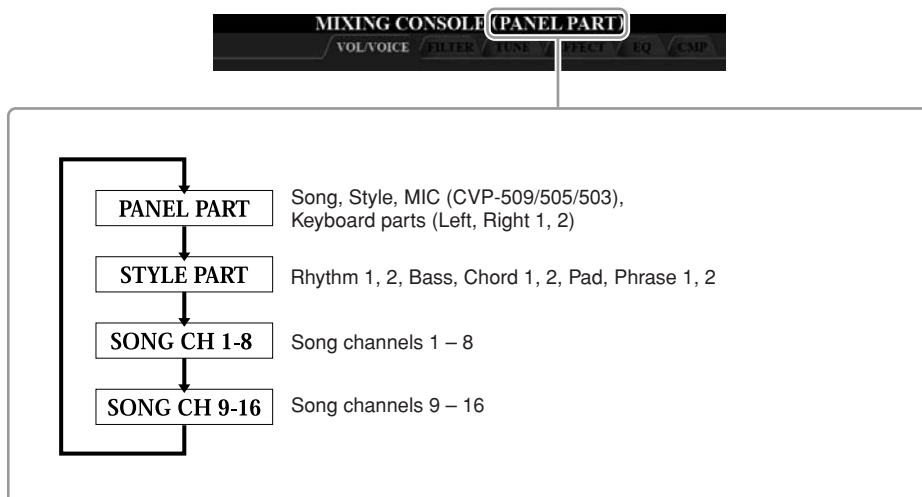

4 Use the [A] – [J] buttons to select a parameter, then use the [1 ▲▼] – [8 ▲▼] buttons to set the value for each part.

5 Save your MIXING CONSOLE settings.

• To save the PANEL PART display settings:

Register them to Registration Memory (page 79).

• To save the STYLE PART display settings:

Save them as Style data.

1. Call up the operation display.

[FUNCTION] → [F] DIGITAL REC MENU →

[B] STYLE CREATOR

2. Press the [EXIT] button to close the RECORD display.

3. Press the [I] (SAVE) button to call up the Style Selection display for saving your data, then save it (page 68).

• To save the SONG CH 1-8/9-16 display settings:

First register the edited settings as part of the Song data (SETUP), then save the Song.

1. Call up the operation display.

[FUNCTION] → [F] DIGITAL REC MENU →

[A] SONG CREATOR

2. Use the TAB [◀][▶] buttons to select the CHANNEL Page.

3. Use the [A]/[B] buttons to select “SETUP.”

4. Press the [D] (EXECUTE) button.

5. Press the [I] button to call up the Song Selection display for saving your data, then save it (page 68).

NOTE

The Style/Song part components are the same as those that appear in the display when you press the panel [CHANNEL ON/OFF] button once or twice.

NOTE

If you simultaneously hold down one of the [A] – [J] buttons and use the [1 ▲▼] – [8 ▲▼] buttons (or the DATA ENTRY dial), you can instantly set the same value to all other parts.

Changing Voices and Adjusting Panning/Volume for Each Part

You can change the Voice and adjust panning and volume for each keyboard part, Style channel or Song channel.

Changing the Voice for each part

1 Same operation as in the “Basic Procedure” on page 88. In step 2, select VOL/VOICE tab.

2 Press the [C] (or [H]) button to select the VOICE parameter.



3 Press one of the [1 ▲▼] – [8 ▲▼] buttons to select the desired part.

The Voice Selection display appears.

4 Select a Voice.

Press one of the Voice category selection buttons on the panel, then select a Voice by using the [A] – [J] buttons (page 37).

5 Press the [EXIT] button to return to the MIXING CONSOLE display.

6 Save your settings (step 5 on page 89).

NOTE

- Some Voices (such as Organ Flutes) cannot be selected for Style channels.
- The RHY2 channel in the STYLE PART display can only be assigned Drum kit Voices and SFX kit Voices.
- When playing GM Song data, channel 10 can only be used for a Drum kit Voice.

Adjusting Panning/Volume for each part

- 1 Same operation as in the “Basic Procedure” on page 88. In step 2, select VOL/VOICE tab.
- 2 Press the [D] (or [I]) button to select the PANPOT parameter or press the [E] (or [J]) button to select the VOLUME parameter.



- 3 Use the [1 ▲▼] – [8 ▲▼] buttons to adjust panning/volume for the desired part.
- 4 Save your settings (step 5 on page 89).

Applying Effects to Each Part

- 1 Same operation as in the “Basic Procedure” on page 88. In step 2, select EFFECT tab.



- 2 Use the [C]/[D]/[E] buttons to select the desired effect.

- **REVERB:**

Reproduce the warm ambience of playing in a concert hall or jazz club.

- **CHORUS:**

Produces a rich “fat” sound as if several parts are being played simultaneously.

- **DSP:**

By default, the most appropriate effect for the selected Voice has been selected.

- 3 Use the [1 ▲▼] – [8 ▲▼] buttons to adjust the depth of each effect for the desired part.

- 4 Save your settings (step 5 on page 89).

NOTE

You can change the effect type by pressing the [F] (TYPE) button. Refer to the Reference Manual.

Adjusting the Overall Volume Using the Master Compressor

CVP-509 CVP-505 CVP-503 CVP-501

Compressor is an effect commonly used to limit and compress the dynamics (softness/loudness) of an audio signal. For signals that vary widely in dynamics, such as vocals and guitar parts, it “squeezes” the dynamic range, effectively making soft sounds louder and loud sounds softer. When used with gain to boost the overall level, this creates a more powerful, more consistently high-level sound.

Editing Master Compressor Settings

Select the CMP tab in step 2 on page 88.

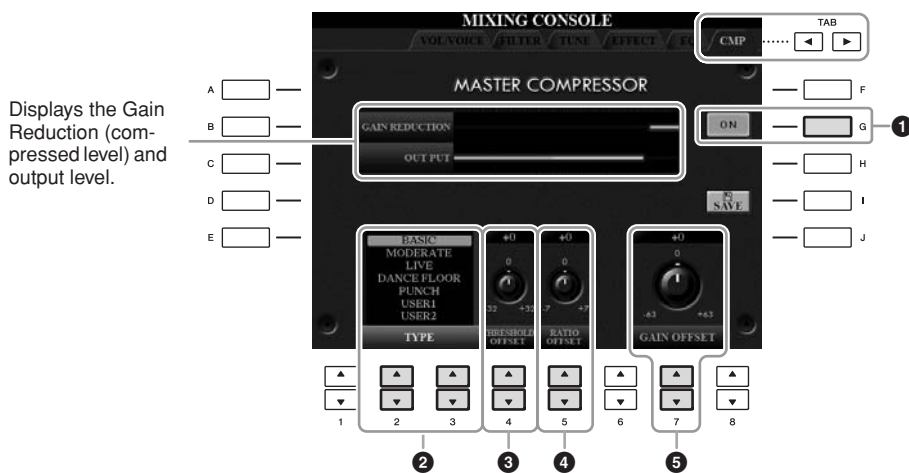

Displays the Gain Reduction (compressed level) and output level.

1	[G]	ON/OFF	Turns the Master Compressor effect on or off.
2	[2 ▲▼]/ [3 ▲▼]	TYPE	Selects a Master Compressor type.
3	[4 ▲▼]	THRESHOLD OFFSET	Determines the threshold (minimum level at which compression starts).
4	[5 ▲▼]	RATIO OFFSET	Determines the ratio of compression (how much the dynamic range is compressed).
5	[7 ▲▼]	GAIN OFFSET	Determines the output level.

Saving Master Compressor Settings

The Master Compressor settings you have edited on page 93 can be saved as the User Compressor type.

- 1 Press the [I] (SAVE) button to enter the USER MASTER COMPRESSOR display.

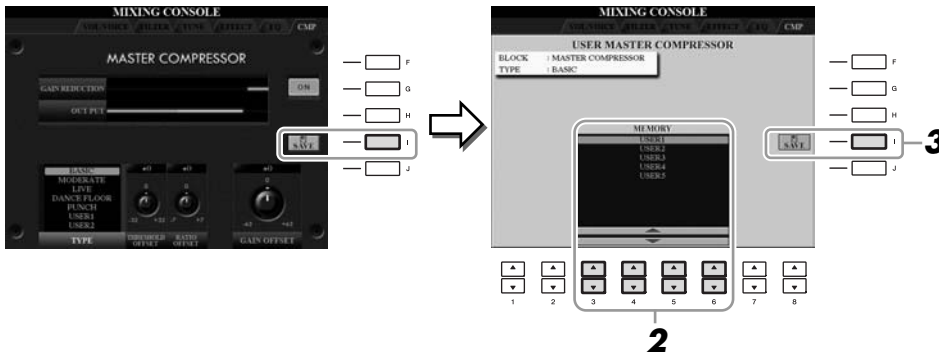

- 2 Select the destination to which the User Master compressor is to be stored, by using the [3 ▲▼] – [6 ▲▼] buttons.

- 3 Press the [I] (SAVE) button to open the SAVE display.

- 4 Enter the name of the edited Compressor type (page 27), then press the [8 ▲] (OK) button.

- 5 Press the [EXIT] button to return to the previous display.

The saved Compressor type is shown in the TYPE selection at the bottom left of the MASTER COMPRESSOR display and can be selected in the same way as the preset types.

Advanced Features

Refer to the Reference Manual on the website, **Chapter 8**.



Converting XG Song Voice to this instrument's Voice (Song Auto Revoice):

[MIXING CONSOLE] → TAB [◀|▶] VOL/VOICE → [G] SET UP

Editing FILTER parameters:

[MIXING CONSOLE] → TAB [◀|▶] FILTER

Editing TUNE parameters:

[MIXING CONSOLE] → TAB [◀|▶] TUNE

Changing an Effect type:

[MIXING CONSOLE] → TAB [◀|▶] EFFECT → [F] TYPE

Editing EQ parameters:

[MIXING CONSOLE] → TAB [◀|▶] EQ

Internet Direct Connection

– Connecting the Clavinova Directly to the Internet –

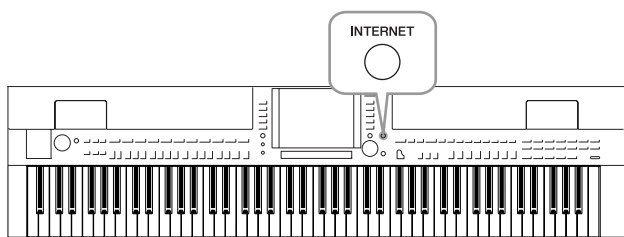

You can purchase and download Song data and other types of data from the special website by directly connecting to the Internet. This section provides the overview of the Internet Direct Connection. For specific instructions on connecting and Internet-related terms, refer to the Internet Connection Guide, which can be downloaded from the Yamaha Manual Library website.

Entering the Internet Direct Connection Function

Press the [INTERNET] button. If the instrument is connected to the Internet, the special website appears on the display. If it is not connected, first connect by referring to the section “Connecting the Instrument to the Internet” below.



To quit the Internet Direct Connection function and return to the operation display of the instrument, press the [EXIT] button.

Connecting the Instrument to the Internet

You can connect the instrument to a full-time online connection (ADSL, optical fiber, cable Internet, etc.) via a router or a modem equipped with a router. (To use the Internet connection, you will first need to subscribe to an Internet service or provider.) Use a computer to connect to the Internet and get online before connecting the instrument, since no modem or router settings can be made from the instrument itself.

The setting procedure differs depending on your connecting environment (devices for connection, etc.). For more information, refer to the Internet Connection Guide.

Viewing the Internet Connection Guide

You can view the Internet Connection Guide on the computer’s browser. (The computer must be connected to the internet.)

1 Access the Manual Library website on the computer browser.

Click “Manual Library” from the menu of included CD-ROM, or enter the following URL directly.

<http://www.yamaha.co.jp/manual/>

NOTE

Only the special website can be opened when the instrument is directly connected to the Internet.

NOTE

Depending on the Internet connection, the number of connectable devices may be limited. This may mean that your instrument cannot be connected to the Internet. If in doubt, check your contract or contact your provider.

- 2** Enter your model name (CVP-509, for example) in the Model Name area, then click “Search.”
- 3** Click “Internet Connection Guide” from Search Results.

Connection Examples

• Connection example 1:

Connecting by cable (using a LAN cable)

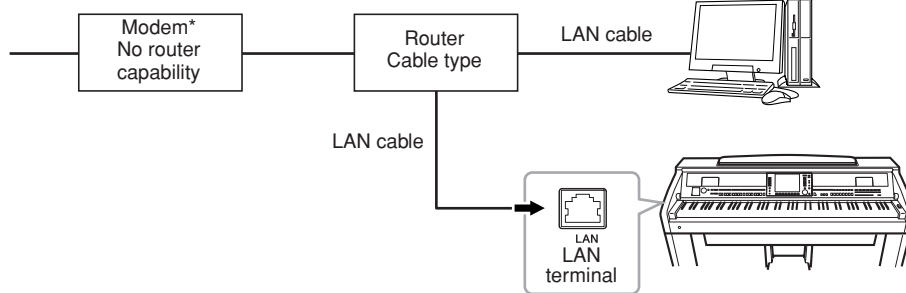

*Here, “modem” refers to an ADSL modem, optical network unit (ONU) or cable modem.

• Connection example 2:

Wireless connection (using a Wireless game adaptor)

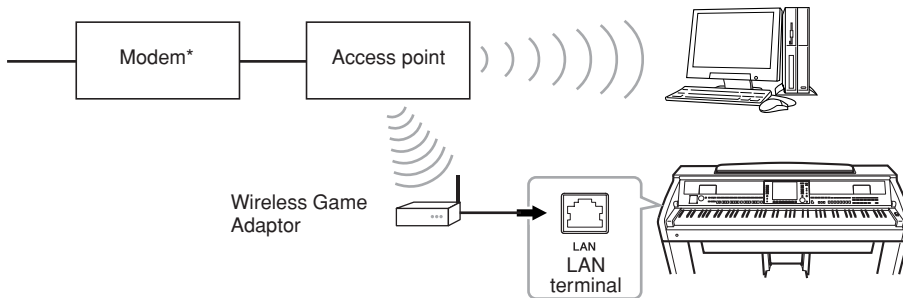

*Here, “modem” refers to an ADSL modem, optical network unit (ONU) or cable modem.

• Connection example 3:

Wireless connection (using a USB wireless LAN adaptor)

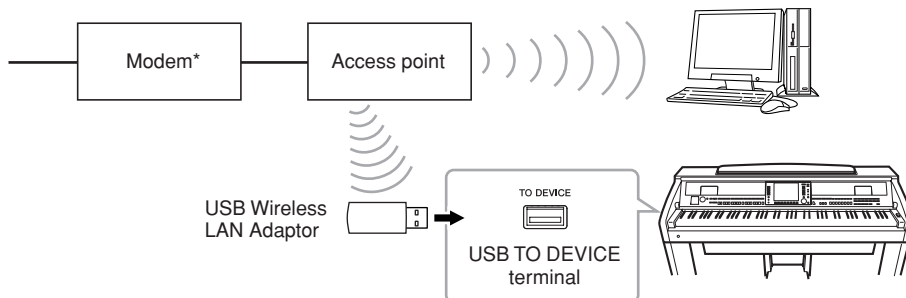

*Here, “modem” refers to an ADSL modem, optical network unit (ONU) or cable modem.

IMPORTANT

Due to EU/Korea regulations, users within Europe and Korea should use an STP (shielded twisted pair) cable to prevent electromagnetic interference.

NOTE

Some types of modems require an optional hub network for simultaneously connecting to several devices (such as computer, musical instrument, etc.).

NOTE

When you are using a modem with router, connect the instrument to the modem by LAN cable.

NOTE

(CVP-509/505) Two [USB TO DEVICE] terminals are provided: one on the panel and the other at the lower left of the keyboard.

Operations in the Special Website

After connecting the instrument to the internet, use these operations to take advantage of Internet services directly from the instrument.

Following Links

By using the [DATA ENTRY] dial and [ENTER] button, you can follow links and navigate through the website. You can also use the [6 ▼]/[7 ▲▼]/[8 ▼] buttons and the [8 ▲] (ENTER) button instead of the [DATA ENTRY] dial and [ENTER] button.

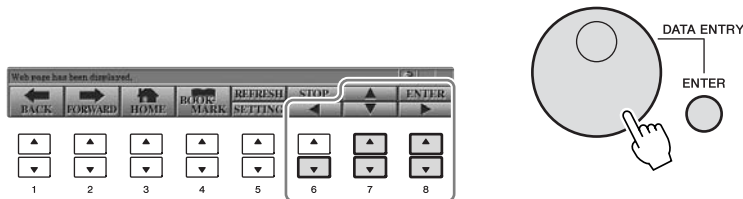

Return to the Previous Web Page/Refreshing a Web Page

Use the [1 ▲▼] (BACK)/[2 ▲▼] (FORWARD) buttons to navigate through previously selected web pages. You can also use the TAB [◀][▶] buttons instead of the [1 ▲▼] (BACK)/[2 ▲▼] (FORWARD) buttons. To return to the top page of the special website, press the [3 ▲▼] (HOME) button. Press the [5 ▲] (REFRESH) button to reload a web page and press the [6 ▲] (STOP) to cancel loading.

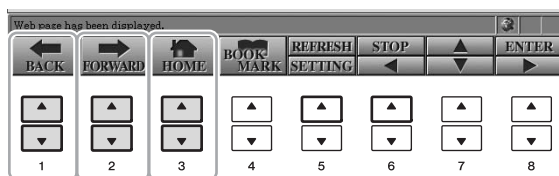

Monitoring the Internet Connection Status

The messages and icons at the bottom right of the Internet display indicate the current Internet connection status.

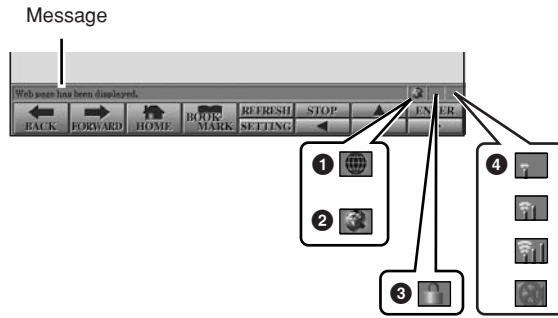

The following three messages are displayed according to the loading status of the web page.

Disconnected.: This appears when the instrument is not connected with the Internet. When this message is displayed, the web page cannot be seen. Icon ❶ is displayed.

Now opening web page...: The web page is being loaded. Icon ❷ flashes.

Web page has been displayed.: Loading of the web page is completed, and the page is displayed completely. Icon ❷ stops flashing. When the displayed web page uses SSL, icon ❸ is displayed, and information is encrypted for communication.

Strength of the reception is displayed in ❹ when connecting to the Internet by wireless LAN. When reception is weak, move the instrument near the access point to improve reception.

NOTE

SSL (Secure Sockets Layer) is an industry-standard method for protecting web communications by using data encryption and other tools.

Advanced Features

Refer to the Reference Manual on the website, **Chapter 9**.



Editing the Browser settings:

[INTERNET] → [5 ▼] SETTING → [D] BROWSER SETTINGS

Registering bookmarks of your favorite pages:

[INTERNET] → [4 ▲▼] BOOKMARK → [3 ▲▼] ADD

Connections

– Using Your Instrument with Other Devices –

CVP-509/505

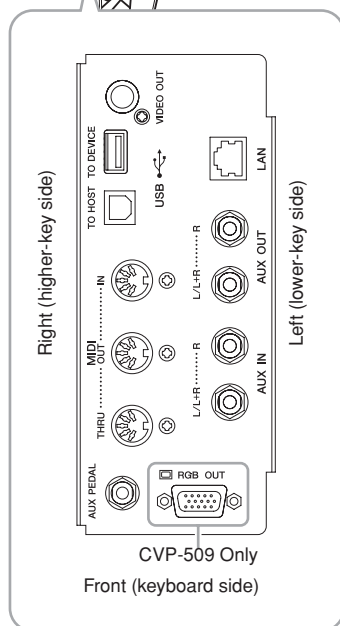

CVP-503/501

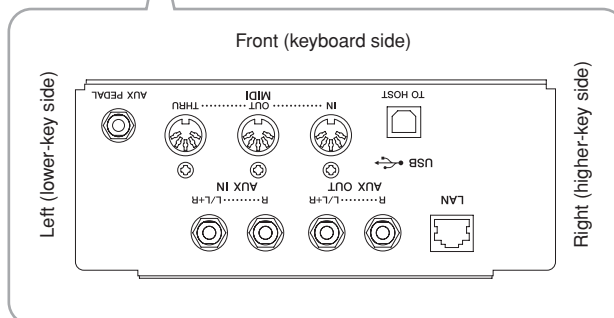
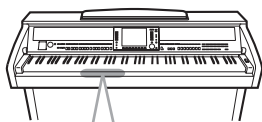

CAUTION

Before connecting the instrument to other electronic components, turn off the power of all the components. Also, before turning any components on or off, make sure to set all volume levels to minimum (0). Otherwise, electrical shock or damage to the components may occur.

Connecting Audio Devices

Using External Audio Devices for Playback

You can connect a stereo system to amplify the instrument's sound by using the AUX OUT [L/L+R]/[R] jacks. When using the CVP-509/505/503, the microphone or guitar sound connected to the instrument's [MIC./LINE IN] jack is output at the same time.

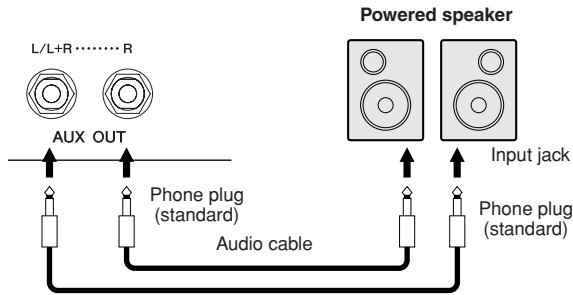

Playing External Audio Devices with the Built-in Speakers

You can connect the output jacks of an external device (such as CD player, tone generator, etc.) to the instrument's AUX IN [L/L+R]/[R] jacks, letting you hear the sound of that device through the built-in speakers of the instrument.

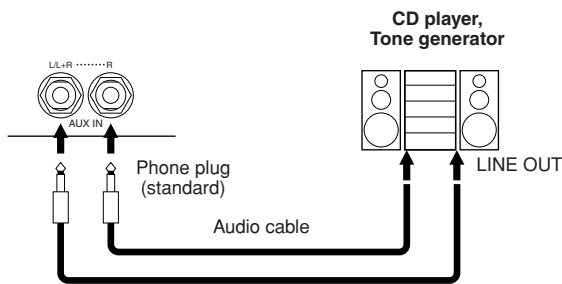

NOTE

Use audio cables and adaptor plugs having no (zero) resistance.

NOTE

Use only the [L/L+R] jack for connection with a monaural device.

CAUTION

When the instrument's sound is output to an external device, first turn on the power to the instrument, then to the external device. Reverse this order when you turn the power off.

CAUTION

Do not route the output from the [AUX OUT] jacks to the [AUX IN] jacks. If you make this connection, the signal input at the [AUX IN] jacks is output from the [AUX OUT] jacks. These connections could result in a feedback loop that will make normal performance impossible, and may even damage both pieces of equipment.

CAUTION

When the sound of an external device is output to the instrument, first turn on the power to the external device, then to the instrument. Reverse this order when you turn the power off.

NOTE

Use only the [L/L+R] jack for connection with a monaural device.

NOTE

The instrument's [MASTER VOLUME] setting affects the input signal from the [AUX IN] jacks.

Connecting an External Monitor

CVP-509 CVP-505 CVP-503 CVP-501

By connecting with a television using the [VIDEO OUT] jack of the instrument, the lyrics (Lyrics)/text (Text) on the instrument's display can be shown on the television. For CVP-509, the instrument can be connected with the external monitor also by the [RGB OUT] terminal. The [RGB OUT] terminal delivers higher resolution than the [VIDEO OUT] jack.

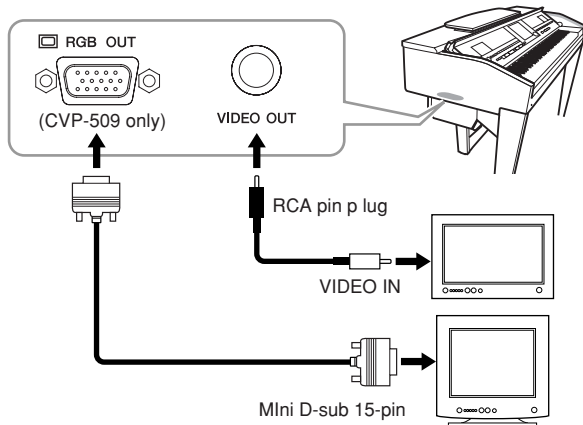

CAUTION

Avoid looking at the television or video monitor for prolonged period of time since doing so could damage your eyesight. Take frequent breaks and focus your eyes on distant objects to avoid eyestrain.

Screen Out Settings

- 1 Call up the operation display.
[FUNCTION] → [J] UTILITY → TAB [◀][▶] SCREEN OUT
- 2 Set the monitor type and screen contents.

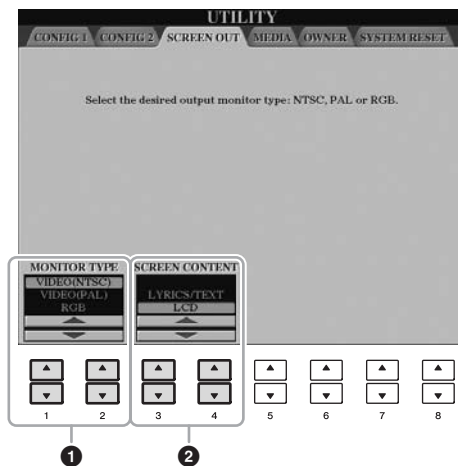

1	[1 ▲▼]/ [2 ▲▼]	MONITOR TYPE	Selects the desired output monitor type (NTSC or PAL) to correspond to the standard used by your video equipment. (In case of CVP-509) Select “RGB” when connecting to an external monitor.
2	[3 ▲▼]/ [4 ▲▼]	SCREEN CONTENT	Determines the contents of the Video Out signal. LYRICS/TEXT: Only the lyrics of the Song or text files are output, regardless of the display that is called up on the instrument. LCD: The currently selected display is output.

NOTE

(CVP-509) When NTSC is selected, the lower part of the screen might not be displayed.

Connecting a Microphone or Guitar

CVP-509 CVP-505 CVP-503 CVP-501

By connecting a microphone or guitar to the [MIC./LINE IN] jack (standard 1/4" phone jack), you can enjoy singing along with your own performance or playing guitar along with Song playback. The instrument outputs your vocals or guitar sounds through the built-in speakers. The following instructions show how to connect a microphone. Please note that when connecting a guitar or other devices of high output level, make sure to set the [MIC. LINE] switch to "LINE."

1 Set the [INPUT VOLUME] knob to the minimum position.

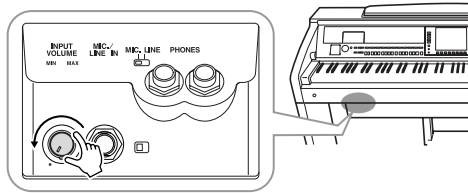

2 Connect the microphone to the [MIC./LINE IN] jack.

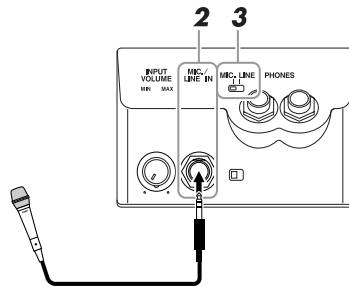

3 Set the [MIC. LINE] switch to "MIC."

4 (For microphones having a power source, turn on the power first.) Adjust the [INPUT VOLUME] knob while singing into the microphone.

Adjust the control while checking the SIGNAL and OVER lamps. The SIGNAL lamp lights to indicate that an audio signal is being received. Make sure to adjust the INPUT VOLUME so that this lamp is light. The OVER lamp lights when the input level is too high. Make sure to adjust the INPUT VOLUME so that this lamp does not light.

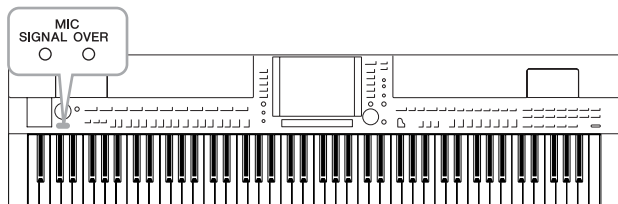

Disconnecting the microphone

1. Set the [INPUT VOLUME] knob to the minimum position.
2. Disconnect the microphone from the [MIC./LINE IN] jack.

NOTE

Make sure you have a conventional dynamic microphone.

NOTE

Always set the INPUT VOLUME to minimum when nothing is connected to the [MIC./LINE IN] jack. Since the [MIC./LINE IN] jack is highly sensitive, it may pick up and produce noise even when nothing is connected.

NOTE

Set the [INPUT VOLUME] knob to the minimum position before turning off the power.

Applying Effects to Your Voice

You can also apply various effects to your voice.

1 Call up the operation display.

[FUNCTION] → [G] MIC SETTING/VOCAL HARMONY

2 Use the [2 ▲▼] – [7 ▲▼] buttons to turn the effect on/off.

[2 ▲▼]/ [3 ▲▼]	TALK	Turning TALK on lets you temporarily cancel the microphone effects or vocal harmony. This is especially useful when you talk between songs during a performance.
[4 ▲▼]/ [5 ▲▼]	MIC EFFECT	Turning MIC EFFECT on applies an effect to your voice. The effect type can be selected in the Mixing Console display (page 92).
[6 ▲▼]/ [7 ▲▼]	VOCAL HARMONY	See below.

Adding Harmony Vocals to Your Voice

You can also automatically apply various harmony vocals to your voice.

1 Call up the operation display.

[FUNCTION] → [G] MIC SETTING/VOCAL HARMONY

2 Press the [6 ▲]/[7 ▲] buttons to turn the harmony vocals (Vocal Harmony) on.

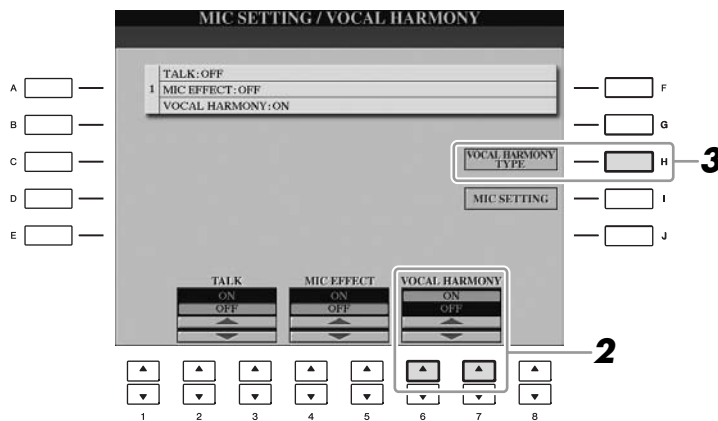

- 3 Press the [H] button to call up the Vocal Harmony selection display.
- 4 Select a Vocal Harmony type by using the [A] – [J] buttons.



- 5 Turn the [ACMP ON/OFF] button on.



- 6 Play and hold down chords in the left-hand section of the keyboard or play back a Song which contains chord data, as you sing along with it.

The harmony is applied to your voice according to the chord.

NOTE

You can adjust the volume balance between the keyboard performance and the microphone in the Balance display (page 58).

Advanced Features

Refer to the Reference Manual on the website, **Chapter 10**.



Microphone overall settings:	[FUNCTION] → [G] MIC SETTING/VOCAL HARMONY → [I] MIC SETTING → TAB [◀][▶] OVERALL SETTING
Talk settings:	[FUNCTION] → [G] MIC SETTING/VOCAL HARMONY → [I] MIC SETTING → TAB [◀][▶] TALK SETTING
Editing Vocal Harmony:	[FUNCTION] → [G] MIC SETTING/VOCAL HARMONY → [H] VOCAL HARMONY TYPE → [8 ▼] (EDIT)

Connecting a Footswitch/Foot Controller

Optional footswitches (Yamaha FC4 or FC5) and an optional Foot controller (Yamaha FC7) can be connected to the [AUX PEDAL] jack. A footswitch can be used for switching functions on and off, while a foot controller controls continuous parameter such as volume.

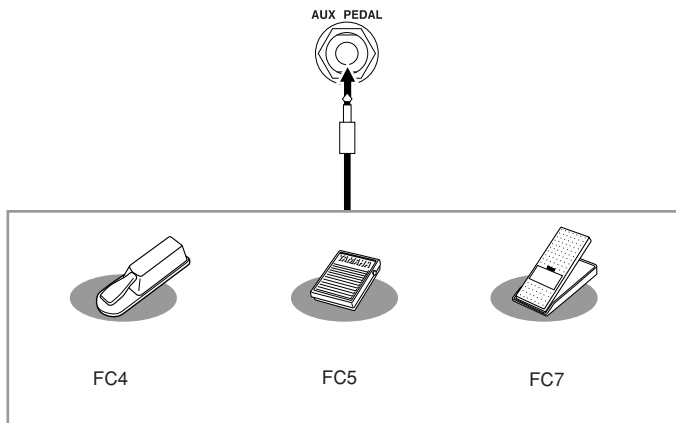

CAUTION

Make sure to connect or disconnect the pedal only when the power is off.

- **Example 1: Controlling the volume of the performance data played on the keyboard by the foot controller.**

Connect the FC7 foot controller to the [AUX PEDAL] terminal. With the initial factory settings, no special setup is necessary.

- **Example 2: Controlling Song Start/Stop by footswitch**

Connect a footswitch (FC4 or FC5) to the [AUX PEDAL] jack.

To assign the function to the connected pedal, select “SONG PLAY/PAUSE” in the operation display: [FUNCTION] → [D] CONTROLLER → TAB [◀][▶] PEDAL.

Advanced Features

Refer to the Reference Manual on the website, **Chapter 10**.



Assigning specific functions to each foot pedal:

[FUNCTION] → [D] CONTROLLER → TAB [◀][▶] PEDAL

Connecting a USB Storage Device

By connecting a USB storage device to the instrument's [USB TO DEVICE] terminal, you can save data you've created to the device.

Precautions when using the [USB TO DEVICE] terminal

When connecting a USB device to the terminal, be sure to handle the USB device with care. Follow the important precautions below.

NOTE

For more information about the handling of USB devices, refer to the owner's manual of the USB device.

Compatible USB devices

- USB storage devices (flash memory, floppy disk drive, hard disk drive, etc.)
- USB-LAN adaptor
- USB hub

The instrument does not necessarily support all commercially available USB devices. Yamaha cannot guarantee operation of USB devices that you purchase. Before purchasing a USB device for use with this instrument, please visit the following web page:

<http://music.yamaha.com/download/>

NOTE

Other USB devices such as a computer keyboard or mouse cannot be used.

Connecting a USB device

- When connecting a USB device to the [USB TO DEVICE] terminal, make sure that the connector on the device is appropriate and that it is connected in the proper direction.

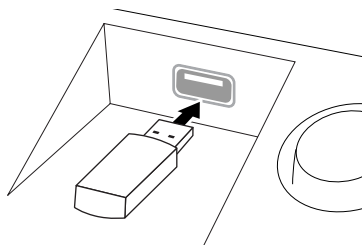

CAUTION

When connecting a USB device to the [USB TO DEVICE] terminal on the top panel, remove it before closing the key cover. If the key cover is closed with the USB device connected, the USB device may be damaged.

- If you intend to connect two or three devices at the same time to a terminal, you should use a USB hub device. The USB hub must be self-powered (with its own power source) and the power must be on. Only one USB hub can be used. If an error message appears while using the USB hub, disconnect the hub from the instrument, then turn on the power of the instrument and re-connect the USB hub.
- Though the instrument supports the USB 1.1 standard, you can connect and use a USB 2.0 storage device with the instrument. However, note that the transfer speed is that of USB 1.1.

Using USB Storage Devices

By connecting the instrument to a USB storage device, you can save data you've created to the connected device, as well as read data from the connected device.

NOTE

Although CD-R/RW drives can be used to read data to the instrument, they cannot be used for saving data.

The number of USB storage device to be used

Up to two USB storage devices can be connected to the [USB TO DEVICE] terminal. (If necessary, use a USB hub. The number of USB storage devices that can be used simultaneously with musical instruments even when a USB hub is used is a maximum of two.) This instrument can recognize up to four drives in one USB storage device.

Formatting USB storage media

When a USB storage device is connected or media is inserted, a message may appear prompting you to format the device/media. If so, execute the Format operation (page 107).

CAUTION

The format operation overwrites any previously existing data. Make sure that the media you are formatting does not contain important data. Proceed with caution, especially when connecting multiple USB storage media.

To protect your data (write-protect)

To prevent important data from being inadvertently erased, apply the write-protect provided with each storage device or media. If you are saving data to the USB storage device, make sure to disable write-protect.

Connecting/removing USB storage device

Before removing the media from the device, make sure that the instrument is not accessing data (such as in the Save, Copy and Delete operations).

CAUTION

Avoid frequently turning the power on/off to the USB storage device, or connecting/disconnecting the device too often. Doing so may result in the operation of the instrument "freezing" or hanging up. While the instrument is accessing data (such as during Save, Copy, Delete, Load and Format operations) or is mounting the USB storage device (shortly after the connection), do NOT unplug the USB connector, do NOT remove the media from the device, and do NOT turn the power off to either device. Doing so may corrupt the data on either or both devices.

Formatting a USB Storage Device

When a USB storage device is connected or media is inserted, a message may appear prompting you to format the device/media. If so, execute the format operation.

1 Insert a USB storage device for formatting into the [USB TO DEVICE].

2 Call up the operation display.

[FUNCTION] → [J] UTILITY → TAB [◀|▶] MEDIA

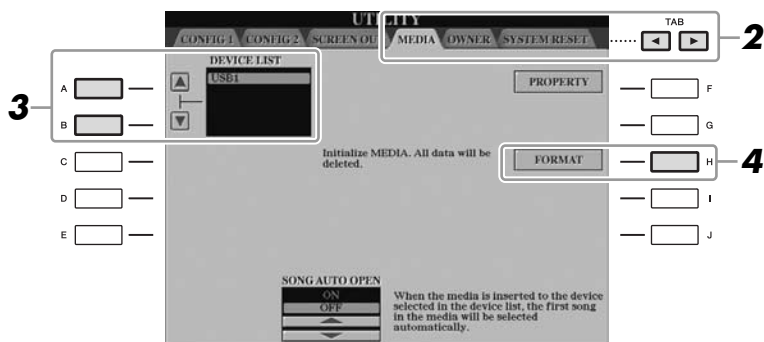

3 Press the [A]/[B] buttons to select the USB device to be formatted from the device list.

The indications USB 1, USB 2, etc. will be displayed depending on the number of the connected devices.

4 Press the [H] (FORMAT) button to format the device/media.

Confirming the remaining memory

You can check the remaining memory of the connected USB storage device by pressing the [F] (PROPERTY) button in step 4 above.

Connecting to the Internet

By using the [LAN] or [USB TO DEVICE] terminal, you can connect the instrument to the Internet. For instructions on connecting, refer to page 96 and Internet Connection Guide downloadable from the Yamaha website.

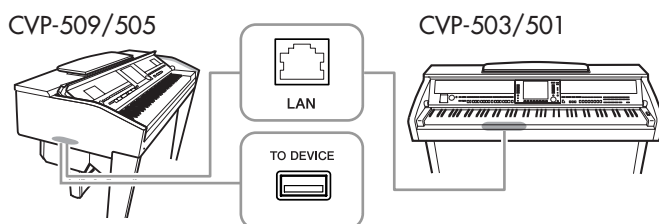

⚠ CAUTION

The format operation deletes any previously existing data. Make sure that the media you are formatting does not contain important data. Proceed with caution, especially when connecting multiple USB storage medias.

Connecting to a Computer

By connecting a computer to the [USB TO HOST] terminal, you can transfer data between the instrument and the computer via MIDI, and use the computer to control, edit and organize data on the instrument.

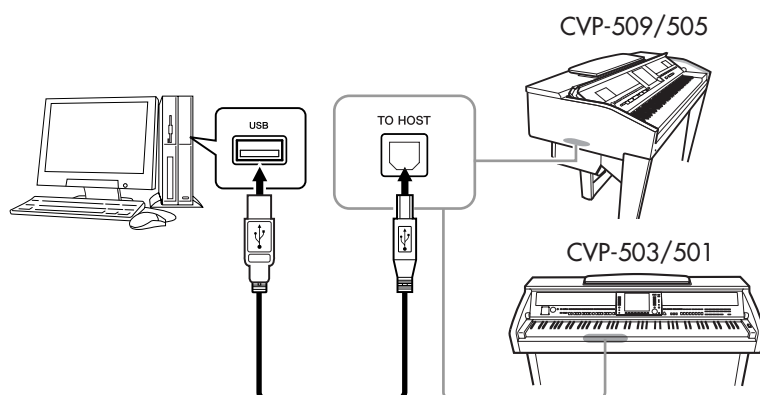

Precautions when using the [USB TO HOST] terminal

When connecting the computer to the [USB TO HOST] terminal, make sure to observe the following points. Failing to do so risks freezing the computer and corrupting or losing the data. If the computer or the instrument freezes, restart the application software or the computer OS, or turn the power to the instrument off then on again.

CAUTION

- Use an AB type USB cable of less than about 3 meters.
- Before connecting the computer to the [USB TO HOST] terminal, exit from any power-saving mode of the computer (such as suspend, sleep, standby).
- Before turning on the power to the instrument, connect the computer to the [USB TO HOST] terminal.
- Execute the following before turning the power to the instrument on/off or plugging/unplugging the USB cable to/from the [USB TO HOST] terminal.
 - Quit any open application software on the computer.
 - Make sure that data is not being transmitted from the instrument. (Data is transmitted only by playing notes on the keyboard or playing back a song.)
- While the computer is connected to the instrument, you should wait for six seconds or more between these operations: (1) when turning the power of the instrument off then on again, or (2) when alternately connecting/disconnecting the USB cable.

IMPORTANT

You need to install a USB-MIDI driver to connect the computer and the instrument. Refer to the separate Installation Guide.

NOTE

You can also use the MIDI IN/OUT terminals to connect to a computer. In this case, a MIDI interface (such as the Yamaha UX16) is needed. For more information, refer to the owner's manual of the MIDI interface.

NOTE

- The instrument will begin transmission a short time after the USB connection is made.
- When using a USB cable to connect the instrument to your computer, make the connection directly without passing through a USB hub.
- For information on setting up your sequence software, refer to the owner's manual of the relevant software.

Connecting External MIDI Devices

Use the [MIDI] terminals and standard MIDI cables to connect external MIDI devices (keyboard, sequencer, etc.).

- **MIDI IN**

Receives MIDI messages from another MIDI device.

- **MIDI OUT**

Transmits MIDI messages generated by the instrument to another MIDI device.

- **MIDI THRU**

Simply relays the MIDI messages received at MIDI IN.

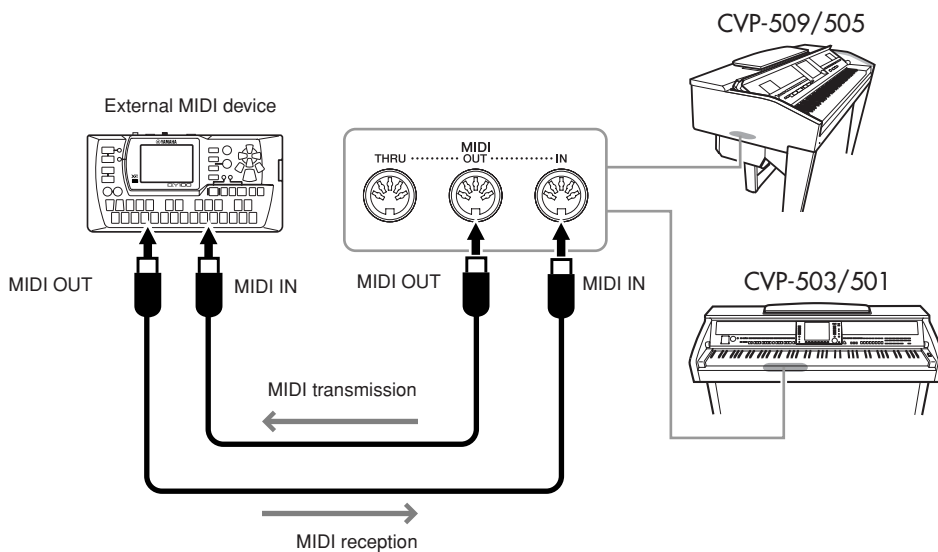

For detailed information about the instrument's MIDI settings, refer to the Reference Manual.

Advanced Features

Refer to the Reference Manual on the website, **Chapter 10**.



MIDI settings:

[FUNCTION] → [I] MIDI → [8 ▼] EDIT

NOTE

For a general overview of MIDI and how you can effectively use it, refer to "MIDI Basics" (downloadable from the Yamaha website).

Utility

– Making Global Settings –

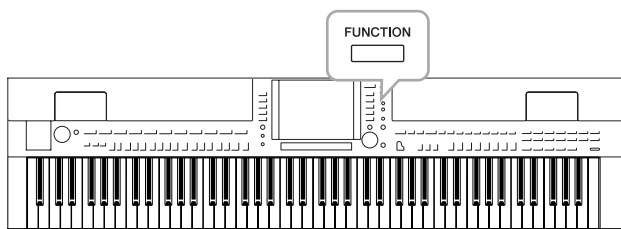

The Utility section in the Function menu provides a variety of convenient tools and settings for the instrument. These include general settings that affect the entire instrument, as well as detailed settings for specific functions. Also included are data reset functions and storage media control, such as media formatting.

Basic Procedure

1 Call up the operation display.

[FUNCTION] → [J] UTILITY

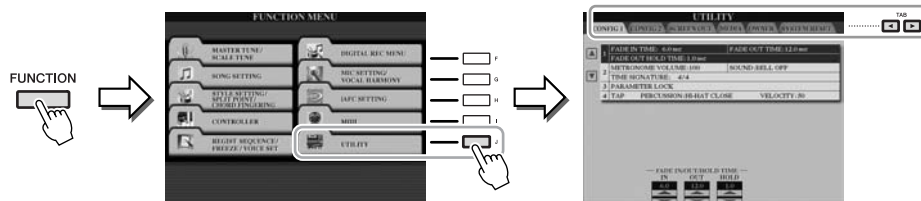

2 Use the TAB [◀][▶] buttons to call up desired page.

• CONFIG 1

General settings such as Fade in/out time, Metronome sound, Tap Tempo sound, etc.

• CONFIG 2

General settings such as speaker output, pop-up display time, etc.

• SCREEN OUT (CVP-509/505)

Monitor type and display content settings which are necessary when connecting a TV monitor (page 101).

• MEDIA

Settings related to a connected USB storage device, such as formatting (page 107) and confirmation of memory size.

• OWNER

Settings of Owner name (page 17) and Message language (page 17). Parameter setting backup/restore operations (page 29) can also be done in this page.

• SYSTEM RESET

Resets the settings of the instrument.

3 If necessary, use the [A]/[B] buttons to select the desired parameter.

4 Change the settings by using the [1 ▲▼] – [8 ▲▼] buttons or execute the operation by using the [A] – [J] buttons.

For details of the Utility settings, refer to the Reference Manual on the website.

CVP-509/505: Keyboard Stand Assembly

⚠ CAUTION

- Assemble the stand on a flat floor with ample space.
- Be careful not to confuse parts, and be sure to install all parts in the correct direction. Please assemble in accordance with the sequence given below.
- Assembly should be carried out by at least two persons.
- Be sure to use the correct screw size, as indicated below. Use of incorrect screws can cause damage.
- Be sure to tighten up all screws upon completing assembly of each unit.
- To disassemble, reverse the assembly sequence given below.

Have a Phillips-head (+) screwdriver of the appropriate size ready.



1 Remove all parts from the box. Confirm that all parts shown in the illustration are provided.

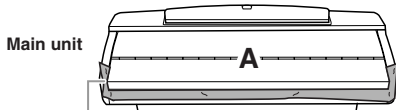

⚠ CAUTION

To prevent the key cover from accidentally opening during assembly, press down on the key cover, making sure that the sheet (shown) remains in place.

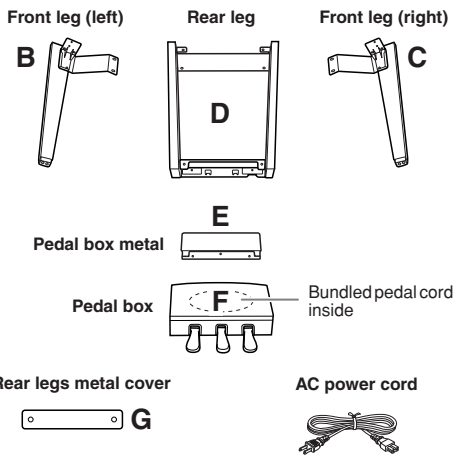

Assembly Parts

4 x 10 mm screws for the cover x 2



5 x 30 mm long screws x 4



Washers x 4



5 x 18 mm short screws x 10



Protective pads x 2

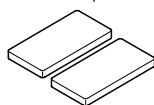

4 x 20 mm thin screws x 3



2 With the key cover closed, lean A against the wall.

- 1 Spread a large soft cloth, such as a blanket on the floor in front of the wall.
- 2 Place A on the cloth with the keyboard side turned to the wall.

⚠ CAUTION

- Be careful not to pinch your fingers.
- Do not lay the main unit upside-down on the floor.

Place the protection pads under the keyboard.

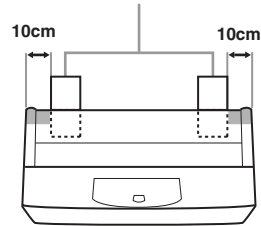

- 3 Raise A from the backside, and lean A against the wall with the keyboard side on the bottom.

⚠ CAUTION

- The top part of the music rest is not fixed. Support the music rest with your hand so that the music rest will not fall.
- Do not place the main unit with the rear side facing down.

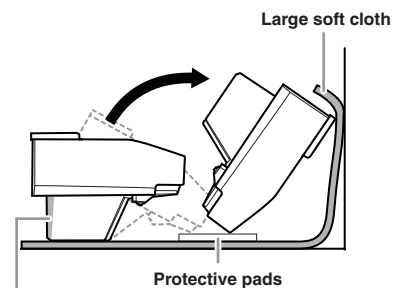

⚠ CAUTION

Please do not touch the speaker net. Doing so may damage the speaker inside.

3 Attach B and C to A.

- 1 Align parts B and A so that the protrusion fits into the hole.

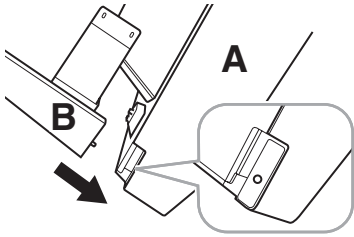

- 2 Fix the bottom surface of the unit using two long screws.

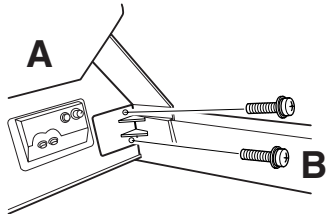

Attach the parts, pressing B onto A so that the two fit tightly together.

- 3 Fix the side of the speaker box using two short screws.

If the screw holes do not align, loosen the other screws and adjust the position of B.

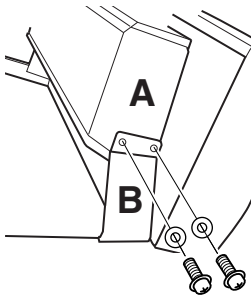

Tighten the screws after attaching the washers to the short screws.

- 4 Fix C in the same way.

4 Fix E to D using two short screws.

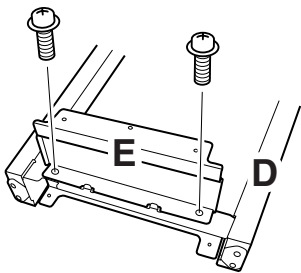

5 Attach D to A.

- 1 Fix D to the bottom surface of A using two short screws.

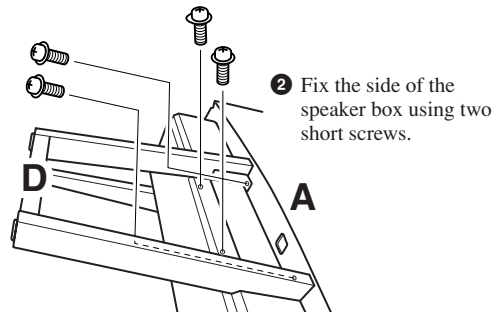

- 2 Fix the side of the speaker box using two short screws.

If the screw holes do not align, loosen the other screws and adjust the position of D.

6 Raise A to the standing position.

Use the front legs as support to raise A.

CAUTION

- Be careful not to pinch your fingers.
- When you raise the unit, do not hold the key cover.

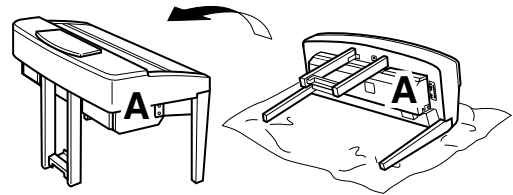

7 Install F.

- 1 Remove the plastic cover from D.

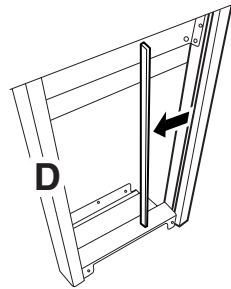

- 2 Untie and straighten out the bundled cord attached to the bottom of F.

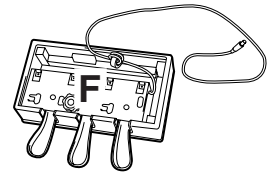

- 3 Pass the pedal cord from under D to the backside of A.

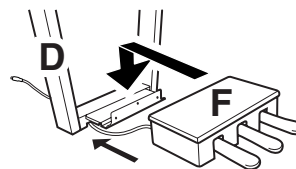

- 4 Attach F.

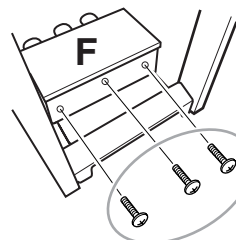

Use three thin screws.

8 Connect the pedal cord.

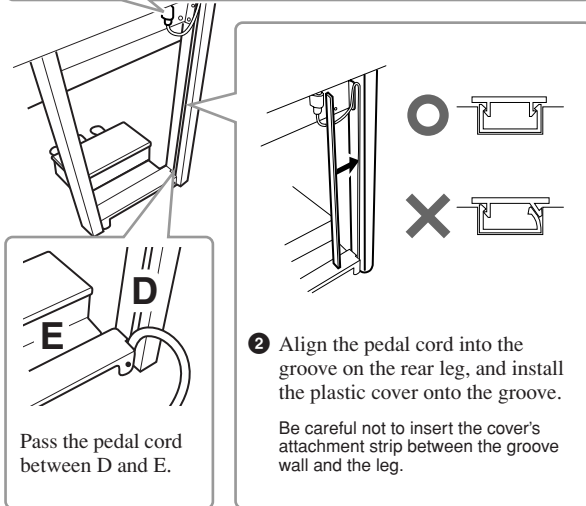
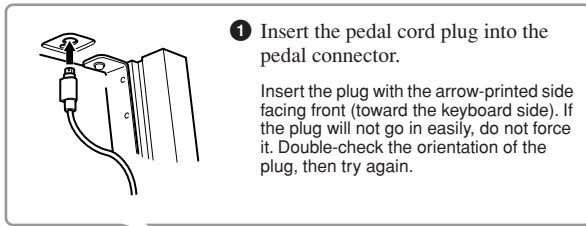

9 Attach G using two screws for the cover.

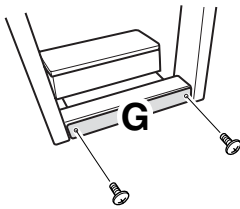

10 Set the voltage selector and connect the power cord.

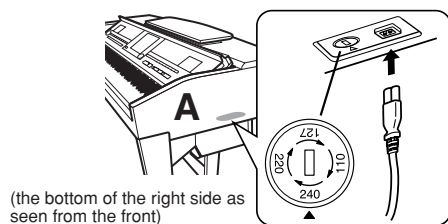

Voltage Selector

Before connecting the AC power cord, check the setting of the voltage selector which is provided in some areas. To set the selector for 110V, 127V, 220V or 240V main voltages, use a "minus" screwdriver to rotate the selector dial so that the correct voltage for your region appears next to the pointer on the panel. The voltage selector is set at 240V when the unit is initially shipped. After the proper voltage has been selected, connect the AC power cord to the AC INLET and an AC wall outlet. A plug adaptor may be also provided in some areas to match the pin configuration of the AC wall outlets in your area.

⚠ WARNING

An improper voltage setting can cause serious damage to the instrument or result in improper operation.

11 Set the adjuster.

Rotate the adjuster until it comes in firm contact with the floor surface.

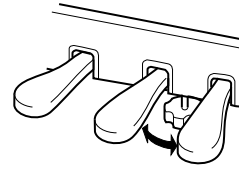

After completing the assembly, please check the following.

- **Are there any parts left over?**
→ Review the assembly procedure and correct any errors.
- **Is the instrument clear of doors and other movable fixtures?**
→ Move the instrument to an appropriate location.
- **Does the instrument make a rattling noise when you shake it?**
→ Tighten all screws.
- **Does the pedal box rattle or give way when you step on the pedals?**
→ Turn the adjuster so that it is set firmly against the floor.
- **Are the pedal and power cords inserted securely into the sockets?**

If the main unit creaks or is otherwise unsteady when you play on the keyboard, refer to the assembly diagrams and retighten all screws.

When moving the instrument after assembly, always hold the bottom of the main unit.

⚠ CAUTION

Do not hold the key cover or top portion. Improper handling can result in damage to the instrument or personal injury.

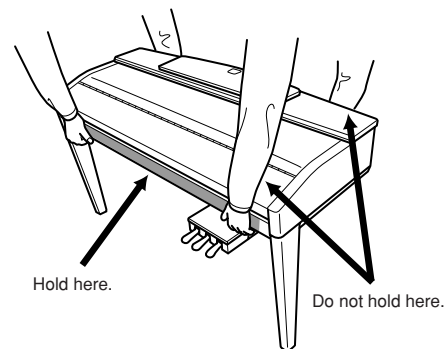

CVP-503: Keyboard Stand Assembly

⚠ CAUTION

- Assemble the stand on a hard and flat floor with ample space.
- Be careful not to confuse parts, and be sure to install all parts in the correct direction. Please assemble in accordance with the sequence given below.
- Assembly should be carried out by at least two persons.
- Be sure to use the correct screw size, as indicated below. Use of incorrect screws can cause damage.
- Be sure to tighten up all screws upon completing assembly of each unit.
- To disassemble, reverse the assembly sequence given below.

Have a Phillips-head (+) screwdriver of the appropriate size ready.

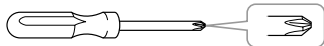

1 Open the package, take out marked “C” in the illustration, take out the styrofoam pads, and place the unit A on top of the pads.

Position the pads so that they will protect the headphone jack located underneath the front left corner.

⚠ CAUTION

To prevent the key cover from accidentally opening during assembly, press down on the key cover, making sure that the sheet (shown) remains in place.

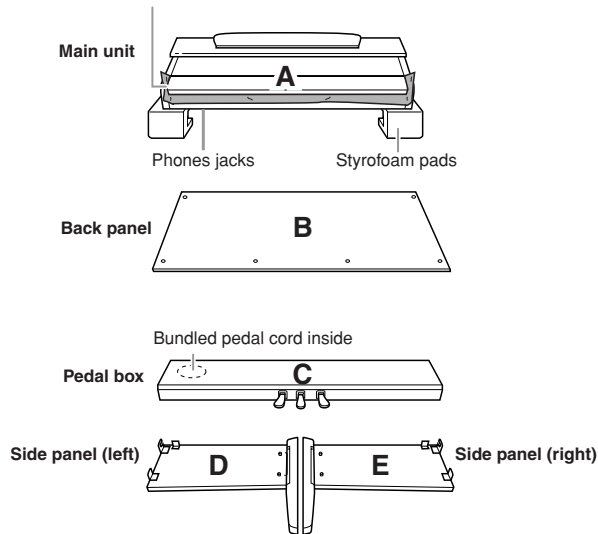

Assembly Parts

6 x 25 mm long screws x 4 	4 x 20 mm tapping screws x 4
6 x 16 mm short screws x 4 	Cord holders x 2
4 x 12 mm thin screws x 2 	

2 Attach C to D and E.

- 1 Untie and straighten out the bundled cord attached to the bottom of the C. Don't discard the vinyl tie, you'll need it later in step 6.

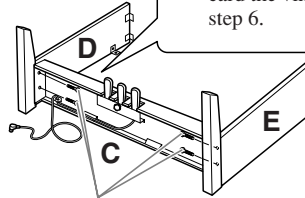

- 2 Use the four 6 x 25 mm long screws to attach C. First attach one side panel, then attach the other side panel.

3 Attach B.

Depending on the model of digital piano you purchased, the surface color of one side of the rear panel may be different from the other side. In this case, position the rear panel so that the side of the surface color similar to the side panel (left) and the side panel (right) faces the player.

- 1 Place the lower side of B on each foot of D and E, then attach the upper side to D and E.
- 2 Attach the top of B to D and E by finger-tightening the thin screws (4 x 12mm).
- 3 While pushing the lower part of D and E from outside, secure the bottom ends of B using two tapping screws (4 x 20mm).
- 4 Insert the other two tapping screws (4 x 20mm) into the other two screw holes to secure B.
- 5 Securely tighten the screws on the top of B that were attached in Step 3-2).

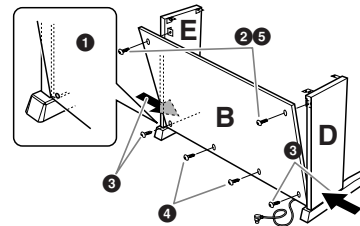

4 Mount A.

⚠ CAUTION

- Fingers can become pinched between A and C/D/E, be extra careful so as not to drop A.
- Do not hold the keyboard in any position other than the position shown in the illustration.

Be sure to place your hands at least 10 cm from either end of A when positioning it.

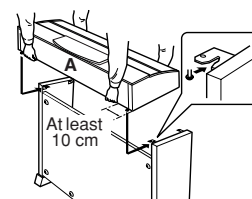

5 Fix A.

- 1 Center A to produce equal clearance on the left and right sides.
- 2 Use 6 x 16 mm short screws to secure A from the front.

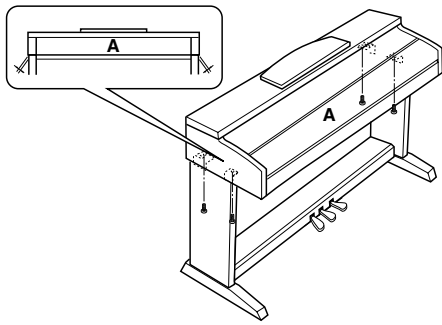

6 Connect the pedal cord.

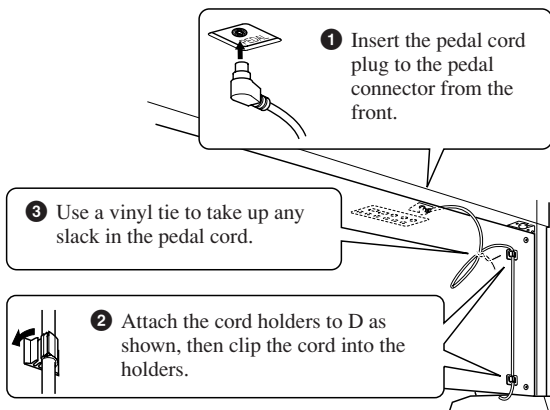

7 Set the voltage selector and connect the power cord.

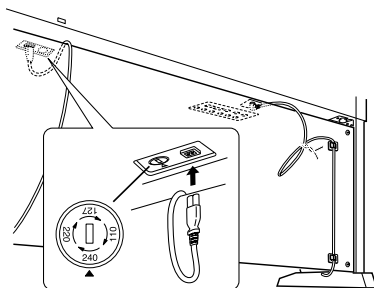

Voltage Selector

Before connecting the AC power cord, check the setting of the voltage selector which is provided in some areas. To set the selector for 110V, 127V, 220V or 240V main voltages, use a “minus” screwdriver to rotate the selector dial so that the correct voltage for your region appears next to the pointer on the panel. The voltage selector is set at 240V when the unit is initially shipped.

After the proper voltage has been selected, connect the AC power cord to the AC INLET and an AC wall outlet. A plug adaptor may be also provided in some areas to match the pin configuration of the AC wall outlets in your area.

⚠ WARNING

An improper voltage setting can cause serious damage to the instrument or result in improper operation.

8 Set the adjuster.

Rotate the adjuster until it comes in firm contact with the floor surface.

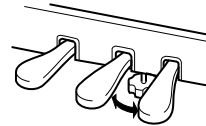

After completing the assembly, please check the following.

- Are there any parts left over?
→ Review the assembly procedure and correct any errors.
- Is the Clavinova clear of doors and other movable fixtures?
→ Move the Clavinova to an appropriate location.
- Does the Clavinova make a rattling noise when you shake it?
→ Tighten all screws.
- Does the pedal box rattle or give way when you step on the pedals?
→ Turn the adjuster so that it is set firmly against the floor.
- Are the pedal and power cords inserted securely into the sockets?

If the main unit creaks or is otherwise unsteady when you play on the keyboard, refer to the assembly diagrams and retighten all screws.

When moving the instrument after assembly, always hold the bottom of the main unit.

⚠ CAUTION

Do not hold the key cover or top portion. Improper handling can result in damage to the instrument or personal injury.

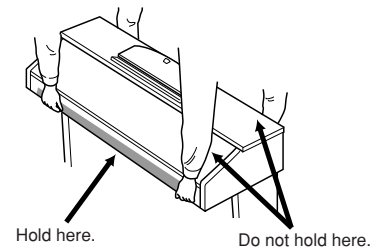

CVP-501: Keyboard Stand Assembly

⚠ CAUTION

- Assemble the stand on a hard and flat floor with ample space.
- Be careful not to confuse parts, and be sure to install all parts in the correct direction. Please assemble in accordance with the sequence given below.
- Assembly should be carried out by at least two persons.
- Be sure to use the correct screw size, as indicated below. Use of incorrect screws can cause damage.
- Be sure to tighten up all screws upon completing assembly of each unit.
- To disassemble, reverse the assembly sequence given below.

Have a Phillips-head (+) screwdriver of the appropriate size ready.

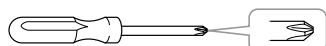

1 Open the package, take out marked "C" in the illustration, take out the styrofoam pads, and place the unit A on top of the pads.

Remove all parts from the box. Confirm that all parts shown in the illustration are provided.

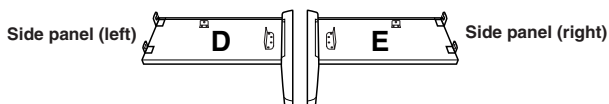
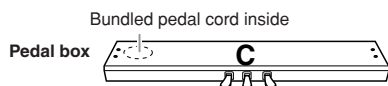
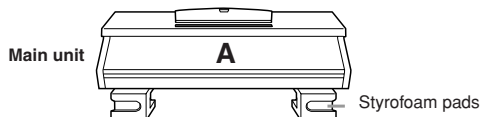

Assembly Parts

6 x 20 mm long screws x 4



4 x 20 mm tapping screws x 4



6 x 16 mm short screws x 4



Cord holders x 2



4 x 12 mm thin screws x 2



2 Attach (finger-tighten) C to D and E.

- 1 Untie and straighten out the bundled pedal cord. Don't discard the vinyl tie, you'll need it later in step 7.
- 2 Align D and E with each end of C.
- 3 Attach D and E to C by finger-tightening the long screws (6 x 20 mm).

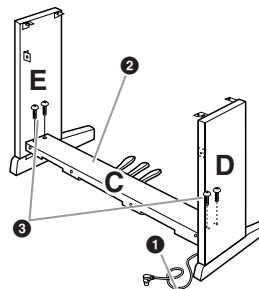

3 Attach B.

Depending on the model of digital piano you purchased, the surface color of one side of the rear panel may be different from the other side. In this case, position the rear panel so that the side of the surface color similar to the side panel (left) and the side panel (right) faces the player.

- 1 Place the lower side of B on each foot of D and E, then attach the upper side to D and E.
- 2 Attach the top of B to D and E by finger-tightening the thin screws (4 x 12mm).
- 3 While pushing the lower part of D and E from outside, secure the bottom ends of B using two tapping screws (4 x 20mm).
- 4 Insert the other two tapping screws (4 x 20mm) into the other two screw holes to secure B.
- 5 Securely tighten the screws on the top of B that were attached in Step 3- 2).

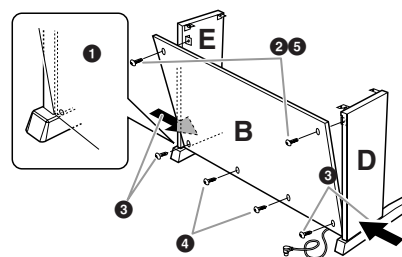

4 Securely tighten the screws on C that were attached in Step 2-3.

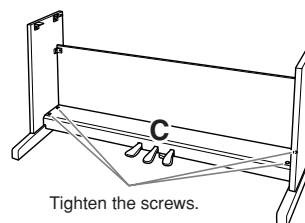

Tighten the screws.

5 Mount A.

CAUTION

- Fingers can become pinched between A and rear or side panels, be extra careful so as not to drop A.
- Do not hold the keyboard in any position other than the position shown in the illustration.

Be sure to place your hands at least 10 cm from either end of A when positioning it.

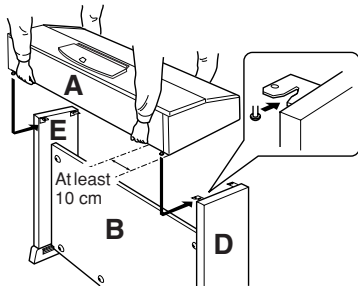

6 Secure A.

- 1 Center A to produce equal clearance on the left and right sides.



- 2 Use 6 x 16 mm short screws to secure A from the front.

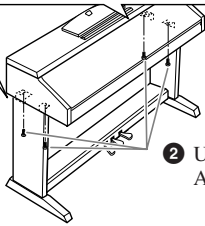

7 Connect the pedal cord.

- 1 Insert the pedal cord plug to the pedal connector from the rear.



- 2 Use a vinyl tie to take up any slack in the pedal cord.

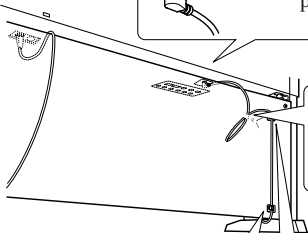

- 3 Attach the cord holders to the rear panel as shown, then clip the cord into the holders.



8 Set the voltage selector and connect the power cord.

Voltage Selector

Before connecting the AC power cord, check the setting of the voltage selector which is provided in some areas. To set the selector for 110V, 127V, 220V or 240V main voltages, use a "minus" screwdriver to rotate the selector dial so that the correct voltage for your region appears next to the pointer on the panel. The voltage selector is set at 240V when the unit is initially shipped.

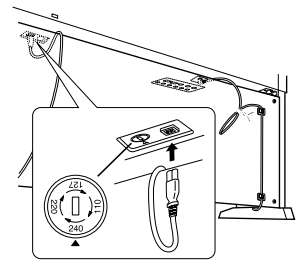

After the proper voltage has been selected, connect the AC power cord to the AC INLET and an AC wall outlet. A plug adaptor may be also provided in some areas to match the pin configuration of the AC wall outlets in your area.

WARNING

An improper voltage setting can cause serious damage to the Clavinova or result in improper operation.

9 Set the adjuster.

Rotate the adjuster until it comes in firm contact with the floor surface.

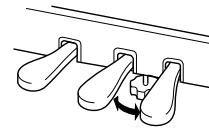

After completing the assembly, please check the following.

- Are there any parts left over?
→ Review the assembly procedure and correct any errors.
- Is the Clavinova clear of doors and other movable fixtures?
→ Move the Clavinova to an appropriate location.
- Does the Clavinova make a rattling noise when you shake it?
→ Tighten all screws.
- Does the pedal box rattle or give way when you step on the pedals?
→ Turn the adjuster so that it is set firmly against the floor.
- Are the pedal and power cords inserted securely into the sockets?

If the main unit creaks or is otherwise unsteady when you play on the keyboard, refer to the assembly diagrams and retighten all screws.

When moving the instrument after assembly, always hold the bottom of the main unit.

CAUTION

Do not hold the key cover or top portion. Improper handling can result in damage to the instrument or personal injury.

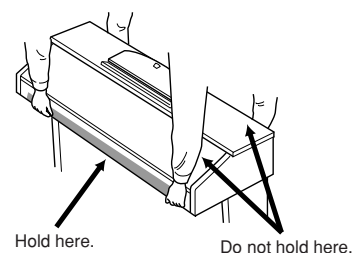

Installing the Floppy Disk Drive (Optional) (CVP-509/505)

The floppy disk drive can be installed to the bottom of the instrument by using the included floppy disk drive case and screws.

For a list of optional floppy disk drives available for this instrument, see “Optional Accessories” (page 127).

Have a Phillips-head (+) screwdriver of the appropriate size ready.

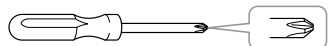

- 1 Remove the three backing papers from the adhesive tape in the case, and fit the floppy disk drive into the case.**

Insert the drive to the case, with the side having the rubber stoppers facing the case.

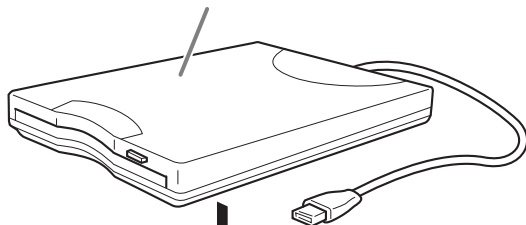

Dual-sided adhesive tape

- 2 Fold the USB cable inside the case as shown.**

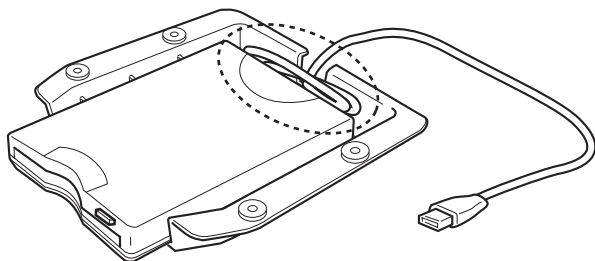

- 3 Attach the drive and case assembly to the left underside of the instrument, using the included four screws (4mm x 10mm).**

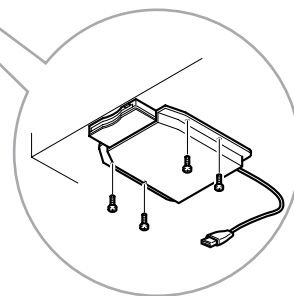
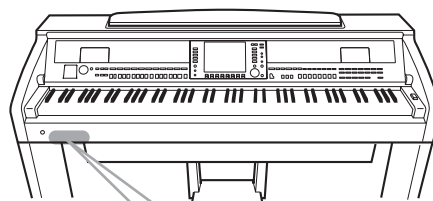

- 4 Connect the USB cable to the [USB TO DEVICE] terminal.**

Handling the Floppy Disk Drive (FDD) and Floppy Disks

(The floppy disk drive is optional. For instructions on installing the floppy disk drive, see page 127.)

The floppy disk drive lets you save original data you've created on the instrument to floppy disk, and allows you to load data from floppy disk to the instrument.

Be sure to handle floppy disks and treat the disk drive with care. Follow the important precautions below.

Floppy Disk Compatibility

3.5" 2DD and 2HD type floppy disks can be used.

Formatting a Floppy Disk

If you find that you are unable to use new, blank disks or old disks that have been used with other devices, you may need to format them. For details on how to format a disk, see page 107. Keep in mind that all data on the disk will be lost after formatting. Make sure to check beforehand whether or not the disk contains important data.

NOTE

Floppy disks formatted on this device may or may not be useable as is on other devices.

Inserting/Removing Floppy Disks

Inserting a Floppy Disk into the Disk Drive:

Hold the disk so that the label of the disk is facing upward and the sliding shutter is facing forward, towards the disk slot. Carefully insert the disk into the slot, slowly pushing it all the way in until it clicks into place and the eject button pops out.

CAUTION

Never insert anything but floppy disks into the disk drive. Other objects may cause damage to the disk drive or floppy disks.

Removing a Floppy Disk

After checking that the instrument is not accessing* the floppy disk (checking that the use lamp on the floppy disk drive is off), firmly press the eject button at the upper right of the disk slot all the way in. When the floppy disk is ejected, pull it out of the drive. If the floppy disk cannot be removed because it is stuck, do not try to force it, but instead try pressing the eject button again, or try re-inserting the disk and attempt to eject it again.

* Access of the disk indicates an active operation, such as recording, playback, or deletion of data.

If a floppy disk is inserted while the power is on, the disk is automatically accessed, since the instrument checks whether the disk has data.

CAUTION

Do not remove the floppy disk or turn off the instrument itself while the disk is being accessed. Doing so may result not only in loss of data on the disk but also damage to the floppy disk drive.

Be sure to remove the floppy disk from the disk drive before turning off the power. A floppy disk left in the drive for extended periods can easily pick up dust and dirt that can cause data-read and -write errors.

Cleaning the Disk Drive Read/Write Head

- Clean the read/write head regularly. This instrument employs a precision magnetic read/write head which, after an extended period of use, will pick up a layer of magnetic particles from the disks used that will eventually cause read and write errors.
- To maintain the disk drive in optimum working order Yamaha recommends that you use a commercially-available dry-type head cleaning disk to clean the head about once a month. Ask your Yamaha dealer about the availability of proper head cleaning disks.

About Floppy Disks

Handle floppy disks with care, and follow these precautions:

- Do not place heavy objects on a disk or bend or apply pressure to the disk in any way. Always keep floppy disks in their protective cases when they are not in use.
- Do not expose the disk to direct sunlight, extremely high or low temperatures, or excessive humidity, dust or liquids.
- Do not open the sliding shutter and touch the exposed surface of the floppy disk inside.
- Do not expose the disk to magnetic fields, such as those produced by televisions, speakers, motors, etc., since magnetic fields can partially or completely erase data on the disk, rendering it unreadable.
- Never use a floppy disk with a deformed shutter or housing.
- Do not attach anything other than the provided labels to a floppy disk. Also make sure that labels are attached in the proper location.

To Protect Your Data (Write-protect Tab):

To prevent accidental erasure of important data, slide the disk's write-protect tab to the "protect" position (tab open). When saving data, make sure that the disk's write-protect tab is set to the "overwrite" position (tab closed).

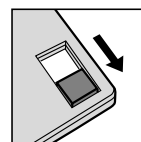
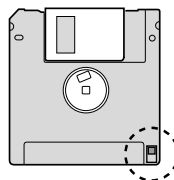

Write-protect tab
ON
(locked or write
protected)

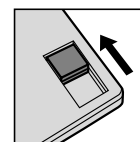

Write-protect tab
OFF
(unlocked or write
enabled)

Data Back up

For maximum data security Yamaha recommends that you keep two copies of important data on separate floppy disks.

Troubleshooting

Overall	
A click or pop is heard when the power is turned on or off.	Electrical current is being applied to the instrument. This is normal.
Noise is heard from the instrument's speakers.	Noise may be heard if a mobile phone is used near the instrument or if the phone is ringing. Turn off the mobile phone, or use it further away from the instrument.
In the LCD display, there are some black points (unlit) or white points (always lit).	(CVP-509/505) These are the result of defective pixels and occasionally occur in TFT-LCDs; they do not indicate a problem in operation.
There is a slight difference in sound quality among different notes played on the keyboard.	This is normal and is a result of the instrument's sampling system.
Some Voices have a looping sound.	
Some noise or vibrato is noticeable at higher pitches, depending upon the Voice.	
The overall volume is too low, or, no sound is heard.	The master volume may be set too low. Set it to an appropriate level with the [MASTER VOLUME] dial.
	All keyboard parts are set to off. Use the PART ON/OFF [RIGHT 1]/[RIGHT 2]/[LEFT] button to turn it on.
	The volume of the individual parts may be set too low. Raise the volume in the BALANCE display (page 58).
	Make sure the desired channel is set to ON (pages 57, 64).
	Headphones are connected, disabling the speaker output. Unplug the headphones.
	If the speaker is set to OFF. Make sure the speaker setting is set to ON (page 110). For details, refer to the Reference Manual on the website.
The sound is distorted or noisy.	The volume may be turned up too high. Make sure all relevant volume settings are appropriate.
	This may be caused by certain effects or filter resonance settings. Check the effect or filter settings and change them accordingly, referring to the Reference Manual on the website.
Not all simultaneously played notes sound.	You are probably exceeding the maximum polyphony (page 125) of the instrument. When the maximum polyphony is exceeded, the earliest played notes will stop sounding, letting the latest played notes sound.
The keyboard volume is lower than the Song/Style playback volume.	The volume of the keyboard parts may be set too low. Raise the volume in the BALANCE display (page 58).
The Main display does not appear even when turning the power on.	This may occur if a USB storage device has been installed to the instrument. Installation of some USB storage device may result a long interval between turning the power on and appearance of the Main display. To avoid this, turn the power on after disconnecting the device.
Some characters of the file/folder name are garbled.	The language settings have been changed. Set the appropriate language for the file/folder name (page 17).
An existing file is not shown.	The file extension (.MID, etc.) may have been changed or deleted. Manually rename the file, adding the appropriate extension, on a computer.
	Data files with names of more than 50 characters cannot be handled by the instrument. Rename the file, reducing the number of characters to 50 or less.

Voice	
The Voice selected from the Voice Selection display does not sound.	Check whether or not the selected part is turned on (page 39).
A strange “flanging” or “doubling” sound occurs. The sound is slightly different each time the keys are played.	The RIGHT 1 and RIGHT 2 parts are set to “ON,” and both parts are set to play the same Voice. Turn off the RIGHT 2 part or change the Voice of one of the parts.
Some Voices will jump an octave in pitch when played in the upper or lower registers.	This is normal. Some voices have a pitch limit which, when reached, causes this type of pitch shift.
Style	
The Style does not start even when the [START/STOP] button is pressed.	The Rhythm channel of the selected Style may not contain any data. Turn the [ACMP ON/OFF] button on and play left-hand section on the keyboard to sound the accompaniment part of the Style.
Only the rhythm channel plays.	Make sure the Auto Accompaniment function is turned on; press the [ACMP ON/OFF] button.
	You may be playing keys in the right hand range of the keyboard. Make sure to play keys in the chord range of the keyboard.
Styles in a USB storage device cannot be selected.	If the size of the Style data is large (about 120 KB or greater), the Style cannot be selected because the data is too large to be ready by the instrument.
Song	
Songs cannot be selected.	This may be because the language settings have been changed. Set the appropriate language for the Song file name (page 17).
	If the size of the Song data is large (about 300 KB or greater), the Song cannot be selected because the data is too large to be read by the instrument.
Song playback does not start.	The Song has been stopped at the end of the Song data. Return to the beginning of the Song by pressing the SONG [STOP] button.
	In the case a Song to which write-protect has been applied (“Prot. 2 Edit” is shown at the upper left of the Song name), the original file may not be in the same folder. It cannot be played back unless the original file (showing “Prot.2 Orig” at the upper left of the Song name) is in the same folder.
	In case of a Song to which write-protect has been applied (“Prot. 2 Edit” is shown at the upper left of the Song name), the original file name may have been changed. Rename the file with the original file name (so that “Prot.2 Orig” is shown at the upper left of the Song name).
	In case of a Song to which write-protect has been applied (“Prot. 2 Edit” is shown at the upper left of the Song name), the file icon may have been changed. Songs to which write-protect has been applied cannot be played back when the file icon of the original has been changed.
Song playback stops before the Song is finished.	The Guide function is turned on. (In this case, playback is “waiting” for the correct key to be played.) Press the [GUIDE] button to turn off the guide function.
The measure number is different from that of the score in the Song Position display, shown by pressing the [REW]/[FF] buttons.	This happens when playing back music data for which a specific, fixed tempo is set.
When playing back a Song, some channels do not play.	Playback of these channels may be set to “OFF.” Turn playback ON for those channels that are set to “OFF” (page 64).
The Guide lamps do not light during Song playback, even after pressing the [GUIDE] button.	Any notes outside of the 88-key range cannot be indicated by the Guide lamps.
The Guide lamps light an octave or two lower/higher than the actual pitch.	The Guide lamps sometimes light an octave or two lower/higher than the actual pitch depending on the selected Voice.
The tempo, beat, measure and music notation is not displayed correctly.	Some Song data for the instrument has been recorded with special “free tempo” settings. For such Song data, the tempo, beat, measure and music notation will not be displayed correctly.

USB Audio function (CVP-509/505/503)	
The message "This drive is busy now." appeared, and then the recording was aborted.	Make sure to use a compatible USB storage device (page 106).
	Make sure that the USB storage device has enough memory (page 87).
	If you are using a USB memory device to which data has already been recorded, check first that no important data remains on the device, then format it (page 107) and try recording again.
Audio files cannot be selected.	The file format may not be compatible with the instrument. The compatible formats are: MP3 and WAV (CVP-509/505), WAV (CVP-503). The DRM protected files cannot be played back.
Recorded file is played back at a different volume compared to when it was recorded.	The audio playback volume has been changed. Setting the volume value to 100 plays back the file as the same volume when it was recorded (page 85).
Mixing Console	
The sound seems strange or different than expected when changing a rhythm Voice (drum kit, etc.) of the Style or Song from the Mixer.	When changing the rhythm/percussion Voices (drum kits, etc.) of the Style and Song from the VOICE parameter, the detailed settings related to the drum voice are reset, and in some cases you may be unable to restore the original sound. In the case of Song playback, you can restore the original sound by returning to the beginning of the Song and playing back from that point. In the case of Style play, you can restore the original sound by selecting the same Style again.
Microphone/Vocal Harmony (CVP-509/505/503)	
The microphone input signal cannot be recorded.	The microphone input signal cannot be recorded by Song recording. Use the USB Audio function (page 86).
Harmony can be heard in addition to the microphone sound.	Vocal Harmony is set to "ON." Turn Vocal Harmony off (page 103).
The Vocal Harmony effect sounds distorted or out-of-tune.	Your vocal microphone may be picking up extraneous sounds, such as the Style sound from the instrument. In particular, bass sounds can cause mistracking of the Vocal Harmony. To remedy this: <ul style="list-style-type: none"> • Sing as closely to the microphone as possible. • Use a unidirectional microphone. • Turn down the Master volume, Style volume, or Song volume control (pages 15, 58).
Pedal/AUX Pedal	
The damper, sostenuto and soft functions do not work for the relevant pedals.	The pedal cord plug is not connected. Securely insert the pedal cord plug into the proper jack (page 113, 115, 117).
	Make sure that each pedal is properly assigned to SUSTAIN, SOSTENUTO, and SOFT (page 32).
The on/off setting of the footswitch connected to the AUX PEDAL jack is reversed.	Turn the instrument's power off, then turn on again without pressing the footswitch.
AUX IN jacks	
Sound input to the AUX IN jacks is interrupted.	The output volume of the external device connected to this instrument is too low. Increase the output volume of the external device. The volume level reproduced via this instrument's speakers can be adjusted by using the [MASTER VOLUME] control.

Panel Button Chart

No.Corresponds to the number in the “Panel Controls” on page 12.

Button/ControlIndicates the button/controller that you should use at first for entering the corresponding function.

DisplayIndicates the display title (and tab title) called up by operating the button/controller.

Reference Manual“●” indicates that the detailed information is described in the Reference Manual (downloadable from website).

No.	Button/Control	Display	Page	Reference Manual	
①	[USB TO DEVICE] terminal	—	106	—	
②	MASTER VOLUME control	—	15	—	
③	MIC [SIGNAL]/[OVER] lamp	—	102	—	
④	[DEMO]	DEMO display	18	—	
⑤	[METRONOME ON/OFF]	—	33	—	
⑥	TRANSPOSE [-]/[+]	TRANSPOSE (pop-up)	42	—	
⑦	[TAP TEMPO]	—	53	—	
	TEMPO [-]/[+]	TEMPO (pop-up)	53	—	
⑧	STYLE CONTROL	[POP & ROCK] – [PIANIST]	Style Selection display	48	—
		[ACMP ON/OFF]	—	48	—
		[AUTO FILL IN]	—	53	—
		INTRO [I] – [III]	—	52	—
		MAIN VARIATION [A] – [D]	—	53	—
		[BREAK]	—	53	—
		ENDING/rit. [I] – [III]	—	52	—
		[SYNC STOP]	—	52	—
		[SYNC START]	—	52	—
		[START/STOP]	—	52	—
⑨	[MUSIC FINDER]	MUSIC FINDER display	ALL	75	—
			FAVORITE	78	●
			SEARCH 1	76	—
			SEARCH 2	76	—
⑩	[LCD CONTRAST] knob (CVP-503/501)	—	17	—	
⑪	[MIXING CONSOLE]	MIXING CONSOLE display	VOL/VOICE	90, 91	●
			FILTER	88	●
			TUNE	88	●
			EFFECT	92	●
			EQ	88	●
			CMP (CVP-509)	93	—
⑫	[CHANNEL ON/OFF]	CHANNEL ON/OFF (SONG) (pop-up)	SONG	64	—
			STYLE	58	—
⑬	TAB [◀][▶] [A] – [J] [DIRECT ACCESS] [EXIT] [1 ▲▼] – [8 ▲▼] buttons [DATA ENTRY] dial [ENTER]	—	—	21	—
		—	—	20	—
		(message)	—	23	—
		—	—	22	—
		—	—	21	—
		—	—	22	—
		—	—	22	—
⑭	[USB] (CVP-509/505/503)	USB/AUDIO PLAYER display	83	—	

No.	Button/Control	Display	Page	Reference Manual	
15	[FUNCTION]	MASTER TUNE/SCALE TUNE	MASTER TUNE SCALE TUNE	47 47	● ●
		SONG SETTING		72	●
		STYLE SETTING/SPLIT POINT/ CHORD FINGERING	STYLE SETTING	58	●
			SPLIT POINT	58	●
			CHORD FINGERING	51, 58	●
		CONTROLLER	PEDAL	105	●
			KEYBOARD/PANEL	31, 47	●
		REGIST SEQUENCE/FREEZE/VOICE SET	REGISTRATION SEQUENCE	82	—
			FREEZE	82	●
			VOICE SET	47	●
		DIGITAL REC MENU	SONG CREATOR	72, 89	●
			STYLE CREATOR	58, 89	●
		MIC SETTING/VOCAL HARMONY (CVP-509/505/503)		103	●
		iAFC SETTING (CVP-509)		34	—
		MIDI	MIDI template selection display	109	●
		UTILITY	CONFIG 1	110	●
CONFIG 2	110		●		
SCREEN OUT	101, 110		—		
MEDIA	110		●		
OWNER	17, 29, 110		●		
	SYSTEM RESET	110	●		
16	PART ON/OFF	[RIGHT1]/[RIGHT2]/ [LEFT]	—	39	—
17		[INTERNET]	Clavinova Special Website (only when connected to the internet)	95	●
18	SONG CONTROL	[SONG SELECT]	Song Selection display	59	—
		[REC]	CHANNEL ON/OFF (pop-up)	66	—
		[STOP]	—	60	—
		[PLAY/PAUSE]	—	60	—
		[REW]/[FF]	SONG POSITION (pop-up)	61	—
		[EXTRA TRACKS]	—	64	—
		[TRACK 2 (L)]	—	64	—
		[TRACK 1 (R)]	—	64	—
		[SCORE]	SCORE display	62	●
		[LYRICS/TEXT] (CVP-509/505/503)	LYRICS display, TEXT display	63	●
		[LYRICS](CVP-501)	LYRICS display	63	—
		[GUIDE]	—	64	●
		[REPEAT]	—	65	—
19		[PIANO RESET]	—	30	—
20	REGISTRATION MEMORY	REGIST BANK [-]/[+]	REGISTRATION BANK (pop-up)	80	—
		[MEMORY]	REGISTRATION MEMORY CONTENTS display	79	—
		[1] – [8]	—	80	—
21	VOICE CONTROL	[PIANO] - [PERC. & DRUM KIT]	Voice Selection display	37	—
		[ORGAN FLUTES]	Organ Flutes VOICE SET display	FOOTAGE VOLUME/ATTACK EFFECT/EQ	46 47 47
22	ONE TOUCH SETTING	[1] – [4]	—	55	●
		[OTS LINK]	—	55	—
23		[VOICE EFFECT]	VOICE EFFECT display	44	●
24		Power	Opening display	14	—

Specifications

		CVP-509	CVP-505	CVP-503	CVP-501	
Size/Weight	Width [in the case of a model with a polished finish]	1430mm (56-5/16") [1430mm (56-5/16")]	1430mm (56-5/16") [1430mm (56-5/16")]	1432mm (56-3/8") [1432mm (56-3/8")]	1372mm (54") [1372mm (54")]	
	Height [in the case of a model with a polished finish]	Without Music Rest	868mm (34-3/16") [871mm (34-5/16")]	868mm (34-3/16") [871mm (34-5/16")]	885mm (34-13/16") [888mm (34-15/16")]	893mm (35-3/16") [896mm (35-1/4")]
		With Music Rest	1025mm (40-3/8") [1027mm (40-7/16")]	1025mm (40-3/8") [1027mm (40-7/16")]	1042mm (41") [1043mm (41-1/16")]	1047mm (41-1/4") [1048mm (41-1/4")]
	Depth [in the case of a model with a polished finish]	Without Music Rest	611mm (24-1/16") [611mm (24-1/16")]	611mm (24-1/16") [611mm (24-1/16")]	613mm (24-1/8") [614mm (24-3/16")]	595mm (23-7/16") [596mm (23-7/16")]
		With Music Rest	609mm (24") [609mm (24")]	609mm (24") [609mm (24")]	613mm (24-1/8") [614mm (24-3/16")]	595mm (23-7/16") [596mm (23-7/16")]
Weight [in the case of a model with a polished finish]		82kg (180lbs., 12oz.) [84kg (185lbs., 3oz.)]	76kg (167lbs., 9oz.) [78kg (171lbs., 15oz.)]	71kg (156lbs., 8oz.) [73kg (160lbs., 15oz.)]	58kg (127lbs., 14oz.) [60kg (132lbs., 4oz.)]	
Control Interface	Keyboard	Number of Keys	88			
		Type	Natural Wood (NW) Keyboard with Synthetic Ivory Keytops (with real-wood white keys)	Graded Hammer 3 (GH3) Keyboard with Synthetic Ivory Keytops	Graded Hammer (GH) Keyboard	
		Touch Sensitivity	Hard2/Hard1/Normal/Soft1/Soft2			
	Pedal	Number of Pedals	3			
		Half Pedal	Yes			
		Functions	Volume, Sustain, Sostenuto, Soft, Glide, Song Play/Pause, Style Start/Stop, etc.			
	Display	Type	TFT Color VGA LCD	TFT Color QVGA LCD	B/W QVGA LCD	
		Size	640 x 480 dots	320 x 240 dots		
		Contrast	-		Yes	
		Score Display Function	Yes			
		Lyrics Display Function	Yes			
		Text Viewer Function	Yes		-	
		Wallpaper Customization	Yes	-		
		Language	English, Japanese, German, French, Spanish, Italian			
	Panel	Language	English			
Cabinet	Key Cover	Folding		Sliding		
	Music Rest	Yes				
	Music Clips	Yes		-		
Voices	Tone Generation	Tone Generating Technology	AWM Dynamic Stereo Sampling			
		Pure CF Sampling	Yes			
		Number of Dynamic Levels	5	4	3	
		Stereo Sustain Samples	Yes		-	
		Key-off Samples	Yes		-	
		String Resonance	Yes	-		
	Polyphony	Number of Polyphony (Max.)	128 + 128	128		

			CVP-509	CVP-505	CVP-503	CVP-501	
Voices	Preset	Number of Voices	811 + 480 XG + 26 Drum/SFX Kits + GM2 (+ GS Voices for GS Song playback)	689 + 480 XG + 23 Drum/SFX Kits + GM2 (+ GS Voices for GS Song playback)	398 + 480 XG + 19 Drum/SFX Kits + GM2 (+ GS Voices for GS Song playback)	296 + 480 XG + 15 Drum/SFX Kits + GM2 (+ GS Voices for GS Song playback)	
		Super Articulation 2 Voices	11	–	–	–	
		Super Articulation Voices	49	38	–	–	
		Mega Voices	23	18	15	–	
		Natural! Voices	39	22	22	3	
		Sweet! Voices	27	24	23	11	
		Cool! Voices	64	46	33	16	
		Live! Voices	70	29	19	10	
		Organ Flutes!	20	10	10	10	
	Custom	Voice Set	Yes				
	Compatibility	XG	Yes				
		XF	Yes				
		GS (For Song Playback)	Yes				
		GM	Yes				
GM2		Yes					
VH		Yes			–		
AEM	Yes	–		–			
Effects	Types	Reverb	42 Preset + 3 User				
		Chorus	106 Preset + 3 User	71 Preset + 3 User			
		Mono/Poly	Yes				
		DSP	DSP 1: 272 Preset + 3 User, DSP 2-9: 272 Preset + 10 User	DSP 1: 271 Preset + 3 User, DSP 2-4: 128 Preset + 10 User			
		iAFC	Yes	–			
		Master Compressor	5 Preset + 5 User	–			
		Master EQ	5 Preset + 2 User				
		Part EQ	27 Parts				
	Part	Dual/Layers (Right Parts 1, 2)	Yes				
		Split (Right + Left Parts)	Yes				
	Accompany Style Related	Vocal Harmony	60 Preset + 10 User			–	
	Accompaniment Styles	Preset	Number of Preset Styles	442	362	272	191
			Pro Styles	362	294	213	151
Session Styles			40	30	23	4	
Free Play Styles			4	2	–	–	
Pianist Styles			36	36	36	36	
File Format			Style File Format GE (Guitar Edition)				
Fingering		Single Finger, Fingered, Fingered On Bass, Multi Finger, AI Fingered, Full Keyboard, AI Full Keyboard					
Style Control		INTRO x 3, MAIN VARIATION x 4, FILL x 4, BREAK, ENDING x 3					
Custom		Style Creator	Yes				
Other Features		Music Finder (Max.)	2,500 Records		1,200 Records		
	One Touch Setting (OTS)	4 for each Style					
Songs	Preset	Number of Preset Songs	120			61	
	Recording	Number of Tracks	16				
		Data Capacity	300KB				
		Recording Function	Quick Recording, Multi Recording, Step Recording				
	Compatible Data Format	Playback	SMF (Format 0 & 1), ESEQ, XF				
Recording		SMF (Format 0)					

		CVP-509	CVP-505	CVP-503	CVP-501
Functions	Registration Memory	Number of Buttons	8		
		Control	Regist. Sequence, Freeze		
	Lesson/Guide	Lesson/Guide	Follow Lights, Any Key, Karao-Key, Vocal CueTIME		Follow Lights, Any Key, Karao-Key
		Guide Lamp	Yes		
		Performance Assistant	Yes		
	Demo	Demo	Yes		
	USB Audio	Playback	.wav..mp3	.wav	–
		Recording	.wav		–
	Overall Controls	Metronome	Bell on/off, Human Voices (5 Languages)		
		Tempo Range	5 - 500, Tap Tempo		
		Transpose	-12 – 0 – +12		
		Tuning	414.8 – 440 – 466.8 Hz		
		Scale Type	9		
	Miscellaneous	PIANO RESET Button	Yes		
		Direct Access	Yes		
Storage and Connectivity	Storage	Internal Memory	about 3.2 MB	about 2.4 MB	about 1.4 MB
		External Drives (Optional)	USB Storage Devices (USB Flash Memory, etc.), Floppy Disk Drive		
	Connectivity	Headphones	x 2		
		Microphone	Input Volume, Mic./Line In		–
		MIDI	In/Out/Thru		
		AUX IN	L/L+R, R		
		AUX OUT	L/L+R, R		
		AUX Pedal	Yes		
		VIDEO OUT	Yes		–
		RGB OUT	Yes		–
		USB TO DEVICE	x 2		x 1
		USB TO HOST	Yes		
LAN	Yes				
Amplifiers and Speakers	Amplifiers	(35 W + 20 W + 20W) x 2 + 20W x 2	40W x 2		20W x 2
	Speakers	(16cm + 5cm + 3cm (dome)) x 2 + 10cm x 2	(16cm + 5cm) x 2		16cm x 2
Accessories		<ul style="list-style-type: none"> • Accessory CD-ROM for Windows • Owner's Manual • Data List • Accessory CD-ROM for Windows Installation Guide • "50 greats for the Piano" Music Book • My Yamaha Product User Registration <p>*The PRODUCT ID on the sheet will be needed when you fill out the User Registration form.</p> <p>The following item may be included or optional, depending on your locale:</p> <ul style="list-style-type: none"> • Bench 			
Optional Accessories	Headphones	HPE-160			
	Floppy Disk Drive	UD-FD01			
	Footswitches	FC4/FC5			
	Foot controller	FC7			
Service	Internet Direct Connection	Yes			

* Specifications and descriptions in this owner's manual are for information purposes only. Yamaha Corp. reserves the right to change or modify products or specifications at any time without prior notice. Since specifications, equipment or options may not be the same in every locale, please check with your Yamaha dealer.

Index

Symbols

- [▶/||] (PLAY/PAUSE) 60
- [◀◀] (REW)..... 61

Numerics

- [1 ▲▼] – [8 ▲▼] buttons 21
- 1-16..... 72

A

- [A] – [J]..... 20
- A-B Repeat 65
- ACMP ON/OFF 49
- ADD TO FAVORITE..... 78
- ADD TO MF 77
- AEM Technology..... 41
- Articulation Effect 43
- ASSEMBLY..... 58
- Assembly (CVP-501)..... 116
- Assembly (CVP-503)..... 114
- Assembly (CVP-509/505) 111
- AUDIO PLAYER 83
- Audio Record (Music Finder) 74
- Auto Accompaniment..... 49
- AUTO FILL IN 53
- AUX IN 100
- AUX OUT 100
- AUX PEDAL..... 105

B

- Backup 29
- Balance display 58
- BASIC 58
- BASS 57
- Bookmark 98
- BREAK..... 53
- Browser..... 98

C

- CD-ROM 9
- Center Pedal 32

- CHANNEL (Song Creator)..... 72
 - CHANNEL (Style Creator) 58
 - CHANNEL ON/OFF..... 57, 64
 - Character entry..... 27
 - CHD1/2 (Chord 1/ 2)..... 57
 - Chord..... 51
 - CHORD (Song Creator)..... 72
 - CHORD FINGERING 51, 58
 - CHORUS 92
 - CMP..... 93
 - Computer..... 108
 - CONFIG 1..... 110
 - CONFIG 2..... 110
 - Connection 99
 - Contrast..... 17
 - COPY 70
 - CUT 70
- ## D
- Damper Pedal..... 32
 - DATA ENTRY dial 22
 - DELETE..... 71
 - DEMO..... 18
 - DEMO (Voice) 38
 - Dial (Data Entry)..... 22
 - DIRECT ACCESS 23
 - Drum Voice..... 40
 - DSP 45, 92
 - DSP VARIATION..... 45
 - DYNAMIC DAMPER EFFECT..... 34

E

- EFFECT..... 88
- EFFECT/EQ 47
- ENDING/rit..... 52
- ENTER 22
- Entering Characters..... 27
- EQ 88
- EXIT..... 22
- EXTRA TRACKS..... 64

F

- Factory Reset..... 29
- Fast Forward..... 61
- FAVORITE 78
- FF..... 61
- File 26
- File Selection Display..... 26
- Fill-in section 53
- FILTER..... 88
- Floppy Disk Drive..... 118, 119
- Folder..... 27
- FOLDER (File Selection Display)..... 69
- Foot Controller 105
- Footage..... 46
- Footswitch..... 105
- FORMAT 107
- Free Play..... 50

G

- GAIN OFFSET 93
- GM 9, 47
- GROOVE 58
- GS..... 9
- GUIDE..... 64
- Guide lamp..... 13, 64
- GUIDE MODE..... 65
- Guitar 102

H

- Half pedal..... 32
- HARMONY/ECHO 45
- Headphone Hanger..... 16
- Headphones..... 16
- HOME 97

I

- iAFC 34
- INFO (Voice)..... 38, 41
- INFO. (Registration Memory)..... 81
- INITIAL TOUCH..... 31
- Initialize (Factory Reset) 29

Input jack	100	Multi Track Recording	67	Pro	50
INPUT VOLUME	102	MUSIC FINDER	73	Prot	61
INTERNET	95	Music Finder +	78	Protected Song	61
Internet Connection Guide	10	Music Notation	62		
Internet Direct Connection	95	Music Rest	15	Q	
INTRO	52			Quick Recording	66
		N			
K		NAME	70	R	
Key cover	14	NEXT (Song Playback)	60	RATIO OFFSET	93
Keyboard Part	39	NEXT CANCEL	60	REC	66
				REC MODE (Song Creator)	72
L		O		Record (Music Finder)	74
LAN terminal	96	ONE TOUCH SETTING	55	RECORD EDIT	78
Language	17	ORGAN FLUTES	46	Recording (Song)	66
LEFT	39	ORGAN TYPE	45, 46	Reference Manual	10
LEFT HOLD	45	OTS INFO	56	REFRESH	97
Left Pedal	32	OTS LINK	55	REGIST BANK	80
Link	97	Output jack	100	REGISTRATION MEMORY	80
Lyrics	63	OVER lamp	102	REGISTRATION SEQUENCE	82
LYRICS (Song Creator)	72	OWNER	17, 18, 29	REPEAT (Audio playback)	85
		Owner Name	18	REPEAT (Song)	65
				REPertoire	54
M		P		RESTORE	29
Main Display	24	P.A.T.	72	REVERB	92
MAIN PICTURE	18	PAD	57	REW	61
Main section	53	Panel Button Chart	123	Rewind	61
MAIN VARIATION	53	PANPOT	91	RGB OUT	101
Master Compressor	93	PARAMETER	58	RHY1/2 (Rhythm 1/2)	57
MASTER TUNE	47	PART ON/OFF	39	Rhythm	48
MASTER VOLUME	15	PASTE	71	RIGHT 1-2	39
MEDIA	107	Pause	60	Right Pedal	32
MegaVoice	40	Pedal	32, 105	ROTARY SP SPEED	46
MEMORY	58, 79	Percussion Voice	40		
Message	23	Performance Assistant	72	S	
Metronome	33	PHONES	16	SA Voice	40
MIC CALIBRATION	35	PHR1/2 (Phrase1/2)	57	SA2 Voice	41
MIC EFFECT	103	Phrase Mark	61	SAVE	68
MIC SETTING/VOCAL HARMONY	103	Pianist	50	Scale	42
MIC. LINE switch	102	Piano Lock	30	SCALE TUNE	47
MIC./LINE IN	102	PIANO RESET	30	SCORE	62
Microphone	102	Pitch setting	42	SCREEN CONTENT	101
MIDI Basics	10	PLAY/PAUSE	60	SCREEN OUT	101
MIDI IN	109	Portamento	45	SEARCH (Music Finder)	76
MIDI OUT	109	Power button	14	Section	53
MIDI THRU	109	Power indicator	14	Session	50
MIXING CONSOLE	88	Powered speaker	100	SFF	9
MONITOR TYPE	101	PRESET	26	SFF GE	50
MONO/POLY	45	PRESETS (Organ Flutes)	46	Sheet	15
MP3	83				

Sheet music brace	15	USB TO HOST	108
SIGNAL lamp	102	USB Wireless LAN Adaptor	96
Song Creator	72	USB-MIDI driver	108
Song Record (Music Finder)	74	USER	26
SONG SELECT	59	Utility	110
SONG SETTING	72		
Sostenuto Pedal	32	V	
SPATIAL EFFECT	34	VERSION	18
Specifications	125	VH	9
Split Point	39, 58	VIBRATO (Organ Flutes)	46
START/STOP	49, 52	VIDEO OUT	101
STEP REC	58	VOCAL HARMONY	103
STOP (Song)	60	VOICE	37
STYLE	48	VOICE EFFECT	44
Style Creator	58	VOICE SET	47
Style File Format	9	Voice Type	40
STYLE SETTING	58	VOL/VOICE	88
Super Articulation Voice	40, 43	Volume	58
SYNC START	49, 52	Volume (Audio playback)	85
SYNC STOP	52	VOLUME/ATTACK	47
Synchro Start (Song)	60		
SYS/EX	72	W	
SYSTEM RESET	29, 110	WAV	83
		Wireless Game Adaptor	96
T			
TAB	21	X	
TALK	103	XF	9
TAP TEMPO	53	XG	9, 47
TEMPO	53		
Tempo	33		
Text	63		
THRESHOLD OFFSET	93		
Touch response	31		
Touch sensitivity	31		
TRACK 1 (R)	64		
TRACK 2 (L)	64		
TRANSPOSE	42		
TRANSPOSE ASSIGN	47		
Troubleshooting	120		
TUNE	88		
U			
UP	27		
USB (File Selection Display)	26		
USB Audio	83		
USB AUDIO RECORDER	86		
USB button	83		
USB Storage Device	106		
USB TO DEVICE	106		

The followings are the titles, credits and copyright notices for fifty seven (57) of the songs pre-installed in this instrument (CVP-509/505/503):

Alfie

Theme from the Paramount Picture ALFIE
Words by Hal David
Music by Burt Bacharach
Copyright © 1966 (Renewed 1994) by Famous Music Corporation
International Copyright Secured All Rights Reserved

All Shook Up

Words and Music by Otis Blackwell and Elvis Presley
Copyright © 1957 by Shalimar Music Corporation
Copyright Renewed and Assigned to Elvis Presley Music
All Rights Administered by Cherry River Music Co. and Chrysalis Songs
International Copyright Secured All Rights Reserved

Beauty And The Beast

from Walt Disney's BEAUTY AND THE BEAST
Lyrics by Howard Ashman
Music by Alan Menken
© 1991 Walt Disney Music Company and Wonderland Music Company, Inc.
All Rights Reserved Used by Permission

Bésame Mucho (Kiss Me Much)

Music and Spanish Words by Consuelo Velazquez
English Words by Sunny Skylar
Copyright © 1941, 1943 by Promotora Hispano Americana de Musica, S.A.
Copyrights Renewed
All Rights Administered by Peer International Corporation
International Copyright Secured All Rights Reserved

Blue Hawaii

from the Paramount Picture WAIKIKI WEDDING
Words and Music by Leo Robin and Ralph Rainger
Copyright © 1936, 1937 (Renewed 1963, 1964) by Famous Music Corporation
International Copyright Secured All Rights Reserved

Blue Moon

Words by Lorenz Hart
Music by Richard Rodgers
© 1934 (Renewed 1962) METRO-GOLDWYN-MAYER INC.
All Rights Controlled by EMI ROBBINS CATALOG INC. (Publishing) and WARNER BROS. PUBLICATIONS U.S. INC. (Print)
All Rights Reserved Used by Permission

Brazil

Words and Music by Ray Barroso
English lyrics by S. K. Russell
Copyright © 1941 by Peer International Corporation
Copyright Renewed
International Copyright Secured All Rights Reserved

California Girls

Words and Music by Brian Wilson and Mike Love
Copyright © 1965 IRVING MUSIC, INC.
Copyright Renewed
All Rights Reserved Used by Permission

Can You Feel The Love Tonight

from Walt Disney Pictures' THE LION KING
Music by Elton John
Lyrics by Tim Rice
© 1994 Wonderland Music Company, Inc.
All Rights Reserved Used by Permission

Can't Help Falling In Love

from the Paramount Picture BLUE HAWAII
Words and Music by George David Weiss, Hugo Peretti and Luigi Creatore
Copyright © 1961 by Gladys Music, Inc.
Copyright Renewed and Assigned to Gladys Music
All Rights Administered by Cherry Lane Music Publishing Company, Inc. and Chrysalis Music
International Copyright Secured All Rights Reserved

Chim Chim Cher-ee

from Walt Disney's MARY POPPINS
Words and Music by Richard M. Sherman and Robert B. Sherman
© 1963 Wonderland Music Company, Inc.
Copyright Renewed
All Rights Reserved Used by Permission

Do-Re-Mi

from THE SOUND OF MUSIC
Lyrics by Oscar Hammerstein II
Music by Richard Rodgers
Copyright © 1959 by Richard Rodgers and Oscar Hammerstein II
Copyright Renewed
WILLIAMSON MUSIC owner of publication and allied rights throughout the world
International Copyright Secured All Rights Reserved

Don't Be Cruel (To A Heart That's True)

Words and Music by Otis Blackwell and Elvis Presley
Copyright © 1956 by Unart Music Corporation and Elvis Presley Music, Inc.
Copyright Renewed and Assigned to Elvis Presley Music
All Rights Administered by Cherry River Music Co. and Chrysalis Songs
International Copyright Secured All Rights Reserved

Edelweiss

from THE SOUND OF MUSIC
Lyrics by Oscar Hammerstein II
Music by Richard Rodgers
Copyright © 1959 by Richard Rodgers and Oscar Hammerstein II
Copyright Renewed
WILLIAMSON MUSIC owner of publication and allied rights throughout the world
International Copyright Secured All Rights Reserved

Fly Me To The Moon (In Other Words)

featured in the Motion Picture ONCE AROUND
Words and Music by Bart Howard
TRO - © Copyright 1954 (Renewed) Hampshire House Publishing Corp., New York, NY
International Copyright Secured
All Rights Reserved Including Public Performance For Profit
Used by Permission

Hey Jude

Words and Music by John Lennon and Paul McCartney
Copyright © 1968 Sony/ATV Songs LLC
Copyright Renewed
All Rights Administered by Sony/ATV Music Publishing, 8 Music Square West, Nashville, TN 37203
International Copyright Secured All Rights Reserved

Hound Dog

Words and Music by Jerry Leiber and Mike Stoller
Copyright © 1956 by Elvis Presley Music, Inc. and Lion Publishing Co., Inc.
Copyright Renewed, Assigned to Gladys Music and Universal - MCA Music Publishing, A Division of Universal Studios, Inc.
All Rights Administered by Cherry Lane Music Publishing Company, Inc. and Chrysalis Music
International Copyright Secured All Rights Reserved

I Just Called To Say I Love You

Words and Music by Stevie Wonder
© 1984 JOBETE MUSIC CO., INC. and BLACK BULL MUSIC
c/o EMI APRIL MUSIC INC.
All Rights Reserved International Copyright Secured Used by Permission

I Left My Heart In San Francisco

Words by Douglass Cross
Music by George Cory
© 1954 (Renewed 1982) COLGEMS-EMI MUSIC INC.
All Rights Reserved International Copyright Secured Used by Permission

In The Mood

By Joe Garland
Copyright © 1939, 1960 Shapiro, Bernstein & Co., Inc., New York
Copyright Renewed
International Copyright Secured All Rights Reserved
Used by Permission

Isn't She Lovely

Words and Music by Stevie Wonder
© 1976 JOBETE MUSIC CO., INC. and BLACK BULL MUSIC
c/o EMI APRIL MUSIC INC.
All Rights Reserved International Copyright Secured Used by Permission

Let It Be

Words and Music by John Lennon and Paul McCartney
Copyright © 1970 Sony/ATV Songs LLC
Copyright Renewed
All Rights Administered by Sony/ATV Music Publishing, 8 Music Square West, Nashville, TN 37203
International Copyright Secured All Rights Reserved

Let's Twist Again

Words by Kal Mann
Music by Dave Appell and Kal Mann
Copyright © 1961 Kalmann Music, Inc.
Copyright Renewed
All Rights Controlled and Administered by Spirit Two Music, Inc. (ASCAP)
International Copyright Secured All Rights Reserved

Linus And Lucy

By Vince Guaraldi
Copyright © 1965 LEE MENDELSON FILM PRODUCTIONS, INC.
Copyright Renewed
International Copyright Secured All Rights Reserved

Love Story

Theme from the Paramount Picture LOVE STORY
Music by Francis Lai
Copyright © 1970, 1971 (Renewed 1998, 1999) by Famous Music Corporation
International Copyright Secured All Rights Reserved

Lullaby Of Birdland

Words by George David Weiss
Music by George Shearing
© 1952, 1954 (Renewed 1980, 1982) EMI LONGITUDE MUSIC
All Rights Reserved International Copyright Secured Used by Permission

Michelle

Words and Music by John Lennon and Paul McCartney
Copyright © 1965 Sony/ATV Songs LLC
Copyright Renewed
All Rights Administered by Sony/ATV Music Publishing, 8 Music Square West, Nashville, TN 37203
International Copyright Secured All Rights Reserved

Mickey Mouse March

from Walt Disney's THE MICKEY MOUSE CLUB
Words and Music by Jimmie Dodd
© 1955 Walt Disney Music Company
Copyright Renewed
All Rights Reserved Used by Permission

Mission: Impossible Theme

from the Paramount Television Series MISSION: IMPOSSIBLE
By Lalo Schifrin
Copyright © 1966, 1967 (Renewed 1994, 1995) by Bruin Music Company
International Copyright Secured All Rights Reserved

Mona Lisa

from the Paramount Picture CAPTAIN CAREY, U.S.A.
Words and Music by Jay Livingston and Ray Evans
Copyright © 1949 (Renewed 1976) by Famous Music Corporation
International Copyright Secured All Rights Reserved

Moon River

from the Paramount Picture BREAKFAST AT TIFFANY'S
Words by Johnny Mercer
Music by Henry Mancini
Copyright © 1961 (Renewed 1989) by Famous Music Corporation
International Copyright Secured All Rights Reserved

Moonlight Serenade

Words by Mitchell Parish
Music by Glen Miller
Copyright © 1939 (Renewed 1967) by ROBBINS MUSIC CORPORATION
All Rights Controlled and Administered by EMI ROBBINS CATALOG INC.
International Copyright Secured All Rights Reserved

My Favorite Things

from THE SOUND OF MUSIC
Lyrics by Oscar Hammerstein II
Music by Richard Rodgers
Copyright © 1959 by Richard Rodgers and Oscar Hammerstein II
Copyright Renewed
WILLIAMSON MUSIC owner of publication and allied rights throughout the world
International Copyright Secured All Rights Reserved

My Way

By Paul Anka, Jacques Revaux, Claude Francois and Giles Thibault
© 1997 by Chrysalis Standards, Inc.
Used by Permission. All Rights Reserved.

The Nearness Of You

from the Paramount Picture ROMANCE IN THE DARK
Words by Ned Washington
Music by Hoagy Carmichael
Copyright © 1937, 1940 (Renewed 1964, 1967) by Famous Music Corporation
International Copyright Secured All Rights Reserved

Theme From "New York, New York"

Music by John Kander
Words by Fred Ebb
© 1977 UNITED ARTISTS CORPORATION
All Rights Controlled by EMI UNART CATALOG INC. (Publishing) and WARNER BROS. PUBLICATIONS U.S. INC. (Print)
All Rights Reserved Used by Permission

Ob-La-Di, Ob-La-Da

Words and Music by John Lennon and Paul McCartney
Copyright © 1968 Sony/ATV Songs LLC
Copyright Renewed
All Rights Administered by Sony/ATV Music Publishing, 8 Music Square West, Nashville, TN 37203
International Copyright Secured All Rights Reserved

Proud Mary

Words and Music by J.C. Fogerty
© 1968 (Renewed) JONDORA MUSIC
All Rights Reserved Used by Permission

Return To Sender

Words and Music by Otis Blackwell and Winfield Scott
Copyright © 1962 by Elvis Presley Music, Inc.
Copyright Renewed and Assigned to Elvis Presley Music
All Rights Administered by Cherry River Music Co. and Chrysalis Songs
International Copyright Secured All Rights Reserved

The Shoop Shoop Song (It's In His Kiss)

Words and Music by Rudy Clark
Copyright © 1963, 1964 by Trio Music Company, Inc. and Top Of The Charts
Copyright Renewed
All Rights for the United States Controlled and Administered by Trio Music Company, Inc.
All Rights for the World excluding the United States Controlled and Administered by Trio Music Company, Inc. and Alley Music Corp.
International Copyright Secured All Rights Reserved
Used by Permission

(Sittin' On) The Dock Of The Bay

Words and Music by Steve Cropper and Otis Redding
 Copyright © 1968, 1975 IRVING MUSIC, INC.
 Copyright Renewed
 All Rights Reserved Used by Permission

Smoke Gets In Your Eyes

from ROBERTA
 Words by Otto Harbach
 Music by Jerome Kern
 © 1933 UNIVERSAL - POLYGRAM INTERNATIONAL PUBLISHING, INC.
 Copyright Renewed
 All Rights Reserved
 International Rights Secured. Not for broadcast transmission.
 DO NOT DUPLICATE. NOT FOR RENTAL.
 WARNING: It is a violation of Federal Copyright Law to synchronize this Multimedia Disc with video tape or film, or to print the Composition(s) embodied on this Multimedia Disc in the form of standard music notation, without the express written permission of the copyright owner.

Somewhere, My Love

Lara's Theme from DOCTOR ZHIVAGO
 Lyric by Paul Francis Webster
 Music by Maurice Jarre
 Copyright © 1965, 1966 (Renewed 1993, 1994) Webster Music Co. and EMI Robbins Catalog Inc.
 International Copyright Secured All Rights Reserved

Spanish Eyes

Words by Charles Singleton and Eddie Snyder
 Music by Bert Kaempfert
 © 1965, 1966 (Renewed 1993, 1994) EDITION DOMA BERT KAEMPFERT
 All Rights for the world, excluding Germany, Austria and Switzerland, Controlled and Administered by SCREEN GEMS-EMI MUSIC INC.
 All Rights Reserved International Copyright Secured Used by Permission

Speak Softly, Love (Love Theme)

from the Paramount Picture THE GODFATHER
 Words by Larry Kusik
 Music by Nino Rota
 Copyright © 1972 (Renewed 2000) by Famous Music Corporation
 International Copyright Secured All Rights Reserved

Stella By Starlight

from the Paramount Picture THE UNINVITED
 Words by Ned Washington
 Music by Victor Young
 Copyright © 1946 (Renewed 1973, 1974) by Famous Music Corporation
 International Copyright Secured All Rights Reserved

Take The "A" Train

Words and Music by Billy Strayhorn
 Copyright © 1941; Renewed 1969 DreamWorks Songs (ASCAP) and Billy Strayhorn Songs, Inc. (ASCAP) for the U.S.A.
 Rights for DreamWorks Songs and Billy Strayhorn Songs, Inc. Administered by Cherry Lane Music Publishing Company, Inc.
 International Copyright Secured All Rights Reserved

Tears In Heaven

Words and Music by Eric Clapton and Will Jennings
 Copyright © 1992 by E.C. Music Ltd. and Blue Sky Rider Songs
 All Rights for E.C. Music Ltd. Administered by Unichappell Music Inc.
 All Rights for Blue Sky Rider Songs Administered by Irving Music, Inc.
 International Copyright Secured All Rights Reserved

That Old Black Magic

from the Paramount Picture STAR SPANGLED RHYTHM
 Words by Johnny Mercer
 Music by Harold Arlen
 Copyright © 1942 (Renewed 1969) by Famous Music Corporation
 International Copyright Secured All Rights Reserved

That's Amore (That's Love)

from the Paramount Picture THE CADDY
 Words by Jack Brooks
 Music by Harry Warren
 Copyright © 1953 (Renewed 1981) by Paramount Music Corporation and Four Jays Music
 International Copyright Secured All Rights Reserved

Up Where We Belong

from the Paramount Picture AN OFFICER AND A GENTLEMAN
 Words by Will Jennings
 Music by Buffy Sainte-Marie and Jack Nitzsche
 Copyright © 1982 by Famous Music Corporation and Ensign Music Corporation
 International Copyright Secured All Rights Reserved

Waltz For Debby

Lyric by Gene Lees
 Music by Bill Evans
 TRO - © Copyright 1964 (Renewed), 1965 (Renewed), 1966 (Renewed)
 Folkways Music Publishers, Inc., New York, NY
 International Copyright Secured
 All Rights Reserved Including Public Performance For Profit
 Used by Permission

White Christmas

from the Motion Picture Irving Berlin's HOLIDAY INN
 Words and Music by Irving Berlin
 © Copyright 1940, 1942 by Irving Berlin
 Copyright Renewed
 International Copyright Secured All Rights Reserved

A Whole New World

from Walt Disney's ALADDIN
 Music by Alan Menken
 Lyrics by Tim Rice
 © 1992 Wonderland Music Company, Inc. and Walt Disney Music Company
 All Rights Reserved Used by Permission

Yesterday

Words and Music by John Lennon and Paul McCartney
 Copyright © 1965 Sony/ATV Songs LLC
 Copyright Renewed
 All Rights Administered by Sony/ATV Music Publishing, 8 Music Square West, Nashville, TN 37203
 International Copyright Secured All Rights Reserved

You Are The Sunshine Of My Life

Words and Music by Stevie Wonder
 © 1972 (Renewed 2000) JOBETE MUSIC CO., INC. and BLACK BULL MUSIC
 c/o EMI APRIL MUSIC INC.
 All Rights Reserved International Copyright Secured Used by Permission

You Sexy Thing

Words and Music by E. Brown
 Copyright © 1975 by Finchley Music Corp.
 Administered in the USA and Canada by Music & Media International, Inc.
 Administered for the World excluding the USA and Canada by RAK Music Publishing Ltd.
 International Copyright Secured All Rights Reserved

Important Notice: Guarantee Information for customers in European Economic Area (EEA) and Switzerland

<p>Important Notice: Guarantee Information for customers in EEA* and Switzerland</p> <p>For detailed guarantee information about this Yamaha product, and Pan-EEA* and Switzerland warranty service, please either visit the website address below (Printable file is available at our website) or contact the Yamaha representative office for your country. * EEA: European Economic Area</p>	English
<p>Wichtiger Hinweis: Garantie-Information für Kunden in der EWR und der Schweiz</p> <p>Für nähere Garantie-Information über dieses Produkt von Yamaha, sowie über den Pan-EWR- und Schweizer Garantieservice, besuchen Sie bitte entweder die folgend angegebene Internetadresse (eine druckfähige Version befindet sich auch auf unserer Webseite), oder wenden Sie sich an den für Ihr Land zuständigen Yamaha-Vertrieb.</p>	Deutsch
<p>Remarque importante: informations de garantie pour les clients de l'EEE et la Suisse</p> <p>Pour des informations plus détaillées sur la garantie de ce produit Yamaha et sur le service de garantie applicable dans l'ensemble de l'EEE ainsi qu'en Suisse, consultez notre site Web à l'adresse ci-dessous (le fichier imprimable est disponible sur notre site Web) ou contactez directement Yamaha dans votre pays de résidence. * EEE : Espace Economique Européen</p>	Français
<p>Belangrijke mededeling: Garantie-informatie voor klanten in de EER* en Zwitserland</p> <p>Voor gedetailleerde garantie-informatie over dit Yamaha-product en de garantieservice in heel de EER* en Zwitserland, gaat u naar de onderstaande website (u vindt een afdrukbaar bestand op onze website) of neemt u contact op met de vertegenwoordiging van Yamaha in uw land. * EER: Europese Economische Ruimte</p>	Nederlands
<p>Aviso importante: información sobre la garantía para los clientes del EEE* y Suiza</p> <p>Para una información detallada sobre este producto Yamaha y sobre el soporte de garantía en la zona EEE* y Suiza, visite la dirección web que se incluye más abajo (la versión del archivo para imprimir esta disponible en nuestro sitio web) o póngase en contacto con el representante de Yamaha en su país. * EEE: Espacio Económico Europeo</p>	Español
<p>Avviso importante: informazioni sulla garanzia per i clienti residenti nell'EEA* e in Svizzera</p> <p>Per informazioni dettagliate sulla garanzia relativa a questo prodotto Yamaha e l'assistenza in garanzia nei paesi EEA* e in Svizzera, potete consultare il sito Web all'indirizzo riportato di seguito (è disponibile il file in formato stampabile) oppure contattare l'ufficio di rappresentanza locale della Yamaha. * EEA: Area Economica Europea</p>	Italiano
<p>Aviso importante: informações sobre as garantias para clientes da AEE* e da Suíça</p> <p>Para obter uma informação pormenorizada sobre este produto da Yamaha e sobre o serviço de garantia na AEE* e na Suíça, visite o site a seguir (o arquivo para impressão está disponível no nosso site) ou entre em contato com o escritório de representação da Yamaha no seu país. * AEE: Área Económica Européia</p>	Português
<p>Σημαντική σημείωση: Πληροφορίες εγγύησης για τους πελάτες στον ΕΟΧ* και Ελλάδα</p> <p>Για λεπτομερείς πληροφορίες εγγύησης σχετικά με το παρόν προϊόν της Yamaha και την κάλυψη εγγύησης σε όλες τις χώρες του ΕΟΧ και την Ελλάδα, επισκεφτείτε την παρακάτω ιστοσελίδα (Εκτυπώσιμη μορφή είναι διαθέσιμη στην ιστοσελίδα μας) ή απευθυνθείτε στην αντιπροσωπεία της Yamaha στη χώρα σας. * ΕΟΧ: Ευρωπαϊκός Οικονομικός Χώρος</p>	Ελληνικά
<p>Viktigt: Garantiinformation för kunder i EES-området* och Schweiz</p> <p>För detaljerad information om denna Yamahaprodukt samt garantiservice i hela EES-området* och Schweiz kan du antingen besöka nedanstående webbadress (en utskriftsvänlig fil finns på webbplatsen) eller kontakta Yamahas officiella representant i ditt land. * EES: Europeiska Ekonomiska Samarbetsområdet</p>	Svenska
<p>Viktig merknad: Garantiinformasjon for kunder i EØS* og Sveits</p> <p>Detaljert garantiinformasjon om dette Yamaha-produktet og garantiservice for hele EØS-området* og Sveits kan fås enten ved å besøke nettstedene nedenfor (utskriftsversjon finnes på våre nettsider) eller kontakte Yamahas kontoret i landet der du bor. *EØS: Det europeiske økonomiske samarbeidsområdet</p>	Norsk
<p>Viktig oplysning: Garantioplysninger til kunder i EØO* og Schweiz</p> <p>De kan finde detaljerede garantioplysninger om dette Yamaha-produkt og den fælles garantiserviceordning for EØO* (og Schweiz) ved at besøge det websted, der er angivet nedenfor (der findes en fil, som kan udskrives, på vores websted), eller ved at kontakte Yamahas nationale repræsentationskontor i det land, hvor De bor. * EØO: Det Europæiske Økonomiske Område</p>	Dansk
<p>Tärkeä ilmoitus: Takuutiedot Euroopan talousalueen (ETA)* ja Sveitsin asiakkaille</p> <p>Tämän Yamaha-tuotteen sekä ETA-alueen ja Sveitsin takuuta koskevat yksityiskohtaiset tiedot saatte alla olevasta nettiosoitteesta. (Tulostettava tiedosto saatavissa sivustollamme.) Voitte myös ottaa yhteyttä paikalliseen Yamahadustajaan. *ETA: Euroopan talousalue</p>	Suomi
<p>Ważne: Warunki gwarancyjne obowiązujące w EOG* i Szwajcarii</p> <p>Aby dowiedzieć się więcej na temat warunków gwarancyjnych tego produktu fi rmy Yamaha i serwisu gwarancyjnego w całym EOG* i Szwajcarii, należy odwiedzić wskazaną poniżej stronę internetową (Plik gotowy do wydruku znajduje się na naszej stronie internetowej) lub skontaktować się z przedstawicielstwem fi rmy Yamaha w swoim kraju. * EOG — Europejski Obszar Gospodarczy</p>	Polski
<p>Důležité oznámení: Záruční informace pro zákazníky v EHS* a ve Švýcarsku</p> <p>Podrobné záruční informace o tomto produktu Yamaha a záručním servisu v celém EHS* a ve Švýcarsku naleznete na níže uvedené webové adrese (soubor k tisku je dostupný na našich webových stránkách) nebo se můžete obrátit na zástupce firmy Yamaha ve své zemi. * EHS: Evropský hospodářský prostor</p>	Česky
<p>Fontos figyelmeztetés: Garancia-információk az EGT* területén és Svájcban élő vásárlók számára</p> <p>A jelen Yamaha termékre vonatkozó részletes garancia-információk, valamint az EGT*-re és Svájcra kiterjedő garanciális szolgáltatás tekintetében keresse fel webhelyünket az alábbi címen (a webhelyen nyomtatható fájl is talál), vagy pedig lépjen kapcsolatba az országában működő Yamaha képviselői irodával. * EGT: Európai Gazdasági Térség</p>	Magyar
<p>Oluline märkus: Garantiiteave Euroopa Majanduspiirkonna (EMP)* ja Šveitsi klientidele</p> <p>Täpsema teabe saamiseks selle Yamaha toote garantii ning kogu Euroopa Majanduspiirkonna ja Šveitsi garantiiteeninduse kohta, külastage palun veebisaiti alljärgneval aadressil (meie saidil on saadaval printitav fail) või pöörduge Teie regiooni Yamaha esinduse poole. * EMP: Euroopa Majanduspiirkond</p>	Eesti keel
<p>Svarīgs paziņojums: garantijas informācija klientiem EEZ* un Šveicē</p> <p>Lai saņemtu detalizētu garantijas informāciju par šo Yamaha produktu, kā arī garantijas apkalpošanu EEZ* un Šveicē, lūdzu, apmeklējiet zemāk norādīto tīmekļa vietnes adresi (tīmekļa vietnē ir pieejams drukājams fails) vai sazinieties ar jūsu valsti apkalpojošo Yamaha pārstāvniecību. * EEZ: Eiropas Ekonomikas zona</p>	Latviešu
<p>Dėmesio: informacija dėl garantijos pirkėjams EEE* ir Šveicarijoje</p> <p>Jei reikia išsamios informacijos apie šį „Yamaha“ produktą ir jo techninę priežiūrą visoje EEE* ir Šveicarijoje, apsilankykite mūsų svetainėje toliau nurodytu adresu (svetainėje yra spausdintinas failas) arba kreipkitės į „Yamaha“ atstovybę savo šaliai. *EEE – Europos ekonominė erdvė</p>	Lietuvių kalba
<p>Dôležité upozornenie: Informácie o záruke pre zákazníkov v EHP* a Švajčiarsku</p> <p>Podrobné informácie o záruke týkajúce sa tohto produktu od spoločnosti Yamaha a garančnom servise v EHP* a Švajčiarsku nájdete na webovej stránke uvedenej nižšie (na našej webovej stránke je k dispozícii súbor na tlač) alebo sa obráťte na zástupcu spoločnosti Yamaha vo svojej krajine. * EHP: Európsky hospodársky priestor</p>	Slovenčina
<p>Pomembno obvestilo: Informacije o garanciji za kupce v EGP* in Švici</p> <p>Za podrobnejše informacije o tem Yamahinem izdelku ter garancijskem servisu v celotnem EGP in Švici, obiščite spletno mesto, ki je navedeno spodaj (natisljiva datoteka je na voljo na našem spletnem mestu), ali se obrnite na Yamahinega predstavnika v svoji državi. * EGP: Evropski gospodarski prostor</p>	Slovensčina
<p>Важно съобщение: Информация за гаранцията за клиенти в ЕИП* и Швейцария</p> <p>За подробна информация за гаранцията за този продукт на Yamaha и гаранционното обслужване в паневропейската зона на ЕИП* и Швейцария или посетете посочения по-долу уеб сайт (на нашия уеб сайт има файл за печат), или се свържете с представителния офис на Yamaha във вашата страна. * ЕИП: Европейско икономическо пространство</p>	Български език
<p>Notificare importantă: Informații despre garanție pentru clienții din SEE* și Elveția</p> <p>Pentru informații detaliate privind acest produs Yamaha și serviciul de garanție Pan-SEE* și Elveția, vizitați site-ul la adresa de mai jos (fișierul imprimabil este disponibil pe site-ul nostru) sau contactați biroul reprezentanței Yamaha din țara dumneavoastră. * SEE: Spațiul Economic European</p>	Limba română

<http://europe.yamaha.com/warranty/>

Yamaha Representative Offices in Europe

AUSTRIA

Yamaha Music Europe GmbH
Branch Austria
Schleiergasse 20, A-1100 Wien Austria
Tel: +43 (0)1 602 03900
Fax: +43 (0)1 602 039051

BELGIUM

Yamaha Music Europe
Branch Benelux
Clarissenhof 5b NL, 4133 AB. Vianen
The Netherlands
Tel: +31 (0)347 358040
Fax: +31 (0)347 358060

BULGARIA

Yamaha Music Europe GmbH
Branch Austria (Central and Eastern Europe)
Schleiergasse 20, A-1100 Wien Austria
Tel: +43 (0)1 602 03900
Fax: +43 (0)1 602 039051

CYPRUS

NAKAS Music Cyprus Ltd.
31C Nikis Ave., 1086 Nicosia
Tel: +357 (0)22 510 477
Fax: +357 (0)22 511 080

CZECH REPUBLIC

Yamaha Music Europe GmbH
Branch Austria (Central and Eastern Europe)
Schleiergasse 20, A-1100 Wien Austria
Tel: +43 (0)1 602 03900
Fax: +43 (0)1 602 039051

DENMARK

YS Copenhagen Liaison Office
(Yamaha Scandinavia AB Filial Denmark)
Generatorvej 6A, 2730 Herlev, Denmark
Tel: +45 44 92 49 00
Fax: +45 44 54 47 09

ESTONIA

Yamaha Music Europe GmbH
Sp. z o.o. Oddział w Polsce
(Branch Poland)
ul. 17 Stycznia 56
PL-02-146 Warszawa Poland
Tel: +48 (0)22 500 29 25
Fax: +48 (0)22 500 29 30

FINLAND

(For Musical Instrument)
F - Musiikki OY
Kaisaniemenkatu 7, PL260
00101 Helsinki, Finland
Tel: +358 (0)9 618511
Fax: +358 (0)9 61851385

(For Pro Audio)

Yamaha Scandinavia AB
J A Wettergrens gata 1
Västra Frölunda, Sweden
(Box 300 53, 400 43 Goteborg
Sweden - Postal Address)
Tel: +46 (0)31 893400
Fax: +46 (0)31 454026

FRANCE

Yamaha Musique France
Zone d'activité de Pariest
7, rue Ambroise Croizat
77183 Croissy-Beaubourg, France
(B.P. 70, 77312 Marne la Vallée Cedex 2
France-Adresse postale)
Tel: +33 (0)1 64 61 4000
Fax: +33 (0)1 64 61 4079

GERMANY

Yamaha Music Europe GmbH
Siemensstr 22-34
D-25462 Rellingen, b. Hamburg, Germany
Tel: +49 (0)4101 3030
Fax: +49 (0)4101 303 77702

GREECE

PH. Nakas S.A.Music House/Service
19 KM Leoforos Lavriou
19002 Peania / Attiki, Greece
Tel: +30 (0)210 6686260
Fax: +30 (0)210 6686269

HUNGARY

Yamaha Music Europe GmbH
Branch Austria (Central and Eastern Europe)
Schleiergasse 20, A-1100 Wien Austria
Tel: +43 (0)1 602 03900
Fax: +43 (0)1 602 039051

ICELAND

(For Musical Instrument)
HLJODFAERAHUSID EHF
Sidumula 20
108 Reykjavik, Iceland
Tel: +354 525 50 50
Fax: +354 568 65 14

(For Pro Audio)

Yamaha Scandinavia AB
J A Wettergrens gata 1
Västra Frölunda, Sweden
(Box 300 53, 400 43 Goteborg
Sweden - Postal Address)
Tel: +46 (0)31 893400
Fax: +46 (0)31 454026

IRELAND (REPUBLIC OF IRELAND)

Yamaha Music UK Ltd.
Sherbourne Drive
Tilbrook, Milton Keynes MK7 8BL
United Kingdom
Tel: +353 (0) 1526 2449
Fax: +44 (0) 1908 369278

ITALY

Yamaha Musica Italia s.p.a.
Viale Italia 88
20020, Lainate (Milano), Italy
Tel: +39 (0)02 93577 1
Fax: +39 (0)02 937 0956

LATVIA

Yamaha Music Europe GmbH
Sp. z o.o. Oddział w Polsce
(Branch Poland)
ul. 17 Stycznia 56
PL-02-146 Warszawa Poland
Tel: +48 (0)22 500 29 25
Fax: +48 (0)22 500 29 30

LIECHTENSTEIN

Yamaha Music Europe GmbH, Rellingen,
Branch Switzerland in Zurich
Seefeldstrasse 94, CH-8008
Zürich, Switzerland
Tel: +41 (0)1 3833990
Fax: +41 (0)1 3833918

LITHUANIA

Yamaha Music Europe GmbH
Sp. z o.o. Oddział w Polsce
(Branch Poland)
ul. 17 Stycznia 56
PL-02-146 Warszawa Poland
Tel: +48 (0)22 500 29 25
Fax: +48 (0)22 500 29 30

LUXEMBOURG

Yamaha Music Europe
Branch Benelux
Clarissenhof 5b NL, 4133 AB. Vianen
The Netherlands
Tel: +31 (0)347 358040
Fax: +31 (0)347 358060

MALTA

Olimpus Music Ltd.
The Emporium, Level 3, St. Louis Street
Msida MSD06
Tel: +356 (0)2133 2093
Fax: +356 (0)2133 2144

NETHERLANDS

Yamaha Music Europe
Branch Benelux
Clarissenhof 5b NL, 4133 AB. Vianen
The Netherlands
Tel: +31 (0)347 358040
Fax: +31 (0)347 358060

NORWAY

YS Oslo Liaison Office
(Yamaha Scandinavia AB Filial Norway)
Grini Naeringspark 1
1361 Osteras, Norway
Tel: +47 67 16 77 70
Fax: +47 67 16 77 79

POLAND

YAMAHA Music Europe GmbH
Sp. z o.o. Oddział w Polsce
ul. 17 Stycznia 56
02-146 WARSZAWA/POLSKA
Tel: +48 (0)22 500 29 25
Fax: +48 (0)22 500 29 30

PORTUGAL

Yamaha Música Ibérica, S.A.U.
Sucursal Portuguesa
Rua Alfredo da Silva
2610-016 Amadora, Portugal
Tel: +351 214 704 330
Fax: +351 214 718 220

ROMANIA

Yamaha Music Europe GmbH
Branch Austria (Central and Eastern Europe)
Schleiergasse 20, A-1100 Wien Austria
Tel: +43 (0)1 602 03900
Fax: +43 (0)1 602 039051

SLOVAKIA

Yamaha Music Europe GmbH
Branch Austria (Central and Eastern Europe)
Schleiergasse 20, A-1100 Wien Austria
Tel: +43 (0)1 602 03900
Fax: +43 (0)1 602 039051

SLOVENIA

Yamaha Music Europe GmbH
Branch Austria (Central and Eastern Europe)
Schleiergasse 20, A-1100 Wien Austria
Tel: +43 (0)1 602 03900
Fax: +43 (0)1 602 039051

SPAIN

Yamaha Música Ibérica, S.A.U.
Ctra. de la Coruna km.17, 200
28230 Las Rozas de Madrid, Spain
Tel: +34 902 39 8888
Fax: +34 91 638 4660

SWEDEN

Yamaha Scandinavia AB
J A Wettergrens gata 1
Västra Frölunda, Sweden
(Box 300 53, 400 43 Goteborg
Sweden - Postal Address)
Tel: +46 (0)31 893400
Fax: +46 (0)31 454026

SWITZERLAND

Yamaha Music Europe GmbH, Rellingen,
Branch Switzerland in Zurich
Seefeldstrasse 94, CH-8008
Zürich, Switzerland
Tel: +41 (0)1 3833990
Fax: +41 (0)1 3833918

UNITED KINGDOM

Yamaha Music UK Ltd.
Sherbourne Drive
Tilbrook, Milton Keynes MK7 8BL
United Kingdom
Tel: +44 (0) 870 4445575
Fax: +44 (0) 1908 369278

FCC INFORMATION (U.S.A.)

1. IMPORTANT NOTICE: DO NOT MODIFY THIS UNIT!

This product, when installed as indicated in the instructions contained in this manual, meets FCC requirements. Modifications not expressly approved by Yamaha may void your authority, granted by the FCC, to use the product.

2. IMPORTANT:

When connecting this product to accessories and/or another product use only high quality shielded cables. Cable/s supplied with this product MUST be used. Follow all installation instructions. Failure to follow instructions could void your FCC authorization to use this product in the USA.

3. NOTE:

This product has been tested and found to comply with the requirements listed in FCC Regulations, Part 15 for Class "B" digital devices. Compliance with these requirements provides a reasonable level of assurance that your use of this product in a residential environment will not result in harmful interference with other electronic devices. This equipment generates/uses radio frequencies and, if not installed and used according to the instructions found in the users manual, may cause interference harmful to the operation of other electronic devices. Compliance with FCC regulations does not guarantee

that interference will not occur in all installations. If this product is found to be the source of interference, which can be determined by turning the unit "OFF" and "ON", please try to eliminate the problem by using one of the following measures:

Relocate either this product or the device that is being affected by the interference.

Utilize power outlets that are on different branch (circuit breaker or fuse) circuits or install AC line filter/s.

In the case of radio or TV interference, relocate/reorient the antenna. If the antenna lead-in is 300 ohm ribbon lead, change the lead-in to co-axial type cable.

If these corrective measures do not produce satisfactory results, please contact the local retailer authorized to distribute this type of product. If you can not locate the appropriate retailer, please contact Yamaha Corporation of America, Electronic Service Division, 6600 Orangethorpe Ave, Buena Park, CA90620

The above statements apply ONLY to those products distributed by Yamaha Corporation of America or its subsidiaries.

* This applies only to products distributed by YAMAHA CORPORATION OF AMERICA.

(class B)

IMPORTANT NOTICE FOR THE UNITED KINGDOM Connecting the Plug and Cord

IMPORTANT. The wires in this mains lead are coloured in accordance with the following code:

BLUE : NEUTRAL
BROWN : LIVE

As the colours of the wires in the mains lead of this apparatus may not correspond with the coloured markings identifying the terminals in your plug proceed as follows:

The wire which is coloured BLUE must be connected to the terminal which is marked with the letter N or coloured BLACK.

The wire which is coloured BROWN must be connected to the terminal which is marked with the letter L or coloured RED.

Making sure that neither core is connected to the earth terminal of the three pin plug.

* This applies only to products distributed by Yamaha Music U.K. Ltd. (2 wires)

COMPLIANCE INFORMATION STATEMENT (DECLARATION OF CONFORMITY PROCEDURE)

Responsible Party : Yamaha Corporation of America

Address : 6600 Orangethorpe Ave., Buena Park,
Calif. 90620

Telephone : 714-522-9011

Type of Equipment : Digital Piano

Model Name : CVP-509/505/503/501

This device complies with Part 15 of the FCC Rules.

Operation is subject to the following two conditions:

- 1) this device may not cause harmful interference, and
- 2) this device must accept any interference received including interference that may cause undesired operation.

See user manual instructions if interference to radio reception is suspected.

* This applies only to products distributed by
YAMAHA CORPORATION OF AMERICA.

(FCC DoC)

The serial number of this product may be found on the bottom of the unit. You should note this serial number in the space provided below and retain this manual as a permanent record of your purchase to aid identification in the event of theft.

Model No.

Serial No.

(bottom)

For details of products, please contact your nearest Yamaha representative or the authorized distributor listed below.

Pour plus de détails sur les produits, veuillez-vous adresser à Yamaha ou au distributeur le plus proche de vous figurant dans la liste suivante.

Die Einzelheiten zu Produkten sind bei Ihrer unten aufgeführten Niederlassung und bei Yamaha Vertragshändlern in den jeweiligen Bestimmungsländern erhältlich.

Para detalles sobre productos, contacte su tienda Yamaha más cercana o el distribuidor autorizado que se lista debajo.

NORTH AMERICA

CANADA

Yamaha Canada Music Ltd.
135 Milner Avenue, Scarborough, Ontario,
M1S 3R1, Canada
Tel: 416-298-1311

U.S.A.

Yamaha Corporation of America
6600 Orangethorpe Ave., Buena Park, Calif. 90620,
U.S.A.
Tel: 714-522-9011

CENTRAL & SOUTH AMERICA

MEXICO

Yamaha de México S.A. de C.V.
Calz. Javier Rojo Gómez #1149,
Col. Guadalupe del Moral
C.P. 09300, México, D.F., México
Tel: 55-5804-0600

BRAZIL

Yamaha Musical do Brasil Ltda.
Rua Joaquim Floriano, 913 - 4º andar, Itaim Bibi,
CEP 04534-013 Sao Paulo, SP. BRAZIL
Tel: 011-3704-1377

ARGENTINA

Yamaha Music Latin America, S.A.
Sucursal de Argentina
Olga Cossetтини 1553, Piso 4 Norte
Madero Este-C1107CEK
Buenos Aires, Argentina
Tel: 011-4119-7000

PANAMA AND OTHER LATIN AMERICAN COUNTRIES/ CARIBBEAN COUNTRIES

Yamaha Music Latin America, S.A.
Torre Banco General, Piso 7, Urbanización Marbella,
Calle 47 y Aquilino de la Guardia,
Ciudad de Panamá, Panamá
Tel: +507-269-5311

EUROPE

THE UNITED KINGDOM/IRELAND

Yamaha Music U.K. Ltd.
Sherbourne Drive, Tilbrook, Milton Keynes,
MK7 8BL, England
Tel: 01908-366700

GERMANY

Yamaha Music Europe GmbH
Siemensstraße 22-34, 25462 Rellingen, Germany
Tel: 04101-3030

SWITZERLAND/LIECHTENSTEIN

Yamaha Music Europe GmbH
Branch Switzerland in Zürich
Seefeldstrasse 94, 8008 Zürich, Switzerland
Tel: 01-383 3990

AUSTRIA

Yamaha Music Europe GmbH Branch Austria
Schleiergasse 20, A-1100 Wien, Austria
Tel: 01-60203900

CZECH REPUBLIC/SLOVAKIA/ HUNGARY/SLOVENIA

Yamaha Music Europe GmbH Branch Austria
Schleiergasse 20, A-1100 Wien, Austria
Tel: 01-602039025

POLAND/LITHUANIA/LATVIA/ESTONIA

Yamaha Music Europe GmbH
Branch Sp.z o.o. Oddział w Polsce
ul. 17 Stycznia 56, PL-02-146 Warszawa, Poland
Tel: 022-868-07-57

THE NETHERLANDS/ BELGIUM/LUXEMBOURG

Yamaha Music Europe Branch Benelux
Clarissenhof 5-b, 4133 AB Vianen, The Netherlands
Tel: 0347-358 040

FRANCE

Yamaha Musique France
BP 70-77312 Marne-la-Vallée Cedex 2, France
Tel: 01-64-61-4000

ITALY

Yamaha Musica Italia S.P.A.
Viale Italia 88, 20020 Lainate (Milano), Italy
Tel: 02-935-771

SPAIN/PORTUGAL

Yamaha Música Ibérica, S.A.
Ctra. de la Coruna km. 17, 200, 28230
Las Rozas (Madrid), Spain
Tel: 91-639-8888

GREECE

Philippos Nakas S.A. The Music House
147 Skiathou Street, 112-55 Athens, Greece
Tel: 01-228 2160

SWEDEN

Yamaha Scandinavia AB
J. A. Wettergrens Gata 1, Box 30053
S-400 43 Göteborg, Sweden
Tel: 031 89 34 00

DENMARK

YS Copenhagen Liaison Office
Generatorvej 6A, DK-2730 Herlev, Denmark
Tel: 44 92 49 00

FINLAND

F-Musiikki Oy
Kluuvikatu 6, P.O. Box 260,
SF-00101 Helsinki, Finland
Tel: 09 618511

NORWAY

Norsk filial av Yamaha Scandinavia AB
Grini Næringspark 1, N-1345 Østerås, Norway
Tel: 67 16 77 70

ICELAND

Skiifan HF
Skeifan 17 P.O. Box 8120, IS-128 Reykjavik, Iceland
Tel: 525 5000

RUSSIA

Yamaha Music (Russia)
Office 4015, entrance 2, 21/5 Kuznetskii
Most street, Moscow, 107996, Russia
Tel: 495 626 0660

OTHER EUROPEAN COUNTRIES

Yamaha Music Europe GmbH
Siemensstraße 22-34, 25462 Rellingen, Germany
Tel: +49-4101-3030

AFRICA

Yamaha Corporation,
Asia-Pacific Music Marketing Group
Nakazawa-cho 10-1, Naka-ku, Hamamatsu,
Japan 430-8650
Tel: +81-53-460-2312

MIDDLE EAST

TURKEY/CYPRUS

Yamaha Music Europe GmbH
Siemensstraße 22-34, 25462 Rellingen, Germany
Tel: 04101-3030

OTHER COUNTRIES

Yamaha Music Gulf FZE
LOB 16-513, P.O.Box 17328, Jubel Ali,
Dubai, United Arab Emirates
Tel: +971-4-881-5868

ASIA

THE PEOPLE'S REPUBLIC OF CHINA

Yamaha Music & Electronics (China) Co.,Ltd.
2F, Yunhedasha, 1818 Xinzha-lu, Jingan-qu,
Shanghai, China
Tel: 021-6247-2211

HONG KONG

Tom Lee Music Co., Ltd.
11/F., Silvercord Tower 1, 30 Canton Road,
Tsimshatsui, Kowloon, Hong Kong
Tel: 2737-7688

INDIA

Yamaha Music India Pvt. Ltd.
5F Ambience Corporate Tower Ambience Mall Complex
Ambience Island, NH-8, Gurgaon-122001, Haryana, India
Tel: 0124-466-5551

INDONESIA

PT. Yamaha Music Indonesia (Distributor)
PT. Nusantik
Gedung Yamaha Music Center, Jalan Jend. Gatot
Subroto Kav. 4, Jakarta 12930, Indonesia
Tel: 21-520-2577

KOREA

Yamaha Music Korea Ltd.
8F, 9F, Dongsung Bldg. 158-9 Samsung-Dong,
Kangnam-Gu, Seoul, Korea
Tel: 080-004-0022

MALAYSIA

Yamaha Music Malaysia, Sdn., Bhd.
Lot 8, Jalan Perbandaran, 47301 Kelana Jaya,
Petaling Jaya, Selangor, Malaysia
Tel: 3-78030900

PHILIPPINES

Yupangco Music Corporation
339 Gil J. Puyat Avenue, P.O. Box 885 MCPO,
Makati, Metro Manila, Philippines
Tel: 819-7551

SINGAPORE

Yamaha Music Asia Pte., Ltd.
#03-11 A-Z Building
140 Paya Lebar Road, Singapore 409015
Tel: 747-4374

TAIWAN

Yamaha KHS Music Co., Ltd.
3F, #6, Sec.2, Nan Jing E. Rd. Taipei.
Taiwan 104, R.O.C.
Tel: 02-2511-8688

THAILAND

Siam Music Yamaha Co., Ltd.
4, 6, 15 and 16th floor, Siam Motors Building,
891/1 Rama 1 Road, Wangmai,
Pathumwan, Bangkok 10330, Thailand
Tel: 02-215-2626

OTHER ASIAN COUNTRIES

Yamaha Corporation,
Asia-Pacific Music Marketing Group
Nakazawa-cho 10-1, Naka-ku, Hamamatsu,
Japan 430-8650
Tel: +81-53-460-2317

OCEANIA

AUSTRALIA

Yamaha Music Australia Pty. Ltd.
Level 1, 99 Queensbridge Street, Southbank,
Victoria 3006, Australia
Tel: 3-9693-5111

NEW ZEALAND

Music Works LTD
P.O. BOX 6246 Wellesley, Auckland 4680,
New Zealand
Tel: 9-634-0099

COUNTRIES AND TRUST TERRITORIES IN PACIFIC OCEAN

Yamaha Corporation,
Asia-Pacific Music Marketing Group
Nakazawa-cho 10-1, Naka-ku, Hamamatsu,
Japan 430-8650
Tel: +81-53-460-2312

HEAD OFFICE Yamaha Corporation, Pro Audio & Digital Musical Instrument Division
Nakazawa-cho 10-1, Naka-ku, Hamamatsu, Japan 430-8650
Tel: +81-53-460-3273



Yamaha Home Keyboards Home Page
<http://music.yamaha.com/homekeyboard/>

Yamaha Manual Library
<http://www.yamaha.co.jp/manual/>

U.R.G., Pro Audio & Digital Musical Instrument Division, Yamaha Corporation
© 2009 Yamaha Corporation

WR05330 911MWAP5.2-04D0
Printed in China