



**DVD HOME THEATER SYSTEM
SYSTEME HOME CINEMA AVEC LECTUER DVD**

DVX-700

(DVR-700 + NS-PSW700 + NS-P700)

**OWNER'S MANUAL
MODE D'EMPLOI**

IMPORTANT SAFETY INSTRUCTIONS

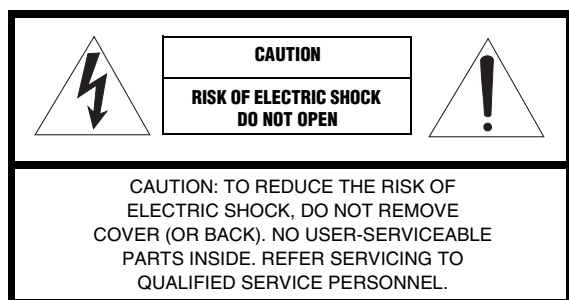

• Explanation of Graphical Symbols



The lightning flash with arrowhead symbol, within an equilateral triangle, is intended to alert you to the presence of uninsulated “dangerous voltage” within the product’s enclosure that may be of sufficient magnitude to constitute a risk of electric shock to persons.



The exclamation point within an equilateral triangle is intended to alert you to the presence of important operating and maintenance (servicing) instructions in the literature accompanying the appliance.

Note to CATV system installer:

This reminder is provided to call the CATV system installer’s attention to Article 820-40 of the NEC that provides guidelines for proper grounding and, in particular, specifies that the cable ground shall be connected to the grounding system of the building, as close to the point of cable entry as practical.

- 1 Read these instructions.
- 2 Keep these instructions.
- 3 Heed all warnings.
- 4 Follow all instructions.
- 5 Do not use this apparatus near water.
- 6 Clean only with dry cloth.
- 7 Do not block any ventilation openings. Install in accordance with the manufacturer’s instructions.
- 8 Do not install near any heat sources such as radiators, heat registers, stoves, or other apparatus (including amplifiers) that produce heat.
- 9 Do not defeat the safety purpose of the polarized or grounding-type plug. A polarized plug has two blades with one wider than the other. A grounding type plug has two blades and a third grounding prong. The wide blade or the third prong are provided for your safety. If the provided plug does not fit into your outlet, consult an electrician for replacement of the obsolete outlet.
- 10 Protect the power cord from being walked on or pinched particularly at plugs, convenience receptacles, and the point where they exit from the apparatus.
- 11 Only use attachments/accessories specified by the manufacturer.
- 12 Use only with the cart, stand, tripod, bracket, or table specified by the manufacturer, or sold with the apparatus. When a cart is used, use caution when moving the cart/apparatus combination to avoid injury from tip-over.
- 13 Unplug this apparatus during lightning storms or when unused for long periods of time.
- 14 Refer all servicing to qualified service personnel. Servicing is required when the apparatus has been damaged in any way, such as power-supply cord or plug is damaged, liquid has been spilled or objects have fallen into the apparatus, the apparatus has been exposed to rain or moisture, does not operate normally, or has been dropped.



FCC INFORMATION (for US customers)

1 IMPORTANT NOTICE: DO NOT MODIFY THIS UNIT!

This product, when installed as indicated in the instructions contained in this manual, meets FCC requirements. Modifications not expressly approved by Yamaha may void your authority, granted by the FCC, to use the product.

- 2 **IMPORTANT:** When connecting this product to accessories and/or another product use only high quality shielded cables. Cable/s supplied with this product **MUST** be used. Follow all installation instructions. Failure to follow instructions could void your FCC authorization to use this product in the USA.

- 3 **NOTE:** This product has been tested and found to comply with the requirements listed in FCC Regulations, Part 15 for Class “B” digital devices. Compliance with these requirements provides a reasonable level of assurance that your use of this product in a residential environment will not result in harmful interference with other electronic devices.

This equipment generates/uses radio frequencies and, if not installed and used according to the instructions found in the users manual, may cause interference harmful to the operation of other electronic devices.

Compliance with FCC regulations does not guarantee that interference will not occur in all installations. If this product is found to be the source of interference, which can be determined by turning the unit “OFF” and “ON”, please try to eliminate the problem by using one of the following measures:

Relocate either this product or the device that is being affected by the interference.

Utilize power outlets that are on different branch (circuit breaker or fuse) circuits or install AC line filter/s.

In the case of radio or TV interference, relocate/reorient the antenna. If the antenna lead-in is 300 ohm ribbon lead, change the lead-in to coaxial type cable.

If these corrective measures do not produce satisfactory results, please contact the local retailer authorized to distribute this type of product. If you can not locate the appropriate retailer, please contact Yamaha Electronics Corp., U.S.A. 6660 Orangethorpe Ave, Buena Park, CA 90620.

The above statements apply **ONLY** to those products distributed by Yamaha Corporation of America or its subsidiaries.

Caution: read this before operating your unit.

- 1 To assure the finest performance, please read this manual carefully. Keep it in a safe place for future reference.
- 2 Install this sound system in a well ventilated, cool, dry, clean place — way from direct sunlight, heat sources, vibration, dust, moisture, and/or cold. Allow ventilation space of at least 5 cm on the top, left, right, and the back of this unit.
- 3 Locate this unit away from other electrical appliances, motors, or transformers to avoid humming sounds.
- 4 Do not expose this unit to sudden temperature changes from cold to hot, nor locate this unit in an environment with high humidity (i.e., a room with a humidifier) to prevent condensation inside this unit, which may cause an electrical shock, fire, damage to this unit, and/or personal injury.
- 5 Avoid installing this unit in a location where foreign objects may fall onto this unit or where this unit may be exposed to liquid dripping or splashing. On the top of this unit, do not place:
 - Other components, as they may cause damage and/or discoloration on the surface of this unit.
 - Burning objects (i.e., candles), as they may cause fire, damage to this unit, and/or personal injury.
 - Containers with liquid in them, as they may fall, spilling the liquid and causing an electrical shock to the user and/or damage to this unit.
- 6 Do not cover this unit with a newspaper, tablecloth, curtain, etc. in order not to obstruct heat radiation. If the temperature inside this unit rises, it may cause fire, damage to this unit, and/or personal injury.
- 7 Do not plug in this unit to a wall outlet until all connections are complete.
- 8 Do not operate this unit upside-down. It may overheat, possibly causing damage.
- 9 Do not use excessive force on switches, knobs and/or cords.
- 10 When disconnecting the power cord from the wall outlet, grasp the plug; do not pull the cord.
- 11 Do not clean this unit with chemical solvents; this might damage the finish. Use a clean, dry cloth.
- 12 Use only the voltage specified on this unit. Using this unit with a higher voltage than specified is dangerous and may cause fire, damage to this unit, and/or personal injury. Yamaha will not be held responsible for any damage resulting from use of this unit with a voltage other than as specified.
- 13 To prevent damage by lightning, keep the power cord out and outdoor antennas disconnected from a wall outlet or the unit during a lightning storm.
- 14 Do not attempt to modify or fix this unit. Contact qualified Yamaha service personnel when any service is needed. The cabinet should never be opened for any reason.
- 15 When not planning to use this unit for long periods of time (i.e., vacation), disconnect the AC power plug from the wall outlet.
- 16 Be sure to read the “TROUBLESHOOTING” section on common operating errors before concluding that this unit is faulty.
- 17 Before moving this unit, press STANDBY/ON to set the unit in standby mode, then disconnect the AC power plug from the wall outlet.
- 18 Condensation will form when the surrounding temperature changes suddenly. Disconnect the power cable from the outlet, then leave the unit alone.
- 19 When using the unit for a long time, the unit may become warm. Turn the power off, then leave the unit alone for cooling.
- 20 Install this unit near the AC outlet and where the AC power plug can be reached easily.
- 21 The batteries shall not be exposed to excessive heat such as sunshine, fire or like.
- 22 Excessive sound pressure from earphones and headphones can cause hearing loss.
- 23 When replacing the batteries, be sure to use batteries of the same type. Danger of explosion may happen if batteries are incorrectly replaced.

This unit is not disconnected from the AC power source as long as it is connected to the wall outlet, even if this unit itself is turned off. This state is called the standby mode. In this state, this unit is designed to consume a very small quantity of power.

Laser component in this product is capable of emitting radiation exceeding the limit for Class 1.

WARNING
TO REDUCE THE RISK OF FIRE OR ELECTRIC SHOCK, DO NOT EXPOSE THIS UNIT TO RAIN OR MOISTURE.

CAUTION
Danger of explosion if battery is incorrectly replaced. Replace only with the same or equivalent type.

FOR CANADIAN CUSTOMERS
To prevent electric shock, match wide blade of plug to wide slot and fully insert.
This Class B digital apparatus complies with Canadian ICES-003.

IMPORTANT
Please record the serial number of this unit in the space below.
MODEL:
Serial No.:
The serial number is located on the rear of the unit.
Retain this Owner's Manual in a safe place for future reference.

LASER SAFETY

This unit employs a laser. Due to possible eye injury, only a qualified service person should remove the cover or attempt to service this device.

DANGER

This unit emits visible laser radiation when open. Avoid direct eye exposure to beam. When this unit is plugged into a wall outlet, do not place your eyes close to the opening of the disc loader and other openings or look inside.

LASER

Type	Semiconductor laser ALGaInP
Wave length	655nm (DVD) 790nm (VCD/CD)
Output Power	5/7mW (DVD/VCD,CD)
Beam divergence	20degrees

CAUTION

Use of controls or adjustments or performance of procedures other than those specified herein may result in hazardous radiation exposure.

CONTENTS

1. INTRODUCTION

INTRODUCTION	2
Main unit.....	4
Supplied accessories.....	4
FUNCTIONAL OVERVIEW	5
Front panel (DVR-700).....	5
Rear panel (DVR-700).....	6
Front panel display (DVR-700).....	7
Rear panel (NS-PSW700).....	8
Remote control.....	9

2. CONNECTIONS

CONNECTIONS	11
Roles and layout of the speakers.....	11
Placing the speakers using the stands.....	12
Placing the speakers on a wall.....	12
SYSTEM CONNECTIONS	14
Connecting the speakers.....	14
Connecting the DVD controller and the subwoofer/system control.....	16
OTHER CONNECTIONS	17
Connecting a TV.....	17
Connecting an HDMI component.....	18
Connecting the FM antenna.....	18
Connecting external AV components.....	19
Connecting the power cable.....	20

3. PREPARATION

GETTING STARTED	21
Inserting batteries into the remote control.....	21
Using the remote control.....	21
Turn on the system.....	22
Setting the video input/output.....	23
Setting language preferences.....	25

4. BASIC OPERATIONS

DISC OPERATION	26
Playing discs.....	26
Basic playback controls.....	27
Ejecting a disc.....	28
Using the disc menu (DVD only).....	28
Playback control (PBC) (Video CD only).....	28
Changing soundtrack language.....	28
Changing subtitle language.....	29
Resuming playback from the last stopped point.....	29
Viewing from another angle.....	29
Displaying disc information.....	29
Zooming in.....	29
Advanced operation.....	30
Disc navigator.....	32
PLAYING OTHER DISCS	33
To play back audio files.....	33
To start a slide show of JPEG files.....	34
Selecting a file to play back.....	34
Using a USB device.....	35

5. DVD SETUP MENU

DVD SETUP MENU OPTIONS	36
Menu overview.....	36
VIDEO ADJUST MENU	37

INITIAL SETTINGS MENU	38
Video Output.....	38
Language.....	40
Display.....	41
Options.....	41

6. OTHER FUNCTIONS

AIR SURROUND XTREME	43
What is AIR SURROUND XTREME?.....	43
Listening to surround mode of AIR SURROUND XTREME.....	43
Shifting the optimum listening area from side to side.....	44
Selecting the optimum distance between the speakers.....	44
Checking the virtual surround effect.....	45
Using extended stereo mode.....	45
Setting compressed music enhancer.....	45
LISTENING TO FM BROADCASTS	46
Basic tuning operation.....	46
Using station preset feature.....	47
Recalling the preset stations.....	49
LISTENING TO XM® SATELLITE RADIO BROADCASTS	50
Connecting XM Mini-Tuner Home Dock.....	50
Activating XM Satellite Radio.....	50
Basic XM Satellite Radio operations.....	51
Setting the XM Satellite Radio preset channels.....	52
Displaying the XM Satellite Radio information.....	53
LISTENING TO SIRIUS SATELLITE RADIO™ BROADCASTS	54
Connecting the SiriusConnect™ tuner.....	54
Activating SIRIUS Satellite Radio™ subscription.....	55
Basic SIRIUS Satellite Radio™ operations.....	55
Setting the SIRIUS Satellite Radio™ preset channels.....	57
Setting the Parental Lock.....	58
Displaying the SIRIUS Satellite Radio™ information.....	59
USING OPTIONAL EQUIPMENT	60
Using iPod™.....	60
Using Bluetooth™ components.....	61

7. USEFUL OPERATION

USEFUL OPERATION	63
Adjusting the audio delay.....	63
Listening at low volume (night listening mode).....	63
Adjusting the audio balance for the playback.....	64
Changing the brightness of the front panel display.....	64
Setting the sleep timer.....	65
System menu.....	65
Setting the preset code.....	66

8. ADDITIONAL INFORMATION

TROUBLESHOOTING	67
GLOSSARY	74
SPECIFICATIONS	76
INDEX	77

APPENDIX

LIST OF PRESET CODES.....	i
LIST OF COUNTRY CODES.....	ii
LIST OF LANGUAGE CODES.....	iii

1

2

3

4

5

6

7

8

English

INTRODUCTION

Thank you for purchasing this unit. This Owner's Manual explains the basic operation of this unit.

Notes about discs

- This DVD controller is designed for use with the following discs.
 - DVD disc: DVD-Video, DVD-R/-RW/-R DL, DVD+R/+RW/+R DL
 - Compact Disc: Audio CD, CD-R, CD-RW, Video CD, Super Video CD

Notes

- DVD-R/-RW/-R DL and DVD+R/+RW/+R DL discs recorded in DVD-Video compatible format.
- DVD-R/-RW/-R DL discs recorded in VR format (compatible with CPRM).
- CD-R/RW, DVD-R/-RW/-R DL and DVD+R/+RW/+R DL cannot be played unless finalized.
- Multi-session discs are not supported.
- Some discs recorded on PC cannot be played depending on the settings of the application software.
- Discs recorded on PC in packet write format are not compatible with this DVD controller.
- This unit is not compatible with 8-cm discs.



This controller can play the following formatted files recorded on CD-R/RW, DVD-R/-RW, DVD+R/+RW and USB device.

Compressed audio file

- MPEG1 audio layer3 (MP3)
- Windows Media Audio (WMA)
- MPEG-4 AAC

Still image file

- JPEG
- FUJICOLOR CD
- KODAK Picture CD

Movie file

(except files saved on USB devices)

- WMV
- DivX® Ultra
 - Official DivX® Ultra Certified product.

- Plays all versions of DivX® video (including DivX® 6) with enhanced playback of DivX® media files and the DivX® Media Format.

Hint

Refer to "DISC OPERATION" on page 26 for details.

Cleaning discs

- When a disc becomes dirty, clean it with a cleaning cloth. Wipe the disc from the center out. Do not wipe in a circular motion.
- Do not use solvents such as benzine, thinner, commercially available cleaners, or antistatic spray intended for analog records.

Avoid high temperatures, moisture, water and dust

- Do not expose the system, batteries or discs to humidity, rain, sand or excessive heat (caused by heating equipment or direct sunlight).

Avoid condensation problem

- The lens may cloud over when the controller is suddenly moved from cold to warm surroundings, making it impossible to play a disc. Leave the controller in the warm environment until the moisture evaporates.

Disc care

- Write only on the printed side of a CD-R/RW, DVD-R/-RW/-R DL, DVD+R/+RW/+R DL and only with a soft felt tipped pen.
- Handle the disc by its edge; do not touch the surface.

Lens care

- Basically, lens cleaning is not necessary.
- Do not use lens cleaner because it may cause malfunction.

Cabinet care















- Use a soft cloth slightly moistened with a mild detergent solution. Do not use a solution containing alcohol, spirits, ammonia, or abrasives.

Choosing a suitable location

- Place the controller on a flat, hard, and stable surface.

Region codes

The unit is designed to support the Region Management System. Check the region code number on the disc package. If the number does not match the unit's region number (Refer to the table below or the back of the unit), the unit may be unable to play the disc.

Destination	Region code of DVR-700	Playable discs
U.S.A., and Canada model		 
Europe model		 
Asia and Taiwan models		 
Australia model		 
Russia model		 

Features



Manufactured under license from Dolby Laboratories. "Dolby", "Pro Logic", "MLP Lossless" and the double-D symbol are trademarks of Dolby Laboratories.



"DTS" and "DTS Digital Surround" are registered trademarks of DTS, Inc.



DivX®, DivX® Ultra Certified, and associated logos are trademarks of DivX®, Inc. and are used under license.



HDMI, the HDMI logo and High Definition Multimedia Interface are trademarks or registered trademarks of HDMI Licensing LLC.



The XM name and related logos are registered trademarks of XM Satellite Radio Inc.

XM Mini-Tuner



©2006 SIRIUS Satellite Radio Inc. "SIRIUS", "SiriusConnect", the SIRIUS dog logo, channel names and logos are trademarks of SIRIUS Satellite Radio Inc.

"Apple", "iPod", and "iTunes" are trademarks of Apple Inc., registered in the U.S. and other countries.

Bluetooth is a registered trademark of Bluetooth SIG and is used by Yamaha in accordance with a license agreement.

Windows Media is either a registered trademark or trademark of Microsoft Corporation in the United States and/or other countries.

This product incorporates copyright protection technology that is protected by U.S. patents and other intellectual property rights. Use of this copyright protection technology must be authorized by Macrovision, and is intended for home and other limited viewing uses only unless otherwise authorized by Macrovision. Reverse engineering or disassembly is prohibited.



This system employs new technologies and algorithms that make it possible to achieve 7-channel surround sound with only two speakers, and without using wall reflections.

■ Main unit

DVD controller
(DVR-700)



■ Speaker package

Speaker (L/R)
(NS-P700)

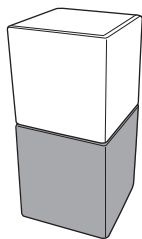

Subwoofer/system control
(NS-PSW700)

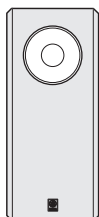

■ Supplied accessories

Indoor FM antenna



(U.S.A., Canada,
Asia and Taiwan
models)

(Europe, Russia
and Australia
models)

Remote control



Battery x 2
(AA, R6, UM-3)

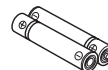

Video pin cable (1.5 m)



System control cable (4 m)

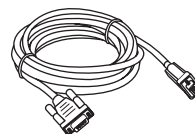

Speaker cable x 2 (4 m)

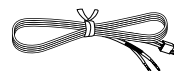

Cover
(For NS-PSW700)

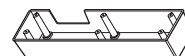

Screw x 6
(for cover 3 x 6 mm)



Stand x 2
(For NS-P700)

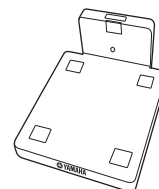

Screw x 2
(for stand 4 x 10 mm)



Owner's Manual



■ Front panel (DVR-700)

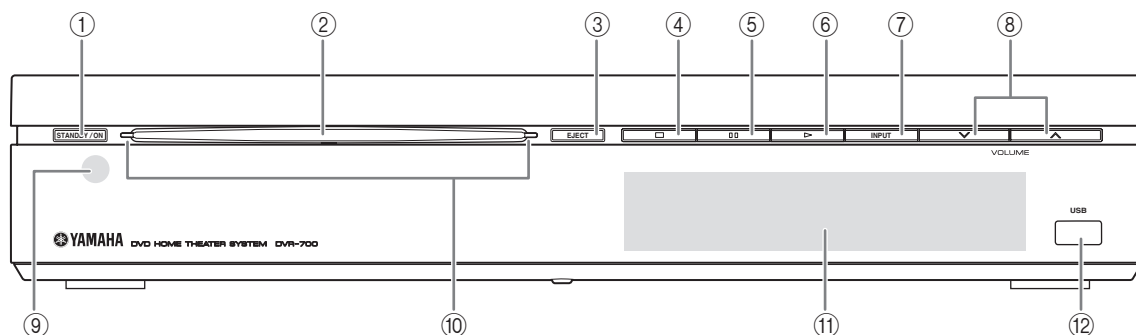

- ① **STANDBY/ON**
Turns on the system, or sets it to standby mode (Page 22).
- ② **Disc loading slot**
Insert a disc to be played.
- ③ **EJECT**
Ejects a disc in the DVD controller.
- ④ **□**
Stops playback.
- ⑤ **⏸**
Pauses playback.
- ⑥ **▶**
Starts playback.
- ⑦ **INPUT**
Selects an input source by pressing repeatedly.
- ⑧ **VOLUME ^ / ∨**
Adjusts the volume level.
- ⑨ **Remote control sensor**
Point the remote control towards this sensor.
- ⑩ **Power indicator**
Lights up when system is on.
- ⑪ **Front panel display**
Shows information about the operational status of the unit.
- ⑫ **USB terminal**
Connect to the USB connector of your USB device (Page 35).

■ **Rear panel (DVR-700)**

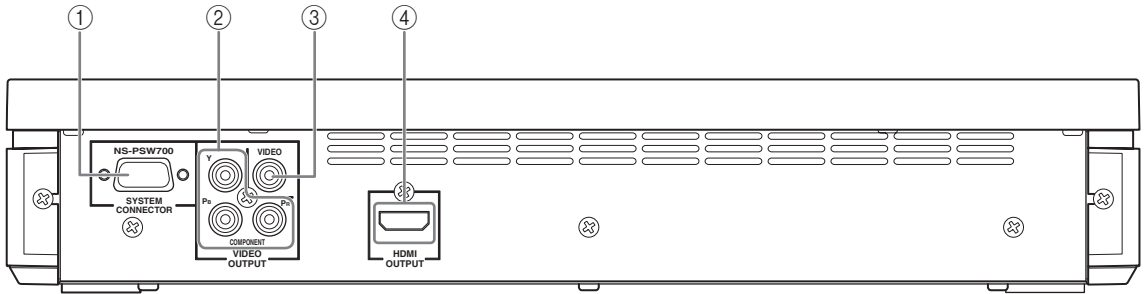

- ① **SYSTEM CONNECTOR terminal**
Connect to the subwoofer/system control (Page 16).
- ② **COMPONENT VIDEO OUTPUT jacks**
Connect to the Y PB/CB PR/CR jacks on your TV (Page 17).
- ③ **VIDEO OUTPUT jack**
Connect to the video (composite) jack on your TV (Page 17).
- ④ **HDMI OUTPUT terminal**
Connect to the HDMI input terminal on your TV (Page 18).

■ Front panel display (DVR-700)

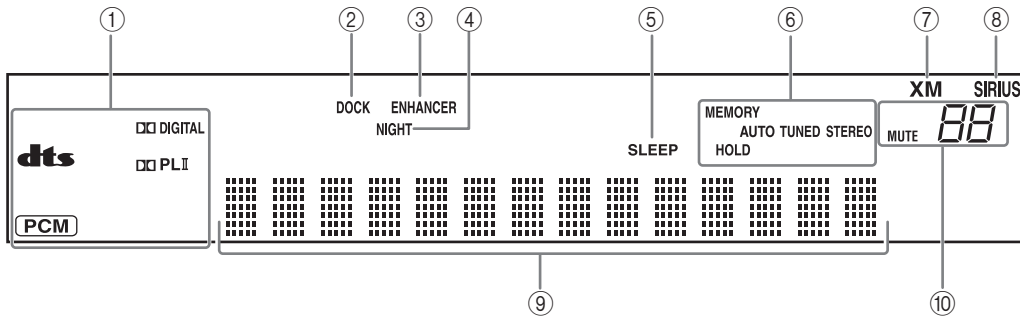

① Decoder indicators

The respective indicator lights up when any of the decoders of the system is functioning.

② DOCK indicator

- Lights up when the system is receiving a signal from an iPod stationed in the Yamaha iPod universal dock (such as YDS-10 or YDS-11, sold separately) connected to the DOCK terminal of the subwoofer/system control (Page 20).
- Lights up while the Yamaha Bluetooth wireless audio receiver (such as YBA-10, sold separately) is connected to the Bluetooth component (Page 61).
- Flashes while the connected Yamaha Bluetooth wireless audio receiver (such as YBA-10, sold separately) and the Bluetooth component are pairing or while the Yamaha Bluetooth wireless audio receiver is searching for the Bluetooth component (Page 61).

③ ENHANCER indicator

Lights up when compressed music enhancer mode is selected (Page 45).

④ NIGHT indicator

Lights up when you select night listening mode (Page 63).

⑤ SLEEP indicator

Lights up when sleep mode is on (Page 65).

⑥ Tuner indicators (AUTO/TUNED/STEREO/MEMORY/HOLD)

AUTO indicator

Lights up when the system is in automatic tuning mode (Page 46).

TUNED indicator

Lights up when the system is receiving a station (Page 46).

STEREO indicator

Lights up when the system is receiving a strong signal from an FM stereo broadcast in automatic tuning mode (Page 46).

MEMORY indicator

Flashes to show a station can be stored (Page 47).

HOLD Indicator

Flashes while holding the XM/SIRIUS information (Page 53, 59).

⑦ XM indicator

Lights up when the input source is XM Mini-Tuner (Page 50).

⑧ SIRIUS indicator

Lights up when the input source is SiriusConnect tuner (Page 54).

⑨ Multi information display

Shows the playing time. When you adjust or change a setting, the value is displayed.

⑩ MUTE indicator/VOLUME indicator

- Flashes while the mute function is activated.
- Indicates the current volume level.

■ Rear panel (NS-PSW700)

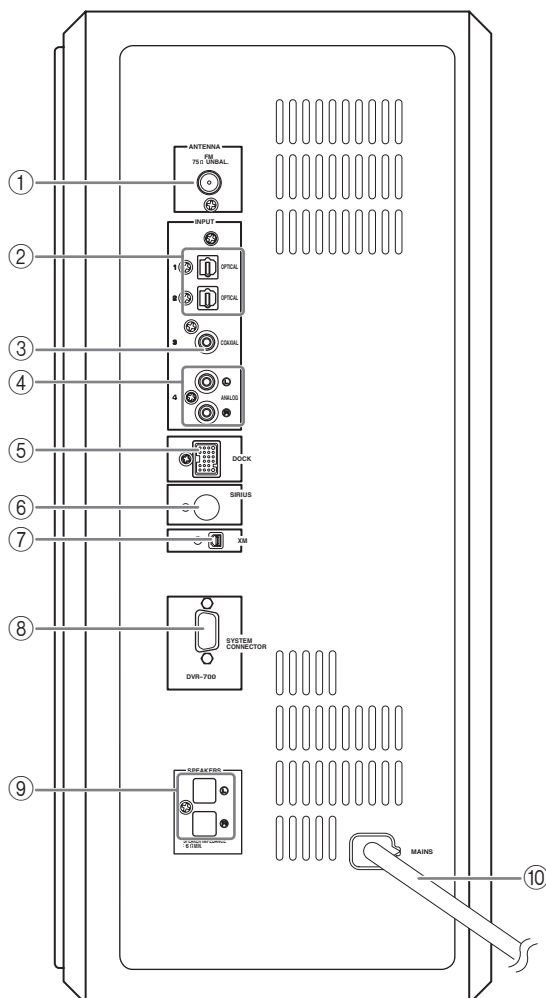

- ① **ANTENNA terminal**
Connect the FM antenna.
- ② **INPUT 1/2 OPTICAL jacks**
Connect to the DIGITAL OUT jack (Optical Type) on your digital audio component. These input jacks support PCM, Dolby Digital, and DTS bitstream.
- ③ **INPUT 3 COAXIAL jack**
Connect to the DIGITAL OUT jack (Coaxial Type) on your digital audio component. This input jack support PCM, Dolby Digital, and DTS bitstream.
- ④ **INPUT 4 ANALOG jacks**
Connect to the ANALOG OUT jack if the component does not have DIGITAL OUT jacks.
- ⑤ **DOCK terminal**
Connect the Yamaha iPod Universal Dock (such as YDS-10 or YDS-11, sold separately) or Yamaha Bluetooth wireless audio receiver (such as YBA-10, sold separately) (Page 20).
- ⑥ **SIRIUS terminal**
Connect to a SiriusConnect tuner (sold separately).
- ⑦ **XM terminal**
Connect to an XM Mini-Tuner and XM Mini-Tuner Home Dock (sold separately).
- ⑧ **SYSTEM CONNECTOR terminal**
Connect to the DVD controller.
- ⑨ **SPEAKER terminals**
Connect to the speakers.
- ⑩ **Power cable**
Connect to a standard AC outlet.

■ Remote control

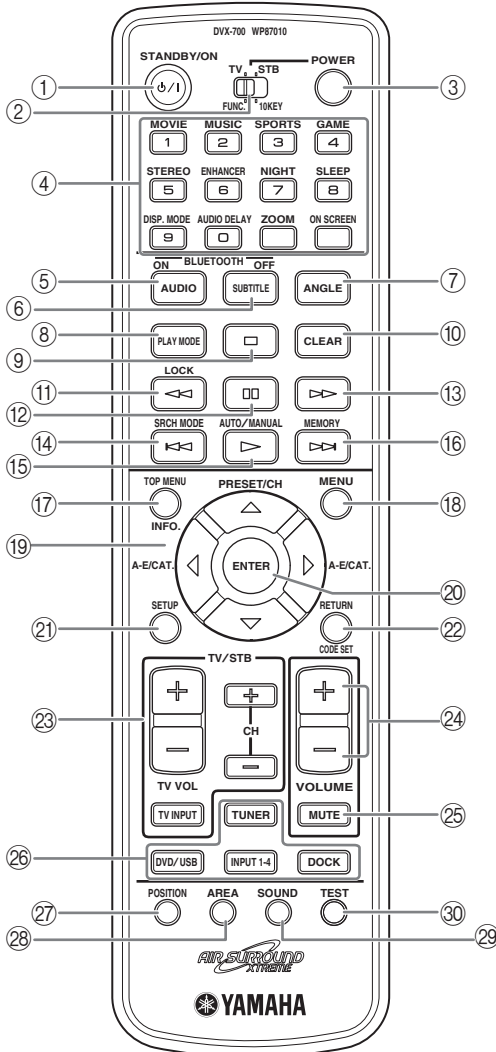

- ① **STANDBY/ON (ϕ /I)**
Turns on the this system, or sets it to the standby mode.
- ② **FUNC./10KEY**
Switches the operation of the Function/Numeric keypad keys. Also, the preset code to operate TV or STB.

Hint

Using the remote control, you can operate two kinds of peripheral devices such as TV and satellite tuner. When operating them, you need to set the preset codes depending on the components. Refer to “Setting the preset code” on page 66.

- ③ **POWER**
Turns on the TV.

Note

To operate your TV with the remote control, you need to set the preset code. Refer to “Setting the preset code” on page 66.

- ④ **Function / Numeric keypad 0-9**
Operates some functions, such as AIR SURROUND XTREME, and enters track numbers or other numbers.

The available operation will be changed depending on the FUNC./10KEY position.

FUNC./10KEY: FUNC. side

- MOVIE**
- MUSIC** Select surround mode.
- SPORTS**
- GAME**

- STEREO**
 - Turns extended stereo mode on and off alternately (Page 45).
 - Turns surround mode off (Page 43).

- ENHANCER** Turns compressed music enhancer mode on and off alternately (Page 45).

- NIGHT** Turns night listening mode on and off alternately (Page 63).

- SLEEP** Sets the sleep timer (Page 65).

- DISP. MODE** Changes the brightness of the front panel display (Page 64).

- AUDIO DELAY** Delays the output sound to synchronize it with the video image (Page 63).

- ZOOM** Enlarges the pictures while playing DVD.

Hint

This button can be used regardless of the FUNC./10KEY position.











- ON SCREEN** Displays the disc information on the TV display.

Hint

This button can be used regardless of the FUNC./10KEY position.

FUNC./10KEY: 10KEY side

Enters numeric characters using 0 to 9 buttons.

- ⑤ **AUDIO**
Selects an audio language for the DVD that is playing (if available).
- ⑥ **SUBTITLE**
Selects a subtitle language for the DVD that is playing (if available).
- ⑦ **ANGLE**
Selects a camera angle for the DVD that is playing (if available).
- ⑧ **PLAY MODE**
Displays the Play Mode menu.
- ⑨ 
Stops playback.
- ⑩ **CLEAR**
Erases the registered track/chapter order.
- ⑪  (**LOCK**)
Rewinds the disc.
SIRIUS: Sets a parental lock.
- ⑫ 
Pauses playback.
- ⑬ 
Fast-forwards the disc.
- ⑭  (**SRCH MODE**)
Selects the previous track or chapter.
XM/SIRIUS: Selects the search mode.
- ⑮  (**AUTO/MANUAL**)
Starts playback.
FM: selects auto/manual tuning (Page 46).
- ⑯  (**MEMORY**)
Selects the next track or chapter.
FM: registers the radio frequency.
- ⑰ **TOP MENU (INFO.)**
Displays the top-level disc menu.
iPod: switches operation mode of the iPod.
- ⑱ **MENU**
Displays the disc contents menu.
- ⑲ **Cursors** ( /  /  / )
Selects items or changes values in the menu screen.
– Tuning the FM station.
– Controlling an iPod.
– Changing the settings.
- ⑳ **ENTER**
Confirms a selection.
- ㉑ **SETUP**
Displays the DVD setup menu.
- ㉒ **RETURN (CODE SET)**
– Returns to the previous screen when DVD setup menu is displayed.
– Use to set the preset code. Refer to “Setting the preset code” on page 66.
- ㉓ **TV/STB control buttons**
TV VOL +/-
Adjusts the TV volume level.
CH +/-
Select the TV channel.
TV INPUT
Selects the TV input.
- Note**
To operate your TV with the remote control, you need to set the preset code. Refer to “Setting the preset code” on page 66.
You can select TV or STB by switching FUNC./10KEY.
- ㉔ **VOLUME +/-**
Adjusts the volume level of DVX-700.
- ㉕ **MUTE**
Mutes the volume of DVX-700. Press the button again to mute OFF.
- ㉖ **Input selection buttons**
DVD/USB
Switches the input source to DVD or USB. Each time you press the button, the input source changes in sequence.
TUNER
Switches the input source to FM/XM/SIRIUS.
INPUT 1-4
Switches the input source to the external input. Each time you press the button, the input source changes in sequence from input 1 to input 4.
DOCK
Switches the input source to DOCK.
Selects iPod or Bluetooth as the input source depending on the option connected to the Dock terminal.
- ㉗ **POSITION**
Shifts the optimum listening area according to your listening position (Page 44).
- ㉘ **AREA**
Sets the distance between speakers for the best surround effect (Page 44).
- ㉙ **SOUND**
Adjusts the volume balance for the virtual speaker and subwoofer (Page 64).
- ㉚ **TEST**
Outputs the test tone (Page 45).

■ Roles and layout of the speakers

To enjoy quality sounds, you need to place the speakers in their appropriate positions and install them correctly. The following shows the recommended layout of the speakers.

When placing the speakers on a rack

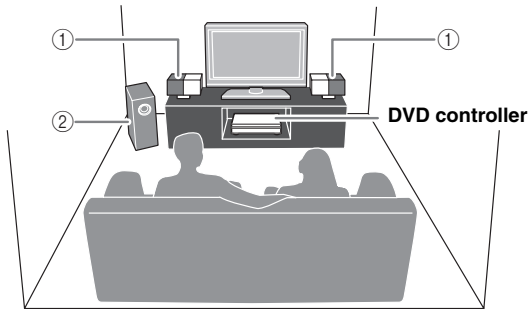

When placing the speakers on a wall

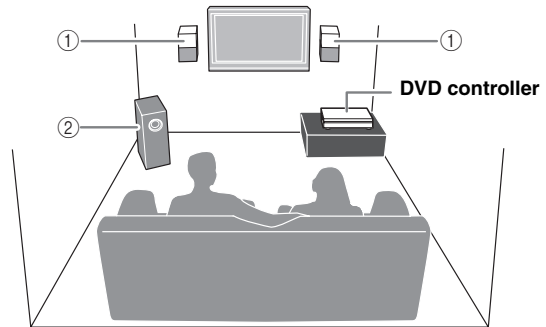

① Speaker (L, R)

Produces front channel (stereo) sounds. Also produces virtual center channel sounds (dialogue, etc.) and virtual surround channel sounds effectively using the Yamaha front surround system.

Place the left and right speakers at equal distances away from the listening position so that you can produce high quality surround sound. You can install the speakers on a rack using the stands or on a wall.

② Subwoofer/system control

The subwoofer produces bass sounds and LFE sounds contained in Dolby Digital or DTS. Place the subwoofer in the front of the listening position. Turn it slightly toward the center of the room to reduce wall reflections.

Notes

- To avoid magnetic interference, do not position the speakers too close to your TV.
- Allow adequate ventilation around the DVD controller and subwoofer/system control.
- Bass sounds produced by the subwoofer may be heard differently depending on the listening position and subwoofer location.
To enjoy desired sounds, try to change the location of the subwoofer according to the listening position.
- You can adjust the surround effect by arranging the position of the speakers (Page 46).

■ Placing the speakers using the stands

You can place the speakers in an upright position or a horizontal position. Put the speakers on the stands and secure them with the screws.

When placing the speaker in an upright position

Place the speaker on the stand vertically, and then secure it with the screw as shown in the illustration.

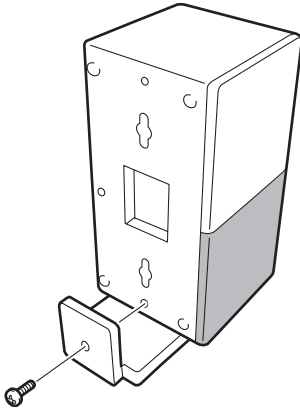

When placing the speakers in a horizontal position

Put the speaker on the stand so that the black side of the speaker becomes outside, and then secure it with the screw as shown in the illustration.

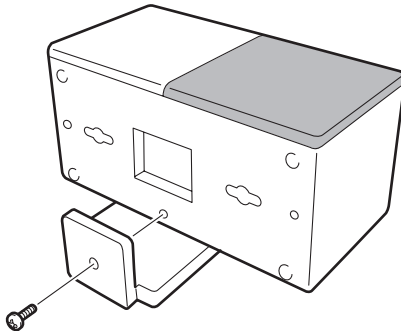

■ Placing the speakers on a wall

Put the speakers on a wall using commercially available screws. Refer to the illustration below for the screw size.

Tapping screw (Available at the hardware store)
Dia.4 mm (1/8")

Installing on a plaster wall.

Installing on a firm wall.

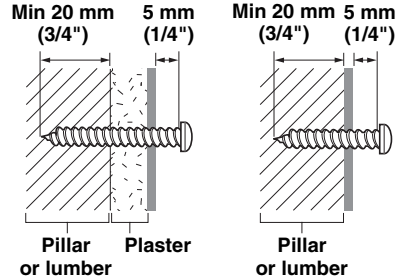

- ① When placing the speakers on a wall, remove the stands.
- ② Install screws on a wall as shown in the illustration. The distance between the screws: 126 mm for both sides

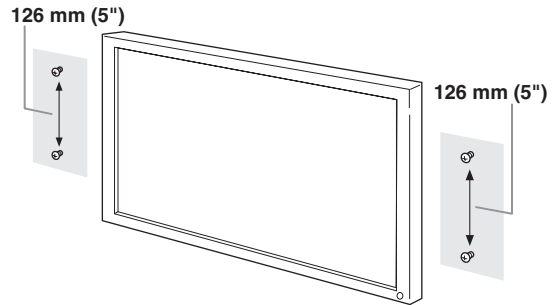

- ③ Insert the screws into the holes on the back of the speaker.

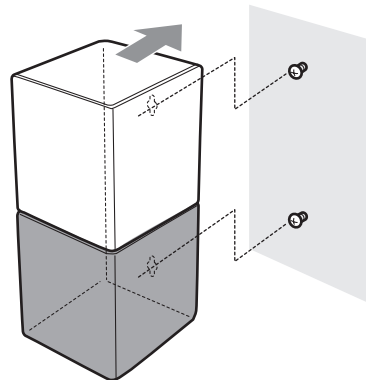

Notes

- To attach the speaker to a wall with screws, the wall must be firm. If not you may cause the speaker to fall.

- Use commercially available screws that can support the weight of the installation.
- Make sure you use specified screws to attach the speakers to a wall. Using clamps other than specified screws, such as short screws, nails, or two-sided tape, may cause the speaker to fall.
- After attaching the speakers, check that the speakers are installed securely. Yamaha will bear no responsibility for any accidents caused by improper installations.

SYSTEM CONNECTIONS

■ Connecting the speakers

Note

Do not connect the power cable of the subwoofer/system control into an AC outlet until all cable connections are completed.

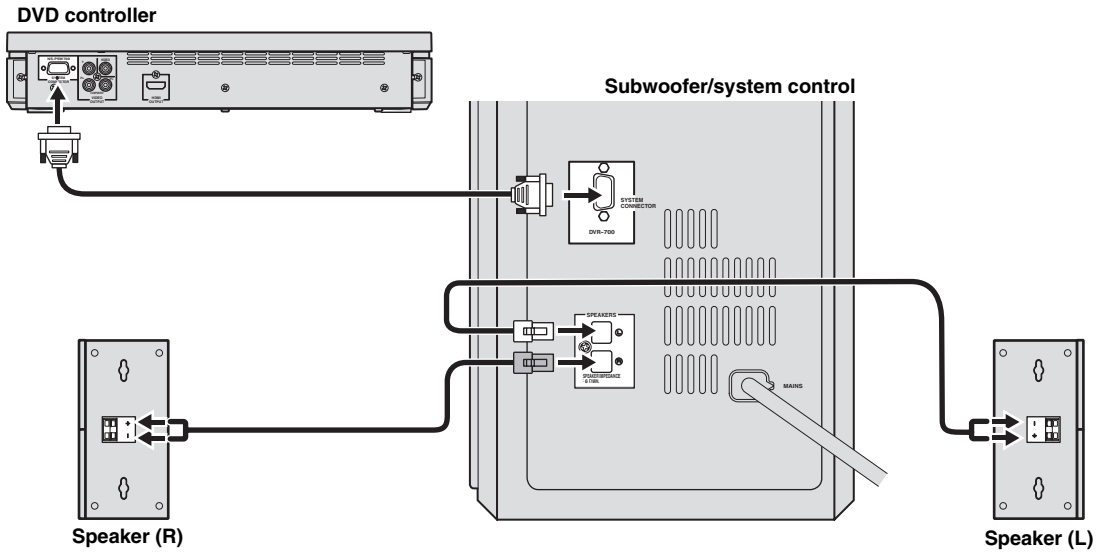

Connecting the speakers and subwoofer/system control

Connecting the speakers

Confirm the plug colors of the speaker cables.

- Speaker cable with white plug: for speaker (L)
- Speaker cable with red plug: for speaker (R)

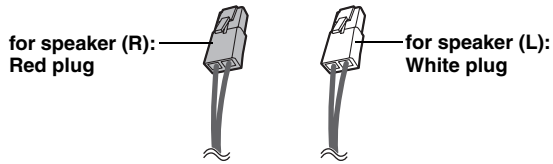

- 1 Push down the knob of the speaker terminal.

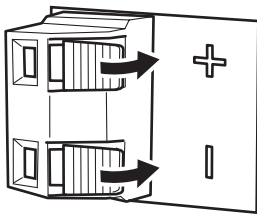

- 2 Insert the stripped speaker cable into the hole on the speaker terminal.

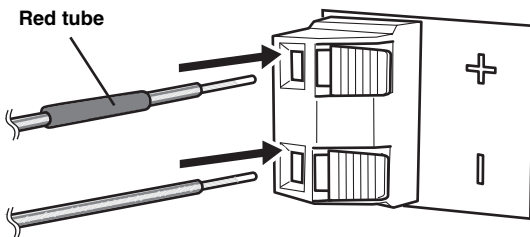

Note

Connect the cable with red tube to the positive terminal, and the other cable to the negative terminal.

- 3 Release the knob of the speaker terminal.

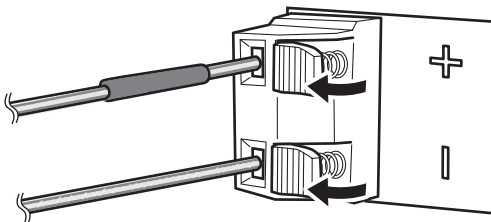

Connecting the subwoofer/system control

- 1 Insert the speaker cable plug until you hear a click sound.

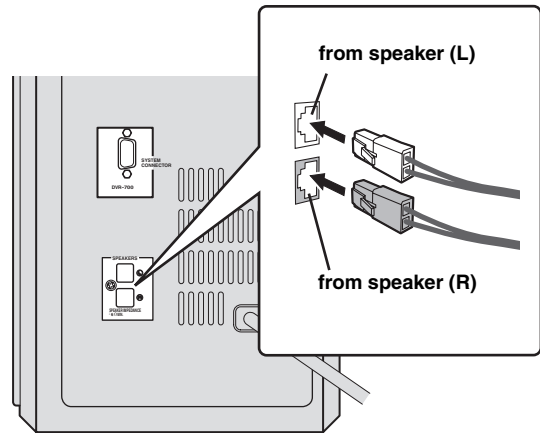

Note

Make sure that the cable plugs are connected to the subwoofer/system control terminals of the same color.

- 2 Use the same procedure to connect the other speaker cable.

■ Connecting the DVD controller and the subwoofer/system control

Connect the SYSTEM CONNECTOR terminal at the rear of the subwoofer/system control to the SYSTEM CONNECTOR terminal at the rear of the DVD controller using the system control cable.

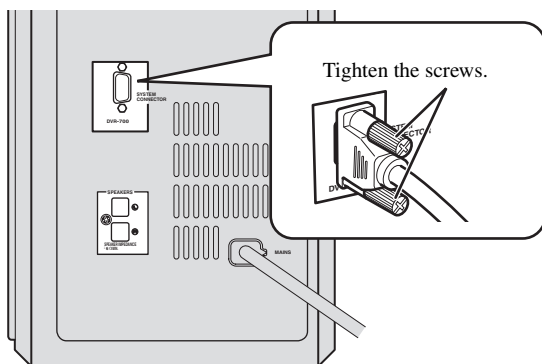
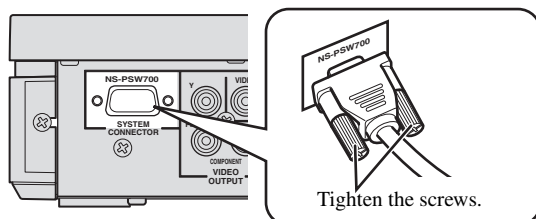

Notes

- Make sure that the system control cable is correctly connected. Improper connections may damage the system due to a short-circuit.
- To prevent unwanted noise, do not place the subwoofer too close to the DVD controller, AC power adaptor, TV or other sources of radiation.
- Do not insert the Power cable to an AC outlet until all connections are completed.

OTHER CONNECTIONS

■ Connecting a TV

Notes

- You only need to make one video connection from the following options (A or B), depending on the capabilities of your TV.
- Do not connect the power cables until all cable connections are completed.

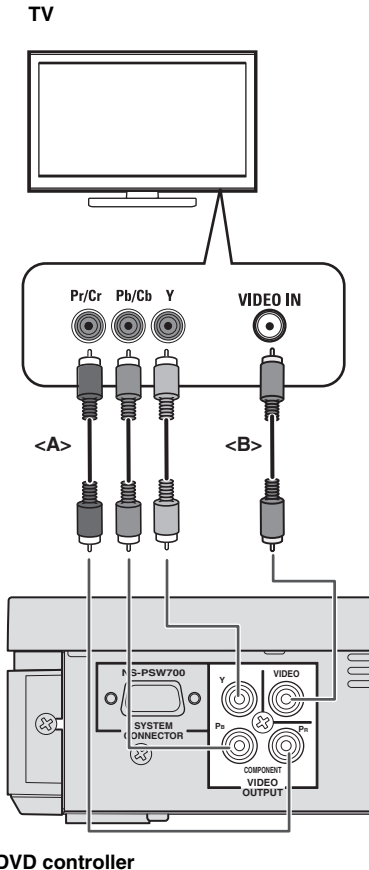

COMPONENT VIDEO OUTPUT jacks <A>

Use the component video cables (Green/Blue/Red, not supplied) to connect the DVD controller's Y PB PR jacks to the corresponding component video input jacks (or the Y PB/CB PR/CR YUV jacks) on your TV.

Progressive scan video quality is only available when using Y PB PR in conjunction with a progressive scan TV. To activate the progressive scan function, refer to "Selecting the output type for COMPONENT VIDEO OUTPUT jacks" on page 24.

VIDEO OUTPUT jack

Use the Video pin cable (yellow-supplied) to connect the DVD controller's VIDEO OUTPUT jack to the video input jack (or A/V In/Video In/Composite/Baseband jack) on your TV.

■ Connecting an HDMI component

HDMI (High-Definition Multimedia Interface) is the first industry-supported, uncompressed, all-digital A/V (audio/video) interface.

By connecting to an HDMI component (such as a TV), you can enjoy standard, enhanced or high-definition video as well as digital audio using a single cable.

When used in combination with HDCP (High-bandwidth Digital Content Protection), HDMI provides a secure audio/video interface that meets the security requirements of content providers and system operators.

For further information on HDMI, visit the HDMI website at "<http://www.hdmi.org/>".

■ Viewing and Listening to playback from an HDMI component

To output an HDMI signal, you need to configure the settings manually. It is necessary to prepare in advance to output an HDMI signal.

- ① Set the system to standby mode.
- ② Connect the HDMI terminals on your HDMI compatible device and the DVD controller using a commercially available HDMI cable.

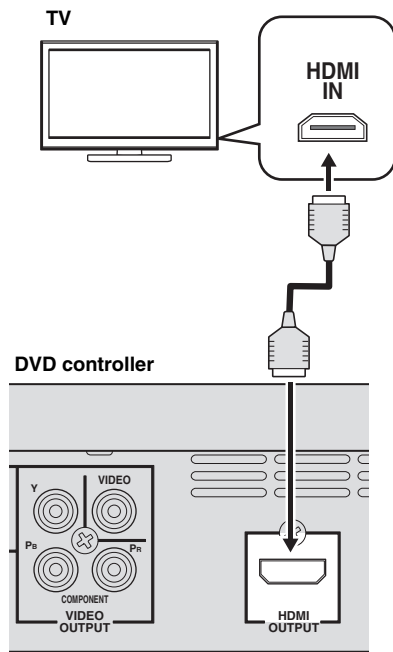

- ③ To output an audio signal from the DVD controller to the HDMI compatible device, refer to "System menu" on page 65.
After doing the settings, set the DVD controller to standby mode, and then turn on the system again.

- ④ To set the video output according to the HDMI compatible device, refer to "Video Output" on page 38 to access the DVD setup menu, and then set the two items under Video output in the system menu.
 - HDMI Resolution
 - HDMI Color

Notes

- This unit is designed to connect to HDMI compatible devices. If you connect to the DVI component, the system may not operate correctly.
- The DVD controller is not compatible with HDCP-incompatible HDMI or DVI components.
- You need a commercially available HDMI/DVI conversion cable when you connect the DVD controller to other DVI components.
- If you connect the system to the DVI component with a HDMI/DVI conversion cable, the HDMI terminal of the DVD controller does not output any audio signals.
- Do not disconnect or connect the HDMI cable from the DVD controller or turn off the power of the HDMI/DVI component connected to the HDMI OUTPUT terminal of the DVD controller while data is being transferred. Doing so may disrupt playback or cause noise.
- PCM signal downmixed to two channels can be output from the HDMI output terminal.

■ Connecting the FM antenna

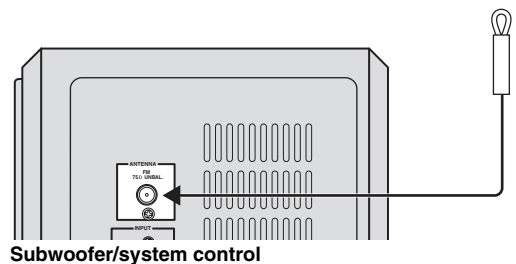

Connect an indoor FM antenna to the ANTENNA terminal. Extend the FM antenna and fix its ends to the wall.
For better FM stereo reception, connect an external FM antenna.

Notes

- Adjust the position of the antenna for optimal reception.
- Position the antenna as far as possible from your TV, VCR or other sources of radiation to prevent unwanted interference.

■ Connecting external AV components

If you connect external AV equipment, such as a VCR or cassette deck, to the audio input terminal on the subwoofer/system control, you can listen to those audio sources on the system.

This section provides some examples of VCR and digital AV equipment connections.

Connecting analog AV components

Connect the DVD controller and external AV equipment as shown in the illustration.

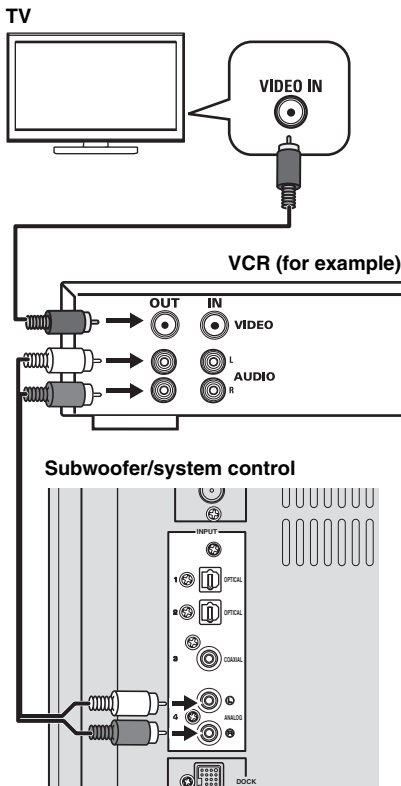

Connecting digital AV components

Connect the subwoofer/system control and external AV equipment as shown in the illustration.

When connecting to optical type digital AV components

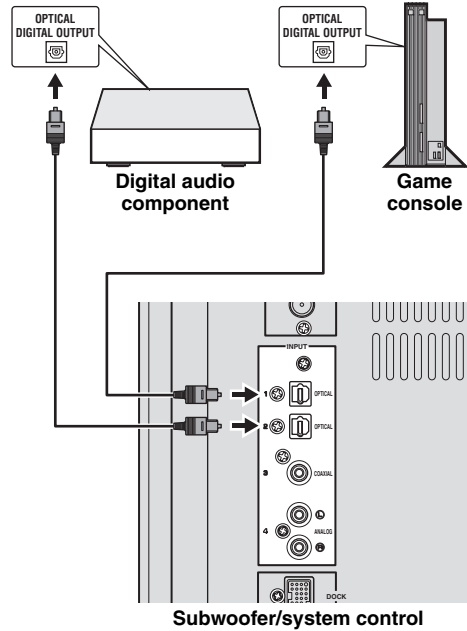

When connecting to coaxial type digital AV components

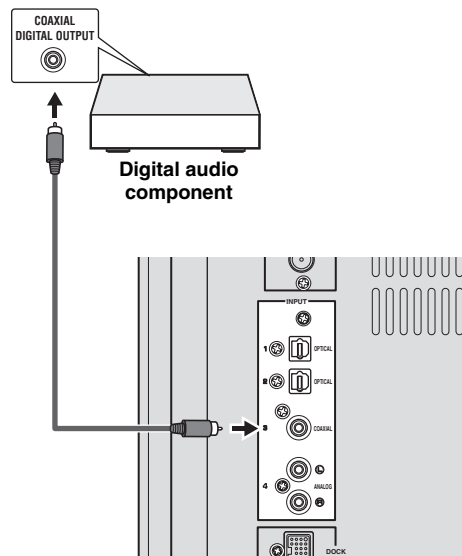

Connecting optional equipment

The system is equipped with the DOCK terminal, which allows you to connect the Yamaha iPod universal dock (such as YDS-10 or YDS-11, sold separately) or Yamaha Bluetooth wireless audio receiver (such as YBA-10, sold separately). Connect the optional equipment to the DOCK terminal of the subwoofer/system control using its dedicated cable.

When connecting the Yamaha iPod universal dock

Yamaha iPod universal dock
(such as YDS-10 or YDS-11, sold separately)

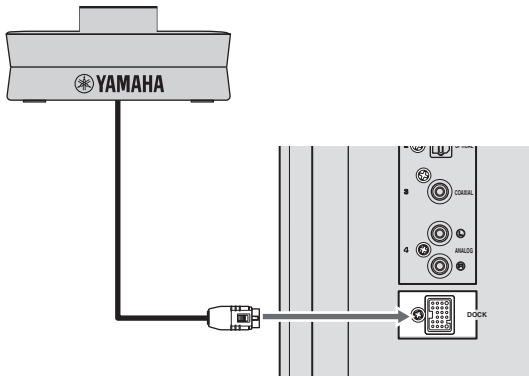

When connecting the Yamaha Bluetooth wireless audio receiver

Yamaha Bluetooth wireless audio receiver
(such as YBA-10, sold separately)

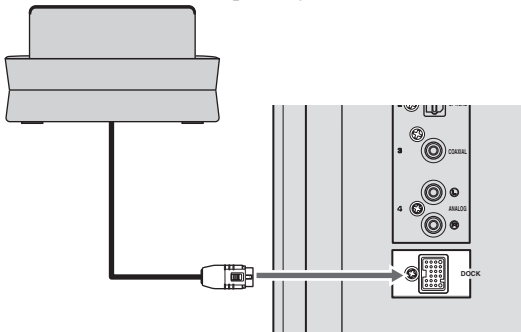

Connecting the power cable

After you have made all connections, connect the power cable of the subwoofer/system control.

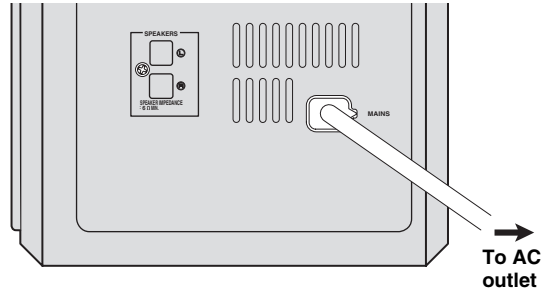

Hint

You can attach or detach the cover according to your preference after you have made all connections. Attach the cover to the rear panel of subwoofer/system control using the 6 supplied screws as shown.

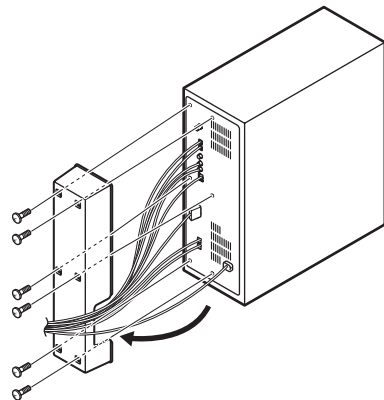

GETTING STARTED

■ Inserting batteries into the remote control

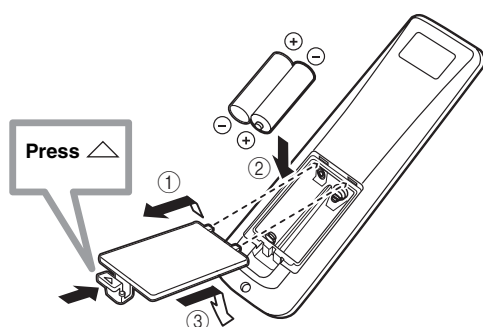

- ① Press \triangle on the battery cover and open the cover.
- ② Insert the two supplied batteries (AA, R6, UM-3) into the battery compartment. Insert the batteries according to the polarity markings (+ and -).
- ③ Close the battery cover.

Replacing the batteries

If the batteries run low, the effective operation distance of the remote control decreases considerably. If this happens, replace the batteries with two new ones as soon as possible.

Notes

- Do not use an old battery together with new one.
- Do not use different types of batteries (for example, alkaline and manganese) together. Each type of battery has its own characteristics even if they are similar in shape.
- If the batteries run out, immediately remove them from the remote control to prevent an explosion or acid leak.
- Dispose of the batteries according to the regional regulations.
- If a battery starts leaking, dispose of it immediately.
Be careful not to let leaking battery acid come into contact with your skin or clothing. Before inserting new batteries, wipe the compartment clean.
- Replace the batteries within two minutes to preserve the preset code in the remote control.

Hint

Remove the transparent sheet before using the remote control.

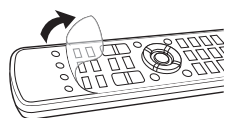

■ Using the remote control

Use the remote control within 6 m of the DVD controller and point it toward the remote control sensor.

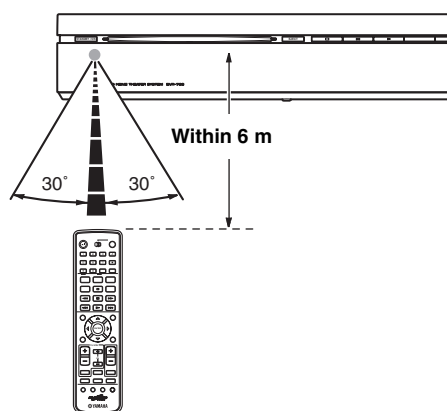

Basic operation of the remote control

- ① Use the Input selection buttons on the remote control to select the input source you wish to control (for example **DVD/USB**).
→ The selected source appears in the front panel display.
When the button contains several input sources such as **DVD/USB** and **INPUT 1-4** buttons, the input source switches each time you press the button.

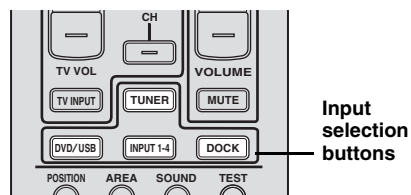

- ② Operate the desired function (for example, \triangleright or \triangleleft / $\triangleright\triangleright$).

Notes

- Be careful not to spill liquid on the remote control.
- Be careful not to drop the remote control.
- Do not leave the remote control in the following places:
 - hot or humid places, such as near a heater or in a bathroom
 - extremely cold places
 - dusty places
- To operate your TV with the remote control, you need to set the preset code.
Refer to "Setting the preset code" on page 66 for how to change the preset code.

■ Turn on the system

Press **STANDBY/ON** on the DVD controller or the remote control.

The LED indicators beside the disc loading slot light up when the system is turned on.

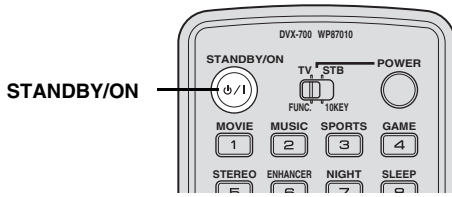

Light up

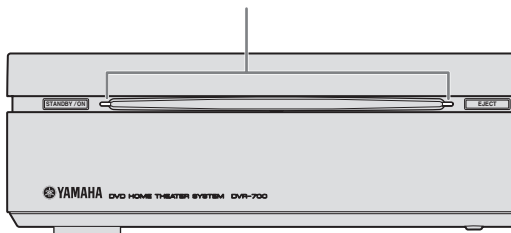

■ Setting the video input/output

Notes

- Make sure that you have completed all the necessary connections (Refer to “Connecting a TV” on page 17).
 - If the settings you have selected are not appropriate, you can reset DVD settings to the initial factory settings (Refer to “System menu” on page 65).
- ① Press **DVD/USB** repeatedly until “DVD” appears in the front panel display.
 - ② Turn on the TV and set to the correct video-in channel.
 - You should see the background screen on the TV.
 - Usually this channel is between the lowest and highest channels and may be called FRONT, A/V IN or VIDEO. See your TV manual for more details.
 - Or, you may go to channel 1 on your TV, then press the Channel down button repeatedly until you see the Video In channel.
 - Or, the TV remote control may have a button or switch that chooses different video modes.

Setting the TV display

Set the aspect ratio of the DVD controller according to the TV you have connected. The format you select must be available on the disc. If it is not, the TV display setting will not affect the picture during playback.

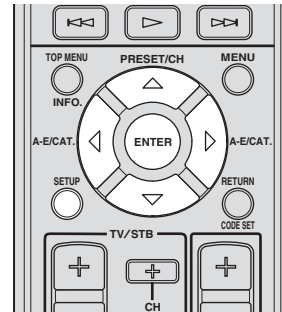

- ① Press **SETUP** on the remote control. DVD setup menu is displayed on the screen.

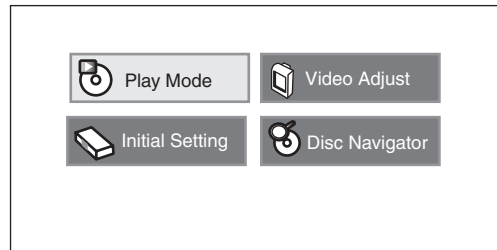

- ② Press \triangle / ∇ / \triangleleft / \triangleright on the remote control to highlight [Initial Settings], and then press **ENTER**.

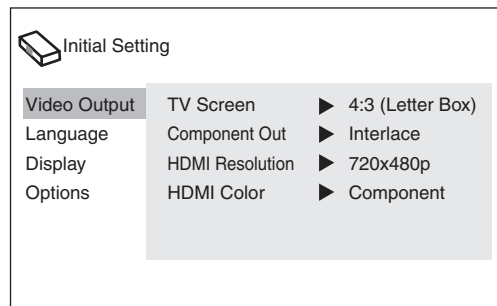

- ③ Press \triangle / ∇ on the remote control to highlight [Video Output], and then press **ENTER**.

- ④ Press \triangle / ∇ on the remote control to highlight [TV Screen], and then press **ENTER**.

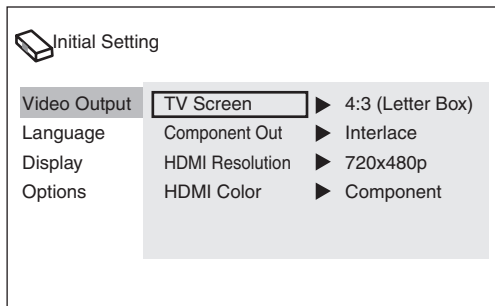

- ⑤ Press \triangle / ∇ on the remote control to highlight one of the options below, and then press **ENTER**.

4:3 (Letter Box)

Select this if you have a conventional TV. In this case, a wide picture with black bar on the upper and lower portions of the TV screen will be displayed.

4:3 (Pan&Scan)

Select this if you have a conventional TV and want both sides of the picture to be trimmed or formatted to fit your TV screen.

Note

If the disc does not support an aspect ratio of 4:3 (Pan&Scan), the content is displayed in 4:3 (Letter Box).

16:9 (Wide)

Select this if you have a wide-screen TV.

16:9 (Compressed)

Select this if a wide-screen TV is connected to the DVD controller with an HDMI cable, and set HDMI Resolution to either [1920 x 1080p], [1920 x 1080i], or [1280 x 720p]. When playing back a content whose aspect ratio is 4:3, black bars cover the sides of the screen.

Selecting the output type for COMPONENT VIDEO OUTPUT jacks

To use progressive display function, connect to a TV, which has that function, via COMPONENT VIDEO OUTPUT jacks.

- ① Press **SETUP** on the remote control.
- ② Press \triangle / ∇ / \triangleleft / \triangleright on the remote control to highlight [Initial Settings], and then press **ENTER**.
- ③ Press \triangle / ∇ on the remote control to highlight [Video Output], and then press **ENTER**.
- ④ Press \triangle / ∇ on the remote control to highlight [Component Out], and then press **ENTER**.

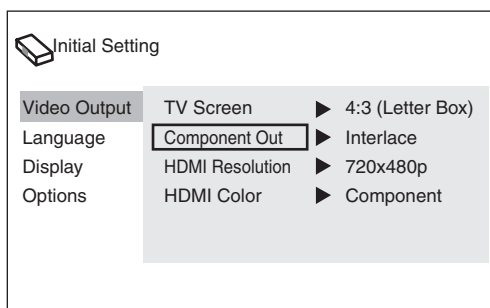

- ⑤ Press \triangle / ∇ on the remote control to highlight [Progressive] / [Interlace], and then press **ENTER**.
- ⑥ When the confirmation screen appears, press **ENTER** again.
To cancel the setting, press **RETURN**.

Note

Do not select [Progressive] if your TV does not have a progressive display function.

If your TV is also connected via HDMI OUTPUT terminal, the system may ignore this setting and output the progressive signal from COMPONENT VIDEO OUTPUT jacks.

■ Setting language preferences

You can select your preferred language settings so that this controller will automatically switch to your preferred language whenever you load a disc. If the language selected is not available on the disc, the disc's default setting language will be used instead. The OSD (on-screen display) language for the DVD setup menu will remain as you set it, regardless of various disc languages.

On-screen display (OSD) language

- ① Press **SETUP** on the remote control. DVD setup menu appears on the screen.
- ② Press $\triangle / \nabla / \triangleleft / \triangleright$ on the remote control to highlight [Initial Settings], and then press **ENTER**.
- ③ Press \triangle / ∇ on the remote control to highlight [Display], and then press **ENTER**.

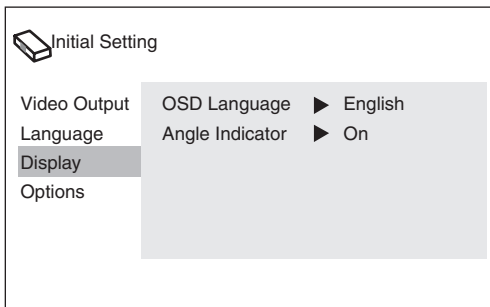

- ④ Press \triangle / ∇ on the remote control to highlight [OSD Language], and then press **ENTER**.
- ⑤ Press \triangle / ∇ on the remote control to select a language, and then press **ENTER**.

Audio, Subtitle and Disc menu languages

- ① Press **SETUP** on the remote control. DVD setup menu appears on the screen.
- ② Press $\triangle / \nabla / \triangleleft / \triangleright$ on the remote control to highlight [Initial Settings], and then press **ENTER**.
- ③ Press \triangle / ∇ on the remote control to highlight [Language], and then press **ENTER**.

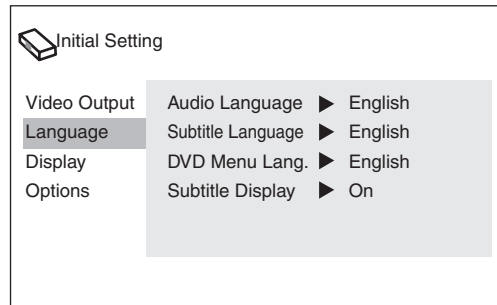

- ④ Press \triangle / ∇ on the remote control to highlight the item below, and then press **ENTER**.
 - Audio Language
 - Subtitle Language
 - DVD Menu Language

Hint

Refer to page 40 for the other items.

- ⑤ Press \triangle / ∇ on the remote control to select a language, and then press **ENTER**.

DISC OPERATION

This unit is designed for use with DVD, CD, Video CD, and Super Video CD, as well as DivX® files and WMV files recorded on CD-R or DVD-R/DVD+R.

IMPORTANT!

- DVD discs and players are designed with regional restrictions. Before playing a disc, make sure that the disc is for the same zone as your DVD controller.
- Do not insert any objects other than discs into the disc loading slot. Doing so may cause the DVD controller to malfunction.
- Depending on the disc, some functions may be prohibited.
- This unit is not compatible with 8-cm discs.

■ Playing discs

- ① Turn on the system.
- ② Press **DVD/USB** repeatedly until “DVD” appears in the front panel display.
- ③ Turn on the TV power and set to the correct Video-in channel (Refer to “Setting the video input/output” on page 23).
→ You should see the background screen on the TV.
- ④ Insert the disc into the disc loading slot.

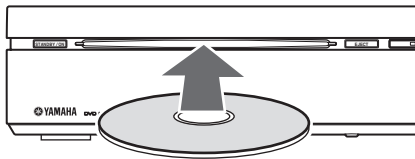

- ⑤ Press **▶** to start playback.
→ If a disc menu appears on the TV, refer to “Using the disc menu (DVD only)” on page 28.
→ If the disc is locked by parental lock function, you must enter your 4-digit password (Refer to “Parental Lock” on page 41).

Note

If you do the operation that is not available during playback, a message “This operation can’t be performed.” or “Depending on the disc, this operation may be prohibited.” appears.

Playing DivX® video/WMV files

DivX® video file

This unit can play DivX® videos recorded on CD-R/RW, DVD-R/-RW, DVD+R/+RW discs. By default they will be played in alphabetical order. The supported files are shown below.

- Plays all versions of DivX® video (including DivX® 6) with enhanced playback of DivX® media files and the DivX® media format.
- The following filename extensions are supported “*.avi*” and “*.divx*”.

Displaying external subtitle files

The font sets listed below are available for external subtitle files. You can see the proper font set on-screen by setting [Subtitle Language] to match the subtitle file.

- | | |
|----------------|--|
| Group 1 | Albanian (sq), Basque (eu), Catalan (ca), Danish (da), Dutch (nl), English (en), Faroese (fo), Finnish (fi), French (fr), German (de), Icelandic (is), Irish (ga), Italian (it), Norwegian (no), Portuguese (pt), Rhaeto-Romanic (rm), Scottish (gd), Spanish (es), Swedish (sv) |
| Group 2 | Albanian (sq), Croatian (hr), Czech (cs), Hungarian (hu), Polish (pl), Romanian (ro), Slovak (sk), Slovenian (sl) |
| Group 3 | Bulgarian (bg), Byelorussian (be), Macedonian (mk), Russian (ru), Serbian (sr), Ukrainian (uk) |
| Group 4 | Hebrew (iw), Yiddish (ji) |
| Group 5 | Turkish (tr) |
- Some external subtitle files may be displayed incorrectly or not at all.
 - For external subtitle files, the following subtitle format filename extensions are supported: “*.srt*”, “*.sub*”, “*.ssa*”, “*.smi*”
 - The filename of the movie file has to be repeated at the beginning of the filename for the external subtitle file.
 - The number of external subtitle files which can be switched for the same movie file is limited to a maximum of 10.

WMV file

WMV content can be encoded by using Windows Media Encoder.

The supported files are shown below.

- The DVD controller is compatible with WMV9 files that are encoded by using the Windows Media Encoder 9 Series, with “.wmv” as an filename extension.
- Compatible with size under 720 x 576 pixels/720 x 480 pixels.
- The available maximum bit rate is about 2 to 3 Mbps. The maximum bit rate varies depending on the encode method.
- Advanced Profile is not supported.
- DRM-Protected video files are not played in the DVD controller.

Basic playback controls

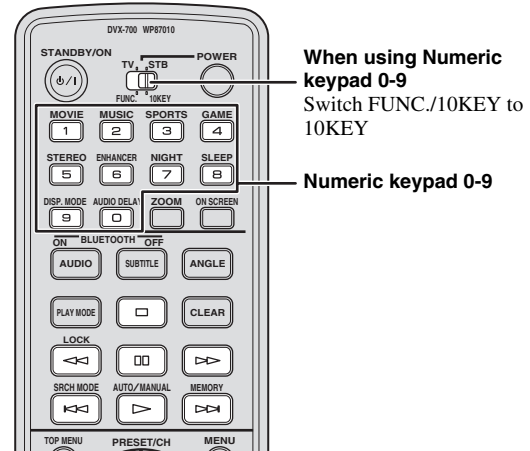

To pause playback



During playback, press .

- To resume normal playback, press .

To stop playback

Press .



To select track/chapter

Press  /  to select previous/next track or chapter.



You can enter a track/chapter number using **Numeric keypad 0-9**.

To search backward/forward

Press  / .



- To resume normal playback, press .
- When searching, press  /  again to increase the search speed. (DVD, CD, and VideoCD only)

To playback in slow motion



During pause, press and hold  to play back in slow motion. To resume normal playback, press .

During pause, press and hold  to play back in reverse slow motion. (DVD only)

Hint

During slow motion playback, press  /  to change the playback speed. (DVD, CD, and Video CD only)

To advance by frame

During pause, press  to advance by frame. To resume normal mode, press .

During pause, press  to reverse by frame. (DVD only)

To adjust the volume level

Press **VOLUME +/-** on the remote control or **VOLUME ^ / v** on the DVD controller. The volume level appears in the front panel display.

■ Ejecting a disc

Press to stop disc playback, and then press **EJECT** on the DVD controller.

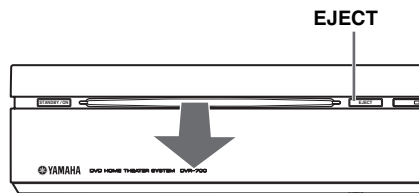

Note

Do not push the ejected disc when reloading it. To reload the ejected disc, press **EJECT**, or remove the disc from the disc loading slot fully, then insert it to the disc loading slot once again.

■ Using the disc menu (DVD only)

To display the disc menu

Press **TOP MENU** to display the top-level disc menu. Press **MENU** to return to the main menu. The same menu as the top-level disc menu may appear depending on the disc.

Hint

- Depending on the disc, a menu may appear on the TV screen once you load a disc.
- The disc menu is displayed when you press **TOP MENU** during playing DivX® files. (If available)

Note

Depending on the disc, these menus do not appear on the TV screen.

To select a playback feature or item

Press \triangle / ∇ / \leftarrow / \rightarrow on the remote control, then press **ENTER** to start playback.

You can also specify the number to select a feature or item.

To enter a number, switch FUNC./10KEY to 10KEY.

■ Playback control (PBC) (Video CD only)

Some Video CD/super Video CD discs are compatibility with PBC function.

PBC playback allows you to play Video CDs interactively, following the menu on the display.

To display the PBC menu

When you insert a video CD or super video CD with PBC function and press \triangleright , playback starts with the function.

During playback, press **RETURN** to display the menu.

Press \leftarrow / \rightarrow to display the other menu on the previous/next page.

To select a track in PBC menu

To select a track, switch FUNC./10KEY to 10KEY, enter the number, and then press **ENTER**.

Note

To disable PBC, press twice, then press \rightarrow . You can enter a track number using **Numeric keypad 0-9** instead of pressing \rightarrow .

To enable PBC again, press twice, then press \triangleright to play back.

■ Changing soundtrack language

While playing a DVD with multiple language soundtracks, press **AUDIO** repeatedly to select the language.

Notes

- If you cancel the resume mode or eject the disc, the language gets back to the default setting.
- When playing a Video CD, it switches 1/L (Left) and 2/R (Right).
- You can change the soundtrack language by pressing **AUDIO** during playing DivX® video files. (if available)
- Depending on the disc, you can change the soundtrack language only in the disc menu.

■ Changing subtitle language

This operation works only on DVDs with multiple subtitle languages. You can change the language you want while playing a DVD.

Press **SUBTITLE** repeatedly to select a language from the various subtitle languages.

Notes

- If you cancel the resume mode or eject the disc, the language gets back to the default setting.
- Depending on the disc, you can change the language only in the disc menu.
- You can change the subtitle language by pressing **SUBTITLE** during playing DivX® video files. (if available)

■ Resuming playback from the last stopped point

With the exception of VR format DVD-R/-RW discs, when you stop playback of a DVD, CD, or Video CD/ Super video CD or DivX® video/WMV discs, “RESUME” appears in the front panel display indicating that you can resume playback again from that point.

With DVDs and Video CD/Super video CDs, if you eject the disc in the DVD controller after stopping playback, the last play position is stored in memory. If the next disc you load is the same one, “Last Memory” appears and playback will resume. For DVD-Video discs, the system stores the play position of the last five discs. When one of these discs is next loaded, you can resume playback.

Hints

- To clear the resume point, press again while “RESUME” is displayed.
- If you don’t need the Last Memory function when you stop a disc, you can press **EJECT** to stop playback and eject the disc.

Notes

- Resume and Last Memory functions may not work with some discs.
- As for CD and movie files (DivX®/WMV), the resume point is cleared when the disc is ejected or the input is changed.

■ Viewing from another angle

If the disc contains sequences recorded from different camera angles, the angle mark appears on the screen. Press **ANGLE** repeatedly to select the desired angle.

Hint

You can hide the angle mark (Page 41).

■ Displaying disc information

Press **ON SCREEN** to display track, chapter and title information. Press **ON SCREEN** repeatedly to select the information.

■ Zooming in

This function allows you to enlarge the picture double or quadruple of the original size. While playing a disc, press **ZOOM** once to double or twice to quadruple the size. You can move the zoom point using \triangle / ∇ / \triangleleft / \triangleright . Press **ZOOM** one more time to return to the original size.

Advanced operation

When playing discs, you can use advanced operations such as repeat playback and programming playback. Use the menu to set them.

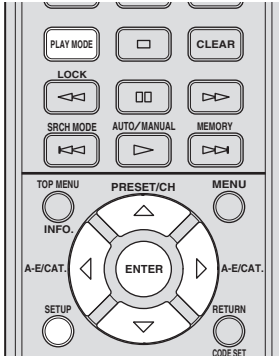

- Press **PLAY MODE** on the remote control. Play Mode menu appears.

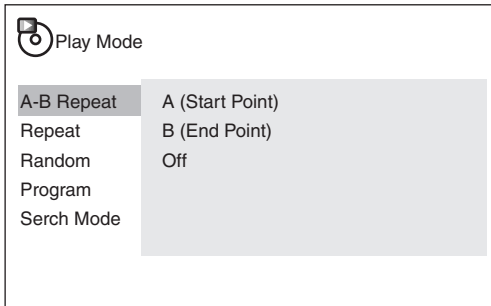

- Use \triangle / ∇ to select playback function, then press **ENTER**.
Setup for each items. Refer to the description below.

[A-B Repeat]	Repeats a specific section between A and B
[Repeat]	Repeats title/chapter/disc/track
[Random]	Plays titles/chapters/tracks randomly
[Program]	Plays titles/chapters/tracks in the order you want
[Search Mode]	Plays a specific chapter/track/time that you want to play

- Press **SETUP** to return to the previous screen.

A-B repeat playback

Select [A-B Repeat] in the Play Mode menu, then press **ENTER**.

Specify the section according to the following procedure. Once you specify the section, repeat playback starts.

Starting point: Select [A (Start)], then press **ENTER** at the point you want to start repeating.

End point: Select [B (End point)], then press **ENTER** at the point you want to end repeating.

Exiting repeat playback: Select [OFF], then press **ENTER**.

Notes

- A-B repeat playback is not available for DivX® Video/WMV discs.
- You cannot specify the section that straddles tracks.

Repeat playback

Select [Repeat] in Play Mode menu, then press **ENTER**. Select [Title Repeat]/[Chapter Repeat], then press **ENTER** at the point you want to repeat. Repeat playback starts.

To exit the repeat playback, select [Repeat Off], then press **ENTER**.

Available repeat playback

DVD: [Title Repeat], [Chapter Repeat]

CD/Video CD: [Disc Repeat], [Track Repeat]

DivX®/WMV: [Title Repeat], [Chapter Repeat] (if supported)

Hint

You can use program playback with repeat playback. If program playback is active, you can select [Program Repeat].

Random playback

Select [Random] in Play Mode menu, then press **ENTER**. When playing DVD, select [Random Title]/[Random Chapter], then press **ENTER**.

When playing CD/Video CD, select [On], then press **ENTER**.

To exit the random playback, select [Random Off], then press **ENTER**.

Program playback

Select [Program] in the Play Mode menu, then press **ENTER**.

When playing a DVD, you can program the order the titles/chapters are played back. When playing a CD/Video CD, you can only program the order the tracks are played back.

Programming the playback order

Select [Create/Edit] and press **ENTER** to open program list to set the playback order. Use \triangle / ∇ / \triangleleft / \triangleright and **ENTER** to program the order. You can store up to 24 steps.

Each time you press **ENTER**, the step moves to the next. Use the same procedure to complete the programming.

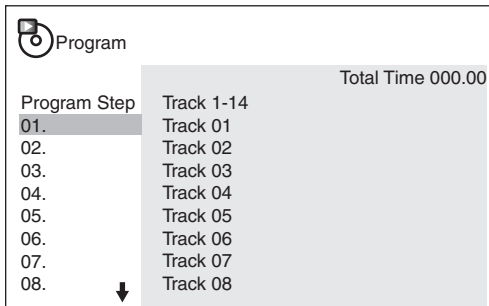

Hints

- To remove the step, press **CLEAR** on the step.
- To add a step in the middle of the list, select a title/chapter/track.
- If you press **SETUP** after programming, program playback is canceled. To do the program play back again, enter [Program] again.

Starting/Stopping program playback

In program mode, press \triangleright to start program playback.

Press \square to stop the program playback.

During program playback, press \lll / \ggg to skip to the next or previous programmed title/chapter/track.

Hint

You can also start/stop program playback by selecting [Playback Start]/[Playback Stop].

Deleting the program order

Select [Program Delete] in the menu, then press **ENTER**.

Using search mode

Select [Search Mode] in Play Mode menu, then press **ENTER**.

Select the item you want to search, then enter a title/chapter/track number using **Numeric keypad 0-9**.

Press **ENTER** to start playback.

Search mode types

DVD: [Title Search], [Chapter Search], [Time Search]

CD/Video CD: [Track Search], [Time Search]

DivX®/WMV: [Time Search], [Chapter Search] (if supported)

You can select [Time Search] during playback. Enter a 4-digit number to specify the minutes and seconds. For example, to specify 32 minutes and 20 seconds, enter 3220. To specify 1 hour, 25 minute, and 40 second, enter 8540.

■ Disc navigator

When playing DVD or Video CD, you can display a list of titles and tracks using disc navigator.

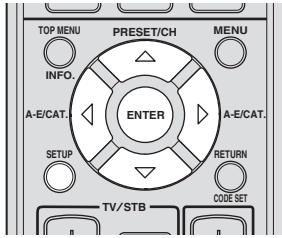

- ① Press **SETUP** on the remote control. DVD setup menu appears.

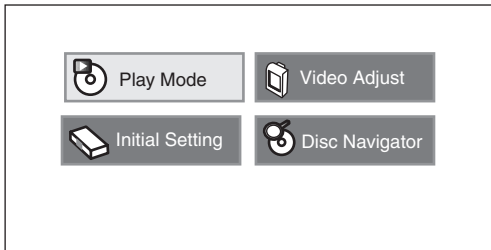

- ② Press \triangle / ∇ / \triangleleft / \triangleright to highlight [Disc Navigator], then press **ENTER**.
- ③ Select the item that you want to display in a list, then press **ENTER**.
The available items vary depending on the disc that you are loading.

DVD-Video: [Title], [Chapter]

DVD-R/R DL/RW (VR format): [Original: Title], [Original: Time], [Playlist: Title], [Playlist: Time]

Video CD: [Track], [Time]

Hints

- Select [Time] to display an image from every 10 minutes.
- Original means the titles recorded on a DVD recorder. Playlist means the titles arranged based on Original.

- ④ Select a number, then press **ENTER** to start playback. 6 titles/chapters/tracks will be displayed on the screen. Press \lll / \ggg to display the next/previous page. You can select the number either from the menu or remote control.



PLAYING OTHER DISCS

This system can play audio files and picture files recorded on CD-R or DVD-R/DVD+R, etc.

Note

The files and folders may not be recognized if the disc is in the following condition.

There are 299 or more folders in a disc.

There are 648 or more files or subfolders in a folder.

Compressed audio file

- MPEG1 audio layer3 (MP3)
- Windows Media Audio (WMA)
- MPEG-4 AAC

Hints

- The available sampling frequency is 32/44.1/48 kHz.
- The recommended bit rate for MP3/WMA is 128 kbps or higher.
- The supported bit rate for MPEG-4 AAC is between 16 and 320 kbps.
- The following filename extensions are supported. “.mp3” or “.MP3” (for MP3 files), “.wma” or “.WMA” (for WMA files), “.m4a” (for MPEG-4 AAC)

Notes

- Files that are encoded in VBR (Variable Bit Rate) cannot be played.
- Files that are encoded in loss-less format cannot be played.
- DRM copy-protected files cannot be played.
- Encode the WMA files with an application that is certified by Microsoft Corporation. If not, the files may not play back correctly.
- MPEG-4 AAC files encoded with iTunes are supported. Those files may not play back correctly depending on the version of iTunes.

Still image file

- JPEG
- FUJICOLOR CD
- KODAK Picture CD

Hints

- This unit is compatible with JPEG images that are 3072 x 2048 pixels or less.
- This unit supports the files that are compliant with Exif (Exchangeable Image File Format) version 2.2.
- The image file must have the file name extension “.jpg” or “.JPG”.

Note

This unit does not support progressive JPEG images.

■ To play back audio files

The audio files recorded on the disc are played back.

① Insert the disc that contains audio files.

② Press \triangleright , and playback starts.

During the playback, you can use the following operations.

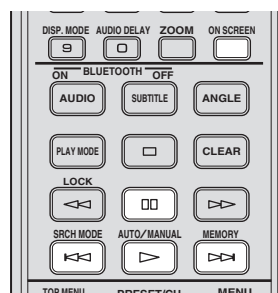

\square Pauses the slide show. When playing a disc with audio files, it pauses the music.

\ll / \gg Plays the previous/next track.

ON SCREEN Displays the track information on the TV display.

③ Press \square to stop.

4

BASIC OPERATIONS

■ To start a slide show of JPEG files

JPEG files recorded on the disc are played back in order in slide show.

During the slide show, you can play back all JPEG files in the disc in order.

Hints

- If the disc contains several folders, the pictures in each folders are displayed in alphabetical order.
- If the disc contains both JPEG files and compressible audio files, you can enjoy the music during the slide show.

① Insert a the disc that contains JPEG files.

② Press \blacktriangleright .

The slide show starts. During the slide show, you can do the following operations.



\square Pauses the slide show. When playing a disc with audio files, it pauses the music.

\ll / \gg Move to the previous/next picture. When playing a disc with audio files, it plays the previous/next song.

$\triangle / \nabla / \triangleleft / \triangleright$ Pauses the slide show to rotate or flip the picture. Press \blacktriangleright to restart the slide show.

ZOOM Pauses the slide show to enlarge the picture. Each time you press the key, the picture size doubles, quadruples, and then returns to normal. Press \blacktriangleright to restart the slide show.

MENU Displays Disc Navigator.

③ Press \square to stop the slide show.

■ Selecting a file to play back

You can select a file that you want to play back using Disc Navigator.

① Press **SETUP** after inserting the disc you want to play back.

The DVD setup menu appears on the screen.

② Select [Disc Navigator], then press **ENTER**.

Disc Navigator is opens.

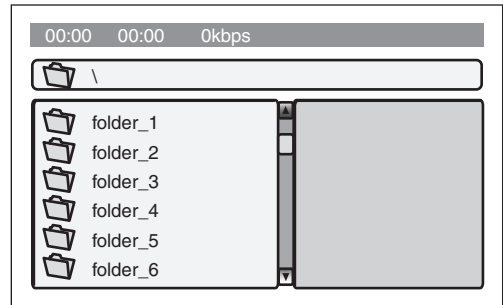

③ Press \triangle / ∇ to select the file you want to play back.

If you select a JPEG file, the preview image appears in the right window.

To move to the one lower folder

Select the folder, then press \blacktriangleright or **ENTER**.

To move to the one upper folder

Press \triangleleft . You can also move by selecting the [.] folder.

④ Press **ENTER** to play back the selected file/folder.

When playing audio/movie files

Playback starts from the selected file and plays the files in the folder.

When playing JPEG files

The slide show starts from the selected file and plays the files in the folder.

Hint

When the disc contains both audio files and JPEG files, play back an audio file first, then play back the pictures to enjoy the music during the slide show. In this case, \square and \ll / \gg is used for JPEG files.

⑤ Press \square to stop playback.

■ Using a USB device

You can play back audio files, and picture files saved on your USB devices.

Supported USB devices

The DVD controller supports USB mass storage class devices (e.g., flash memories, card readers, portable audio players) using FAT16 or FAT32 format.

Notes

- Some devices may not work properly even if they meet the requirements.
- If “USB ERROR” or “NO USB” appears in the front panel display, see the following methods.
 - Set the system to the standby mode, and then turn it on again.
 - Disconnect the device when the DVD controller is in the standby mode, then connect it again and turn on the DVD controller.
- Set the input source to USB, then remove and insert the USB device.
- Select the input source other than USB, then Set it back to USB again.
- Connect the AC adapter if the adapter is supplied with the device.
- If the electrical power consumption of the USB device is high, the USB device may not be used correctly.
- Do not connect devices other than USB mass storage class devices: USB chargers, USB hubs, PCs, etc.

Playing data files

Yamaha and suppliers accepts no liability for the loss of data saved on the USB devices connected to the DVD controller. As a precaution, it is recommended that the files are tested after they have been saved on.

- ① Press **DVD/USB** repeatedly until “USB” appears in the front panel display.
- ② Connect your USB device to the USB terminal of the DVD controller.

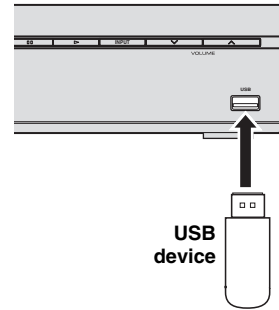

- ③ Start playback in either of the following ways.

When playing back all files in a USB device

Press **▷** to start playback.

When playing back the selected files

Press **MENU** to open Disc Navigator.

Press **△ / ▽ / ◀ / ▶** to select files, then press **▷**. Refer to page 34 for how to select files.

- ④ Press **□** to stop playback. Before you remove the USB device, select an input source other than USB.

Note

When the input source is USB, you cannot open the DVD setup menu.

DVD SETUP MENU OPTIONS

■ Menu overview

[Video Adjust] menu

Adjusts the picture quality. The bold items/parameters listed below are the default settings.

Menu Item	Setting item/Parameter
Sharpness	Fine, Standard , Soft
Brightness	-20 - 0 - +20
Contrast	-16 - 0 - +16
Gamma	High, Medium, Low, Off
Hue	green 9 - 0 - red 9
Chroma Level	-9 - 0 - +9

[Initial Settings] menu

Make advanced settings. The bold items/parameters listed below are the default settings.

Menu Item	Setting Item	Parameter	Page
Video Output	TV Screen	4:3 (Letter Box) , 4:3 (Pan&Scan), 16:9 (Wide), 16:9 (Compressed)	38
	Component Out	Progressive, Interlace	38
	HDMI Resolution	1920x1080p, 1920x1080i, 1280x720p, 720x480p*/720x576p* , 720x480i*/720x576i*	39
	HDMI Color	Full range RGB, RGB, Component	39
Language	Audio Language	English , French, German, Italian, Spanish, Other Language	40
	Subtitle Language	English , French, German, Italian, Spanish, Other Language	40
	DVD Menu Lang.	W/ Subtitle Lang. , English, French, German, Italian, Spanish, Other Language	40
	Subtitle Display	On , Off	40
Display	OSD Language	English , Français, Deutsch, Italiano, Español	41
	Angle Indicator	On , Off	41
Options	Parental Lock	Password, Level Change, Country Code	41
	DivX(R) VOD	Display	42

* Depending on the disc, NTSC and PAL switches automatically. For U.S.A. and Canada models, only NTSC is available.

Notes

- Refer to page 30 for [Play Mode]
- Refer to page 32 for [Disc Navigator]

VIDEO ADJUST MENU

This setup is carried out via the TV, enabling you to customize the DVD controller to suit your particular requirements

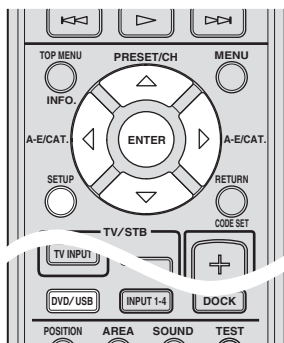

- ① Press **DVD/USB** repeatedly to switch the input source to DVD.
- ② Press **SETUP** on the remote control. DVD setup menu appears.

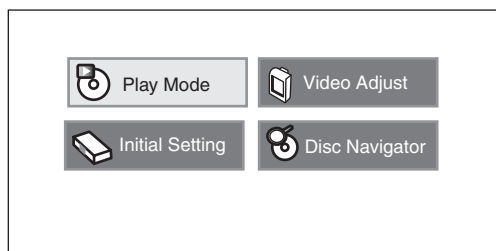

- ③ Press $\triangle / \nabla / \triangleleft / \triangleright$ to highlight [Video Adjust], then press **ENTER**.

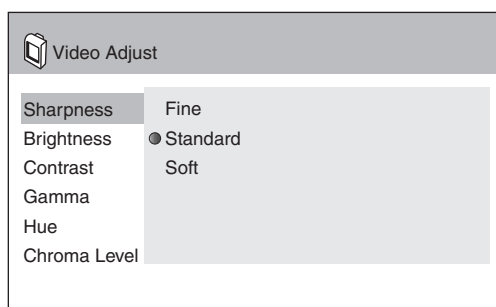

- ④ Select the item that you want to adjust, press **ENTER**, and then press $\triangle / \nabla / \triangleleft / \triangleright$ to adjust the image quality.

You can adjust the following items in Video Adjust menu.

[Sharpness]

Select this to adjust the sharpness. Choose from Fine/Standard/Soft.

[Brightness]

Increase or decrease the value to adjust the brightness. You can adjust the value from -20 to +20 using $\triangleleft / \triangleright$.

[Contrast]

Increase or decrease the value to adjust the sharpness. You can adjust the value from -16 to +16 using $\triangleleft / \triangleright$.

[Gamma]

Select this to adjust the darkness. Choose from High/Medium/Low/Off.

[Hue]

Select this to adjust the balance of green and red. You can adjust the value from Green 9 to Red 9 using $\triangleleft / \triangleright$.

[Chroma Level]

Select this to adjust the color density. You can adjust the value from -9 to +9 using $\triangleleft / \triangleright$.

- ⑤ Press **ENTER** to confirm.
Repeat steps 3 and 4 if necessary.
- ⑥ Press **SETUP** to close the menu.

Hints

- Once you confirm the values, you can select other items in Video Adjust menu.
- If the settings you have selected are not appropriate, you can reset DVD settings to the initial factory settings (Page 65).

Note

The sharpness setting does not affect the HDMI signal.

INITIAL SETTINGS MENU

This setup is carried out via the TV, enabling you to customize the DVD controller to suit your particular requirements

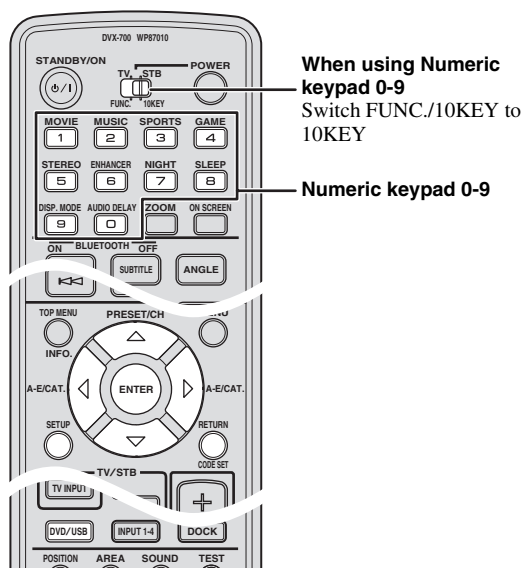

- ① Press **DVD/USB** repeatedly to switch the input source to DVD.
- ② Press **SETUP** on the remote control. DVD setup menu appears.
- ③ Press \triangle / ∇ / \leftarrow / \rightarrow to highlight [Initial Settings], then press **ENTER**.
- ④ Press \triangle / ∇ to highlight the item that you want to adjust, then press **ENTER**. Refer to the following explanations.
- ⑤ Press **ENTER** to confirm. Repeat steps 3 and 4 if necessary.
- ⑥ Press **SETUP** to close the menu.

Hint

If the settings you have selected are not appropriate, you can reset DVD settings to the initial factory settings (Page 65).

Video Output

Configure the video output settings.

Initial Setting		
Video Output	TV Screen	▶ 4:3 (Letter Box)
Language	Component Out	▶ Interlace
Display	HDMI Resolution	▶ 720x480p
Options	HDMI Color	▶ Component

TV Screen

Set the aspect ratio according to the TV you have connected.

[4:3 (Letter Box)] (default)

Select this if you have a conventional TV. In this case, a wide picture with black bands on the upper and lower portions of the TV screen will be displayed.

[4:3 (Pan&Scan)]

Select this if you have a conventional TV and want both sides of the picture to be trimmed or formatted to fit your TV screen.

Note

If the disc does not support an aspect ratio of 4:3 (Pan&Scan), the content is displayed in 4:3 (Letter Box).

[16:9 (Wide)]

Select this if you have a wide-screen TV.

[16:9 (Compressed)]

Select this if a wide-screen TV is connected to the DVD controller with an HDMI cable, and set HDMI Resolution to either [1920 x 1080p], [1920 x 1080i], or [1280 x 720p]. When playing back a content whose aspect ratio is 4:3, black bars cover the sides of the screen.

Component Out

Select the video type output via the COMPONENT VIDEO OUTPUT jacks.

[Progressive]

Select this if the connected TV has progressive display function. When you select this and press **ENTER**, the confirmation screen appears.

Press **ENTER** again to confirm the setting. If you want to cancel the setting, press **RETURN**.

[Interlace] (default)

Select this if the connected TV does not have progressive display function.

Notes

- Do not select [Progressive] if the connected TV does not have progressive display function.
- If your TV is also connected via HDMI OUTPUT terminal, the progressive signal may be output from the COMPONENT VIDEO OUTPUT jacks.

HDMI Resolution

Set the resolution output via the HDMI OUTPUT terminal. Select the resolution and press **ENTER**, and a message appears on the screen. Select [YES] to confirm. The available values are shown below.

[1920 x 1080p]

Select this if the connected TV is designed for progressive 1920 x 1080 resolution.

1080p/60Hz (NTSC)

1080p/50Hz (PAL)

[1920 x 1080i]

Select this if the connected TV is designed for interlaced 1920 x 1080 resolution.

1080i/60Hz (NTSC)

1080i/50Hz (PAL)

[1280 x 720p]

Select this if the connected TV is designed for progressive 1280 x 720 resolution.

720p/60Hz (NTSC)

720p/50Hz (PAL)

[720 x 480p] / [720 x 576p] (default)

Select this if the connected TV is designed for progressive 720 x 480 (NTSC color system)/720 x 576 (PAL color system) resolution.

480p/60Hz (NTSC)

576p/50Hz (PAL)

[720 x 480i] / [720 x 576i]

Select this if the connected TV is designed for interlaced 720 x 480 (NTSC color system)/720 x 576 (PAL color system) resolution.

480i/60Hz (NTSC)

576i/50Hz (PAL)

Notes

- Depending on the disc, NTSC and PAL switches automatically. For U.S.A. and Canada models, only NTSC is available.
- When you change the resolution, the screen may be distorted or take some time to be displayed.
- If the screen is not displayed correctly, reset HDMI resolution to the initial setting (Page 65).

HDMI Color

Set the color output for the HDMI component.

[RGB Full Range]

Reproduces bright white and deep black colors. Select this if the image reproducibility is poor.

[RGB]

Select this to lower the intensity of the picture when you selected RGB Full Range.

[Component]

Select this to set the standard component video output format of the HDMI component.

Note

The default setting varies depending on your HDMI component.

■ Language

These menus contain various language options for the audio, subtitle and disc menus recorded on the DVD. For details, Refer to “DISC OPERATION” on page 26.

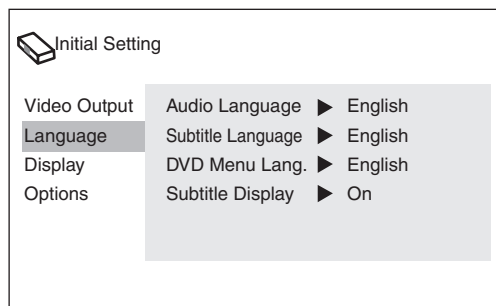

Notes

- Depending on the disc, the language set on the DVD controller may not play.
- If the disc does not contain the language that you set on the DVD controller, it may play in another in language.

Audio Language

Selects an audio language.

[English] (default), [French], [German], [Italian], [Spanish]

The selected language is used as a default audio setting.

[Other Language]

Selects an audio language from 136 languages. Once you select this item and press **ENTER**, you can select a language in “List of Languages” or “Code.” Refer to “LIST OF LANGUAGE CODES” on the appendix for the corresponding codes.

Subtitle Language

Select the subtitle language.

[English] (default), [French], [German], [Italian], [Spanish]

The selected language is used as a default subtitle setting.

[Other Language]

Selects a subtitle language from 136 languages. Once you select this item and press **ENTER**, you can select a language in “List of Languages” or “Code.” Refer to “LIST OF LANGUAGE CODES” on the appendix for the corresponding codes.

DVD Menu Lang.

Selects an displaying language for the DVD menu.

[W/ Subtitle Lang.] (default)

Displays the menu in the language selected in [Subtitle Language].

[English], [French], [German], [Italian], [Spanish]

Displays the menus in the selected language.

[Other Language]

Selects an audio language from 136 languages. Once you select this item and press **ENTER**, you can select a language in “List of Languages” or “Code.” Refer to “LIST OF LANGUAGE CODES” on the appendix for the corresponding codes.

Subtitle Display

Switch the subtitles On/Off.

[On]

The subtitles are displayed.

[Off]

The subtitles are not displayed.

■ Display

Set the screen display for the DVD controller.

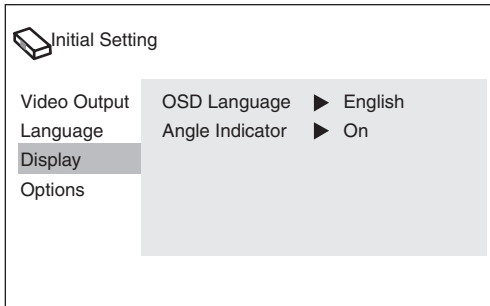

OSD Language

Selects a language for the DVD setup menu.

[English] (default), [Français], [Deutsch], [Italiano], [Español]

Displays the DVD setup menu in the selected language.

Angle Indicator

Switches the angle mark on/off. If the disc contains sequences recorded from different camera angles, the angle mark  appears on the screen. Press **ANGLE** repeatedly to select the desired angle.

[On]

The angle mark is displayed when the disc contains multi-angles.

[Off]

The angle mark is not displayed even if the disc contains multi-angles.

■ Options

You can set other items such as parental lock.

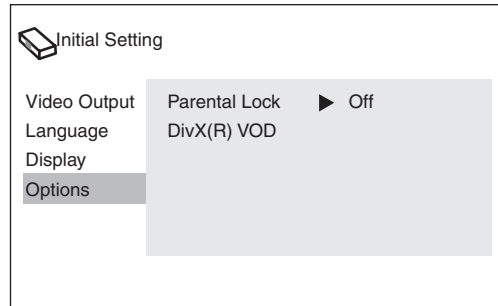

Parental Lock

Some DVDs may have a parental lock level assigned to the complete disc or to certain scenes on the disc. This feature lets you set a playback limitation level. The rating levels are from 1 to 8 and are country dependent. You can prohibit the playback of certain discs that are not suitable for your children, or play alternative scenes for certain discs.

[Password]

Set a password to use for the parental lock function. You need to enter the password to cancel the parental lock.

- ① To set a password, select [Password] and press **ENTER**.
- ② Use **Numeric keypad 0-9** on the remote control to enter a 4-digit number, then press **ENTER** to confirm.

Hint

When you play a DVD that is restricted by a parental lock, a screen requiring a password to be input appears. Use **Numeric keypad 0-9** to enter the password.

Notes

- Keep the password secure.
- If you forget the password, resets the DVD settings to the factory defaults, and set it again. For details, refer to “System menu” on page 65.

[Password Change]

Once you set a password, the item name changes to [Password Change]. If you select [Password Change], you can change the password.

- ① Select [Password Change] to change the password, then press **ENTER**.
- ② Use **Numeric keypad 0-9** on the remote control to enter the password that you have set before, then press **ENTER**.
- ③ Enter a new password using **Numeric keypad 0-9**, then press **ENTER**.

[Level Change]

You can change the parental lock level.

- ① Select [Level Change], then press **ENTER**.
- ② Use **Numeric keypad 0-9** on the remote control to enter a password, then press **ENTER** to confirm.
- ③ Press $\triangleleft / \triangleright$ to change the parental lock level, then press **ENTER**.

[Country Code]

You can change the country code. Refer to appendix at the end of this manual.

- ① Select [Country Code], then press **ENTER**.
- ② Use **Numeric keypad 0-9** on the remote control to enter a password, then press **ENTER** to confirm.
- ③ Press $\triangleup / \triangledown$ to change the parental level, then press **ENTER**. You can enter country code using **Numeric keypad 0-9**.

Note

When you change the country code, eject the disc once. Reinsert the disc to apply the settings.

DivX(R) VOD

Yamaha provides you with the DivX® VOD (Video On Demand) registration code that allows you to rent and purchase videos using the DivX® VOD service. For more information, go to www.divx.com/vod.

Notes

- If you try to play files without an authorized registration code, a message “Authorization Error” appears and the file does not start.
- If a file has a play time limit, the number of remaining plays is displayed on the screen.

You may need to show the registration code of this unit to the delivery site. You can check the registration code as shown below.

- ① Select [DivX(R) VOD], then press \triangleright .
- ② Select [Display], then press **ENTER**.
The registration code is displayed.

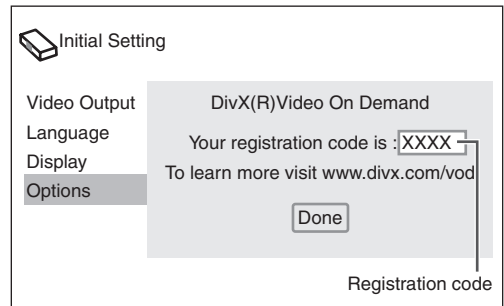

AIR SURROUND XTREME

■ What is AIR SURROUND XTREME?

Ordinarily, two speakers, a center speaker, two surround speakers, and a subwoofer are necessary for enjoying 5.1 channel surround sound.

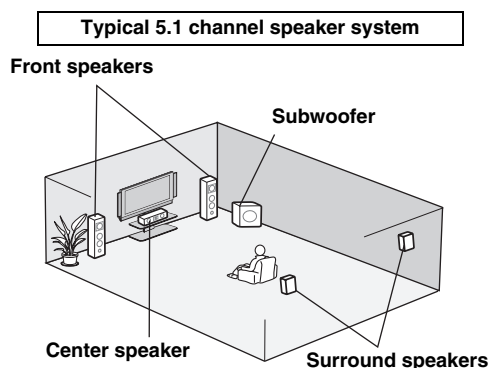

Virtual 7.1 channel

The AIR SURROUND XTREME technology, using only the left and right speakers of the this system and subwoofer, enables you to enjoy a realistic 7.1 channel sound by simulating sound from virtual speakers at center, surround, and surround backs.

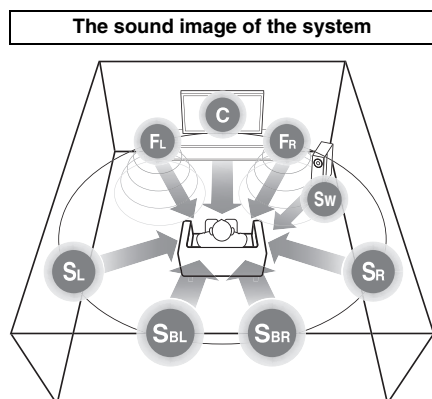

- C:** Center virtual speaker
- FR, FL:** Front speaker
- SW:** Subwoofer
- SR, SL:** Surround virtual speaker
- SBR, SBL:** Surround back virtual speaker

You can check the virtual surround effect and adjust the volume balance according to your preference and the characteristics of your listening room. Refer to the following pages for details.

- Checking the virtual surround effect. (Page 45)
- Adjusting the volume balance. (Page 64)

■ Listening to surround mode of AIR SURROUND XTREME

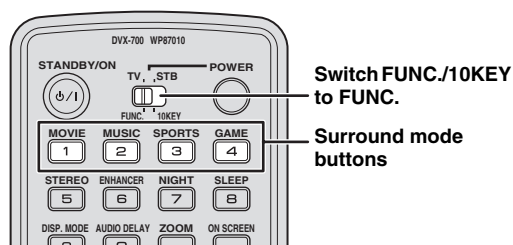

Press one of the surround mode buttons.

The names of the selected input source and the selected surround mode appear in the front panel display.

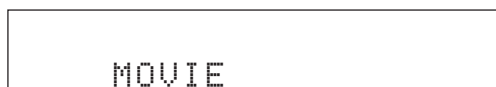

Surround mode descriptions

MOVIE

This mode is useful when you listen to a movie soundtrack on media such as DVDs, etc.

MUSIC

This mode is useful when you listen to music on media such as DVDs, etc.

SPORTS

This mode is useful when you enjoy sports or TV news programs.

GAME

This mode is useful when you play video games.

Hints

- To reproduce the original sounds, press **STEREO**.
- The system automatically memorizes the settings assigned to each input source. When you select another input, the system automatically recalls the last settings for the selected input.

■ Shifting the optimum listening area from side to side

This function shifts the optimum listening area from side to side according to your listening position for the best Virtual Surround effect.

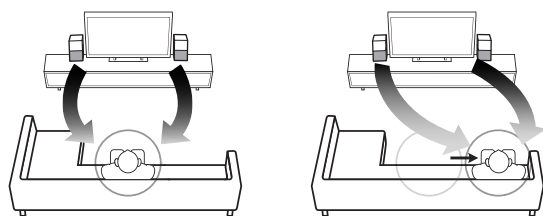

The optimum listening area

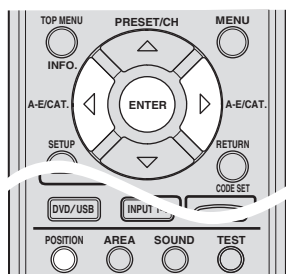

① Press **POSITION** to enter position mode.
The current position appears in the front panel display.

② Press $\triangleleft / \triangleright$ to shift the optimum listening area (L6, L5, L4, L3, L2, L1, CENTER, R1, R2, R3, R4, R5, R6).
Adjust the optimum listening area from L1 to L6 when your listening position is to the left side of the center position, and adjust the optimum listening area from R1 to R6 when your listening position is to the right side of the center position.
The position appears in the front panel display.



③ Press **POSITION** again or **ENTER** to exit position mode.

Hints

- The default setting is CENTER.
- If you press **TEST** after performing step 1, the system outputs the test tone for a virtual center speaker so that you can adjust the position setting. (Page 45)
- The setting is set for all the input sources.
- This function is available even when surround mode is off.

Note

If you do not operate this function within 30 seconds after entering position mode, the system automatically exits position mode.

■ Selecting the optimum distance between the speakers

The surround effect will be changed depending on the speaker positions. You can set the optimum distance area to enjoy the best surround effect at your listening position.

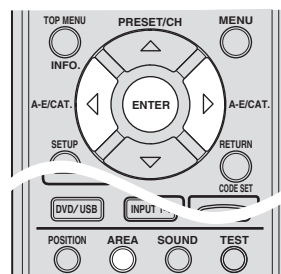
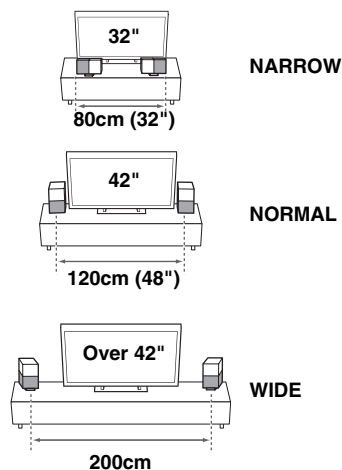

① Press **AREA** when the surround mode is activated.
The mode switches to the area setting mode. The current setting appears in the front panel display.

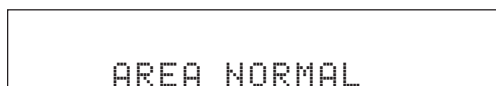

② Use $\triangleleft / \triangleright$ to select one of the following area.
NARROW: Select this when the distance between the speakers is about 80 cm.
NORMAL: Select this when the distance between the speakers is about 120 cm.
WIDE: Select this when the distance between the speakers is about 200 cm.

Hints

- The default setting is NORMAL.
- When you select WIDE, slightly turn the speakers toward the listening position to get the better surround effect.

③ Press **AREA** or **ENTER** to apply the setting.

Hint

This function is available when the surround mode or extended stereo mode is on. If you do not operate this function within 30 seconds after entering area setting mode, the setting automatically exits area setting mode.

■ **Checking the virtual surround effect**

You can check the virtual surround effect using test tones produced from the speakers.

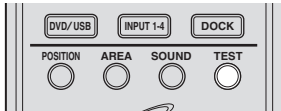

- ① Press **TEST** to output the test tone.
- ② The system outputs the test tone and the output channel of the test tone appears in the front panel display.

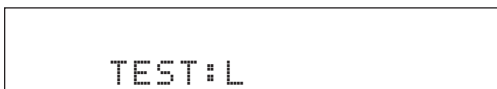

Active (virtual) speaker channel

The output channel of the test tone cycles through as follows. Each channel outputs the test tone for about 2 seconds.

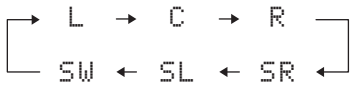

- ③ To cancel test tone mode, press **TEST** again.

Note

The surround back virtual speaker is included in SL and SR.

■ **Using extended stereo mode**

An extended sound is achieved for a 2 channel source such as a CD player.



Press **STEREO** to activate extended stereo mode. "EXTENDED" appears in the front panel display.



Each time you press **STEREO**, the function is turned on (EXTENDED) and off (STEREO) alternately.

Hints

- The default setting is STEREO.
- The system memorizes the settings assigned to each input source.
- You can also turn on compressed music enhancer mode when extended stereo mode is turned on.

Note

This operation is only available when the surround mode is not activated.

■ **Setting compressed music enhancer**

This function enhances your listening experience by regenerating the missing harmonics in a compression artifact. This is useful when you play back compressed music data stored on an iPod or a digital music player.



Press **ENHANCER**.

The ENHANCER indicator lights up in the front panel display when this function is turned on.

Each time you press **ENHANCER**, the function is turned on and off alternately. The selected mode is stored in memory even when the system is in the standby mode.

Hints

- The default setting is OFF.
- The system memorizes the settings assigned to each input source.
- When this function is on, night listening mode is automatically set to off.

LISTENING TO FM BROADCASTS

Make sure that the FM antenna is connected to the subwoofer/system control when using the tuner

You can use two tuning modes to tune into the desired FM station:

Frequency tuning mode

You can search or specify the frequency of the desired FM station automatically or manually.

Preset tuning mode

You can preset the desired FM stations in advance, and then recall the station by specifying the preset group and number.

Basic tuning operation

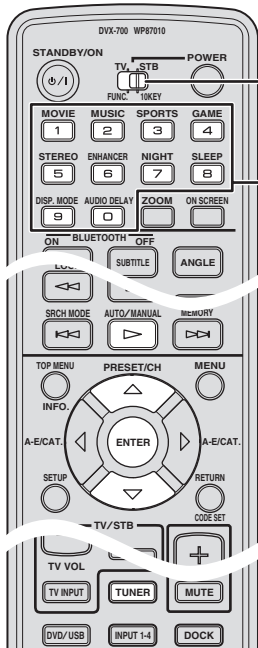

When using Numeric keypad 0-9
Switch FUNC./10KEY to 10KEY

Numeric keypad 0-9

The AUTO indicator lights up when the system is set to automatic tuning mode.

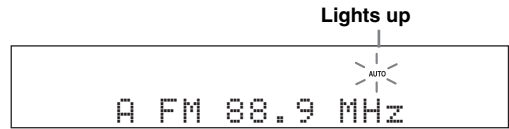

- Press **PRESET/CH** \triangle / ∇ once to begin automatic tuning.

When the system is tuned to a station, the TUNED indicator lights up and the frequency of the received station is shown in the front panel display.

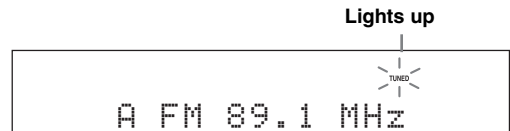

Hint

When you tune in an FM station using automatic tuning mode, the system receives the FM radio signal in stereo reception mode. The STEREO indicator appears in the front panel display.

Manual tuning

If the signal received from the station you want to select is weak, you can tune into the desired station by specifying the frequency manually. In FM tuning mode, press **AUTO/MANUAL** repeatedly so that the AUTO indicator disappears, and then press **PRESET/CH** \triangle / ∇ repeatedly to specify the frequency of the desired station.

If you tune into a station using the manual tuning feature, the system receives the FM radio signals in monaural reception mode to increase signal quality.

- Press **TUNER** repeatedly to set the input source to FM.
“FM” appears in the front panel display.



- Press **AUTO/MANUAL** to switch automatic tuning mode.

Direct frequency tuning

Use this feature to tune into the desired station directly by entering the frequency.

- ① Press **TUNER** to set the input source to FM.
- ② Press **AUTO/MANUAL** to select automatic tuning mode or manual tuning mode.
- ③ Use **Numeric keypad 0-9** to specify a radio frequency.
For example, enter 1037 using **Numeric keypad 0-9** to specify 103.7 MHz.

Hint

If the entered frequency is out of the range of the FM tuning, “WRONG STATION!” appears in the front panel display and then this unit automatically tunes into the last selected station.

Using station preset feature

You can store up to 40 stations (A1 to E8: 8 preset numbers in each of the 5 preset groups).

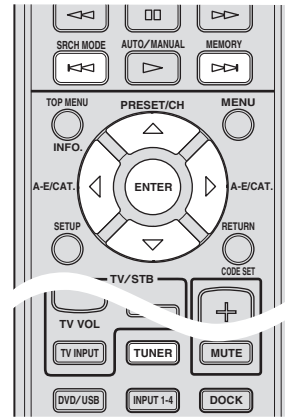

Automatic station preset

Available radio stations are automatically tuned in. You can set all available stations to a preset group at the same time by using automatic preset.

Note

Only radio stations with sufficient signal strength are set by automatic preset. If a radio station's signal is weak, set it by using manual preset tuning.

- ① Press **TUNER** repeatedly to set the input source to FM.
“FM” appears in the front panel display.
- ② Press and hold **MEMORY** for more than 3 seconds.
The preset group and number as well as the MEMORY and AUTO indicators flash. After approximately 5 seconds, automatic presetting starts from the current frequency and proceeds through higher frequencies.

Press **MEMORY** again to cancel while the MEMORY indicator is flashing.

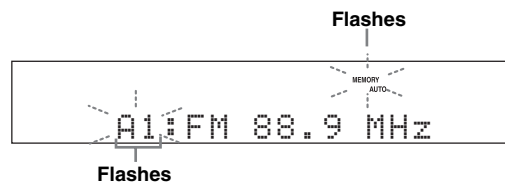

Hint

Press **A-E/CAT.** \triangleleft / \triangleright to select a preset group, and then press **PRESET/CH** \triangle / ∇ repeatedly to select a preset number to which the first station will be stored after you perform step 2.

Notes

- Any stored station data existing under a preset number is cleared when you store a new station under the same preset number.
- If the number of received stations does not reach 40 (A1 to E8), automatic preset tuning automatically stops after searching for all the available stations.

If the desired station is not stored, or a station is not stored to the desired preset group and number, preset the station manually. Refer to Manual station preset for details.

Manual station preset

Use this feature to store the radio stations manually.

- ① Tune into a station.
Refer to “Basic tuning operation” on page 46 for the details.
- ② Press **MEMORY**.
The MEMORY indicator flashes in the front panel display for approximately 30 seconds.
Press **MEMORY** again to cancel while the MEMORY indicator is flashing.

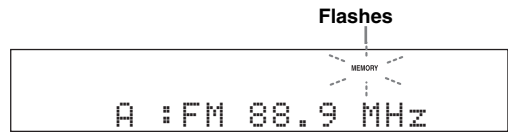

- ③ Press **A-E/CAT**. ◀ / ▶ repeatedly to select a preset group (A to E) while the MEMORY indicator is flashing.
The selected preset group appears.

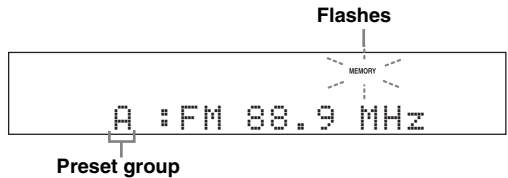

- ④ Press **PRESET/CH** ▲ / ▼ to select a preset number (1 to 8) while the MEMORY indicator is flashing.

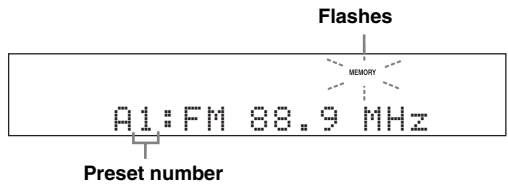

- ⑤ Press **MEMORY** to confirm the preset.

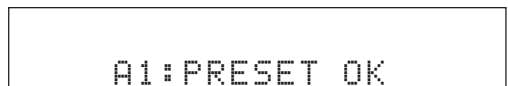

After “A1:PRESET OK” appears in the front panel display, the frequency appears with the preset group and number you selected. The MEMORY indicator disappears from the front panel display.

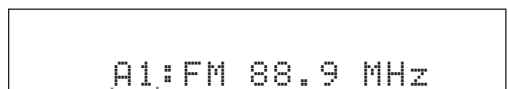

The displayed station has been stored as A1.

Notes

- Any stored station data existing under a preset number is cleared when you store a new station under the same preset number.
- The reception mode (stereo or monaural) is stored along with the station frequency.

■ Recalling the preset stations

If you have stored the preset stations based on “Presetting radio stations”, you can recall them using the following procedures.

- ① Press **TUNER** on the remote control.
“FM” appears in the front panel display.
- ② Press **PRESET/CH** to select preset tuning mode.

Hint

If a colon(:) appears, the system is set to preset tuning mode.

- ③ Use **A-E/CAT**. $\triangleleft / \triangleright$ to select the preset group (A to E).
- ④ Use **PRESET/CH** \triangle / ∇ to select the preset number you want (1 to 8).

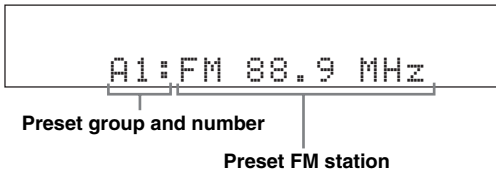
**Hint**

You can specify the preset number using **Numeric keypad 0-9** by switching FUNC./10KEY to 10KEY.

LISTENING TO XM[®] SATELLITE RADIO BROADCASTS

XM Satellite Radio offers an extraordinary variety of commercial-free music, plus the best in sports, news, talk and entertainment. XM is broadcast in superior digital audio from coast to coast. From rock to reggae, from classical to hip hop, XM has something for every music fan.

XM Satellite Radio online information

For U.S. customers: <http://www.xmradio.com/>
For Canadian customers: <http://www.xmradio.ca/>

XM READY legal disclaimer

XM monthly service subscription sold separately. XM Mini-Tuner and Home Dock required (each sold separately) to receive XM service. It is prohibited to copy, decompile, disassemble, reverse engineer, hack, manipulate or otherwise make available any technology or software incorporated in receivers compatible with the XM Satellite Radio System. Installation costs and other fees and taxes, including a one-time activation fee may apply. All fees and programming subject to change. Channels with frequent explicit language are indicated with an XL. Channel blocking is available for XM radio receivers by calling 1-800-XMRADIO (U.S. residents) and 1-877-GETXMSR (Canadian residents). XM service only available in the 48 contiguous United States and Canada. ©2008 XM Satellite Radio Inc. All rights reserved.

■ Connecting XM Mini-Tuner Home Dock

Connect XM Mini-Tuner and XM Mini-Tuner Home Dock (sold separately) to the XM terminal on the rear panel of subwoofer/system control. For details, see the operating instructions provided with the XM Mini-Tuner Home Dock.



XM Mini-Tuner and XM Mini-Tuner Home Dock (sold separately)

Hint

To ensure optimal reception of the XM Satellite Radio signals, the XM Mini-Tuner Home Dock must be placed at or near a southerly facing window with no obstacles in the path to the sky. You can mount it indoors or outdoors. Use the “ANTENNA INFO” information in the front panel display to check the antenna reception level and adjust the orientation of the antenna.

Notes

- If “CHECK ANTENNA” or “CHECK XM TUNER” appears in the front panel display, the connection and setting of the antenna, XM Mini-Tuner Home Dock, or XM Mini-Tuner may not be correct.
- If “UPGRADE” and “XM TUNER” appear in sequence in the front panel display, the connected XM Mini-Tuner is incompatible with this unit.

■ Activating XM Satellite Radio

Once you have installed the XM Mini-Tuner Home Dock, inserted the XM Mini-Tuner, connected the XM Mini-Tuner Home Dock to your XM Ready[®] home audio system, and installed the antenna, you are ready to subscribe and begin receiving XM programming. There are three places to find your eight characters XM Radio ID: On the XM Mini-Tuner, on the XM Mini-Tuner package, and on XM Channel 0. Record the XM Radio ID in the following eight squares for reference.



Note

The XM Radio ID does not use the letters “I”, “O”, “S” or “F”. Activate your XM Satellite Radio service in the U.S. online at <http://activate.xmradio.com/> or call 1-800-XM-RADIO (1-800- 967-2346). Activate your XM Satellite Radio service in Canada online at <https://activate.xmradio.ca/> or call 1-877-GET-XMSR (1-877-438-9677). You will need a major credit card. XM will send a signal from the satellites to activate the full channel lineup. Activation normally takes 10 to 15 minutes, but during peak busy periods you may need to keep your XM Ready home audio system on for up to an hour. When you can access the full lineup on your XM Ready home audio system you are done.

Basic XM Satellite Radio operations

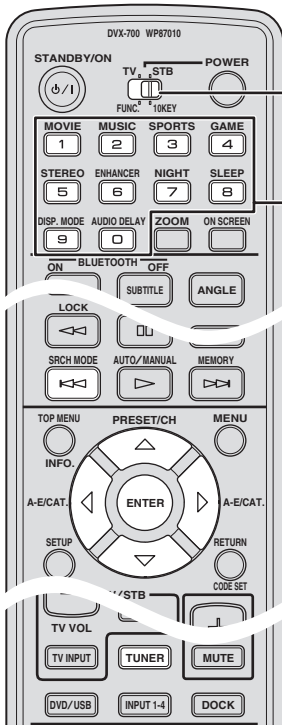

When using Numeric keypad 0-9
Switch FUNC./10KEY to 10KEY

Numeric keypad 0-9

- Press **TUNER** repeatedly to select “XM” as the input source.

The XM indicator lights up in the front panel display and the XM Satellite Radio information (such as channel number, channel name, category, and artist name/song title) for the currently selected channel appears in the front panel display.

Lights up

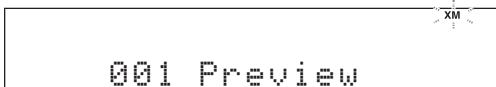

Hint

When you select “XM” as the input source, this unit automatically recalls the previously selected channel.

Note

If a status message or an error message appears in the front panel display, refer to the “XM Satellite Radio” section in “Troubleshooting” on page 68 for appropriate remedies.

- Search for a channel by using one of the XM Satellite Radio search modes.
 - To select a channel from the all channel list, refer to “All Channel Search mode” on page 51.

- To select a channel by category, refer to “Category Search mode” on page 51.
- To select a channel from the preset channels, refer to “Preset Search mode” on page 51.
- To select the desired channel directly by entering the channel number, refer to “Direct number access mode” on page 52.

All Channel Search mode

- Press **SRCH MODE** repeatedly to select “ALL CH SEARCH”.
- Press **PRESET/CH** \triangle / ∇ repeatedly to search for a channel within all channels.

Hint

You can search for a channel quickly by pressing and holding **PRESET/CH** \triangle / ∇ .

Category Search mode

- Press **SRCH MODE** repeatedly to select “CAT SEARCH”.
- Press **A-E/CAT.** \triangleleft / \triangleright repeatedly to change the channel category.
- Press **PRESET/CH** \triangle / ∇ repeatedly to search for a channel within the selected channel category.

Hint

You can search for a channel quickly by pressing and holding **PRESET/CH** \triangle / ∇ .

Preset Search mode

Prior to selecting a preset channel in the Preset Search mode, you must preset XM Satellite Radio channels. For details, refer to “Setting the XM Satellite Radio preset channels” on page 52.

Hint

The initial factory setting of all preset channels (A1 to E8) is “001 Preview”.

- Press **SRCH MODE** repeatedly to select “PRESET SEARCH”.
- Press **A-E/CAT.** \triangleleft / \triangleright repeatedly to change the preset channel group (A to E).
- Press **PRESET/CH** \triangle / ∇ repeatedly to change the preset channel number (1 to 8).

Hint

You can also select the preset channel number directly by pressing the **Numeric keypad 0-9**.

Direct number access mode

- ① Press **SRCH MODE** on the remote control repeatedly to select “ALL CH SEARCH” or “CAT SEARCH”.
- ② Press the **Numeric keypad 0-9** to enter the desired 3-digit channel number.
For example, to select the channel “123”, enter 123 using **Numeric keypad 0-9**.

Hints

- To enter a 1-digit or 2-digit channel number, press the **Numeric keypad 0-9** on the remote control and then press **ENTER** to confirm the input number.
- Instead of pressing **ENTER** to tune into the channel immediately, you can wait a few seconds until this unit confirms the entered channel number.

■ Setting the XM Satellite Radio preset channels

You can use this feature to store up to 40 XM Satellite Radio channels (A1 to E8: 8 preset channel numbers in each of the 5 preset channel groups). You can recall any preset channel easily by selecting the preset channel group and number as described in “Preset Search mode” on page 51.

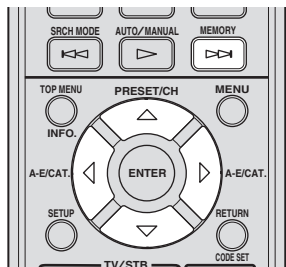

- ① Search for a channel you want to set as a preset channel by using one of the XM Satellite Radio search modes.
Refer to “Basic XM Satellite Radio operations” on page 51 for details.

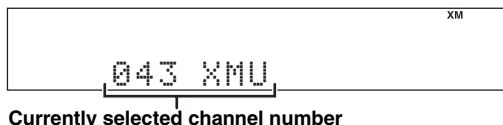

- ② Press **MEMORY**.
The **MEMORY** indicator flashes in the front panel display for approximately 30 seconds.

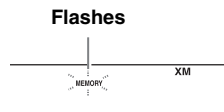

Note

You must proceed to and carry out steps 3 and 4 while the **MEMORY** indicator is flashing in the front panel display.

- ③ Press **PRESET/CH** \triangle / ∇ repeatedly to select a preset channel group and number (A1 to E8) while the **MEMORY** indicator is flashing.
The preset channel number appears in the front panel display.

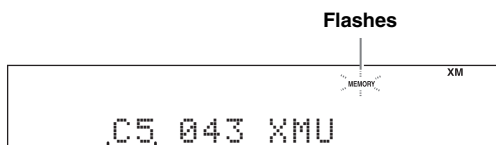

Selected preset channel group and number

Hint

You can select the preset station group (A to E) by pressing **A-E/CAT.** \triangleleft / \triangleright repeatedly.

- ④ Press **MEMORY** to set the selected XM Satellite Radio channel as a preset channel while the **MEMORY** indicator is flashing.
A colon (:) appears next to the preset channel number for confirmation, and the **MEMORY** indicator turns off in the front panel display.

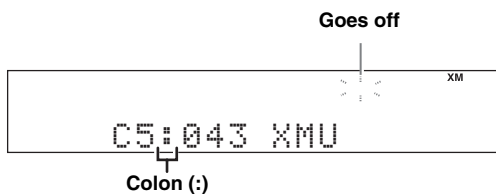

Note

Once you set a new preset channel, the one previously stored in the same preset channel group and number is overwritten.

■ Displaying the XM Satellite Radio information

You can display the XM Satellite Radio information (such as channel number, channel name, category, artist name, or song title) for the currently selected channel in the front panel display.

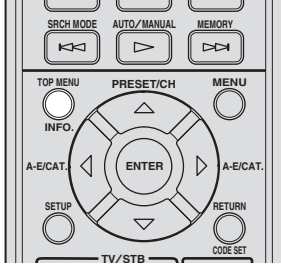

Note

If a status message or an error message appears in the front panel display, refer to the “XM Satellite Radio” section in “Troubleshooting” on page 68 for appropriate remedies.

Press **INFO.** repeatedly to toggle between the following XM Satellite Radio information display modes.

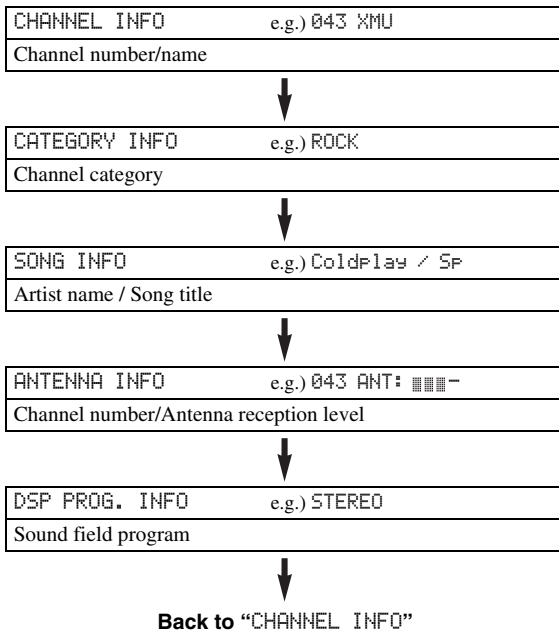

Hints

- The front panel display can indicate up to 14 alphanumeric characters at once. If the information contains more than 14 alphanumeric characters, it starts scrolling.
- If the XM Satellite Radio information contains a character that cannot be recognized by this unit, the character will be displayed with a space.

- To hold the current XM Radio information, press **ENTER** on the remote control while it is being displayed. The HOLD indicator flashes in the front panel display while you are holding the XM information. Press **ENTER** again to release the held information.
- When the antenna of the XM Mini-Tuner Home Dock cannot receive the signals, “NO SIGNAL” appears in the front panel display.

LISTENING TO SIRIUS SATELLITE RADIO™ BROADCASTS

SIRIUS Satellite Radio provides over 130 channels of exclusive entertainment and 100% commercial-free music. Only SIRIUS has more than 65 original music channels, from today's hits to R&B, oldies, and classical masterpieces. From authentic country and real bluegrass to cool jazz, hot latin, reggae, rock and many more. Best of all, it's all 100% commercial-free.

SIRIUS also has more than 55 channels of world-class sports, news and entertainment. Included as part of your subscription, you get up to 16 NFL games a week, up to 40 NBA games a week and up to 40 NHL games a week. (Games are broadcast during their respective seasons.) Coupled with great sports news from ESPN, the SIRIUS sports offering is unrivaled. And don't forget a host of other great news and entertainment, like NPR, CNBC, Fox News, Radio Disney and E! Entertainment Radio. For more information, visit <http://www.sirius.com/>.

SIRIUS Satellite Radio legal disclaimer

SIRIUS is available in the U.S.A. for subscribers with addresses in the continental U.S.A. and is available in Canada for subscribers with a Canadian address. To Get SIRIUS Satellite Radio a subscription and compatible tuner and antenna are required and sold separately. Visit sirius.com for the most complete and up-to-date channel lineup and information.

“SIRIUS” and the SIRIUS dog logo and related marks are trademarks of SIRIUS Satellite Radio Inc.

■ Connecting the SiriusConnect™ tuner

Connect the SiriusConnect tuner (sold separately) to the SIRIUS terminal on the rear panel of the unit. For details, see the operating instructions provided with the SiriusConnect tuner.

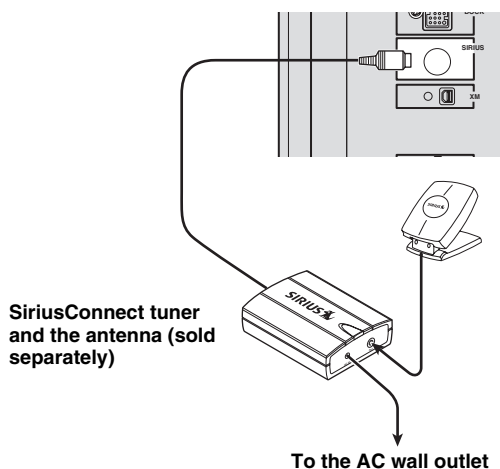

Hints

- To ensure optimal reception of the SIRIUS Satellite Radio signals, the antenna of the SiriusConnect tuner must be placed at or near a window with no obstacles in the path to the sky. The orientation of the antenna for the best reception differs depending on the area. Refer to the instruction manuals supplied with the SiriusConnect tuner for the installation of the antenna. You can mount it indoors or outdoors.
- Use the “ANTENNA INFO” information in the front panel display to check the antenna reception level and adjust the orientation of the antenna.
- You need to connect the SiriusConnect tuner to the AC wall outlet.

Notes

- If “CHECK SR TUNER” or “ANTENNA ERROR” appears in the front panel display, the connection of the SiriusConnect tuner or antenna is incorrect. In such cases, check the connection of the SiriusConnect tuner and the antenna.
- If “NOT SUPPORTED” appears in the front panel display, the unit does not support the connected SiriusConnect tuner.

■ Activating SIRIUS Satellite Radio™ subscription

Before using the SIRIUS Satellite Radio feature, you need to activate your SIRIUS Satellite Radio subscription. To activate the subscription you need the Sirius ID which is uniquely assigned to the SiriusConnect tuner. Sirius ID is a 12-digit number and it appears on the package of the SiriusConnect tuner, on the label of the SiriusConnect tuner, and when you tune into the SIRIUS Satellite Radio channel “0” (see below).

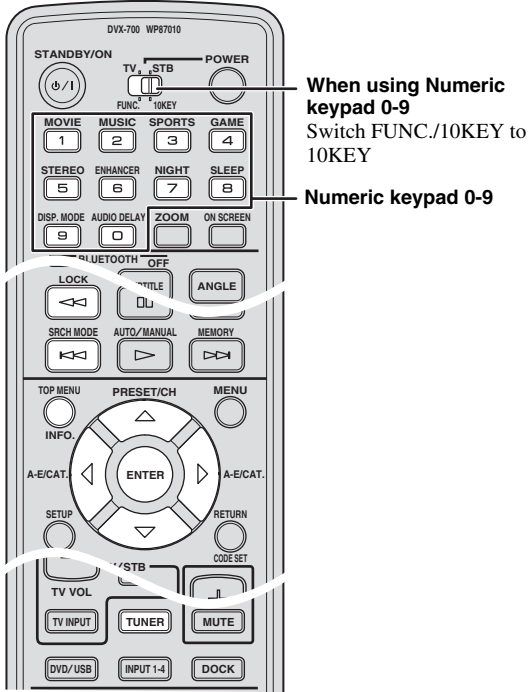

■ Displaying the Sirius ID of your SiriusConnect™ tuner

- ① Press **TUNER** repeatedly to select “SIRIUS” as the input source.
- ② Press “0” (on the **Numeric keypad 0-9**) and **ENTER** to display the Sirius ID of your SiriusConnect tuner.
“000 Sirius IDxxxxxxxxxxx” (“xxxxxxxxxxx” indicates the 12-digit Sirius ID of your SiriusConnect tuner) appears in the front panel display.

Hints

- You can also display the Sirius ID by entering “000”.
- To scroll the message again, press **INFO.**

Write the Sirius ID below.

ID _____

- ③ Contact SIRIUS Satellite Radio to activate your subscription.

SIRIUS Satellite Radio online information

Contact for activation

URL: <https://activate.siriusradio.com/>

Phone: 1-888-539-SIRIUS (1-888-539-7474)

Hint

Status messages appear in the front panel display during the activation. Once the activation is finished, “SUB UPDATED” appears.

■ Basic SIRIUS Satellite Radio™ operations

- ① Press **TUNER** repeatedly to select “SIRIUS” as the input source.

The SIRIUS indicator lights up in the front panel display and the SIRIUS Satellite Radio information (such as channel number, channel name, category, and artist name/song title) for the currently selected channel appears in the front panel display.

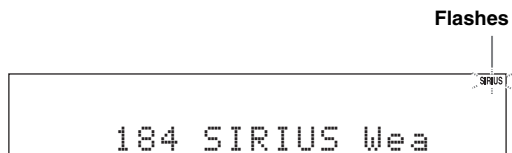

Hint

When you select “SIRIUS” as the input source, this unit automatically recalls the previously selected channel.

Notes

- When you have not activated your subscription yet, you can only select “184” or “000”.
 - If a status message or an error message appears in the front panel display, refer to the “SIRIUS Satellite Radio” section in “Troubleshooting” on page 69 for appropriate remedies.
- ② Search for a channel by using one of the SIRIUS Satellite Radio search modes.
 - To select a channel from the all channel list, refer to “All Channel Search mode” on page 56.
 - To select a channel by category, refer to “Category Search mode” on page 56.
 - To select a channel from the preset channels, refer to “Preset Search mode” on page 56.
 - To select the desired channel directly by entering the channel number, refer to “Direct number access mode” on page 56.

Hints

- If you tune into a channel that you do not subscribe, “CALL 888-539-SIRIUS TO SUBSCRIBE CH xxx” appears in the front panel display. To scroll the message again, press **INFO**.
- You can set the SIRIUS Satellite Radio preset channels (Page 57).
- You can display the SIRIUS Satellite Radio information in the front panel display (Page 59).

All Channel Search mode

- ① Press **SRCH MODE** repeatedly to select “ALL CH SEARCH”.
- ② Press **PRESET/CH** \triangle / ∇ repeatedly to search for a channel within all channels.

Hints

- You can search for a channel quickly by pressing and holding **PRESET/CH** \triangle / ∇ .
- You can skip channels to the previous or next category by pressing **A-E/CAT**. \triangleleft / \triangleright .

Category Search mode

- ① Press **SRCH MODE** repeatedly to select “CAT SEARCH”.
- ② Press **A-E/CAT**. \triangleleft / \triangleright repeatedly to change the channel category.
- ③ Press **PRESET/CH** \triangle / ∇ repeatedly to search for a channel within the selected channel category.

Hint

You can search for a channel quickly by pressing and holding **PRESET/CH** \triangle / ∇ .

Note

The system skips the channels when the system is All Channel Search mode or Category Search mode in the following cases (it is not malfunction of the system):

- the channel is locked (page 58).
- the channel is out of service.
- you do not subscribe to the channel.

Preset Search mode

Before selecting a preset channel in the Preset Search mode, you must preset SIRIUS channels. Refer to “Setting the SIRIUS Satellite Radio™ preset channels” on page 57 for details.

- ① Press **SRCH MODE** repeatedly to select “PRESET SEARCH”.
- ② Press **A-E/CAT**. \triangleleft / \triangleright repeatedly to change the preset channel group (A to E).

- ③ Press **PRESET/CH** \triangle / ∇ repeatedly to change the preset channel number (1 to 8).

Hint

You can also select the preset channel number directly by pressing the **Numeric keypad** (1 to 8).

Direct number access mode

- ① Press **SRCH MODE** on the remote control repeatedly to select “ALL CH SEARCH” or “CAT SEARCH”.
- ② Press the **Numeric keypad 0-9** to enter the desired 3-digit channel number.
For example, to select the channel “123”, enter 123 using **Numeric keypad 0-9**.

Hints

- To display the Sirius ID number displayed in the front panel display, select channel “0”.
- To enter a 1-digit or 2-digit channel number, press the **Numeric keypad 0-9** and then press **ENTER** to confirm the input number.
- Instead of pressing **ENTER** to tune into the channel immediately, you can wait a few seconds until the system confirms the entered channel number.
- If the selected channel is locked, “PIN:___” appears in the front panel display. Enter the 4-digit Parental Lock code number by using the **Numeric keypad 0-9** or press **LOCK** to cancel (Page 58).

■ Setting the SIRIUS Satellite Radio™ preset channels

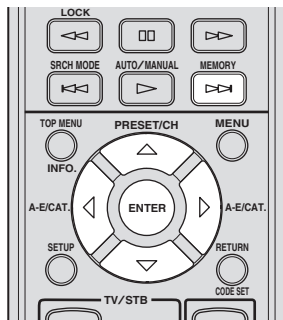

You can use this feature to store up to 40 SIRIUS Satellite Radio channels (A1 to E8: 8 preset channel numbers in each of the 5 preset channel groups). You can recall any preset channel easily by selecting the preset channel group and number as described in “Preset Search mode” on page (Page 56).

- ① Search for a channel you want to set as a preset channel by using one of the SIRIUS Satellite Radio search modes.
Refer to “Basic SIRIUS Satellite Radio™ operations” on page 55 for details.



Currently selected channel number

- ② Press **MEMORY**.
The MEMORY indicator flashes in the front panel display for approximately 30 seconds.

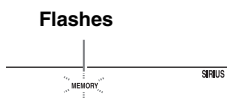

Note

You must proceed to and carry out steps 3 and 4 while the MEMORY indicator is flashing in the front panel display.

- ③ Press **PRESET/CH** \triangle / ∇ repeatedly to select a preset channel group and number (A1 to E8) while the MEMORY indicator is flashing.

The preset channel number appears in the front panel display.

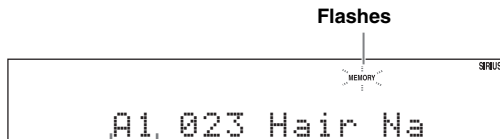

Currently selected preset channel group and number

Hint

You can select the preset station group (A to E) by pressing **A-E/CAT**. \triangle / ∇ repeatedly.

- ④ Press **MEMORY** to set the selected SIRIUS Satellite Radio channel as a preset channel while the MEMORY indicator is flashing.

A colon (:) appears next to the preset channel number for confirmation, and the MEMORY indicator turns off in the front panel display.

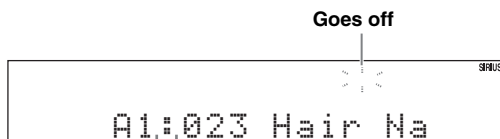

Colon (:)

Note

Once you set a new preset channel, the one previously stored in the same preset channel group and number is overwritten.

■ Setting the Parental Lock

You can use the Parental Lock feature to limit the access to the desired SIRIUS Satellite channels. The system automatically skips the locked channels when the system is in the All Channel Search mode or Category Search mode and you search a channel by pressing **PRESET/CH** \triangle / ∇ .

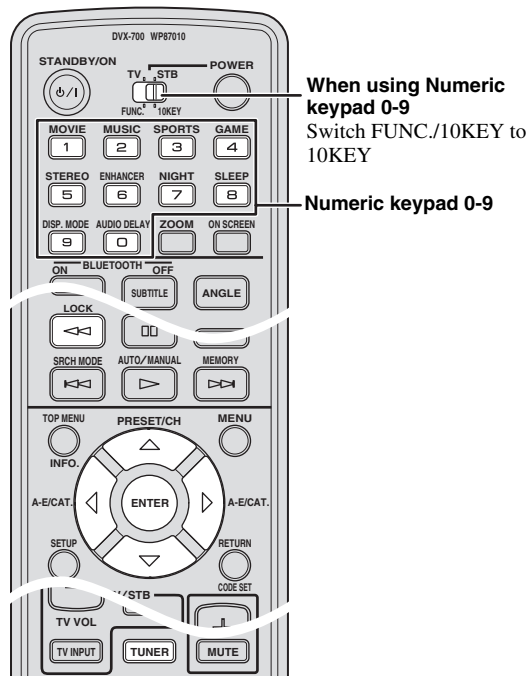

Locking/Unlocking channels

Use this feature to set the Parental Lock code number (PIN) and select the channels to be locked.

- ① Press **TUNER** repeatedly to select “SIRIUS” as the input source.
- ② Press **LOCK**. “PARENTAL LOCK” appears in the front panel display.
- ③ Press **ENTER**. “NEW PIN:0000” appears.



Hint

If the Parental Lock code number is already set, “PIN:___” appears instead of “NEW PIN:0000”.

Note

If a SiriusConnect tuner is not connected to the unit, “Not Available” appears.

- ④ Press **A-E/CAT.** \triangle / ∇ to select the place you want to change, then enter a number by pressing **Numeric keypad 0-9**.

Complete the other places using the same procedure. Keep the parental lock code number secure. You need it the next time you change the number again.

PIN_____

Hints

- To cancel the setting, press **LOCK** during the setting.
- If you forget the password, restore to the factory defaults. Refer to “System menu” on page 65 for details.
- Each time you enter a number, the cursor moves to the next place.
- You can change the number by moving the cursor to the place again.

- ⑤ Press **ENTER** to confirm the setting.

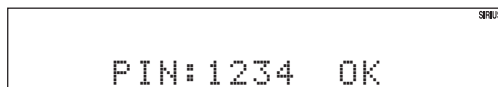

- ⑥ Select a channel you want to lock. Refer to “Basic SIRIUS Satellite Radio™ operations” on page 55 for details.

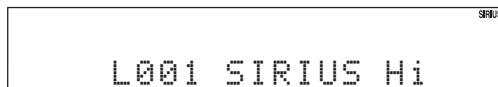

- ⑦ Press **ENTER** to set the parental lock. Once the parental lock is set, the channel number is displayed with asterisk “*”.

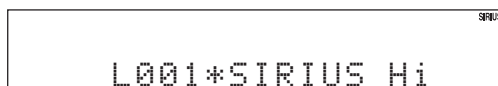

Hint

Each time you press **ENTER**, lock (asterisk “*”) appears) and unlock (asterisk “*” disappears) switches in sequence.

- ⑧ Repeat the steps 6 and 7 to lock other channels.
- ⑨ Press **LOCK** to return to the original display.

Hint

To cancel the parental lock using the same procedures as when you have locked the channel. Once the lock is canceled, the asterisk “*” disappears.

Tuning into the locked channels

You can tune into the locked channels by the Direct number access mode or preset tuning mode. When you tune into the locked channel, following message appears in the front panel display. Enter the code number you set for the parental lock feature by using **Numeric keypad 0-9**.



Notes

- Enter each code number within 10 seconds.
- If the entered code number is incorrect, “Wrong” appears in the front panel display.
- To cancel the tuning, press **LOCK**.

■ Displaying the SIRIUS Satellite Radio™ information

You can display the SIRIUS Satellite Radio information (such as channel number, channel name, category, artist name, composer name, or song title) for the currently selected channel in the front panel display.

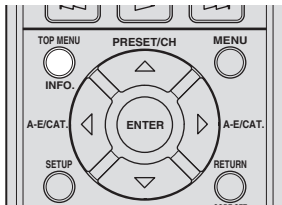

Note

If a status message or an error message appears in the front panel display, refer to the “SIRIUS Satellite Radio” section in “Troubleshooting” on page 69 for appropriate remedies.

Displaying the SIRIUS Satellite Radio information in the front panel display

Press **INFO** repeatedly to toggle between the following SIRIUS Satellite Radio information display modes.

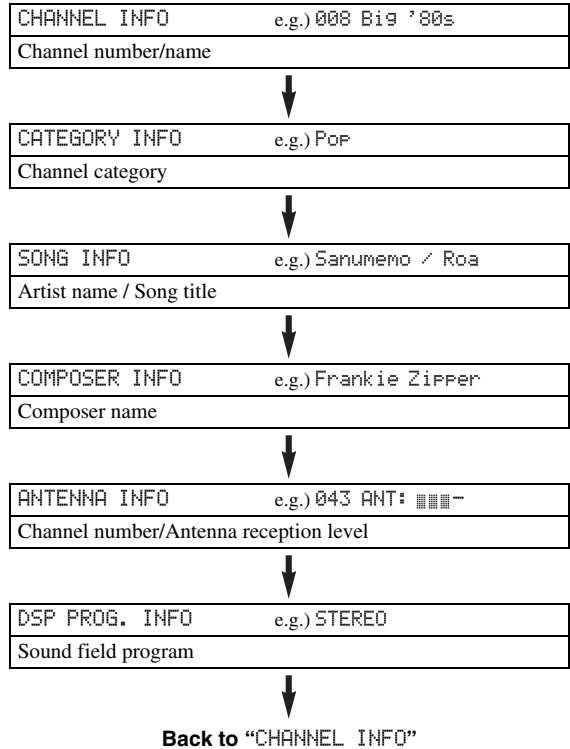

Hints

- The front panel display can indicate up to 14 alphanumeric characters at once. If the information contains more than 14 alphanumeric characters, it starts scrolling.
- If the SIRIUS Satellite Radio information contains a character that cannot be recognized by the system, the character will be displayed with a space.
- To hold the current SIRIUS Satellite Radio information, press **ENTER** on the remote control while it is being displayed. The HOLD indicator flashes in the front panel display while you are holding the SIRIUS Satellite Radio information. Press **ENTER** again to release the held information.
- When the antenna of the SiriusConnect tuner cannot receive the signals, “ACQUIRING” appears in the front panel display.
- When an information is unavailable, “----” appears.

USING OPTIONAL EQUIPMENT

■ Using iPod™

Once you have stationed your iPod in the Yamaha iPod universal dock (such as YDS-10/ YDS-11, sold separately) connected to the DOCK terminal of the subwoofer/system control (Page 20), you can enjoy playback on your iPod.

Supported iPod

iPod (Click and Wheel)
iPod touch
iPod nano
iPod mini

Battery charge feature

This system charges the battery of an iPod stationed in the Yamaha iPod universal dock connected to the DOCK terminal of the subwoofer/system control while this system is turned on.

Stationing your iPod in the Yamaha iPod universal dock

Once you station your iPod in the Yamaha iPod universal dock, “iPod connected” and the DOCK indicator appear in the front panel display.

Notes

- Some features may not be available depending on the model or the software version of your iPod.
- For a complete list of status messages that appear in the front panel display, Refer to the “iPod” section in “TROUBLESHOOTING” (Page 67).
- Be sure to set the volume to minimum before docking or removing your iPod.

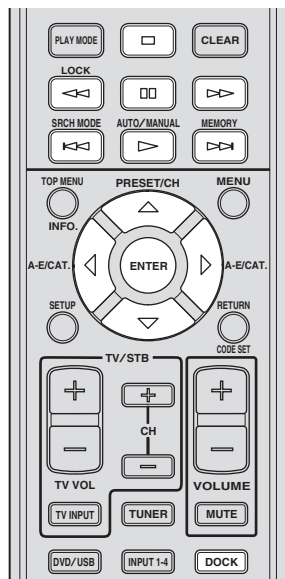

DOCK

Set the input source to DOCK.

Playback control buttons

Controls the connected iPod.

- ▷: Play/pause (Normal mode),
Play (Menu browse mode)
- ⏏: Play/pause (Normal mode),
Pause (Menu browse mode)
- : Stop
- ◀◀ / ▶▶: Skip backward/forward.
When you press ◀◀ just after a song has started, skip backward to the beginning of the previous song.
- ◀◀ / ▶▶: Search backward/forward.

Cursor buttons (△ / ▽ / ◀ / ▶) / ENTER

Navigates the menus on your iPod.

- Press ◀ to move to a previous menu level.
- Press △ / ▽ to move the cursor to an upper/lower menu.
- Press ENTER or ▶ to confirm the selected menu.
- Press ENTER in the “Songs” level menu screen to play the selected song.

INFO.

Switches between simple remote mode and menu browse mode.

Controlling your iPod in simple remote mode

Docking your iPod in the Yamaha iPod universal dock (such as YDS-10 or YDS-11, sold separately) enters simple remote mode. You can perform the basic operations of your iPod (play, stop, skip backward/forward, etc.) using the supplied remote control in this mode.

Hint

Operations can be also done with the controls on your iPod. Refer to the instruction manuals of your iPod for information about these operations.

Controlling your iPod in menu browse mode

Song information and play lists are displayed in the front panel display so that you can select and play back songs or adjust settings using the supplied remote control in this mode.

Notes

- Operations cannot be done with the controls of your iPod.
 - Characters that cannot be displayed in the front panel display are replaced with underscores “_”.
- ① Press **INFO**. to enter menu browse mode.
 - ② Press $\triangle / \nabla / \triangleleft / \triangleright$ repeatedly to select the desired menu, and then press **ENTER** to play back the selected song.

Options	Level 1	Level 2	Level 3	Level 4
Playlists	Playlist	Song list		
Artists	Artist list	Album list	Song list	
Albums	Album list	Song list		
Songs	Song list			
Genres	Genre list	Artist list	Album list	Song list
Composers	Composer list	Album list	Song list	
Settings	Setting list			

Shuffle

Use this feature to set the system to play songs or albums in random order.

Options: Off, Songs, Album

You can switch each option by pressing **ENTER**.

- Select “Off” to deactivate this feature.
- Select “Songs” to set the system to play songs in random order.
- Select “Album” to set the system to play albums in random order.

Repeat

Use this feature to set the system to repeat one song or a sequence of songs.

Options: Off, One, All

You can switch each option by pressing **ENTER**.

- Select “Off” to deactivate this feature.
- Select “One” to set the system to repeat one song.
- Select “All” to set the system to repeat a sequence of songs.

Note

The contents of the iPod menu vary, depending on the model or the generation.

Using Bluetooth™ components

You can connect the Yamaha Bluetooth wireless audio receiver (such as YBA-10, sold separately) to the DOCK terminal of the subwoofer/system control and enjoy the music contents stored in your Bluetooth component (such as a portable music player or computer equipped with a Bluetooth transmitter, etc.) without connecting it to the system. You need to perform “pairing” of the connected Yamaha Bluetooth wireless audio receiver and your Bluetooth component in advance.

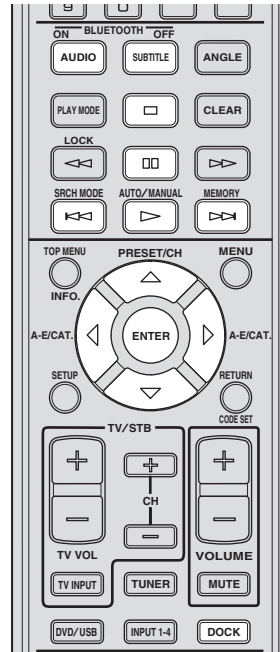

DOCK

Set the input source to DOCK.

BLUETOOTH ON / BLUETOOTH OFF

- Start or cancel the pairing.
- Connect or disconnect a Bluetooth component.

Playback control buttons

Control the playback of a Bluetooth component.

- \triangleright : Play
- \square : Pause
- \square : Stop
- $\triangleleft\triangleleft / \triangleright\triangleright$: Skip backward/forward

Pairing the Yamaha Bluetooth™ wireless audio receiver and your Bluetooth™ component

Pairing must be performed before using a Bluetooth component with the Yamaha Bluetooth wireless audio receiver connected to the system for the first time or if the registered pairing data has been deleted. “Pairing” refers to the operation of registering a Bluetooth component for Bluetooth communications.

To ensure security, a time limit of 8 minutes is set for the pairing operation. Please read and fully understand all the instructions before starting.

- ① Connect the Yamaha Bluetooth wireless audio receiver to the DOCK terminal of the subwoofer/ system control. (Page 20)
- ② Press **DOCK** to set the input source to DOCK.
- ③ Turn on the Bluetooth component you want to pair with, and then enter pairing mode. Refer to the instruction manual of your Bluetooth component for details.
- ④ Press and hold **BLUETOOTH ON** for more than 3 seconds to start pairing. “Searching...” appears when the pairing starts. While the Yamaha Bluetooth wireless audio receiver is in pairing mode, the DOCK indicator flashes in the front panel display.

Hint

To cancel the pairing, press **BLUETOOTH OFF**.

- ⑤ Check that the Bluetooth component detects the Yamaha Bluetooth wireless audio receiver. If the Bluetooth component detects the Yamaha Bluetooth wireless audio receiver, the audio receiver name (“YBA-10 YAMAHA” for example) appears in the device list of the Bluetooth component.
- ⑥ Select the Yamaha Bluetooth wireless audio receiver in the device list of the Bluetooth component, and then enter the pass key “0000” on the Bluetooth component. When the pairing procedure is successful, “Completed” appears in the front panel display.

Hints

- If the pairing is not completed within 8 minutes, “Not found” appears and the DOCK indicator is turned off in the front panel display.
- If the pairing is canceled during the pairing, “Canceled” appears in the front panel display.

Note

The Yamaha Bluetooth wireless audio receiver can be paired with up to eight Bluetooth components. When pairing is conducted successfully with a ninth component and the pairing data is registered, the pairing data for another least recently used component is deleted.

Establishing a connection

After the pairing is completed, perform the connecting operation on the system or on the Bluetooth component to enable communication between them. The connecting operation on the system is only available for the most recently connected Bluetooth component.

- ① Press **DOCK** to set the input to DOCK.
- ② Press **BLUETOOTH ON** to start a connection. “Searching...” appears in the front panel display. When the system finds the last connected Bluetooth component, “BT connected” appears in the front panel display for 3 seconds.

Hints

- If the system cannot find the last connected Bluetooth component, “Not found” appears in the front panel display.
- If you want to establish a connection with a Bluetooth component other than the one most recently connected to, connect from that Bluetooth component. Refer to the instruction manual of your Bluetooth component for details.

Disconnecting

Press **DOCK**, and then **BLUETOOTH OFF** to disconnect the system from the Bluetooth component. “Disconnected” appears in the front panel display.

Playing back the Bluetooth component

You can play back your Bluetooth component using the supplied remote control.

You can also play back your Bluetooth component by operating it directly.

Hint

Operation using the remote control is available only when the connection is established between the Bluetooth component you want to play back and the system.

USEFUL OPERATION

■ Adjusting the audio delay

FPD TV images sometimes lag behind the sound. You can use this function to delay the sound output to synchronize it with the video image.

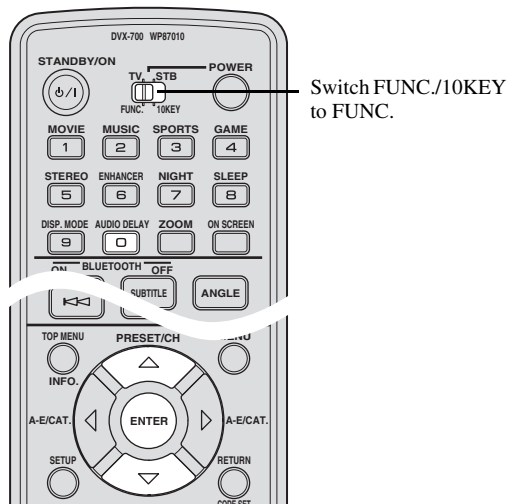

- ① Press **AUDIO DELAY** to enter adjusting mode.
- ② Press \triangle / ∇ to adjust the delay time.
Options: 0 to 240 ms
You can adjust the delay time by the 10 ms.

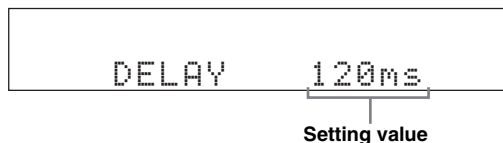

- ③ Press **AUDIO DELAY** again or **ENTER** to exit adjusting mode.

Hints

- The default setting is 0 ms and "DELAY OFF" appears in the front panel display.
- The system memorizes the settings assigned to each input source.

Notes

If you do not operate this function within 30 seconds after entering adjusting mode, the system automatically exits adjusting mode.

■ Listening at low volume (night listening mode)

Night listening mode enables you to listen to dialog or vocals more clearly at lower volume by suppressing louder sound effects. This function is useful when playing sources with wide dynamic range of the sound at night.

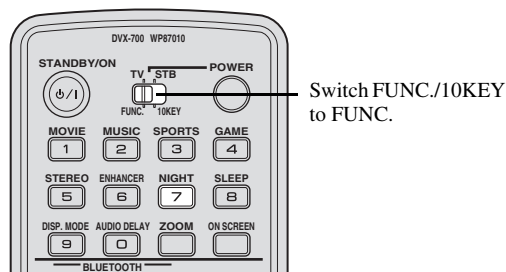

Press **NIGHT**.
"NIGHT ON" appears in the front panel display.
The NIGHT indicator lights up when night listening mode is selected.

Lights up

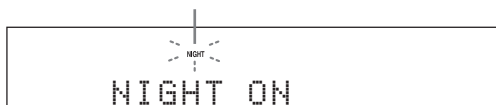

Hints

- To cancel night listening mode, press **NIGHT** again.
- When this function is on, compressed music enhancer mode is automatically set to off. (Page 45)
- The setting is set for all the input sources.

■ Adjusting the audio balance for the playback

You can adjust the volume balance of the virtual speakers and subwoofer.

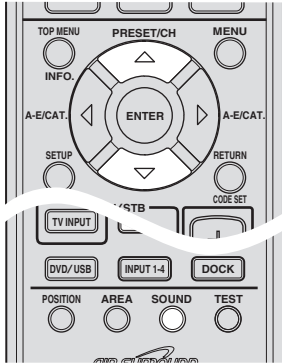

- ① Press **SOUND** repeatedly to select the item you want to adjust.

Each time you press **SOUND**, the item changes to subwoofer, center and surround.

SWFR

Adjusts the output level of the subwoofer channel.

CENTER

Adjusts the output level of the center virtual speaker channel.

SUR.

Adjusts the output level of the surround virtual speaker channels.

- ② Use \triangle / ∇ to adjust the volume balance. You can adjust the balance from +6 to -6.

Hints

- The volume balance setting for the virtual surround speaker is assigned to both left and right channels.
- You can also adjust the speaker volume while the test tone is output. (Page 45)
- The setting is set for all the input sources.

Note

You cannot check the volume balance of the center virtual speaker and surround virtual speaker when the surround mode is off. Set the surround mode to on to check the volume balance.

■ Changing the brightness of the front panel display

You can change the brightness of the front panel display. You can also turn off the front panel display to view a movie in a darker environment.

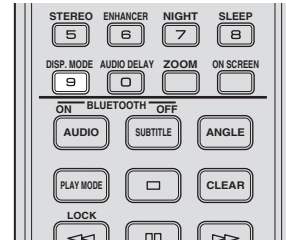

Press **DISP. MODE** repeatedly.

Each time you press **DISP. MODE**, the brightness of the front panel display changes.

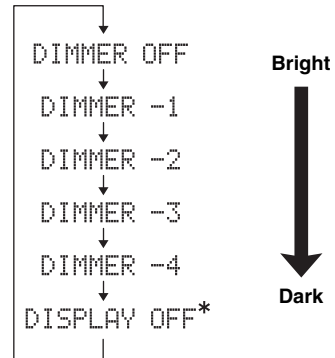

* Selecting "DISPLAY OFF" turns off the front panel display. Before it turns off, "DISPLAY OFF" appears briefly in the front panel display.

The front panel display lights up momentarily when any operation is performed while DISPLAY OFF is selected.

Hints

- The default setting is DIMMER OFF.
- Only the power indicator remains lit in DISPLAY OFF mode.

■ Setting the sleep timer

The sleep timer function sets the system to the standby mode automatically at the preset time.



Press **SLEEP** repeatedly until the desired turn-off time is displayed.

The preset time appears on the front panel display.

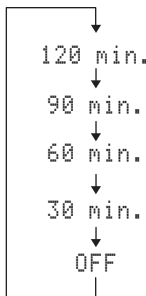
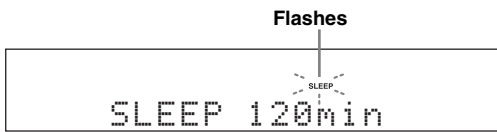

Select [OFF] to cancel the sleep timer.

■ System menu

This feature allows you to initialize the settings (such as DVD setting) or change the HDMI audio output settings by opening a specialized menu (system menu) for this purpose.

- ① Set the system to standby mode.
- ② Press and hold **INPUT** and **⏻** on the DVD controller, then press **STANDBY/ON**.
Keep holding **INPUT** and **⏻** until "SYSTEM MENU" appears in the front panel display.
The system menu appears on the front panel display.



- ③ Press **◀/▶** to select the item you want.

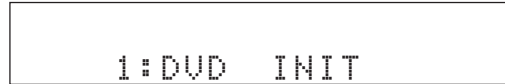

1: DVD INIT

Resets the settings for DVD settings to the initial factory settings.

2: HDMI INIT

Resets the settings for HDMI settings to the initial factory settings.

3: HDMI A ON

Select if the audio signal is output from the HDMI terminal. Select [ON] to output the audio signal to HDMI components such as TV.

4: HDMI A OFF

Select if the audio signal is output from the HDMI terminal. Select [OFF] not to output the audio signal to HDMI components such as TV.

5: SIRIUS P.CLR

(U.S.A. and Canada models only)

Clears the parental lock code for the SiriusConnect tuner.

- ④ Press **ENTER** to confirm.
"*)" is displayed on the left side of the selected item in the front panel display.
Each time you press **ENTER**, set (asterisk "*)" appears) and cancel (asterisk "*)" disappears switches in sequence.
The settings will be activated the next time you turn on this unit. Press **STANDBY/ON** to set the system to the standby mode, then turn on the power again.

Hints

- If you select other items before the system is set to the standby mode, the item you confirmed is canceled.

- The next time you turn on the system after selecting an item between 1 and 4 in the system menu, the system starts with DVD as an input source.

■ Setting the preset code

You can use the remote control to control the power, TV input, channel, and volume for up to two components, such as TV or Set top box (STB). Set the preset codes depending on the components.

Hint

The preset cords are set to “298” (TV) and “748” (STB) as the default settings.

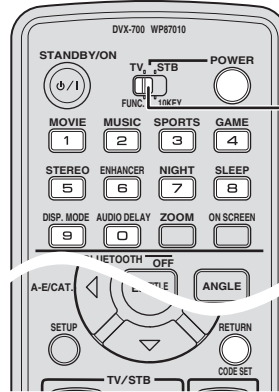

- ① Switch **TV/STB** to the side you want to set.
- ② Press and hold **CODE SET**, then press **POWER**.
- ③ Point the remote control toward the remote control sensor on the DVD controller and enter a 3-digit code while holding **CODE SET**.
Refer to “LIST OF PRESET CODES” on the appendix for the corresponding codes.
- ④ Release **CODE SET**.
If the preset cord is set correctly, “PRESET OK!” appears in the front panel display.

Note

If you have failed to set the preset code, “PRESET NG!” appears in the front panel display. Try to set it again.

Hints

- When you select the preset cord for “cable” or “DBS”, you can use only **POWER** and **CH +/-**. If a preset cord for “TV” is set on the other side, you can use **TV VOL +/-** or **TV INPUT** to control TV.
- To set another preset code, switch **TV/STB** to the other side and repeat the step 2 to step 4.

Operating a TV/STB

Once you set the preset code, you can operate your TV/STB.

- ① Switch **TV/STB** to the side, which the preset code is set.
- ② Press the button you want to operate.

TROUBLESHOOTING

If there is any problem with your unit, check the following items. If you cannot solve your problem with the following remedies or if your problem is not listed below, turn off the system and unplug the unit, then consult the nearest authorized Yamaha dealer or service center.

General

Problem	Cause	Remedy	See page
Power turns on but immediately shuts off.	The power cable may be connected improperly.	Make sure the power cable is plugged into the outlet firmly.	20
	A speaker cable may be shorted.	Make sure all speaker cables are connected properly.	14
	This system may have received a strong electrical shock, such as from a lightning bolt or excessive static electricity.	Set this system to standby mode, and then disconnect the power cable. Wait for about 30 seconds, connect the power cable, and then turn the system on again.	20, 22
The speakers make no sound.	The volume may be set to minimum level.	Adjust the volume level.	5, 10
	The mute function may be activated.	Cancel the mute function.	10
	The input source or input setting may be incorrect.	Select the correct input source or input setting.	5, 10
	The cables may be connected improperly.	Make sure all cables are connected properly.	14
Sound is too low on one side.	The cables may be connected improperly.	Make sure all cables are connected properly.	14
Speaker channels other than the front ones make no sound.	You may be listening to stereo sounds without surround mode.	Press a surround mode button to enable the sound field effect.	43
The virtual speaker channel makes no sound.	The volume of the center virtual speaker channel may be set to minimum level.	Adjust the volume level of the center virtual speaker channel.	64
	The volume of the surround virtual speaker channels may be set to minimum level.	Adjust the volume level of the surround virtual speaker channels.	64
The subwoofer makes no sound.	The volume of the subwoofer channel may be set to minimum level.	Adjust the volume level of the subwoofer.	64
Sound is poor (noisy).	A speaker cable may be shorted.	Make sure all cables are connected properly.	14
This system does not operate properly.	This system may receive a strong electrical shock, such as from a lightning bolt or excessive static electricity, or drop in power supply.	Set this system to standby mode, and then disconnect the power cable. Wait for about 30 seconds, connect the power cable, and then turn on this system.	20, 22
	The system control cable may be connected improperly.	Connect the system control cable firmly.	14
A digital or high-frequency equipment produces noises.	The system may be placed close to digital equipment or high-frequency equipment.	Place this system farther away from such equipment.	--
The remote control does not operate the system.	The system may be outside the remote control operation range.	For information on the remote control operation range, refer to "Using the remote control".	21
	The remote control sensor of this system may be exposed to direct sunlight or lighting.	Change the lighting.	--
	The batteries may be worn out.	Replace the batteries.	21

Problem	Cause	Remedy	See page
The picture is not displayed on the TV screen.	The TV cables may be connected improperly.	Make sure all cables are connected properly.	17
	If the COMPONENT VIDEO OUTPUT and HDMI connections are used simultaneously, the COMPONENT VIDEO OUTPUT jacks may output progressive video signal regardless of the Component Out setting.	Disconnect the HDMI component, or connect a TV that supports progressive video to the COMPONENT VIDEO OUTPUT jacks.	18
The picture is not displayed on the TV screen correctly.	The Video Output settings may be incorrect.	Check the Video Output settings and correct as necessary.	38
	The Component Out setting is set to Progressive, but the TV connected to the COMPONENT VIDEO OUTPUT may not support progressive scanning.	Change the Component Out setting to Interlace.	38
	The TV connected to the HDMI OUTPUT terminal may not support the selected resolution.	Change the HDMI Resolution setting to a resolution supported by the HDMI TV.	38
The message “HDMI ERROR” is displayed or the picture is not displayed on the HDMI TV screen.	The wrong HDMI resolution may be selected or an HDMI error may have occurred.	Check the HDMI Resolution setting and correct as necessary.	38
		Reset the HDMI settings.	65

Tuner (FM)

Problem	Cause	Remedy	See page
FM stereo reception is noisy.	The characteristics of FM stereo broadcasts may cause this problem when the transmitter is too far away, or if the antenna quality is poor.	Check the antenna connections.	18
		Try using a high-quality directional FM antenna.	--
		Use the manual tuning method.	46
There is distortion, and clear reception cannot be obtained, even with a good FM antenna.	There is multi-path interference.	Adjust the antenna position to eliminate multi-path interference.	--
The desired station cannot be tuned into with the automatic tuning method.	The signal is too weak.	Use a high-quality directional FM antenna.	--
		Use the manual tuning method.	46

XM Satellite Radio

If an operation takes longer than usual or an error occurs, one of the following messages may appear in the front panel display. In this case, read the causes and follow the corresponding remedies.

Status message	Cause	Remedy	See page
CHECK XM TUNER	The XM Mini-Tuner is not installed in the XM Mini-Tuner Home Dock or the XM Mini-Tuner Home Dock is not connected to this unit.	Confirm the XM Mini-Tuner is fully seated in the dock and check that the XM Mini-Tuner Home Dock cable is connected to this unit.	50
CHECK ANTENNA	The XM antenna is not connected to the XM Mini-Tuner Home Dock or the XM antenna cable has become damaged.	Check that the XM antenna is securely connected to the XM Mini-Tuner Home Dock and check the antenna cable for damage. Replace the XM antenna if the cable is damaged.	50

Status message	Cause	Remedy	See page
LOADING	The XM Mini-Tuner is acquiring audio or program information from the XM satellite signal. This message can also occur in weak XM signal conditions. Note that this unit may not respond to some operations while this message is displayed.	This message should disappear in a few seconds in good signal conditions. If you see this message often, reposition the XM antenna to get better signal reception. Use the "ANTENNA INFO" information in the front panel display or "XM Information" screen in the video monitor to check the antenna reception level.	53
NO SIGNAL	The XM Mini-Tuner is not receiving the XM satellite signal. Something may be blocking the XM antenna view of the satellites or the antenna is not properly aimed.	Check for antenna obstructions and reposition the XM antenna to get better signal reception. Use the "ANTENNA INFO" information in the front panel display or "XM Information" screen in the video monitor to check the antenna reception level. See instructions supplied with the XM Mini-Tuner and Dock for antenna installation information.	53
OFF AIR	The XM channel you selected is not currently broadcasting.	Check back at a later time; in the mean time, select another channel.	--
CH UNAUTH	You may be attempting to tune to an XM channel that is blocked or that you cannot receive with your XM subscription package.	Consult the latest channel guide at http://www.xmradio.com/ (US residents) and http://www.xmradio.ca/ (Canadian residents) for the current list of channels. For information on receiving this channel, visit http://www.xmradio.com/ (US residents) and http://www.xmradio.ca/ (Canadian residents) or contact XM Satellite Radio at 1-800-967-2346 (US residents) and 1-877-438-9677 (Canadian residents).	--
CH UNAVAIL	The selected channel is not available. The channel may have been reassigned to a different channel number. This message may occur initially with a new XM Mini-Tuner that has not received XM signal for an extended period.	Consult the latest channel guide at http://www.xmradio.com/ (US residents) and http://www.xmradio.ca/ (Canadian residents) for the current list of channels. For the case of a new XM Mini-Tuner that has not received XM signal for an extended period, allow the XM Mini-Tuner to receive the XM satellite signal for at least 5 minutes and then try to select the channel again.	--
----	No artist name or song title is available for this selection.	No action required.	--
UPGRADE XM TUNER	This unit does not support the connected XM Mini-Tuner.	Connect a XM Mini-Tuner that is compatible with XM Rev 4x.	--

SIRIUS Satellite Radio

If an operation takes longer than usual or an error occurs, one of the following messages may appear in the front panel display. In this case, read the causes and follow the corresponding remedies.

Status message	Cause	Remedy	See page
ANTENNA ERROR	The antenna is not connected to the SiriusConnect tuner properly.	Check the connection of the antenna and SiriusConnect tuner.	54

Status message	Cause	Remedy	See page
CHECK SR TUNER	The SiriusConnect tuner is not connected to the SIRIUS terminal of this unit correctly.	Check the connection of the SiriusConnect tuner and this unit.	54
	The SiriusConnect tuner is not connected to the AC wall outlet.	Connect the power cable of the SiriusConnect tuner to the AC wall outlet.	54
NOT SUPPORTED	This unit does not support the connected SIRIUS Satellite Radio tuner.	Connect the SiriusConnect tuner that is compatible with this unit.	--
ACQUIRING	The signal is too weak.	Adjust the orientation of the antenna of the SiriusConnect tuner. Use the "ANTENNA INFO" information in the front panel display or "SIRIUS Information" screen in the video monitor to check the antenna reception level.	59
UPDATING	The SiriusConnect tuner is updating the channel list.	Wait until the updating is completed.	--
	The period of the subscription is end.	Contact SIRIUS Satellite Radio to renew the subscription.	--
F/W UPDATING	The SiriusConnect tuner is updating the firmware.	Wait until the updating is completed.	--
CALL SIRIUS (CALL 888-539-SIRIUS TO SUBSCRIBE)	The selected channel is not subscribed.	Contact SIRIUS Satellite Radio to subscribe the selected channel. URL: https://activate.siriusradio.com/ Phone: 1-888-539-SIRIUS (1-888-539-7474)	--
		Select another channel.	--
SUB UPDATED	The subscription information is updated.	--	--
INVALID	The selected channel is currently out of service.	Select another channel.	--
Not Available	The operation you made is not available.	--	--

iPod

Status message	Cause	Remedy	See page
Unknown iPod	The iPod being used is not supported by this system.	Only iPod (Click and Wheel), iPod touch, iPod nano, and iPod mini are supported.	--
iPod connected	Your iPod is properly stationed in the Yamaha iPod universal dock (such as YDS-10 or YDS-11, sold separately) connected to the DOCK terminal of this system, and the connection between your iPod and this system is completed.	--	--
Disconnected	Your iPod was removed from the Yamaha iPod universal dock (such as YDS-10 or YDS-11, sold separately) connected to the DOCK terminal of this system.	Station your iPod back in the Yamaha iPod universal dock (YDS-10 or YDS-11, sold separately) connected to the DOCK terminal of this system.	20

Note

In case of a transmission error without a status message appearing in the front panel, check the connection to your iPod.

Bluetooth

Status message	Cause	Remedy	See page
Searching...	The Yamaha Bluetooth wireless audio receiver (such as YBA-10, sold separately) and the Bluetooth component are in the process of the pairing.	--	--
	The Yamaha Bluetooth wireless audio receiver and the Bluetooth component are in the process of establishing the connection.	--	--
Completed	The pairing is completed.	--	--
Canceled	The pairing is canceled.	--	--
Not found	The system cannot find the Bluetooth component while performing the pairing or trying to connect to the Bluetooth component.	--	--
BT connected	The connection between the Yamaha Bluetooth wireless audio receiver and the Bluetooth component is established.	--	--
Disconnected	The Bluetooth component is disconnected from the Yamaha Bluetooth wireless audio receiver.	--	--
Not Available	The pairing is performed when the Yamaha Bluetooth wireless audio receiver is connected to the Bluetooth component.	Perform the pairing when the Yamaha Bluetooth wireless audio receiver is not connected to the Bluetooth component.	61

Note

In case of a transmission error without a status message appearing in the front panel, check your Bluetooth component.

Disc

Problem	Cause	Remedy	See page
Some functions do not work.	Not all discs support all of the disc playback functions of this unit.	Try another disc.	2
Playback does not start, the sound or picture is distorted or playback is stopped halfway.	The disc is not properly set.	Place the disc, label-side up.	26
	The disc is dirty.	Check the disc and clean as necessary.	2
	The loaded disc is not supported.	Use only supported disc formats. The Disc that is not compliant with the CD Audio specification (e.g. copy control CD, the non-DVD side of the DualDisc, etc.) may not play.	2
	Condensation on the pickup lens. When this system is moved from a cold environment to a warm one, condensation may form on the pickup lens.	Wait for one to two hours for the condensation to evaporate, then try again.	--
After loading a DVD-Video, the same picture is usually displayed and you cannot move to the main contents or the main menu.	The Resume/Last memory function is effective.	Press <input type="checkbox"/> twice to set the Resume function to off.	29
		Reset the DVD setting to the initial factory settings (DVD INIT) to clear the resume point.	65

Problem	Cause	Remedy	See page
Cannot select foreign language soundtracks or subtitles.	The loaded disc does not contain foreign language soundtracks or subtitles.	See the disc packaging for details on foreign language soundtracks and subtitles.	--
	The loaded disc does not allow this operation.	Select foreign language soundtracks or subtitles in the disc menu.	28
Subtitles are not displayed.	Subtitles are turned off.	Select a subtitle.	29
	The loaded disc does not contain subtitles.	See the disc packaging for details on subtitles.	--
	When using A-B repeat playback, subtitles outside of the specified section may not be displayed.	Turn off A-B repeat playback.	30
Cannot select camera angles.	The loaded disc does not contain multiple camera angles.	See the disc packaging for details on multiple camera angles.	--
Cannot play some files.	Only MP3, WMA, MPEG-4 AAC, and JPEG files with no copy protection (DRM) can be played.	Use files with no copy protection.	--
	The file is not supported.	Use only supported file format.	26, 27, 33
Cannot record a DVD.	The DVD is copy protected.	Most DVD-Video discs are copy protected and cannot be recorded.	--
The TV picture is disturbed.	The picture may be disturbed while rewinding or fast forwarding.	This is not a malfunction.	--
The picture is stretched or black bars are displayed.	The TV Screen setting is set incorrectly.	Check the TV Screen setting and change as necessary.	38
Ghosting appears in some areas of the picture.	The video material is incompatible with the Progressive Scanning function due to the way in which it was edited or the type of material it is.	Change the Component Out setting to Interlace.	38
The disc ejected as soon as it was loaded.	The loaded disc is not supported.	Use only supported disc formats.	2
The message "No Disc" is displayed even though a disc is loaded.	The disc is not properly inserted into the disc slot.	Insert the disc, label-side up into the disc slot.	26
Cannot display the DVD setup menu, Initial Settings, and Video Adjust menus.	These menus can be displayed only when DVD as the input source is selected.	Select DVD as the input source.	5, 9

USB

Problem	Cause	Remedy	See page
Cannot play content stored on a USB mass storage device.	Not all USB storage devices are recognized by this unit.	Try another USB storage device.	--
	Only USB storage devices formatted with FAT16 or FAT32 are supported.	Reformat the USB storage device with FAT16 or FAT32.	--
	The USB storage device is connected to a USB hub, but this unit does not support USB hubs.	Connect the USB storage device directly to the USB port of this unit.	35
Cannot play some files.	Only MP3, WMA, MPEG-4 AAC, and JPEG files with no copy protection (DRM) can be played.	Use files with no copy protection.	--
	The file is not supported.	Use only supported file format.	33

Problem	Cause	Remedy	See page
The message “NO USB” or “USB ERROR” is displayed.	The USB device is not compatible, or this unit cannot supply enough power to the device for it to function properly.	Turn this unit off and on again.	22
		Set this unit to standby, disconnect the USB storage device, and then reconnect it.	22, 35
		Select the USB input source, and then connect the USB device.	35
		Select a different input source and select USB again.	35
		If the USB storage device came with its own power adapter, use it to power the USB storage device while connecting to this unit.	--
		If the message still appears, the USB storage device is probably incompatible with this unit.	--

GLOSSARY

AAC (Advanced Audio Coding)

An audio compression scheme defined as part of the MPEG-2/MPEG-4 standard. AAC supports up to 48 channels and generally achieves better sound quality than MP3 at the same bit rate.

Analog

Sound that has not been turned into numbers. Analog sound varies, while digital sound has specific numerical values. These terminals send audio through two channels, the left and right.

Aspect ratio

The ratio of vertical and horizontal sizes of a displayed image. The horizontal vs. vertical ratio of conventional TVs. is 4:3, and that of wide-screens is 16:9.

Bit

Short for binary digit. Represents the smallest unit of information manipulated on a computer. In audio systems, the bit size determines resolution to digitize analog signals.

The larger the bit size, the larger the dynamic range (the ratio of maximum and minimum frequency level) and the finer the sounds. Generally, an audio CD is 16 bit and DVD audio is 24 bit.

Bit rate

The amount of data used to hold a given length of music; measured in kilobits per second, or kbps. Also, the speed at which you record. Generally, the higher the bit rate, or recording speed, the better the sound quality. However, higher bit rates use more space on a disc.

Component Video

Terminals for inputting or outputting a component video signal. Component video signal consists of three lines, the luminance signal (Y) and two color difference signals (PB/CB, PR/CR), which enable to provide high-quality video.

Disc menu

A screen display prepared for allowing selection of images, sounds, subtitles, multi-angles, etc. recorded on a DVD.

DivX®

DivX® is a popular media technology created by DivX, Inc. DivX® media files contain highly compressed video with high visual quality that maintains a relatively small file size. DivX® files can also include advanced media features like menus, subtitles, and alternate audio tracks. Many DivX® media files are available for download online, and you can create your own using your personal content and easy-to-use tools from DivX.com.

DivX® Ultra

DivX® Ultra Certified products provide enhanced playback of advanced media features supported by the DivX® Media Format. Key features include interactive video menus, subtitles, alternate audio tracks, video tags, and chapter points.

DMF (DivX® Media Format)

The DivX® Media Format supports advanced media features, adding controls for an interactive media experience: interactive video menus, chapter points, multi-language subtitles, and alternate audio tracks.

Dolby Digital

Digital surround sound system which is developed by Dolby Laboratories provides completely independent multi-channel audio. With 3 front channels (left, center, and right) and 2 surround stereo channels, Dolby Digital provides five full-range audio channels. With an additional channel especially for bass effects (called LFE, or low frequency effect), the system has a total of 5.1-channels (LFE is counted as 0.1 channel). By using 2-channel stereo for the surround speakers, more accurate moving sound effects and surround sound environment are possible than with Dolby Surround.

Dolby Pro Logic II

It is an improved matrix decoding technology that provides better spatiality and directionality on Dolby Surround programmed material; provides a convincing three-dimensional soundfield on conventional stereo music recordings; and is ideally suited to bring the surround experience to automotive sound. While conventional surround programming is fully compatible with Dolby Pro Logic II decoders, soundtracks will be able to be encoded specifically to take full advantage of Pro Logic II playback, including separate left and right surround channels. (Such material is also compatible with conventional Pro Logic decoders).

DTS (Digital Theater Systems)

Digital surround sound system developed by Digital Theater Systems, Inc., which provides 5.1 channel audio (max). With an abundance of audio data, it is able to provide authentic-sounding effects.

HDMI

HDMI (High-Definition Multimedia Interface) is the first industry-supported, uncompressed, all-digital audio/video interface. Providing an interface between any source (such as a set-top box or AV controller) and an audio/video monitor (such as a digital television), HDMI supports standard, enhanced or high-definition video as well as multi-channel digital audio using a single cable. HDMI transmits all ATSC (Advanced Television Systems Committee) HDTV standards and supports 8-channel digital audio, with bandwidth to spare to accommodate future enhancements and requirements.

When used in combination with HDCP (High-bandwidth Digital Content Protection), HDMI provides a secure audio/video interface that meets the security requirements of content providers and system operators. For further information on HDMI, visit the HDMI website at "www.hdmi.org/".

Interlace

The most common type of scanning used in televisions. It divides a screen into even and odd numbered fields for scanning, and then builds an image by combining them into one image (frame).

JPEG (Joint Photographic Experts Group)

A standardized image compression system proposed by the Joint Photographic Experts Group. It can reduce image data sizes to 1 to 10% of their original sizes, and works on digital photographs effectively.

MP3 (MPEG Audio Layer-3)

An audio file compression technology. It can reduce audio data sizes to about 10% of their original sizes while maintaining CD-level audio quality.

MPEG (Moving Pictures Experts Group)

International standard for digital video and audio compression generated by ISO (International Organization for Standardization) and IEC (International Electrotechnical Commission). Includes MPEG-1, MPEG-2, and MPEG-4. MPEG-1 offers VHS level video quality and is often used on video CDs. MPEG-2 offers S-VHS level video quality and is often used on DVDs.

Parental lock

(On DVD) Limits Disc play according to the age of the users or the limitation level in each country. The limitation varies from disc to disc; when it is activated, playback will be prohibited if the software's level is higher than the user-set level.

(On Sirius Satellite Radio) Limits the channel (channel skip) to protect children from inappropriate contents. The limitation is set by channel basis.

Playback control (PBC)

An on-screen menu recorded on a Video CD or Super Video CD that enables interactive playback and searching.

Progressive Scan

A method of displaying all scanning lines in a frame at once, reducing flicker noticeable on a larger screen and creating a sharp and smooth image.

Region code

Many DVD discs include a region code so that the copyright owner can control DVD software distribution only to regions where they are ready to distribute. There are six regions codes, which restrict a DVD player to playing a DVD disc with the same region code.

Surround

A controller for creating realistic three-dimensional sound fields full of realism by arranging multiple speakers around the listener.

VR format (Video Recording format)

A DVD video recording format, which allows editing DVD video data recorded onto a disc. You need a VR format compatible player for playback.

SPECIFICATIONS

DVR-700

Input	
Others	USB: 1
Output	
Video	Composite: 1
	Component: 1
	HDMI: 1
Others	System Connector: 1
Dimensions (W x H x D).....	360 x 68 x 224 mm
Weight	2.6 kg

NS-P700

Woofer.....	5.5 cm cone woofer x 2,
	Magnetic shielding type
Tweeter.....	2.5 cm Balanced dome tweeter,
	Magnetic shielding type
Input Power (Nominal/Maximum).....	40 W/100 W
Frequency Response.....	130 Hz – 20 kHz (-10 dB)
Dimensions (W x H x D)	
Excluding stands	95 x 190 x 98 mm
Including stands/Upright position.....	95 x 206 x 106 mm
Including stands/Horizontal position	190 x 111 x 106 mm
Weight	1.2 kg (Excluding stands)

NS-PSW700

Type.....	Bass reflex type
	16.5 cm cone, Magnetic shielding type
Frequency Response.....	35 Hz – 130 Hz (-10 dB)
Dimensions (W x H x D).....	194 x 450 x 400 mm
Weight	13 kg
Power Supply	
[U.S.A. and Canada models].....	AC 120 V, 60 Hz
[Asia, Europe, Russia models]	AC 230 V, 50 Hz
[Taiwan model]	AC 110 V, 60 Hz
[Australia model]	AC 240 V, 50 Hz
Power Consumption	50 W
Standby Power Consumption (reference data).....	Less than 1 W
INPUT	
Analog Audio.....	Pin Jack: 1 (AUX)
Digital Audio.....	Coaxial: 1
	Optical: 2
	DOCK: 1
	(YDS-10, YDS-11, YBA-10)
	FM Antenna terminal: 1
	XM Tuner: 1 (U.S.A., and Canada model only)
	Sirius Tuner: 1 (U.S.A., and Canada model only)
OUTPUT	
Analog Audio.....	SPEAKER OUT
Others	System Connector: 1

Amplifier Section

Maximum Power	
SP OUT.....	70 W [6 Ω, 1 kHz, 10 %THD]
Subwoofer	70 W [6 Ω, 100 Hz, 10 %THD]
Minimum RMS Output Power	
SP OUT.....	55 W [6 Ω, 1 kHz, 1 %THD]
Subwoofer	55 W [6 Ω, 100 Hz, 1 %THD]
Input Sensitivity/Input Impedance	
AUX.....	350 mV/32 kΩ
Maximum Input Signal	
AUX.....	≥ 2.2 V [1 kHz, DSP=Thru]
Frequency Response	
SP OUT.....	-2.0 ± 1 dB [20 Hz]
	0 dB [1 kHz]
	-0.5 ± 1 dB [20 kHz]
S / N Ratio	
SP OUT.....	≥ 82 dB [1 kHz, 18.5 V/6 Ω, Analog]
SP OUT.....	≥ 98 dB [1 kHz, 18.5 V/6 Ω, Digital]
	[IHF-A Network]

Total Harmonic Distortion	
SP OUT.....	≤ 0.06 % [1 kHz, Analog, Digital 20 kHz-LPF]
Residual Noise	SP OUT: ≤ 138 uV

DVD Section

Video Output	Composite: 1 Vp-p (75 Ω)
Y Output/Component Video Output	Component: 1 Vp-p (75 Ω)
PB Output/Component Video Output.....	Component: 0.7 Vp-p (75 Ω)
PR Output/Component Video Output.....	Component: 0.7 Vp-p (75 Ω)

Tuner Section

FM Tuning Range	
[U.S.A. and Canada models].....	87.5 to 107.9 MHz
[Other models]	87.50 to 108.00 MHz
Radio Data System Function (Europe and Russian model only)	

Other Section

SOUND FIELD.....	MOVIE, MUSIC, SPORTS, GAME
Surround mode	
Night listening mode	
Extended stereo	
Compressed music enhancer	
VIRTUAL SURROUND PROCESSOR	AIR SURROUND XTREME
AUDIO DECODE.....	Dolby Digital / Dolby Pro Logic II / DTS
Speakers distance mode	Wide / Normal /Narrow

Specifications are subject to change without prior notice.

INDEX

■ A

A-B repeat playback	30
AIR SURROUND XTREME	43
Angle Indicator, Display menu	41
angle selection	29
ANGLE, remote control	10
ANTENNA terminal, subwoofer/system control rear panel	8
AREA, remote control	10
AUDIO DELAY, remote control	9
audio file playback	33
Audio language	25
Audio Language, Language menu	40
AUDIO, remote control	10
AUTO indicator, front panel display	7
Automatic station preset, FM	47

■ B

battery insertion, remote control	21
Bluetooth component listening	61
brightness of front panel display	64
Brightness, Video Adjust menu	37

■ C

CH, remote control	10
Chroma Level, Video Adjust menu	37
CLEAR, remote control	10
CODE SET, remote control	10
Component Out, Video Output menu	38
COMPONENT VIDEO OUTPUT jacks, DVD controller rear panel	6
compressed music enhancer	45
connecting DVD controller	16
connecting external AV component	19
connecting FM antenna	18
connecting HDMI component	18
connecting power cable	20
connecting speakers	14
connecting TV	17
connection	14
Contrast, Video Adjust menu	37
Country Code, Parental Lock	42

■ D

Decoder indicator, front panel display ...	7
Direct frequency tuning, FM	47
disc ejection	28
disc information displaying	29
Disc loading slot, front panel	5
disc menu	28
Disc menu language	25
disc navigator	32
disc playback	26
DISP. MODE, remote control	9
Display, Initial Setting menu	41
displaying disc information	29
distance between speakers setting	44
DivX video playback	26
DivX VOD, Options menu	42

DOCK indicator, front panel display	7
DOCK terminal, subwoofer/system control rear panel	8
DOCK, remote control	10
DVD controller connection	16
DVD Menu Lang., Language menu	40
DVD setup menu	36
DVD/USB, remote control	10

■ E

EJECT, front panel	5
ejecting disc	28
ENHANCER indicator	7
ENHANCER, remote control	9
ENTER, remote control	10
extended stereo mode	45
external AV component connection	19

■ F

FM antenna connection	18
FM listening	46
FM tuning operation	46
front panel display brightness	64
Front panel display, DVD controller	7
Front panel display, front panel	5
Front panel, DVD controller	5
FUNC./10KEY, remote control	9

■ G

GAME, AIR SURROUND XTREME	43
GAME, remote control	9
Gamma, Video Adjust menu	37

■ H

HDMI Color, Video Output menu	39
HDMI component connection	18
HDMI OUTPUT terminal, DVD controller rear panel	6
HDMI Resolution, Video Output menu	39
Hue, Video Adjust menu	37

■ I

Initial Setting menu	38
initialization	65
INPUT 1 OPTICAL jack, subwoofer/ system control rear panel	8
INPUT 2 OPTICAL jack, subwoofer/ system control rear panel	8
INPUT 3 COAXIAL jack, subwoofer/ system control rear panel	8
INPUT 4 ANALOG jacks, subwoofer/ system control rear panel	8
Input selection buttons, remote control	10
INPUT, front panel	5
INPUT, remote control	10
inserting batteries, remote control	21
iPod content playback	60

■ J

JPEG file slide show	34
----------------------------	----

■ L

language preference setting	25
Language, Initial Setting menu	40
Level Change, Parental Lock	42
Lights up when compressed	7
listening area shifting	44

■ M

Manual station preset, FM	48
Manual tuning, FM	46
MEMORY indicator, front panel display	7
menu browse mode, iPod	61
MENU, remote control	10
MOVIE, AIR SURROUND XTREME	43
MOVIE, remote control	9
MUSIC, AIR SURROUND XTREME	43
MUSIC, remote control	9
MUTE, remote control	10

■ N

NIGHT indicator, front panel display ...	7
NIGHT, remote control	9
Numeric keypad, remote control	9

■ O

ON SCREEN, remote control	9
On-screen display language	25
Options, Initial Setting menu	41
OSD language	25
OSD Language, Display menu	41

■ P

pairing to Bluetooth component	62
Parental Lock, Options menu	41
Password, Parental Lock	41
PBC	28
placing speakers	12
PLAY MODE, remote control	10
playable disc	2
playback control	28
playback controls	27
playing back audio file	33
playing disc	26
playing DivX video	26
playing WMV file	26
POSITION, remote control	10
power cable connection	20
Power cable, subwoofer/system control rear panel	8
Power indicator, front panel	5
POWER, remote control	9
preset code, remote control	66
preset station, FM	47
program playback	31

■ R

random playback	30
Rear panel, subwoofer/system control ...	8
Recalling preset station, FM	49
Remote control	9
Remote control sensor, front panel	5
remote control using	21
repeat playback	30
resuming playback	29
RETURN, remote control	10

■ S

search mode	31
SETUP, remote control	10
Sharpness, Video Adjust menu	37
shifting listening area	44
simple remote mode, iPod	60
SLEEP indicator, front panel display	7
sleep timer	65
SLEEP, remote control	9
slide show of JPEG file	34
SOUND, remote control	10
soundtrack language changing	28
speaker connection	14
speaker layout	11
speaker placement	12
SPEAKER terminals, subwoofer/system control rear panel	8
SPORTS, AIR SURROUND XTREME	43
SPORTS, remote control	9
STANDBY/ON, front panel	5
STANDBY/ON, remote control	9
station preset, FM	47
STEREO indicator, front panel display	7
STEREO, remote control	9
Subtitle Display, Language menu	40
Subtitle language	25
subtitle language changing	29
Subtitle Language, Language menu	40
SUBTITLE, remote control	10
supplied accessory	4
SYSTEM CONNECTOR terminal, DVD controller rear panel	6
SYSTEM CONNECTOR terminal, subwoofer/system control rear panel	8
system menu	65

■ T

TEST, remote control	10
TUNED indicator, front panel display ...	7
TUNER, remote control	10
tuning operation, FM	46
Turning on	22
TV connection	17
TV display setting	23
TV INPUT, remote control	10
TV Screen, Video Output menu	38
TV VOL, remote control	10

■ U

USB device using	35
------------------------	----

USB terminal, front panel	5
---------------------------------	---

■ V

Video Adjust menu	37
video input/output setting	23
VIDEO OUTPUT jack, DVD controller rear panel	6
Video Output, Initial Setting menu	38
virtual surround effect checking	45
VOLUME, front panel	5
VOLUME, remote control	10

■ W

WMV file playback	26
-------------------------	----

■ Z

ZOOM, remote control	9
zooming in	29

LIST OF PRESET CODES LISTE DES CODES PRÉDÉFINIS

TV

Brand name	Preset code
Yamaha	299, 292, 242, 285, 287, 253, 206
Admiral	292, 293, 216
Aiwa	294, 276, 283, 284
Akai	295, 296
Alba	296
AOC	297
Bell & Howell	292
Bester	298
Blaupunkt	229, 222
Blue sky	298
Brandt	223
Broscronic	297
Bush	296
By Design	201, 202
Clatronic	298
Craig	224
Croslex	225, 298
Curtis Mathis	297, 226
Daewoo	297, 298, 224, 227, 228, 215, 289
Daytron	239
Dual	298
Dwin	293, 281
Electrograph	289
Emerson	297, 224, 239, 232
Ferguson	223, 265, 266
First line	298
Fisher	295, 233
Fraba	298
Fujitsu	290
Funai	277, 278
Gateway	215, 289
GE	293, 297, 234, 235, 236
Goodmans	296, 298, 223
Grundig	229, 238, 249
Hitachi	297, 239, 242, 243, 285, 206
ICE	296
Irradio	296
Itt/Nokia	244, 245
JC Penny	293, 297, 234, 237, 240
JVC	296, 246, 247, 286
Kendo	298
KTV	297, 239
LG/Goldstar	297, 298, 239, 237, 240
Loewe	298, 248, 207
LXI	293, 297, 225, 226, 233, 298
Magnavox	297, 225, 239, 298
Marantz	298, 210
Matsui	295
Medion	203, 204, 298
Memorex	297, 216

Brand name	Preset code
Mitsubishi	299, 297, 259, 287
Nad	226, 255
NEC	297, 252, 282
Nokia	244, 245
Nokia Oceanic	245
Nordmende	265, 266
Onwa	296
Panasonic	234, 235, 236, 253, 288
Philco	297, 225, 239, 298
Philips	225, 205, 298
Pioneer	226, 235, 254, 255
Portland	297, 256
Proscan	293, 221, 231, 241, 251
Proton	297, 250, 260, 270
Quasar	234, 235
Radio Shack	299, 293, 297
RCA	293, 297, 234, 256, 257, 258, 221
Runco	220, 230, 271
SABA	223, 269, 265, 266
Sampo	281, 297, 280
Samsung	297, 239, 248, 262, 275
Sanyo	295, 233, 279, 272, 273, 274, 212
Schneider	296
Scott	297
Sharp	292, 239, 232, 208
Siemens	229
Signature	216, 292
Sony	263, 214
Sylvania	297, 225, 298
Symphonic	217, 218, 219, 291
Tatung	215
Telefunken	269, 264, 265, 266
Thomson	223, 266
Toshiba	292, 226, 267
V	209, 211, 215, 289
Videch	297, 242
Viewsonic	209, 211, 289
VIZIO	209, 211, 213, 215, 268, 289
Wards	297, 239, 232, 216
Westinghouse	211
Yamaji	298
Zenith	216, 261, 271

CABLE

Brand name	Preset code
ABC	739, 752, 753, 755, 758, 759, 762
General Instrument	722, 786, 787, 788
Hamlin	723, 724, 725, 726, 727
Hitachi	722
Jerrold	722, 728, 729, 732, 733, 734, 735, 736, 737
Magnavox	738
Motorola	748, 728
Oak	739, 742, 743
Panasonic	744, 745, 746, 747, 783, 784
Philips	763, 764, 765, 766, 767, 768
Pioneer	748, 785, 747
Radio Shack	749
RCA	744, 792, 793
Scientific Atlanta	752, 753, 754, 789
Sony	756, 757
Tocom	755
Universal	769, 772, 773, 774, 775
Viewstar	764, 766, 776, 777, 778, 779, 782

LIST OF COUNTRY CODES LISTE DES CODES DE PAYS

DBS

Brand name	Preset code
Bell expressvu	822, 855
DirecTV	825, 832, 842, 843, 846, 848, 849, 856, 857, 858, 859, 862, 863, 864, 865, 866
Dish Network system	822, 854, 855
Dishpro	822, 854
Echostar	822, 854, 855
Expressvu	822
GE	837, 838, 839, 857, 858
General Instrument	823
Goi	822
Hitachi	824
Houston	822
HTS	822
Hughes	843, 844, 845, 846
JVC	822, 855
Magnavox	825
Panasonic	826, 829
Philips	825, 843, 844, 845, 846, 847, 848, 849, 822
Primestar	827
Proscan	837, 838, 839, 842
Radio Shack	828, 822
RCA	837, 838, 839, 842, 822
Samsung	852
SKY +	853
SKY HD	853
Sony	832, 835
Toshiba	833, 836
Uniden	825
Zenith	834

Country/region	Country code
Argentina	ar 0118
Australia	au 0121
Austria	at 0120
Belgium	be 0205
Brazil	br 0218
Britain	gb 0702
Canada	ca 0301
Chile	cl 0312
China	cn 0314
Denmark	dk 0411
Finland	fi 0609
France	fr 0618
Germany	de 0405
Hong Kong	hk 0811
India	in 0914
Indonesia	id 0904
Italy	es 0920
Japan	jp 1016
Korea	kr 1118
Malaysia	my 1325
Mexico	mx 1324
Netherlands	nl 1412
New Zealand	nz 1426
Norway	no 1415
Pakistan	pk 1611
Philippines	ph 1608
Portugal	pt 1620
Russia	ru 1821
Singapore	sg 1907
Spain	es 0519
Sweden	se 1905
Switzerland	ch 0308
Taiwan	tw 2023
Thailand	th 2008
U.S.A.	us 2119

LIST OF LANGUAGE CODES LISTE DE CODES DE LANGUES

Language	Lanruage code	Language	Lanruage code	Language	Lanruage code
Abkhazian	ab 0102	Italian	it 0920	Spanish	es 0519
Afar	aa 0101	Japanese	ja 1001	Sudanese	su 1921
Afrikaans	af 0106	Javanese	jw 1023	Swahili	sw 1923
Albanian	sq 1917	Kannada	kn 1114	Swedish	sv 1922
Amharic	am 0113	Kashmiri	ks 1119	Tagalog	tl 2012
Arabic	ar 0118	Kazakh	kk 1111	Tajik	tg 2007
Armenian	hy 0821	Kinyarwanda	rw 1823	Tamil	ta 2001
Assamese	as 0119	Kirghiz	ky 1125	Tatar	tt 2020
Aymara	ay 0125	Kirundi	rn 1814	Telugu	te 2005
Azerbaijani	az 0126	Korean	ko 1115	Thai	th 2008
Bashkir	ba 0201	Kurdish	ku 1121	Tibetan	bo 0215
Basque	eu 0521	Laotian	lo 1215	Tigrinya	ti 2009
Bengali	bn 0214	Latin	la 1201	Tonga	to 2015
Bhutani	dz 0426	Latvian	lv 1222	Tsonga	ts 2019
Bihari	bh 0208	Lingala	ln 1214	Turkish	tr 2018
Bislama	bi 0209	Lithuanian	lt 1220	Turkmen	tk 2011
Breton	br 0218	Macedonian	mk 1311	Twi	tw 2023
Bulgarian	bg 0207	Malagasy	mg 1307	Ukrainian	uk 2111
Burmese	my 1325	Malayalam	ml 1312	Urdu	ur 2118
Byelorussian	be 0205	Maori	mi 1309	Uzbek	uz 2126
Cambodian	km 1113	Marathi	mt 1320	Vietnamese	vi 2209
Catalan	ca 0301	Moldavian	mo 1315	Volapük	vo 2215
Chinese	zh 2608	Mongolian	mn 1314	Welsh	cy 0325
Corsican	co 0315	Nauru	na 1401	Wolof	wo 2315
Croatian	hr 0818	Nepali	ne 1405	Xhosa	xh 2408
Czech	cs 0319	Norwegian	no 1415	Yiddish	ji 1009
Danish	da 0401	Occitan	oc 1503	Yoruba	yo 2515
Dutch	nl 1412	Oriya	or 1518	Zulu	zu 2621
English	en 0514	Oromo	om 1513		
Esperanto	eo 0515	Panjabi	pa 1601		
Estonian	et 0520	Pashto, Pushto	ps 1619		
Faroese	fo 0615	Persian	fa 0601		
Fiji	fi 0609	Polish	pl 1612		
Finnish	fi 0609	Portuguese	pt 1620		
French	fr 0618	Quechua	qu 1721		
Frisian	fy 0625	Rhaeto-Romance	rm 1813		
Galician	gl 0712	Romanian	ro 1815		
Georgian	ka 1101	Russian	ru 1821		
German	de 0405	Samoan	sm 1913		
Greek	el 0512	Sangho	sg 1907		
Greenlandic	kl 1112	Sanskrit	sa 1901		
Guarani	gn 0714	Scots-Gaelic	gd 0704		
Gujarati	gu 0721	Serbian	sr 1918		
Hausa	ha 0801	Serbo-Croatian	sh 1908		
Hebrew	iw 0923	Sesotho	st 1920		
Hindi	hi 0809	Setswana	tn 2014		
Hungarian	hu 0821	Shona	sn 1914		
Icelandic	is 0919	Sindhi	sd 1904		
Indonesian	in 0914	Sinhalese	si 1909		
Interlingua	ia 0901	Siswati	ss 1919		
Interlingue	ie 0905	Slovak	sk 1911		
Inupiak	ik 0911	Slovenian	sl 1912		
Irish	ga 0701	Somali	so 1915		

LASER INFORMATION INFORMATION LASER

- The name plate is located on the rear panel of the DVD controller.
- La plaque signalétique se trouve sur le panneau arrière du lecteur de DVD.

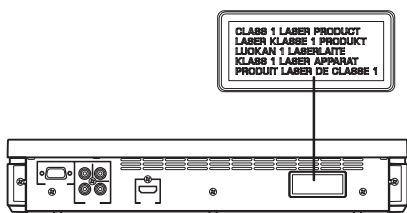

Without top cover
Sans couvercle supérieur

