



# *HTR-5750/HTR-5740*

---

*AV Receiver*

OWNER'S MANUAL

# IMPORTANT SAFETY INSTRUCTIONS

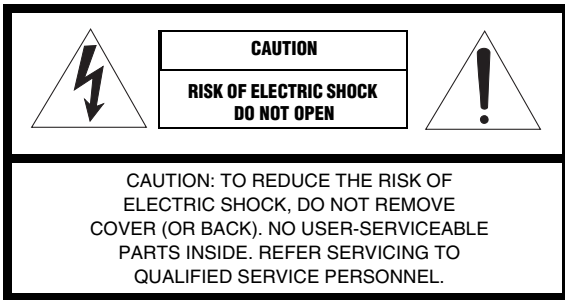

## • Explanation of Graphical Symbols



The lightning flash with arrowhead symbol, within an equilateral triangle, is intended to alert you to the presence of uninsulated “dangerous voltage” within the product’s enclosure that may be of sufficient magnitude to constitute a risk of electric shock to persons.



The exclamation point within an equilateral triangle is intended to alert you to the presence of important operating and maintenance (servicing) instructions in the literature accompanying the appliance.

- 1** Read Instructions – All the safety and operating instructions should be read before the product is operated.
- 2** Retain Instructions – The safety and operating instructions should be retained for future reference.
- 3** Heed Warnings – All warnings on the product and in the operating instructions should be adhered to.
- 4** Follow Instructions – All operating and use instructions should be followed.
- 5** Cleaning – Unplug this product from the wall outlet before cleaning. Do not use liquid cleaners or aerosol cleaners. Use a damp cloth for cleaning.
- 6** Attachments – Do not use attachments not recommended by the product manufacturer as they may cause hazards.
- 7** Water and Moisture – Do not use this product near water – for example, near a bath tub, wash bowl, kitchen sink, or laundry tub; in a wet basement; or near a swimming pool; and the like.
- 8** Accessories – Do not place this product on an unstable cart, stand, tripod, bracket, or table. The product may fall, causing serious injury to a child or adult, and serious damage to the product. Use only with a cart, stand, tripod, bracket, or table recommended by the manufacturer, or sold with the product. Any mounting of the product should follow the manufacturer’s instructions, and should use a mounting accessory recommended by the manufacturer.
- 9** A product and cart combination should be moved with care. Quick stops, excessive force, and uneven surfaces may cause the product and cart combination to overturn.



- 10** Ventilation – Slots and openings in the cabinet are provided for ventilation and to ensure reliable operation of the product and to protect it from overheating, and these openings must not be blocked or covered. The openings should never be blocked by placing the product on a bed, sofa, rug, or other similar surface. This product should not be placed in a built-in installation such as a bookcase or rack unless proper ventilation is provided or the manufacturer’s instructions have been adhered to.
- 11** Power Sources – This product should be operated only from the type of power source indicated on the marking label. If you are not sure of the type of power supply to your home, consult your product dealer or local power company. For products intended to operate from battery power, or other sources, refer to the operating instructions.
- 12** Grounding or Polarization – This product may be equipped with a polarized alternating current line plug (a plug having one blade wider than the other). This plug will fit into the power outlet only one way. This is a safety feature. If you are unable to insert the plug fully into the outlet, try reversing the plug. If the plug should still fail to fit, contact your electrician to replace your obsolete outlet. Do not defeat the safety purpose of the polarized plug.
- 13** Power-Cord Protection – Power-supply cords should be routed so that they are not likely to be walked on or pinched by items placed upon or against them, paying particular attention to cords at plugs, convenience receptacles, and the point where they exit from the product.
- 14** Lightning – For added protection for this product during a lightning storm, or when it is left unattended and unused for long periods of time, unplug it from the wall outlet and disconnect the antenna or cable system. This will prevent damage to the product due to lightning and power-line surges.
- 15** Power Lines – An outside antenna system should not be located in the vicinity of overhead power lines or other electric light or power circuits, or where it can fall into such power lines or circuits. When installing an outside antenna system, extreme care should be taken to keep from touching such power lines or circuits as contact with them might be fatal.
- 16** Overloading – Do not overload wall outlets, extension cords, or integral convenience receptacles as this can result in a risk of fire or electric shock.
- 17** Object and Liquid Entry – Never push objects of any kind into this product through openings as they may touch dangerous voltage points or short-out parts that could result in a fire or electric shock. Never spill liquid of any kind on the product.
- 18** Servicing – Do not attempt to service this product yourself as opening or removing covers may expose you to dangerous voltage or other hazards. Refer all servicing to qualified service personnel.
- 19** Damage Requiring Service – Unplug this product from the wall outlet and refer servicing to qualified service personnel under the following conditions:
  - a)** When the power-supply cord or plug is damaged,
  - b)** If liquid has been spilled, or objects have fallen into the product,
  - c)** If the product has been exposed to rain or water,

- d) If the product does not operate normally by following the operating instructions. Adjust only those controls that are covered by the operating instructions as an improper adjustment of other controls may result in damage and will often require extensive work by a qualified technician to restore the product to its normal operation,
  - e) If the product has been dropped or damaged in any way, and
  - f) When the product exhibits a distinct change in performance - this indicates a need for service.
- 20 Replacement Parts** – When replacement parts are required, be sure the service technician has used replacement parts specified by the manufacturer or have the same characteristics as the original part. Unauthorized substitutions may result in fire, electric shock, or other hazards.
- 21 Safety Check** – Upon completion of any service or repairs to this product, ask the service technician to perform safety checks to determine that the product is in proper operating condition.
- 22 Wall or Ceiling Mounting** – The unit should be mounted to a wall or ceiling only as recommended by the manufacturer.
- 23 Heat** – The product should be situated away from heat sources such as radiators, heat registers, stoves, or other products (including amplifiers) that produce heat.

**24 Outdoor Antenna Grounding** – If an outside antenna or cable system is connected to the product, be sure the antenna or cable system is grounded so as to provide some protection against voltage surges and built-up static charges. Article 810 of the National Electrical Code, ANSI/NFPA 70, provides information with regard to proper grounding of the mast and supporting structure, grounding of the lead-in wire to an antenna discharge unit, size of grounding conductors, location of antenna discharge unit, connection to grounding electrodes, and requirements for the grounding electrode.

EXAMPLE OF ANTENNA GROUNDING

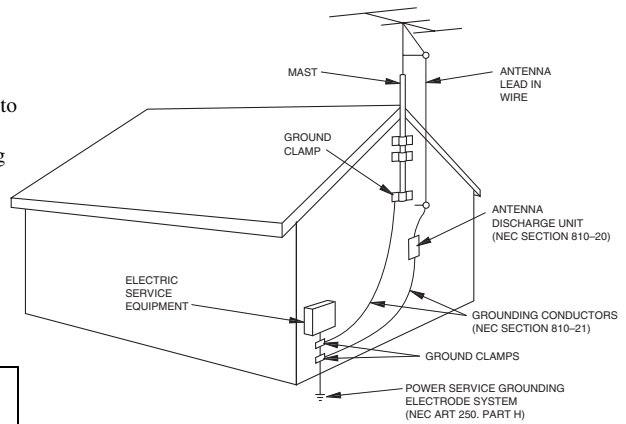

NEC – NATIONAL ELECTRICAL CODE

**Note to CATV system installer:**

This reminder is provided to call the CATV system installer’s attention to Article 820-40 of the NEC that provides guidelines for proper grounding and, in particular, specifies that the cable ground shall be connected to the grounding system of the building, as close to the point of cable entry as practical.

**FCC INFORMATION (for US customers)**

**1 IMPORTANT NOTICE: DO NOT MODIFY THIS UNIT!**

This product, when installed as indicated in the instructions contained in this manual, meets FCC requirements. Modifications not expressly approved by Yamaha may void your authority, granted by the FCC, to use the product.

**2 IMPORTANT:** When connecting this product to accessories and/or another product use only high quality shielded cables. Cable/s supplied with this product **MUST** be used. Follow all installation instructions. Failure to follow instructions could void your FCC authorization to use this product in the USA.

**3 NOTE:** This product has been tested and found to comply with the requirements listed in FCC Regulations, Part 15 for Class “B” digital devices. Compliance with these requirements provides a reasonable level of assurance that your use of this product in a residential environment will not result in harmful interference with other electronic devices.

This equipment generates/uses radio frequencies and, if not installed and used according to the instructions found in the users manual, may cause interference harmful to the operation of other electronic devices.

Compliance with FCC regulations does not guarantee that interference will not occur in all installations. If this product is found to be the source of interference, which can be determined by turning the unit “OFF” and “ON”, please try to eliminate the problem by using one of the following measures:

Relocate either this product or the device that is being affected by the interference.

Utilize power outlets that are on different branch (circuit breaker or fuse) circuits or install AC line filter/s.

In the case of radio or TV interference, relocate/reorient the antenna. If the antenna lead-in is 300 ohm ribbon lead, change the lead-in to coaxial type cable.

If these corrective measures do not produce satisfactory results, please contact the local retailer authorized to distribute this type of product. If you can not locate the appropriate retailer, please contact Yamaha Electronics Corp., U.S.A. 6660 Orangethorpe Ave, Buena Park, CA 90620.

The above statements apply **ONLY** to those products distributed by Yamaha Corporation of America or its subsidiaries.

# CAUTION: READ THIS BEFORE OPERATING YOUR UNIT.

- 1 To assure the finest performance, please read this manual carefully. Keep it in a safe place for future reference.
- 2 Install this sound system in a well ventilated, cool, dry, clean place — away from direct sunlight, heat sources, vibration, dust, moisture, and/or cold. Allow ventilation space of at least 30 cm on the top, 20 cm on the left and right, and 20 cm on the back of this unit.
- 3 Locate this unit away from other electrical appliances, motors, or transformers to avoid humming sounds.
- 4 Do not expose this unit to sudden temperature changes from cold to hot, and do not locate this unit in a environment with high humidity (i.e. a room with a humidifier) to prevent condensation inside this unit, which may cause an electrical shock, fire, damage to this unit, and/or personal injury.
- 5 Avoid installing this unit where foreign object may fall onto this unit and/or this unit may be exposed to liquid dripping or splashing. On the top of this unit, do not place:
  - Other components, as they may cause damage and/or discoloration on the surface of this unit.
  - Burning objects (i.e. candles), as they may cause fire, damage to this unit, and/or personal injury.
  - Containers with liquid in them, as they may fall and liquid may cause electrical shock to the user and/or damage to this unit.
- 6 Do not cover this unit with a newspaper, tablecloth, curtain, etc. in order not to obstruct heat radiation. If the temperature inside this unit rises, it may cause fire, damage to this unit, and/or personal injury.
- 7 Do not plug in this unit to a wall outlet until all connections are complete.
- 8 Do not operate this unit upside-down. It may overheat, possibly causing damage.
- 9 Do not use force on switches, knobs and/or cords.
- 10 When disconnecting the power cord from the wall outlet, grasp the plug; do not pull the cord.
- 11 Do not clean this unit with chemical solvents; this might damage the finish. Use a clean, dry cloth.
- 12 Only voltage specified on this unit must be used. Using this unit with a higher voltage than specified is dangerous and may cause fire, damage to this unit, and/or personal injury. YAMAHA will not be held responsible for any damage resulting from use of this unit with a voltage other than specified.
- 13 To prevent damage by lightning, disconnect the power cord from the wall outlet during an electrical storm.
- 14 Do not attempt to modify or fix this unit. Contact qualified YAMAHA service personnel when any service is needed. The cabinet should never be opened for any reasons.
- 15 When not planning to use this unit for long periods of time (i.e. vacation), disconnect the AC power plug from the wall outlet.
- 16 Be sure to read the “TROUBLESHOOTING” section on common operating errors before concluding that this unit is faulty.
- 17 Before moving this unit, press STANDBY/ON to set this unit in the standby mode, and disconnect the AC power plug from the wall outlet.

## WARNING

TO REDUCE THE RISK OF FIRE OR ELECTRIC SHOCK, DO NOT EXPOSE THIS UNIT TO RAIN OR MOISTURE.

This unit is not disconnected from the AC power source as long as it is connected to the wall outlet, even if this unit itself is turned off. This state is called the standby mode. In this state, this unit is designed to consume a very small quantity of power.

## FOR CANADIAN CUSTOMERS

To prevent electric shock, match wide blade of plug to wide slot and fully insert.  
This Class B digital apparatus complies with Canadian ICES-003.

## IMPORTANT

Please record the serial number of this unit in the space below.  
MODEL:  
Serial No.:  
The serial number is located on the rear of the unit.  
Retain this Owner's Manual in a safe place for future reference.

## We Want You Listening For A Lifetime

YAMAHA and the Electronic Industries Association's Consumer Electronics Group want you to get the most out of your equipment by playing it at a safe level. One that lets the sound come through loud and clear without annoying blaring or distortion - and, most importantly, without affecting your sensitive hearing.

Since hearing damage from loud sounds is often undetectable until it is too late, YAMAHA and the Electronic Industries Association's Consumer Electronics Group recommend you to avoid prolonged exposure from excessive volume levels.



# CONTENTS

## INTRODUCTION

<b>FEATURES</b> .....	<b>2</b>
<b>GETTING STARTED</b> .....	<b>3</b>
Supplied accessories .....	3
Installing batteries in the remote control .....	3
<b>CONTROLS AND FUNCTIONS</b> .....	<b>4</b>
Front panel.....	4
Remote control.....	6
Using the remote control .....	7
Front panel display .....	8
Rear panel .....	9

## PREPARATION

<b>SPEAKER SETUP</b> .....	<b>10</b>
Speaker placement .....	10
Speaker connections .....	11
<b>CONNECTIONS</b> .....	<b>13</b>
Before connecting components.....	13
Connecting video components.....	14
Connecting audio components.....	17
Connecting the antennas.....	18
Connecting the power supply cord .....	19
Turning on the power.....	21
<b>BASIC SETUP</b> .....	<b>22</b>
Using the BASIC SETUP menu .....	22

## BASIC OPERATION

<b>PLAYBACK</b> .....	<b>25</b>
Basic operations.....	25
Selecting sound field programs .....	27
Selecting input modes.....	31
<b>TUNING</b> .....	<b>33</b>
Automatic and manual tuning.....	33
Presetting stations .....	34
Selecting preset stations.....	36
Exchanging preset stations .....	37
<b>RECORDING</b> .....	<b>38</b>

## SOUND FIELD PROGRAMS

<b>SOUND FIELD PROGRAM DESCRIPTIONS</b> .....	<b>39</b>
For movie/video sources.....	39
For music sources .....	41

## ADVANCED OPERATION

<b>ADVANCED OPERATIONS</b> .....	<b>42</b>
Using the sleep timer .....	42
Manually adjusting speaker levels.....	43
Using the test tone .....	43
<b>SET MENU</b> .....	<b>44</b>
Using SET MENU .....	45
1 SOUND MENU .....	46
2 INPUT MENU .....	48
3 OPTION MENU .....	49
<b>REMOTE CONTROL FEATURES</b> .....	<b>51</b>
Control area .....	51
Setting manufacturer codes.....	52
Controlling other components .....	53
Clearing setup manufacturer codes.....	54

## ADDITIONAL INFORMATION

<b>EDITING SOUND FIELD PARAMETERS</b> .....	<b>55</b>
What is a sound field .....	55
Changing parameter settings .....	55
<b>SOUND FIELD PARAMETER DESCRIPTIONS</b> .....	<b>57</b>
<b>TROUBLESHOOTING</b> .....	<b>59</b>
<b>RESETTING THE FACTORY PRESETS</b> .....	<b>63</b>
<b>GLOSSARY</b> .....	<b>64</b>
Audio formats .....	64
Sound field programs.....	65
Audio information .....	65
Video signal information .....	66
<b>SPECIFICATIONS</b> .....	<b>67</b>

INTRODUCTION

PREPARATION

BASIC OPERATION

SOUND FIELD PROGRAMS

ADVANCED OPERATION

ADDITIONAL INFORMATION

English

# FEATURES

## Built-in 6-channel power amplifier

Minimum RMS output power

### [ HTR-5750 ]

(0.06% THD, 20 Hz – 20 kHz, 8Ω)

Front: 90 W + 90 W

Center: 90 W

Surround: 90 W + 90 W

Surround back: 90 W

### [ HTR-5740 ]

(0.06% THD, 20 Hz – 20 kHz, 8Ω)

Front: 85 W + 85 W

Center: 85 W

Surround: 85 W + 85 W

Surround back: 85 W

## Sound field features

- ◆ Proprietary YAMAHA technology for the creation of sound fields
- ◆ Dolby Digital/Dolby Digital EX decoder
- ◆ DTS/DTS ES Matrix 6.1, Discrete 6.1, DTS Neo:6, DTS 96/24 decoder
- ◆ Dolby Pro Logic/Dolby Pro Logic II/Dolby Pro Logic IIx decoder
- ◆ Virtual CINEMA DSP
- ◆ SILENT CINEMA™

## Sophisticated AM/FM tuner

- ◆ 40-station random access preset tuning
- ◆ Automatic preset tuning
- ◆ Preset station shifting capability (preset editing)

## Other features

- ◆ 192-kHz/24-bit D/A converter
- ◆ A SET MENU which provides you with items for optimizing this unit for your audio/video system
- ◆ 6 additional input jacks for discrete multi-channel input
- ◆ Component video input/output capability
- ◆ Optical and coaxial digital audio signal jacks
- ◆ Sleep timer
- ◆ Cinema and music night listening modes
- ◆ Remote control with preset manufacturer codes

### [ HTR-5750 only ]

- ◆ S-Video signal input/output capability
- ◆ Video signal conversion (Composite video ↔ S-Video) capability for monitor out

- This document is the owner's manual for both HTR-5750 and HTR-5740. Model names are given where the details of functions are unique to each model. Illustrations for HTR-5750 are mainly used for explanations.
- ✎ indicates a tip for your operation.
- Some operations can be performed by using either the buttons on the main unit or on the remote control. In cases when the button names differ between the main unit and the remote control, the button name on the remote control is given in parentheses.
- This manual is printed prior to production. Design and specifications are subject to change in part as a result of improvements, etc. In case of differences between the manual and product, the product has priority.



Manufactured under license from Dolby Laboratories.

"Dolby", "Pro Logic", "Surround EX", and the double-D symbol are trademarks of Dolby Laboratories.



"DTS", "DTS-ES", "Neo:6" and "DTS 96/24" are trademarks of Digital Theater Systems, Inc.

"SILENT CINEMA" is a trademark of YAMAHA CORPORATION.

# GETTING STARTED

## Supplied accessories

Please check that you received all of the following parts.

### Remote control

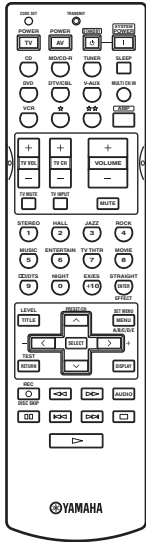

**Batteries (4)  
(AAA, R03, UM-4)**

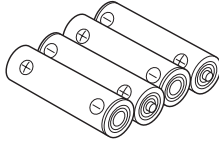

**AM loop antenna**



**75-ohm/300-ohm antenna  
adapter (U.K. model only)**

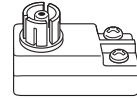

**Indoor FM antenna  
(U.S.A., Canada and  
China models)**

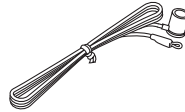

**Indoor FM antenna  
(U.K., Europe, Australia  
and Korea models)**

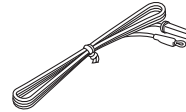

## Installing batteries in the remote control

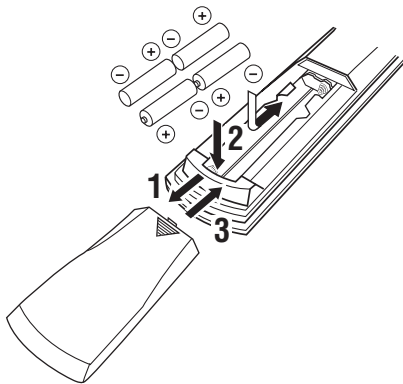

**1** Press the ▼ part and slide the battery compartment cover off.

**2** Insert four supplied batteries (AAA, R03, UM-4) according to the polarity markings (+ and -) on the inside of the battery compartment.

**3** Slide the cover back until it snaps into place.

### Notes on batteries

- Change all of the batteries if you notice the condition like; the operation range of the remote control decreases, the indicator does not flash or its light becomes dim.
- Do not use old batteries together with new ones.
- Do not use different types of batteries (such as alkaline and manganese batteries) together. Read the packaging carefully as these different types of batteries may have the same shape and color.
- If the batteries have leaked, dispose of them immediately. Avoid touching the leaked material or letting it come into contact with clothing, etc. Clean the battery compartment thoroughly before installing new batteries.

If the remote control is without batteries for more than 2 minutes, or if exhausted batteries remain in the remote control, the contents of the memory may be cleared. When the memory is cleared, insert new batteries, set up the manufacturer code and program any acquired functions that may have been cleared.

# CONTROLS AND FUNCTIONS

## Front panel

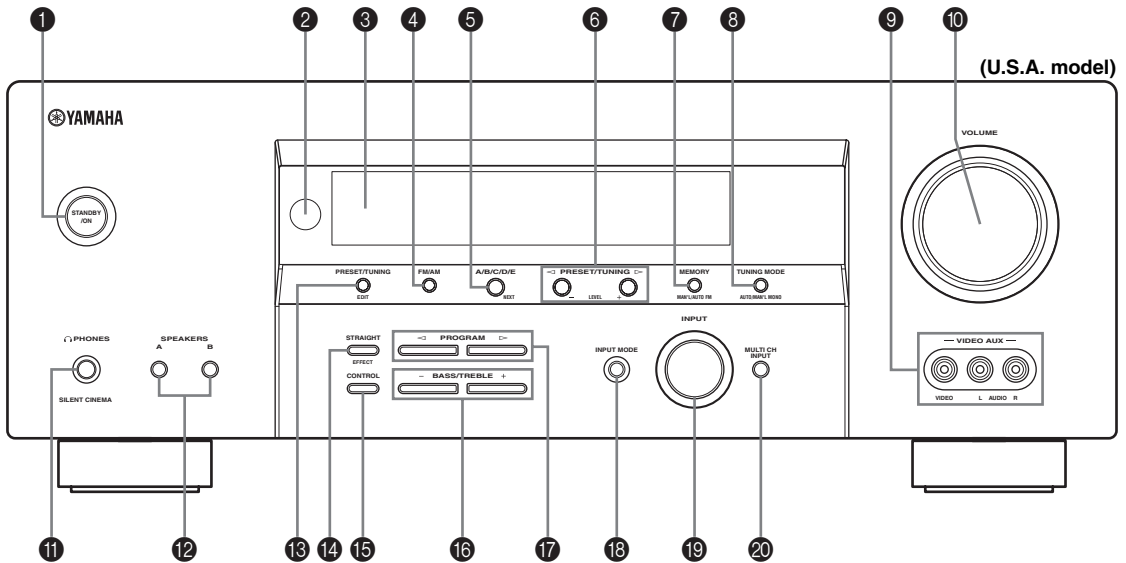

### 1 STANDBY/ON

Turns on this unit or sets it to the standby mode. When you turn on this unit, you will hear a click and there will be a 4 to 5-second delay before this unit can reproduce sound.

#### Note

In standby mode, this unit consumes a small amount of power in order to receive infrared-signals from the remote control.

### 2 Remote control sensor

Receives signals from the remote control.

### 3 Front panel display

Shows information about the operational status of this unit.

### 4 FM/AM

Switches the reception band between FM and AM.

### 5 A/B/C/D/E (NEXT)

Selects one of the 5 preset station groups (A to E) when the unit is in tuner mode.

Selects the speaker channel to be adjusted when the unit is not in tuner mode.

### 6 PRESET/TUNING </> (LEVEL +/-)

Selects preset station number 1 to 8 when the colon (:) is displayed next to the band indication in the front panel display when the unit is in tuner mode. Selects the tuning frequency when the colon (:) is not displayed.

Adjusts the level of the speaker channel selected using A/B/C/D/E (NEXT) when the unit is not in tuner mode.

### 7 MEMORY (MAN'L/AUTO FM)

Stores a station in the memory. Hold down this button for more than 3 seconds to start automatic preset tuning.

### 8 TUNING MODE (AUTO/MAN'L MONO)

Switches between automatic tuning (AUTO indicator on) and manual tuning (AUTO indicator off).

### 9 VIDEO AUX jacks

Input audio and video signals from a portable external source such as a game console. To reproduce source signals from these jacks, select V-AUX as the input source.

### 10 VOLUME

Controls the output level of all audio channels. This does not affect the REC OUT level.



**11 PHONES (SILENT CINEMA) jack**

Outputs audio signals for private listening with headphones. When you connect headphones, no signals are output to the OUTPUT jacks or to the speakers. All Dolby Digital and DTS audio signals are mixed down to the left and right headphone channels.

**12 SPEAKERS A/B**

Turns on or off the set of front speakers connected to the A and/or B terminals on the rear panel each time the corresponding button is pressed.

**13 PRESET/TUNING (EDIT)**

Switches the function of PRESET/TUNING </> (LEVEL -/+ ) between selecting preset station numbers and tuning.

**14 STRAIGHT (EFFECT)**

Switches the sound fields off or on. When STRAIGHT is selected, input signals (2-channel or multi-channel) are output directly from their respective speakers without effect processing.

**15 CONTROL**

Use to adjust the bass/treble balance for the front left and right speakers (see page 26).

**16 BASS/TREBLE -/+**

Use to adjust the bass/treble balance for the front left and right speakers (in conjunction with CONTROL).

**17 PROGRAM </>**

Use to select sound field programs (see page 26).

**18 INPUT MODE**

Sets the priority (AUTO, DTS, ANALOG) for the type of signals received when one component is connected to two or more of this unit's input jacks (see page 31).

**19 INPUT selector**

Selects the input source you want to listen to or watch.

**20 MULTI CH INPUT**

Selects the source connected to the MULTI CH INPUT jacks. When selected, the MULTI CH INPUT source takes priority over the source selected with INPUT (or the input selector buttons on the remote control).

## Remote control

This section describes the function of each control on the remote control used to control this unit. To operate other components, see “REMOTE CONTROL FEATURES” on page 51.

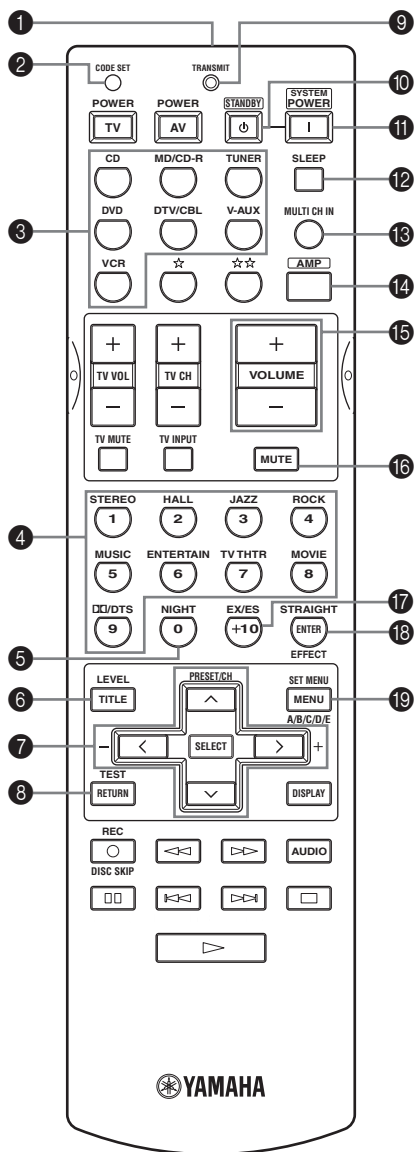

**1 Infrared window**

Outputs infrared control signals. Aim this window at the component you want to operate.

**2 CODE SET**

Use to set up manufacturer codes (see page 52).

**3 Input selector buttons**

Select the input source and change the control area.

**4 Sound field program / numeric buttons (1 - 8)**

Use to select sound field programs.

Use numbers 1 through 8 to select preset stations when the unit is in tuner mode.

**5 NIGHT**

Turns on or off the night listening modes (see page 30).

**6 LEVEL**

Selects the speaker channel to be adjusted and sets the level.

**7 Cursor buttons ^ / v / < / > / SELECT**

Use to select and adjust sound field program parameters or SET MENU items.

Press ^ / v to select preset station numbers when the unit is in tuner mode.

**8 TEST (RETURN)**

Outputs the test tone to adjust the speaker levels.

Returns to the previous menu level when adjusting the SET MENU parameters.

**9 TRANSMIT indicator**

Flashes while the remote control is sending signals.

**10 STANDBY**

Sets this unit in the standby mode.

**11 SYSTEM POWER**

Turns on the power of this unit.

**12 SLEEP**

Sets the sleep timer.

**13 MULTI CH IN**

Selects MULTI CH INPUT when using an external decoder (etc.).

**14 AMP**

Selects the AMP mode. You must select the AMP mode to control the main unit.

**15 VOLUME -/+**

Increases or decreases the volume level.

**16 MUTE**

Mutes the sound. Press again to restore the audio output to the previous volume level.

**17 EX/ES**

Switches between 5.1 or 6.1-channel playback of multi-channel software.

**18 STRAIGHT (EFFECT)**

Switches the sound fields off or on. When STRAIGHT is selected, input signals (2-channel or multi-channel) are output directly from their respective speakers without effect processing.

**19 SET MENU (A/B/C/D/E)**

Activates the SET MENU function.

Selects preset station groups when the unit is in tuner mode.

**Using the remote control**

The remote control transmits a directional infrared beam. Be sure to aim the remote control directly at the remote control sensor on the main unit during operation.

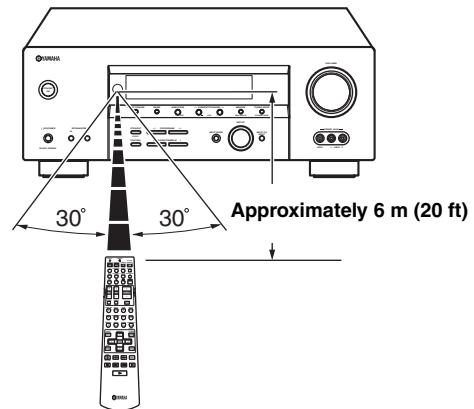
**Handling the remote control**

- Do not spill water or other liquids on the remote control.
- Do not drop the remote control.
- Do not leave or store the remote control in the following types of conditions:
  - high humidity such as near a bath
  - high temperature such as near a heater or stove
  - extremely low temperatures
  - dusty places

## Front panel display

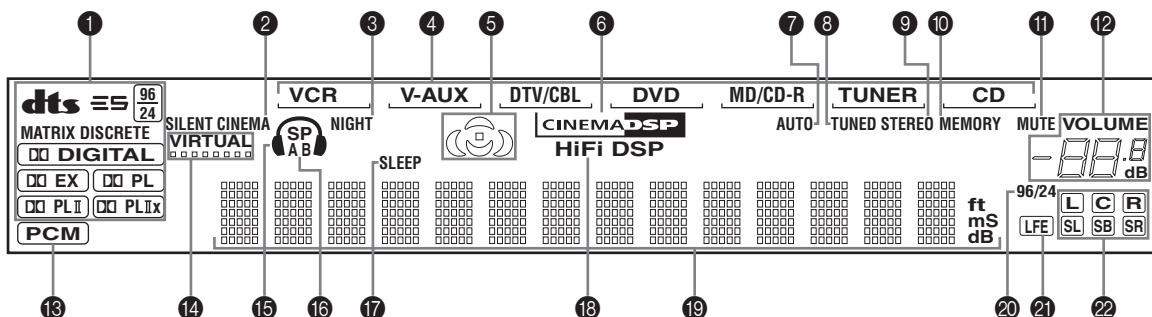

**1 Decoder indicators**

When any of this unit's decoders function, the respective indicator lights up.

**2 SILENT CINEMA indicator**

Lights up when headphones are connected and a sound field program is selected (see page 26).

**3 NIGHT indicator**

Lights up when you select night listening mode.

**4 Input source indicators**

A cursor lights to show the current input source.

**5 Sound field indicators**

Light to indicate the active DSP sound fields.

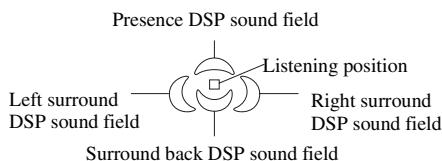

**6 CINEMA DSP indicator**

Lights up when you select a CINEMA DSP sound field program.

**7 AUTO indicator**

Lights up to indicate that automatic tuning is possible.

**8 TUNED indicator**

Lights up when this unit is tuned into a station.

**9 STEREO indicator**

Lights up when this unit is receiving a strong signal for an FM stereo broadcast while the AUTO indicator is lit.

**10 MEMORY indicator**

Blinks to show that a station can be stored.

**11 MUTE indicator**

Blinks while the MUTE function is on.

**12 VOLUME level indication**

Indicates the volume level.

**13 PCM indicator**

Lights up when this unit is reproducing PCM (pulse code modulation) digital audio signals.

**14 VIRTUAL indicator**

Lights up when Virtual CINEMA DSP is active (see page 31).

**15 Headphones indicator**

Lights up when headphones are connected.

**16 SP A B indicators**

Light up according to the set of front speakers selected. Both indicators light up when both sets of speakers are selected.

**17 SLEEP indicator**

Lights up while the sleep timer is on.

**18 HiFi DSP**

Lights when you select a HiFi DSP sound field program.

**19 Multi-information display**

Shows the current sound field program name and other information when adjusting or changing settings.

**20 96/24 indicator**

Lights up when a DTS 96/24 signal is input to this unit.

**21 LFE indicator**

Lights up when the input signal contains the LFE signal.

**22 Input channel indicators/speaker indicators**

Indicate the channel components of the current digital input signal. Indicate the number of speakers connected in SPEAKERS (page 23), or indicate the channel being adjusted in SP LEVEL (page 47).

## Rear panel

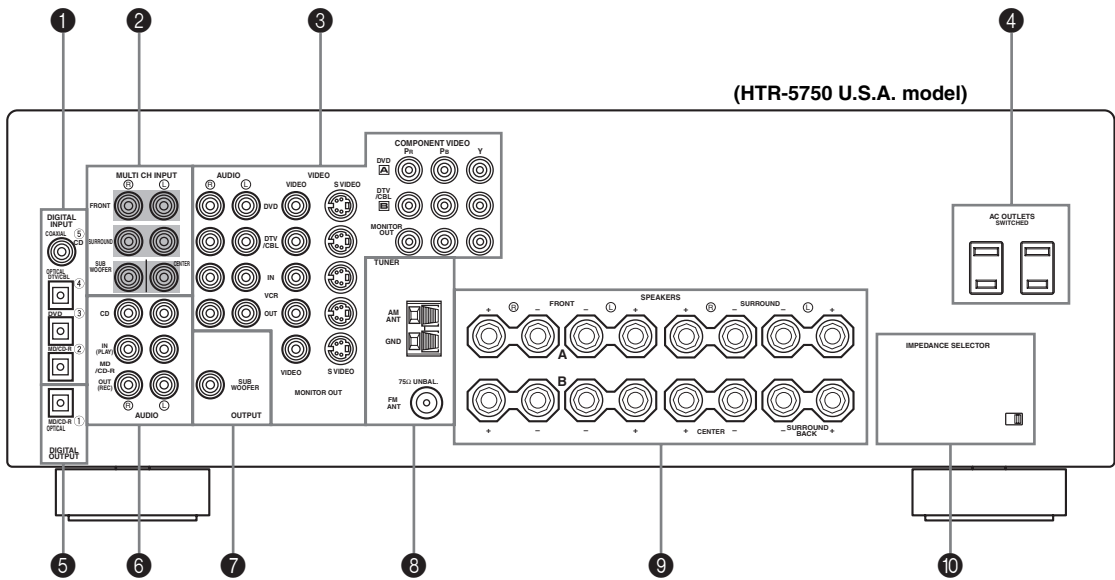

**1 DIGITAL INPUT jacks**

[ HTR-5750 ]

CD<sup>5</sup>, DTV/CBL<sup>4</sup>, DVD<sup>3</sup>, MD/CD-R<sup>2</sup>

[ HTR-5740 ]

CD<sup>3</sup>, DTV/CBL<sup>2</sup>, DVD<sup>1</sup>

See pages 14, 16 and 17 for details.

**2 MULTI CH INPUT jacks**

See page 15 for connection information.

**3 Video component jacks**

See pages 14 and 16 for connection information.

S VIDEO jacks are only available for HTR-5750.

**4 AC OUTLET(S)**

Use to supply power to your other A/V components (see page 19).

**5 DIGITAL OUTPUT jack (HTR-5750 only)**

See page 17 for details.

**6 Audio component jacks**

See page 17 for connection information.

**7 SUB WOOFER OUTPUT jack**

See page 12 for connection information.

**8 Antenna terminals**

See page 18 for connection information.

**9 Speaker terminals**

See page 12 for connection information.

**10 IMPEDANCE SELECTOR switch**

See page 20.

# SPEAKER SETUP

## Speaker placement

The speaker layout below shows the standard ITU-R speaker setting. You can use it to enjoy CINEMA DSP and multi-channel audio sources.

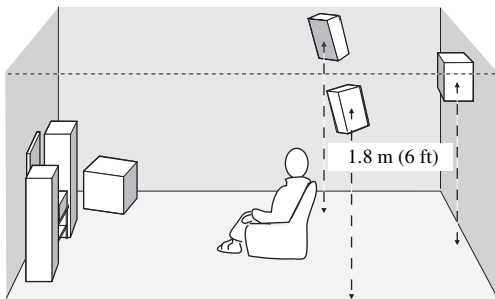
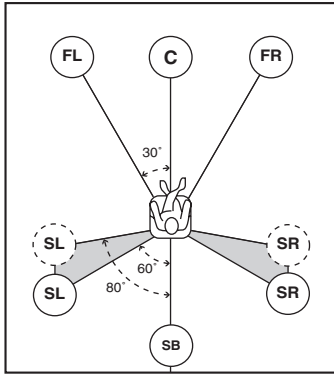

### Front speakers (FR and FL)

The front speakers are used for the main source sound plus effect sounds. Place these speakers an equal distance from the ideal listening position. The distance of each speaker from each side of the video monitor should be the same.

### Center speaker (C)

The center speaker is for the center channel sounds (dialog, vocals, etc.). If for some reason it is not practical to use a center speaker, you can do without it. Best results, however, are obtained with the full system. Align the front face of the center speaker with the front face of your video monitor. Place the speaker centrally between the front speakers and as close to the monitor as possible, such as directly over or under it.

### Surround speakers (SR and SL)

The surround speakers are used for effect and surround sounds. Place these speakers behind your listening position, facing slightly inwards, about 1.8 m (6 ft) above the floor.

### Surround back speaker (SB)

The surround back speaker supplements the surround speakers and provides for more realistic front-to-back transitions. Place this speaker directly behind the listening position and at the same height as the surround speakers.

### Subwoofer

The use of a subwoofer, such as the YAMAHA Active Servo Processing Subwoofer System, is effective not only for reinforcing bass frequencies from any or all channels, but also for high fidelity reproduction of the LFE (low-frequency effect) channel included in Dolby Digital and DTS software. The position of the subwoofer is not so critical, because low bass sounds are not highly directional. But it is better to place the subwoofer near the front speakers. Turn it slightly toward the center of the room to reduce wall reflections.

## Speaker connections

Be sure to connect the left channel (L), right channel (R), “+” (red) and “-” (black) properly. If the connections are faulty, no sound will be heard from the speakers, and if the polarity of the speaker connections is incorrect, the sound will be unnatural and lack bass.

### CAUTION

- If you will use 6 ohm speakers, be sure to set this unit's speaker impedance setting to 6 ohms before using (see page 20).
- Before connecting the speakers, make sure that the power of this unit is off.
- Do not let the bare speaker wires touch each other or do not let them touch any metal part of this unit. This could damage this unit and/or speakers.
- Use magnetically shielded speakers. If this type of speakers still creates the interference with the monitor, place the speakers away from the monitor.

A speaker cord is actually a pair of insulated cables running side by side. One cable is colored or shaped differently, perhaps with a stripe, groove or ridges. Connect the striped (grooved, etc.) cable to the “+” (red) terminals on this unit and your speaker. Connect the plain cable to the “-” (black) terminals.

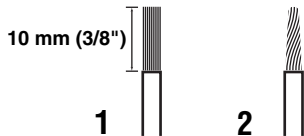

- 1 Remove approximately 10 mm (3/8") of insulation from the end of each speaker cable.
- 2 Twist the exposed wires of the cable together to prevent short circuits.
- 3 Unscrew the knob.
- 4 Insert one bare wire into the hole in the side of each terminal.

- 5 Tighten the knob to secure the wire.

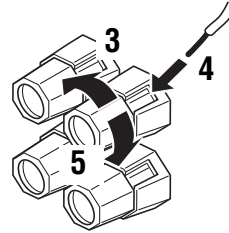

Red: positive (+)  
Black: negative (-)

### ■ Banana plug connections

(With the exception of U.K. and Europe models)  
First, tighten the knob and then insert the banana plug connector into the end of the corresponding terminal.

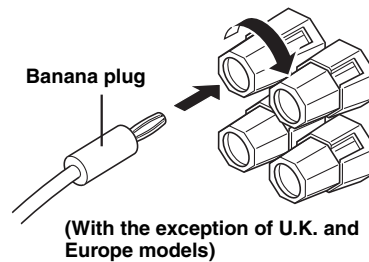

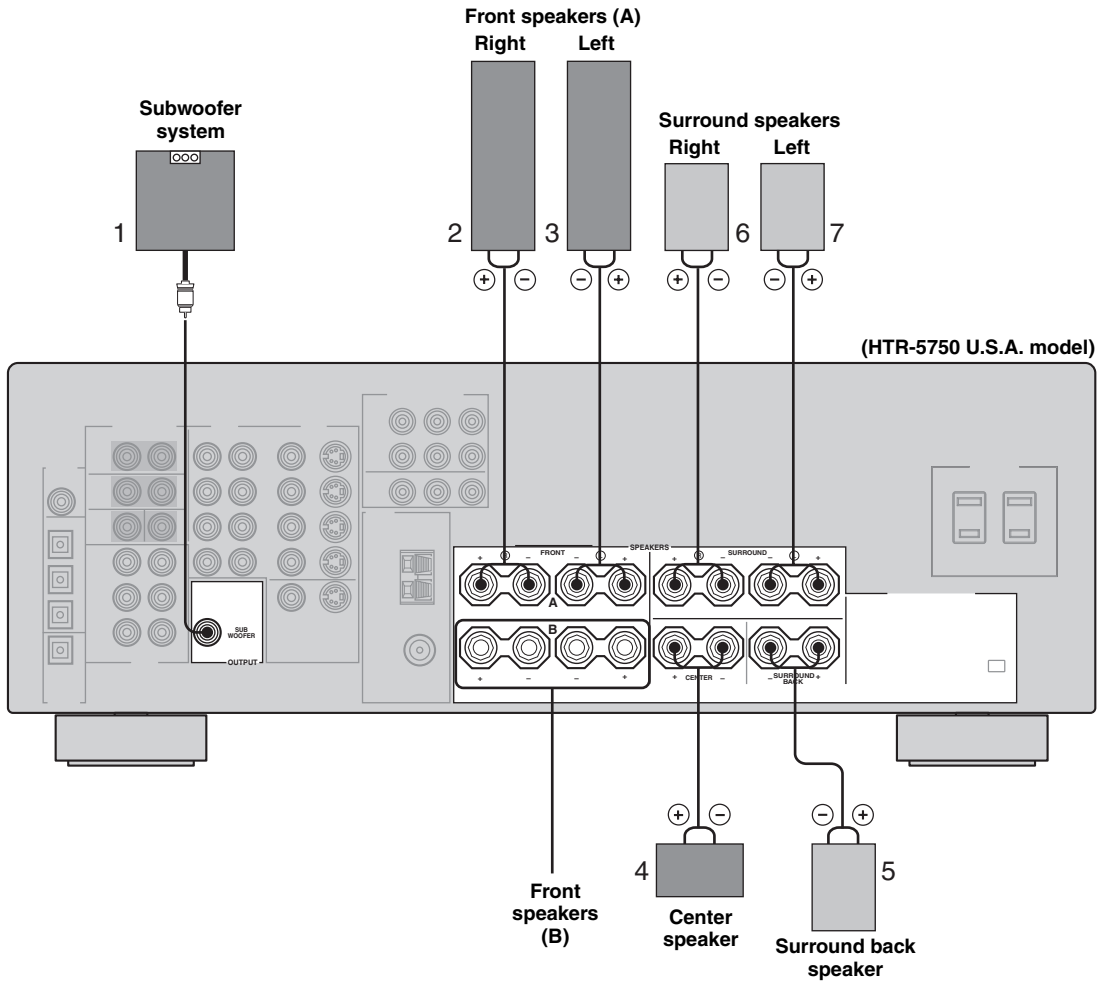

■ **FRONT terminals**

Connect one or two speaker systems to these terminals. If you use only one speaker system, connect it to either the FRONT A or B terminals.

**Note**

The Canada model cannot output to two separate speaker systems simultaneously.

■ **CENTER terminals**

Connect a center speaker to these terminals.

■ **SURROUND terminals**

Connect surround speakers to these terminals.

■ **SUB WOOFER jack**

Connect a subwoofer with built-in amplifier, such as the YAMAHA Active Servo Processing Subwoofer System, to this jack.

■ **SURROUND BACK terminals**

Connect a surround back speaker to these terminals.

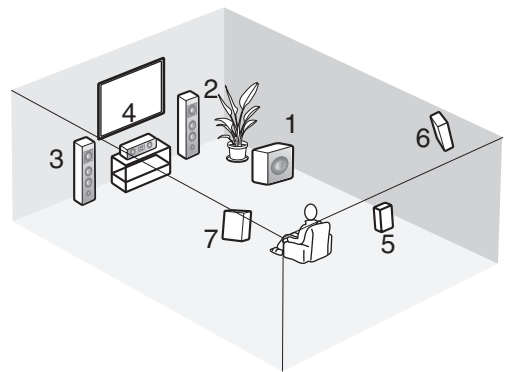

**Speaker layout**



# CONNECTIONS

## Before connecting components

### CAUTION

Do not connect this unit or other components to the mains power until all connections between components are complete.

### ■ Cable indications

#### For analog signals

left analog cables



right analog cables



#### For digital signals

optical cables



coaxial cables



#### For video signals

video cables



S-Video cables



### ■ Analog jacks

You can input analog signals from audio components by connecting audio pin cable to the analog jacks on this unit. Connect red plugs to the right jacks and white plugs to the left jacks.

### ■ Digital jacks

This unit has digital jacks for direct transmission of digital signals through either coaxial or fiber optic cables. You can use the digital jacks to input PCM, Dolby Digital and DTS bitstreams. When you connect components to both the COAXIAL and OPTICAL jacks, priority is given to the input signals from the COAXIAL jack. All digital input jacks are compatible with 96-kHz sampling digital signals.

### Note

This unit handles digital and analog signals independently. Thus audio signals input to the analog jacks are only output to the analog OUT (REC) jacks.

[ HTR-5750 only ] Likewise audio signals input to the digital (OPTICAL or COAXIAL) jacks are only output to the DIGITAL OUTPUT jack.

### Dust protection cap

Pull out the cap from the optical jack before you connect the fiber optic cable. Do not discard the cap. When you are not using the optical jack, be sure to put the cap back in place. This cap protects the jack from dust.



### ■ Video jacks

#### [ HTR-5750 ]

This unit has three types of video jacks. Connection depends on the availability of input jacks on your monitor. The signals input through the S VIDEO jacks on this unit are automatically converted for output through the VIDEO jacks. When V CONV. is set to ON (see page 49), signals input through the VIDEO jacks can be output through the S VIDEO jacks.



#### [ HTR-5740 ]

This unit has two types of video jacks. Connection depends on the availability of input jacks on your monitor.



### VIDEO jack

For conventional composite video signals.

### S VIDEO jack ( HTR-5750 only )

For S-Video signals, separated into luminance (Y) and color (C) video signals to achieve high-quality color reproduction.

### COMPONENT VIDEO jacks

For component signals, separated into luminance (Y) and color difference (PB, PR) to provide the best quality in picture reproduction.

### Note

[ HTR-5750 only ] When signals are input through both the S VIDEO and VIDEO jacks, signals input through the S VIDEO jack have priority.

Signal flow inside this unit (HTR-5750)

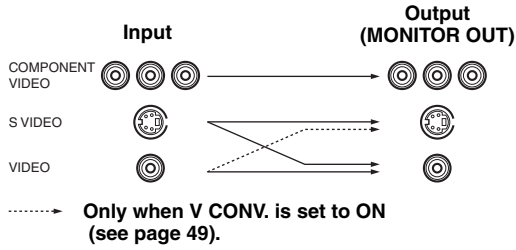

Signal flow inside this unit (HTR-5740)

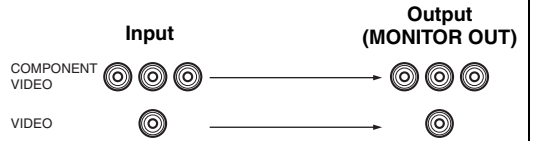

## Connecting video components

### Connections for DVD playback

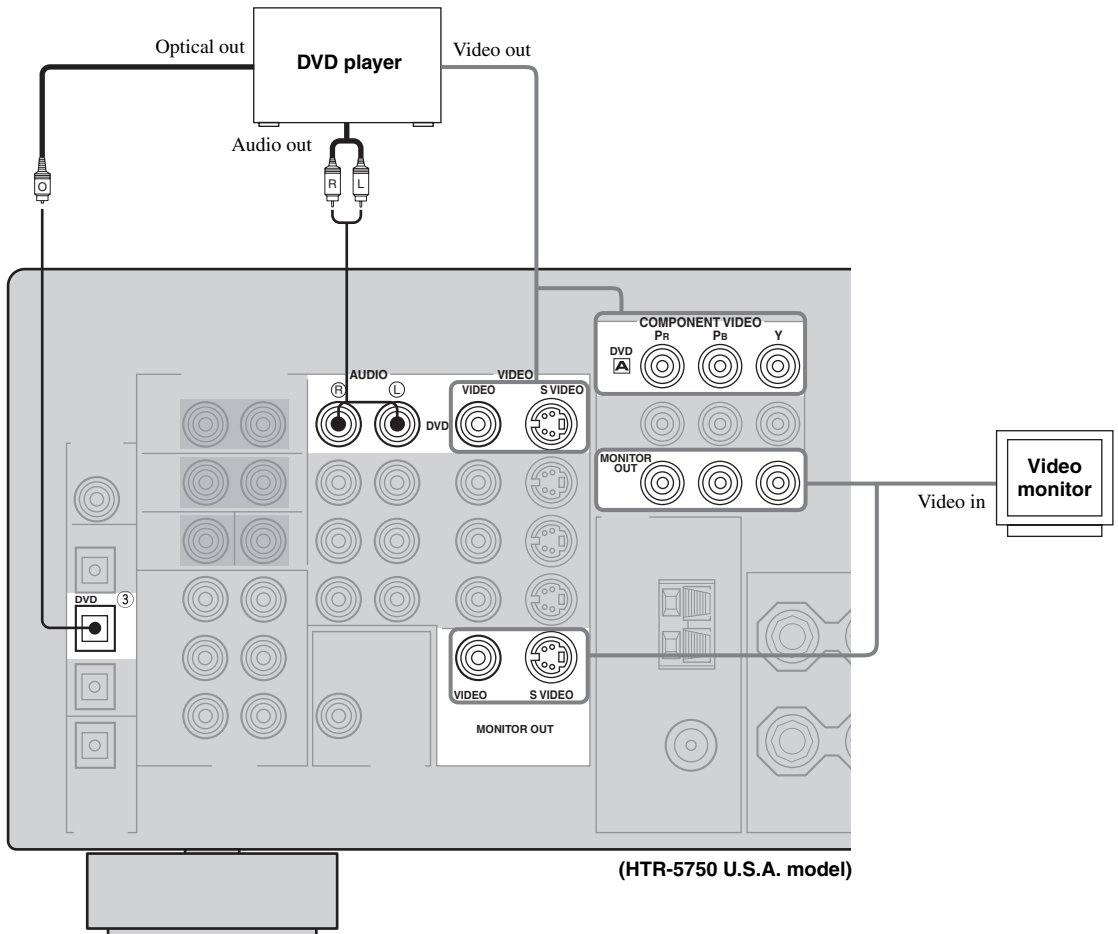

### ■ Connecting to the MULTI CH INPUT jacks

This unit is equipped with 6 additional input jacks (left and right FRONT, CENTER, left and right SURROUND and SUB WOOFER) for discrete multi-channel input from a multi-format player, external decoder, sound processor or pre-amplifier.

Connect the output jacks on your multi-format player or external decoder to the MULTI CH INPUT jacks. Be sure to match the left and right outputs to the left and right input jacks for the front and surround channels.

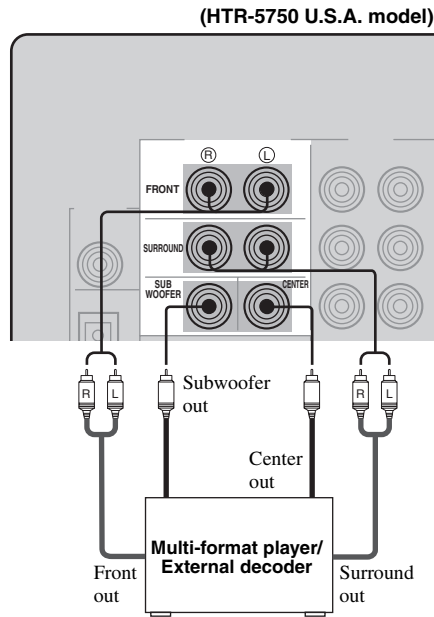

#### Notes

- When you select MULTI CH INPUT as the input source, this unit automatically turns off the digital sound field processor, and you cannot select sound field programs.
- This unit does not redirect signals input to the MULTI CH INPUT jacks to accommodate for missing speakers. We recommend that you connect at least a 5.1-channel speaker system before using this feature.
- When headphones are used, only front left and right channels are output.

■ Connections for other video components

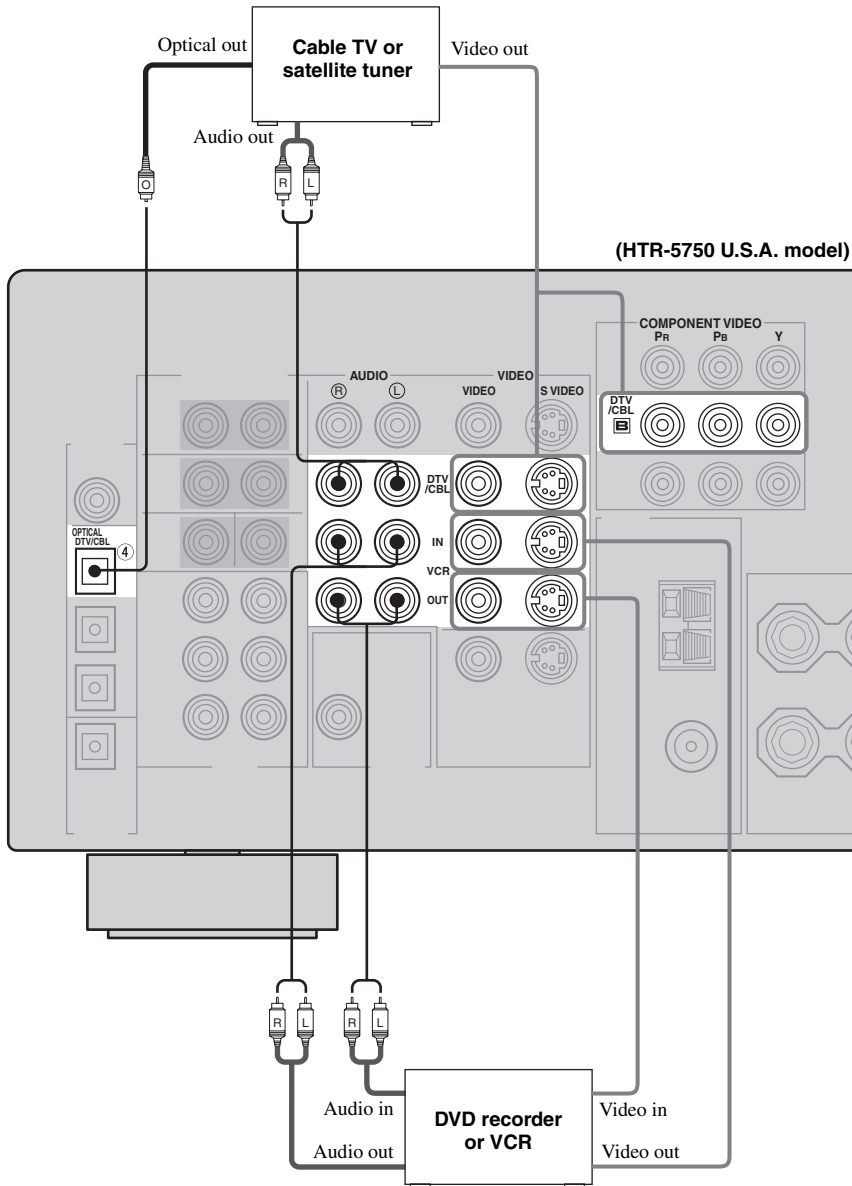

■ VIDEO AUX jacks (on the front panel)

Use these jacks to connect any video source, such as a game console or video camera, to this unit.

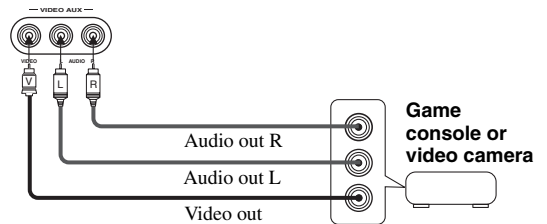

## Connecting audio components

### ■ Connections for audio components

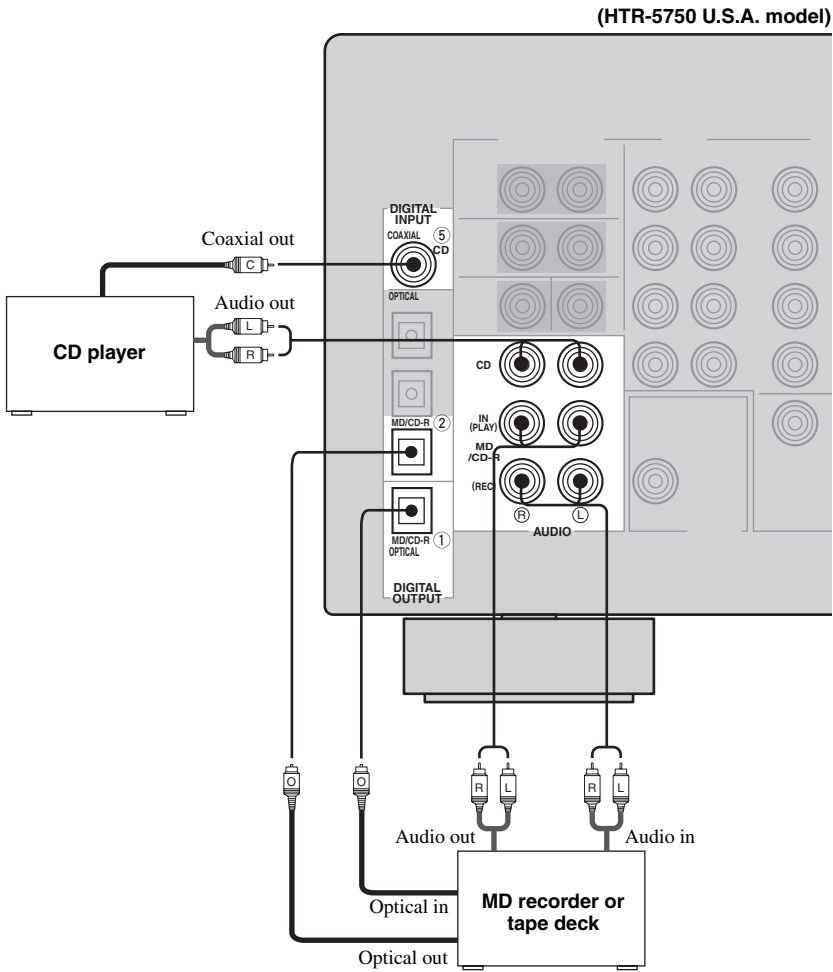

## Connecting the antennas

Both AM and FM indoor antennas are included with this unit. In general, these antennas should provide sufficient signal strength. Connect each antenna correctly to the designated terminals.

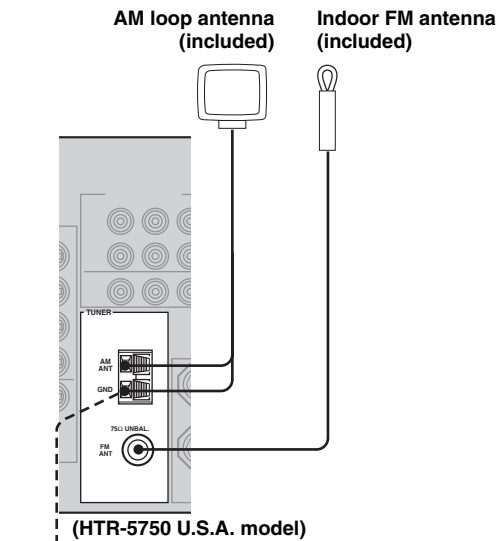

**Ground (GND terminal)**  
For maximum safety and minimum interference, connect the antenna GND terminal to a good earth ground. A good earth ground is a metal stake driven into moist earth.

### ■ Connecting the AM loop antenna

**1** Set up the AM loop antenna, then connect it to the terminals on this unit.

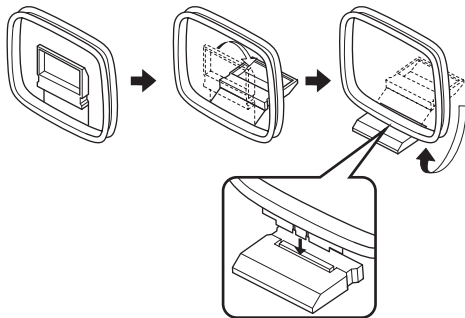

**2** Press and hold the tab to insert the AM loop antenna lead wires into the AM ANT and GND terminals.



**3** Orient the AM loop antenna for the best reception.



### Notes

- The AM loop antenna should be placed away from this unit.
- The AM loop antenna should always be connected, even if an outdoor AM antenna is connected to this unit.
- A properly installed outdoor antenna provides clearer reception than an indoor one. If you experience poor reception quality, an outdoor antenna may improve the quality. Consult the nearest authorized YAMAHA dealer or service center about outdoor antennas.

### ■ 75-ohm/300-ohm antenna adapter (U.K. model only)

**1** Open the cover of the included 75-ohm/300-ohm antenna adapter.

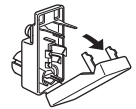

**2** Cut the external sleeve of the 75-ohm coaxial cable and prepare it for connection.

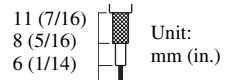

**3** Cut the lead wire and remove it.

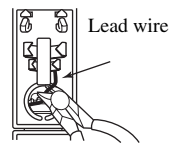

**4** Insert the cable wire into the slot, and clamp it with pliers.

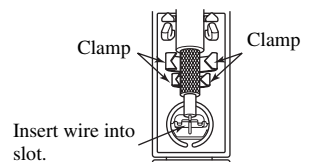

**5** Snap the cover into place.

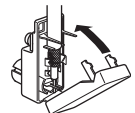

## Connecting the power supply cord

### ■ Connecting the AC power cord

Plug the power cord into an AC wall outlet.

### ■ AC OUTLET(S) (SWITCHED)

U.K. and Australia models..... 1 OUTLET  
 Korea model..... None  
 Other models..... 2 OUTLETS

Use these outlets to connect the power cords from your other components to this unit. Power to the AC OUTLET(S) is controlled by this unit's STANDBY/ON (or SYSTEM POWER and STANDBY). The outlet(s) supply power to any connected component whenever this unit is turned on. The maximum power (total power consumption of components) that can be connected to the AC OUTLET(S) is:

Korea model..... N/A  
 Other models ..... 100 W

### ■ Memory back-up

The memory back-up circuit prevents the stored data from being lost even if this unit is in the standby mode. However if the power cord is disconnected from the AC wall outlet, or the power supply is cut for more than one week, the stored data will be lost.

■ IMPEDANCE SELECTOR switch

**CAUTION**

Do not change the setting of the IMPEDANCE SELECTOR switch when the unit power is switched on, as doing so may damage the unit.

If this unit fails to turn on when STANDBY/ON is pressed on either the front panel or remote control, the IMPEDANCE SELECTOR switch may not be fully slid to either position. If this is the case, slide the switch all the way to either position when this unit is in standby mode. Select the switch position (left or right) according to the impedance of the speakers in your system.

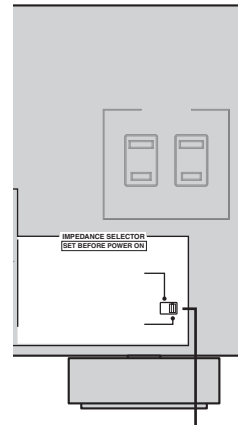

IMPEDANCE SELECTOR switch

Switch position	Speaker	Impedance level
Left	Front	If you use one set (A or B), the impedance of each speaker must be 4 Ω or higher. If you use two sets (A and B), the impedance of each speaker must be 8 Ω or higher.
	Center, Surround, Surround back	The impedance of each speaker must be 6 Ω or higher.
Right	Front	If you use one set (A or B), the impedance of each speaker must be 8 Ω or higher. If you use two sets (A and B), the impedance of each speaker must be 16 Ω or higher.*
	Center, Surround, Surround back	The impedance of each speaker must be 8 Ω or higher.

\* The Canada model cannot use two separate speaker systems (A and B) simultaneously when the switch is set to the right position.



## Turning on the power

When all connections are complete, turn on the power of this unit.

(U.S.A. model)

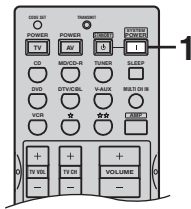
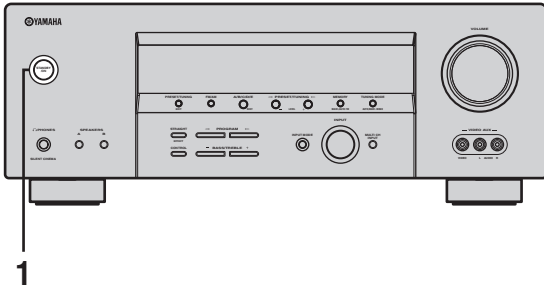

- 1 Press **STANDBY/ON** (**SYSTEM POWER** on the remote control) to turn on the power of this unit.



or

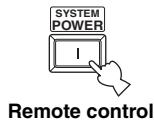

- 2 Turn on the video monitor connected to this unit.

# BASIC SETUP

The basic setup feature is a useful way to set up your system quickly and with minimal effort.



- If you wish to configure the unit manually using more precise adjustments, use the detailed parameters in SOUND MENU (page 46) instead of using BASIC SETUP.
- Altering any parameters in BASIC SETUP will reset all parameters in SOUND MENU.

## Using the BASIC SETUP menu

Before you begin:

- Press SPEAKERS A or B on the front panel to select the main speakers you want to use.
- Make sure you disconnect your headphones from this unit.

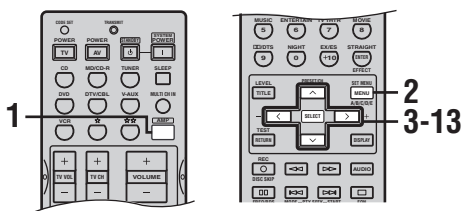

### 1 Press AMP.



### 2 Press SET MENU.

“BASIC SETUP” appears in the front panel display.



BASIC SETUP

### 3 Press SELECT to enter BASIC SETUP.

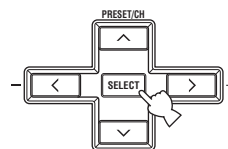

The ROOM parameter appears in the front panel display.

### 4 Press </> to select the desired setting.

ROOM: S M >L

Select the size of the room you have installed your speakers in. Roughly speaking, the room sizes are defined as follows:

[U.S.A. and Canada models]

S (small)	16 x 13ft, 200ft <sup>2</sup> (4.8 x 4.0m, 20m <sup>2</sup> )
M (medium)	20 x 16ft, 300ft <sup>2</sup> (6.3 x 5.0m, 30m <sup>2</sup> )
L (large)	26 x 19ft, 450ft <sup>2</sup> (7.9 x 5.8m, 45m <sup>2</sup> )

[Other models]

S (small)	3.6 x 2.8m, 10m <sup>2</sup>
M (medium)	4.8 x 4.0m, 20m <sup>2</sup>
L (large)	6.3 x 5.0m, 30m <sup>2</sup>

### 5 Press ∨ to display the SUBWOOFER parameter.

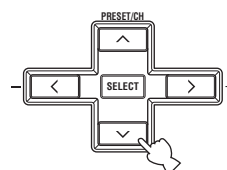

### 6 Press </> to select the desired setting.

SUBWOOFER YES

- YES If you have a subwoofer in your system.
- NONE If you do not have a subwoofer in your system.

**7** Press  $\vee$  to display the **SPEAKERS** parameter.

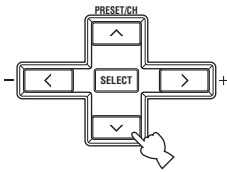

**8** Press  $\langle / \rangle$  to select the number of speakers you connected.

SPEAKERS 6spk

Choices	Display	Speakers
2spk	L R	Front L/R
3spk	L C R	Front L/R, Center
4spk	L SL R SR	Front L/R, Surround L/R
5spk	L C R SL SR	Front L/R, Center, Surround L/R
6spk	L C R SL SB SR	Front L/R, Center, Surround L/R, Surround back

**9** Press  $\vee$  to display **SET/CANCEL**.

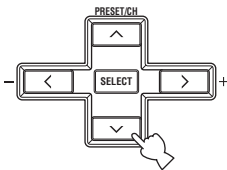

**10** Press  $\langle / \rangle$  to select the desired setting.

>SET CANCEL

- SET To apply the settings you chose in steps 4 through 8.
- CANCEL To cancel the setup without making any changes.

**11** Press **SELECT** to confirm your selection.

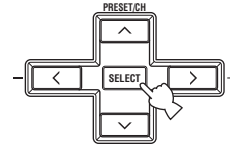

If you selected SET, you hear a test tone from each speaker in turn. "CHECK:Test Tone" appears in the front panel display for a few seconds, then "CHECK: OK?".

CHECK:TestTone



CHECK OK? YES

**12** Press  $\langle / \rangle$  to select the desired setting.

CHECK OK? YES

- YES To complete the setup process if the test tone levels from each speaker were satisfactory.
- NO To proceed to the SP LEVEL speaker level adjustment menu to balance the level of each speaker.

**13** Press **SELECT** to confirm your selection.

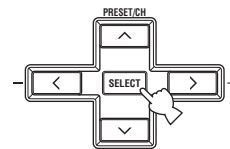

If you selected NO in step 12, the front speaker level adjustment display appears in the front panel display.

**■ To balance the speaker levels**

Perform the following steps after step 13 (see page 23).

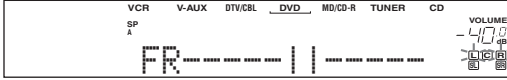

The unit outputs the test tone from the selected speaker and the left front (or left surround) speaker in turn. The indicator of the speaker currently outputting the test tone flashes in the front panel display.

**Memory back-up**

The memory back-up circuit prevents the stored data from being lost even if this unit is in the standby mode. However, if the power cord is disconnected from the AC outlet, or the power supply is cut for more than one week, the stored data will be lost. If so, adjust the items again.

**1 Press  $\nabla$  /  $\blacktriangle$  to select a speaker, then use  $\langle$  /  $\rangle$  to adjust the balance.**

FR-----||-----

Adjusts the balance between the front left and right speakers.

C-----||-----

Adjusts the balance between the front left and center speakers.

SL-----||-----

Adjusts the balance between the front left and surround left speakers.

SB-----||-----

Adjusts the balance between the surround left and surround back speakers.

SR-----||-----

Adjusts the balance between the surround left and surround right speakers.

SWFR-----||-----

Adjusts the balance between the front left speaker and the subwoofer.

**2 Press SET MENU to exit after balancing the speakers.**



You can also balance the speaker levels using test tone by pressing TEST on the remote control.

# PLAYBACK

## Basic operations

(U.S.A. model)

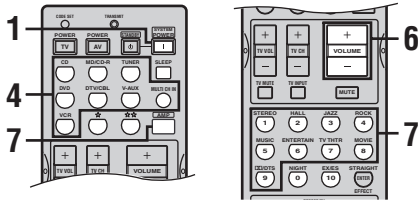
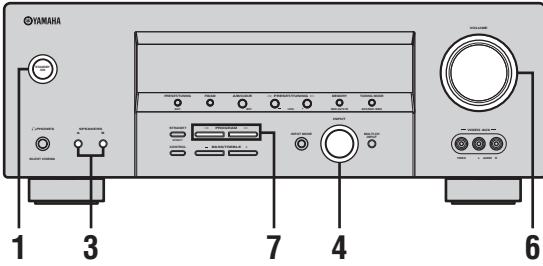

- 1 Press **STANDBY/ON** (SYSTEM POWER on the remote control) to turn on the power.

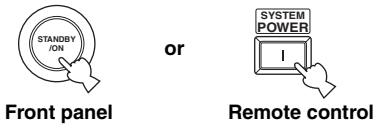

- 2 Turn on the video monitor connected to this unit.

- 3 Press **SPEAKERS A** or **B** on the front panel. Each press turns the respective speakers on or off.

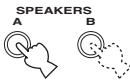

- 4 Select the input source.

Use **INPUT** (or press one of the input selector buttons on the remote control) to select the input you desire.

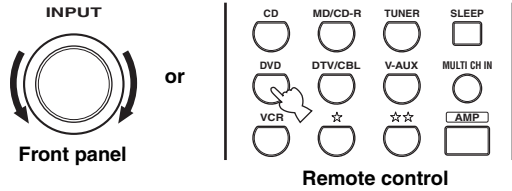

The current input source name and input mode appear in the front panel display and video monitor for a few seconds.

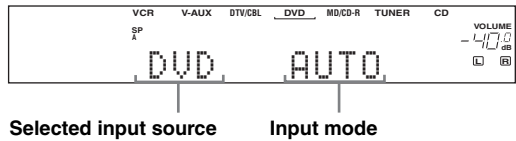

- 5 Start playback or select a broadcast station on the source component.

Refer to the operating instructions for the component.

- 6 Adjust the volume to the desired output level.

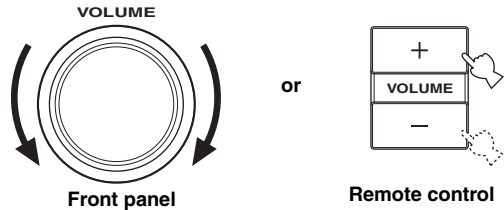

## 7 Select a sound field program if desired.

Press PROGRAM ◀/▶ repeatedly (or press AMP on the remote control to select the AMP mode, then press one of the sound field program buttons repeatedly) to select a sound field program. (See page 39 for details about sound field programs.)

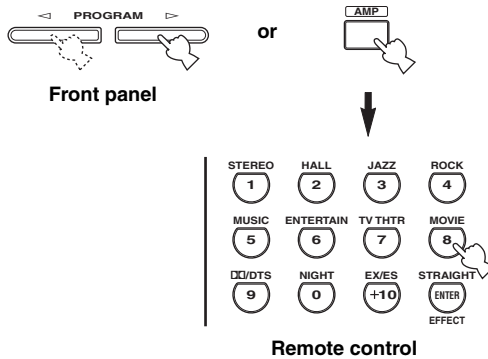

### To listen with headphones (SILENT CINEMA)

“SILENT CINEMA” allows you to enjoy multi-channel music or movie sound, including Dolby Digital and DTS surround, through ordinary headphones. “SILENT CINEMA” activates automatically whenever you connect headphones to the PHONES jack while listening to CINEMA DSP or HiFi DSP sound field programs. When activated, the “SILENT CINEMA” indicator lights up in the front panel display.

#### Notes

- This unit will not be set to “SILENT CINEMA” when MULTI CH INPUT is selected as the input source.
- “SILENT CINEMA” is not effective when the Direct Stereo or 2ch Stereo program is selected, or in STRAIGHT mode.

### To adjust the tone

You can adjust the tonal quality of your front left and right speakers or headphones (when connected).

Press CONTROL on the front panel repeatedly to select TREBLE or BASS, then press BASS/TREBLE -/+ repeatedly to increase or decrease.

- Select TREBLE to adjust the high frequency response.
- Select BASS to adjust the low frequency response.

To cancel the tone control, press CONTROL repeatedly to select BYPASS.



Speaker and headphone adjustments are stored independently.

#### Notes

- If you increase or decrease the high-frequency or low-frequency sound to an extreme level, the tonal quality of the surround speakers may not match that of the front left and right speakers.
- CONTROL is not effective with the Direct Stereo program (page 30) or MULTI CH INPUT.

### To mute the sound

Press MUTE on the remote control.

The MUTE indicator blinks in the front panel display.

To resume the audio output, press MUTE again (or press VOLUME -/+).

The MUTE indicator disappears from the display.



You can adjust the muting level (see page 48).

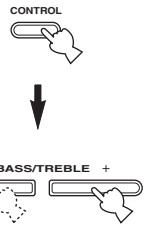

## ■ Selecting MULTI CH INPUT

Press MULTI CH INPUT so that “MULTI CH INPUT” appears in the front panel display and video monitor.

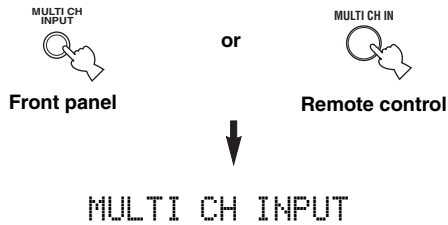

### Note

When “MULTI CH INPUT” is shown in the front panel display, no other source can be played. To select another input source with INPUT (or one of the input selector buttons), press MULTI CH INPUT to turn off “MULTI CH INPUT” in the front panel display.

## ■ Playing video sources in the background

You can combine a video image from a video source with sound from an audio source. For example, you can enjoy listening to classical music while viewing beautiful scenery from the video source on the video monitor.

**Use the input selector buttons on the remote control to select a video source, then select an audio source.**

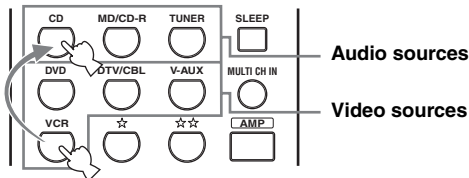

### Note

If you want to enjoy audio from the MULTI CH INPUT jacks together with a video source, first select the video source, then press MULTI CH INPUT.

## Selecting sound field programs

### ■ Front panel operation

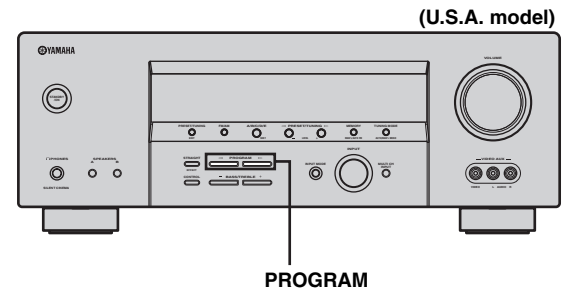

**Press PROGRAM </> repeatedly to select the desired program.**

The name of the selected program appears in the front panel display and video monitor.

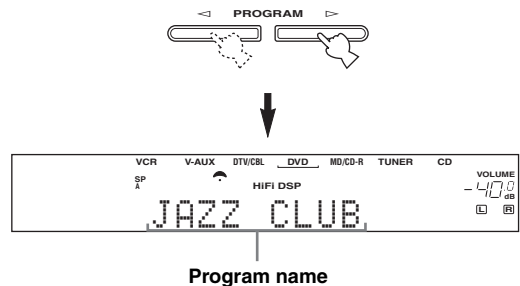

■ Remote control operation

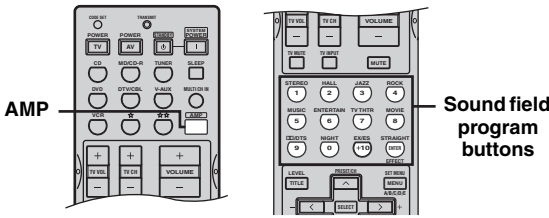

Press AMP to select the AMP mode, then press one of the sound field program buttons repeatedly to select the desired program.

The name of the selected program appears in the front panel display.

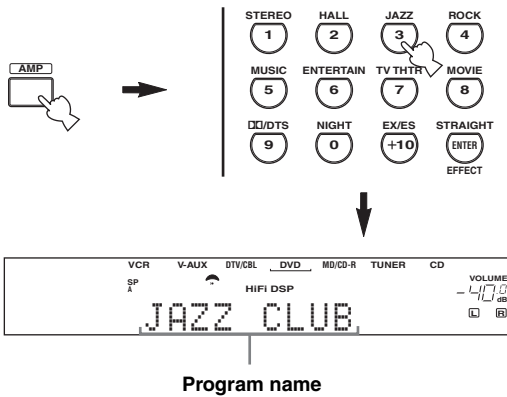

Program name



Feel free to choose a sound field program based on your listening preference, and not purely on the name of the program itself.

**Notes**

- When you select an input source, this unit automatically selects the last sound field program used with that source.
- Sound field programs cannot be selected when MULTI CH INPUT is selected.
- Sampling frequencies higher than 48 kHz (except for DTS 96/24 signals) will be sampled down to 48 kHz, then sound field programs will be applied.

■ Enjoying multi-channel software

If you connected a surround back speaker, use this feature to enjoy 6.1-channel playback for multi-channel sources using the Dolby Pro Logic IIx, Dolby Digital Surround EX or DTS-ES decoders.

Press AMP on the remote control to select the AMP mode, then press EX/ES to switch between 5.1 and 6.1-channel playback.



To select a decoder, press </> repeatedly while PLIIxMusic (etc.) is displayed.

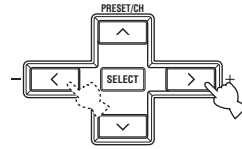

**AUTO (AUTO)**

When a signal (flag) that can be recognized by the unit is input, the unit selects the optimum decoder for playing back the signal in 6.1 channels.

If the unit cannot recognize the flag or no flag is present in the input signal, it cannot automatically be played in 6.1 channels.

**Decoders (select with </>)**

You can select from the following decoders depending on the format of the software you are playing.

**PLIIxMusic**

For playing back Dolby Digital or DTS signals in 6.1 channels using the Pro Logic IIx music decoder.

**EX/ES**

For playing back Dolby Digital signals in 6.1 channels using the Dolby Digital Surround EX decoder.

DTS signals are played back in 6.1 channels using the DTS-ES decoder.

**EX**

For playing back Dolby Digital or DTS signals in 6.1 channels using the Dolby Digital Surround EX decoder.

**OFF (OFF)**

Decoders are not used to create 6.1 channels.



**Notes**

- Some 6.1-channel compatible discs do not have a signal (flag) which this unit can automatically detect. When playing these kinds of discs with 6.1-channel, select a decoder manually (PLIIx Music, EX/ES or EX).
- 6.1-channel playback is not possible even if EX/ES is pressed in the following cases:
  - When “SURR LR” (see page 46) or “SURR B” (see page 46) is set to NONE.
  - When the source connected to the MULTI CH INPUT jack is being played.
  - When the source being played does not contain surround left and right channel signals.
  - When a Dolby Digital KARAOKE source is being played.
  - When “2ch Stereo” or “Direct Stereo” is selected.
- When the power of this unit is turned off, the input mode will be reset to AUTO.
- When the DTS-ES decoder is applied to DTS 96/24 signals, you cannot use the DTS 96/24 decoding feature.
- The Pro Logic IIX decoder is not available when “SURR B” is set to NONE (see page 46).

**■ Enjoying 2-channel software**

Signals input from 2-channel sources can also be played back on multiple channels.

**Press /DTS on the remote control to select the decoder.**



You can select from the following decoders depending on the type of software you are playing and your personal preference.

PRO LOGIC SUR. STANDARD

Standard processing for Dolby Surround sources.

PRO LOGIC SUR. ENHANCED

CINEMA DSP enhanced processing for Dolby Surround sources.

PRO LOGIC IIX Movie\*

Dolby Pro Logic II/IIX processing for movie software.

PRO LOGIC IIX Music\*

Dolby Pro Logic II/IIX processing for music software.

PRO LOGIC IIX Game\*

Dolby Pro Logic II/IIX processing for game software.

DTS Neo:6 Cinema

DTS processing for movie software.

DTS Neo:6 Music

DTS processing for music software.

\* Use the PLII/PLIIX parameter to select the Pro Logic II or Pro Logic IIX decoders (see page 40).

**Note**

The Pro Logic IIX decoder is not available when “SURR B” is set to NONE (see page 46).

**■ Listening to high fidelity stereo sound (Direct Stereo)**

Direct Stereo allows you to bypass this unit's decoders and DSP processors to enjoy pure high fidelity sound from 2-channel PCM and analog sources.

Press **PROGRAM** </> repeatedly (or press **AMP** to select the AMP mode, then press **STEREO** repeatedly) to select "Direct Stereo".

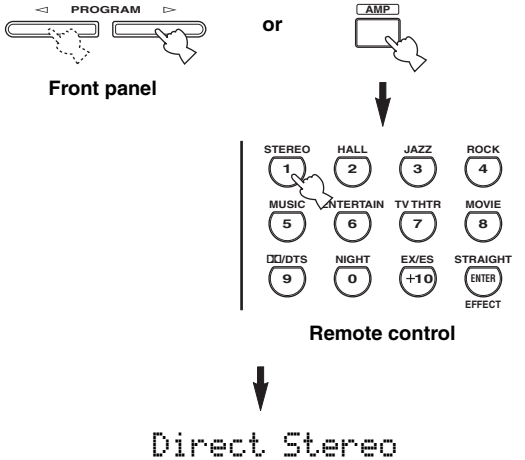

**Notes**

- To avoid unexpected noise, do not play DTS-encoded CDs in this mode.
- When multi-channel signals (Dolby Digital and DTS) are input, this unit automatically switches to the corresponding analog input. (When DTS is selected as an input mode, no sound will be heard.)
- No sound will be output from the subwoofer.
- CONTROL (page 26) and SET MENU (page 44) settings are not effective.
- The front panel display automatically dims.

**■ Night listening modes**

The night listening modes are designed to improve listenability at lower volumes or at night. Choose either NIGHT:CINEMA or NIGHT:MUSIC depending on the type of material you are playing.

Press **NIGHT** on the remote control repeatedly to select cinema or music.

When night listening is selected, the NIGHT indicator in the front panel display lights up.



- Select NIGHT:CINEMA when watching films to reduce the dynamic range of film soundtracks and make dialog easier to hear at lower volumes.
- Select NIGHT:MUSIC when listening to music sources to preserve ease-of-listening for all sounds.
- Select OFF if you do not want to use this function.

Press </> to adjust the effect level while NIGHT:CINEMA or NIGHT:MUSIC is displayed.

This adjusts the level of compression.

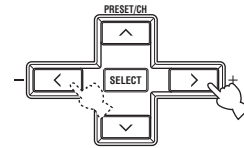

Effect.Lvl:MID

- Select MIN for minimum compression.
- Select MID for standard compression.
- Select MAX for maximum compression.



NIGHT:CINEMA and NIGHT:MUSIC adjustments are stored independently.

**Notes**

- You cannot use the night listening modes with the Direct Stereo program or MULTI CH INPUT (even though the NIGHT indicator lights up when Direct Stereo is selected).
- The night listening modes may vary in effectiveness depending on the input source and surround sound settings you use.

## Downmixing to 2 channels

You can enjoy 2-channel stereo playback even from multi-channel sources.

Press **PROGRAM** ◀/▶ repeatedly (or press **STEREO** on the remote control) to select 2ch Stereo.

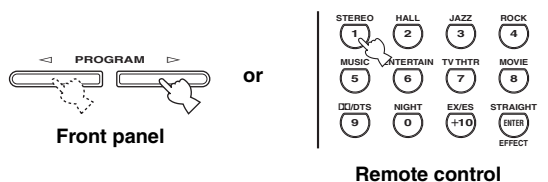

2ch Stereo



You can use a subwoofer with this program when SWFR or BOTH is selected in "BASS OUT".

## Listening to unprocessed input signals

In STRAIGHT mode, two channel stereo sources are output from only the front left and right speakers. Multi-channel sources are decoded straight into the appropriate channels without any additional effect processing.

Press **STRAIGHT (EFFECT)** to select STRAIGHT.

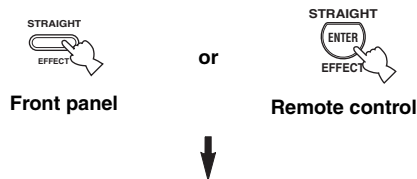

STRAIGHT

Press STRAIGHT (EFFECT) again so that "STRAIGHT" disappears from the display when you want to turn the sound effect back on.

## Virtual CINEMA DSP

Virtual CINEMA DSP allows you to enjoy the CINEMA DSP programs without surround speakers. It creates virtual speakers to reproduce the natural sound field. If you do not connect surround speakers, Virtual CINEMA DSP activates automatically whenever you select a CINEMA DSP sound field program.

### Note

Virtual CINEMA DSP will not activate, even when "SURR LR" is set to NONE (see page 46) in the following cases:

- When MULTI CH INPUT is selected as the input source.
- When headphones are connected to the PHONES jack.

## Selecting input modes

This unit comes with a variety of input jacks. Do the following to select the type of input signals you want to use.

### 1 Rotate INPUT to select the input source.

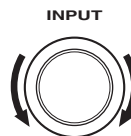

### 2 Press INPUT MODE to select an input mode. In most cases, use AUTO.

INPUT MODE

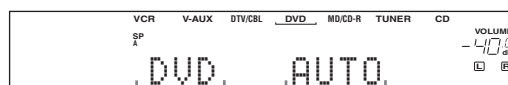

Input source

Input mode

AUTO

Automatically selects input signals in the following order:

- 1) Digital signals\*
- 2) Analog signals

DTS

Selects only digital signals encoded in DTS. If no DTS signals are input, no sound is output.

ANALOG

Selects only analog signals. If no analog signals are input, no sound is output.

\* If this unit detects a Dolby Digital or DTS signal, the decoder automatically switches to the appropriate sound field program.



You can adjust the default input mode this unit selects when the power is turned on (see page 49).

**Notes**

- When you play DTS-encoded CD/LDs with the input mode set to AUTO:
  - This unit automatically switches to the DTS decoding mode. The unit remains in DTS mode (and the **dts** indicator may flash) for up to 30 seconds after playback of the DTS source is complete. To manually release the DTS mode, press INPUT MODE to reselect AUTO.
  - The DTS decoding mode may be released if search or skip operations are performed for more than 30 seconds. To prevent this, press INPUT MODE to select DTS.
- If the digital output data of the player has been processed in any way, you may not be able to perform DTS decoding even if you make a digital connection between this unit and the player.

**Displaying the information about the input source**

You can display the type, format and sampling frequency of the current input signal.

**1 Select the input source.**

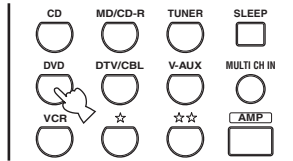

**2 Press AMP to select the AMP mode, then press STRAIGHT (EFFECT) so that “STRAIGHT” appears in the display.**

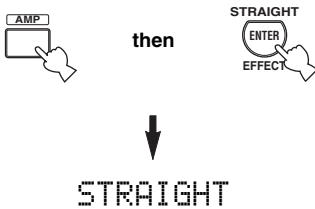

**3 Press ^/∨ to display the following information about the input signal.**

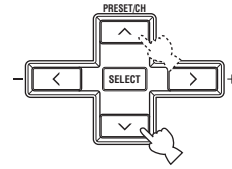

- (Format) Signal format display. When the unit cannot detect a digital signal it automatically switches to analog input.
- in Number of source channels in the input signal. For example, a multi-channel soundtrack with 3 front channels, 2 surround channels and LFE, is displayed as “3/2/LFE”.
- fs Sampling frequency. When the unit is unable to detect the sampling frequency “Unknown” appears.
- rate Bit rate. When the unit is unable to detect the bit rate “Unknown” appears.
- flg Flag data encoded with DTS or Dolby Digital signals that cue this unit to automatically switch decoders.

# TUNING

## Automatic and manual tuning

There are 2 tuning methods; automatic and manual. Automatic tuning is effective when station signals are strong and there is no interference.

### Automatic tuning

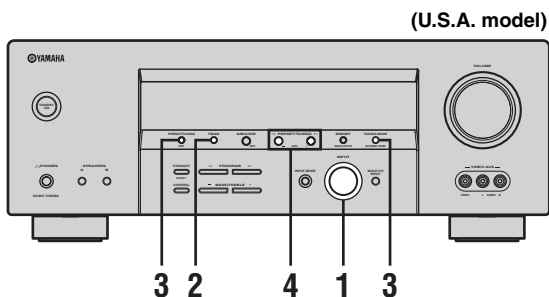

- 1 Rotate **INPUT** to select **TUNER** as the input source.



- 2 Press **FM/AM** to select the reception band. "FM" or "AM" appears in the front panel display.



- 3 Press **TUNING MODE (AUTO/MAN'L MONO)** so that the **AUTO** indicator lights up in the front panel display.



If a colon (:) appears in the front panel display, tuning is not possible. Press **PRESET/TUNING (EDIT)** to turn the colon (:) off.

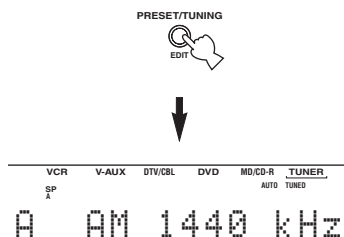

- 4 Press **PRESET/TUNING </>** once to begin automatic tuning.

Press **>** to tune into a higher frequency, or press **<** to tune into a lower frequency.

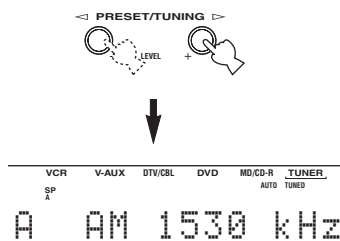

When tuned into a station, the **TUNED** indicator lights up and the frequency of the received station is shown in the front panel display.

### Manual tuning

If the signal from the station you want to select is weak, tune into it manually. Manually tuning into an FM station will automatically switch the tuner to monaural reception to increase the signal quality.

**1 Select TUNER and the reception band following steps 1 and 2 as described in “Automatic tuning”.**

**2 Press TUNING MODE (AUTO/MAN'L MONO) so that the AUTO indicator disappears from the front panel display.**



If a colon (:) appears in the front panel display, tuning is not possible. Press PRESET/TUNING (EDIT) to turn the colon (:): off.

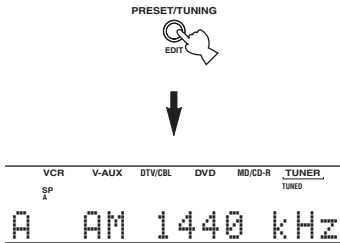

**3 Press PRESET/TUNING </> to tune into the desired station manually.**

Hold down the button to continue searching.



### Presetting stations

#### Automatically presetting FM stations

You can use the automatic preset tuning feature to store FM stations. This function enables this unit to automatically tune into FM stations with strong signals, and to store up to 40 (8 stations in 5 groups, A1 through E8) of those stations in order. You can then recall any preset station easily by selecting the preset station number.

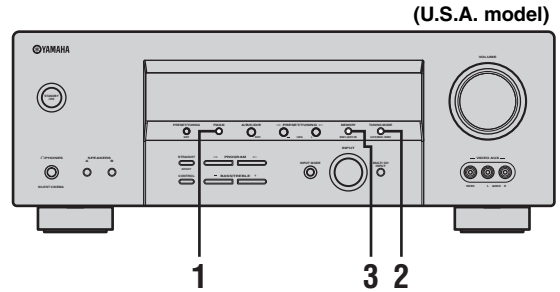

**1 Press FM/AM to select the FM band.**



**2 Press TUNING MODE (AUTO/MAN'L MONO) so that the AUTO indicator lights up in the front panel display.**



If a colon (:) appears in the front panel display, tuning is not possible. Press PRESET/TUNING (EDIT) to turn the colon (:): off.

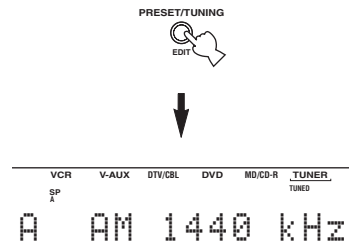

### 3 Press and hold MEMORY (MAN'L/AUTO FM) for more than 3 seconds.

The preset number, the MEMORY and AUTO indicators flash. After about 5 seconds, automatic presetting starts from the frequency currently displayed and proceeds toward the higher frequencies.

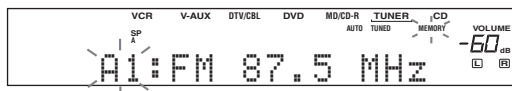

When automatic preset tuning is completed, the front panel display shows the frequency of the last preset station.

#### Notes

- Any stored station data existing under a preset number is cleared when you store a new station under that preset number.
- If the number of the received stations does not reach 40 (E8), automatic preset tuning has automatically stopped after searching all stations.
- Only FM stations with sufficient signal strength are stored automatically by automatic preset tuning. If the station you want to store is weak in signal strength, tune into it manually and store it by following the procedure in “Manually presetting stations”.

#### Automatic preset tuning options

You can select the preset number from which this unit will store FM stations and/or begin tuning toward lower frequencies.

After pressing MEMORY in step 3:

- 1 Press A/B/C/D/E, then PRESET/TUNING </> to select the preset number under which the first station will be stored. Automatic preset tuning will stop when stations have all been stored up to E8.
- 2 Press PRESET/TUNING (EDIT) to turn off the colon (: ) and then press PRESET/TUNING </> to begin tuning toward the lower frequencies.

#### Memory back-up

The memory back-up circuit prevents the stored data from being lost even if this unit is set in the standby mode, the power cord is disconnected from the AC outlet, or the power supply is temporarily cut due to power failure. However, if the power is cut for more than one week, the preset stations may be cleared. If so, store the stations again by using the presetting station methods.

### Manually presetting stations

You can also store up to 40 stations (8 stations x 5 groups) manually.

(U.S.A. model)

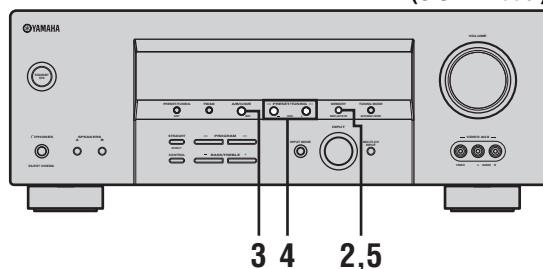

### 1 Tune into a station.

See page 33 for tuning instructions.

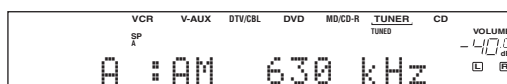

When tuned into a station, the front panel display shows the frequency of the station received.

### 2 Press MEMORY (MAN'L/AUTO FM).

The MEMORY indicator flashes for about 5 seconds.



Flashes

### 3 Press A/B/C/D/E repeatedly to select a preset station group (A to E) while the MEMORY indicator is flashing.

The group letter appears. Check that the colon (: ) appears in the front panel display.

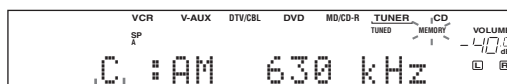

Preset group

- 4 Press PRESET/TUNING  $\triangleleft/\triangleright$  to select a preset station number (1 through 8) while the MEMORY indicator is flashing.**

Press  $\triangleright$  to select a higher preset station number.  
Press  $\triangleleft$  to select a lower preset station number.

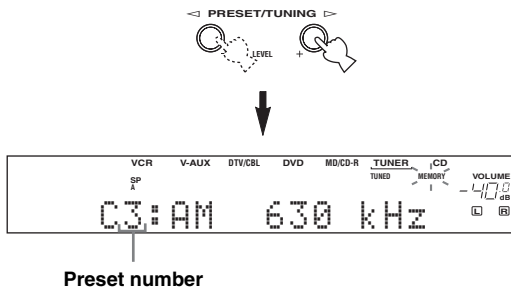

- 5 Press MEMORY (MAN'L/AUTO FM) on the front panel while the MEMORY indicator is flashing.**

The station band and frequency appear in the front panel display with the preset group and number you have selected.

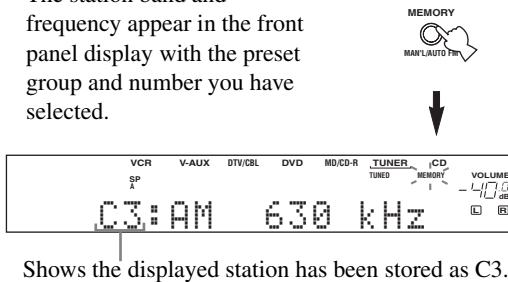

- 6 Repeat steps 1 to 5 to store other stations.**

**Notes**

- Any stored station data existing under a preset number is cleared when you store a new station under that preset number.
- The reception mode (stereo or monaural) is stored along with the station frequency.

**Selecting preset stations**

You can tune any desired station simply by selecting the preset station number under which it was stored.

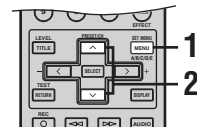
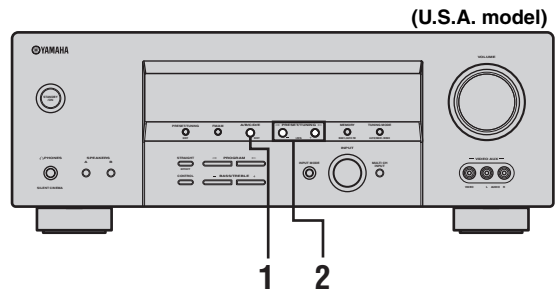

**When performing this operation with the remote control, first press TUNER to set the remote to tuner mode.**

- 1 Press A/B/C/D/E to select the preset station group.**

The preset group letter appears in the front panel display and changes each time you press the button.

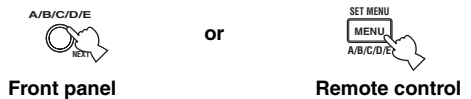

- 2 Press PRESET/TUNING  $\triangleleft/\triangleright$  (PRESET/CH  $\wedge/\vee$  on the remote control) to select a preset station number (1 to 8).**

The preset group and number appear in the front panel display along with the station band, frequency and the TUNED indicator lights up.

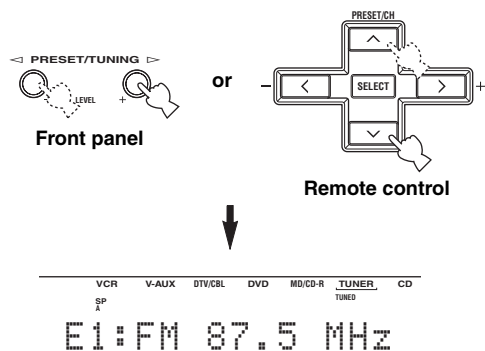



## Exchanging preset stations

You can exchange the assignment of two preset stations with each other. The example below describes the procedure for exchanging preset station “E1” with “A5”.

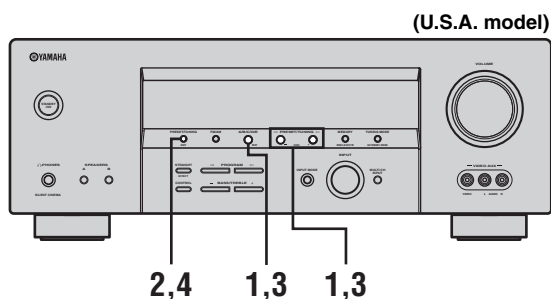

- 1 Select preset station “E1” using A/B/C/D/E and PRESET/TUNING </>.**  
See “Selecting preset stations”.

- 2 Press and hold PRESET/TUNING (EDIT) for more than 3 seconds.**

“E1” and the MEMORY indicator flash in the front panel display.

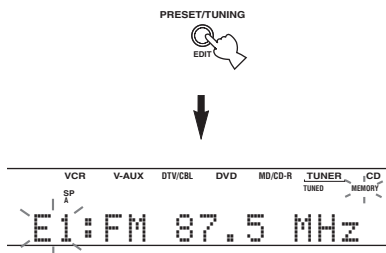

- 3 Select preset station “A5” using A/B/C/D/E and PRESET/TUNING </>.**

“A5” and the MEMORY indicator flash in the front panel display.

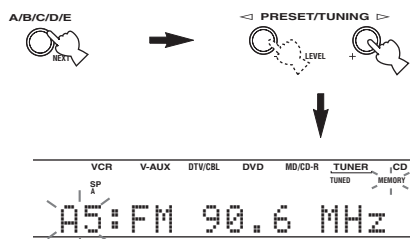

- 4 Press PRESET/TUNING (EDIT) again.**

The stations stored at the two preset assignments are exchanged.

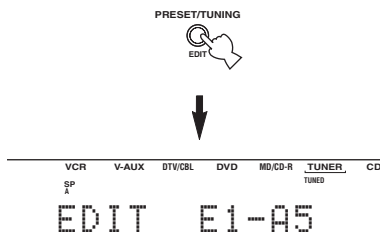

# RECORDING

Recording adjustments and other operations are performed from the recording components. Refer to the operating instructions for those components.

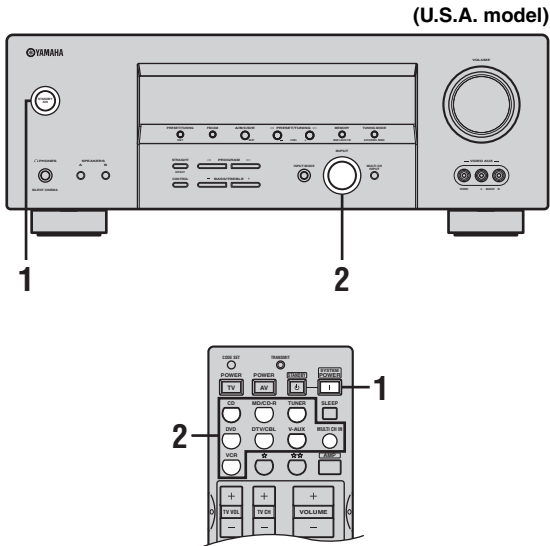

**1 Turn on the power of this unit and all connected components.**

**2 Select the source component you want to record from.**

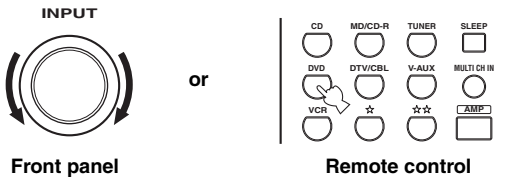

**3 Start playback (or select a broadcast station) on the source component.**

**4 Start recording on the recording component.**



Do a test recording before you start an actual recording.

## Notes

- When this unit is set in the standby mode, you cannot record between other components connected to this unit.
- The setting of CONTROL, VOLUME, “SP LEVEL” (page 47) and the sound field programs does not affect recorded material.
- A source connected to the MULTI CH INPUT jacks of this unit cannot be recorded.
- [ HTR-5750 only ] S-Video and composite video signals pass independently through this unit’s video circuits. Therefore, when recording or dubbing video signals, if your video source component is connected to provide only an S-Video (or only a composite video) signal, you can record only an S-Video (or only a composite video) signal to your VCR.
- [ HTR-5750 ] Digital signals input to the DIGITAL INPUT jacks are not output to the analog AUDIO OUT (L/R) jacks for recording. Likewise, analog signals input to the AUDIO IN (L/R) jacks are not output to the DIGITAL OUTPUT jack. Therefore, if your source component is connected to provide only digital (or analog) signals, you can only record digital (or analog) signals.
- [ HTR-5740 ] Digital signals input to the DIGITAL INPUT jacks are not output to the analog AUDIO OUT (L/R) jacks for recording. You can only record analog signals.
- A given input source is not output on the same REC OUT channel. (For example, the signal input from VCR IN is not output on VCR OUT.)
- Check the copyright laws in your country to record from records, CDs, radio, etc. Recording of copyrighted material may infringe copyright laws.

If you playback a video source that uses scrambled or encoded signals to prevent it from being dubbed, the picture itself may be disturbed due to those signals.

## Special considerations when recording DTS software

The DTS signal is a digital bitstream. Attempting to digitally record the DTS bitstream will result in noise being recorded. Therefore, if you want to use this unit to record sources that have DTS signals recorded on them, the following considerations and adjustments need to be made.

For DVDs and CDs encoded with DTS, when your player is compatible with the DTS format, follow its operating instructions to make a setting so that the analog signal will be output from the player.

# SOUND FIELD PROGRAM DESCRIPTIONS

This unit is equipped with a variety of precise digital decoders that allow you to enjoy multichannel playback from almost any sound source (stereo or multichannel). This unit is also equipped with a YAMAHA digital sound field processing (DSP) chip containing several sound field programs which you can use to enhance your playback experience. Most of these sound field programs are precise digital recreations of actual acoustic environments found in famous concert halls, music venues, and movie theaters.



The YAMAHA CINEMA DSP modes are compatible with all Dolby Digital, DTS, and Dolby Surround sources. Set the input mode to AUTO (see page 31) to enable this unit to automatically switch to the appropriate digital decoder according to the input signal.

## Notes

- This unit's DSP sound field programs are recreations of real-world acoustic environments made from precise measurements taken in the actual hall, etc. Thus you may notice variations in the strength of the reflections coming from the front, back, left and right.
- Feel free to choose a sound field program based on your listening preference, and not purely on the name of the program itself.

## For movie/video sources

You can select from the following sound fields when playing movie or video sources. The sound fields marked "MULTI" can be used with multi-channel sources, like DVD, digital TV, etc. Those marked "2-CH" can be used with 2-channel (stereo) sources like TV programs, video tapes, etc.

Program	Features	Sources
STEREO: 2ch Stereo	Downmixes multi-channel sources to 2 channels (left and right) or plays back 2-channel sources as is.	MULTI 2-CH
MUSIC VIDEO	This program lends an enthusiastic atmosphere to the sound, giving you the feeling you are at an actual jazz or rock concert.	
ENTERTAINMENT: Game	This program adds a deep and spatial feeling to video game sounds.	
TV THEATER: Mono Movie	This program is provided for reproducing monaural video sources (such as old movies). The program produces the optimum reverberation to create sound depth using only the presence sound field.	
TV THEATER: Variety/Sports	Though the presence sound field is relatively narrow, the surround sound field employs the sound environment of a large concert hall. This effect enhances the experience of watching various TV programs such as news, variety shows, music programs or sports programs.	
MOVIE THEATER: Spectacle	CINEMA DSP processing. This program creates the extremely wide sound field of a 70-mm movie theater. It precisely reproduces the source sound in detail, making both the video and the sound field incredibly real. This is ideal for any kind of video source encoded with Dolby Surround, Dolby Digital or DTS (especially large-scale movie productions).	
MOVIE THEATER: Sci-Fi	CINEMA DSP processing. This program clearly reproduces dialog and sound effects in the latest sound form for science fiction films, thus creating a broad and expansive cinematic space amid silence. You can enjoy science fiction films in a virtual-space sound field that includes Dolby Surround, Dolby Digital and DTS-encoded software employing the most advanced techniques.	
MOVIE THEATER: Adventure	CINEMA DSP processing. This program is ideal for precisely reproducing the sound design of the newest 70-mm and multichannel soundtrack films. The sound field is made to be similar to that of the newest movie theaters, so the reverberations of the sound field itself are restrained as much as possible.	
MOVIE THEATER: General	CINEMA DSP processing. This program is for reproducing sounds from 70-mm and multichannel soundtrack films, and is characterized by soft and extensive sound field.	

**SOUND FIELD PROGRAM DESCRIPTIONS**

Program	Features	Sources
DOLBY DIGITAL: SUR. STANDARD	Standard 5.1-channel processing for Dolby Digital sources.	MULTI
DOLBY DIGITAL: SUR. ENHANCED	CINEMA DSP enhanced processing for Dolby Digital sources.	
DOLBY D EX: SUR. STANDARD	Standard 6.1-channel processing for Dolby Digital sources.	
DOLBY D EX: SUR. ENHANCED	CINEMA DSP enhanced 6.1-channel processing (Dolby Digital EX) for Dolby Digital sources.	
DTS: SUR. STANDARD	Standard 5.1-channel processing for DTS sources.	
DTS 96/24: SUR. STANDARD	Standard 5.1-channel processing for 96-kHz/24-bit DTS sources.	
DTS: SUR. ENHANCED	CINEMA DSP enhanced processing for DTS and 96-kHz/24-bit DTS sources.	
DTS+DOLBY EX: SUR. STANDARD	Standard 6.1-channel processing (Dolby Digital EX) for DTS sources.	
DTS+DOLBY EX: SUR. ENHANCED	CINEMA DSP enhanced 6.1-channel processing (Dolby Digital EX) for DTS sources.	
DTS ES Mtr×6.1: SUR. STANDARD	Standard 6.1-channel processing (DTS-ES Matrix) for DTS sources.	
DTS ES Mtr×6.1: SUR. ENHANCED	CINEMA DSP enhanced processing (DTS-ES Matrix) for DTS sources.	
DTS ES Disc6.1: SUR. STANDARD	Standard 6.1-channel processing (DTS-ES Discrete) for DTS sources.	
DTS ES Disc6.1: SUR. ENHANCED	CINEMA DSP enhanced processing (DTS-ES Discrete) for DTS sources.	
PRO LOGIC: SUR. STANDARD	Standard processing for Dolby Surround sources.	2-CH
PRO LOGIC: SUR. ENHANCED	CINEMA DSP enhanced processing for Dolby Surround sources.	
PRO LOGIC IIx: PLIIx Movie	Dolby Pro Logic IIx processing for movie software.*	
PRO LOGIC II: PLII Movie	Dolby Pro Logic II processing for movie software.*	
PRO LOGIC IIx: PLIIx Game	Dolby Pro Logic IIx processing for game software.*	
PRO LOGIC II: PLII Game	Dolby Pro Logic II processing for game software.*	
DTS: Neo:6 Cinema	DTS processing for movie software.	

\* You can select either Pro Logic IIx or Pro Logic II processing using the PLII/PLIIx parameter on page 58.

## For music sources

You can select from the following sound fields when playing music sources, like CD, FM/AM broadcasting, tapes, etc.

Program	Features	Sources
CONCERT HALL	HiFi DSP processing. A classic shoe-box type concert hall with approximately 1700 seats. Pillars and ornate carvings create extremely complex reflections which produce a very full, rich sound.	MULTI 2-CH
JAZZ CLUB	HiFi DSP processing. This is the sound field at stage front in "The Bottom Line", a famous New York jazz club. The floor can seat 300 people to the left and right in a sound field offering a real and vibrant sound.	
ROCK CONCERT	HiFi DSP processing. The ideal program for lively, dynamic rock music. The data for this program was recorded at LA's "hottest" rock club. The listener's virtual seat is at the center-left of the hall.	
ENTERTAINMENT: Disco	HiFi DSP processing. This program recreates the acoustic environment of a lively disco in the heart of a big city. The sound is dense and highly concentrated. It is also characterized by high-energy, "immediate" sound.	
<b>DD</b> D+PLIIx Music: SUR. STANDARD	Standard Dolby Digital and Dolby Pro Logic IIx processing for music sources.	MULTI
<b>DD</b> D+PLIIx Music: SUR. ENHANCED	CINEMA DSP enhanced Dolby Digital and Dolby Pro Logic IIx processing for music sources.	
DTS+PLIIx Music: SUR. STANDARD	Standard DTS and Dolby Pro Logic IIx processing for music sources.	
DTS+PLIIx Music: SUR. ENHANCED	CINEMA DSP enhanced DTS and Dolby Pro Logic IIx processing for music sources.	
STEREO: 2ch Stereo	2-channel (left and right) playback.	2-CH
STEREO: Direct Stereo	Use to output stereo sources to only the front left and right speakers without any processing.	
STEREO: 6ch Stereo	Use to increase the output stereo sources (in stereo) from all speakers. This provides a larger sound field and is ideal for background music at parties, etc.	
PRO LOGIC IIx: PLIIx Music	Dolby Pro Logic IIx processing for music software.*	
PRO LOGIC II: PLII Music	Dolby Pro Logic II processing for music software.*	
DTS: Neo:6 Music	DTS processing for music software.	

\* You can select either Pro Logic IIx or Pro Logic II processing using the PLII/PLIIx parameter on page 58.

# ADVANCED OPERATIONS

## Using the sleep timer

Use this feature to automatically set this unit in the standby mode after a certain amount of time. The sleep timer is useful when you are going to sleep while this unit is playing or recording a source. The sleep timer also automatically turns off any external components connected to the AC OUTLET(S).

### ■ Setting the sleep timer

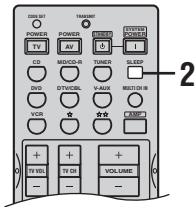

### ■ Canceling the sleep timer

Press SLEEP repeatedly until “SLEEP OFF” appears in the front panel display.

After a few seconds, “SLEEP OFF” disappears, and the SLEEP indicator goes off.

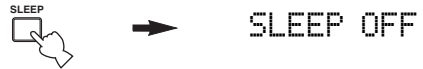

The sleep timer setting can also be canceled by pressing STANDBY on the remote control (or STANDBY/ON on the front panel) to set this unit to the standby mode.

**1 Select a source and start playback on the source component.**

**2 Press SLEEP repeatedly to set the amount of time.**

Each time you press SLEEP, the front panel display changes as shown below. The SLEEP indicator flashes while switching the amount of time for the sleep timer.

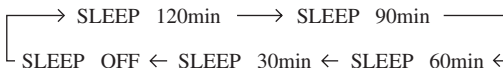

The SLEEP indicator lights up in the front panel display, and the display returns to the selected sound field program.

#### SLEEP indicator



## Manually adjusting speaker levels

You can adjust the output level of each speaker while listening to a music source. This is also possible when playing sources through the MULTI CH INPUT jacks. Please note that this operation will override the level adjustments made in “BASIC SETUP” (page 22), “SP LEVEL” (page 47) and “Using the test tone” (page 43).

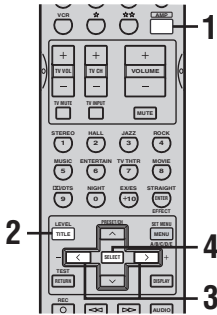

- 1 Press AMP.**
- 2 Press LEVEL repeatedly to select the speaker you want to adjust.**
  - FRONT L Front left speaker level
  - CENTER Center speaker level
  - FRONT R Front right speaker level
  - SUR. R Surround right speaker level
  - SUR. B Surround back speaker level
  - SUR. L Surround left speaker level
  - SUFR Subwoofer level
- 3 Press </> to adjust the speaker output level.**  
The control range is from +10 dB to -10 dB.
- 4 Press SELECT when you have completed your adjustment.**

This operation can also be performed using the controls on the front panel. Press NEXT repeatedly to select the speaker you want to adjust, then press LEVEL +/- to adjust the output level.

## Using the test tone

You can use the test tone feature to manually balance your speaker levels. Please note that this operation will override the level adjustments made in “BASIC SETUP” (page 22), “SP LEVEL” (page 47) and “Manually adjusting speaker levels” (page 43). Use the test tone to set speaker levels so that the volume from each speaker is identical when heard from your listening position.

**Note**

You cannot activate the test tone if headphones are connected to the PHONES jack. Remove the headphones from the PHONES jack.

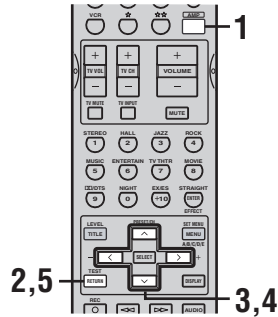

- 1 Press AMP.**
- 2 Press TEST.**  
The unit outputs a test tone.
- 3 Press ^ / v repeatedly to select the speaker you want to adjust.**

TEST LEFT	Front left speaker
TEST CENTER	Center speaker
TEST RIGHT	Front right speaker
TEST SUR. R	Right surround speaker
TEST SUR. B	Surround back speaker
TEST SUR. L	Left surround speaker
TEST SUBWOOFER	Subwoofer
- 4 Press </> to adjust speaker volumes.**
- 5 Press TEST when you have completed your adjustment.**  
The test tone stops.

# SET MENU

You can use the following parameters in SET MENU to adjust a variety of system settings and customize the way this unit operates. Change the initial settings (indicated in bold under each parameter) to reflect the needs of your listening environment.

## ■ BASIC SETUP

Use to quickly setup basic system parameters (see page 22).

## ■ MANUAL SETUP

Use to adjust speaker and system settings.

### 1 SOUND MENU

Use to manually adjust any speaker setting, alter the quality and tone of the sound output by the system or compensate for video signal processing delays when using LCD monitors or projectors.



Most of the parameters described in SOUND MENU are set automatically when you perform “BASIC SETUP” (see page 22). You can use SOUND MENU to make further adjustments.

Item	Features	Page
A)SPEAKER SET	Selects the size of each speaker, the speakers for low-frequency signal output, and the cross over frequency.	46
B)SP LEVEL	Adjusts the output level of each speaker.	47
C)SP DISTANCE	Adjusts the delay time of each speaker.	47
D)CENTER GEQ	Adjusts the tonal quality of the center speaker.	47
E)LFE LEVEL	Adjusts the output level of the LFE channel for Dolby Digital or DTS signals.	47
F)D. RANGE	Adjusts the dynamic range for Dolby Digital or DTS signals.	47
G)AUDIO SET	Customizes the muting level and audio delay.	48

### 2 INPUT MENU

Use to reassign digital input/outputs and select the input mode.

Item	Features	Page
A)I/O ASSIGN	Assigns jacks according to the component to be used.	48
B)INPUT MODE	Selects the initial input mode of the source.	49

### 3 OPTION MENU

Use to adjust the optional system parameters.

Item	Features	Page
A)DISPLAY SET	Adjusts the brightness of the display and converts video signals.	49
B)MEMORY GUARD	Locks sound field program parameters and other SET MENU settings.	49
C)PARAM. INI	Initializes the parameters of a group of sound field programs.	50
D)ZONE SET	Specifies the location of the speakers connected to the SPEAKERS B terminals.	50



## Using SET MENU

Use the remote control to access and adjust each parameter.

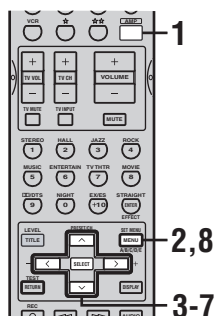

You can change SET MENU parameters while the unit is reproducing sound.

### Note

You cannot change some SET MENU parameters while the unit is in either cinema or music night listening mode.

#### 1 Press AMP.

#### 2 Press SET MENU.

“BASIC SETUP” appears in the front panel display.

#### 3 Press $\wedge$ / $\vee$ to display MANUAL SETUP.

MANUAL SETUP

#### 4 Press SELECT to enter MANUAL SETUP.

1 SOUND MENU appears in the front panel display.

1 SOUND MENU

#### 5 Press $\wedge$ / $\vee$ to display the desired menu.

1 SOUND MENU  
2 INPUT MENU  
3 OPTION MENU

#### 6 Press SELECT to enter the displayed menu.

Repeat steps 5 and 6 to navigate to and enter the items you want to adjust.

To return to the previous menu level, press RETURN.

#### 7 Press $\wedge$ / $\vee$ to select the item you want to adjust, then press $\langle$ / $\rangle$ to change the setting of the item.

Repeat this operation to select and adjust each setting.

To return to the previous menu level, press RETURN.

#### 8 To exit, press SET MENU when finished.

### Memory back-up

The memory back-up circuit prevents the stored data from being lost even if this unit is in the standby mode. However, if the power cord is disconnected from the AC outlet, or the power supply is cut for more than one week, the stored data will be lost. If so, adjust the items again.

## 1 SOUND MENU

Use to manually adjust any speaker setting or compensate for video signal processing delays when using LCD monitors or projectors. Most of the SOUND MENU parameters are set automatically when you perform "BASIC SETUP" (see page 22).

### ■ Speaker set A)SPEAKER SET

Use to manually adjust any speaker setting.



If you are not satisfied with the bass sounds from your speakers, you can change these settings according to your preference.

#### Center speaker CENTER

Choices: LRG, **SML**, NONE

- Select LRG if you have a large center speaker. The unit directs the entire range of the center channel signal to the center speaker.
- Select SML if you have a small center speaker. The unit directs the low-frequency signals of the center channel to the speakers selected with "BASS OUT".
- Select NONE if you do not have a center speaker. The unit directs all of the center channel signal to the front left and right speakers.

#### Front speakers FRONT

Choices: **LARGE**, SMALL

- Select LARGE if you have large front speakers. The unit directs the entire range of the front left and right channel signals to the front left and right speakers.
- Select SMALL if you have small front speakers. The unit directs the low-frequency signals of the front channel to the speakers selected with "BASS OUT".

#### Surround left/right speakers SURR LR

Choices: LRG, **SML**, NONE

- Select LRG if you have large surround left and right speakers. The entire range of the surround channel signal is directed to the surround left and right speakers.
- Select SML if you have small surround left and right speakers. The low-frequency signals of the surround channel are directed to the speakers selected with "BASS OUT".
- Select NONE if you do not have surround speakers. This will set the unit to the Virtual CINEMA DSP mode (see page 31) and automatically set the surround back speaker setting (SURR B) to NONE.

#### Surround back speaker SURR B

Choices: LRG, **SML**, NONE

- Select LRG if you have a large surround back speaker.
- Select SML if you have a small surround back speaker. The low-frequency signals of the surround back channel are directed to the speakers selected with "BASS OUT", and the rest of the frequency signals are directed to the surround back speaker.
- Select NONE if you do not have a surround back speaker. The unit directs all of the surround back channel signal to the surround left and right speakers.

#### Bass out BASS OUT

Low-frequency (bass) signals can be directed to the subwoofer and/or the front left and right speakers according to the characteristics of your system. This setting also determines the routing of the LFE (low-frequency effect) signals found in Dolby Digital or DTS sources.

Choices: SWFR (subwoofer), FRONT, **BOTH**

- Select SWFR if you connect a subwoofer. LFE and low-frequency signals from other channels are directed to the subwoofer according to the speaker settings.
- Select FRONT if you do not use a subwoofer. LFE and low-frequency signals from other channels are directed to the front speakers according to the speaker settings (even if you have previously set the front speakers to SMALL).
- Select BOTH if you connect a subwoofer and you want to output low-frequency signals from front channels to both the front speakers and subwoofer. LFE and low-frequency signals from other channels are also directed to the subwoofer according to the speaker settings. Use this function to reinforce low-frequency signals using the subwoofer when playing back sources such as CDs.

#### Cross over CrossOver

Use this feature to select a cross-over (cut-off) frequency for all low-frequency signals. All frequencies below the selected frequency will be sent to the subwoofer.

Choices: 40Hz, 60Hz, **80Hz**, 90Hz, 100Hz, 110Hz, 120Hz, 160Hz, 200Hz

#### Subwoofer phase SWFR PHASE

If bass sounds are lacking or unclear, use this feature to switch the phase of your subwoofer.

Choices: **NRM** (normal), REV (reverse)

- Select NRM if you do not want to reverse the phase of your subwoofer.
- Select REV to reverse the phase of your subwoofer.

## ■ Speaker level B)SP LEVEL

Use these settings to manually balance the speaker levels between the front left or surround left speakers and each speaker selected in SPEAKER SET (page 46).

Choices: -10.0 dB to +10.0 dB

- **FR** adjusts the balance of the front left and front right speakers.
- **C** adjusts the balance of the front left and center speakers.
- **SL** adjusts the balance of the front left and surround left speakers.
- **SB** adjusts the balance of the surround left and surround back speakers.
- **SR** adjusts the balance of the surround left and surround right speakers.
- **SWFR** adjusts the balance of the front left speaker and subwoofer.



To calibrate, use the test tone feature (see page 43).

## ■ Speaker distance C)SP DISTANCE

Use this feature to manually input the distance of each speaker and adjust the delay applied to respective channel. Ideally, each speaker should be the same distance from the main listening position. However, this is not possible in most home situations. Thus, a certain amount of delay must be applied to the sound from each speaker so that all sound will arrive at the listening position at the same time.

### Unit UNIT

Choices: meters (m), feet (ft)

Initial setting:

U.S.A. and Canada models: feet (ft)

Other models: meters (m)

- Select meters to input speaker distances in meters.
- Select feet to input speaker distances in feet.

### Speaker distances

Choices: 0.3 to 24.00 m (1 to 80 ft)

- **FRONT L** adjusts the distance of the front left speaker. Initial setting: 3.0 m (10.0 ft)
- **FRONT R** adjusts the distance of the front right speaker. Initial setting: 3.0 m (10.0 ft)
- **CENTER** adjusts the distance of the center speaker. Initial setting: 3.0 m (10.0 ft)
- **SURR L** adjusts the distance of the surround left speaker. Initial setting: 3.0 m (10.0 ft)
- **SURR R** adjusts the distance of the surround right speaker. Initial setting: 3.0 m (10.0 ft)
- **SURR B** adjusts the distance of the surround back speaker. Initial setting: 2.10 m (7.0 ft)
- **SWFR** adjusts the distance of the subwoofer. Initial setting: 3.0 m (10.0 ft)

## ■ Center graphic equalizer D)CENTER GEO

Use this feature to adjust the built-in 5-band graphic equalizer for the center channel so that the tonal quality of the center speaker matches that of the left and right main speakers. You can make adjustments listening to the currently selected source component or a test tone.

You can adjust 5 frequency bands:

100Hz, 300Hz, 1kHz, 3kHz, 10kHz

Choices: -6 to +6 dB

- Select ON to output test tones from the front left and center speakers, and adjust the tonal quality of the center speaker.
- Select OFF to stop the test tone and output the currently selected source component.

## ■ Low-frequency effect level E)LFE LEVEL

Use to adjust the output level of the LFE (low-frequency effect) channel according to the capacity of your subwoofer or headphones. The LFE channel carries low-frequency special effects which are only added to certain scenes. This setting is effective only when this unit decodes Dolby Digital or DTS signals.

Choices: -20 to 0 dB

### Speaker SP LFE

Select to adjust the speaker LFE level.

### Headphone HP LFE

Select to adjust the headphone LFE level.

### Note

Depending on the "LFE LEVEL" setting, some signals may not be output from the SUB WOOFER OUTPUT jack.

## ■ Dynamic range F)D. RANGE

Use to select the amount of dynamic range compression to be applied to your speakers or headphones. This setting is effective only when the unit is decoding Dolby Digital and DTS signals.

Choices: **MAX** (maximum), STD (standard), MIN (minimum)

### Speaker SP D.R

Select to adjust the speaker compression.

### Headphone HP D.R

Select to adjust the headphone compression.

- Select MAX for feature films.
- Select STD for general use.
- Select MIN for listening to sources at low volume levels.

## ■ Audio set G)AUDIO SET

Use to customize this unit's overall audio settings.

### Audio mute A.MUTE

Use to adjust how much the mute function reduces the output volume.

Choices: **MUTE**, -20 dB

- Select **MUTE** to completely halt all output of sound.
- Select -20 dB to reduce the current volume by 20 dB.

### Audio delay A.DELAY

Use to delay the sound output and synchronize it with the video image. This may be necessary when using certain LCD monitors or projectors.

Choices: **0** to 160 mS

## 2 INPUT MENU

Use to reassign digital input/outputs and select the input mode.

### ■ Input/output assignment A)I/O ASSIGN

You can assign jacks according to the component to be used if this unit's initial settings do not correspond to your needs. Change the following parameters to reassign the respective jacks and effectively connect more components. Once the inputs have been reassigned, you can select the corresponding component by using **INPUT** on the front panel or the input selector buttons on the remote control.

#### For **COMPONENT VIDEO jacks A (C.V[A]) and B (C.V[B])**

Choices: DVD, V-AUX, DTV/CBL, VCR

#### [ HTR-5750 ]

#### For **OPTICAL OUTPUT jack 1 (OUT<1>)**

Choices: MD/CD-R, CD, V-AUX, DTV/CBL, VCR, DVD

#### For **OPTICAL INPUT jacks 2 (IN<2>), 3 (IN<3>) and 4 (IN<4>)**

Choices: CD, V-AUX, DTV/CBL, VCR, DVD, MD/CD-R

#### For **COAXIAL INPUT jack 5 (IN<5>)**

Choices: CD, V-AUX, DTV/CBL, VCR, DVD, MD/CD-R

#### [ HTR-5740 ]

#### For **OPTICAL INPUT jacks 1 (IN<1>) and 2 (IN<2>)**

Choices: CD, V-AUX, DTV/CBL, VCR, DVD, MD/CD-R

#### For **COAXIAL INPUT jack 3 (IN<3>)**

Choices: CD, V-AUX, DTV/CBL, VCR, DVD, MD/CD-R

### Notes

- You cannot select a specific item more than once for the same type of jack.
- When you connect a component to both the COAXIAL and OPTICAL jacks, priority is given to the input signals from the COAXIAL jack.

### ■ Input mode B)INPUT MODE

Use this feature to designate the input mode for sources connected to the DIGITAL INPUT jacks when you turn on this unit (see page 31 for details about the input mode).

Choices: **AUTO**, **LAST**

- Select **AUTO** to allow this unit to automatically detect the type of input signal and select the appropriate input mode.
- Select **LAST** to set this unit to automatically select the last input mode used for that source.

#### Note

Even if **LAST** is selected, the last setting for the EX/ES button will not be recalled.

## 3 OPTION MENU

Use to adjust the optional system parameters.

### ■ Display set A)DISPLAY SET

#### Dimmer DIMMER

Use to adjust the brightness of the front panel display.

Choices: -4 to **0**

#### Video conversion (HTR-5750 only) V CONU.

Use this feature to turn on/off conversion of composite (VIDEO) signals to S-Video signals. This allows you to output converted video signals from the S VIDEO jacks when no S-Video signals are input.

Choices: **ON**, **OFF**

- Select **OFF** not to convert any signals.
- Select **ON** to convert composite signals to S-Video signals.

#### Note

Converted video signals are only output to the MONITOR OUT jacks. When recording you must make the same type of video connections (i.e., S-Video) between each component.

### ■ Memory guard B)MEMORY GUARD

Use this feature to prevent accidental changes to DSP program parameter values and other system settings.

Choices: **ON**, **OFF**

Select **ON** to protect:

- DSP program parameters
- All SET MENU items
- All speaker levels

When “MEMORY GUARD” is set to **ON**, you cannot use the test tone or select any other SET MENU items.

### ■ Parameter initialization C>PARAM. INI

Use this feature to initialize the parameters for each sound field program within a sound field program group. When you initialize a sound field program group, all of the parameter values within that group revert to their initial settings.

Press the corresponding numeric button for the sound field program that you want to initialize.

An asterisk (\*) next to a program number means that the parameter values have been changed from their initial settings.

#### Notes

- You cannot automatically revert to the previous parameter settings once you initialize a sound field program group.
- You cannot separately initialize individual sound field programs.
- You cannot initialize any program groups when "MEMORY GUARD" is set to ON.

### ■ Zone set D>ZONE SET

Use to specify the location of speakers connected to the SPEAKERS B terminals.

#### Speaker B set SP B

Use this feature to select the location of the front speakers connected to the SPEAKERS B terminals.

Choices: **FRONT**, ZONE B

- Select **FRONT** to turn on/off SPEAKERS A and B when the speakers connected to the SPEAKERS B terminals are set in the main room.
- Select **ZONE B** if the speakers connected to the SPEAKERS B terminals are set in another room. If SPEAKERS A is turned OFF and SPEAKERS B is turned ON, all the speakers including the subwoofer in the main room are muted and the unit outputs sound from SPEAKERS B only.

#### Notes

- If you connect headphones to the PHONES jack on the unit when "SP B" is set to ZONE B, the sound is output from both headphones and SPEAKERS B.
- If a DSP program is selected when "SP B" is set to ZONE B, the unit automatically enters the Virtual CINEMA DSP mode.

# REMOTE CONTROL FEATURES

In addition to controlling this unit, the remote control can also operate other A/V components made by YAMAHA and other manufacturers. To control other components, you must set up remote control with the appropriate manufacturer codes.

## Control area

### ■ Controlling this unit

The shaded areas below can be used to control this unit when the AMP mode is selected. Press AMP to activate the AMP mode.

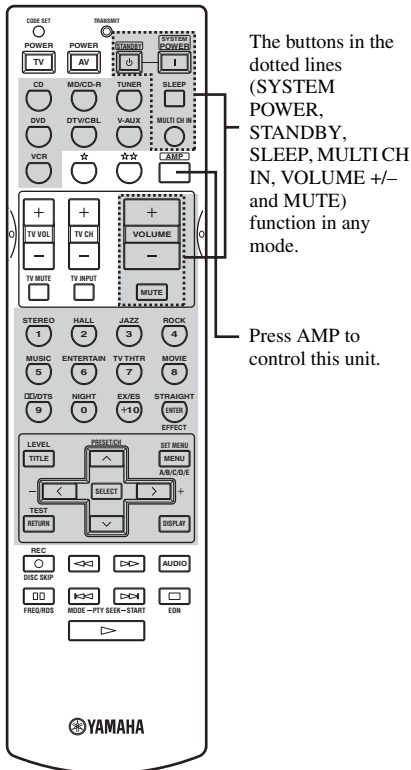

### ■ Controlling other components

The shaded areas below can be used to control other components. Each button has a different function depending on the selected components. Select the component you want to control by pressing an input selector button.

☆☆☆ buttons and the input selector buttons switch the function of the component control area below.

\* Use the ☆/☆☆ buttons to control other components regardless of whether they are connected to this unit.

### Component control area

You can control up to 9 different components by setting appropriate manufacturer codes (see page 52).

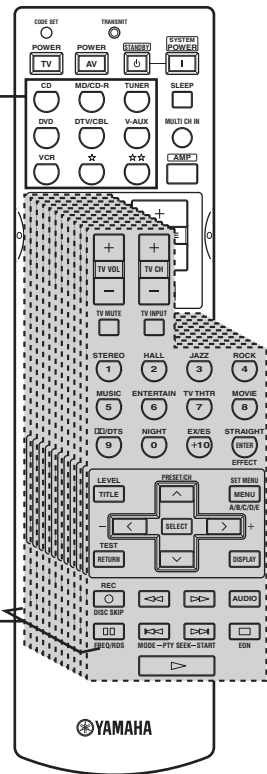

## Setting manufacturer codes

You can control other components by setting the appropriate manufacturer codes. Codes can be set up for each input area. For a complete list of available manufacturer codes, refer to “LIST OF MANUFACTURER CODES” at the end of this manual.

The following table shows the factory preset component (Library: component category) and the manufacturer code for each area.

Input area	Component category (Library)	Manufacturer	Code
CD	CD	YAMAHA	0005
MD/CD-R	MD	YAMAHA	0024
TUNER	TUNER	YAMAHA	0003
DVD	DVD	YAMAHA	0098
DTV/CBL	–	–	–
V-AUX	–	–	–
VCR	–	–	–
☆	–	–	–
☆☆	–	–	–

### Note

You may not be able to operate your YAMAHA component even if a YAMAHA manufacturer code is initially set as listed above. In this case, try to set other YAMAHA manufacturer code(s).

- 1 Press an input selector button or ☆/☆☆ to select the component you want to set up.

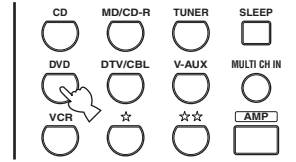

- 2 Press CODE SET using a ballpoint pen or similar object.

The TRANSMIT indicator on the remote control flashes twice.



- 3 Press the numeric buttons to enter the four digit manufacturer’s code for the component to be used.

Refer to “LIST OF MANUFACTURER CODES” at the end of this manual.

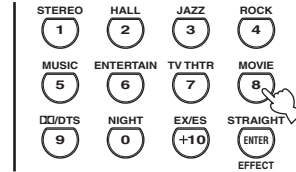

The TRANSMIT indicator on the remote control flashes twice.

### Notes

- If the manufacturer of your component has more than one code, try each of them until you find the correct one.
- If you wait for more than 30 seconds during step 3, the setup process is canceled. If this happens, start over from step 2.



## Controlling other components

Once you set the appropriate manufacturer codes, you can use this remote to control your other components. Note that some buttons may not correctly operate the selected component. Use the input selector buttons to select the component you want to operate. The remote control automatically switches to the appropriate control mode for that component.

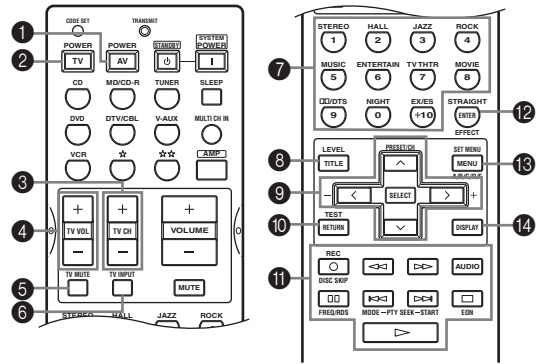

	DVD player/ DVD recorder	VCR	Digital TV/ Cable TV	CD player	MD/CD recorder	Tuner
1 AV POWER	Power *1	Power *1	VCR power *3	Power *1	Power *1	Power *1
2 TV POWER	TV power *2	TV power *2	TV power	TV power *2	TV power *2	TV power *2
3 TV CH + TV CH -	TV channel up *2 TV channel down *2	TV channel up *2 TV channel down *2	TV channel up TV channel down	TV channel up *2 TV channel down *2	TV channel up *2 TV channel down *2	TV channel up *2 TV channel down *2
4 TV VOL + TV VOL -	TV volume up *2 TV volume down *2	TV volume up *2 TV volume down *2	TV volume up TV volume down	TV volume up *2 TV volume down *2	TV volume up *2 TV volume down *2	TV volume up *2 TV volume down *2
5 TV MUTE	TV mute *2	TV mute *2	TV mute	TV mute *2	TV mute *2	TV mute *2
6 TV INPUT	TV input *2	TV input *2	TV input	TV input *2	TV input *2	TV input *2
7 1-9, 0, +10	Numeric buttons	Numeric buttons	Numeric buttons	Numeric buttons	Numeric buttons	Preset stations (1-8)
8 TITLE	Title					
9 PRESET/CH ^ PRESET/CH v PRESET/CH < PRESET/CH >	Up Down Right Left	VCR channel up VCR channel down				Preset up Preset down
10 RETURN	Return					
11 REC/DISC SKIP ▷ ◀◀ ▶▶ AUDIO ⏏ ◀◀◀ ▶▶▶ ◻	Disc skip (player) Rec (recorder) Play Search backward Search forward Audio Pause Skip backward Skip forward Stop	Rec Play Search backward Search forward Pause Pause Skip backward Skip forward Stop	VCR rec *3 VCR play *3 VCR search backward *3 VCR search forward *3 VCR pause *3 VCR stop *3	Play Search backward Search forward Pause Skip backward Skip forward Stop	Rec (MD) Play Search backward Search forward Pause Skip backward Skip forward Stop	
12 ENTER	Title/Index	Enter	Enter	Index	Index	
13 MENU	Menu					A/B/C/D/E
14 DISPLAY	Display		Display	Display	Display	

\*1 This button functions only when the original remote control of the component has a POWER button.

\*2 These buttons can operate your TV without switching the input if the manufacturer code is set in DTV/CBL or ☆☆.

When the manufacturer code for your TV is set up in both the DTV/CBL and ☆☆ areas, priority is given to the signal in the DTV/CBL area.

\*3 These buttons can operate your VCR without switching the input to VCR if the manufacturer code is set in VCR.

## Clearing setup manufacturer codes

### ■ Clearing a setup manufacturer code for component control

- 1 Press an input selector button or ☆/☆☆ to select the component control for which you want to clear the manufacturer code.

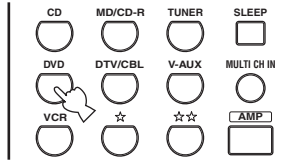

- 2 Press CODE SET using a ballpoint pen or similar object.

The TRANSMIT indicator on the remote control flashes twice.



- 3 If you do not press any button within 30 seconds after step 2, the clearing process is canceled. If this happens, start over from step 1.

- 4 Enter the code number "0000".

The TRANSMIT indicator on the remote control flashes twice, and the manufacturer code for the selected component is cleared.



You can clear all setup manufacturer codes at once by entering the code number "9990".

# EDITING SOUND FIELD PARAMETERS

## What is a sound field

What really creates the rich, full tones of a live instrument are the multiple reflections from the walls of the room. In addition to making the sound “live”, these reflections enable us to tell where the player is situated, and the size and shape of the room in which we are sitting.

### ■ Elements of a sound field

In any environment, in addition to the direct sound coming straight to our ears from the player’s instrument, there are two distinct types of sound reflections that combine to make up the sound field:

#### Early reflections

Reflected sounds reach our ears extremely rapidly (50 ms – 100 ms after the direct sound), after reflecting from one surface only — for example, from the ceiling or a wall. Early reflections actually add clarity to the direct sound.

#### Reverberations

These are caused by reflections from more than one surface — walls, ceiling, the back of the room — so numerous that they merge together to form a continuous sonic “afterglow”. They are non-directional, and lessen the clarity of the direct sound.

Direct sound, early reflections and subsequent reverberation taken together help us to determine the subjective size and shape of the room, and it is this information that the digital sound field processor reproduces in order to create sound fields.

If you could create the appropriate early reflections and subsequent reverberations in your listening room, you would be able to create your own listening environment. The acoustics in your room could be changed to those of a concert hall, a dance floor, or virtually any size room at all. This ability to create sound fields at will is exactly what YAMAHA has done with the digital sound field processor.

## Changing parameter settings

You can enjoy good quality sound with the factory preset parameters. Although you do not have to change the initial settings, you can change some of the parameters to better suit the input source or your listening room.

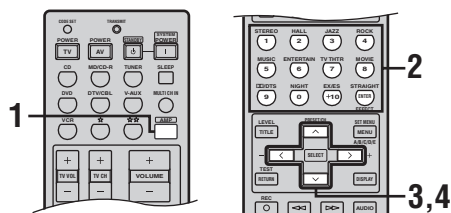

1 Press AMP.



2 Select the sound field program you want to adjust.

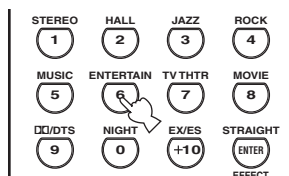

3 Press ^ / v to select the parameters.

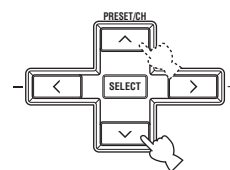

4 Press < / > to change the parameter value.

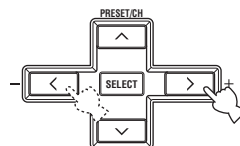

---

**5 Repeat steps 2 through 4 as necessary to change other program parameters.****Note**

You cannot change parameter values when "MEMORY GUARD" is set to ON. If you want to change the parameter values, set "MEMORY GUARD" to OFF (see page 49).

**Memory back-up**

The memory back-up circuit prevents the stored data from being lost even if this unit is set in the standby mode, the power cord is disconnected from the AC outlet, or the power supply is temporarily cut due to power failure. However, if the power is cut for more than one week, the parameter values will return to the factory settings. If this happens, edit the parameter value again.

**■ Resetting parameters to the factory presets****To reset a certain parameter**

Select the parameter you want to reset, then press </> repeatedly to select the factory preset (the display pauses momentarily at the factory preset before proceeding to the next value).

**To reset all parameters**

Use PARAM. INI (see page 50).

# SOUND FIELD PARAMETER DESCRIPTIONS

You can adjust the values of certain digital sound field parameters so the sound fields are recreated accurately in your listening room. Not all of the following parameters are found in every program.

## ■ DSP LEVEL

**Function:** This parameter adjusts the level of all the DSP effect sounds within a narrow range.

**Description:** Depending on the acoustics of your listening room, you may want to increase or decrease the DSP effect level relative to the level of the direct sound.

**Control range:** -6 dB - +3 dB

## ■ DELAY (Delay)

**Function:** This parameter changes the apparent distance from the source sound by adjusting the delay between the direct sound and the first reflection heard by the listener.

**Description:** The smaller the value, the closer the sound source seems to the listener. The larger the value, the farther it seems. For a small room, set to a small value. For a large room, set to a large value.

**Control range:** 1 - 99 msec

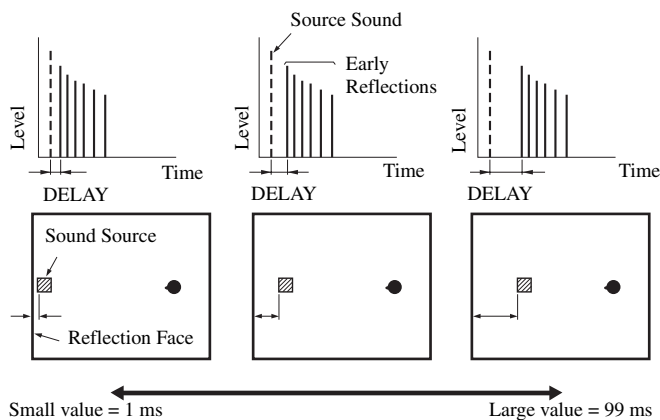

## For 6ch Stereo

**Function:** These parameter adjusts the volume level for each channel in 6-channel stereo mode.

**Control Range:** 0 - 100%

## ■ CT LEVEL (Center level)

## ■ SL LEVEL (Surround left level)

## ■ SR LEVEL (Surround right level)

## ■ SB LEVEL (Surround back level)

**For PRO LOGIC IIx Music and PRO LOGIC II Music****■ PANORAMA**

Function: Extends the front stereo image to include the surround speakers for wraparound effect.

Choices: OFF/ON, initial setting is OFF.

**■ DIMENSION**

Function: Gradually adjusts the sound field either towards the front or towards the rear.

Control range: -3 (towards the rear) to +3 (towards the front), initial setting is STD (standard).

**■ CT WIDTH (Center width)**

Function: Adjusts the center image from all three front speakers to varying degrees. A larger value adjusts the center image towards the front left and right speakers.

Control range: 0 (center channel sound is output only from center speaker) to 7 (center channel sound is output only from front left and right speakers), initial setting is 3.

**For PRO LOGIC IIx Movie, Music and Game****■ PLII/PLIIx (Pro Logic II/Pro Logic IIx)**

Function: Switches the type of Pro Logic decoding to be used. PLII decoding creates 5.1-channel sound from 2-channel sources. PLIIx decoding creates 6.1-channel sound from 2-channel sources.

Choices: PLII, PLIIx

**For DTS Neo:6 Music****■ C. IMAGE (Center image)**

Function: This parameter adjusts the center image from all three front speakers to varying degrees.

Control range: 0 – 0.5

# TROUBLESHOOTING

Refer to the chart below when this unit does not function properly. If the problem you are experiencing is not listed below or if the instruction below does not help, set this unit to the standby mode, disconnect the power cord, and contact the nearest authorized YAMAHA dealer or service center.

## ■ General

Problem	Cause	Remedy	Refer to page
<b>This unit fails to turn on when STANDBY/ON (or SYSTEM POWER) is pressed, or enters in the standby mode soon after the power has been turned on.</b>	The power cord is not connected or the plug is not completely inserted.	Connect the power cord firmly.	—
	The impedance setting is incorrect.	Set the impedance to match your speakers.	20
	The protection circuitry has been activated.	Make sure all speaker wire connections on this unit and on all speakers are secure and that the wire for each connection does not touch anything other than its respective connection.	11-12
	This unit has been exposed to a strong external electric shock (such as lightning and strong static electricity).	Set this unit in the standby mode, disconnect the power cord, plug it back in after 30 seconds, then use it normally.	—
<b>No sound</b>	Incorrect input or output cable connections.	Connect the cables properly. If the problem persists, the cables may be defective.	14-17
	The input mode is set to DTS or ANALOG.	Select AUTO.	31
	No appropriate input source has been selected.	Select an appropriate input source with INPUT, MULTI CH INPUT or the input selector buttons.	25
	Speaker connections are not secure.	Secure the connections.	11
	The front speakers to be used have not been selected properly.	Select the front speakers with SPEAKERS A and/or B.	25
	The volume is turned down.	Turn up the volume.	—
	The sound is muted.	Press MUTE or any operation buttons of this unit to cancel a mute and adjust the volume.	26
	The input mode is set to ANALOG while playing a source encoded with a DTS signal.	Set the input mode to AUTO or DTS.	31
The signals this unit cannot reproduce are being received from a source component e.g.: a CD-ROM.	Play a source whose signals this unit can reproduce.	—	
<b>No picture</b>	The output and input for the picture are connected to different types of video jacks.	Turn on the video conversion function (HTR-5750 only).	49

<b>Problem</b>	<b>Cause</b>	<b>Remedy</b>	<b>Refer to page</b>
<b>The sound suddenly goes off.</b>	The protection circuitry has been activated because of a short circuit, etc.	Check that the impedance selector setting is correct.	20
		Check that the speaker wires are not touching each other and then turn this unit back on.	—
	The sleep timer has turned the unit off.	Turn on the power, and play the source again.	—
	The sound is muted.	Press MUTE to cancel a mute.	26
<b>Only the speaker on one side can be heard.</b>	Incorrect cable connections.	Connect the cables properly. If the problem persists, the cables may be defective.	11
	Incorrect balance settings in SET MENU.	Adjust the SP LEVEL settings.	47
<b>Only the center speaker outputs substantial sound.</b>	When playing a monaural source with a CINEMA DSP program, the source signal is directed to the center channel, and the front and surround speakers output effect sounds.		
<b>No sound from the effect speakers.</b>	The sound field programs are turned off.	Press STRAIGHT (EFFECT) to turn them on.	31
	You are using a source or program combination that does not output sound from all channels.	Try another sound field program.	27, 39
<b>No sound from the center speaker.</b>	The output level of the center speaker is set to minimum.	Raise the level of the center speaker.	47
	“CENTER” in SET MENU is set to NONE.	Select the appropriate setting for the center speaker.	46
	One of the Hi-Fi DSP programs (except for 6ch Stereo) has been selected.	Try another sound field program.	27, 39
<b>No sound from the surround speakers.</b>	The output level of the surround speakers is set to minimum.	Raise the output level of the surround speakers.	47
	“SURR LR” in SET MENU is set to NONE.	Select the appropriate setting for the surround left and right speakers.	46
	A monaural source is being played with STRAIGHT.	Press STRAIGHT (EFFECT) to turn on the sound fields.	—
<b>No sound from the surround back speaker.</b>	“SURR LR” in SET MENU is set to NONE.	If the surround left and right speakers are set to NONE, the surround back speaker setting is automatically set to NONE. Select the appropriate setting for the surround speakers.	46
	“SURR B” in SET MENU is set to NONE.	Select LRG or SML.	46
<b>No sound from the subwoofer.</b>	“BASS OUT” in SET MENU is set to FRONT when a Dolby Digital or DTS signal is being played.	Select SWFR or BOTH.	46
	“BASS OUT” in SET MENU is set to SWFR or FRNT when a 2-channel source is being played.	Select BOTH.	46
	The source does not contain low bass signals.		



Problem	Cause	Remedy	Refer to page
<b>Dolby Digital or DTS sources cannot be played. (Dolby Digital or DTS indicator in the front panel display does not light up.)</b>	The connected component is not set to output Dolby Digital or DTS digital signals.	Make an appropriate setting following the operations instructions for your component.	—
	The input mode is set to ANALOG.	Set the input mode to AUTO or DTS.	31
<b>A “humming” sound can be heard.</b>	Incorrect cable connections.	Firmly connect the audio plugs. If the problem persists, the cables may be defective.	—
<b>The volume level cannot be increased, or the sound is distorted.</b>	The component connected to the OUT (REC) jacks of this unit is turned off.	Turn on the power to the component.	—
<b>The sound effect cannot be recorded.</b>	It is not possible to record the sound effect with a recording component.		
<b>[ HTR-5750 ] A source cannot be recorded by a digital recording component connected to this DIGITAL OUTPUT jack.</b>	The source component is not connected to this unit’s DIGITAL INPUT jacks.	Connect the source component to the DIGITAL INPUT jacks.	13-17, 38
	Some components cannot record the Dolby Digital or DTS sources.		
<b>A source cannot be recorded by an analog component connected to the AUDIO OUT jacks.</b>	The source component is not connected to this unit’s analog AUDIO IN jacks.	Connect the source component to the analog AUDIO IN jacks.	13-17, 38
<b>The sound field parameters and some other settings on this unit cannot be changed.</b>	“MEMORY GUARD” in SET MENU is set to ON.	Select OFF.	49
<b>This unit does not operate properly.</b>	The internal microcomputer has been frozen by an external electric shock (such as lightning or excessive static electricity) or by a power supply with low voltage.	Disconnect the AC power cord from the outlet and then plug it in again after about 30 seconds.	—
<b>“CHECK SP WIRES” appears in the front panel display.</b>	Speaker cables are short circuited.	Make sure all speaker cables are connected correctly.	11
<b>There is noise interference from digital or high-frequency equipment, or this unit.</b>	This unit is too close to the digital or high-frequency equipment.	Move this unit further away from such equipment.	—
<b>The picture is disturbed.</b>	The video source uses scrambled or encoded signals to prevent dubbing.		
<b>This unit suddenly turns into the standby mode.</b>	The internal temperature becomes too high and the overheat protection circuitry has been activated.	Wait about 1 hour for this unit to cool down and then turn it back on.	—

■ **Tuner**

Problem		Cause	Remedy	Refer to page
FM	<b>FM stereo reception is noisy.</b>	The characteristics of FM stereo broadcasts may cause this problem when the transmitter is too far away or the antenna input is poor.	Check the antenna connections. Try using a high-quality directional FM antenna.	18
			Use the manual tuning method.	34
	<b>There is distortion, and clear reception cannot be obtained even with a good FM antenna.</b>	There is multipath interference.	Adjust the antenna position to eliminate multipath interference.	—
	<b>The desired station cannot be tuned in with the automatic tuning method.</b>	The signal is too weak.	Use a high-quality directional FM antenna.	18
			Use the manual tuning method.	34
<b>Previously preset stations can no longer be tuned in.</b>	This unit has been disconnected for a long period.	Preset the stations again.	34	
AM	<b>The desired station cannot be tuned in with the automatic tuning method.</b>	The signal is weak or the antenna connections are loose.	Tighten the AM loop antenna connections and orient it for best reception.	—
			Use the manual tuning method.	34
	<b>There are continuous crackling and hissing noises.</b>	Noises result from lightning, fluorescent lamps, motors, thermostats and other electrical equipment.	Use an outdoor antenna and a ground wire. This will help somewhat, but it is difficult to eliminate all noise.	—
	<b>There are buzzing and whining noises.</b>	A TV set is being used nearby.	Move this unit away from the TV.	—

■ **Remote control**

Problem	Cause	Remedy	Refer to page	
<b>The remote control does not work nor function properly.</b>	Wrong distance or angle.	The remote control will function within a maximum range of 6 m (20 ft) and no more than 30 degrees off-axis from the front panel.	7	
	Direct sunlight or lighting (from an inverter type of fluorescent lamp, etc.) is striking the remote control sensor of this unit.	Reposition this unit.	—	
	The batteries are weak.	Replace all batteries.	3	
	The manufacturer code was not correctly set.		Set the manufacturer code correctly using the “LIST OF MANUFACTURER CODES” at the end of this manual.	52
			Try to set another code for the same manufacturer using the “LIST OF MANUFACTURER CODES” at the end of this manual.	52
	Even if the manufacturer code is correctly set, there are some models that do not respond to the remote control.			

# RESETTING THE FACTORY PRESETS

If you want to reset all of your unit's parameters for any reason, do the following. This procedure completely resets ALL parameters, including the SET MENU, level, assign and tuner presets.

**Be sure this unit is in standby mode.**

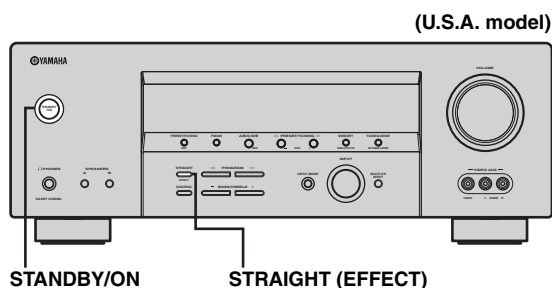

## 1 Hold down STRAIGHT (EFFECT) on the front panel and press STANDBY/ON.

“FACTORY PRESET” appears in the front panel display.



To cancel the initialization procedure without making any changes, press STANDBY/ON.

## 2 Press STRAIGHT (EFFECT) to select the desired setting.

Reset	To reset the unit to its factory presets.
Cancel	To cancel without making any changes.

## 3 Press STANDBY/ON to confirm your selection.

If you selected “Reset”, the unit is reset to its factory presets and switches to standby mode.

If you selected “Cancel”, the unit switches to standby mode and nothing is reset.

## Audio formats

### ■ Dolby Digital

Dolby Digital is a digital surround sound system that gives you completely independent multi-channel audio. With 3 front channels (left, center, and right), and 2 surround stereo channels, Dolby Digital provides 5 full-range audio channels. With an additional channel especially for bass effects, called LFE (low frequency effect), the system has a total of 5.1-channels (LFE is counted as 0.1 channel). By using 2-channel stereo for the surround speakers, more accurate moving sound effects and surround sound environment are possible than with Dolby Surround. The wide dynamic range (from maximum to minimum volume) reproduced by the 5 full-range channels and the precise sound orientation generated using digital sound processing provide listeners with previously unheard of excitement and realism.

With this unit, any sound environment from monaural up to a 5.1-channel configuration can be freely selected for your enjoyment.

### ■ Dolby Digital Surround EX

Dolby Digital EX creates 6 full-bandwidth output channels from 5.1-channel sources. This is done using a matrix decoder that derives 3 surround channels from the 2 in the original recording. For the best results, Dolby Digital EX should be used with movie sound tracks recorded with Dolby Digital Surround EX. With this additional channel, you can experience more dynamic and realistic moving sound especially with scenes with “flyover” and “fly-around” effects.

### ■ Dolby Pro Logic II

Dolby Pro Logic II is an improved technique used to decode vast numbers of existing Dolby Surround software. This new technology enables a discrete 5-channel playback with 2 front left and right channels, 1 center channel, and 2 surround left and right channels (instead of only 1 surround channel for conventional Pro Logic technology). Music and Game modes are also available for 2-channel sources in addition to the Movie mode.

### ■ Dolby Pro Logic IIx

Dolby Pro Logic IIx is a new technology enabling discrete multi-channel playback from 2-channel or multi-channel sources. There is a Music mode for music, a Movie mode for movies (for 2-channel sources only) and a Game mode for games.

### ■ Dolby Surround

Dolby Surround uses a 4 channel analog recording system to reproduce realistic and dynamic sound effects: 2 front left and right channels (stereo), a center channel for dialog (monaural), and a surround channel for special sound effects (monaural). The surround channel reproduces sound within a narrow frequency range.

Dolby Surround is widely used with nearly all video tapes and laser discs, and in many TV and cable broadcasts as well. The Dolby Pro Logic decoder built into this unit employs a digital signal processing system that automatically stabilizes the volume on each channel to enhance moving sound effects and directionality.

### ■ DTS 96/24

DTS 96/24 offers an unprecedented level of audio quality for multi-channel sound on DVD-Video, and is fully backward-compatible with all DTS decoders. “96” refers to a 96 kHz sampling rate (compared to the typical 48 kHz sampling rate). “24” refers to 24-bit word length. DTS 96/24 offers sound quality transparent to the original 96/24 master, and 96/24 5.1-channel sound with full-quality full-motion video for music programs and motion picture soundtracks on DVD-video.

### ■ DTS (Digital Theater Systems) Digital Surround

DTS digital surround was developed to replace the analog soundtracks of movies with a 6-channel digital sound track, and is now rapidly gaining popularity in movie theaters around the world. Digital Theater Systems Inc. has developed a home theater system so that you can enjoy the depth of sound and natural spatial representation of DTS digital surround in your home. This system produces practically distortion-free 6-channel sound (technically, a left, right and center channels, 2 surround channels, plus an LFE 0.1 channel as a subwoofer, for a total of 5.1-channels). The unit incorporates a DTS-ES decoder that enables 6.1-channel reproduction by adding the surround back channel to existing 5.1-channel format.

### ■ Neo:6

Neo:6 decodes the conventional 2-channel sources for 6 channel playback by the specific decoder. It enables playback with the full-range channels with higher separation just like digital discrete signal playback. Two modes are available; “Music mode” for playing music sources and “Cinema mode” for movies.

## Sound field programs

### ■ CINEMA DSP

Since the Dolby Surround and DTS systems were originally designed for use in movie theaters, their effect is best felt in a theater having many speakers and designed for acoustic effects. Since home conditions, such as room size, wall material, number of speakers, and so on, can differ so widely, it's inevitable that there are differences in the sound heard as well. Based on a wealth of actually measured data, YAMAHA CINEMA DSP uses YAMAHA original sound field technology to combine Dolby Pro Logic, Dolby Digital and DTS systems to provide the visual and audio experience of movie theater in the listening room of your own home.

### ■ SILENT CINEMA

YAMAHA has developed a natural, realistic sound effect DSP algorithm for headphones. Parameters for headphones have been set for each sound field so that accurate representations of all the sound field programs can be enjoyed on headphones.

### ■ Virtual CINEMA DSP

YAMAHA has developed a Virtual CINEMA DSP algorithm that allows you to enjoy DSP sound field surround effects even without any surround speakers by using virtual surround speakers. It is even possible to enjoy Virtual CINEMA DSP using a minimal two-speaker system that does not include a center speaker.

## Audio information

### ■ ITU-R

ITU-R is the radio communication sector of the ITU (International Telecommunication Union). ITU-R recommends a standard speaker placement which is used in many critical listening rooms, especially for mastering purposes.

### ■ LFE 0.1 channel

This channel is for the reproduction of low bass signals. The frequency range for this channel is 20 Hz to 120 Hz. This channel is counted as 0.1 because it only enforces a low frequency range compared to the full-range reproduced by the other 5/6 channels in Dolby Digital or DTS 5.1/6.1-channel systems.

### ■ PCM (Linear PCM)

Linear PCM is a signal format under which an analog audio signal is digitized, recorded and transmitted without using any compression. This is used as a method of recording CDs and DVD audio. The PCM system uses a technique for sampling the size of the analog signal per very small unit of time. Standing for "pulse code modulation", the analog signal is encoded as pulses and then modulated for recording.

### ■ Sampling frequency and number of quantized bits

When digitizing an analog audio signal, the number of times the signal is sampled per second is called the sampling frequency, while the degree of fineness when converting the sound level into a numeric value is called the number of quantized bits.

The range of rates that can be played back is determined based on the sampling rate, while the dynamic range representing the sound level difference is determined by the number of quantized bits. In principle, the higher the sampling frequency, the wider the range of frequencies that can be played back, and the higher the number of quantized bits, the more finely the sound level can be reproduced.

## ***Video signal information***

### ■ **Component video signal**

With the component video signal system, the video signal is separated into the Y signal for the luminance and the P<sub>B</sub> and P<sub>R</sub> signals for the chrominance. Color can be reproduced more faithfully with this system because each of these signals is independent. The component signal is also called the “color difference signal” because the luminance signal is subtracted from the color signal. A monitor with component input jacks is required in order to use the component signal for output.

### ■ **Composite video signal**

With the composite video signal system, the video signal is composed of three basic elements of a video picture; color, brightness and synchronization data. A composite video jack on a video component transmits these three elements combined.

### ■ **S-Video signal**

With the S-Video signal system, the video signal normally transmitted using a pin cable is separated and transmitted as the Y signal for the luminance and the C signal for the chrominance through the S-Video cable. Using the S VIDEO jack eliminates video signal transmission loss and allows recording and playback of even more beautiful images.

# SPECIFICATIONS

## AUDIO SECTION

- Minimum RMS Output Power for Front, Center, Surround, Surround back  
20 Hz to 20 kHz, 0.06% THD, 8  $\Omega$  (HTR-5750) ..... 90 W  
(HTR-5740) ..... 85 W
- Maximum Power (EIAJ)  
[China and Korea models]  
1 kHz, 10% THD, 8  $\Omega$  (HTR-5750) ..... 130 W  
(HTR-5740) ..... 125 W
- Dynamic Power (IHF)  
8/6/4/2  $\Omega$  (HTR-5750) ..... 120/155/190/235 W  
(HTR-5740) ..... 115/150/185/230 W
- DIN Standard Output Power [U.K. and Europe models]  
1 kHz, 0.7% THD, 4  $\Omega$  (HTR-5740 only) ..... 130 W
- IEC Output Power [U.K. and Europe models]  
1 kHz, 0.06% THD, 8  $\Omega$  (HTR-5740 only) ..... 95 W
- Damping Factor (IHF)  
20 Hz to 20 kHz, 8  $\Omega$  ..... 100 or more
- Frequency Response  
CD terminal to Front L/R ..... 10 Hz to 100 kHz, -3 dB
- Total Harmonic Distortion  
CD, etc. to Front L/R (20 Hz to 20 kHz, 40 W, 8  $\Omega$ ) ..... 0.06%
- Signal to Noise Ratio (IHF-A Network)  
CD (250 mV) to Front L/R, Effect Off ..... 100 dB
- Residual Noise (IHF-A Network)  
Front L/R ..... 150  $\mu$ V or less
- Channel Separation (1 kHz/10 kHz)  
CD (5.1 k $\Omega$  terminated) to Front L/R ..... 60 dB/45 dB
- Tone Control (Front L/R)  
BASS Boost/Cut .....  $\pm$ 10 dB/60 Hz  
TREBLE Boost/Cut .....  $\pm$ 10 dB/20 kHz
- Phones Output ..... 150 mV/100  $\Omega$
- Input Sensitivity/Input Impedance  
CD, etc. .... 200 mV/47 k $\Omega$   
MULTI CH INPUT ..... 200 mV/47 k $\Omega$
- Output Level/Output Impedance  
REC OUT ..... 200 mV/1.2 k $\Omega$   
SUB WOOFER ..... 4 V/1.2 k $\Omega$

## VIDEO SECTION

- Video Signal Type ..... PAL/NTSC
- Signal to Noise Ratio ..... 50 dB
- Frequency Response (MONITOR OUT)  
Composite ..... 5 Hz to 10 MHz, -3 dB  
Component ..... 5 Hz to 60 MHz, -3 dB  
S-Video (HTR-5750 only) ..... 5 Hz to 10 MHz, -3 dB

## FM SECTION

- Tuning Range  
[U.S.A. and Canada models] ..... 87.5 to 107.9 MHz  
[Other models] ..... 87.5 to 108.0 MHz
- Usable Sensitivity (IHF)..... 1.0  $\mu$ V (11.2 dBf)
- Signal to Noise Ratio (IHF)  
Mono/Stereo ..... 76 dB/70 dB
- Harmonic Distortion (1 kHz)  
Mono/Stereo ..... 0.2%/0.3%
- Stereo Separation (1 kHz) ..... 42 dB
- Frequency Response ..... 20 Hz to 15 kHz, +0.5, -2 dB

## AM SECTION

- Tuning Range  
[U.S.A. and Canada models] ..... 530 to 1710 kHz  
[Other models] ..... 531 to 1611 kHz
- Usable Sensitivity ..... 300  $\mu$ V/m

## GENERAL

- Power Supply  
[U.S.A. and Canada models] ..... AC 120 V, 60 Hz  
[Australia model] ..... AC 240 V, 50 Hz  
[China model] ..... AC 220 V, 50 Hz  
[Korea model] ..... AC 220 V, 60 Hz  
[U.K. and Europe models] ..... AC 230 V, 50 Hz
- Power Consumption  
[U.S.A. and Canada models] ..... 350 W/440 VA  
[Other models] ..... 360 W
- Standby Power Consumption ..... 0.1 W
- AC Outlets  
[U.K. and Australia models] ..... 1 (Total 100 W maximum)  
[Other models] ..... 2 (Total 100 W maximum)
- Dimension (W x H x D)..... 435 x 161 x 416 mm  
(17-1/8" x 6-3/8" x 16-3/8")
- Weight ..... 11 kg (24 lbs 4 oz)

# LIST OF MANUFACTURER CODES

<b>TV</b>	DAYTRON	0941, 1031	JBL	0101	NECKERMANN	1001
A TANDY	DECCA	0271, 1001	JCB	0951	NEI	1001
ABEX	DIXI	0331, 1001, 1071	JENSEN	0311	NIKKAI	0271, 0431, 1001, 1151
ADMIRA	DUMONT	0891, 1031	JINXING	1531, 1541, 1551, 1561, 1571, 1621, 1631, 1641, 1651, 1691, 1731	NIKKO	0861, 1111, 1121
ADVENTURA	DYNATECH	0881			NOVABEAM	0721
AIKO	ELECTROBAND	0951, 1011			NTC	1121
AIWA	ELECTROHOME	0941	JVC (VICTOR)	0261, 0281, 0641, 0651, 0661, 0841	ONWA	1051
AKAI	ELIN	1001			OPTIMUS	0551
ALBA	ELTA	0331	KAWASHO	0901	OPTONICA	0541, 1141
ALLERON	EMERSON	0001, 0021, 0061, 0071, 0081, 0091, 0111, 0811, 0821, 0831, 0841, 0851, 0861, 0871, 0901, 0921, 0941, 0981, 1011, 1031, 1051, 1081, 1091	KAYPANI	1021	ORION	0831, 1001
AMBASSADOR			KENWOOD	0361, 1031, 1111	OSAKI	0271, 1151
AMSTRAD			KLOSS	0631, 0721, 1131	OTTO VERSAND	1001
ANAM			KTV	0921, 0941, 1011, 1051, 1111	PANASONIC	0101, 0191, 0251, 0751, 1041, 1311, 1371, 1431
ANAM NATIONAL			LEYCO	1001		
AOC			LG (GOLDSTAR)	0031, 0121, 0351, 0411, 0731, 0741, 0861, 0941, 0971, 1001, 1031, 1111, 1151	PANDA	1541, 1721
ARCHER	ENVISION	0361, 1111			PENNY	0161, 0361, 0521, 0531, 0621, 0731, 0751, 0761, 0781, 0791, 0861, 0931, 0941, 1031, 1041, 1111, 1151, 1161
AUDIOSONIC	ERRES	1001	LLOYTRON	0941	PEONY	1561, 1621
AUDIOVOX	ETRON	0331	LOEWE	1001	PHILCO	0361, 0581, 0591, 0601, 0611, 0631, 0961, 1031, 1111
BAUER	FERGUSON	1001	LIESENK & TTER	1001		
BAUR	FINLUX	1001			PHILIPS	0101, 0401, 1001
BEIJING	FISHER	0171, 0801, 0981			PHONOLA	1001
BELCOR	FORMENTI	0441	LLOYTRON	0941	PILOT	0941, 1031, 1111
BELL & HOWELL	FORMONTI	1001	LOGIK	0991, 1771	PIONEER	0511, 0551, 0871
BEON	FORMORESS	1141	LUXMAN	0351, 0971	PORTLAND	0941, 1031, 1121
BRADFORD	FUJITSU	1091	LXI	0101, 0621, 0761, 0861, 0981	PRICECLUB	0931
BROCKWOOD	FUNAI	1051, 1091, 1501, 1521			PRISM	0751
BROKSONIC			MAGNAVOX	0101, 0341, 0391, 0401, 0411, 0421, 0581, 0591, 0601, 0611, 0631, 0661, 0961, 1111	PROSCAN	0761
BUSH	FUTURETECH	1051			PROTECH	1001
CANDLE	GE	0131, 0161, 0201, 0751, 0761, 0771, 0781, 0791, 0811, 0861, 1041	MAJESTIC	0991	PROTON	0501, 0861, 0941, 1021, 1161
CAPEHART			MARANTZ	0101, 0221, 0361, 1001, 1111	PULSAR	0891
CARVER	GEC	0271, 1001			PULSER	1031
CATHAY	GEMINI	0391	MARK	1001	QUASAR	0251, 0751, 1041
CELEBRITY	GENEXXA	0431	MATSUI	0271, 0331, 1001	QUELLE	1001
CENTURION	GIBRALTER	0891, 1031, 1111	MEDIATOR	1001	RADIO SHACK	0541, 0941, 1031, 1051, 1151
CHANGHONG	GOODMANS/TASHIKO	0271, 0661, 1001	MEGATRON	0691, 0861, 1161		
	GRANADA	1001	MEI	1011	RADIOLA	1001
CITIZEN	GRUNDIG	1781, 1791, 1801, 1811, 1821, 1831, 1841, 1851, 1861, 1871, 1881	M-ELECTRONIC	1001	RCA	0051, 0141, 0151, 0181, 0411, 0491, 0531, 0761, 0771, 0871, 1031
			MEMOREX	0331, 0571, 0861, 0971, 0981, 0991, 1771	REALISTIC	0541, 0861, 0941, 0971, 0981, 1031, 1051, 1111, 1151
CLAIRTONE	GUNPY	1051, 1091	METZ	1791, 1831, 1891, 1901, 1911, 1921, 1931, 1941	RHAPSODY	1011
CLARIVOX	HARMAN/KARDON	0721			R-LINE	1001
CONCERTO	HALLMARK	0861	MGA	0361, 0561, 0571, 0861, 1031, 1111	RUNCO	0891, 1111
CONROWA	HANSEATIC	1001			SAISHO	0331, 1081
CONTEC	HARVARD	1051, 1061	MIDLAND	0751, 0761, 0891, 0941, 1151	SAMPO	0361, 0941, 1021, 1111, 1151
CORANDO	HINARI	1001, 1091			SAMSUNG	0331, 0341, 0351, 0361, 0861, 0931, 0941, 0971, 1001, 1031, 1111, 1151
CRAIG	HITACHI	0181, 0351, 0671, 0681, 0691, 0701, 0711, 0871, 0941, 0971, 1351	MITSUBISHI	0221, 0321, 0561, 0571, 0661, 0861, 1031, 1101, 1381	SAMSUX	0941
CROWN						
CURTIS MATHES	HYPSON	1001	MONTGOMERY	1091		
	IMA	1051	MOTOROLA	1041, 1141		
CXC	INDIANA	1001	MTC	0351, 0361, 0881, 0931, 0971, 1011, 1031, 1111		
DAEWOO	INFINITY REFERENCE	0101				
			MULTITECH	0881, 1051		
	INTERFUNK	1001	NAD	0551, 0621, 0861		
DANSAI	ITT	0611	NEC	0241, 0351, 0361, 0661, 0971, 1031, 1111, 1321, 1711		
	JANEIL	1131				



SANYO 0171, 0231, 0271,  
0661, 0801, 0911,  
0981, 1231, 1251,  
1261

SBR 1001

SCHEIDER 1001

SCIMITSU 1031

SCOTCH 0861

SCOTT 0831, 0861, 0941,  
1031, 1051, 1091

SEARS 0101, 0161, 0171,  
0351, 0481, 0521,  
0621, 0761, 0801,  
0861, 0971, 0981,  
1091

SHANGHAI 1561, 1681

SHARP 0461, 0471, 0541,  
0661, 0911, 0941,  
1141

SHOGUN 1031

SIGNATURE 0991, 1771

SIMPSON 0581, 0961

SOLAVOX 1151

SONOKO 1001

SONTEC 1001

SONY 0371, 0451, 0661,  
0841, 0951, 1281,  
1441

SOUNDESIGN 0861, 0961, 1051,  
1091

SOUNDWAVE 1001

SPECTRICON 1161

SQUAREVIEW 0481

SSS 1031, 1051

STAR-LITE 1051

SUPREM 0951

SUPRE-MACY 1131

SURPA 0351, 0971

SYLVANIA 0101, 0361, 0441,  
0581, 0591, 0601,  
0611, 0631, 0961,  
1111

SYMPHONIC 0481

SYSLINE 1001

TANDY 0271, 0431, 1141

TATUNG 0271, 0881, 1001,  
1041, 1161

TCL 1561, 1631, 1701

TECHNICS 0751

TECHWOOD 0351, 0751, 0971

TEKNIKA 0101, 0351, 0571,  
0931, 0941, 0961,  
0971, 0991, 1031,  
1051, 1091, 1121,  
1131, 1771

TELETECH 0331

TERA 0501

THAKRAL 1671

THORM 1001

TMK 0351, 0861, 0971,  
1081

TOSHIBA 0381, 0521, 0621,  
0661, 0931, 0981,  
1301

TOSONIC 1011

TOTEVISION 0941

TRICAL 0911

UNIVERSAL 0781, 0791

UNIVERSUM 1001

VECTOR RESEARCH  
0361, 1111

VESTEL 1001

VIDEO CONCEPT 1101

VIDIKRON 0101, 0211

VIDTECH 0861, 1031

VIKING 1131

WARDS 0101, 0361, 0451,  
0541, 0581, 0591,  
0601, 0611, 0771,  
0781, 0791, 0861,  
0971, 0991, 1031,  
1091, 1111, 1771

WATSON 1001

XOGEGO 1611, 1621, 1661,  
1741, 1761

YAMAHA 0361, 1031, 1111

YOKO 1001

ZENITH 0011, 0041, 0891,  
0991, 1771

ZONDA 1161

### CABLE TV

ABC 0256, 0376

ANTRONIX 0136

ARCHER 0136, 0286

BBT 0076

CABLETIME 0166

CABLEVISION 0196

COLOUR VOICE 0306, 0346

COMTRONICS 0216, 0276

EAGLE COMTRONICS  
0276

EASTERN 0066

ELECTRICORD 0206

ELECTUS 0266

GE 0116, 0126

GEC CABLE SYSTEM  
0196

HAMLIN H5 0676

HAMLIN H6 0666

HAMLIN H6S 0656

HAMLIN H8 0646

HAMLIN H9 0636

JERROLD 0256

JERROLD 400L 0626

JERROLD 450L 0616

JERROLD 550 0606

JERROLD OSD CATV  
0596

JERROLD SPRUCER  
0436

MAGNAVOX/PHILIPS  
0416, 0426

MAMM 0296

MEMOREX 0386

MOVIE TIME 0146, 0206

NORTHCOAST 0016

NSC 0146

OAK 0106

OAK SIGMA 450 0546

OAK SIGMA 550 0536

PANASONIC TZ 120/130  
0476

PANASONIC TZ 170/180  
0446

PANASONIC TZ140 0466

PANASONIC TZ150/160  
0456

PARAGON 0386

PHILIPS 0036, 0216, 0306,  
0316, 0326, 0336,  
0346

PIONEER 0006, 0086

PIONEER BR50 0846

PIONEER BR60/70/80/81/82  
0696

PIONEER BR90 0556

PULSAR 0386

RCA DIGITAL SATELLITE  
SYSTEM 0396, 0406

REALISTIC 0136

REGENCY/EASTERN0686

RUNCO 0386

SAMSUNG 0276

SCIENTIFIC ATLANTA 175/475  
0576

SCIENTIFIC ATLANTA 75  
0366, 0586

SCIENTIFIC ATLANTA 8650  
0566

SIGNAL 0276

SL MARX 0276

SPECTAVISION 0236

STANDARD COMPONENTS  
0186

STARCOM V 0256

STARGATE 0276

SYLVANIA/TEXSCAN  
0376, 0496

TEKNIKA 0176

TELESERVICE 0056

TELEVIEW 0276

TEXSCAN 0186, 0376

TFC 0026

TOCOM 0226, 0356

TOCOM 5503A 0526

TOCOM 5503VIP/5507  
0516

TOCOM TC56 0506

TOSHIBA 0386

TUDI 0046

UNIKA 0136

UNIVERSAL 0136, 0156, 0206,  
0286

VIDEOWAY 0096

VIEWSTAR 0216

ZENITH 0246, 0386, 0486

### SATELLITE TUNER

ALPHA STAR 0826

CHAPARRAL 0756

ECHOSTAR 0836

GENERAL INSTRUMENT  
0776, 0876

HTS 0836

HUGHES NETWORK SYSTEMS  
0816

JERROLD 0776, 0786

PANASONIC 0806

PRIMESTAR 0776, 0786

RCA 0766

SONY 0796

### (DBS)

HITACHI 0856

MAGNAVOX 0886

MEMOREX 0886

PANASONIC 0896

PHILIPS 0886

SONY 0906

STAR CHOICE 0876

TOSHIBA 0866, 0916

UNIDEN 0886

### VCR

A TANDY 0902

ADVENTURA 0992

AIKO 0982

AIWA 0992

AKAI 0262, 0942, 0952,  
0962, 0972

AMERICAN HIGH 0932

AMSTRAD 0992

ASA 0002, 0912

ASHA 0922

AUDIO DYNAMICS 0202

AUDIOVOX 0912

BEAUMARK 0922

BELL & HOWELL 0902

BLAUPUNKT 0412

BROKSONIC 0872, 0882, 0892

BUSH 0852

CALIX 0912

CANON 0862, 0932

CCE 0852, 0982

CITIZEN 0912, 0982

COLT 0852

CRAIG 0832, 0842, 0852,  
0912, 0922

CURTIS MATHES 0662, 0822,  
0932

CYBERNEX 0922

DAEWOO 0802, 0812, 0982

DBX 0202

DYNATECH 0472, 0992

ELECTROHOME 0912

ELECTROPHONIC 0912

EMEREX 0792

EMERSON 0072, 0132, 0142,  
0152, 0162, 0172,  
0182, 0192, 0212,  
0702, 0712, 0722,  
0732, 0742, 0752,  
0762, 0772, 0782,  
0872, 0882, 0892,  
0912, 0952, 0992,  
1072

FINLUX 0002, 0992

FISHER 0682, 0692, 0842,  
0902

FUJI 0672, 0932

FUNAI 0992

GARRARD 0992

GE 0662, 0822, 0932

GO VIDEO 0642, 0652

GOODMANS 0402

GRADIENTE 0992

GRANDA 0612, 0902

GRUNDIG 0002

HARLEY DAVIDSON  
0992

HARMAN/KARDON		PROSCAN	1002, 1012, 1022, 1032, 1042, 1052, 1062	YAMAHA	0202, 0632	ALPINE	1215, 1305
	0632, 1082			ZENITH	0042, 0362, 0512, 0672	AUDIO-TECHNICA	0545
HARWOOD	0752, 0852					BSR	0245, 0655, 0775
HEADQUARTER	0612	PULSAR	0512			CALIFORNIA AUDIO LAB	
HI-Q	0842	QUARTER	0612				0055
HINARI	0852	QUARTZ	0272, 0612	<b>DVD PLAYER</b>		CAPETRONIC	1205
HITACHI	0102, 0562, 0572, 0582, 0592, 0602, 0992	QUASAR	0382, 0392, 0932	AKAI	0058	CARRERA	0245
		RADIO SHACK	0912, 0992	AIWA	0218	CARVER	0285, 1135
ITT	0942	RADIX	0912	DENON	0188	CASIO	0345
JVC (VICTOR)	0202, 0522, 0532, 0542, 0552	RANDEX	0912	HITACHI	0198	CROWN	0185
		RCA	0112, 0382, 0392, 0482, 0592, 0602, 0662, 0822, 0942	JVC (VICTOR)	0088, 0178	CURTIS MATHES	0345
KENWOOD	0202, 0542, 0612, 0632, 0902	REALISTIC	0402, 0472, 0612, 0682, 0842, 0902, 0912, 0922, 0932, 0992	KENWOOD	0148	DENON	0275, 0875, 0885
				LG (GOLDSTAR)	0228	DEUAL (E)	0505
KLH	0852			MAGNAVOX	0128	DYNAMIC BASS (H)	
KODAK	0912, 0932			PHILIPS	0138		0555
LG (GOLDSTAR)	0082, 0632, 0912	RICOH	0352, 0362	ONKYO	0068, 0128	EMERSON	0205, 0325, 1105
		SAISHO	0212, 0582, 0722, 0732, 0742, 0772	PANASONIC	0028	EROICA	1275
LLOYD	0992			PHILIPS	0098, 0128	FISHER	0095, 0555, 0925, 1005
LOGIK	0852	SALORA	0612, 0762	PIONEER	0108, 0118		
LUXOR	0942	SAMSUNG	0212, 0312, 0922, 0962	PROSCAN	0158	GARRARD	0365
LXI	0022, 0912			RCA	0158	GENEXXA	0305, 0325, 1105
MAGNAVOX	0002, 0482, 0492, 0502, 0512, 0932	SANKY	0472, 0512	SAMSUNG	0078	HARMAN/KARDON	0105, 0175, 0465, 0995
		SANSUI	0292, 0542, 0832	SHARP	0038		
MAGNIN	0922	SANYO	0242, 0612, 0842, 0902, 0922	SONY	0018	HITACHI	0195, 0205, 0505, 0815
MARANTZ	0002, 0202, 0402, 0632, 0932	SBR	0002, 0282	TECHNICS	0028	INKEL	0115, 0395
		SCHEIDER	0852	THOMSON	0168	JVC (VICTOR)	0315
MARTA	0912	SCOTT	0342, 0712, 0762, 0872, 0882, 0892	TOSHIBA	0048, 0128	KENWOOD	0045, 0095, 0405, 0585, 0725, 0735, 0745, 0755, 0895
MATSUSHITA	0932	SEARS	0302, 0592, 0602, 0612, 0682, 0692, 0842, 0902, 0912, 0932	YAMAHA	0008, 0028, 0098		
MATSUI	0722			ZENITH	0128		
MEI	0222, 0932	SHARP	0402, 0472			KYOCERA	0025
MEMOREX	0232, 0242, 0472, 0512, 0612, 0842, 0902, 0912, 0922, 0932, 0992	SHINTOM	0852	<b>DVD RECORDER</b>		LG (GOLDSTAR)	1135, 1225, 1265, 1335
		SHOGUN	0922	PANASONIC	0238, 0248, 0258		
MGA	0762, 0952	SINGER	0852	PHILIPS	0208	LUXMAN	0075, 0425, 0675, 0705, 0715, 0985
MGA TECHNOLOGY	0922	SONY	0032, 0332, 0352, 0362, 0672, 0792, 0932	PIONEER	0278, 0288, 0298	MAGNAVOX	0165, 0215, 0645, 0955
MINOLTA	0592, 0602	STS	0602	TOSHIBA	0268		
MITSUBISHI	0452, 0462, 0542, 0762, 0952, 1082	SUNPAK	0352	YAMAHA	0208	MARANTZ	0215, 0235, 0375, 0785, 1345
		SYLVANIA	0002, 0492, 0502, 0762, 0932, 0992			MCINTOSH	0355, 1085
MOTOROLA	0472, 0932	SYMPHONIC	0992	<b>LD PLAYER</b>		MCS	0905, 1315
MTC	0922, 0992	TANDY	0992	AIWA	0157	MEMOREX	0205, 0225, 0235, 0305, 0325, 1105
MULTITECH	0852, 0992	TASHIKO	0712, 0992	DENON	0147		
NAD	0442	TEAC	0992	DISCO VISION	0017	MGA	0135
NEC	0122, 0202, 0292, 0422, 0432, 0542, 0632	TECHNICS	0932	FUNAI	0157	MISSION	0215
		TEKNIKA	0322, 0912, 0932, 0992	HITACHI (E)	0017	MITSUBISHI	0135, 0445
NIKKO	0912	TELEFUNKEN	0252	KENWOOD	0087, 0107	MTC	1255
NOBLEX	0922	TMK	0212, 0732, 0772, 0922	MAGNAVOX	0027	NAD	0035, 0615, 0685, 0695
OLYMPUS	0412, 0932	TOSHIBA	0062, 0302, 0342, 0622, 0682, 0712, 0762	MARANTZ	0027	NAKAMICHI	0125, 0435, 0515
OPTIMUS	0442, 0472, 0912	TOTEVISION	0912, 0922	NAKAMICHI	0137	NEC	0255, 0905, 0965
OPTONICA	0402	UNITECH	0922	PANASONIC	0077, 0177	NIKKO	0545, 1005
ORION	0212, 0722, 0742, 0772	VECTOR RESEARCH	0202, 0432, 0632	PHILIPS	0027	ONKYO	0155, 0455, 0495, 0805, 1155
				PIONEER	0017, 0037, 0137	OPTIMUS	0225, 0245, 0555, 0595, 0845, 0855, 0865, 0895, 0935
OSAKI	0912	VIDEO CONCEPTS	0202, 0432, 0632, 0952	RCA	0167		
PANASONIC	0012, 0052, 0092, 0222, 0372, 0382, 0392, 0412, 0932	WARDS	0322, 0402, 0472, 0482, 0602, 0712, 0842, 0852, 0922, 0932, 0992	REALISTIC	0157	PANASONIC	0055, 0825, 1095, 1125
				SHARP	0127		
PENNY	0202, 0432, 0602, 0632, 0692, 0912, 0922, 0932			SONY	0047, 0057, 0117	PENNY	0905
				VICTOR	0097	PHILIPS	0165, 0215
PENTAX	0592, 0602			YAMAHA	0007, 0067	PIONEER	0305, 0935, 1045
PERDIO	0992					PROTON	0215, 1185
PHILCO	0002, 0932			<b>CD PLAYER</b>		QUASAR	0055
PHILIPS	0002, 0282, 0402, 0492, 0932			ACOUSTIC RESEARCH		RCA	0205, 0915, 1115
					1295	REALISTIC	0205, 0225, 0235, 0325, 0555, 0845
PILOT	0912			ADC	0025, 0065	REVOX	1175
PIONEER	0442, 0542			ADCOM	0205, 0255, 1015	ROTEL	0215
				ADS	0265	SABA TELECOMMANDER (E)	0505
				AIWA	0295, 0945, 1035, 1055		
				AKAI	0175, 0485, 0535		

SAE	0215	OPTIMUS	0034, 0064, 0204,
SAMSUNG	1285		0334
SANSUI	0215, 0625, 0975,	ONKYO	0364, 0374
	1025, 1105	PHILIPS	0094
SANYO	0145, 0555, 0635,	PIONEER	0034, 0044, 0064
	0765	REVOX	0354
SCOTT	0325, 1105	SANSUI	0094, 0344
SEARS	0345	SHARP	0264
SHARP	0235, 0665, 0895,	SHERWOOD	0334
	1065, 1075	SONY	0054, 0084, 0324
SHERWOOD	0115, 0235, 0395,	TEAC	0194, 0254
	0475	TECHNICS	0074, 0314
SIEMENS GARRARD		WARDS	0034
	1245	YAMAHA	0004, 0014, 0104,
SIGNATURE	0175		0114, 0164, 0174,
SONTEC	1165		0264
SONY	0065, 0565, 0865,		
	1145		
STARON	1235		
STS	0025		
SYLVANIA	0215		
SYMPHONIC	0335		
TANDY	0305		
TANGBERG	1195		
TEAC	0235, 0335, 0385,		
	0525, 0795, 0835,		
	1355		
TECHNICS	0055, 0605, 1095		
TECHWOOD	1325		
TELEFUNKEN (E)	0505		
THOMSON (E)	0505		
TOSHIBA	0035, 0685		
VECTOR RESEARCH			
	0065, 1135		
WARDS	0175		
YAMAHA	0005, 0015, 0085,		
	0415, 0545, 0575,		
	1065		

---

## CD RECORDER

HITACHI	0474
JVC (VICTOR)	0504
MARANTZ	0484, 0494
PHILIPS	0444
PIONEER	0454
YAMAHA	0414

---

## MD RECORDER

KENWOOD	0384
PIONEER	0424
SHARP	0434
SONY	0394
YAMAHA	0024, 0394, 0404,
	0514

---

## TAPE DECK

AIWA	0094, 0214, 0224
AKAI	0184
CARVER	0094
DENON	0304
FISHER	0144
GARRARD	0194, 0204
JVC (VICTOR)	0274, 0284, 0294
KENWOOD	0124, 0134, 0154,
	0234, 0244, 0264
MAGNAVOX	0094
MARANTZ	0094, 0344
MITSUBISHI	0184



© 2004 YAMAHA CORPORATION All rights reserved.

**YAMAHA ELECTRONICS CORPORATION, USA** 6660 ORANGETHORPE AVE., BUENA PARK, CALIF. 90620, U.S.A.  
**YAMAHA CANADA MUSIC LTD.** 135 MILNER AVE., SCARBOROUGH, ONTARIO M1S 3R1, CANADA  
**YAMAHA ELECTRONIK EUROPA G.m.b.H.** SIEMENSSTR. 22-34, 25462 RELLINGEN BEI HAMBURG, F.R. OF GERMANY  
**YAMAHA ELECTRONIQUE FRANCE S.A.** RUE AMBROISE CROIZAT BP70 CROISSY-BEAUBOURG 77312 MARNE-LA-VALLEE CEDEX02, FRANCE  
**YAMAHA ELECTRONICS (UK) LTD.** YAMAHA HOUSE, 200 RICKMANSWORTH ROAD WATFORD, HERTS WD18 7GQ, ENGLAND  
**YAMAHA SCANDINAVIA A.B.** J A WETTERGRENS GATA 1, BOX 30053, 400 43 VÄSTRA FRÖLUNDA, SWEDEN  
**YAMAHA MUSIC AUSTRALIA PTY, LTD.** 17-33 MARKET ST., SOUTH MELBOURNE, 3205 VIC., AUSTRALIA

**YAMAHA CORPORATION**  
Printed in Malaysia ◀ WC85350