



# *HTR-5950*

---

*AV Receiver*

OWNER'S MANUAL

# IMPORTANT SAFETY INSTRUCTIONS

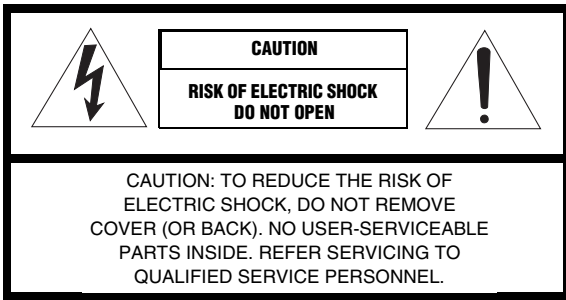

## • Explanation of Graphical Symbols

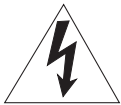

The lightning flash with arrowhead symbol, within an equilateral triangle, is intended to alert you to the presence of uninsulated “dangerous voltage” within the product’s enclosure that may be of sufficient magnitude to constitute a risk of electric shock to persons.



The exclamation point within an equilateral triangle is intended to alert you to the presence of important operating and maintenance (servicing) instructions in the literature accompanying the appliance.

- 1** Read Instructions – All the safety and operating instructions should be read before the product is operated.
- 2** Retain Instructions – The safety and operating instructions should be retained for future reference.
- 3** Heed Warnings – All warnings on the product and in the operating instructions should be adhered to.
- 4** Follow Instructions – All operating and use instructions should be followed.
- 5** Cleaning – Unplug this product from the wall outlet before cleaning. Do not use liquid cleaners or aerosol cleaners.
- 6** Attachments – Do not use attachments not recommended by the product manufacturer as they may cause hazards.
- 7** Water and Moisture – Do not use this product near water – for example, near a bath tub, wash bowl, kitchen sink, or laundry tub; in a wet basement; or near a swimming pool; and the like.
- 8** Accessories – Do not place this product on an unstable cart, stand, tripod, bracket, or table. The product may fall, causing serious injury to a child or adult, and serious damage to the product. Use only with a cart, stand, tripod, bracket, or table recommended by the manufacturer, or sold with the product. Any mounting of the product should follow the manufacturer’s instructions, and should use a mounting accessory recommended by the manufacturer.
- 9** A product and cart combination should be moved with care. Quick stops, excessive force, and uneven surfaces may cause the product and cart combination to overturn.
- 10** Ventilation – Slots and openings in the cabinet are provided for ventilation and to ensure reliable operation of the product and to protect it from overheating, and these openings must not be blocked or covered. The openings should never be blocked by placing the product on a bed, sofa, rug, or other similar surface. This product should not be placed in a built-in installation such as a bookcase or rack unless proper ventilation is provided or the manufacturer’s instructions have been adhered to.
- 11** Power Sources – This product should be operated only from the type of power source indicated on the marking label. If you are not sure of the type of power supply to your home, consult your product dealer or local power company. For products intended to operate from battery power, or other sources, refer to the operating instructions.
- 12** Grounding or Polarization – This product may be equipped with a polarized alternating current line plug (a plug having one blade wider than the other). This plug will fit into the power outlet only one way. This is a safety feature. If you are unable to insert the plug fully into the outlet, try reversing the plug. If the plug should still fail to fit, contact your electrician to replace your obsolete outlet. Do not defeat the safety purpose of the polarized plug.
- 13** Power-Cord Protection – Power-supply cords should be routed so that they are not likely to be walked on or pinched by items placed upon or against them, paying particular attention to cords at plugs, convenience receptacles, and the point where they exit from the product.
- 14** Lightning – For added protection for this product during a lightning storm, or when it is left unattended and unused for long periods of time, unplug it from the wall outlet and disconnect the antenna or cable system. This will prevent damage to the product due to lightning and power-line surges.
- 15** Power Lines – An outside antenna system should not be located in the vicinity of overhead power lines or other electric light or power circuits, or where it can fall into such power lines or circuits. When installing an outside antenna system, extreme care should be taken to keep from touching such power lines or circuits as contact with them might be fatal.
- 16** Overloading – Do not overload wall outlets, extension cords, or integral convenience receptacles as this can result in a risk of fire or electric shock.
- 17** Object and Liquid Entry – Never push objects of any kind into this product through openings as they may touch dangerous voltage points or short-out parts that could result in a fire or electric shock. Never spill liquid of any kind on the product.
- 18** Servicing – Do not attempt to service this product yourself as opening or removing covers may expose you to dangerous voltage or other hazards. Refer all servicing to qualified service personnel.
- 19** Damage Requiring Service – Unplug this product from the wall outlet and refer servicing to qualified service personnel under the following conditions:
  - a)** When the power-supply cord or plug is damaged,
  - b)** If liquid has been spilled, or objects have fallen into the product,
  - c)** If the product has been exposed to rain or water,



- d) If the product does not operate normally by following the operating instructions. Adjust only those controls that are covered by the operating instructions as an improper adjustment of other controls may result in damage and will often require extensive work by a qualified technician to restore the product to its normal operation,
  - e) If the product has been dropped or damaged in any way, and
  - f) When the product exhibits a distinct change in performance - this indicates a need for service.
- 20 Replacement Parts** – When replacement parts are required, be sure the service technician has used replacement parts specified by the manufacturer or have the same characteristics as the original part. Unauthorized substitutions may result in fire, electric shock, or other hazards.
- 21 Safety Check** – Upon completion of any service or repairs to this product, ask the service technician to perform safety checks to determine that the product is in proper operating condition.
- 22 Wall or Ceiling Mounting** – This unit should be mounted to a wall or ceiling only as recommended by the manufacturer.
- 23 Heat** – The product should be situated away from heat sources such as radiators, heat registers, stoves, or other products (including amplifiers) that produce heat.

- 24 Outdoor Antenna Grounding** – If an outside antenna or cable system is connected to the product, be sure the antenna or cable system is grounded so as to provide some protection against voltage surges and built-up static charges. Article 810 of the National Electrical Code, ANSI/NFPA 70, provides information with regard to proper grounding of the mast and supporting structure, grounding of the lead-in wire to an antenna discharge unit, size of grounding conductors, location of antenna discharge unit, connection to grounding electrodes, and requirements for the grounding electrode.

EXAMPLE OF ANTENNA GROUNDING

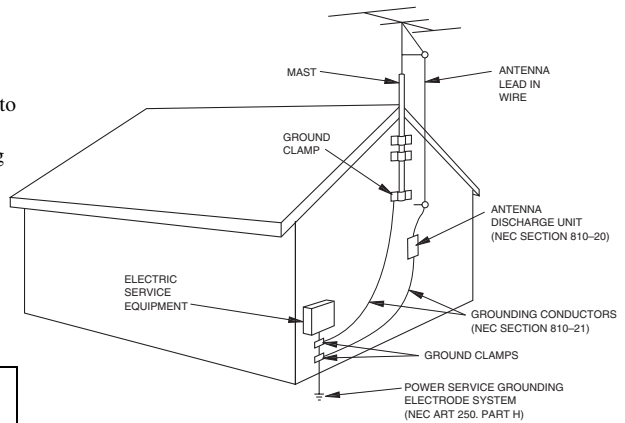

NEC – NATIONAL ELECTRICAL CODE

**Note to CATV system installer:**

This reminder is provided to call the CATV system installer's attention to Article 820-40 of the NEC that provides guidelines for proper grounding and, in particular, specifies that the cable ground shall be connected to the grounding system of the building, as close to the point of cable entry as practical.

**FCC INFORMATION (for US customers)**

**1 IMPORTANT NOTICE: DO NOT MODIFY THIS UNIT!**

This product, when installed as indicated in the instructions contained in this manual, meets FCC requirements. Modifications not expressly approved by Yamaha may void your authority, granted by the FCC, to use the product.

- 2 IMPORTANT:** When connecting this product to accessories and/or another product use only high quality shielded cables. Cable/s supplied with this product **MUST** be used. Follow all installation instructions. Failure to follow instructions could void your FCC authorization to use this product in the USA.

- 3 NOTE:** This product has been tested and found to comply with the requirements listed in FCC Regulations, Part 15 for Class "B" digital devices. Compliance with these requirements provides a reasonable level of assurance that your use of this product in a residential environment will not result in harmful interference with other electronic devices.

This equipment generates/uses radio frequencies and, if not installed and used according to the instructions found in the users manual, may cause interference harmful to the operation of other electronic devices.

Compliance with FCC regulations does not guarantee that interference will not occur in all installations. If this product is found to be the source of interference, which can be determined by turning this unit "OFF" and "ON", please try to eliminate the problem by using one of the following measures:

Relocate either this product or the device that is being affected by the interference.

Utilize power outlets that are on different branch (circuit breaker or fuse) circuits or install AC line filter/s.

In the case of radio or TV interference, relocate/reorient the antenna. If the antenna lead-in is 300 ohm ribbon lead, change the lead-in to coaxial type cable.

If these corrective measures do not produce satisfactory results, please contact the local retailer authorized to distribute this type of product. If you can not locate the appropriate retailer, please contact Yamaha Electronics Corp., U.S.A. 6660 Orangethorpe Ave, Buena Park, CA 90620.

The above statements apply **ONLY** to those products distributed by Yamaha Corporation of America or its subsidiaries.

# CAUTION: READ THIS BEFORE OPERATING YOUR UNIT.

- 1 To assure the finest performance, please read this manual carefully. Keep it in a safe place for future reference.
- 2 Install this sound system in a well ventilated, cool, dry, clean place – away from direct sunlight, heat sources, vibration, dust, moisture, and/or cold. Allow ventilation space of at least 30 cm on the top, 20 cm on the left and right, and 20 cm on the back of this unit.
- 3 Locate this unit away from other electrical appliances, motors, or transformers to avoid humming sounds.
- 4 Do not expose this unit to sudden temperature changes from cold to hot, and do not locate this unit in an environment with high humidity (i.e. a room with a humidifier) to prevent condensation inside this unit, which may cause an electrical shock, fire, damage to this unit, and/or personal injury.
- 5 Avoid installing this unit where foreign object may fall onto this unit and/or this unit may be exposed to liquid dripping or splashing. On the top of this unit, do not place:
  - other components, as they may cause damage and/or discoloration on the surface of this unit.
  - burning objects (i.e. candles), as they may cause fire, damage to this unit, and/or personal injury.
  - containers with liquid in them, as they may fall and liquid may cause electrical shock to the user and/or damage to this unit.
- 6 Do not cover this unit with a newspaper, tablecloth, curtain, etc. in order not to obstruct heat radiation. If the temperature inside this unit rises, it may cause fire, damage to this unit, and/or personal injury.
- 7 Do not plug in this unit to a wall outlet until all connections are complete.
- 8 Do not operate this unit upside-down. It may overheat, possibly causing damage.
- 9 Do not use force on switches, knobs and/or cords.
- 10 When disconnecting the power cable from the wall outlet, grasp the plug; do not pull the cord.
- 11 Do not clean this unit with chemical solvents; this might damage the finish. Use a clean, dry cloth.
- 12 Only voltage specified on this unit must be used. Using this unit with a higher voltage than specified is dangerous and may cause fire, damage to this unit, and/or personal injury. YAMAHA will not be held responsible for any damage resulting from use of this unit with a voltage other than specified.
- 13 To prevent damage by lightning, keep the power cable and outdoor antennas disconnected from a wall outlet or this unit during a lightning storm.
- 14 Do not attempt to modify or fix this unit. Contact qualified YAMAHA service personnel when any service is needed. The cabinet should never be opened for any reasons.
- 15 When not planning to use this unit for long periods of time (i.e. vacation), disconnect the AC power plug from the wall outlet.
- 16 Install this unit near the AC wall outlet where the power cable plug can be reached easily.
- 17 Be sure to read the “TROUBLESHOOTING” section on common operating errors before concluding that this unit is faulty.
- 18 Before moving this unit, press STANDBY/ON to set this unit to the standby mode, and then disconnect the power cable from the AC wall outlet.

## WARNING

TO REDUCE THE RISK OF FIRE OR ELECTRIC SHOCK, DO NOT EXPOSE THIS UNIT TO RAIN OR MOISTURE.

This unit is not disconnected from the AC power source as long as it is connected to the wall outlet, even if this unit itself is set to the standby mode. In this state, this unit is designed to consume a very small quantity of power.

## FOR CANADIAN CUSTOMERS

To prevent electric shock, match wide blade of plug to wide slot and fully insert.  
This Class B digital apparatus complies with Canadian ICES-003.

## IMPORTANT

Please record the serial number of this unit in the space below.  
MODEL:  
Serial No.:  
The serial number is located on the rear panel of this unit. Retain this Owner’s Manual in a safe place for future reference.

## We Want You Listening For A Lifetime

YAMAHA and the Electronic Industries Association’s Consumer Electronics Group want you to get the most out of your equipment by playing it at a safe level. One that lets the sound come through loud and clear without annoying blaring or distortion – and, most importantly, without affecting your sensitive hearing.

Since hearing damage from loud sounds is often undetectable until it is too late, YAMAHA and the Electronic Industries Association’s Consumer Electronics Group recommend you to avoid prolonged exposure from excessive volume levels.



# CONTENTS

## INTRODUCTION

<b>FEATURES</b> .....	<b>2</b>
<b>GETTING STARTED</b> .....	<b>3</b>
Supplied accessories .....	3
Installing batteries in the remote control .....	3
<b>CONTROLS AND FUNCTIONS</b> .....	<b>4</b>
Front panel.....	4
Remote control.....	6
Front panel display .....	9
Rear panel .....	11

## PREPARATION

<b>CONNECTIONS</b> .....	<b>12</b>
Placing speakers.....	12
Connecting speakers .....	13
Information on jacks and cable plugs .....	16
Audio and video signal flow.....	17
Connecting a TV.....	18
Connecting a DVD player, a DVD recorder, a VCR or an STB.....	19
Connecting a CD player, an MD player or a tape deck .....	21
Connecting a YAMAHA iPod universal dock .....	22
Connecting a multi-format player or an external decoder .....	23
Connecting a game console, a video camera or a portable audio player .....	23
Connecting the FM and AM antennas .....	24
Connecting the power cable.....	25
Setting the speaker impedance.....	26
Turning on this unit or setting it to the standby mode.....	27
<b>BASIC SETUP</b> .....	<b>28</b>

## BASIC OPERATION

<b>PLAYBACK</b> .....	<b>31</b>
<b>USING AUDIO FEATURES</b> .....	<b>33</b>
Using SILENT CINEMA .....	33
Muting the audio output.....	33
Selecting the night listening mode.....	33
Selecting the input mode .....	34
Using the sleep timer .....	34
Adjusting the speaker level.....	35
Selecting the Compressed Music Enhancer mode .....	36
Selecting the MULTI CH INPUT component.....	37
Enjoying multi-channel sources in 2-channel stereo.....	38
Enjoying unprocessed input sources.....	38
Enjoying pure hi-fi stereo sound.....	38
<b>USING VIDEO FEATURES</b> .....	<b>39</b>
Displaying the input source information .....	39
Selecting the OSD mode.....	40
Playing video sources in the background .....	40

<b>ENJOYING SURROUND SOUND</b> .....	<b>41</b>
Enjoying multi-channel sources in surround .....	41
Enjoying 2-channel sources in surround.....	42
Using Virtual CINEMA DSP .....	43
<b>RECORDING</b> .....	<b>44</b>
<b>FM/AM TUNING</b> .....	<b>45</b>
Automatic tuning .....	45
Manual tuning.....	46
Automatic preset tuning.....	47
Manual preset tuning .....	48
Selecting preset stations.....	49
Exchanging preset stations .....	50
<b>XM® SATELLITE RADIO TUNING</b> .....	<b>52</b>
Connecting the XM Connect-and-Play digital antenna accessory.....	52
XM Satellite Radio controls and functions.....	53
Activating XM Satellite Radio .....	54
Basic XM Satellite Radio operations.....	55
Selecting the XM Satellite Radio search mode .....	56
Setting the XM Satellite Radio preset channels .....	60
Displaying the XM Satellite Radio information .....	61

## SOUND FIELD PROGRAMS

<b>SOUND FIELD PROGRAMS</b> .....	<b>63</b>
Selecting sound field programs .....	63
Sound field program descriptions.....	64
Changing sound field parameter settings.....	66
Sound field program speaker layouts .....	72

## ADVANCED OPERATION

<b>SET MENU</b> .....	<b>75</b>
Using SET MENU .....	77
1 SOUND MENU.....	78
2 INPUT MENU.....	83
3 OPTION MENU .....	85
<b>ADVANCED SETUP</b> .....	<b>88</b>
<b>REMOTE CONTROL FEATURES</b> .....	<b>90</b>
Controlling this unit, a TV, or other components .....	90
Setting the remote control code .....	92
Setting library codes .....	93
Resetting all remote control codes.....	94
<b>USING iPod®</b> .....	<b>95</b>
Setting the remote control code .....	95
Controlling iPod .....	95
<b>RESETTING THE SYSTEM</b> .....	<b>97</b>

## ADDITIONAL INFORMATION

<b>TROUBLESHOOTING</b> .....	<b>98</b>
<b>GLOSSARY</b> .....	<b>103</b>
Audio information .....	103
Video information.....	104
Sound field program information .....	105
<b>SPECIFICATIONS</b> .....	<b>106</b>

INTRODUCTION

PREPARATION

BASIC OPERATION

SOUND FIELD PROGRAMS

ADVANCED OPERATION

ADDITIONAL INFORMATION

# FEATURES

## Built-in 6-channel power amplifier

- ◆ Minimum RMS output power (0.7% THD, 1 kHz, 8 Ω)  
Front: 110 W + 110 W  
Center: 110 W  
Surround: 110 W + 110 W  
Surround back: 110 W

## Sound field programs

- ◆ Proprietary YAMAHA technology for the creation of sound fields
- ◆ Dolby Digital/Dolby Digital EX decoder
- ◆ DTS/DTS-ES Matrix 6.1, Discrete 6.1, DTS Neo:6, DTS 96/24 decoder
- ◆ Dolby Pro Logic/Dolby Pro Logic II/Dolby Pro Logic IIx decoder
- ◆ Neural Surround decoder (U.S.A. and Canada models only)
- ◆ Virtual CINEMA DSP
- ◆ SILENT CINEMA™

## Sophisticated AM/FM tuner

- ◆ 40-station random and direct preset tuning
- ◆ Automatic preset tuning
- ◆ Preset station shifting capability (preset editing)

## XM Satellite Radio (U.S.A. model only)

- ◆ XM Satellite Radio tuning capability (using the “XM Connect-and-Play digital antenna accessory” sold separately)
- ◆ Neural Surround decoder to play back the surround sound content of the XM Satellite Radio broadcasts in multi-channels, resulting in a full surround sound experience

## Notes

-  indicates a tip for your operation.
- Some operations can be performed by using either the buttons on the front panel or the ones on the remote control. In case the button names differ between the front panel and the remote control, the button name on the remote control is given in parentheses.
- This manual is printed prior to production. Design and specifications are subject to change in part as a result of improvements, etc. In case of differences between the manual and product, the product has priority.



Manufactured under license from Dolby Laboratories. “Dolby”, “Pro Logic”, and the double-D symbol are trademarks of Dolby Laboratories.



Manufactured under license from Digital Theater Systems, Inc. “DTS”, “DTS-ES”, “NEO:6”, and “DTS 96/24” are trademarks of Digital Theater Systems, Inc. Copyright 1996, 2003 Digital Theater Systems, Inc. All right reserved.

## iPod®

“iPod” is a trademark of Apple Computer, Inc., registered in the U.S. and other countries.

## iPod controlling capability

- ◆ DOCK terminal to connect a YAMAHA iPod universal dock (such as YDS-10 sold separately), which supports iPod (Click and Wheel), iPod nano, and iPod mini

## Other features

- ◆ 192-kHz/24-bit D/A converter
- ◆ OSD (on-screen display) menus that allow you to optimize this unit to suit your individual audiovisual system
- ◆ 6 additional input jacks for discrete multi-channel input
- ◆ S-video signal input/output capability
- ◆ Component video input/output capability (3 COMPONENT VIDEO INs and 1 MONITOR OUT)
- ◆ Digital video signal conversion (composite video ↔ S-video → component video) capability for monitor out
- ◆ Optical and coaxial digital audio signal jacks
- ◆ Sleep timer
- ◆ Cinema and music night listening modes
- ◆ Remote control with preset remote control codes, backlighting input selector buttons, and an iPod (stationed in a YAMAHA iPod universal dock connected to the DOCK terminal) controlling capability
- ◆ PORTABLE mini analog input jack on the front panel for a portable audio player
- ◆ Compressed Music Enhancer mode to improve the sound quality of compression artifacts (such as the MP3 format) to that of a high-quality stereo

SILENT™  
CINEMA

“SILENT CINEMA” is a trademark of YAMAHA CORPORATION.



The XM name and related logos are registered trademarks of XM Satellite Radio Inc.



Neural Surround™ name and related logos are trademarks owned by Neural Audio Corporation.

# GETTING STARTED

## Supplied accessories

Check that you received all of the following parts.

### Remote control

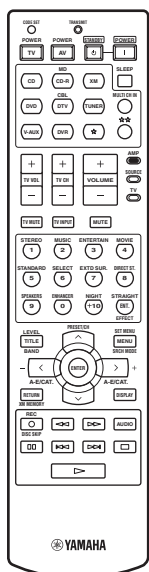

### Batteries (2) (AA, R6, UM-3)

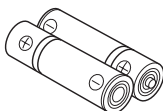

### AM loop antenna



### Indoor FM antenna (U.S.A., Canada and China models)

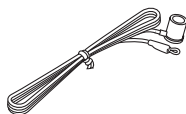

### Indoor FM antenna (Australia model)

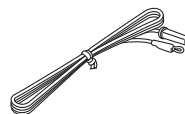

## Installing batteries in the remote control

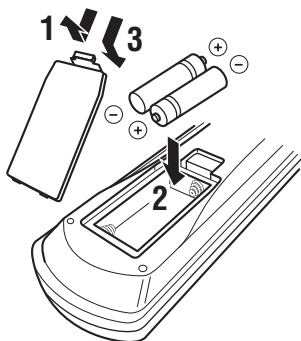

**1** Take off the battery compartment cover.

**2** Insert the two supplied batteries (AA, R6, UM-3) according to the polarity markings (+ and -) on the inside of the battery compartment.

**3** Snap the battery compartment cover back into place.

### Notes

- Change all of the batteries if you notice the following conditions:
  - the operation range of the remote control decreases.
  - the TRANSMIT indicator does not flash or its light becomes dim.
- Do not use an old battery together with a new one.
- Do not use different types of batteries (such as alkaline and manganese batteries) together. Read the packaging carefully as these different types of batteries may have the same shape and color.
- If the batteries have leaked, dispose of them immediately. Avoid touching the leaked material or letting it come into contact with clothing, etc. Clean the battery compartment thoroughly before installing new batteries.
- Do not throw away batteries with general house waste; dispose of them correctly in accordance with your local regulations.
- If the remote control is without batteries for more than 2 minutes, or if exhausted batteries remain in the remote control, the contents of the memory may be cleared. When the memory is cleared, insert new batteries, set up the remote control code and program any acquired functions that may have been cleared.

# CONTROLS AND FUNCTIONS

## Front panel

### Note

The XM Satellite Radio controlling functions in the following buttons (SEARCH MODE, CATEGORY, PRESET/TUNING/CH </>, MEMORY, and DISPLAY) are only applicable to the U.S.A. model and are operational only when “XM” is selected as the input source. For details, see “XM Satellite Radio controls and functions” on page 53.

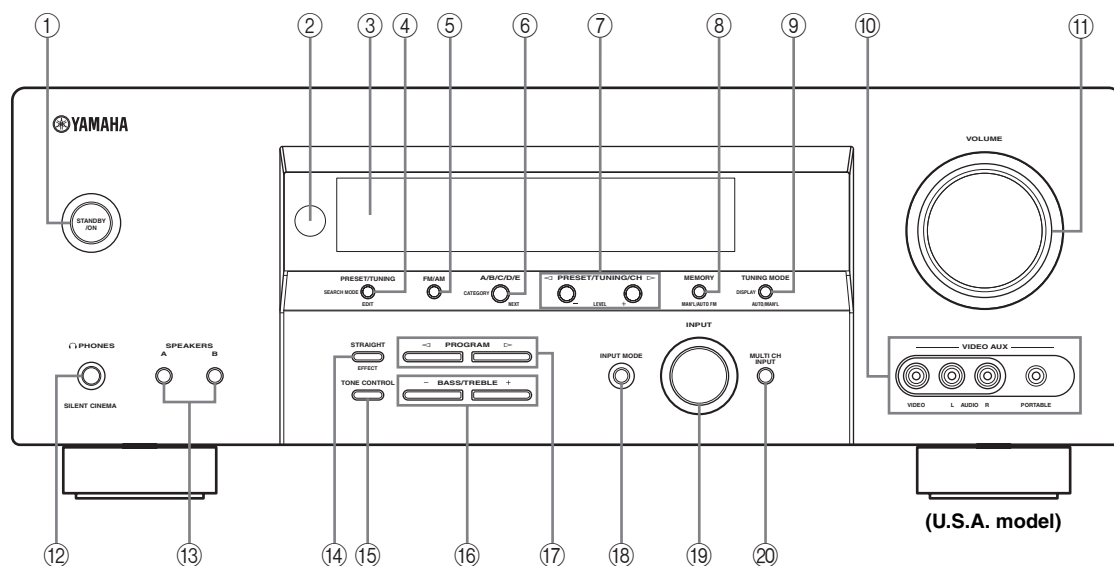

(U.S.A. model)

### ① STANDBY/ON

Turns on this unit or sets it to the standby mode (see page 27).

### Notes

- In the standby mode, this unit consumes a small amount of power in order to receive infrared signals from the remote control.
- When you turn on this unit, there will be a 4 to 5-second delay before this unit can reproduce sound.

### ② Remote control sensor

Receives signals from the remote control (see page 8).

### ③ Front panel display

Shows information about the operational status of this unit (see page 9).

### ④ PRESET/TUNING, EDIT

- Switches the function of PRESET/TUNING/CH </> between selecting preset station numbers and selecting the tuning frequency.
- Edits the assignments of preset stations (see page 50).

### ⑤ FM/AM

Switches the reception band between FM and AM when “TUNER” is selected as the input source (see page 45).

### ⑥ A/B/C/D/E, NEXT

- Selects one of the 5 preset station groups (A to E) when “TUNER” is selected as the input source (see page 45).
- Selects the speaker channel whose output level you want to adjust when “TUNER” is not selected as the input source (see page 35).

### ⑦ PRESET/TUNING/CH </>, LEVEL +/-

- Selects one of the 8 preset station numbers (1 to 8) when “TUNER” is selected as the input source. The colon (:) is displayed in the front panel display (see page 45).
- Selects the tuning frequency when “TUNER” is selected as the input source. The colon (:) is not displayed in the front panel display (see page 45).
- Adjusts the level of the speaker channel selected using NEXT when “TUNER” is not selected as the input source (see page 35).



**⑧ MEMORY (MAN'L/AUTO FM)**

Stores a preset station in the memory. Hold down this button for more than 3 seconds to start automatic preset tuning (see page 47).

**⑨ TUNING MODE (AUTO/MAN'L)**

Switches between automatic tuning (the AUTO indicator is turned on) and manual tuning (the AUTO indicator is turned off) (see page 45).

**⑩ VIDEO AUX jacks**

Input audio and video signals from a portable external source such as a game console, a video camera or a portable audio player (see page 23).



To reproduce the source signals input at these jacks, select "V-AUX" as the input source.

**Notes**

- The audio signals input at the PORTABLE mini jack take priority over the ones input at the AUDIO L/R jacks.
- The audio signals input at the DOCK terminal on the rear panel take priority over the ones input at the VIDEO AUX jacks.

**⑪ VOLUME**

Controls the output level of all audio channels.



This does not affect the AUDIO OUT (REC) level.

**⑫ PHONES (SILENT CINEMA) jack**

Outputs audio signals for private listening with headphones (see page 33).

**Notes**

- When you connect headphones, no signals are output at the SUBWOOFER OUTPUT jack or the speaker terminals.
- All Dolby Digital and DTS audio signals are mixed down to the left and right headphone channels.

**⑬ SPEAKERS A/B**

Turns on or off the set of front speakers connected to the FRONT A and/or B terminals on the rear panel each time the corresponding button is pressed.

**⑭ STRAIGHT (EFFECT)**

Turns the sound field programs off or on. When the "STRAIGHT" mode is selected, 2-channel or multi-channel input signals are output directly from their respective speakers without effect processing (see page 38).

**⑮ TONE CONTROL**

Selects "BASS" or "TREBLE" to adjust the tonal balance of the front left and right speakers in conjunction with BASS/TREBLE +/- (see page 32).

**⑯ BASS/TREBLE +/-**

Adjusts the bass/treble balance of the front left and right speakers in conjunction with TONE CONTROL (see page 32).

**⑰ PROGRAM </>**

Selects sound field programs (see page 32).

**⑱ INPUT MODE**

Selects either digital or analog input signals exclusively or sets this unit to automatically detect the type of input signals and select the corresponding input signals when one component is connected via both digital and analog connections (see page 34).

**⑲ INPUT selector**

Selects the desired input source.

**⑳ MULTI CH INPUT**

Selects the component connected to the MULTI CH INPUT jacks as the input source (see page 37).

**Note**

The input source connected to the MULTI CH INPUT jacks takes priority over the source selected with the INPUT selector on the front panel (or the input selector buttons on the remote control).

## Remote control

This section describes the function of each control on the remote control used to control this unit. To operate other components, see “REMOTE CONTROL FEATURES” on page 90.

### Notes

- The XM Satellite Radio controlling functions in the following buttons (XM, XM MEMORY, SRCH MODE, DISPLAY, cursor buttons ^/∨/∧/∨, numeric buttons and ENT.) are only applicable to the U.S.A. model and are operational only when “XM” is selected as the input source. For details, see “XM Satellite Radio controls and functions” on page 53.
- The operation mode of the remote control buttons in the shaded area below depends on the component selector switch position. Set the component selector switch to AMP to control this unit. To control the TUNER functions, set the component selector switch to SOURCE and then press TUNER to select “TUNER” as the input source.

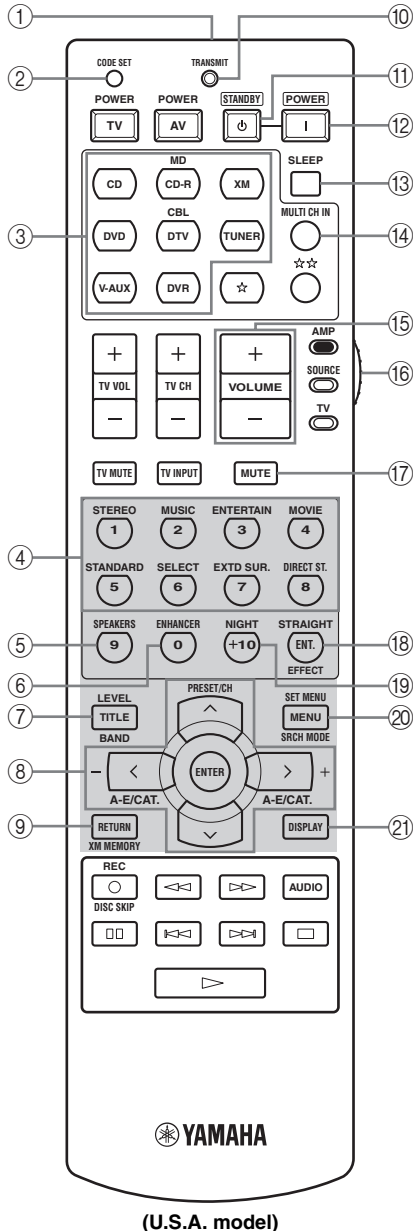

### Controlling this unit

Set the component selector switch to AMP to control this unit.

#### ① Infrared window

Outputs infrared control signals. Aim this window at the component you want to operate (see page 8).

#### ② CODE SET

Use to set up remote control codes (see page 92).

#### ③ Input selector buttons

Select the input source you want to control.

### Note

The corresponding input selector button for the currently selected input source lights up for approximately 5 seconds after you press any buttons on the remote control, showing which source component is currently being operated.

#### ④ Sound field program selector buttons

Select sound field programs (see page 63).

- Use SELECT to play back 2-channel sources in surround (see page 42).
- Use EXTD SUR. to switch between 5.1 and 6.1-channel playback of multi-channel sources (see page 41).
- Use DIRECT ST. to play back 2-channel sources in hi-fi stereo sound (see page 38).

#### ⑤ SPEAKERS

Turns on or off the set of front speakers connected to the FRONT A and/or B terminals on the rear panel. Press this button repeatedly to toggle as follows:

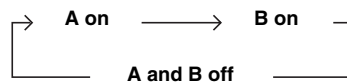

#### ⑥ ENHANCER

Turns on or off the Compressed Music Enhancer mode (see page 36).

#### ⑦ LEVEL

Selects the speaker channel to be adjusted and sets the output level (see page 35).

**⑧ Cursor buttons  $\wedge/\vee/⟨/⟩$ , ENTER**

Select and adjust the sound field program parameters or the “SET MENU” parameters.

**⑨ RETURN**

Returns to the previous menu level when adjusting the “SET MENU” parameters.

**⑩ TRANSMIT indicator**

Flashes while the remote control is sending infrared signals.

**⑪ STANDBY**

Sets this unit to the standby mode (see page 27).

**⑫ POWER**

Turns on this unit (see page 27).

**⑬ SLEEP**

Sets the sleep timer (see page 34).

**⑭ MULTI CH IN**

Selects the component connected to the MULTI CH INPUT jacks as the input source when using an external decoder, etc. (see page 37).

**⑮ VOLUME +/-**

Increases or decreases the volume level.

**⑯ Component selector switch**

Selects the operation mode of the remote control buttons in the shaded area.

**AMP**

Operates this unit.

**SOURCE**

Operates the component selected with an input selector button (see page 91).

**TV**

Operates the TV assigned to either DTV/CBL or ☆☆ (see page 90).

**Notes**

- To set the remote control codes for other components, see page 92.
- When you set the remote control codes for both DTV/CBL and ☆☆ (see page 92), priority is given to the one set for DTV/CBL.

**⑰ MUTE**

Mutes the audio output. Press again to restore the audio output to the previous volume level (see page 33).

**⑱ STRAIGHT (EFFECT)**

Turns the sound field programs off or on. When the “STRAIGHT” mode is selected, 2-channel or multi-channel input signals are output directly from their respective speakers without effect processing (see page 38).

**⑲ NIGHT**

Turns on or off the night listening modes (see page 33).

**⑳ SET MENU**

Enters “SET MENU” (see page 77).

**㉑ DISPLAY**

Selects the on-screen display (OSD) mode for your video monitor (see page 40).

■ **Controlling the TUNER functions**

Set the component selector switch to SOURCE and then press TUNER to select “TUNER” as the input source.

④ **Numeric buttons**

Use numbers 1 through 8 to select preset stations.

⑦ **BAND**

Switches the reception band between FM and AM (see page 45).

⑧ **Cursor buttons**  $\wedge / \vee / \langle / \rangle$

Press  $\langle / \rangle$  to select a preset station group (A to E) and  $\wedge / \vee$  to select a preset station number (1 to 8) (see page 49).

■ **Using the remote control**

The remote control transmits a directional infrared ray. Be sure to aim the remote control directly at the remote control sensor on this unit during operation.

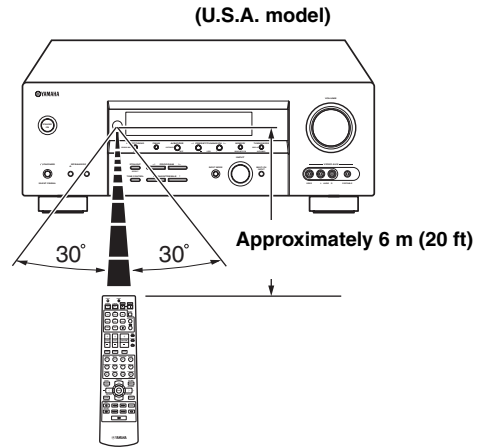

**Notes**

- Do not spill water or other liquids on the remote control.
- Do not drop the remote control.
- Do not leave or store the remote control in the following types of conditions:
  - places of high humidity, such as near a bath
  - places of high temperatures, such as near a heater or stove
  - places of extremely low temperatures
  - dusty places

## Front panel display

### Note

The XM indicator is only applicable to the U.S.A. model and the cursor on the left of the XM indicator lights up only when "XM" is selected as the input source. For details, see "Basic XM Satellite Radio operations" on page 55.

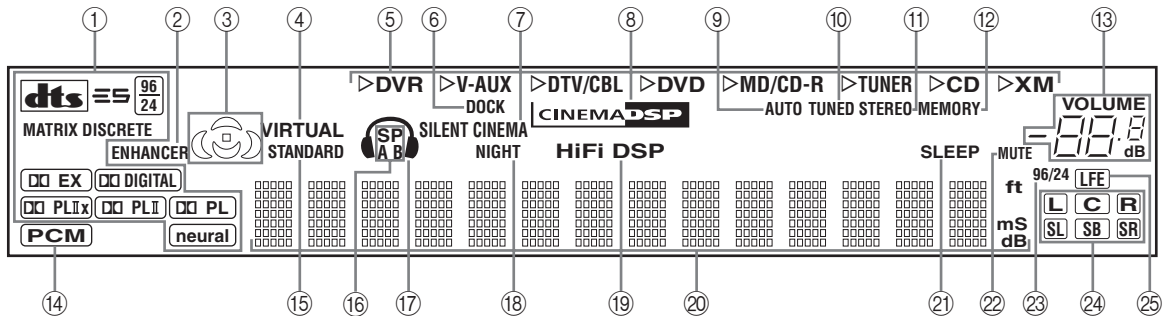

### ① Decoder indicators

The respective indicator lights up when any of the decoders of this unit function.

### Note

The neural indicator is only applicable to the U.S.A. and Canada models and lights up only when the Neural Surround decoder is selected (see page 42).

### ② ENHANCER indicator

Lights up when the Compressed Music Enhancer mode is turned on (see page 36).

### ③ Sound field indicators

Light up to indicate the active DSP sound fields.

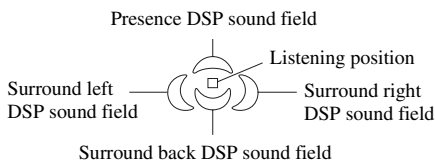

### ④ VIRTUAL indicator

Lights up when Virtual CINEMA DSP is active (see page 43).

### ⑤ Input source indicators

The corresponding cursor lights up to show the currently selected input source.

### ⑥ DOCK indicator

Lights up when you station your iPod in a YAMAHA iPod universal dock (such as YDS-10 sold separately) connected to the DOCK terminal of this unit (see page 22).

### ⑦ SILENT CINEMA indicator

Lights up when headphones are connected and a sound field program is selected (see page 33).

### ⑧ CINEMA DSP indicator

Lights up when you select a CINEMA DSP sound field program (see page 64).

### ⑨ AUTO indicator

Lights up when this unit is in the automatic tuning mode (see page 45).

### ⑩ TUNED indicator

Lights up when this unit is tuned into a station (see page 45).

### ⑪ STEREO indicator

Lights up when this unit is receiving a strong signal for an FM stereo broadcast while the AUTO indicator is lit (see page 45).

### ⑫ MEMORY indicator

Flashes to show that a station can be stored (see page 47).

**⑬ VOLUME level indicator**

Indicates the current volume level.

**⑭ PCM indicator**

Lights up when this unit is reproducing PCM (Pulse Code Modulation) digital audio signals.

**⑮ STANDARD indicator**

Lights up when the “SUR. STANDARD” or “SUR. ENHANCED” program is selected (see page 42).

**⑯ SP A B indicators**

Light up according to the set of front speakers selected.

**⑰ Headphones indicator**

Lights up when headphones are connected (see page 33).

**⑱ NIGHT indicator**

Lights up when you select a night listening mode (see page 33).

**⑲ HiFi DSP indicator**

Lights up when you select a HiFi DSP sound field program (see page 64).

**⑳ Multi-information display**

Shows the name of the current sound field program and other information when adjusting or changing settings.

**㉑ SLEEP indicator**

Lights up while the sleep timer is on (see page 34).

**㉒ MUTE indicator**

Flashes while the MUTE function is on (see page 33).

**㉓ 96/24 indicator**

Lights up when a DTS 96/24 signal is input to this unit.

**㉔ Input channel indicators**

Indicate the channel components of the current digital input signal (see page 29).

**㉕ LFE indicator**

Lights up when the input signal contains the LFE signal.

## Rear panel

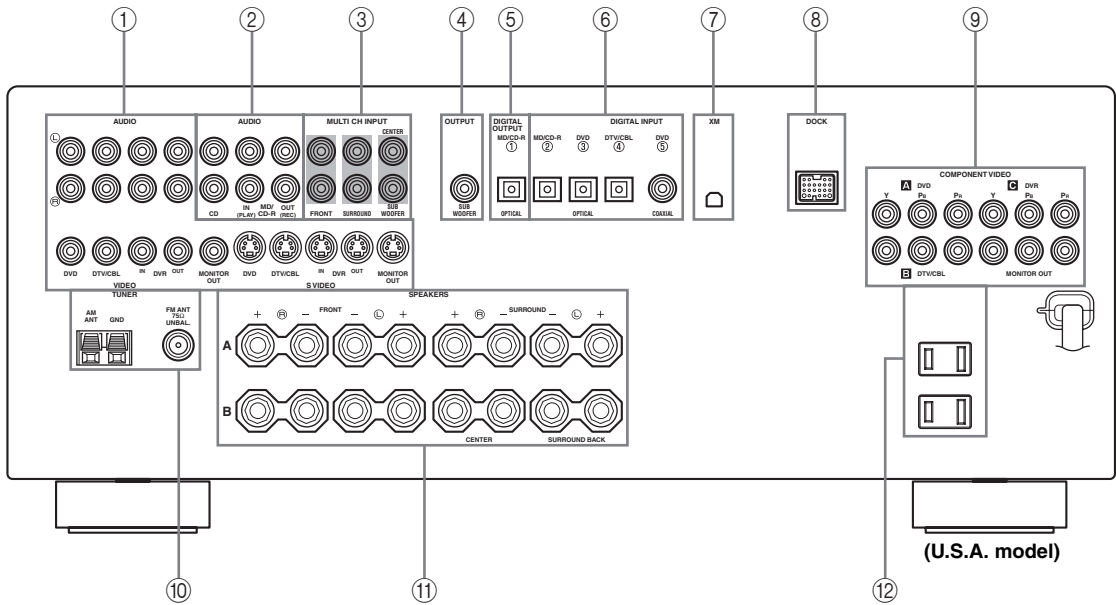
① **Video component jacks**

See pages 18 and 19 for connection information.

② **Audio component jacks**

See page 21 for connection information.

③ **MULTI CH INPUT jacks**

See page 23 for connection information.

④ **SUBWOOFER OUTPUT jack**

See page 13 for connection information.

⑤ **DIGITAL OUTPUT jack**

See page 21 for connection information.

⑥ **DIGITAL INPUT jacks**

See page 19 for connection information.

⑦ **XM jack (U.S.A. model only)**

See page 52 for connection information.

⑧ **DOCK terminal**

Use to connect a YAMAHA iPod universal dock (such as YDS-10 sold separately) where your iPod can be stationed.

See page 22 for connection information.

⑨ **COMPONENT VIDEO jacks**

See pages 18 and 19 for connection information.

⑩ **Antenna terminals**

See page 24 for connection information.

⑪ **Speaker terminals**

See page 13 for connection information.

⑫ **AC OUTLET(S)**

Use to supply power to your other audiovisual components.

See page 25 for details.

# CONNECTIONS

## Placing speakers

The speaker layout below shows the standard ITU-R\* speaker setting. You can use it to enjoy CINEMA DSP and multi-channel audio sources.

\* ITU-R is the radio communication sector of the ITU (International Telecommunication Union).

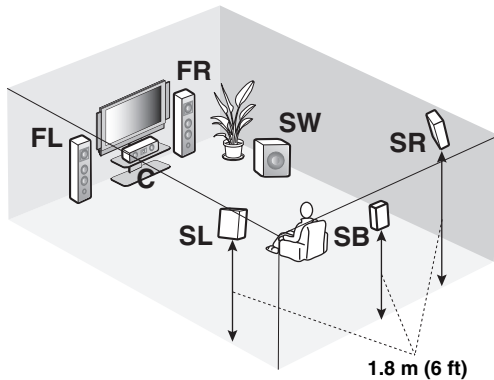
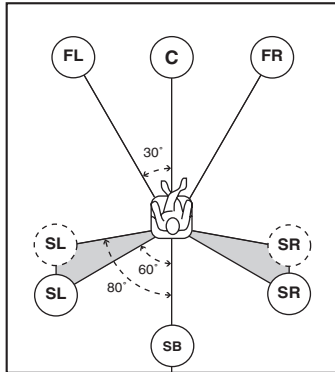

### Front left and right speakers (FL and FR)

The front speakers are used for the main source sound plus effect sounds. Place these speakers at an equal distance from the ideal listening position. The distance of each speaker from each side of the video monitor should be the same.

### Center speaker (C)

The center speaker is for the center channel sounds (dialog, vocals, etc.). If for some reason it is not practical to use a center speaker, you can do without it. Best results, however, are obtained with the full system. Place the center speaker centrally between the front speakers and as close to the monitor as possible, such as directly over or under it.

### Surround left and right speakers (SL and SR)

The surround speakers are used for effect and surround sounds. Place these speakers behind your listening position, facing slightly inwards, about 1.8 m (6 ft) above the floor.

### Surround back speaker (SB)

The surround back speaker supplements the surround speakers and provides more realistic front-to-back transitions. Place this speaker directly behind the listening position and at the same height as the surround speakers.

### Subwoofer (SW)

The use of a subwoofer with a built-in amplifier, such as the YAMAHA Active Servo Processing Subwoofer System, is effective not only for reinforcing bass frequencies from any or all channels, but also for hi-fi stereo sound reproduction of the LFE (low-frequency effect) channel included in Dolby Digital and DTS sources. The position of the subwoofer is not so critical, because low bass sounds are not highly directional. But it is better to place the subwoofer near the front speakers. Turn it slightly toward the center of the room to reduce wall reflections.



## Connecting speakers

Be sure to connect the left channel (L), right channel (R), “+” (red) and “-” (black) properly. If the connections are faulty, no sound will be heard from the speakers, and if the polarity of the speaker connections is incorrect, the sound will be unnatural and lack bass.

### CAUTION

- Before connecting the speakers, make sure that this unit is set to the standby mode (see page 27).
- Do not let the bare speaker wires touch each other or do not let them touch any metal part of this unit. This could damage this unit and/or speakers.
- Use magnetically shielded speakers. If this type of speakers still creates the interference with the monitor, place the speakers away from the monitor.
- If you are to use 4 or 6 ohm speakers, be sure to set “SP IMP.” to “6ΩMIN” before using this unit (see page 26).

### Notes

- A speaker cord is actually a pair of insulated cables running side by side. Cables are colored or shaped differently, perhaps with a stripe, groove or ridge. Connect the striped (grooved, etc.) cable to the “+” (red) terminals of this unit and your speaker. Connect the plain cable to the “-” (black) terminals.
- The low-frequency signals of other speakers set to “SML” (or “SMALL”) or to “NONE” in “SPEAKER SET” (see pages 78 and 79) are directed to the speakers selected in “LFE/BASS OUT” (see page 79).

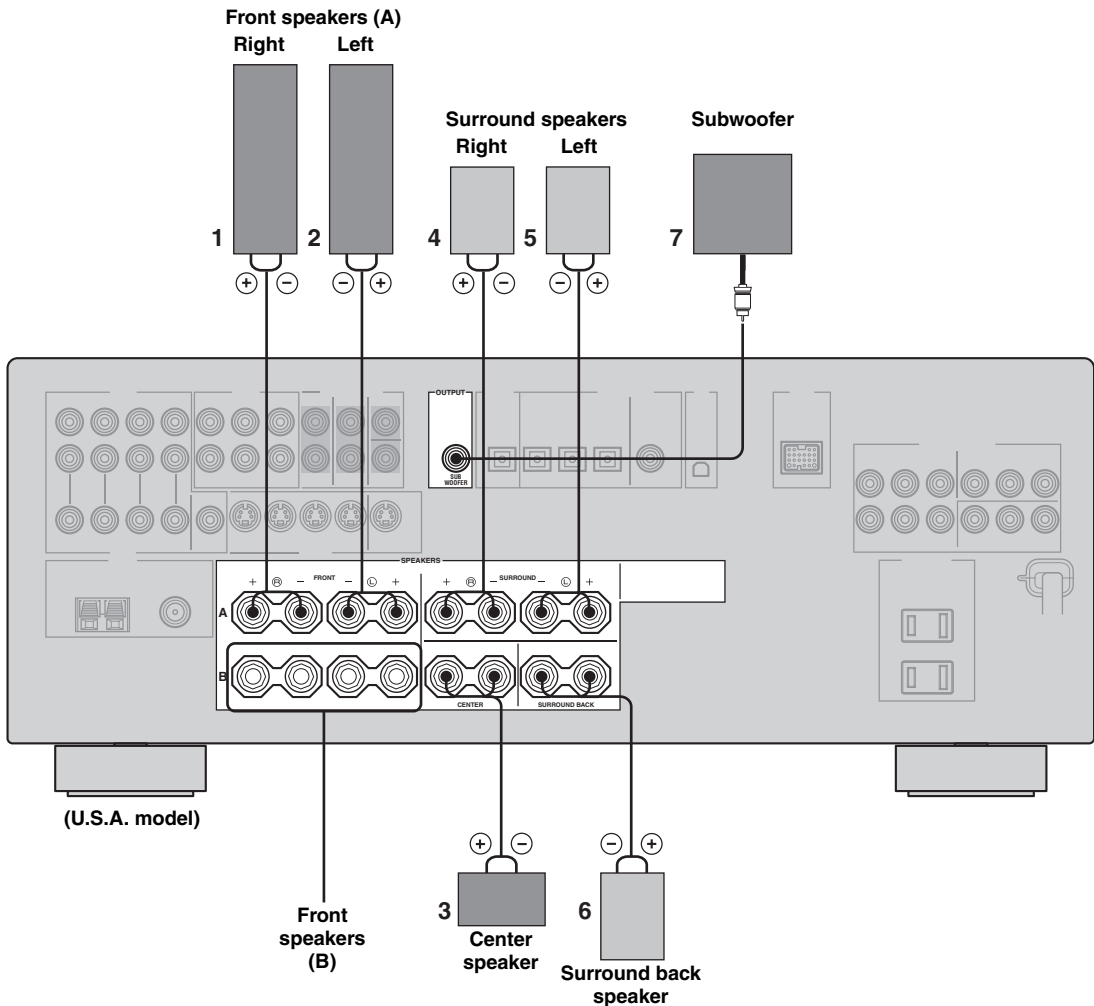

**FRONT terminals**

Connect one or two front speaker systems (1, 2) to these terminals. If you use only one front speaker system, connect it to the FRONT A or B terminal.

**CENTER terminals**

Connect a center speaker (3) to these terminals.

**SURROUND terminals**

Connect surround speakers (4, 5) to these terminals.

**SURROUND BACK terminals**

Connect a surround back speaker (6) to these terminals.

**SUBWOOFER jack**

Connect a subwoofer with a built-in amplifier (7) (such as the YAMAHA Active Servo Processing Subwoofer System) to this jack.

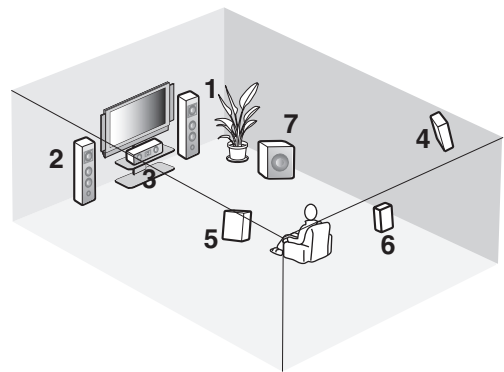

**Speaker layout**

■ **Connecting the speaker cable**

- 1 Remove approximately 10 mm (0.4 in) of insulation from the end of each speaker cable and then twist the exposed wires of the cable together to prevent short circuits.

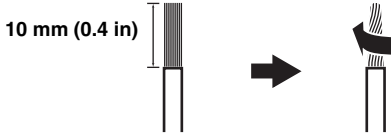

- 2 Loosen the knob.

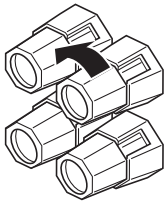

Red: positive (+)  
Black: negative (-)

- 3 Insert one bare wire into the hole on the side of each terminal.

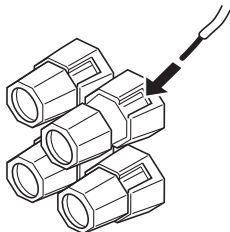

Red: positive (+)  
Black: negative (-)

- 4 Tighten the knob to secure the wire.

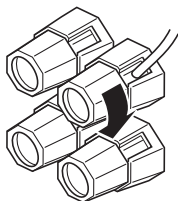

Red: positive (+)  
Black: negative (-)

■ **Connecting the banana plug**

The banana plug is a single-pole electrical connector widely used to terminate speaker cables.

Banana plug

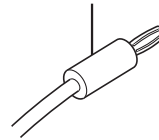

- 1 Tighten the knob.

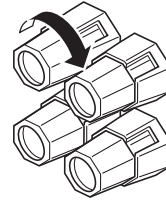

- 2 Insert the banana plug connector into the end of the corresponding terminal.

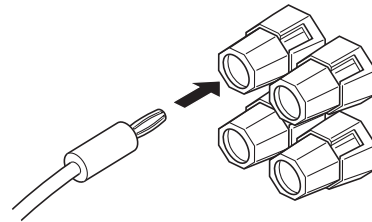

## Information on jacks and cable plugs

### Note

You can use the digital jacks to input PCM, Dolby Digital and DTS bitstreams. When you connect components to both the COAXIAL and OPTICAL jacks, priority is given to the signals input at the COAXIAL jack. All digital input jacks are compatible with 96-kHz sampling digital signals.

### Audio jacks and cable plugs

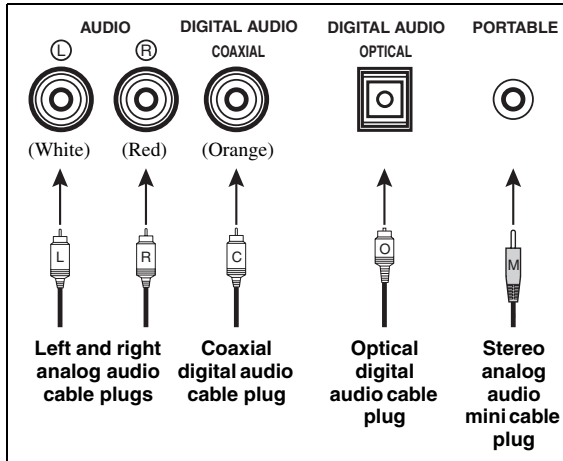

### Video jacks and cable plugs

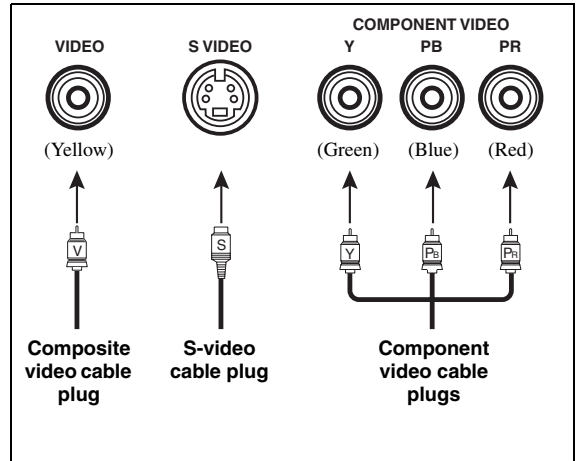

### Audio jacks

This unit has four types of audio jacks. Connection depends on the availability of audio jacks on your other components.

#### AUDIO jacks

For conventional analog audio signals transmitted via left and right analog audio cables. Connect red plugs to the right jacks and white plugs to the left jacks.

#### DIGITAL AUDIO COAXIAL jacks

For digital audio signals transmitted via coaxial digital audio cables.

#### DIGITAL AUDIO OPTICAL jacks

For digital audio signals transmitted via optical digital audio cables.

### Note

Pull out the cap from the optical jack before you connect the fiber optic cable. Do not discard the cap. When you are not using the optical jack, be sure to put the cap back in place. This cap protects the jack from dust.

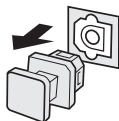

#### PORTABLE jack

For analog audio signals transmitted via stereo analog audio mini cables.

### Video jacks

This unit has three types of video jacks. Connection depends on the availability of input jacks on your video monitor. When "VIDEO CONV." is set to "ON" (see page 85), the video signals input at the VIDEO and S VIDEO jacks are converted and output at the VIDEO, S VIDEO and COMPONENT VIDEO jacks interchangeably.

#### VIDEO jacks

For conventional composite video signals transmitted via composite video cables.

#### S VIDEO jacks

For S-video signals, separated into the luminance (Y) and chrominance (C) video signals transmitted on separate wires of S-video cables.

#### COMPONENT VIDEO jacks

For component video signals, separated into the luminance (Y) and chrominance (P<sub>B</sub>, P<sub>R</sub>) video signals transmitted on separate wires of component video cables.

## Audio and video signal flow

### ■ Audio signal flow for AUDIO OUT (REC)

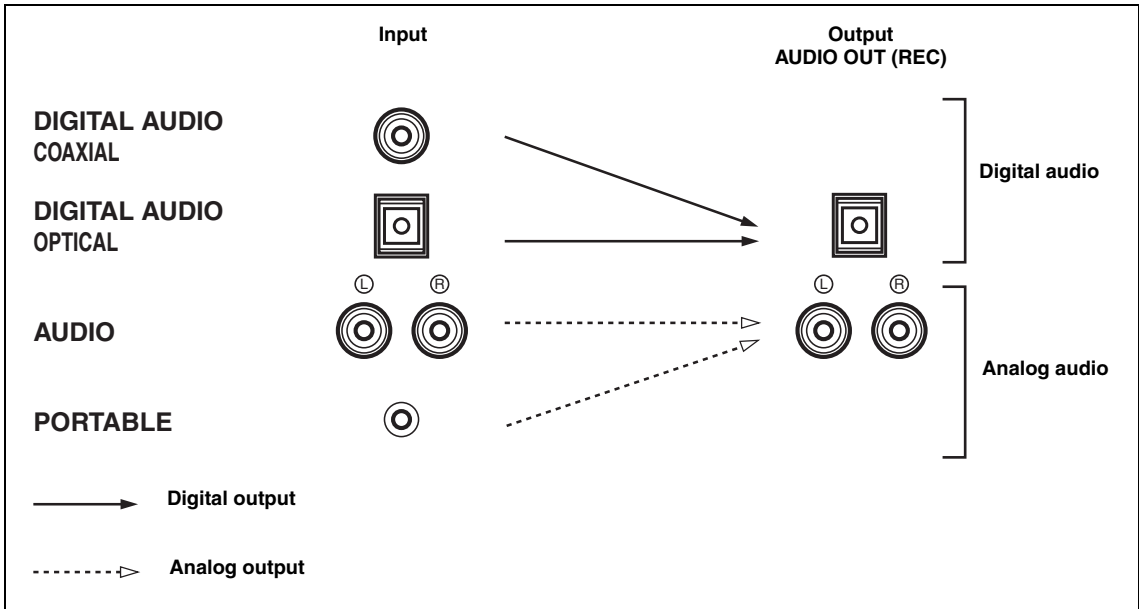

PREPARATION

#### Note

This unit handles digital and analog signals independently. Thus, audio signals input at the analog jacks are output only at the analog AUDIO OUT (REC) jacks. Likewise, audio signals input at the DIGITAL INPUT (OPTICAL or COAXIAL) jacks are output only at the DIGITAL OUTPUT jack.

### ■ Video signal flow for MONITOR OUT

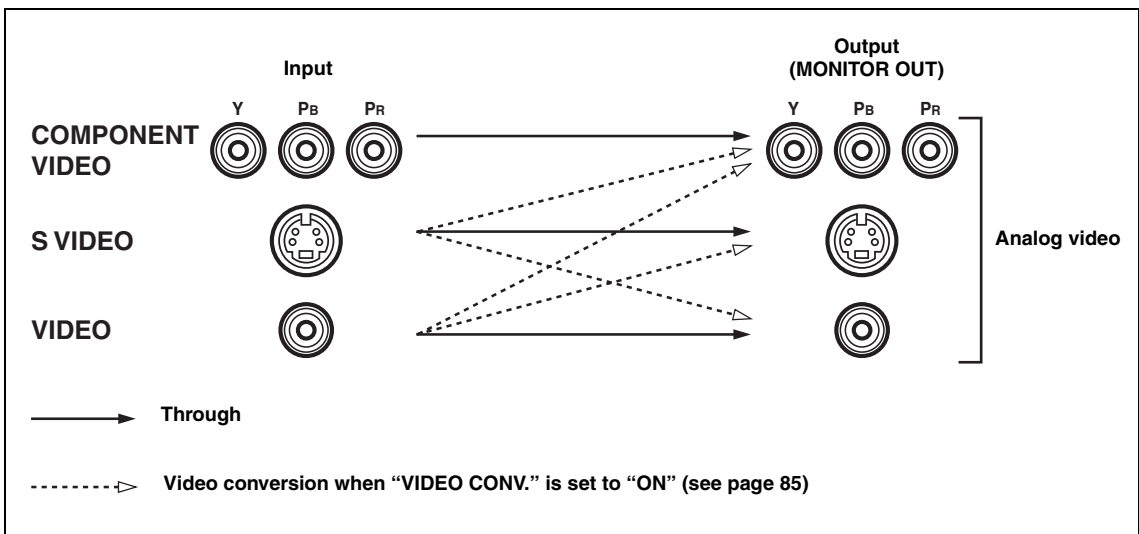

#### Note

When video signals are input at the COMPONENT VIDEO, S VIDEO and VIDEO jacks, the priority order of the input signals is as follows where the video signals input at the COMPONENT VIDEO jacks have the top priority:  
COMPONENT VIDEO > S VIDEO > VIDEO

## Connecting a TV

Connect your TV to the VIDEO MONITOR OUT jack, the S VIDEO MONITOR OUT jack or the COMPONENT VIDEO MONITOR OUT jacks of this unit.

### CAUTION

Do not connect this unit or other components to the AC power supply until all connections between components are complete.

(U.S.A. model)

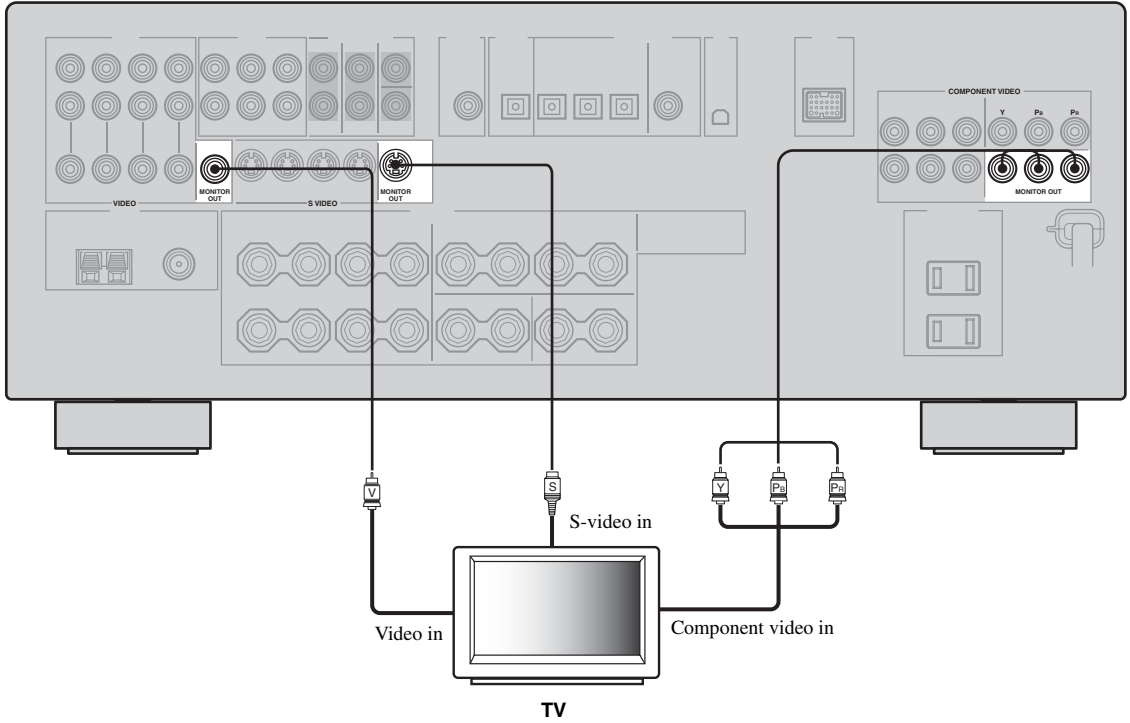

## Connecting a DVD player, a DVD recorder, a VCR or an STB

Connect your DVD player, DVD recorder, VCR or STB (set-top box) using the same type of video connections as those made for your TV (see page 18). The cable TV receiver and the satellite receiver are examples of the STB.

### CAUTION

**Do not connect this unit or other components to the AC power supply until all connections between components are complete.**

### Notes

- When “VIDEO CONV.” is set to “OFF” (see page 85), be sure to make the same type of video connections as those made for your TV (see page 18). For example, if you connected your TV to the VIDEO MONITOR OUT jack of this unit, connect your other components to the VIDEO jacks.
- When “VIDEO CONV.” is set to “ON” (see page 85), the converted video signals are output only at the MONITOR OUT jacks. When recording a source, you must make the same type of video connections between each component.
- To make a digital connection to a component other than the default component assigned to each DIGITAL INPUT or DIGITAL OUTPUT jack, select the corresponding setting for “OPTICAL OUT”, “OPTICAL IN”, or “COAXIAL IN” in “I/O ASSIGNMENT” (see page 83).
- If you connect your DVD player to both the DIGITAL INPUT (OPTICAL) and the DIGITAL INPUT (COAXIAL) jacks, priority is given to the signals input at the DIGITAL INPUT (COAXIAL) jack.

### ■ Connecting a DVD player

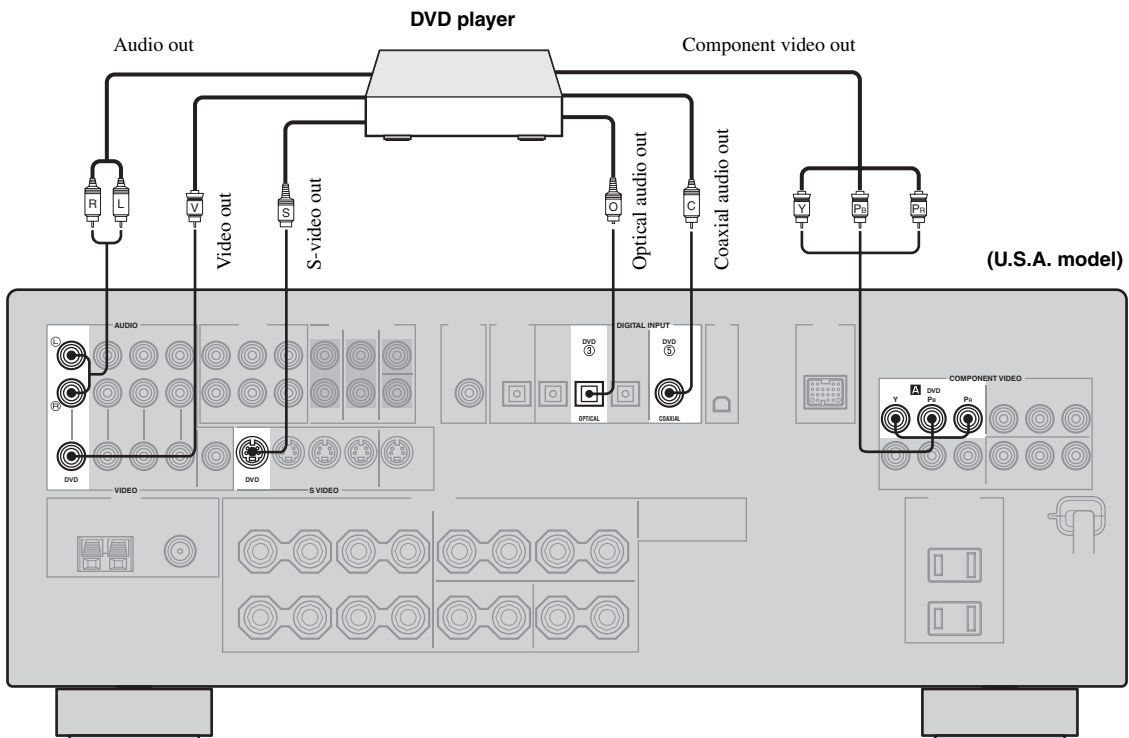

■ Connecting a DVD recorder or a VCR

(U.S.A. model)

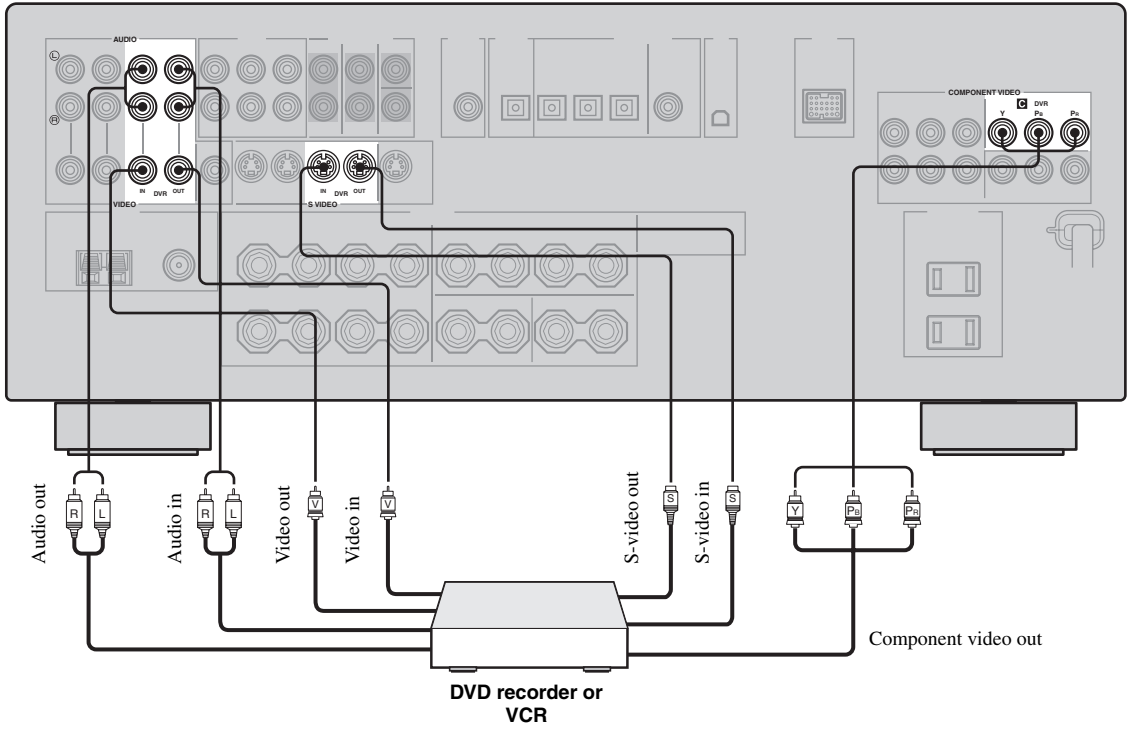

■ Connecting an STB

Cable TV receiver or satellite receiver

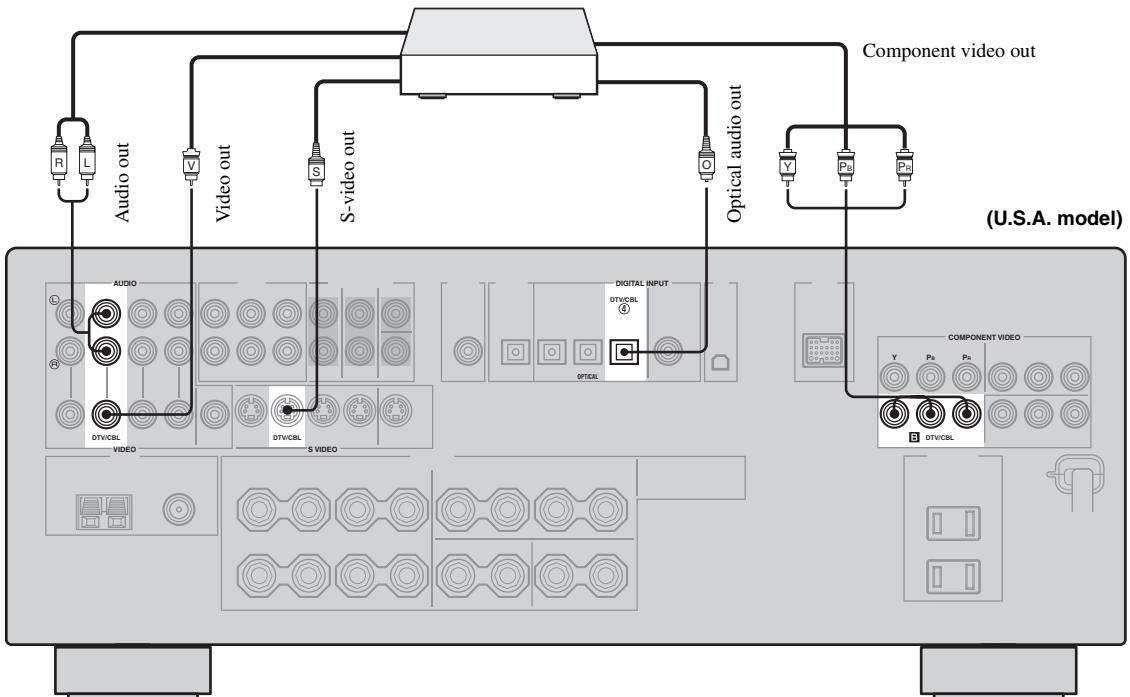

(U.S.A. model)



## Connecting a CD player, an MD player or a tape deck

Connect your CD player, MD player or tape deck via analog and/or digital connections.

### CAUTION

**Do not connect this unit or other components to the AC power supply until all connections between components are complete.**

### Note

To make a digital connection to a component other than the default component assigned to each DIGITAL INPUT or DIGITAL OUTPUT jack, select the corresponding setting for "OPTICAL OUT", "OPTICAL IN", or "COAXIAL IN" in "I/O ASSIGNMENT" (see page 83).

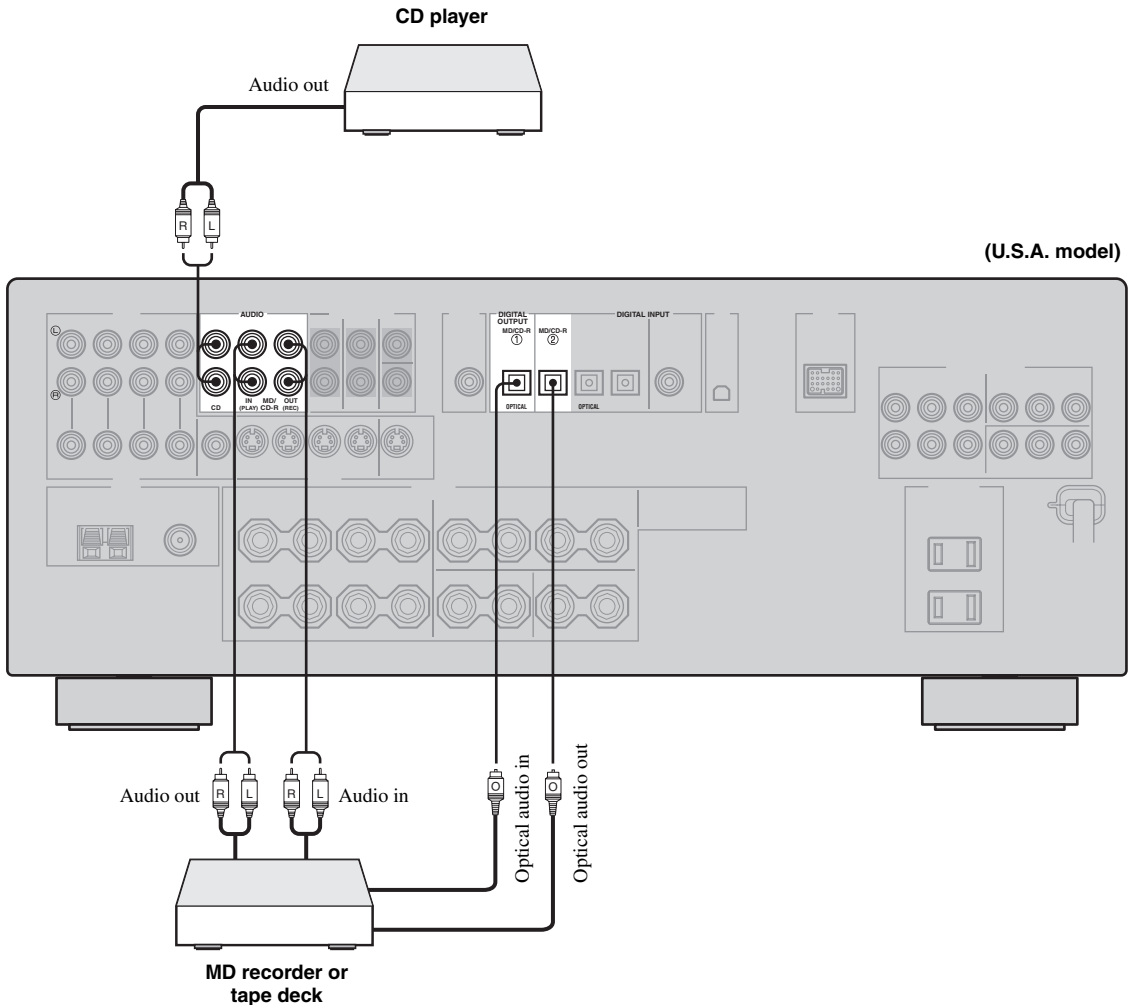

## Connecting a YAMAHA iPod universal dock

This unit is equipped with the DOCK terminal on the rear panel that allows you to connect a YAMAHA iPod universal dock (such as YDS-10 sold separately) where you can station your iPod and control playback of your iPod using the supplied remote control. Connect a YAMAHA iPod universal dock (such as YDS-10 sold separately) to the DOCK terminal on the rear panel of this unit using its dedicated cable. Once the connection is complete, station your iPod in the YAMAHA iPod universal dock.

### CAUTION

**Do not connect this unit or other components to the AC power supply until all connections between components are complete.**

### Notes

- Only iPod (Click and Wheel), iPod nano, and iPod mini are supported.
- You need a YAMAHA iPod universal dock (such as YDS-10 sold separately) and its dedicated cable compatible with the DOCK terminal of this unit.
- Once your iPod is stationed in a YAMAHA iPod universal dock (such as YDS-10 sold separately) connected to the DOCK terminal of this unit, this unit begins the signal transmission with your iPod.
- Once the connection between your iPod and this unit is complete, "iPod connected" appears in the front panel display and the DOCK indicator lights up in the front panel display. If the connection between your iPod and this unit fails, a status message appears in the front panel display. For a complete list of connection status messages, see the iPod section in "TROUBLESHOOTING" on page 102.
- Only analog audio and video signals of your iPod are input at the DOCK terminal, and the analog audio signals can be output at the analog AUDIO OUT (REC) jacks for recording.
- Your iPod battery is automatically charged when your iPod is stationed in a YAMAHA iPod universal dock (such as YDS-10 sold separately) connected to the DOCK terminal of this unit as long as this unit is turned on.
- Depending on the type of iPod, you may need to insert one of the iPod adapters supplied with a YAMAHA iPod universal dock (such as YDS-10 sold separately) into the dock slot before you station your iPod.

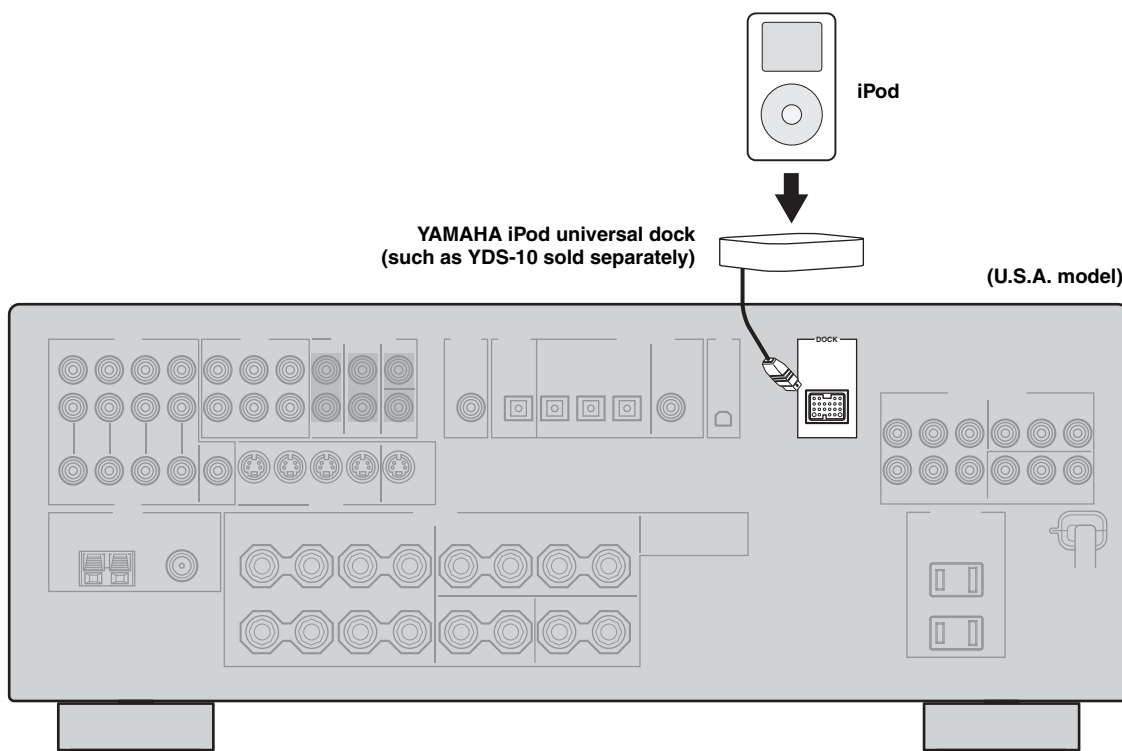

## Connecting a multi-format player or an external decoder

This unit is equipped with 6 additional input jacks (FRONT L/R, CENTER, SURROUND L/R and SUBWOOFER) for discrete multi-channel input from a multi-format player, external decoder or sound processor. Connect the output jacks on your multi-format player or external decoder to the MULTI CH INPUT jacks. Be sure to match the left and right output jacks to the left and right input jacks for the front and surround channels.

### CAUTION

**Do not connect this unit or other components to the AC power supply until all connections between components are complete.**

### Notes

- When you select the component connected to the MULTI CH INPUT jacks as the input source (see page 37), this unit automatically turns off the digital sound field processor, and you cannot select sound field programs.
- This unit does not redirect signals input at the MULTI CH INPUT jacks to accommodate for missing speakers. We recommend that you connect at least a 5.1-channel speaker system before using this feature.
- When headphones are used, signals are output only from the front left and right channels.

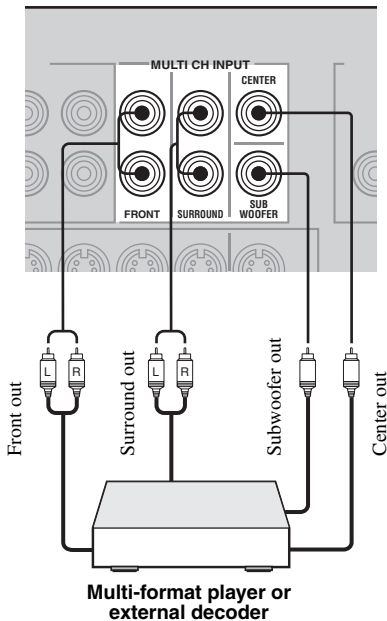

## Connecting a game console, a video camera or a portable audio player

Use the VIDEO AUX jacks on the front panel to connect a game console, a video camera or a portable audio player to this unit.

### CAUTION

**Be sure to turn off the volume of this unit and other components before making connections.**

### Notes

- The audio signals input at the PORTABLE mini jack take priority over the ones input at the AUDIO L/R jacks.
- The audio signals input at the DOCK terminal takes priority over the ones input at the VIDEO AUX jacks.

(U.S.A. model)

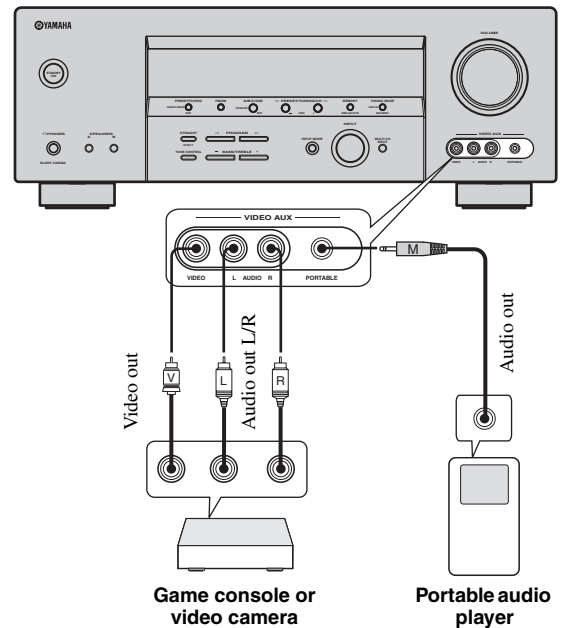

## Connecting the FM and AM antennas

Both FM and AM indoor antennas are supplied with this unit. In general, these antennas should provide sufficient signal strength. Connect each antenna correctly to the designated terminals.

### Notes

- The AM loop antenna should be placed away from this unit.
- The AM loop antenna should always be connected, even if an outdoor AM antenna is connected to this unit.
- A properly installed outdoor antenna provides clearer reception than an indoor one. If you experience poor reception quality, install an outdoor antenna. Consult the nearest authorized YAMAHA dealer or service center about outdoor antennas.

### AM loop antenna (supplied)

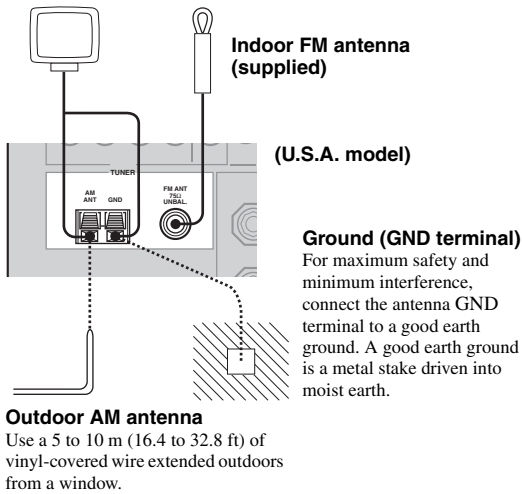

## ■ Connecting the AM loop antenna

### 1 Set up the AM loop antenna.

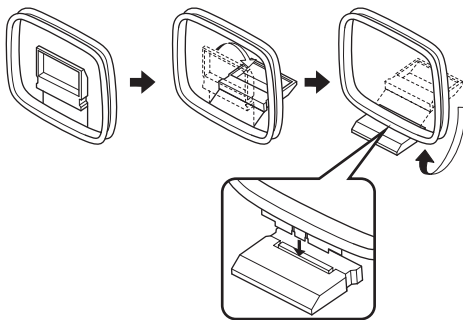

### 2 Press and hold the tab of the AM ANT terminal.



### 3 Insert one of the AM loop antenna lead wires into the AM ANT terminal.

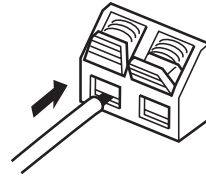

### 4 Release the tab of the AM ANT terminal back into place.



### 5 Repeat steps 2 through 4 to connect the other lead wire to the GND terminal.



Once you have properly connected the AM loop antenna to this unit, orient the AM loop antenna for the best reception when you tune into AM stations (see page 45).

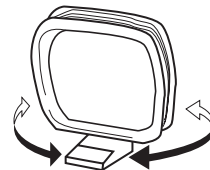

## Connecting the power cable

Once all connections are complete, plug the power cable into the AC wall outlet.

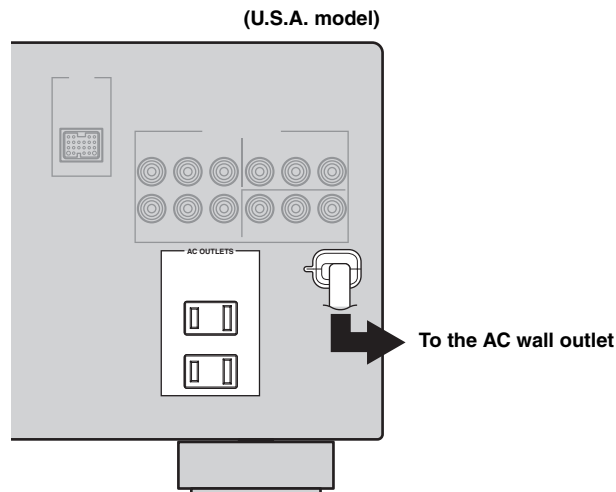

### ■ AC OUTLET(S) (SWITCHED)

Australia model..... 1 outlet  
 Other models..... 2 outlets

Use these outlet(s) to supply power to any connected components. Connect the power cable of your other components to these outlet(s). Power to these outlet(s) is supplied when this unit is turned on. However, power to these outlet(s) is cut off when this unit is set to the standby mode. For information on the maximum power or the total power consumption of the components that can be connected to these outlet(s), see "SPECIFICATIONS" on page 106.

#### **Memory back-up**

The memory back-up circuit prevents the stored data from being lost even if this unit is in the standby mode. However, the stored data will be lost in case the power cable is disconnected from the AC wall outlet or if the power supply is cut off for more than one week.

## Setting the speaker impedance

### CAUTION

If you are to use 4 or 6 ohm speakers, set “SP IMP.” to “6ΩMIN” as follows BEFORE using this unit.

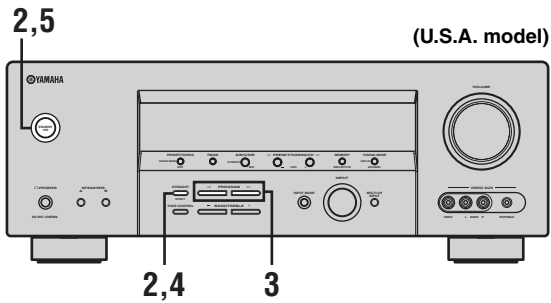

- 1 Make sure this unit is set to the standby mode.

See page 27 for details about turning on this unit or setting it to the standby mode.

- 2 Press and hold STRAIGHT (EFFECT) on the front panel and then press STANDBY/ON to turn on this unit.

This unit turns on, and the advanced setup menu appears in the front panel display.

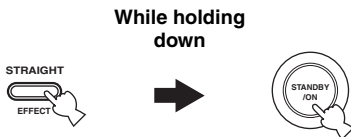

- 3 Press PROGRAM </> on the front panel repeatedly to select “SP IMP.”.

The following display appears in the front panel display.



- 4 Press STRAIGHT (EFFECT) on the front panel repeatedly to select “6ΩMIN”.

The following display appears in the front panel display.

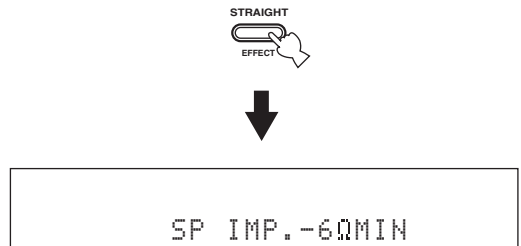

- 5 Press STANDBY/ON on the front panel to save the new setting and set this unit to the standby mode.



### Note

The setting you made is reflected next time you turn on this unit.

## Turning on this unit or setting it to the standby mode

When all connections are complete, turn on this unit.

STANDBY/ON

(U.S.A. model)

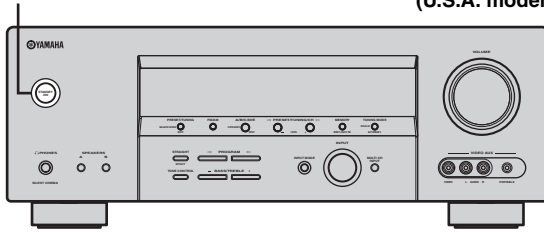

(U.S.A. model)



STANDBY  
POWER

### ■ Turning on this unit

Press STANDBY/ON on the front panel (or POWER on the remote control) to turn on this unit.



Front panel

or



Remote control

### ■ Setting this unit to the standby mode

Press STANDBY/ON on the front panel again (or STANDBY on the remote control) to set this unit to the standby mode.



Front panel

or



Remote control

# BASIC SETUP

The “BASIC SETUP” feature is a useful way to set up your system quickly and with minimal effort.

## Notes

- Make sure you disconnect your headphones from this unit.
- If you wish to configure this unit manually using more precise adjustments, use the detailed parameters in “SOUND MENU” (see page 78).
- Altering any parameters in “BASIC SETUP” resets all parameters manually adjusted in “SOUND MENU” (see page 78).
- Initial settings are indicated in bold under each parameter.
- Press RETURN on the remote control to return to the previous menu level.

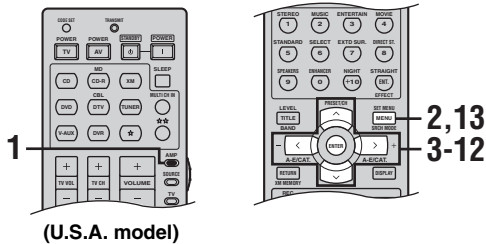

## 4 Press ENTER to enter “BASIC SETUP”.

The following display appears in the OSD.

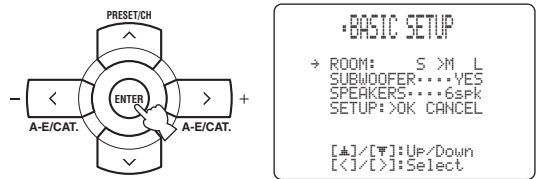

## 1 Set the component selector switch to AMP.

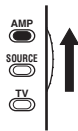

## 5 Press ^ / v to select “ROOM” and then < / > to select the desired setting.

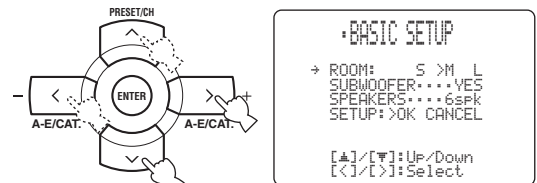

## 2 Press SET MENU to enter “SET MENU”.

The top “SET MENU” display appears in the OSD.

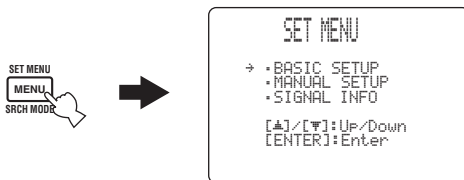

Select the size of the room where you have installed your speakers. In general, the room sizes are defined as follows:

Choices: **S**, **M**, **L**

[U.S.A. and Canada models]

S (small) 16 x 13ft, 200ft<sup>2</sup> (4.8 x 4.0m, 20m<sup>2</sup>)

M (medium) 20 x 16ft, 300ft<sup>2</sup> (6.3 x 5.0m, 30m<sup>2</sup>)

L (large) 26 x 19ft, 450ft<sup>2</sup> (7.9 x 5.8m, 45m<sup>2</sup>)

[Other models]

S (small) 3.6 x 2.8m, 10m<sup>2</sup>

M (medium) 4.8 x 4.0m, 20m<sup>2</sup>

L (large) 6.3 x 5.0m, 30m<sup>2</sup>

## 3 Press ^ / v to select “BASIC SETUP”.

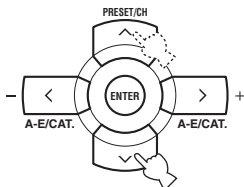



**6** Press  $\nabla$  to select “SUBWOOFER” and then  $\langle / \rangle$  to select the desired setting.

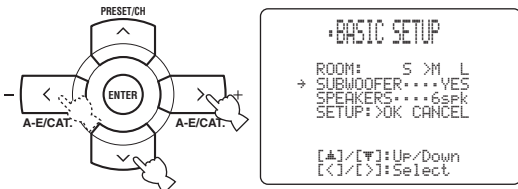

Choices: **YES, NONE**

- Select “YES” if you have a subwoofer in your system.
- Select “NONE” if you do not have a subwoofer in your system.

**7** Press  $\nabla$  to select “SPEAKERS” and then  $\langle / \rangle$  to select the number of speakers connected to this unit.

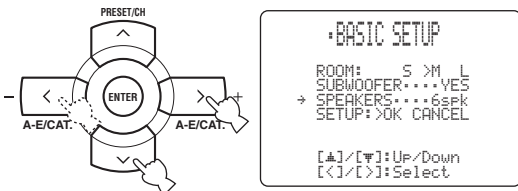

Choice	Display	Speakers
2spk	<input type="checkbox"/> <input type="checkbox"/>	Front L/R
3spk	<input type="checkbox"/> <input type="checkbox"/> <input type="checkbox"/>	Front L/R, Center
4spk	<input type="checkbox"/> <input type="checkbox"/> <input type="checkbox"/> <input type="checkbox"/>	Front L/R, Surround L/R
5spk	<input type="checkbox"/> <input type="checkbox"/> <input type="checkbox"/> <input type="checkbox"/> <input type="checkbox"/>	Front L/R, Center, Surround L/R
6spk	<input type="checkbox"/> <input type="checkbox"/> <input type="checkbox"/> <input type="checkbox"/> <input type="checkbox"/> <input type="checkbox"/>	Front L/R, Center, Surround L/R, Surround back

**8** Press  $\nabla$  to select “SETUP” and then  $\langle / \rangle$  to select the desired setting.

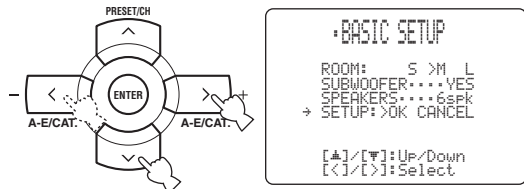

Choices: **OK, CANCEL**

- Select “OK” to apply the settings you made.
- Select “CANCEL” to cancel the setup procedure without making any changes.



You can also press SET MENU to cancel the setup procedure.

**9** Press ENTER to confirm your selection.

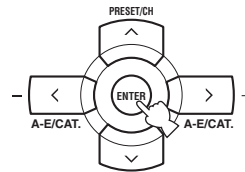

If you selected “OK” in step 8, each speaker outputs a test tone twice in turn. “CHECK:Test Tone” appears in the OSD for a few seconds and then “CHECK OK?” appears in the OSD.

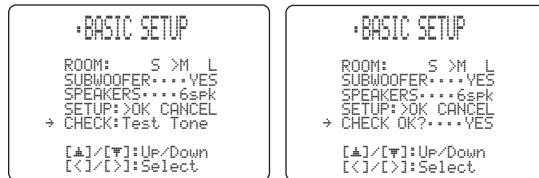

Check the speaker connections (see page 13) and adjust the “SPEAKERS” settings back in step 7, if necessary.

**10 Press </> to select the desired setting.**

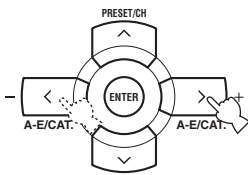

Choices: **YES, NO**

- Select “YES” to complete the setup procedure if the test tone levels from each speaker were satisfactory.
- Select “NO” to proceed to the speaker level adjustment menu in step 12 to balance the output level of each speaker.

**11 Press ENTER to confirm your selection.**

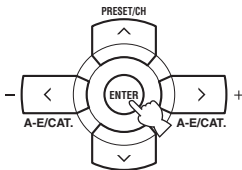

- If you selected “YES” in step 10, the setup procedure is completed and the display returns to the top “SET MENU” display.
- If you selected “NO” in step 10, the front speaker level adjustment display appears in the front panel display.

**12 Press ^/∨ to select a speaker and then </> to adjust the balance.**

The selected speaker and the front left speaker (or the surround left speaker) output a test tone in turn.

- Press > to increase the value.
- Press < to decrease the value.

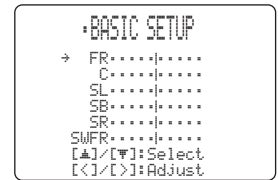
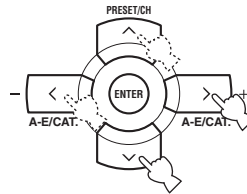

- Select “FR” to adjust the balance between the front left and right speakers.
- Select “C” to adjust the balance between the front left and center speakers.
- Select “SL” to adjust the balance between the front left and surround left speakers.
- Select “SB” to adjust the balance between the surround left and surround back speakers.
- Select “SR” to adjust the balance between the surround left and surround right speakers.
- Select “SWFR” to adjust the balance between the front left speaker and the subwoofer.

**13 Press SET MENU to exit from “BASIC SETUP”.**



# PLAYBACK

## CAUTION

Extreme caution should be exercised when you play back CDs encoded in DTS. If you play back a CD encoded in DTS on a DTS-incompatible CD player, you will only hear some unwanted noise that may damage your speakers. Check whether your CD player supports CDs encoded in DTS. Also, check the sound output level of your CD player before you play back a CD encoded in DTS.

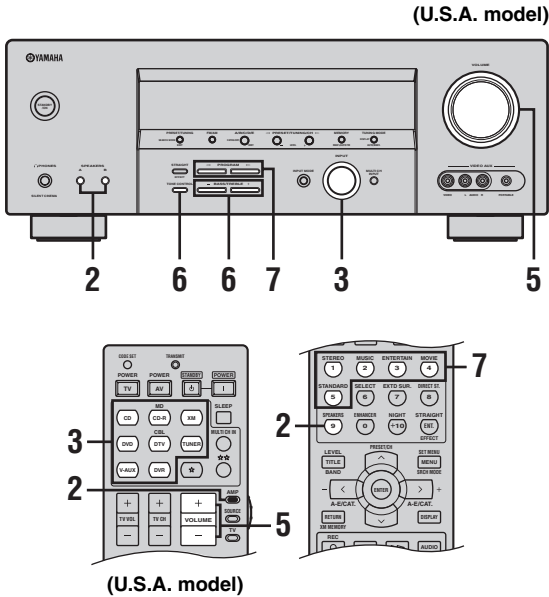

**3** Rotate the INPUT selector on the front panel (or press one of the input selector buttons on the remote control) to select the desired input source.

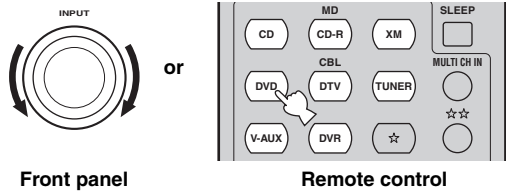

The name of the currently selected input source appears in the front panel display and in the OSD for a few seconds.

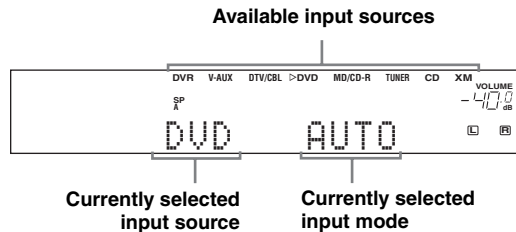

**1** Turn on the video monitor connected to this unit.

**2** Press SPEAKERS A or B on the front panel (or set the component selector switch to AMP and then press SPEAKERS on the remote control repeatedly).

Each time you press SPEAKERS A or B, the respective speakers are turned on or off.

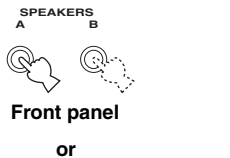

**4** Start playback on the selected source component or select a broadcast station.

Refer to the operating instructions for the source component.

See page 45 for details about tuning instructions.

## Notes

- If you are to select an input source connected via digital connections, set "INPUT MODE" to "AUTO" or "DTS" (see page 34).
- For details about controlling XM Satellite Radio when "XM" is selected as the input source, see page 55.

- 5 Rotate **VOLUME** on the front panel (or press **VOLUME +/-** on the remote control) to adjust the volume to the desired output level.

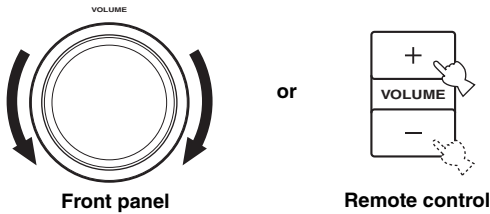

- 6 Press **TONE CONTROL** on the front panel repeatedly to select “**TREBLE**” or “**BASS**” and then press **BASS/TREBLE +/-** repeatedly to adjust the corresponding frequency response level.

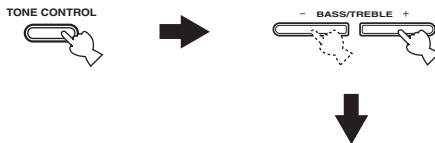

- Select “**TREBLE**” to adjust the high-frequency response.
- Select “**BASS**” to adjust the low-frequency response.

#### Notes

- Speaker and headphone adjustments are stored independently.
- When “**TONE BYPASS**” is set to “**AUTO**” (see page 82), and “**BASS**” and “**TREBLE**” are set to 0 dB, audio output automatically bypasses the tone control circuitry of this unit.
- If you increase or decrease the high-frequency or low-frequency sound to an extreme level, the tonal quality of the surround speakers may not match that of the front left and right speakers.
- **TONE CONTROL** is not effective when the “**DIRECT STEREO**” mode (see page 38) is selected or when the component connected to the **MULTI CH INPUT** jacks is selected as the input source (see page 37).
- To enjoy multi-channel sources in surround, see page 41 for details.

- 7 Press **PROGRAM** ◀/▶ on the front panel (or press one of the sound field program selector buttons on the remote control) repeatedly to select the desired sound field program.

The name of the selected sound field program appears in the front panel display and in the OSD.

See page 64 for details about sound field programs.

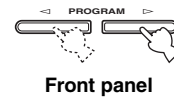

or

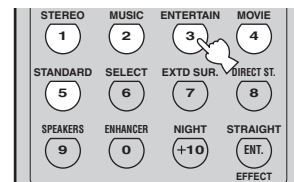

**Currently selected  
surround field program**

#### Notes

- Choose a sound field program based on your listening preference, not merely on the name of the program.
- When you select an input source, this unit automatically selects the last sound field program used with the corresponding input source.
- Sound field programs cannot be selected when the component connected to the **MULTI CH INPUT** jacks is selected as the input source (see page 37).
- Sampling frequencies higher than 48 kHz (except for DTS 96/24 signals) are sampled down to 48 kHz and then sound field programs are applied.
- To display information about the currently selected input source in the OSD, see page 39 for details.

# USING AUDIO FEATURES

## Using SILENT CINEMA

SILENT CINEMA allows you to enjoy multi-channel music or movie sound, including Dolby Digital and DTS sources, through ordinary headphones. SILENT CINEMA activates automatically whenever you connect headphones to the PHONES jack while listening to CINEMA DSP or HiFi DSP sound field programs (see page 64). When activated, the SILENT CINEMA indicator lights up in the front panel display.

### Notes

- SILENT CINEMA does not activate when the component connected to the MULTI CH INPUT jacks is selected as the input source (see page 37).
- SILENT CINEMA is not effective when the “DIRECT STEREO” (see page 38) or “2ch Stereo” mode (see page 38) is selected, or when this unit is in the “STRAIGHT” mode (see page 38).

## Muting the audio output

Press **MUTE** on the remote control to mute the audio output. Press **MUTE** again to resume the audio output.



- You can also rotate VOLUME on the front panel or VOLUME +/- on the remote control to resume the audio output.
- You can adjust the muting level by using the “MUTING TYPE” parameter in “SOUND MENU” (see page 82).
- The MUTE indicator flashes in the front panel display when the audio output is muted and disappears from the front panel display when the audio output is resumed.

### Note

If you change the input source or the sound field program while the audio output is being muted, this unit resumes the audio output.

## Selecting the night listening mode

The night listening modes are designed to improve listenability at lower volumes or at night. Choose either “NIGHT:CINEMA” or “NIGHT:MUSIC” depending on the type of material you are playing.

- 1 Set the component selector switch to **AMP** and then press **NIGHT** on the remote control repeatedly to select “NIGHT:CINEMA” or “NIGHT:MUSIC”.

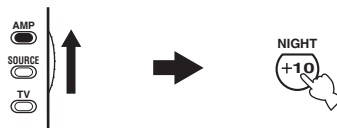

Choices: NIGHT:CINEMA, NIGHT:MUSIC, OFF

- Select “NIGHT:CINEMA” when watching films to reduce the dynamic range of film soundtracks and make dialog easier to hear at lower volumes.
- Select “NIGHT:MUSIC” when listening to music sources to preserve ease-of-listening for all sounds.
- Select “OFF” if you do not want to use this feature.



When a night listening mode is selected, the NIGHT indicator lights up in the front panel display.

- 2 Press **</>** on the remote control to adjust the effect level while “NIGHT:CINEMA” or “NIGHT:MUSIC” is displayed in the front panel display.

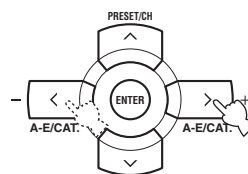

Remote control



Effect.Lvl: MID

Choices: MIN, **MID**, MAX

- Select “MIN” for minimum compression.
- Select “MID” for standard compression.
- Select “MAX” for maximum compression.



“NIGHT:CINEMA” and “NIGHT:MUSIC” adjustments are stored independently.

**Notes**

- You cannot use the night listening modes in the following cases:
  - when the “DIRECT STEREO” mode (see page 38) is selected.
  - when the component connected to the MULTI CH INPUT jacks is selected as the input source (see page 37).
  - when headphones are connected to the PHONES jack.
- The night listening modes may vary in effectiveness depending on the input source and surround sound settings you use.

**Selecting the input mode**

This unit comes with a variety of input jacks. Do the following to select the type of input signals you want to use.



- We recommend setting “INPUT MODE” to “AUTO” in most cases.
- You can adjust the default input mode of this unit by using the “INPUT MODE” parameter in “INPUT MENU” (see page 84).

**Notes**

- To play DTS-encoded CDs when using a digital audio connection, be sure to set “INPUT MODE” to “DTS”.
- DTS decoding may not be performed correctly depending on the player even if you make a digital connection between this unit and the player.

**1 Rotate the INPUT selector on the front panel to select the desired input source.**

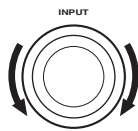

**2 Press INPUT MODE on the front panel repeatedly to select the desired input mode.**

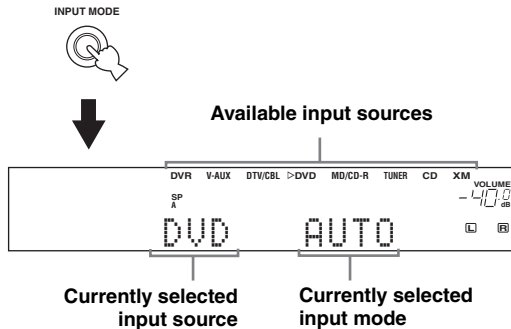

- AUTO** Automatically selects input signals in the following order:
  - (1) Digital signals
  - (2) Analog signals
- DTS** Selects only digital signals encoded in DTS. If no DTS signals are input, no sound is output.
- ANALOG** Selects only analog signals. If no analog signals are input, no sound is output.

**Note**

When “INPUT MODE” is set to “AUTO”, this unit automatically switches to the appropriate decoder if a Dolby Digital or DTS signal is detected.

**Using the sleep timer**

Use this feature to automatically set this unit to the standby mode after a certain amount of time. The sleep timer is useful when you are going to sleep while this unit is playing or recording a source. The sleep timer also automatically turns off any external components connected to AC OUTLET(S) (see page 25).

**1 Press one of the input selector buttons on the remote control to select the desired input source.**

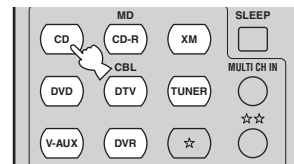

**2 Start playback on the selected source component or select a broadcast station.** Refer to the operating instructions for the source component. See page 45 for details about tuning instructions.

**3 Press SLEEP on the remote control repeatedly to set the amount of time.**

Each time you press SLEEP, the front panel display changes as shown below.

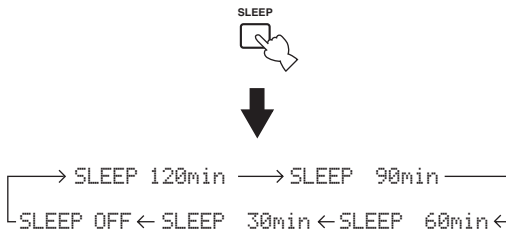

The SLEEP indicator flashes while you are switching the amount of time for the sleep timer. Once the sleep timer is set, the SLEEP indicator lights up in the front panel display, and the display returns to the selected sound field program.

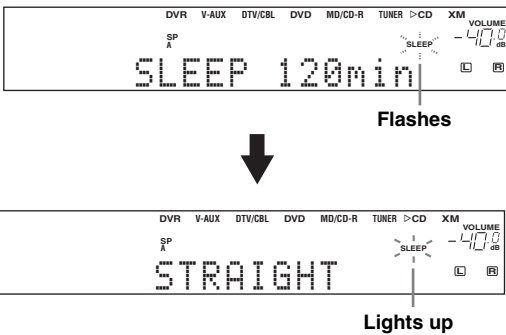

**4 To cancel the sleep timer, press SLEEP on the remote control repeatedly until "SLEEP OFF" appears in the front panel display.**

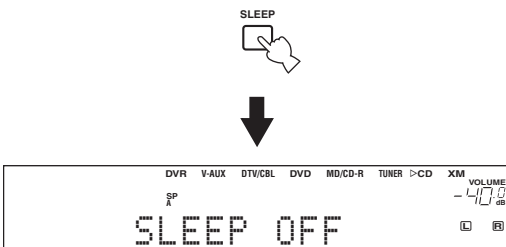

The SLEEP indicator turns off, and "SLEEP OFF" disappears from the front panel display after a few seconds.

The sleep timer setting can also be canceled by pressing STANDBY on the remote control (or STANDBY/ON on the front panel) to set this unit to the standby mode.

**Adjusting the speaker level**

You can adjust the output level of each speaker while listening to a music source. This is also possible when playing sources input at the MULTI CH INPUT jacks.

**Note**

This operation will override the level adjustments made in "BASIC SETUP" (see page 28) and "SPEAKER LEVEL" (see page 80).

This operation can also be performed using the control buttons on the front panel. Press NEXT on the front panel repeatedly to select the speaker channel whose output level you want to adjust and then press LEVEL +/- on the front panel to adjust the output level.

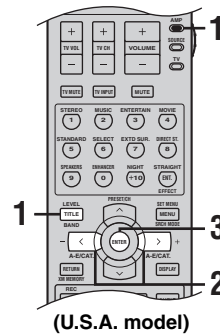

**1 Set the component selector switch to AMP and then press LEVEL on the remote control repeatedly to select the speaker you want to adjust.**

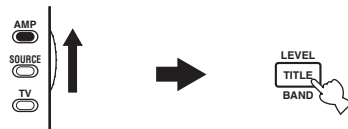

- Select "FRONT L" to adjust the front left speaker output level.
- Select "CENTER" to adjust the center speaker output level.
- Select "FRONT R" to adjust the front right speaker output level.
- Select "SUR. R" to adjust the surround right speaker output level.
- Select "SUR. B" to adjust the surround back speaker output level.
- Select "SUR. L" to adjust the surround left speaker output level.
- Select "SWFR" to adjust the subwoofer output level.

Once you press LEVEL on the remote control, you can also select the speaker by pressing ^ / ∨.

**2 Press </> on the remote control to adjust the speaker output level.**

- Press > to increase the value.
  - Press < to decrease the value.
- Control range: -10 dB to +10 dB

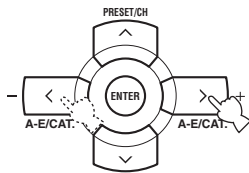

**3 Press ENTER on the remote control when you have completed your adjustment.**

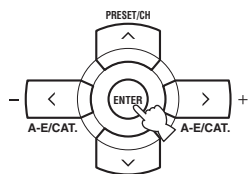

## Selecting the Compressed Music Enhancer mode

Compression artifacts (such as the MP3 format) are created by a lossy compression scheme where the audio is resampled to lower the bitrate and to remove sounds that are indistinguishable to typical human hearing. The Compressed Music Enhancer feature of this unit enhances your listening experience by regenerating the missing harmonics in a compression artifact. As a result, flattened complexity due to the loss of high-frequency fidelity as well as lack of bass due to the loss of low-frequency bass is compensated, providing the improved performance of the overall sound system.

### Notes

- The Compressed Music Enhancer mode is compatible with the PCM signals (32 kHz, 44.1 kHz and 48 kHz) and the analog 2-channel input sources.
- The Compressed Music Enhancer mode is not effective with any of the sound field programs.
- When the Compressed Music Enhancer mode is turned on while an incompatible input source is being played back, “Not Available” appears in the front panel display and in the OSD.
- When the input source is changed to an incompatible input source while the Compressed Music Enhancer mode is turned on, the Compressed Music Enhancer mode is automatically turned off and the incompatible input source is played back in 2-channel or 6-channel stereo.



The ENHANCER indicator lights up in the front panel display when one of the Compressed Music Enhancer modes is selected.



**1 Set the component selector switch to AMP and then press ENHANCER on the remote control repeatedly to select the desired Compressed Music Enhancer mode.**

The following display is shown in the OSD and the ENHANCER indicator lights up in the front panel display.

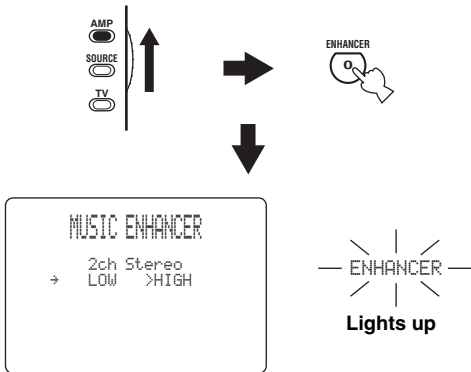

- Choices: **2ch Stereo**, 6ch Stereo, Off
- Select “2ch Stereo” to play back compression artifacts in 2-channel stereo.
  - Select “6ch Stereo” to play back compression artifacts in 6.1-channel stereo.
  - Select “Off” to turn off the Compressed Music Enhancer mode.

**Note**

When you select “Off”, this unit returns to the previously selected sound field program.

**2 Press </> on the remote control to select the desired effect level.**

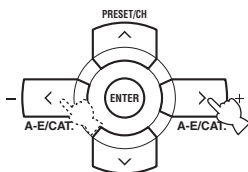

- Choices: **HIGH**, LOW
- Select “HIGH” for a high effect level.
  - Select “LOW” for a low effect level.

**Note**

Set the effect level to “HIGH” or “LOW” according to the characteristics of a source. The high-frequency signals of some sources may be emphasized too much. In this case, set the effect level to “LOW”.

**Selecting the MULTI CH INPUT component**

Use this feature to select the component connected to the MULTI CH INPUT jacks (see page 23) as the input source.

Press MULTI CH INPUT on the front panel (or MULTI CH IN on the remote control) so that “MULTI CH INPUT” appears in the front panel display.

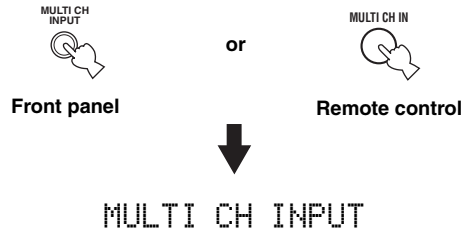

**Note**

When “MULTI CH INPUT” is shown in the front panel display, no other source can be played. To select another input source with the INPUT selector on the front panel (or one of the input selector buttons), press MULTI CH INPUT (or MULTI CH IN on the remote control) so that “MULTI CH INPUT” disappears from the front panel display.

## Enjoying multi-channel sources in 2-channel stereo

You can mix down multi-channel sources to 2 channels and enjoy playback in 2-channel stereo.

Set the component selector switch to AMP and then press STEREO on the remote control repeatedly to select “2ch Stereo”.

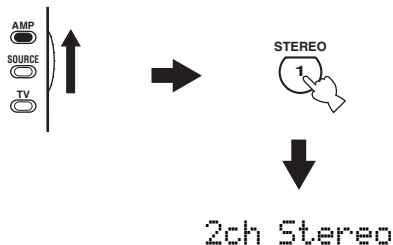

- You can use a subwoofer with this program when “LFE/BASS OUT” is set to “SWFR” or “BOTH” (see page 79).
- You can also select the “2ch Stereo” mode by pressing PROGRAM <|/> on the front panel repeatedly.

## Enjoying unprocessed input sources

When this unit is in the “STRAIGHT” mode, 2-channel stereo sources are output from only the front left and right speakers. Multi-channel sources are decoded straight into the appropriate channels without any additional effect processing.

- 1 Set the component selector switch to AMP and then press STRAIGHT on the remote control to select “STRAIGHT”.

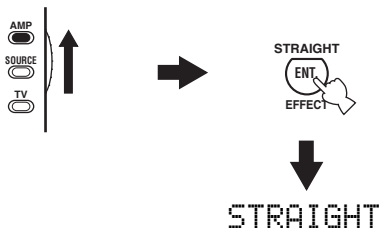

- 2 To deactivate the “STRAIGHT” mode, press STRAIGHT on the remote control again so that “STRAIGHT” disappears from the front panel display.

The sound effect is turned back on.



You can also select the “STRAIGHT” mode by pressing STRAIGHT (EFFECT) on the front panel.

## Enjoying pure hi-fi stereo sound

The “DIRECT STEREO” mode allows sources to bypass the decoders and DSP processors of this unit so that you can enjoy pure hi-fi sound from 2-channel PCM and analog sources.

Set the component selector switch to AMP and then press DIRECT ST. on the remote control to select “DIRECT STEREO”.

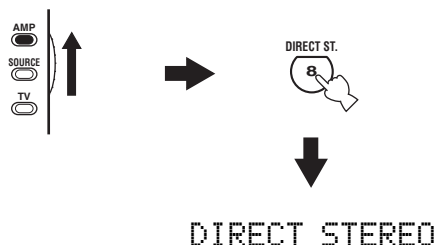

### Notes

- To avoid unexpected noise, do not play CDs encoded in DTS when the “DIRECT STEREO” mode is selected.
- When multi-channel signals (Dolby Digital and DTS) are input, this unit automatically switches to the corresponding analog input. When “DTS” is selected as the input mode (see page 34), no sound will be output.
- No sound will be output from the subwoofer.
- “TONE CONTROL” (see page 32) and “SOUND MENU” (see page 78) settings (except for speaker level settings) are not effective.
- The front panel display automatically dims.



You can also select the “DIRECT STEREO” mode by pressing PROGRAM <|/> on the front panel repeatedly.

# USING VIDEO FEATURES

## Displaying the input source information

You can display the format, sampling frequency, channel, bit rate and flag data of the current input signal.

- 1 **Set the component selector switch to AMP and then press SET MENU on the remote control.**

The top "SET MENU" display appears in the OSD.



- 2 **Press  $\nabla$  repeatedly to select "SIGNAL INFO" and then press ENTER.**

The following information about the input source appears in the OSD.

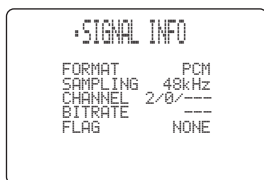
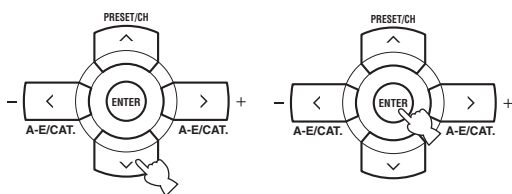

### Signal format FORMAT

Signal format display. When this unit cannot detect a digital signal, it automatically switches to analog input.

Display status: Analog, Digital, Dolby D, DTS, PCM, ---

#### Note

"---" appears when this unit cannot detect any signals.

### Sampling frequency SAMPLING

The number of samples per second taken from a continuous signal to make a discrete signal.

Display status: 32kHz, 44.1kHz, 48kHz, 64kHz, 88.2kHz, 96kHz, ---

#### Note

"---" appears when this unit cannot detect the sampling frequency.

### Channel CHANNEL

The number of source channels in the input signal (front/surround/LFE). For example, a multi-channel soundtrack with 3 front channels, 2 surround channels and LFE, is displayed as "3/2/0.1".

#### Note

"---" appears when there is no source channel available.

### Bit rate BITRATE

The number of bits passing a given point per second.

#### Note

"---" appears when this unit cannot detect the bit rate.

### Flag FLAG

Flag data encoded in DTS, Dolby Digital, or PCM signals that cue this unit to automatically switch decoders.

- 3 **Press SET MENU on the remote control again to exit from "SET MENU".**



## Selecting the OSD mode

You can display the operating information of this unit on a video monitor. If you display the "SET MENU" and sound field program parameter settings on a video monitor, it is much easier to see the available options and parameters than it is to read the information in the front panel display.

**1 Turn on the video monitor connected to this unit.**

**2 Set the component selector switch to AMP and then press DISPLAY on the remote control repeatedly to toggle between the OSD modes.**

The OSD mode changes in the following order.

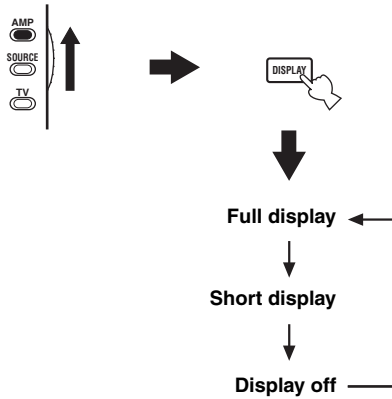

### Full display

Fully shows the sound field program parameter settings as well as the contents of the front panel display.

### Short display

Briefly shows the contents of the front panel display at the bottom of the screen each time you operate this unit.

### Display off

No information is displayed except for the "SET MENU" screen.

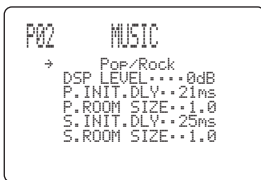

Full display

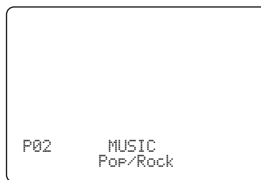

Short display



You can display a gray background in the OSD when there is not video signal being input by setting "GRAY BACK" in "OPTION MENU" to "AUTO" (see page 86).

### Notes

- The OSD signal is not output at the DVR OUT jacks and will not be recorded.
- You must set "VIDEO CONV." in "OPTION MENU" to "ON" (see page 85) to display the OSD.
- To display the OSD with the component video signals output at the COMPONENT VIDEO MONITOR OUT jacks, set the OSD mode to the full display mode.
- When "GRAY BACK" in "OPTION MENU" is set to "OFF" (see page 86), the OSD may not be displayed correctly depending on the conditions of the picture.

## Playing video sources in the background

You can combine a video image from a video source with sound from an audio source. For example, you can enjoy listening to classical music while viewing beautiful scenery from the video source on the video monitor.

**Press the input selector buttons on the remote control to select a video source and then an audio source.**

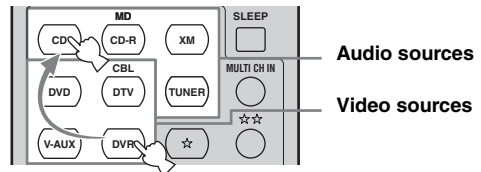

### Note

If you want to enjoy an audio source input at the MULTI CH INPUT jacks together with a video source, first select the video source and then press MULTI CH INPUT on the front panel (or MULTI CH IN on the remote control) to select the component connected to the MULTI CH INPUT jacks as the input source (see page 37).

# ENJOYING SURROUND SOUND

## Enjoying multi-channel sources in surround

If you connected a surround back speaker, use this feature to enjoy 6.1-channel playback for multi-channel sources using the Dolby Pro Logic IIX, Dolby Digital EX or DTS-ES decoders.

- 1 Set the component selector switch to AMP and then press **EXTD SUR.** on the remote control repeatedly to switch between 5.1 and 6.1-channel playback.

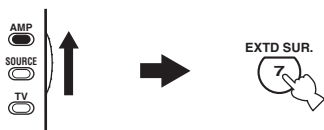

- 2 Press **</>** repeatedly to select a decoder while “PLIIXMusic” (etc.) is displayed.

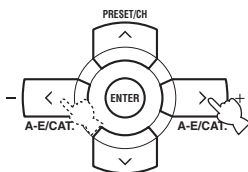

### Auto AUTO

When a signal flag that can be recognized by this unit is input, this unit selects the optimum decoder to play back the signal in 6.1 channels.

If this unit cannot recognize the flag or no flag is present in the input signal, it cannot automatically be played in 6.1 channels.

### Decoders

You can select from the following decoders depending on the format of the source you are playing.

Decoder	Functions
PLIIXMusic	Plays back Dolby Digital or DTS signals in 6.1 channels using the Pro Logic IIX music decoder.
EX/ES	Plays back Dolby Digital or DTS signals in 6.1 channels using the Dolby Digital EX or DTS-ES decoder.
EX	Plays back Dolby Digital or DTS signals in 6.1 channels using the Dolby Digital EX decoder.

### Off OFF

Decoders are not used to create 6.1 channels.

### Notes

- Some 6.1-channel compatible discs do not have a signal flag that can be automatically detected by this unit. When playing these kinds of discs in 6.1 channels, select a decoder manually from “PLIIX Music”, “EX/ES” or “EX”.
- 6.1-channel playback is not possible even if you press **EXTD SUR.** in the following cases:
  - when “SUR. L/R SP” (see page 79) or “SUR. B SP” (see page 79) is set to “NONE”.
  - when the component connected to the MULTI CH INPUT jacks is being played.
  - when the source being played does not contain surround left and right channel signals.
  - when a Dolby Digital KARAOKE source is being played.
  - when the “2ch Stereo” (see page 38) or “DIRECT STEREO” (see page 38) mode is selected.
- When this unit is set to the standby mode, this setting will be reset to “AUTO”.
- The Pro Logic IIX decoder is not available when “SUR. B SP” is set to “NONE” (see page 79).

## Enjoying 2-channel sources in surround

Signals input from 2-channel sources can also be played back on multi-channels.

- 1 Set the component selector switch to AMP and then press STANDARD on the remote control repeatedly to switch between the “SUR. STANDARD” and “SUR. ENHANCED” programs or press MOVIE to select the “MOVIE THEATER” program.

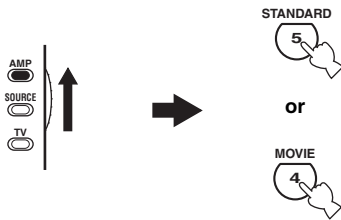

- 2 Press SELECT on the remote control repeatedly to select the desired decoder.



You can select from the following modes depending on the type of source you are playing and your personal preference.



You can also select a decoder by pressing </> on the remote control while the decoder type is displayed in the front panel display.

SUR. STANDARD	Functions
PRO LOGIC	Dolby Pro Logic processing for any sources
PLII Movie	Dolby Pro Logic II processing for movie sources
PLII Music	Dolby Pro Logic II processing for music sources
PLII Game	Dolby Pro Logic II processing for game sources
PLIIx Movie	Dolby Pro Logic IIx processing for movie sources
PLIIx Music	Dolby Pro Logic IIx processing for music sources
PLIIx Game	Dolby Pro Logic IIx processing for game sources
Neo:6 Cinema	DTS processing for movie sources
Neo:6 Music	DTS processing for music sources
Neural Sur.	Neural Surround processing for any sources (U.S.A. and Canada models only)

SUR. ENHANCED or MOVIE THEATER	Functions
PRO LOGIC	Dolby Pro Logic processing for any sources
PLII Movie	Dolby Pro Logic II processing for movie sources
PLIIx Movie	Dolby Pro Logic IIx processing for movie sources
Neo:6 Cinema	DTS processing for movie sources

### Notes

- The Pro Logic IIx decoder is not available when “SUR. B SP” is set to “NONE” (see page 79).
- The Neural Surround decoder is compatible with the PCM signals (32 kHz, 44.1 kHz and 48 kHz) and the analog 2-channel input sources.
- The Neural Surround decoder is not effective with any of the sound field programs.
- When Neural Surround-incompatible signals are being input while the Neural Surround decoder is selected, multi-channel sources are decoded straight into the appropriate channels without any additional effect processing and the Neural Surround-incompatible PCM signals are played back in stereo.

## Using Virtual CINEMA DSP

Virtual CINEMA DSP allows you to enjoy the CINEMA DSP programs without surround speakers. It creates virtual speakers to reproduce the natural sound field. If you set “SUR. L/R SP” to “NONE” (see page 79), Virtual CINEMA DSP activates automatically whenever you select a CINEMA DSP sound field program (see page 64).

### Note

Virtual CINEMA DSP will not activate even when “SUR. L/R SP” is set to “NONE” (see page 79) in the following cases:

- when the component connected to the MULTI CH INPUT jacks is selected as the input source (see page 37).
- when headphones are connected to the PHONES jack.
- when the “DIRECT STEREO” (see page 38) or “2ch Stereo” mode (see page 38) is selected, or when this unit is in the “STRAIGHT” mode (see page 38).

# RECORDING

Recording adjustments and other operations are performed from the recording components. Refer to the operating instructions for those components.

## CAUTION

The DTS signal is a digital bitstream. Attempting to digitally record the DTS bitstream will result in noise being recorded. Therefore, if you want to use this unit to record sources encoded in DTS, the following considerations and adjustments need to be made. To play DTS-encoded DVDs and CDs (when using a digital audio connection) on your DTS-compatible player, follow its operating instructions to make a setting so that the analog signal will be output from the player.

## Notes

- When this unit is set to the standby mode, you cannot record between other components connected to this unit.
- The settings of TONE CONTROL (see page 32), VOLUME, the speaker level (see page 80) and the sound field programs (see page 64) do not affect the recorded material.
- The source connected to the MULTI CH INPUT jacks of this unit cannot be recorded.
- S-video and composite video signals pass independently through the video circuits of this unit. Therefore, when recording or dubbing video signals input from a video source component that provides only an S-video or a composite video signal, you can record only an S-video or a composite video signal on your VCR.
- Digital signals input at the DIGITAL INPUT jacks are not output at the analog AUDIO OUT (REC) jacks for recording. Likewise, analog signals input at the AUDIO IN or PORTABLE jacks are not output at the DIGITAL OUTPUT jack. Therefore, if your source component is connected to provide only digital or analog signals, you can only record digital or analog signals.
- A given input source is not output on the same OUT (REC) channel.
- Check the copyright laws in your country to record from CDs, radio, etc. Recording of copyrighted material may infringe copyright laws.
- The XM Satellite Radio (U.S.A. model only) signals cannot be output at the AUDIO OUT (REC) jacks.
- The analog audio signals input at the DOCK terminal can be output at the analog AUDIO OUT (REC) jacks for recording.



Do a test recording before you start an actual recording.

If you play back a video source that uses scrambled or encoded signals to prevent it from being dubbed, the picture itself may be disturbed due to those signals.

(U.S.A. model)

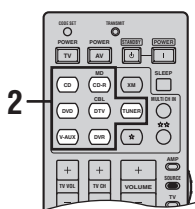
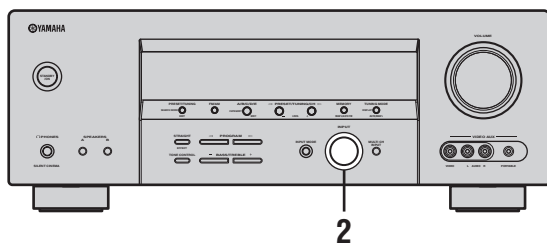

(U.S.A. model)

**1 Turn on all the connected components.**

**2 Rotate the INPUT selector on the front panel (or press one of the input selector buttons on the remote control) to select the source component you want to record from.**

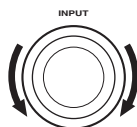

Front panel

or

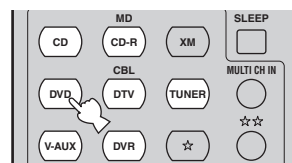

Remote control

**3 Start playback on the selected source component or select a broadcast station.**

**4 Start recording on the recording component.**



# FM/AM TUNING

There are 2 tuning methods: automatic and manual. Automatic tuning is effective when station signals are strong and there is no interference. If the signal from the station you want to select is weak, tune into it manually. You can also use the automatic and manual preset tuning features to store up to 40 stations (A1 to E8: 8 preset station numbers in each of the 5 preset station groups). Furthermore, you can recall any preset stations and exchange the assignment of two preset stations with each other.

## Note

Orient the connected FM and AM antennas for the best reception.

## Automatic tuning

Automatic tuning is effective when station signals are strong and there is no interference.

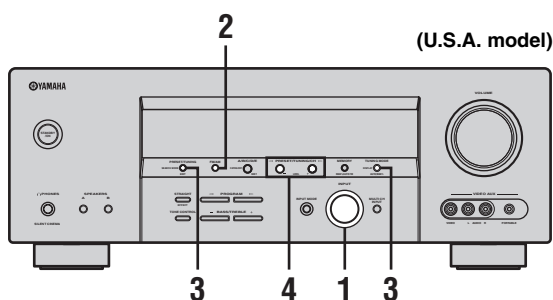

- 1 Rotate the INPUT selector to select "TUNER" as the input source.

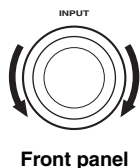

- 2 Press FM/AM to select the reception band. "FM" or "AM" appears in the front panel display.



- 3 Press TUNING MODE (AUTO/MAN'L) so that the AUTO indicator lights up in the front panel display.

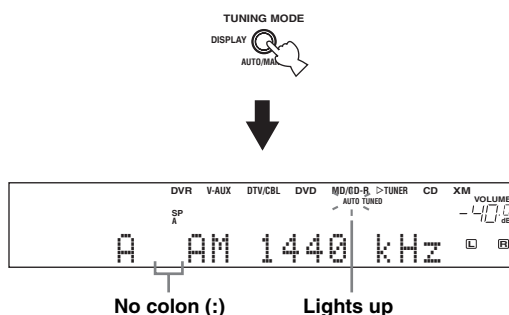

If a colon (:) appears in the front panel display, tuning is not possible. Press PRESET/TUNING to turn the colon (:) off.



- 4 Press PRESET/TUNING/CH </> once to begin automatic tuning.

When this unit is tuned into a station, the TUNED indicator lights up and the frequency of the received station is shown in the front panel display.

- Press > to tune into a higher frequency.
- Press < to tune into a lower frequency.

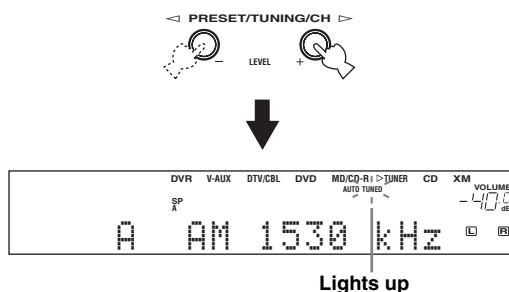

## Manual tuning

If the signal received from the station you want to select is weak, tune into it manually.

### Note

Manually tuning into an FM station automatically switches the tuner to monaural reception to increase the signal quality.

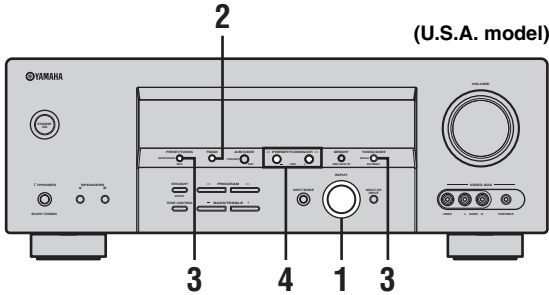

- 1 Rotate the INPUT selector to select "TUNER" as the input source.



- 2 Press FM/AM to select the reception band. "FM" or "AM" appears in the front panel display.



- 3 Press TUNING MODE (AUTO/MAN'L) so that the AUTO indicator disappears from the front panel display.

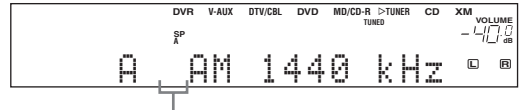
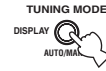

No colon (:)

If a colon (:) appears in the front panel display, tuning is not possible. Press PRESET/TUNING to turn the colon (:) off.



- 4 Press PRESET/TUNING/CH </> to tune into the desired station manually. Hold down the button to continue searching.



## Automatic preset tuning

You can use the automatic preset tuning feature to store FM stations with strong signals up to 40 (A1 to E8: 8 preset station numbers in each of the 5 preset station groups) of those stations in order. You can then recall any preset station easily by selecting the preset station number.

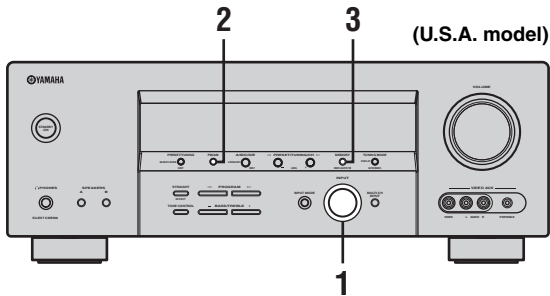

- 1 Rotate the INPUT selector to select "TUNER" as the input source.

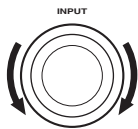

Front panel

- 2 Press FM/AM to select "FM" as the reception band.

"FM" appears in the front panel display.



- 3 Press and hold MEMORY (MAN'L/AUTO FM) for more than 3 seconds.

The preset station number as well as the MEMORY and AUTO indicators flashes. After approximately 5 seconds, automatic presetting starts from the current frequency and proceeds toward the higher frequencies.

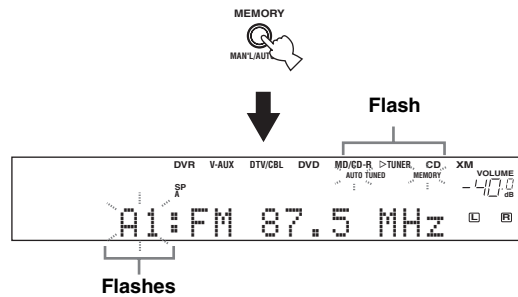

When automatic preset tuning is completed, the front panel display shows the frequency of the last preset station.



You can specify the preset number from which this unit stores FM stations and/or begins tuning toward lower frequencies. For details, see "Automatic preset tuning options" on page 48.

### Notes

- Any stored station data existing under a preset station number is cleared when you store a new station under the same preset station number.
- If the number of received stations does not reach 40 (E8), automatic preset tuning automatically stops after searching for all the available stations.
- Only FM stations with sufficient signal strength are stored automatically by automatic preset tuning. If the station you want to store is weak in signal strength, tune into it manually and store it as described in "Manual preset tuning" on page 48.

### Automatic preset tuning options

You can specify the preset number from which this unit stores FM stations and/or begins tuning toward lower frequencies.

**Note**

First carry out steps 1 through 3 in “Automatic preset tuning” on page 47.

- Press A/B/C/D/E and then PRESET/TUNING/CH ◀ / ▶ to select the preset station number under which the first station will be stored. Automatic preset tuning stops when stations have all been stored up to E8.



- Press PRESET/TUNING so that the colon (:)  
disappears from the front panel display and then press PRESET/TUNING/CH ◀ to begin tuning toward lower frequencies.



## Manual preset tuning

You can also store up to 40 stations (A1 to E8: 8 preset station numbers in each of the 5 preset station groups) manually.

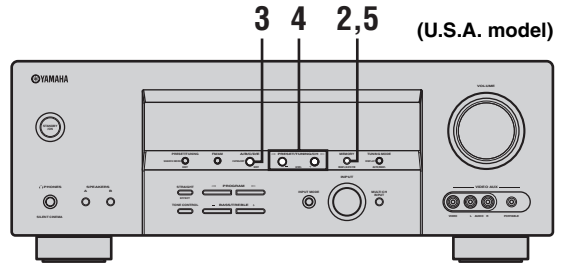

- 1 Tune into a station automatically or manually. See pages 45 and 46 for tuning instructions.

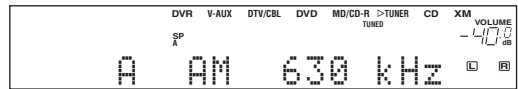

When this unit is tuned into a station, the front panel display shows the frequency of the station received.

- 2 Press MEMORY (MAN'L/AUTO FM).

The MEMORY indicator flashes in the front panel display for approximately 5 seconds.

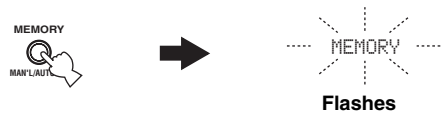

- 3 Press A/B/C/D/E repeatedly to select a preset station group (A to E) while the MEMORY indicator is flashing.

The selected preset station group letter appears. Check that the colon (:) appears in the front panel display.

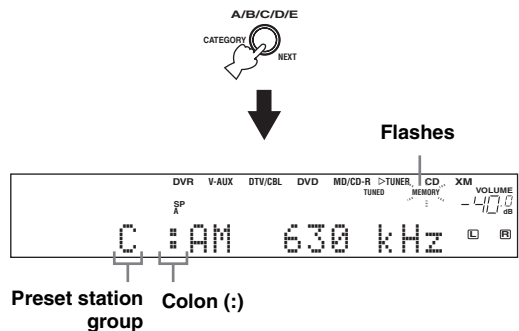

**4** Press PRESET/TUNING/CH ◀/▶ to select a preset station number (1 to 8) while the MEMORY indicator is flashing.

- Press ▶ to select a higher preset station number.
- Press ◀ to select a lower preset station number.



Flashes

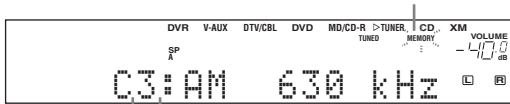

Preset station number

**5** Press MEMORY (MAN'L/AUTO FM) while the MEMORY indicator is flashing.

The station band and frequency appear in the front panel display with the preset station group and number you have selected. The MEMORY indicator disappears from the front panel display.

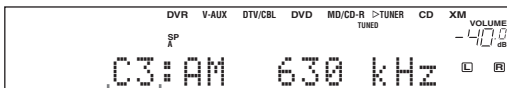

The displayed station has been stored as C3.

**6** Repeat steps 1 through 5 to store other stations.

**Notes**

- Any stored station data existing under a preset station number is cleared when you store a new station under the same preset station number.
- The reception mode (stereo or monaural) is stored along with the station frequency.

## Selecting preset stations

You can tune into any desired station simply by selecting the preset station group and number under which it was stored.

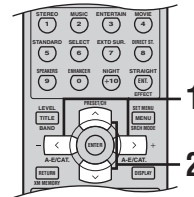
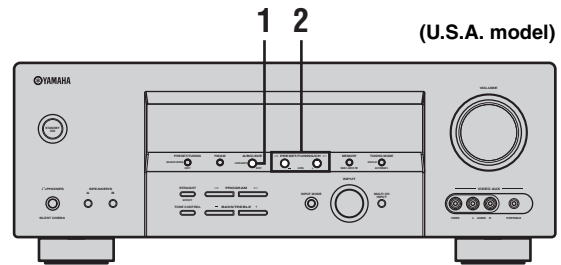

(U.S.A. model)



When performing this operation with the remote control, set the component selector switch to SOURCE and then press TUNER to select "TUNER" as the input source.

**1** Press A/B/C/D/E on the front panel (or A-E/CAT. ◀/▶ on the remote control) to select the desired preset station group (A to E).

The preset station group letter appears in the front panel display and changes each time you press the button.



Front panel

or

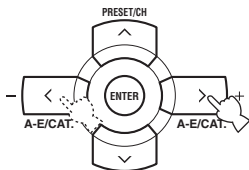

Remote control

- 2 Press PRESET/TUNING/CH ◀/▶ on the front panel (or PRESET/CH ^/▼ on the remote control) to select the desired preset station number (1 to 8).**

The preset station group and number appear in the front panel display along with the station band and frequency.

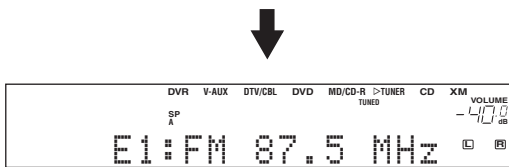
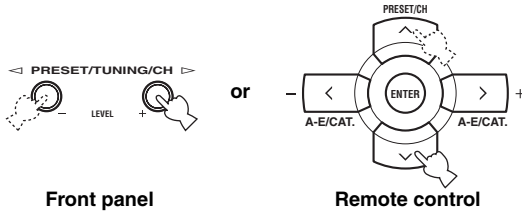

## Exchanging preset stations

You can exchange the assignments of two preset stations with each other. The example below describes the procedure to exchange preset station “E1” with “A5”.

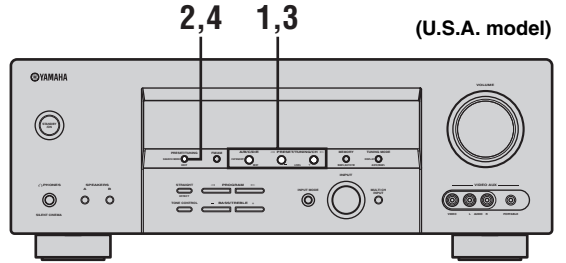

- 1 Select preset station “E1” using A/B/C/D/E and PRESET/TUNING/CH ◀/▶.**

See “Selecting preset stations” on page 49.

- 2 Press and hold EDIT for more than 3 seconds.**

“E1” and the MEMORY indicator flash in the front panel display.

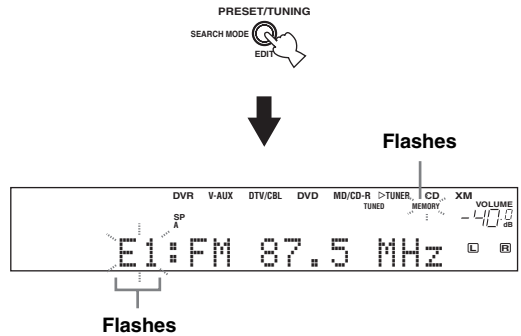

### 3 Select preset station “A5” using A/B/C/D/E and PRESET/TUNING/CH </>.

“A5” and the MEMORY indicator flash in the front panel display.

See “Selecting preset stations” on page 49.

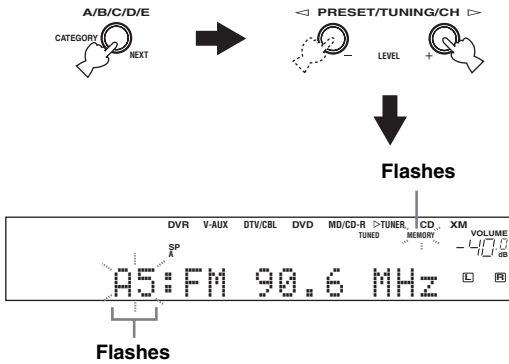

### 4 Press EDIT again.

“EDIT E1–A5” appears in the front panel display and the assignments of the two preset stations are exchanged.

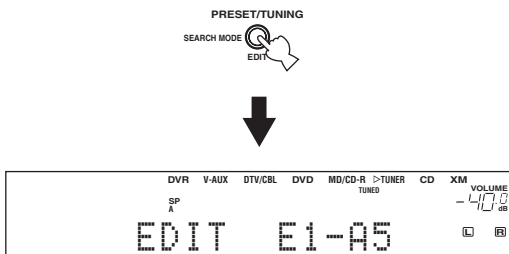

# XM<sup>®</sup> SATELLITE RADIO TUNING

XM Satellite Radio is the satellite radio service with millions of listeners across the United States, broadcasting live daily. The XM Satellite Radio channel lineup includes more than 150 digital channels of choice from coast to coast: 67 commercial-free music channels, featuring hip hop to opera, classical to country, bluegrass to blues; 33 channels of premier sports, talk, comedy, children's and entertainment programming; and more than 20 channels of the traffic and weather information for major metropolitan areas nationwide.

Because XM Satellite Radio is a subscription service, you will need to set up an account and activate service with XM using your XM Satellite Radio ID number. To check your ID number, follow "Activating XM Satellite Radio" on page 54. For further information on XM Satellite Radio services, visit the XM Satellite Radio website at "<http://www.xmradio.com/>".

This unit is equipped with the Neural Surround decoder (U.S.A. and Canada models only) that plays back the surround sound content of the XM Satellite Radio broadcasts in multi-channels, resulting in a full surround sound experience.

## Notes

- The XM Satellite Radio service is only available in the 48 contiguous United States (not available in Alaska and Hawaii).
- XM Connect-and-Play digital antenna accessory and monthly subscription are sold separately. For details, visit the XM Satellite Radio website at "<http://www.xmradio.com/>".
- For information on obtaining the XM Connect-and-Play digital antenna accessory, visit the XM Satellite Radio website at "<http://www.xmradio.com/>" or consult your local retailer that sells XM Ready products.
- To ensure the optimal reception of the XM Satellite Radio signals, the XM Connect-and-Play digital antenna accessory must be placed at or near a southerly facing window with no obstacles in the path to the sky. You can mount it indoors or outdoors.

## ■ Information from XM Satellite Radio Inc.

Hardware and required basic monthly subscription sold separately. Premium Channel available at additional monthly cost. Installation costs and other fees and taxes, including a one-time activation fee may apply. Subscription fee is consumer only. All fees and programming subject to change. Channels with frequent explicit language are indicated with an "XL". Channel blocking is available for XM radio receivers by calling "1-800-XM-RADIO (1-800-967-2346)". Subscriptions subject to Customer Agreement available at [xmradio.com](http://xmradio.com). Only available in the 48 continuous United States. © 2005 XM Satellite Radio Inc. All rights reserved. All other trademarks are the property of their respective owners.

## Connecting the XM Connect-and-Play digital antenna accessory

Connect the XM Connect-and-Play digital antenna accessory (sold separately) to the XM jack on the rear panel of this unit. For details, see the operating instructions provided with the XM Connect-and-Play digital antenna accessory.

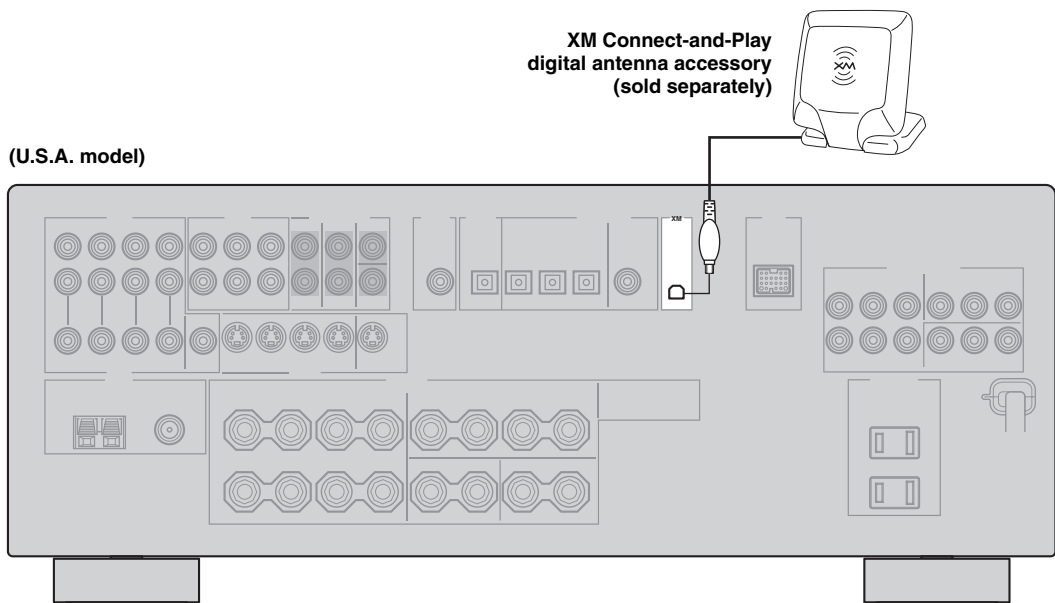



# XM Satellite Radio controls and functions

## Note

The following controls are available only when “XM” is selected as the input source. Rotate the INPUT selector on the front panel (or set the component selector switch to SOURCE and then press XM on the remote control) to select “XM” as the input source.

### ■ Front panel functions

(U.S.A. model)

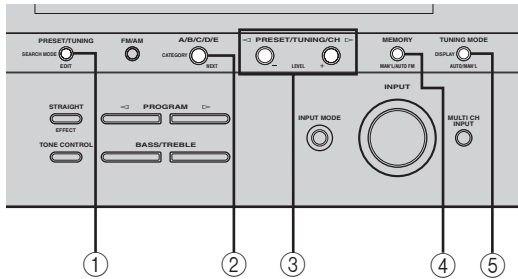

#### ① SEARCH MODE

Changes the search mode between the All Channel Search, Category Search, and Preset Search modes (see page 56).

#### ② CATEGORY

##### (All Channel Search mode)

Changes the channel category while staying in the All Channel Search mode.

##### (Category Search mode)

Changes the channel category.

##### (Preset Search mode)

Changes the preset channel group (A to E).

#### ③ PRESET/TUNING/CH </>

##### (All Channel Search mode)

Searches for a channel within all channels. Press and hold for quick search.

##### (Category Search mode)

Searches for a channel within the selected category. Press and hold for quick search.

##### (Preset Search mode)

Changes the preset channel number (1 to 8).

#### ④ MEMORY (MAN'L/AUTO FM)

Stores a preset channel in the memory (see page 60).

#### ⑤ DISPLAY

Displays the XM Satellite Radio information such as channel number, channel name, category, artist name, or song title displayed in the front panel display or in the OSD (see page 61).

### ■ Remote control functions

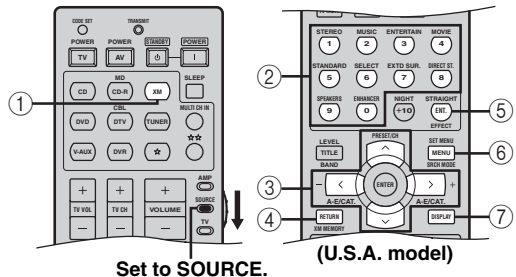

Set to SOURCE.

#### ① XM

Selects “XM” as the input source.

#### ② Numeric buttons

##### (All Channel Search or Category Search mode)

Use 1 to 9 and 0 to enter a channel number directly.

##### (Preset Search mode)

Use 1 to 8 to enter a preset channel number directly.

#### ③ Cursor buttons ^ / v / < / >

##### (All Channel Search mode)

Press A-E/CAT. </> to change the channel category.

Press PRESET/CH ^ / v to search for a channel within all channels. Press and hold for quick search.

##### (Category Search mode)

Press A-E/CAT. </> to change the channel category.

Press PRESET/CH ^ / v to search for a channel within the selected category. Press and hold for quick search.

##### (Preset Search mode)

Press A-E/CAT. </> to change the preset channel group (A to E).

Press PRESET/CH ^ / v to change the preset channel number (1 to 8).

#### ④ XM MEMORY

Stores a preset channel in the memory (see page 60).

#### ⑤ ENT.

Confirms an entered channel number in the Direct Number Access mode (see page 59).

#### ⑥ SRCH MODE

Changes the search mode between the All Channel Search, Category Search, and Preset Search modes (see page 56).

#### ⑦ DISPLAY

Displays the XM Satellite Radio information such as channel number, channel name, category, artist name, or song title displayed in the front panel display or in the OSD (see page 61).

## Activating XM Satellite Radio

To sign up for an account with the XM Satellite Radio service, an XM Satellite Radio ID number is required. Follow the procedure below to check your ID number, and then visit the website at “http://activate.xmradio.com/” or call “1-800-XM-RADIO (1-800-967-2346)” with a major credit card handy for signing up.

(U.S.A. model)

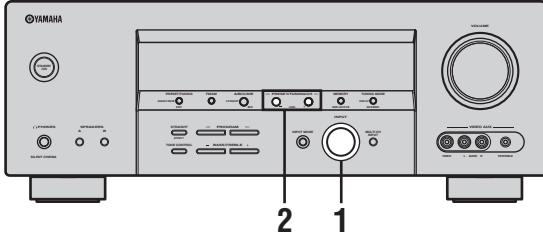

- 1 Rotate the INPUT selector on the front panel (or set the component selector switch to SOURCE and then press XM on the remote control) to select “XM” as the input source.**  
The cursor on the left of the XM indicator lights up in the front panel display.

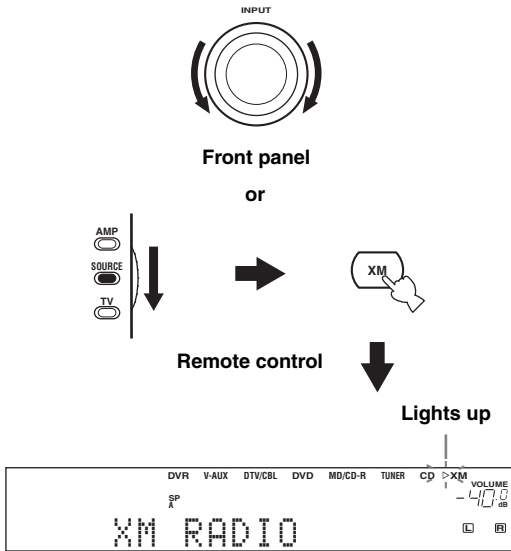

- 2 Check the XM Satellite Radio reception level and adjust the orientation of the XM Connect-and-Play digital antenna accessory for a better percentage of the reception level.**



You can display the XM Satellite Radio reception level by using the “XM ANTENNA” parameter in “OPTION MENU” (see page 87).

### Notes

- If “CHECK ANTENNA” appears in the front panel display, the XM Connect-and-Play digital antenna accessory may not be connected to the XM jack on the rear panel of this unit properly. See “Connecting the XM Connect-and-Play digital antenna accessory” on page 52 and check the connection.
- The “XM ANTENNA” parameter in “OPTION MENU” (see page 87) cannot be adjusted by using the remote control. Instead, you need to adjust the orientation of the XM Connect-and-Play digital antenna accessory connected to the XM jack of this unit for a better percentage of the reception level.

- 3 Press PRESET/TUNING/CH </> on the front panel (or PRESET/CH ^ / v on the remote control) to select channel “0”.**

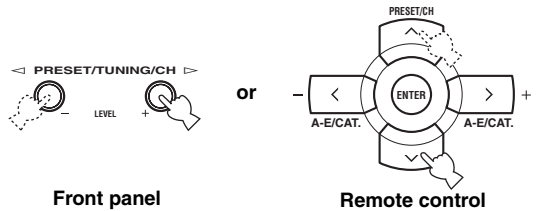

### Note

You cannot select channel “0” if the All Channel Search mode (see page 56) is not selected.

- 4 Check the XM Satellite Radio ID number displayed in the front panel display and write it down.**

ID: \_\_\_\_\_

## Basic XM Satellite Radio operations

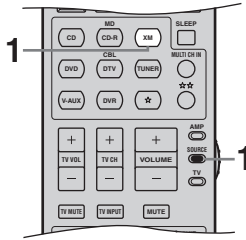

(U.S.A. model)

### 1 Set the component selector switch to SOURCE and then press XM on the remote control to select “XM” as the input source.

The cursor on the left of the XM indicator lights up in the front panel display and the XM Satellite Radio information (such as channel number, channel name, category, artist name, or song title) for the currently selected channel appears in the front panel display.

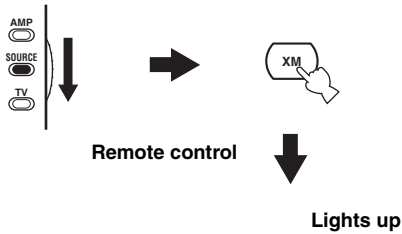

When you select “XM” as the input source, this unit automatically recalls the previously selected channel.

**Note**

The XM Satellite Radio signals cannot be output at the AUDIO OUT (REC) jacks.

### 2 Search for a channel by using one of the XM Satellite Radio search modes.

See “Selecting the XM Satellite Radio search mode” on page 56 for details.



- You can use the Neural Surround decoder to enjoy the surround sound content of the XM Satellite Radio broadcasts in multi-channels (see page 42).
- You can set the XM Satellite Radio preset channels (see page 60).
- You can display the XM Satellite Radio information in the front panel display or in the OSD (see page 61).

BASIC OPERATION

## Selecting the XM Satellite Radio search mode

You can search for the desired channel using one of the three search modes (All Channel Search, Category Search, and Preset Search modes). You can also enter the channel number directly to select the desired channel by using the Direct Number Access mode (see page 59).

### ■ All Channel Search mode

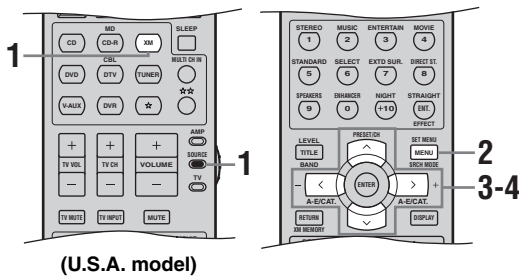
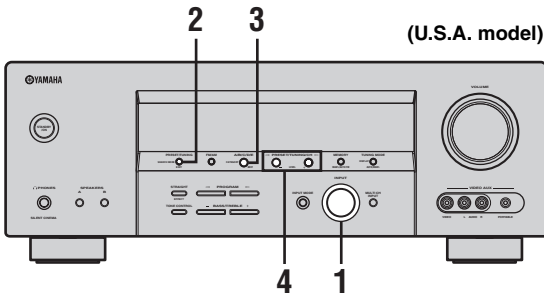

- 1 Rotate the INPUT selector on the front panel (or set the component selector switch to SOURCE and then press XM on the remote control) to select "XM" as the input source.

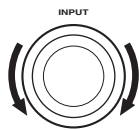

Front panel

or

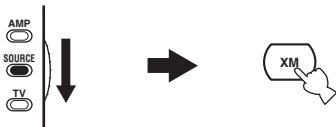

Remote control

- 2 Press SEARCH MODE on the front panel (or SRCH MODE on the remote control) repeatedly to select "ALL CH SEARCH".



Front panel

or



Remote control



- 3 Press CATEGORY on the front panel (or A-E/CAT. </> on the remote control) repeatedly to change the channel category.



Front panel

or

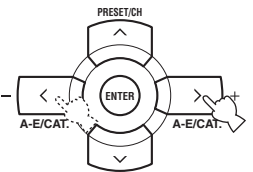

Remote control

- 4 Press PRESET/TUNING/CH </> on the front panel (or PRESET/CH ^ / v on the remote control) repeatedly to search for a channel within all channels.



Front panel

or

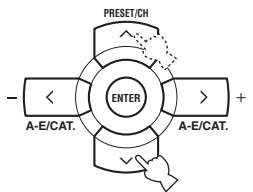

Remote control



You can search for a channel quickly by pressing and holding PRESET/TUNING/CH </> on the front panel (or PRESET/CH ^ / v on the remote control).

**Category Search mode**

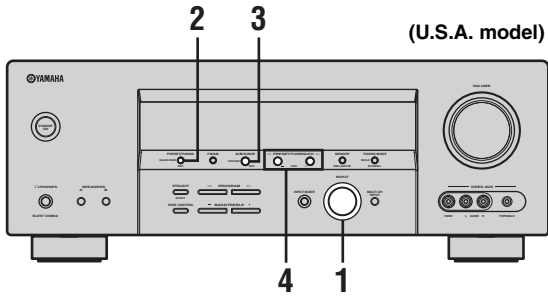

(U.S.A. model)

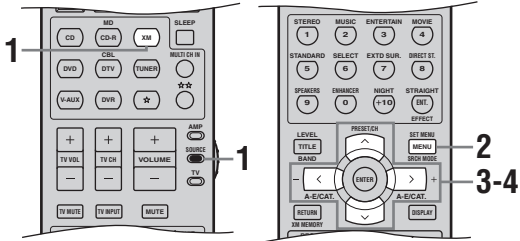

(U.S.A. model)

- 1 Rotate the INPUT selector on the front panel (or set the component selector switch to SOURCE and then press XM on the remote control) to select "XM" as the input source.

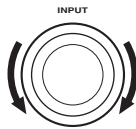

Front panel

or

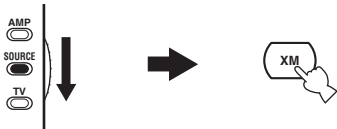

Remote control

- 2 Press SEARCH MODE on the front panel (or SRCH MODE on the remote control) repeatedly to select "CAT SEARCH".



Front panel

or



Remote control



- 3 Press CATEGORY on the front panel (or A-E/CAT. </> on the remote control) repeatedly to change the channel category.



Front panel

or

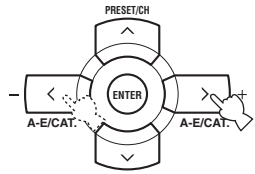

Remote control

- 4 Press PRESET/TUNING/CH </> on the front panel (or PRESET/CH ^ / v on the remote control) repeatedly to search for a channel within the selected channel category.



Front panel

or

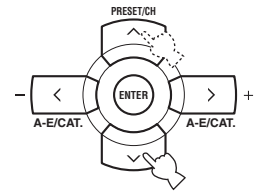

Remote control



You can search for a channel quickly by pressing and holding PRESET/TUNING/CH </> on the front panel (or PRESET/CH ^ / v on the remote control).

### ■ Preset Search mode

Prior to selecting a preset channel in the Preset Search mode, you must preset XM Satellite Radio channels. For details, see “Setting the XM Satellite Radio preset channels” on page 60.



All preset channels (A1 to E8) recalls “001 Preview” by the initial factory setting.

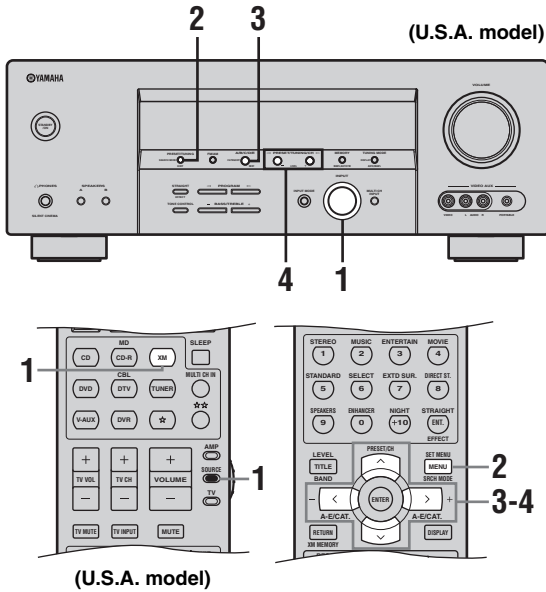

- 1 Rotate the INPUT selector on the front panel (or set the component selector switch to SOURCE and then press XM on the remote control) to select “XM” as the input source.

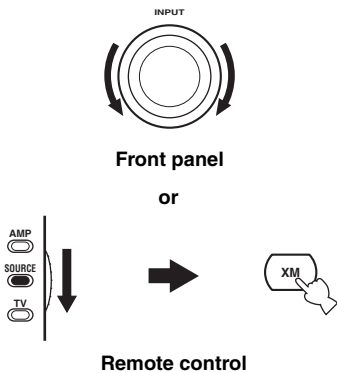

- 2 Press SEARCH MODE on the front panel (or SRCH MODE on the remote control) repeatedly to select “PRESET SEARCH”.

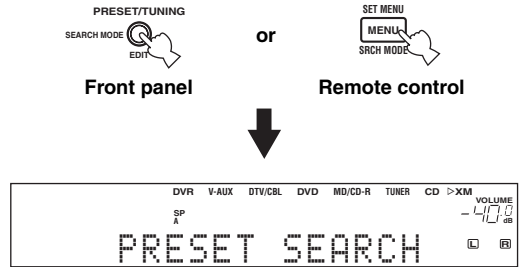

- 3 Press CATEGORY on the front panel (or A-E/CAT. </> on the remote control) repeatedly to change the preset channel group (A to E).

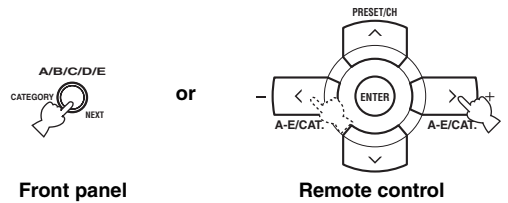

- 4 Press PRESET/TUNING/CH </> on the front panel (or PRESET/CH ^/∨ on the remote control) repeatedly to change the preset channel number (1 to 8).

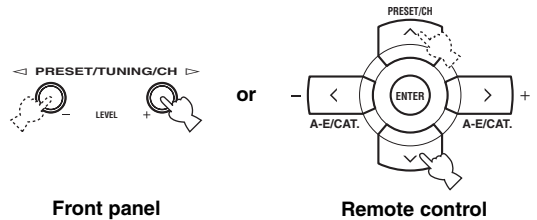

You can also select the preset channel number directly by pressing the numeric buttons (1 to 8) on the remote control.

■ Direct Number Access mode

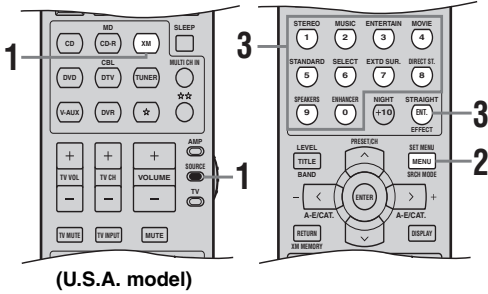

(U.S.A. model)

1 Set the component selector switch to **SOURCE** and then press **XM** on the remote control to select “XM” as the input source.

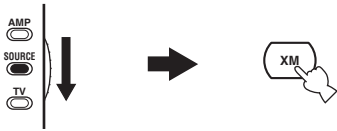

2 Press **SRCH MODE** on the remote control repeatedly to select “ALL CH SEARCH” or “CAT SEARCH”.

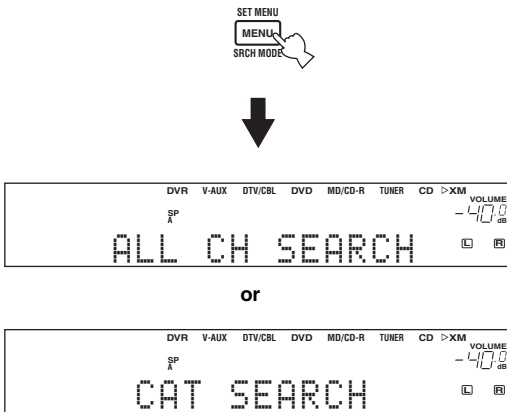

3 Press the numeric buttons on the remote control to enter the desired three-digit channel number.

For example, to enter the number 123, press the numeric buttons as shown below.



The display changes as follows.

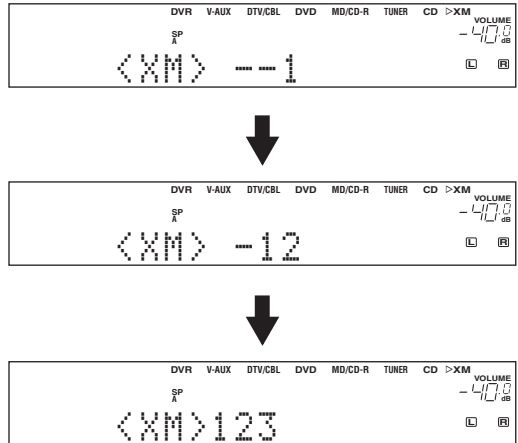

Press the numeric buttons and **ENT.** on the remote control to enter the desired one-digit or two-digit channel number.

For example, to enter the number 12, press the numeric buttons as shown below.



- Instead of pressing ENT. to tune into the channel immediately, you can wait a few seconds until this unit confirms the entered channel number.
- If no button is pressed within a few seconds after you enter a one-digit or two-digit number, this unit automatically confirms the entered channel number.
- Pressing a button other than the numeric buttons or ENT. cancels the Direct Number Access mode procedure.

## Setting the XM Satellite Radio preset channels

You can use this feature to store up to 40 XM Satellite Radio channels (A1 to E8: 8 preset channel numbers in each of the 5 preset channel groups). You can then recall any preset channel easily by selecting the preset channel group and number as described in “Preset Search mode” on page 58.

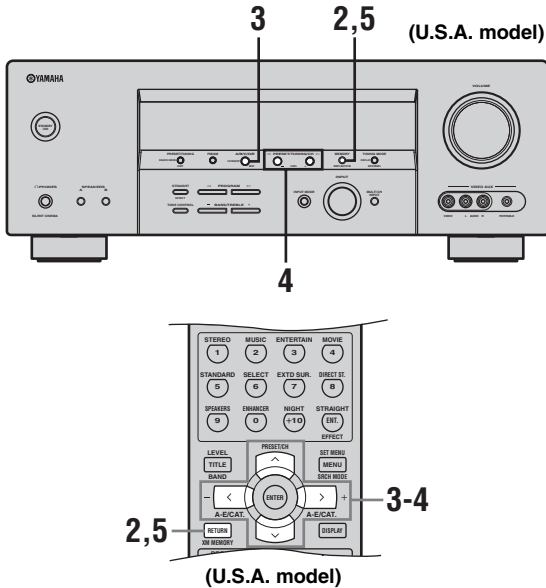

- 1 Search for a channel you want to set as a preset channel by using one of the XM Satellite Radio search modes.**  
See “Selecting the XM Satellite Radio search mode” on page 56 for details.

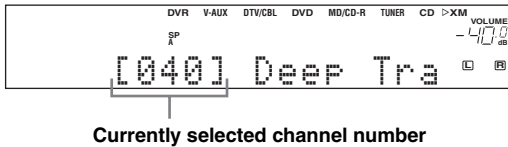

- 2 Press MEMORY on the front panel (or XM MEMORY on the remote control).**  
The MEMORY indicator flashes in the front panel display for approximately 5 seconds.

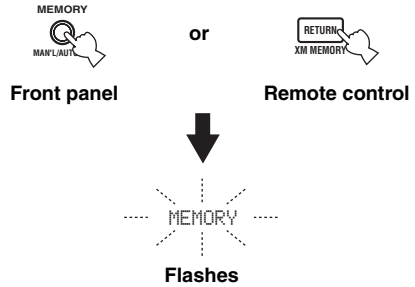

**Note**

You must proceed to and carry out steps 3 through 5 while the MEMORY indicator is flashing in the front panel display.

- 3 Press CATEGORY on the front panel (or A-E/CAT. </> on the remote control) repeatedly to select a preset channel group (A to E) while the MEMORY indicator is flashing.**  
The preset channel group letter appears in the front panel display.

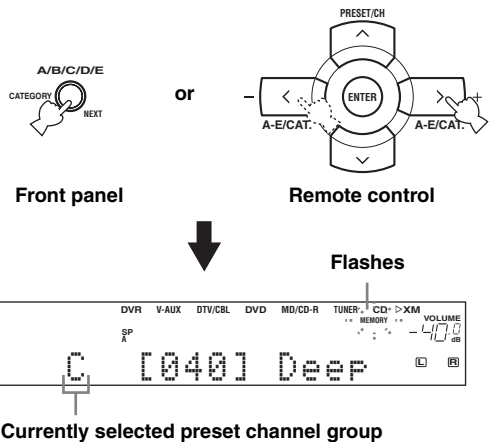



- 4 Press PRESET/TUNING/CH ◀/▶ on the front panel (or PRESET/CH ^/▼ on the remote control) repeatedly to select a preset channel number (1 to 8) while the MEMORY indicator is flashing.**

The preset channel number appears in the front panel display.

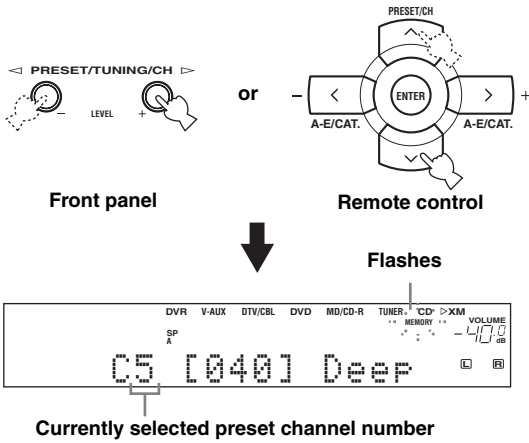

- 5 Press MEMORY on the front panel (or XM MEMORY on the remote control) to set the selected XM Satellite Radio channel as a preset channel while the MEMORY indicator is flashing.**

A colon (:) appears next to the preset channel number for confirmation, and the MEMORY indicator turns off in the front panel display.

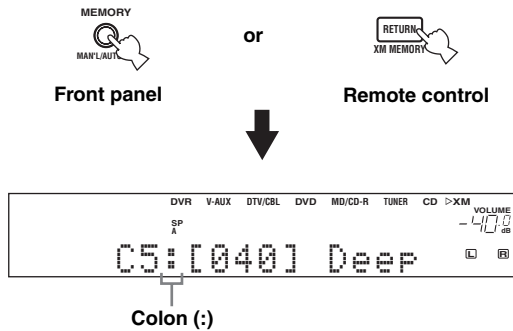

**Note**

Once you set a new preset channel, the one previously stored in the same preset channel group and number is cleared.

## Displaying the XM Satellite Radio information

You can display the XM Satellite Radio information (such as channel number, channel name, category, artist name, or song title) for the currently selected channel in the front panel display or in the OSD.

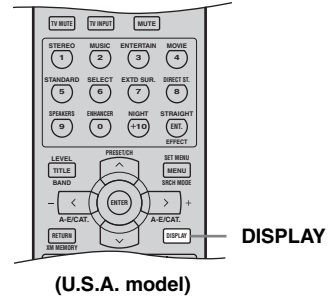
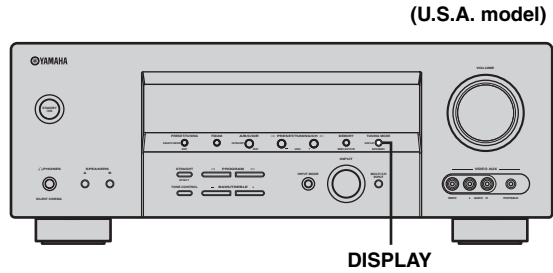

BASIC OPERATION

**Note**

If a status message or an error message appears in the front panel display or in the OSD, see the “XM Satellite Radio (U.S.A. model only)” section in “TROUBLESHOOTING” on page 101 for appropriate remedies.

### ■ Displaying the XM Satellite Radio information in the front panel display

Press DISPLAY on the front panel or on the remote control repeatedly to toggle between the following XM Satellite Radio information display modes.

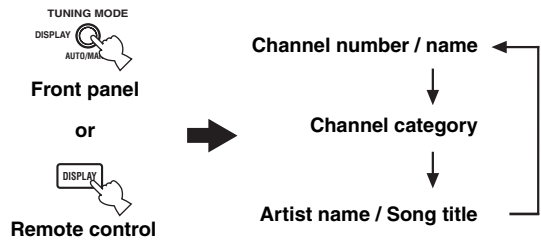

**When the channel number / name is displayed:**



**When the channel category is displayed:**



**When the artist name / song title is displayed:**



- The front panel display can indicate up to 14 alphanumeric characters at once. You can set whether to display the XM Satellite Radio information in the front panel display in a continuous manner or by 14 alphanumeric characters at once by using the "SCROLL" parameter in "OPTION MENU" (see page 87).
- If the XM Satellite Radio information contains a character that cannot be recognized by this unit, the character will be displayed with an underscore "\_".

**Note**

If you press DISPLAY while the XM Satellite Radio information display is scrolling from right to left in the front panel display, the XM Satellite Radio information display mode toggles as described above.

**■ Displaying the XM Satellite Radio information in the OSD**

**Press DISPLAY on the front panel or on the remote control.**

The following screen is displayed in the OSD.

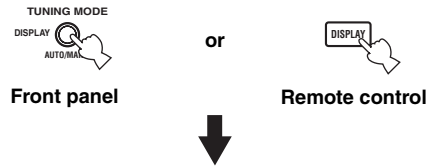

- You can select the amount of time while the XM Satellite Radio information is displayed in the OSD by using the "XM DISPLAY" parameter in "OPTION MENU" (see page 87).
- To hold the XM Satellite Radio information screen, press ENTER on the remote control while it is being displayed in the OSD.
- The XM Satellite Radio information screen on hold is released if you press ENTER on the remote control again or if you change the XM Satellite Radio channel.
- This unit can save up to two XM Satellite Radio information screens for future reference. To view the previous two XM Satellite Radio information screens, press TITLE on the remote control repeatedly while the current XM Satellite Radio information screen is being on hold.

# SOUND FIELD PROGRAMS

What really creates the rich, full tones of a live instrument are the multiple reflections from the walls of the room. In addition to making the sound live, these reflections enable us to tell where the player is situated as well as the size and shape of the room in which we are sitting.

## ■ Elements of a sound field

There are two distinct types of sound reflections that combine to make up the sound field in addition to the direct sound coming straight to our ears from the player's instrument.

### Early reflections

Reflected sounds reach our ears extremely rapidly (50 ms to 100 ms after the direct sound), after reflecting from one surface only (for example, from a wall or the ceiling). Early reflections actually add clarity to the direct sound.

### Reverberations

These are caused by reflections from more than one surface (for example, from the walls, and the ceiling) so numerous that they merge together to form a continuous sonic afterglow. They are non-directional and lessen the clarity of the direct sound.

Direct sound, early reflections and subsequent reverberations taken together help us to determine the subjective size and shape of the room, and it is this information that the digital sound field processor reproduces in order to create sound fields.

If you could create the appropriate early reflections and subsequent reverberations in your listening room, you would be able to create your own listening environment. The acoustics in your room could be changed to those of a concert hall, a dance floor, or a room with virtually any size at all. This ability to create sound fields at will is exactly what YAMAHA has done with the digital sound field processor.

## Selecting sound field programs

### Notes

- Choose a sound field program based on your listening preference, not merely on the name of the program.
- When you select an input source, this unit automatically selects the last sound field program used with the corresponding input source.
- Sound field programs cannot be selected when the component connected to the MULTI CH INPUT jacks is selected as the input source (see page 37).
- Sampling frequencies higher than 48 kHz (except for DTS 96/24 signals) are sampled down to 48 kHz and then sound field programs are applied.

## ■ Front panel operations

(U.S.A. model)

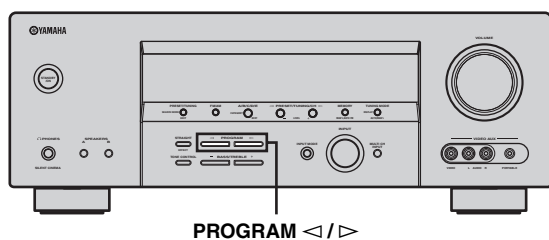

**Press PROGRAM </> on the front panel repeatedly.**

The name of the selected sound field program appears in the front panel display and in the OSD.

## ■ Remote control operations

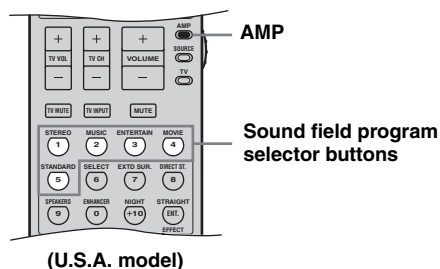

(U.S.A. model)

**Set the component selector switch to AMP and then press one of the sound field program selector buttons on the remote control repeatedly.**

The name of the selected sound field program appears in the front panel display and in the OSD.

## Sound field program descriptions

This unit is equipped with a variety of precise digital decoders that allow you to enjoy multi-channel playback from almost any stereo or multi-channel sound source. This unit is also equipped with a YAMAHA digital sound field processing (DSP) chip containing several sound field programs which you can use to enhance your playback experience.



The YAMAHA CINEMA DSP modes are compatible with all Dolby Digital, DTS, and Dolby Surround sources. Set “INPUT MODE” to “AUTO” (see page 34) to enable this unit to automatically switch to the appropriate digital decoder according to the input signal.

### Notes

- The DSP sound field programs of this unit are recreations of real-world acoustic environments made from precise measurements taken in the actual concert hall, music venue, movie theater, etc. Thus, you may notice variations in the strength of the reflections coming from the front, back, left and right.
- Choose a sound field program based on your listening preference, not merely on the name of the program itself.

### ■ For movie/video sources

You can select from the following sound fields when playing movie or video sources. The sound fields marked “MULTI” can be used with multi-channel sources, like DVD, digital TV, etc. Those marked “2-CH” can be used with 2-channel stereo sources like TV programs, video tapes, etc.



Press PROGRAM </> on the front panel repeatedly (or set the component selector switch to AMP and then press one of the sound field program selector buttons on the remote control) to select the desired sound field program (see page 63).

Remote control button	Sound field program	Features	Sources
1	STEREO 2ch Stereo	Downmixes multi-channel sources to 2 channels or plays back 2-channel sources as they are.	
2	MUSIC Pop/Rock	CINEMA DSP processing. Creates an enthusiastic atmosphere where you can feel as if you are in an actual jazz or rock concert.	
3	ENTERTAINMENT TV Sports	CINEMA DSP processing. Reproduces the sound environment of a large concert hall using the surround sound field to enhance your experience of watching various TV programs such as news, variety shows, music programs or sports programs.	MULTI 2-CH
	ENTERTAINMENT Mono Movie	CINEMA DSP processing. Reproduces monaural video sources (such as old movies) at the optimum reverberation level to create sound depth using only the presence sound field.	
	ENTERTAINMENT Game	CINEMA DSP processing. Adds a deep and spatial feeling to video game sounds.	

Remote control button	Sound field program	Features	Sources
4	MOVIE THEATER Spectacle	CINEMA DSP processing. This program reproduces the extremely wide sound field of a 70-mm movie theater in detail, making both the video and the sound field incredibly real. This is ideal for any kind of video source encoded in Dolby Surround, Dolby Digital or DTS, especially large-scale movie productions.	MULTI 2-CH
	MOVIE THEATER Sci-Fi	CINEMA DSP processing. This program reproduces dialog and sound effects in the latest sound form for science fiction films, thus creating a broad and expansive cinematic space amid silence. You can enjoy science fiction films encoded in Dolby Surround, Dolby Digital or DTS in a virtual-space sound field employing the most advanced techniques.	
	MOVIE THEATER Adventure	CINEMA DSP processing. This program reproduces the sound design of the newest 70-mm and multi-channel soundtrack films similar to the sound field of the newest movie theaters, so the reverberations of the sound field itself are restrained as much as possible.	
	MOVIE THEATER General	CINEMA DSP processing. This program reproduces sounds from 70-mm and multi-channel soundtrack films characterized by soft and extensive sound field.	
5	SUR. STANDARD	Standard processing for the selected decoder.	
	SUR. ENHANCED	Enhanced processing for the selected decoder.	

### ■ For music sources

You can select from the following sound fields when playing music sources, like CD, FM/AM broadcasting, tapes, etc.

 Press PROGRAM </> on the front panel repeatedly (or set the component selector switch to AMP and then press one of the sound field program selector buttons on the remote control) to select the desired sound field program (see page 63).

Remote control button	Sound field program	Features	Sources
1	STEREO 2ch Stereo	Plays back 2-channel sources.	2-CH
	STEREO 6ch Stereo	Plays back 2-channel sources from all speakers in 6.1 channels, providing a larger sound field ideal for background music at parties, etc.	
2	MUSIC Hall in Vienna	HiFi DSP processing. The program reproduces a classic shoe-box type concert hall with approximately 1700 seats. Pillars and ornate carvings create extremely complex reflections which produce a very full, rich sound.	MULTI 2-CH
	MUSIC The Btm Line	HiFi DSP processing. This program reproduces the stage front in "The Bottom Line", a famous New York jazz club where 300 people can be seated.	
	MUSIC The Roxy Thtr	HiFi DSP processing. This program reproduces the dynamic rock music environment of "The Roxy Theatre", one of the hottest rock clubs in L.A. The listener's imaginary seat is at the center-left of the hall.	
3	ENTERTAINMENT Disco	HiFi DSP processing. This program reproduces the acoustic environment of a lively disco in the heart of a big city to create a highly concentrated and energetic sound.	
5	SUR. STANDARD	Standard processing for the selected decoder.	
	SUR. ENHANCED	Enhanced processing for the selected decoder.	

## Changing sound field parameter settings

You can enjoy good quality sound with the initial factory settings. Although you do not have to change the initial factory settings, you can change some of the parameters to better suit the input source or your listening room.

### Notes

- Use the “PARAM. INT” feature in “OPTION MENU” to initialize the parameters of each sound field program within a sound field program group (see page 86).
- When you set a sound field parameter to a value other than the initial factory settings, an asterisk mark (\*) appears by the sound field parameter name in the OSD.
- You cannot change the sound field parameter values when “MEMORY GUARD” in “OPTION MENU” is set to “ON” (see page 86). If you want to change the sound field parameter values, set “MEMORY GUARD” to “OFF”.



- For details about the function and control range of each sound field parameter, see page 67.
- Repeat steps 3 and 4 as necessary to change other sound field program parameter settings.
- The available sound field parameters for some of the sound field programs may be displayed on more than one page in the OSD. In this case, press ^ / v to scroll through pages.
- If you press and hold < / > to change the sound field parameter value, the initial factory settings are shown momentarily in the front panel display.

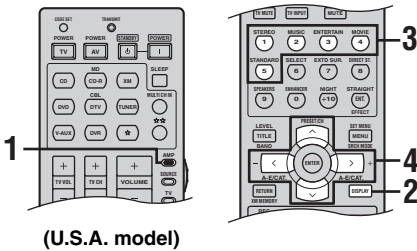

**1** Set the component selector switch to AMP.



**2** Turn on the video monitor and then press **DISPLAY** on the remote control.

The following display is shown in the OSD.

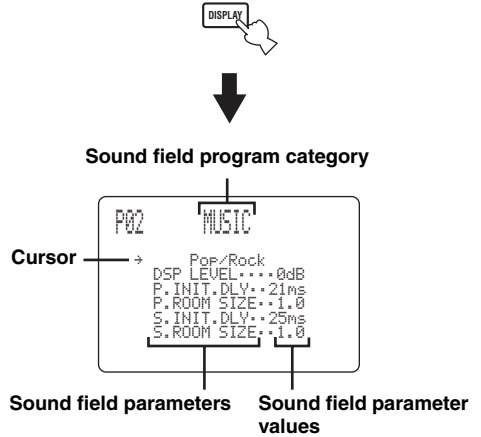

**3** Press one of the sound field program selector buttons repeatedly to select the desired sound field program you want to adjust.

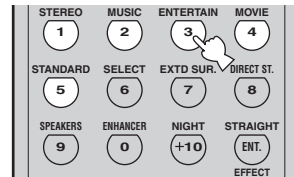

**4** Press ^ / v to select the desired sound field parameter and then < / > to change the selected sound field parameter value.

- Press > to increase the value.
- Press < to decrease the value.

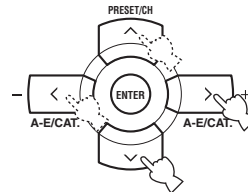

### ■ Sound field parameter descriptions

You can adjust the values of certain digital sound field parameters so that the sound fields are recreated accurately in your listening room. Not all of the following parameters are found in every program.



To change sound field parameter settings to suit your listening environment, see page 66 for details.

Sound field parameter	Features
DSP LEVEL	DSP level. Adjusts the level of all the DSP effect sounds within a narrow range. Depending on the acoustics of your listening room, you may want to increase or decrease the DSP effect level relative to the level of the direct sound.  Control range: -6 dB to +3 dB
INIT.DLY P. INIT.DLY S. INIT.DLY SB INI.DLY	Initial delay. Presence, surround, and surround back initial delay. Changes the apparent distance from the source sound by adjusting the delay between the direct sound and the first reflection heard by the listener. The smaller the value, the closer the sound source seems to the listener. The larger the value, the farther it seems. For a small room, set to a small value. For a large room, set to a large value.  Control range: 1 to 99 ms (INIT.DLY and P.INIT.DLY) 1 to 49 ms (S.INIT.DLY and SB INI.DLY)

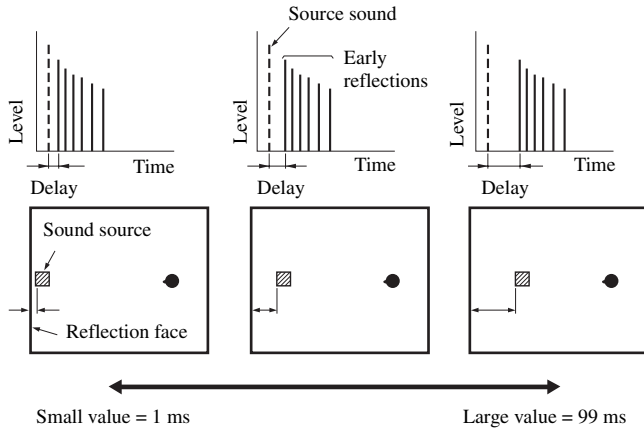

Sound field parameter	Features
ROOM SIZE P.ROOM SIZE S.ROOM SIZE SB ROOM SIZE	Room size. Presence, surround, and surround back room size. Adjusts the apparent size of the surround sound field. The larger the value, the larger the surround sound field becomes. As the sound is repeatedly reflected around a room, the larger the hall is, the longer the time between the original reflected sound and the subsequent reflections. By controlling the time between the reflected sounds, you can change the apparent size of the virtual venue. Changing this parameter from one to two doubles the apparent length of the room.
Control range: 0.1 to 2.0	

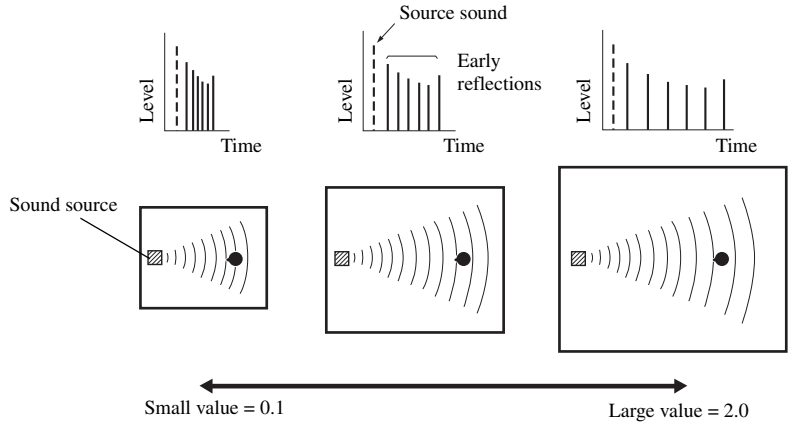

LIVENESS S.LIVENESS SB LIVENESS	Liveness. Surround and surround back liveness. Adjusts the reflectivity of the virtual walls in the hall by changing the rate at which the early reflections decay. The early reflections of a sound source decay much faster in a room with acoustically absorbent wall surfaces than in one which has highly reflective surfaces. A room with acoustically absorbent surfaces is referred to as "dead", while a room with highly reflective surfaces is referred to as "live". This parameter lets you adjust the early reflection decay rate and thus the "liveness" of the room.
Control range: 0 to 10	

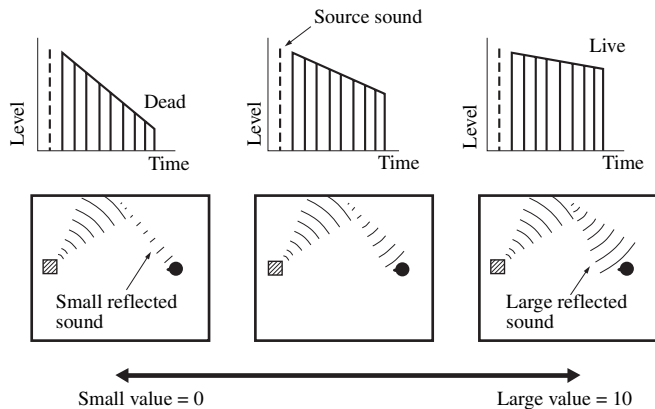



Sound field parameter	Features
-----------------------	----------

REV. TIME

Reverberation time. Adjusts the amount of time taken for the dense, subsequent reverberation sound to decay by 60 dB at 1 kHz. This changes the apparent size of the acoustic environment over an extremely wide range. Set a longer reverberation time for “dead” sources and listening room environments, and a shorter time for “live” sources and listening room environments.

Control range: 1.0 to 5.0 s

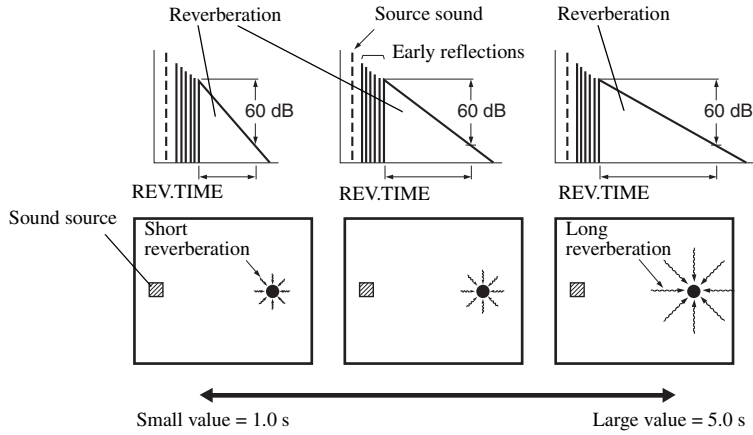

REV. DELAY

Reverberation delay. Adjusts the time difference between the beginning of the direct sound and the beginning of the reverberation sound. The larger the value, the later the reverberation sound begins. A later reverberation sound makes you feel as if you are in a larger acoustic environment.

Control range: 0 to 250 ms

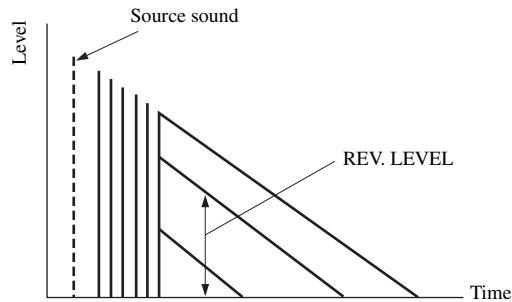

Sound field parameter	Features
REV. LEVEL	<p>Reverberation level. Adjusts the volume of the reverberation sound. The larger the value, the stronger the reverberation becomes.</p> <hr/> <p>Control range: 0 to 100%</p>

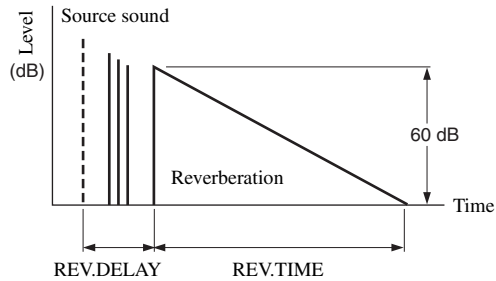

<p>2ch Stereo DIRECT</p>	<p>2-channel stereo direct. Bypasses the decoders and DSP processors of this unit for pure hi-fi stereo sound when playing 2-channel analog sources.</p> <hr/> <p>Choices: <b>AUTO</b>, OFF</p> <hr/> <p></p> <ul style="list-style-type: none"> <li>• The “AUTO” setting bypasses the decoders and DSP processors only when “BASS” and “TREBLE” are set to 0 dB (see page 32).</li> <li>• When multi-channel signals (Dolby Digital and DTS) are input, they are downmixed to 2 channels and output from the front left and right speakers.</li> <li>• The low-frequency signals input from the front left and right speakers are redirected to the subwoofer in the following cases: <ul style="list-style-type: none"> <li>– “LFE/BASS OUT” is set to “BOTH” (see page 79).</li> <li>– “FRONT SP” is set to “SMALL” (see page 78) and “LFE/BASS OUT” is set to “SWFR” (see page 79).</li> </ul> </li> </ul>
<p>6ch Stereo CT LEVEL SL LEVEL SR LEVEL SB LEVEL</p>	<p>6-channel stereo center, surround left, surround right and surround back levels. Adjusts the volume level of each channel in the 6-channel stereo mode.</p> <hr/> <p>Control range: 0 to 100%</p>

Sound field parameter	Features
PRO LOGIC IIx Music PRO LOGIC II Music PANORAMA	Pro Logic IIx Music and Pro Logic II Music panorama. Sends stereo signals to the surround speakers as well as the front speakers for a wraparound effect.  Choices: <b>OFF</b> , ON
PRO LOGIC IIx Music PRO LOGIC II Music DIMENSION	Pro Logic IIx Music and Pro Logic II Music dimension. Adjusts the sound field either towards the front or towards the rear.  Control range: -3 (towards the rear) to +3 (towards the front)  Initial setting: STD (standard)
PRO LOGIC IIx Music PRO LOGIC II Music CENTER WIDTH	Pro Logic IIx Music and Pro Logic II Music center width. Moves the center channel output completely towards the center speaker or towards the front left and right speakers. A larger value moves the center channel output towards the front left and right speakers.  Control range: 0 (center channel sound is output only from the center speaker) to 7 (center channel sound is output only from the front left and right speakers)  Initial setting: 3
DTS Neo:6 Music C. IMAGE	DTS Neo:6 Music center image. Adjusts the front left and right channel output relative to the center channel to make the center channel more or less dominant as necessary.  Control range: 0.0 to 1.0  Initial setting: 0.3

 The “PRO LOGIC IIx Music”, “PRO LOGIC II Music”, and “DTS Neo:6 Music” parameters can be set only when “SUR. STANDARD” is selected. Set the component selector switch to AMP and then press STANDARD on the remote control repeatedly to select “SUR. STANDARD” (see page 42).

## Sound field program speaker layouts

Sound output from each speaker depends on the type of audio signals being input. Refer to the diagrams in the table below to understand the speaker layout for each sound field program.

### Note

Be advised that there may be no or not enough sound output from speakers depending on the type of input source being played back. Furthermore, there may be some channels that can only be used partially when they are adjusted to specific aspects of movies, such as special sound effects, etc.



Except for “2ch Stereo”, “6ch Stereo”, and “STRAIGHT”, you can select a decoder to output sound from the surround back speaker (see page 41).

The abbreviations and symbols used in each diagram are as follows:

- |                                       |  |  |   |
|---------------------------------------|--|--|---|
| <input checked="" type="checkbox"/> L | Front left speaker                       | <input checked="" type="checkbox"/> SL | Surround left speaker                       |
| <input checked="" type="checkbox"/> C | Center speaker                           | <input checked="" type="checkbox"/> SR | Surround right speaker                      |
| <input checked="" type="checkbox"/> R | Front right speaker                      | <input checked="" type="checkbox"/> SB | Surround back speaker                       |
| <input checked="" type="checkbox"/>   | Speaker from which sound is being output | <input type="checkbox"/>               | Speaker from which no sound is being output |

\* When the **EX** / **PL IIx** / **ES** indicators are turned off in the front panel display

Sound field program	2-channel audio (monaural)	2-channel audio (stereo)	5.1/6.1-channel audio *
STEREO 2ch Stereo			
STEREO 6ch Stereo			
MUSIC Hall in Vienna The Btm Line The Roxv Thtr			
ENTERTAINMENT Disco			
MUSIC Pop/Rock			
ENTERTAINMENT TV Sports Mono Movie Game			

Sound field program	2-channel audio (monaural)	2-channel audio (stereo)	5.1/6.1-channel audio *
MOVIE THEATER Spectacle Sci-Fi Adventure General			
SUR. STANDARD DOLBY DIGITAL PRO LOGIC DTS			
	Pro Logic	Pro Logic	
SUR. STANDARD PLII Movie PLII Music PLII Game PLIIx Movie PLIIx Music PLIIx Game			
	Pro Logic II/Pro Logic IIx	Pro Logic II	
		Pro Logic IIx	
SUR. STANDARD Neo:6 Cinema Neo:6 Music			
	Cinema	Cinema/Music	
	Music		
SUR. STANDARD Neural Sur.			

SOUND FIELD PROGRAMS

Sound field program	2-channel audio (monaural)	2-channel audio (stereo)	5.1/6.1-channel audio *
SUR. ENHANCED DOLBY DIGITAL PRO LOGIC DTS			
	Pro Logic	Pro Logic	
SUR. ENHANCED PLII Movie PLIIx Movie			
		Pro Logic II	
		Pro Logic IIx	
SUR. ENHANCED Neo:6 Cinema			
STRAIGHT			
	Monaural playback		
DIRECT STEREO			
	Monaural playback		

# SET MENU

You can use the following parameters in “SET MENU” to adjust a variety of system settings and customize the way this unit operates. Change the initial settings (indicated in bold under each parameter) to reflect the needs of your listening environment.

## ■ **Basic setup** BASIC SETUP

Use this feature to set up your system quickly and with minimal effort (see page 28).

## ■ **Manual setup** MANUAL SETUP

Use this feature to manually adjust speaker and system parameters.

### **Sound menu 1** SOUND MENU

Use this menu to manually adjust any speaker settings, alter the quality and tone of the sound output by the system or compensate for video signal processing delays when using LCD monitors or projectors.

Parameter	Features	Page
A)SPEAKER SET	Selects the size of each speaker, the speakers for low-frequency signal output, and the crossover frequency.	78
B)SPEAKER LEVEL	Adjusts the output level of each speaker.	80
C)SP DISTANCE	Adjusts the delay time of each speaker.	81
D)CENTER GEO	Adjusts the tonal quality of the center speaker.	81
E)LFE LEVEL	Adjusts the output level of the LFE channel for Dolby Digital or DTS signals.	81
F)DYNAMIC RANGE	Adjusts the dynamic range of Dolby Digital or DTS signals.	82
G)AUDIO SET	Adjusts the muting level, audio delay and tone bypass settings.	82

### **Input menu 2** INPUT MENU

Use this menu to manually reassign the input/output jacks, select the input mode or rename the input source.

Parameter	Features	Page
A)I/O ASSIGNMENT	Assigns the input/output jacks of this unit according to the component to be used.	83
B)INPUT MODE	Selects the initial input mode of the source.	84
C)INPUT RENAME	Changes the name of the input source.	84
D)VOLUME TRIM	Adjusts the output volume of each jack.	85

**Option menu 3 OPTION MENU**

Use this menu to manually adjust the optional system parameters.

Parameter	Features	Page
A>DISPLAY SET	Adjusts the brightness of the display and converts video signals.	85
B>MEMORY GUARD	Locks sound field program parameters and other "SET MENU" settings.	86
C>PARAM. INI	Initializes the parameters of a group of sound field programs.	86
D>MULTI ZONE SET	Specifies the location of the speakers connected to the SPEAKERS B terminals.	87
E>XM RADIO SET	Displays the current reception level of the XM Connect-and-Play digital antenna accessory or adjusts the XM Satellite Radio information display settings.	87

**Note**

The "XM RADIO SET" parameter is only applicable to the U.S.A. model.

■ **Signal information** SIGNAL INFO

Use this feature to check audio signal information (see page 39).



# Using SET MENU

Use the remote control to access and adjust each parameter.

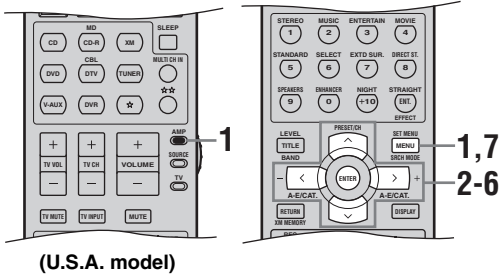

- You can change the “SET MENU” parameters while this unit is reproducing sound.
- If you press one of the sound field program selector buttons during the “SET MENU” operation, the “SET MENU” operation is canceled.
- Repeat the following procedure to select and adjust each parameter setting.
- Press RETURN to return to the previous menu level.

**Note**

You cannot change some “SET MENU” parameters when “NIGHT:CINEMA” or “NIGHT:MUSIC” is selected as the night listening mode (see page 33).

## 1 Set the component selector switch to AMP and then press SET MENU to enter “SET MENU”.

The top “SET MENU” display appears in the OSD.

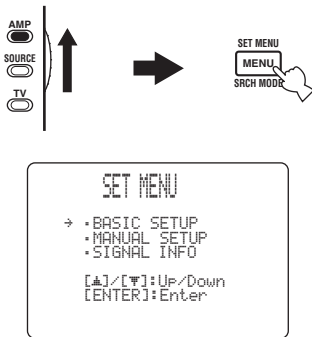

## 2 Press ^/∨ to select “MANUAL SETUP”.

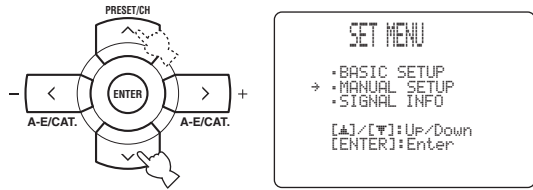

## 3 Press ENTER to enter “MANUAL SETUP”.

The “MANUAL SETUP” display appears in the OSD.

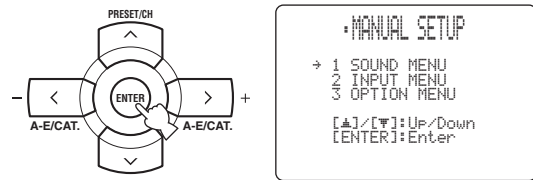

## 4 Press ^/∨ repeatedly and then press ENTER to select and enter the desired menu.

The following displays are examples where “SOUND MENU” is selected.

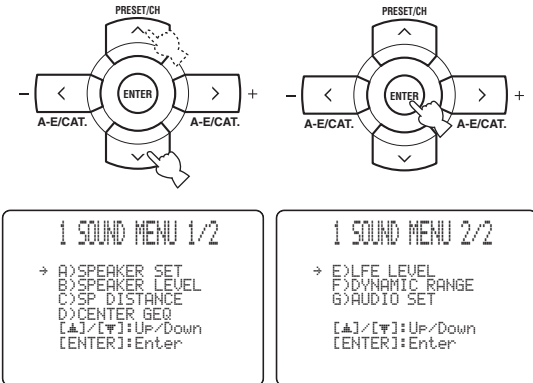

- 5 Press  $\wedge$  /  $\vee$  repeatedly and then press ENTER to select and enter the desired submenu.**

The following display is an example where "SPEAKER LEVEL" is selected.

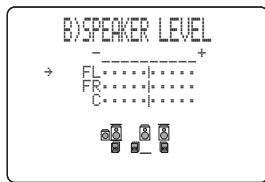
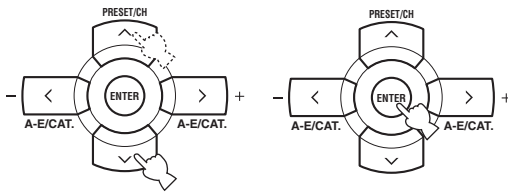

- 6 Press  $\wedge$  /  $\vee$  to select the desired parameter and then  $\lt$  /  $\gt$  to change the parameter settings.**

- Press  $\gt$  to increase the value.
- Press  $\lt$  to decrease the value.

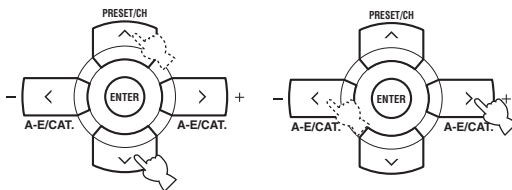

- 7 Press SET MENU to exit from "SET MENU".**



**Memory back-up**

The memory back-up circuit prevents the stored data from being lost even if this unit is in the standby mode. However, the stored data will be lost in case the power cable is disconnected from the AC wall outlet or if the power supply is cut off for more than one week.

**1 SOUND MENU**

Use this menu to manually adjust any speaker settings or compensate for video signal processing delays when using LCD monitors or projectors.

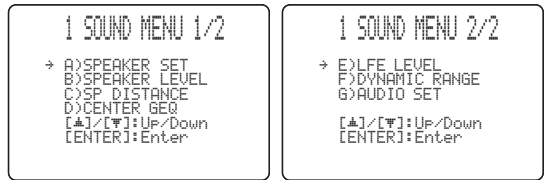

**Speaker settings A) SPEAKER SET**

Use this feature to manually adjust any speaker settings.



If you are not satisfied with the bass sounds from your speakers, you can change these settings according to your preference.

**Front speakers FRONT SP**

Choices: SMALL, LARGE

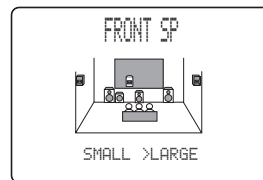

- Select "SMALL" (small) if you have small front speakers that do not reproduce low-frequency signals effectively. The low-frequency signals of the front left and right channels are directed to the speakers selected in "LFE/BASS OUT" (see page 79).
- Select "LARGE" (large) if you have large front speakers that reproduce low-frequency signals effectively. All the front left and right channel signals are directed to the front left and right speakers.

**Note**

If "LFE/BASS OUT" is set to "FRNT" (see page 79), the LFE signals found in Dolby Digital or DTS sources, the low-frequency signals of the front left and right channels, and the low-frequency signals of other speakers set to "SML" (or "SMALL") or to "NONE" are all directed to the front left and right speakers regardless of the "FRONT SP" setting.

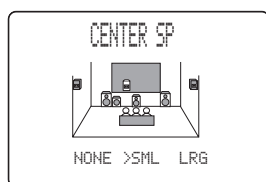
**Center speaker** CENTER SPChoices: NONE, **SML**, LRG

- Select “NONE” (none) if you did not connect a center speaker. The low-frequency signals of the center channel are directed to the speakers selected in “LFE/BASS OUT”, and the rest of the center channel signals are directed to the front left and right speakers.
- Select “SML” (small) if you have a small center speaker that does not reproduce low-frequency signals effectively. The low-frequency signals of the center channel are directed to the speakers selected in “LFE/BASS OUT”.
- Select “LRG” (large) if you have a large center speaker that reproduces low-frequency signals effectively. All the center channel signals are directed to the center speaker.

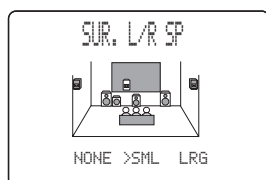
**Surround left/right speakers** SUR. L/R SPChoices: NONE, **SML**, LRG

- Select “NONE” (none) if you did not connect surround speakers. This unit is set to the Virtual CINEMA DSP mode (see page 43) and “SUR. B SP” is automatically set to “NONE”. The low-frequency signals of the surround left and right channels are directed to the speakers selected in “LFE/BASS OUT”.
- Select “SML” (small) if you have small surround left and right speakers that do not reproduce low-frequency signals effectively. The low-frequency signals of the surround left and right channels are directed to the speakers selected in “LFE/BASS OUT”.
- Select “LRG” (large) if you have large surround left and right speakers that reproduce low-frequency signals effectively. All the surround channel signals are directed to the surround left and right speakers.

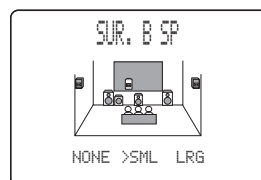
**Surround back speakers** SUR. B SPChoices: NONE, **SML**, LRG

- Select “NONE” (none) if you did not connect a surround back speaker. The low-frequency signals of the surround back channel are directed to the speakers selected in “LFE/BASS OUT”, and the rest of the surround back channel signals are directed to the surround left and right speakers.
- Select “SML” (small) if you have a small surround back speaker that does not reproduce low-frequency signals effectively. The low-frequency signals of the surround back channel are directed to the speakers selected in “LFE/BASS OUT”.
- Select “LRG” (large) if you have a large surround back speaker that reproduces low-frequency signals effectively. All the surround back channel signals are directed to the surround back speaker.

**Bass out** LFE/BASS OUT

Use this feature to select the speakers that output the LFE (low-frequency effect) and the low-frequency signals.

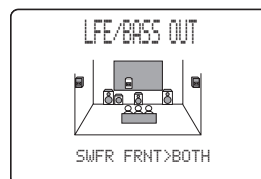
Choices: SWFR, FRNT, **BOTH**

- Select “SWFR” (subwoofer) if you connected a subwoofer. The LFE signals as well as the low-frequency signals of other speakers set to “SML” (or “SMALL”) or to “NONE” are directed to the subwoofer.
- Select “FRNT” (front) if you did not connect a subwoofer. The LFE signals, the low-frequency signals of the front left and right channels, and the low-frequency signals of other speakers set to “SML” (or “SMALL”) or to “NONE” are all directed to the front left and right speakers regardless of the “FRONT SP” setting (see page 78).
- Select “BOTH” (both) if you connected a subwoofer. The low-frequency signals of any source are output from the subwoofer. The LFE signals as well as the low-frequency signals of other speakers set to “SML” (or “SMALL”) or to “NONE” are directed to the subwoofer. The low-frequency signals of the front left and right channels are directed to the front left and right speakers and the subwoofer regardless of the “FRONT SP” setting (see page 78).

**Crossover** CROSS OVER

Use this feature to select a crossover frequency of all the speakers set to “SML” (or “SMALL”) or to “NONE” in “SPEAKER SET” (see pages 78 and 79). All frequencies below the selected frequency will be sent to the subwoofer or to the speakers set to “LRG” (or “LARGE”) in “SPEAKER SET” (see pages 78 and 79).

Choices: 40Hz, 60Hz, **80Hz**, 90Hz, 100Hz, 110Hz, 120Hz, 160Hz, 200Hz



**Subwoofer phase** SUBWOOFER PHASE

Use this feature to switch the phase of your subwoofer if bass sounds are lacking or unclear.

Choices: **NORMAL**, REVERSE

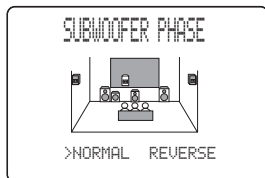

- Select “NORMAL” if you do not want to reverse the phase of your subwoofer.
- Select “REVERSE” to reverse the phase of your subwoofer.

■ **Speaker level** B>SPEAKER LEVEL

Use this feature to manually balance the speaker levels between the front left or surround left speakers and each speaker selected in “SPEAKER SET” (see page 78).

Control range: -10.0 to +10.0 dB

Control step: 1.0 dB

Initial setting: 0 dB

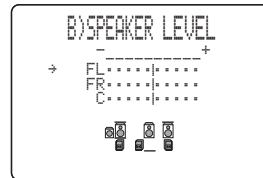

- Select “FL” to adjust the balance of the front left speaker.
- Select “FR” to adjust the balance of the front right speaker.
- Select “C” to adjust the balance of the center speaker.
- Select “SL” to adjust the balance of the surround left speaker.
- Select “SR” to adjust the balance of the surround right speaker.
- Select “SB” to adjust the balance of the surround back speaker.
- Select “SWFR” to adjust the balance of the subwoofer.

**Note**

“C”, “SL”, “SR”, “SB” and “SWFR” cannot be adjusted if “CENTER SP” (see page 79), “SUR. L/R SP” (see page 79), “SUR. B SP” (see page 79) and “LFE/BASS OUT” (see page 79) are set to “NONE” respectively.

## ■ Speaker distance C)SP DISTANCE

Use this feature to manually adjust the distance of each speaker and the delay applied to the respective channel. Ideally, each speaker should be the same distance from the main listening position. However, this is not possible in most home situations. Thus, a certain amount of delay must be applied to the sound from each speaker so that all sounds will arrive at the listening position at the same time.

```

C)SP DISTANCE
→ UNIT.....feet
FRONT L...10.0ft
FRONT R...10.0ft
CENTER...10.0ft
[▲]/[▼]: Up/Down
[<]/[>]: Adjust
  
```

### Unit UNIT

Choices: meters (m), **feet** (ft)

Initial setting:

[U.S.A. and Canada models]: feet (ft)

[Other models]: meters (m)

- Select “meters” to adjust speaker distances in meters.
- Select “feet” to adjust speaker distances in feet.

### Speaker distances

Control range: 0.30 to 24.00 m (1.0 to 80.0 ft)

Control step: 0.10 m (0.5 ft)

- Select “FRONT L” to adjust the distance of the front left speaker.  
Initial setting: 3.00 m (10.0 ft)
- Select “FRONT R” to adjust the distance of the front right speaker.  
Initial setting: 3.00 m (10.0 ft)
- Select “CENTER” to adjust the distance of the center speaker.  
Initial setting: 3.00 m (10.0 ft)
- Select “SUR. L” to adjust the distance of the surround left speaker.  
Initial setting: 3.00 m (10.0 ft)
- Select “SUR. R” to adjust the distance of the surround right speaker.  
Initial setting: 3.00 m (10.0 ft)
- Select “SUR. B” to adjust the distance of the surround back speaker.  
Initial setting: 2.10 m (7.0 ft)
- Select “SWFR” to adjust the distance of the subwoofer.  
Initial setting: 3.00 m (10.0 ft)

### Note

“CENTER”, “SUR.L”, “SUR.R”, “SUR.B” and “SWFR” cannot be adjusted if “CENTER SP” (see page 79), “SUR. L/R SP” (see page 79), “SUR. B SP” (see page 79) and “LFE/BASS OUT” (see page 79) are set to “NONE” respectively.

## ■ Center graphic equalizer D)CENTER GEO

Use this feature to adjust the built-in 5-frequency band (100Hz, 300Hz, 1kHz, 3kHz and 10kHz) graphic equalizer for the center channel so that the tonal quality of the center speaker matches that of the front speakers. You can make adjustments while listening to the currently selected source component or a test tone.

Control range: -6 to +6 dB

Control step: 0.5 dB

Initial setting: 0 dB

```

D)CENTER GEO
→ TEST _>OFF ON
100Hz ..... 0dB
300Hz ..... 0dB
1kHz ..... 0dB
3kHz ..... 0dB
10kHz ..... 0dB
[▲]/[▼]: Up/Down
[<]/[>]: Adjust
  
```

### Test tone TEST

Choices: **OFF**, ON

- Select “OFF” to stop test tones and output the currently selected source component.
- Select “ON” to output test tones from the front left and center speakers, and adjust the tonal quality of the center speaker.



Press ^ / v to select a frequency band and < / > to adjust the selected frequency band.

## ■ Low-frequency effect level E)LFE LEVEL

Use this feature to adjust the output level of the LFE (low-frequency effect) channel according to the capacity of your subwoofer or headphones. The LFE channel carries low-frequency special effects which are only added to certain scenes. This setting is effective only when this unit decodes Dolby Digital or DTS signals.

Control range: -20 to **0** dB

Control step: 1 dB

```

E)LFE LEVEL
→ SPEAKER.....0dB
HEADPHONE.....0dB

[▲]/[▼]: Up/Down
[<]/[>]: Adjust
  
```

### Speaker SPEAKER

Adjusts the speaker LFE level.

### Headphone HEADPHONE

Adjusts the headphone LFE level.

### Note

Depending on the settings of “LFE/BASS OUT” (see page 79), some signals may not be output at the SUBWOOFER OUTPUT jack.

## ■ Dynamic range F>DYNAMIC RANGE

Use this feature to select the amount of dynamic range compression to be applied to your speakers or headphones. This setting is effective only when this unit is decoding Dolby Digital and DTS signals.



### Speaker SP

Adjusts the speaker compression.

### Headphone HP

Adjusts the headphone compression.

Choices: MIN, STD, **MAX**

- Select “MIN” (minimum) if you regularly listen at low volume levels.
- Select “STD” (standard) for general use.
- Select “MAX” (maximum) to preserve the greatest amount of dynamic range.

## ■ Audio settings G>AUDIO SET

Use this feature to adjust the overall audio settings of this unit.

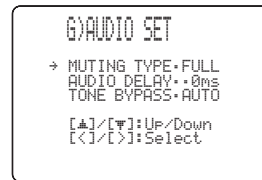

### Muting type MUTING TYPE

Use this feature to adjust how much the mute function reduces the output volume (see page 33).

Choices: **FULL**, -20dB

- Select “FULL” to completely mute all the audio output.
- Select “-20dB” to reduce the current volume by 20 dB.

### Audio delay AUDIO DELAY

Use this feature to delay the sound output and synchronize it with the video image. This may be necessary when using certain LCD monitors or projectors.

Control range: **0** to 160 ms

Control step: 1 ms

### Tone bypass TONE BYPASS

Use this feature to select whether audio output bypasses tone control circuitry when “TREBLE” and “BASS” are set to 0 dB (see page 32).

Choices: **AUTO**, OFF

- Select “AUTO” if you want signals to bypass tone control circuitry to provide the purest signal possible.
- Select “OFF” if you do not want signals to bypass tone control circuitry.

## 2 INPUT MENU

Use this menu to reassign the input/output jacks, select the input mode or rename the input source.

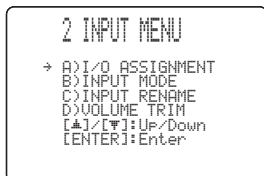

### ■ Input/output assignment

#### A) I/O ASSIGNMENT

Use this feature to assign the input/output jacks according to the component to be used if the initial settings of this unit do not correspond to your needs. Change the following parameters to reassign the respective jacks and effectively connect more components.

Once the input/output jacks are reassigned, you can select the corresponding component by using the INPUT selector on the front panel (or the input selector buttons on the remote control).

#### For COMPONENT VIDEO jacks A, B and C

```

CMPNT-V INPUT [A]
CMPNT-V INPUT [B]
CMPNT-V INPUT [C]
  
```

Choices: [A] **DVD**, DTV/CBL, V-AUX, DVR  
 [B] DVD, **DTV/CBL**, V-AUX, DVR  
 [C] DVD, DTV/CBL, V-AUX, **DVR**

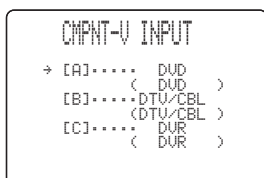

#### For OPTICAL OUTPUT jack 1 OPTICAL OUT (1)

Choices: CD, **MD/CD-R**, DVD, DTV/CBL, V-AUX, DVR

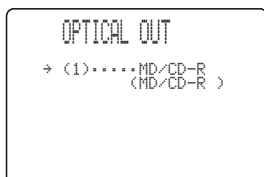

#### For OPTICAL INPUT jacks 2, 3 and 4

```

OPTICAL IN (2)
OPTICAL IN (3)
OPTICAL IN (4)
  
```

Choices: (2) CD, **MD/CD-R**, DVD, DTV/CBL, V-AUX, DVR  
 (3) CD, MD/CD-R, **DVD**, DTV/CBL, V-AUX, DVR  
 (4) CD, MD/CD-R, DVD, **DTV/CBL**, V-AUX, DVR

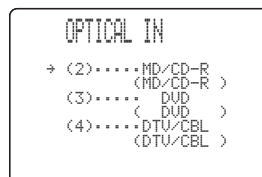

#### For COAXIAL INPUT jack 5 COAXIAL IN (5)

Choices: (5) CD, MD/CD-R, **DVD**, DTV/CBL, V-AUX, DVR

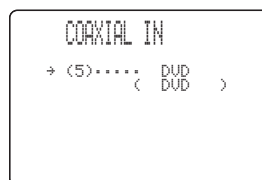

### Notes

- You cannot select a specific item more than once for the same type of jack.
- When you connect a component to both the DIGITAL INPUT (COAXIAL) and DIGITAL INPUT (OPTICAL) jacks, priority is given to the signals input at the DIGITAL INPUT (COAXIAL) jack.

**Input mode** B)INPUT MODE

Use this feature to set this unit to reset “INPUT MODE” back to “AUTO” (see page 34) regardless of the previous setting or to recall the last input mode (“AUTO”, “DTS”, or “ANALOG”) used for that source whenever you turn on this unit.

Choices: **AUTO**, **LAST**



- Select “AUTO” to reset “INPUT MODE” back to “AUTO” (see page 34) regardless of the previous setting whenever you turn on this unit. This unit automatically selects input signals in the following order:
  - (1) Digital signals
  - (2) Analog signals
- Select “LAST” to set this unit to automatically recall the last input mode (“AUTO”, “DTS”, or “ANALOG”) used for that source whenever you turn on this unit.

**Input rename** C)INPUT RENAME

Use this feature to change the name of the input source that appears in the OSD and in the front panel display.



- 1 Press one of the input selector buttons on the remote control to select the input source you want to change the name of.**

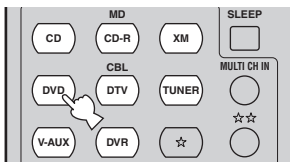

- 2 Set the component selector switch to AMP and then press </> on the remote control to place the “\_” (underscore) under the space or the character you want to edit.**

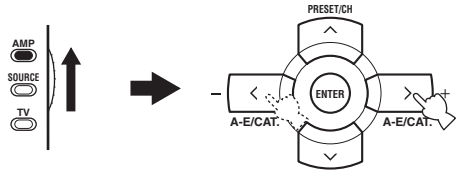

- 3 Press ^ / v to select the character you want to use and then press </> to move to the next space.**

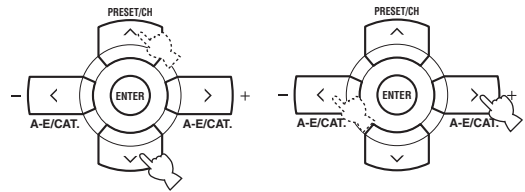

**Notes**

- You can use up to 8 characters for each input.
- Press v to change the character in the following order, or press ^ to go in the reverse order:  
A to Z, a space, 0 to 9, a space, a to z, a space, symbols (#, \*, -, +, etc.)

- 4 Repeat steps 1 through 3 to rename each input source.**

- 5 Press SET MENU on the remote control to exit from “INPUT RENAME”.**





## ■ Volume Trim D)VOLUME TRIM

Use this feature to adjust the level of the signal input at each jack. This is useful if you want to balance the level of each input source to avoid sudden changes in volume when switching between input sources.

Choices: CD, MD/CD-R, TUNER, DVD, DTV/CBL, V-AUX, DVR

Control range: -6.0 to +6.0 dB

Control step: 1.0 dB

Initial setting: 0.0 dB

```
D)VOLUME TRIM

DVD -> 0.0dB

[<]/[>]:Adjust
[RETURN]:Exit
```

## 3 OPTION MENU

Use this menu to adjust the optional system parameters.

```
3 OPTION MENU 1/2
-> A)DISPLAY SET
   B)MEMORY GUARD
   C)PARAM. INI
   D)MULTI ZONE SET
   [▲]/[▼]:Up/Down
   [ENTER]:Enter

3 OPTION MENU 2/2
-> E)XM RADIO SET

[▲]/[▼]:Up/Down
[ENTER]:Enter
```

## ■ Display settings A)DISPLAY SET

```
A)DISPLAY SET

-> DIMMER.....0
   VIDEO CONV....ON
   OSD SHIFT.....0
   GRAY BACK...AUTO

[▲]/[▼]:Up/Down
[<]/[>]:Adjust
```

### Dimmer DIMMER

Use this feature to adjust the brightness of the front panel display.

Control range: -4 to 0

Control step: 1

- Press < to make the front panel display dimmer.
- Press > to make the front panel display brighter.

### Video conversion VIDEO CONV.

Use this feature to set whether to convert the video signals input at the VIDEO and S VIDEO jacks.

Choices: ON, OFF

- Select "ON" to convert composite and S-video signals interchangeably and up-convert composite and S-video signals to component video signals.
- Select "OFF" not to convert any signals.

### Notes

- The converted video signals are only output at the MONITOR OUT jacks. When recording a video source, you must make the same type of video connections between each component.
- When composite video or S-video signals from a VCR are converted to component video signals, the picture quality may suffer depending on your VCR.
- You must set "VIDEO CONV." to "ON" to display the OSD.
- Unconventional signals input at the composite video or S-video jacks cannot be converted or may be output abnormally. In such cases, set "VIDEO CONV." to "OFF".

**OSD shift** OSD SHIFT

Use this feature to adjust the vertical position of the OSD.

Control range: -5 (upward) to +5 (downward)

Control step: 1

Initial setting: 0

- Press < to raise the position of the OSD.
- Press > to lower the position of the OSD.

**Gray back** GRAY BACK

Use this feature to display a gray background in the OSD when there is no video signal being input.

Choices: **AUTO**, OFF

- Select "AUTO" to display a gray background in the OSD when there is no video signal being input.
- Select "OFF" not to display any background in the OSD.

**Notes**

- Depending on the video signals being input or the system setting of your video monitor (NTSC or PAL), the OSD may be displayed abnormally. In such cases, set "GRAY BACK" to "OFF".
- Even when "GRAY BACK" is set to "OFF", the OSD may not be displayed correctly depending on the conditions of the picture.

**Memory guard** B)MEMORY GUARD

Use this feature to prevent accidental changes to DSP program parameter values and other system settings.

Choices: **OFF**, ON



- Select "OFF" to turn off the "MEMORY GUARD" feature.
- Select "ON" to protect:
  - DSP program parameters
  - all "SET MENU" items
  - all speaker levels

**Note**

When "MEMORY GUARD" is set to "ON", you cannot select and adjust any other "SET MENU" items.

**Parameter initialization** C)PARAM. INI

Use this feature to initialize the parameters of each sound field program within a sound field program group. When you initialize a sound field program group, all of the parameter values within that group revert to their initial factory settings.

Press the corresponding sound field program selector buttons on the remote control to select the sound field program that you want to initialize.

An asterisk (\*) appears to the left of the sound field program names that have been changed from their initial factory settings.

Choices: STEREO, MUSIC, ENTERTAINMENT, MOVIE THEATER, STANDARD

**Notes**

- You cannot automatically revert to the previous parameter settings once you initialize a sound field program group.
- You cannot separately initialize individual sound field programs.
- You cannot initialize any sound field program groups when "MEMORY GUARD" is set to "ON" (see page 86).

## ■ Zone set D)MULTI ZONE SET

Use this feature to specify the location of speakers connected to the SPEAKERS B terminals of this unit.



### Speaker B setting SP B

Use this feature to select the location of the front speakers connected to the SPEAKERS B terminals.

Choices: **FRONT**, ZONE B

- Select “FRONT” to turn on or off SPEAKERS A and B when the speakers connected to the SPEAKERS B terminals are set in the main zone.
- Select “ZONE B” if the speakers connected to the SPEAKERS B terminals are set in another zone. If SPEAKERS A is turned off and SPEAKERS B is turned on, all the speakers including the subwoofer in the main zone are muted and this unit outputs sound at the SPEAKERS B terminals only.

### Notes

- If you connect headphones to the PHONES jack of this unit, the sound is output from both headphones and the SPEAKERS B terminals when “SP B” is set to “ZONE B”.
- If a DSP program is selected when “SP B” is set to “ZONE B”, this unit automatically enters the Virtual CINEMA DSP mode (see page 43).

## ■ XM Radio setting E)XM RADIO SET (U.S.A. model only)

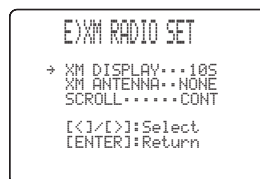

### XM Radio information display time XM DISPLAY

Use this feature to set the time to display the XM Satellite Radio information in the OSD after pressing DISPLAY on the front panel or on the remote control.

Choices: ON, **10S**, 30S, OFF

- Select “ON” to display the XM Satellite Radio information while this unit is tuned into a channel.
- Select “10S” to display the XM Satellite Radio information for 10 seconds.
- Select “30S” to display the XM Satellite Radio information for 30 seconds.
- Select “OFF” not to display the XM Satellite Radio information.

### XM Radio antenna XM ANTENNA

Use this feature to check the current reception level of the XM Connect-and-Play digital antenna accessory connected to the XM jack of this unit (see page 52). For the best reception, orient the XM Connect-and-Play digital antenna accessory so that a value of 60% or more is displayed here.

Display status: NONE, 0 to 100%

### Notes

- “NONE” is displayed if the XM Connect-and-Play digital antenna accessory is not connected to this unit. In this case, check the antenna connections (see page 52).
- The “XM ANTENNA” parameter cannot be adjusted by using the remote control. Instead, you need to adjust the orientation of the XM Connect-and-Play digital antenna accessory connected to the XM jack of this unit for a better percentage of the reception level.

### XM Radio information display scroll SCROLL

Use this feature to set whether to display the XM Satellite Radio information in the front panel display in a continuous manner or by 14 alphanumeric characters at once (see page 61).

Choices: **CONT**, ONCE

- Select “CONT” to display the XM Satellite Radio information in the front panel display in a continuous manner.
- Select “ONCE” to display the XM Satellite Radio information in the front panel display by 14 alphanumeric characters at once.

# ADVANCED SETUP

This unit has additional menus that are displayed in the front panel display. The advanced setup menu offers additional operations to adjust and customize the way this unit operates. Change the initial settings (indicated in bold under each parameter) to reflect the needs of your listening environment.

## Notes

- The settings you make are reflected next time you turn on this unit by pressing STANDBY/ON on the front panel (or POWER on the remote control) (see page 27).
- Only STANDBY/ON, STRAIGHT (EFFECT) and PROGRAM </> are effective while you are using the advanced setup menu.
- All the other operations cannot be made while you are using the advanced setup menu.
- The advanced setup menu is only available in the front panel display.

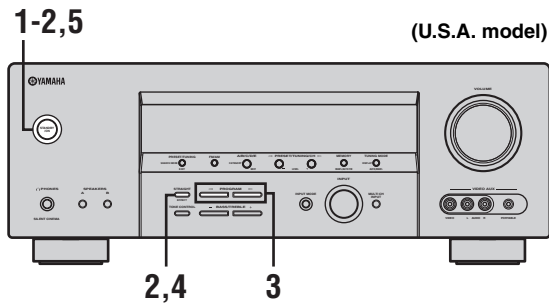

- 1 Press STANDBY/ON on the front panel to set this unit to the standby mode.**



- 2 Press and hold STRAIGHT (EFFECT) on the front panel and then press STANDBY/ON to turn on this unit.**

This unit turns on, and the advanced setup menu appears in the front panel display.



- 3 Press PROGRAM </> on the front panel repeatedly to select the parameter you want to adjust.**

The name of the selected parameter appears in the front panel display.

See page 89 for a complete list of available parameters.



Currently selected parameter

Currently selected parameter setting

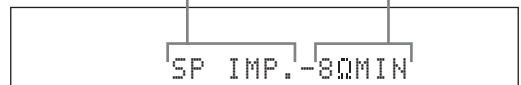

- 4 Press STRAIGHT (EFFECT) on the front panel repeatedly to change the selected parameter setting.**



- 5 Press STANDBY/ON on the front panel to save the new setting and set this unit to the standby mode.**



The settings you made are reflected next time you turn on this unit.

**Speaker impedance** SP IMP.

Use this feature to set the speaker impedance of this unit so that it matches that of your speakers.

Choices: **8ΩMIN**, **6ΩMIN**

- Select “8ΩMIN” to set the speaker impedance to 8 Ω .
- Select “6ΩMIN” to set the speaker impedance to 6 Ω .

SP IMP.	Speaker	Impedance level
8ΩMIN	Front	If you use one set (A or B), the impedance of each speaker must be 8 Ω or higher.
		If you use two sets (A and B), the impedance of each speaker must be 16 Ω or higher.*
	Center	
	Surround	The impedance of each speaker must be 8 Ω or higher.
	Surround back	
6ΩMIN	Front	If you use one set (A or B), the impedance of each speaker must be 4 Ω or higher.
		If you use two sets (A and B), the impedance of each speaker must be 8 Ω or higher.
	Center	
	Surround	The impedance of each speaker must be 6 Ω or higher.
	Surround back	

\* The Canada model cannot use two separate speaker systems (A and B) simultaneously when “SP IMP.” is set to “8ΩMIN”.

**Factory presets** PRESET

Use this feature to reset all the parameters of this unit to the initial factory settings (see page 97).

Choices: **CANCEL**, **RESET**

- Select “CANCEL” not to reset any parameters of this unit.
- Select “RESET” to reset the parameters of this unit.

**Notes**

- This setting completely resets all the parameters of this unit including the “SET MENU” parameters. However, the advanced setup menu parameters will not be initialized.
- The initial factory settings are activated next time you turn on this unit.

**Remote control AMP ID** REMOTE AMP

Use this feature to set the AMP ID of this unit for remote control recognition (see page 93).

Choices: **ID1**, **ID2**

- Select “ID1” when the remote control AMP ID library code is set to “00001”.
- Select “ID2” when the remote control AMP ID library code is set to “00002”.

**Note**

You need to set the corresponding remote control AMP library code for the remote control (see page 93).

**Remote control TUNER ID** REMOTE TUN

Use this feature to set the TUNER ID of this unit for remote control recognition (see page 93).

Choices: **ID1**, **ID2**

- Select “ID1” when the remote control TUNER ID library code is set to “81916”.
- Select “ID2” when the remote control TUNER ID library code is set to “81917”.

**Note**

You need to set the corresponding remote control TUNER library code for the remote control (see page 93).

**Remote control XM ID** REMOTE XM  
**(U.S.A. model only)**

Use this feature to set the XM ID of this unit for remote control recognition (see page 94).

Choices: **ID1**, **ID2**

- Select “ID1” when the remote control XM ID library code is set to “81918”.
- Select “ID2” when the remote control XM ID library code is set to “81919”.

**Note**

You need to set the corresponding remote control XM library code for the remote control (see page 93).

# REMOTE CONTROL FEATURES

In addition to controlling this unit, the remote control can also operate other audiovisual components made by YAMAHA and other manufacturers. To control your TV or other components, you must set the appropriate remote control code for each input source (see page 92).

## Controlling this unit, a TV, or other components

### ■ Controlling this unit

Set the component selector switch to AMP to control this unit.

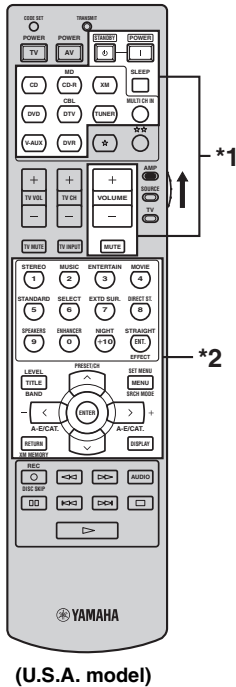

### ■ Controlling a TV

Set the component selector switch to TV to control your TV. To control your TV, you must set the appropriate remote control code for DTV/CBL or ☆☆ (see page 92). When you set the remote control codes for both DTV/CBL and ☆☆, priority is given to the one set for DTV/CBL.

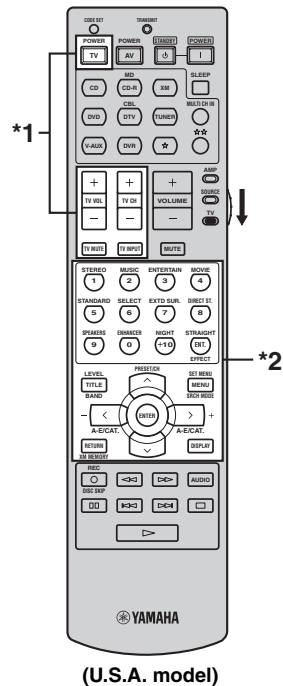

### Notes

- \*1 These buttons always control this unit regardless of the component selector switch position.
- \*2 These buttons control this unit only when the component selector switch is set to AMP.

### Notes

- \*1 These buttons always control your TV regardless of the component selector switch position.

Remote control	Digital TV/Cable TV
TV POWER	Turns on or off the power.
TV VOL +/-	Increases or decreases the volume level.
TV CH +/-	Changes the channel number.
TV MUTE	Mutes the audio output.
TV INPUT	Changes the input source.

- \*2 These buttons control your TV only when the component selector switch is set to TV. For details, see the "Digital TV/ Cable TV" column on page 91.

### ■ Controlling other components

Set the component selector switch to SOURCE to control other components selected with the input selector buttons, ☆, or ☆☆. You must set the appropriate remote control code for each input source (see page 92). The following table shows the function of each control button used to control other components assigned to each input selector button, ☆, and ☆☆. Be advised that some buttons may not correctly operate the selected component.

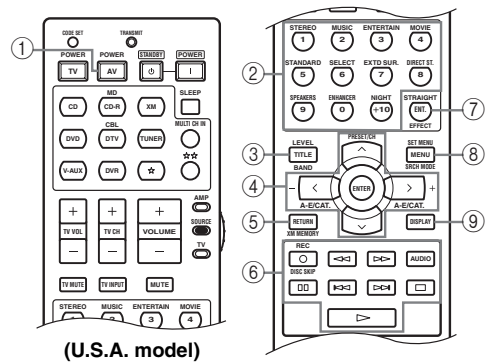

Remote control	DVD player/recorder	VCR	Digital TV/Cable TV	LD player	CD player	MD/CD recorder	Tuner	iPod®
① AV POWER	Power *1	Power *1	Power *2	Power *1	Power *1	Power *1		
② 1-9, 0, +10	Numeric buttons	Numeric buttons	Numeric buttons	Numeric buttons	Numeric buttons	Numeric buttons	Preset stations (1-8)	
③ TITLE	Title						Band	
④ PRESET/CH ^	Up	VCR channel up	Up				Preset up (1-8)	Up
PRESET/CH v	Down	VCR channel down	Down				Preset down (1-8)	Down
A-E/CAT. <	Left		Left				Preset down (A-E)	
A-E/CAT. >	Right		Right				Preset up (A-E)	
ENTER	Enter		Enter					Subsequent menu
⑤ RETURN	Return		Return					
⑥ REC/DISC SKIP	Disc skip (player) Rec (recorder) *3	Rec *3	Rec *2*3		Disc skip	Rec *3		
▷	Play	Play	Play *2	Play	Play	Play		Play
◁◁	Search backward	Search backward	Search backward *2	Search backward	Search backward	Search backward		Search backward *4
▷▷	Search forward	Search forward	Search forward *2	Search forward	Search forward	Search forward		Search forward *4
AUDIO	Audio	Audio	Audio *2	Sound				
⏸	Pause	Pause	Pause *2	Pause	Pause	Pause		Pause
◁◁	Skip backward	Skip backward	Skip backward *2	Skip backward	Skip backward	Skip backward		Skip backward
▷▷	Skip forward	Skip forward	Skip forward *2	Skip forward	Skip forward	Skip forward		Skip forward
◻	Stop	Stop	Stop *2	Stop	Stop	Stop		Stop
⑦ ENT.	Title/Index	Enter	Enter	Chapter/Time	Index	Index		
⑧ MENU	Menu		Menu					Previous menu
⑨ DISPLAY	Display	Display	Display	Display	Display	Display		Display

#### Notes

\*1 This button is operational only when the original remote control supplied with the component has a POWER button.

\*2 These buttons control your VCR or DVD recorder only when you set the appropriate remote control code for DVR (see page 92).

\*3 When you use this button to record a source, press it twice repeatedly to prevent a malfunction.

\*4 Press and hold to search backward or forward.

## Setting the remote control code

You can control your TV and other components by setting the appropriate remote control code for each input source. For a complete list of available remote control codes, refer to “LIST OF REMOTE CONTROL CODES” at the end of this manual.

The following table shows the default component in the “Library (component category)” column and the remote control code for each input source.

### Remote Control Code Default Settings

Input source	Library (component category)	Manufacturer	Default code
CD	CD	YAMAHA	61907
MD/CD-R	MD	YAMAHA	70888
XM	TUNER	YAMAHA	81918
DVD	DVD	YAMAHA	40539
DTV/CBL	–	–	–
TUNER	TUNER	YAMAHA	81916
V-AUX	–	–	–
DVR	DVR	YAMAHA	51544
☆	–	–	–
☆☆	–	–	–

#### Note

You may not be able to operate your YAMAHA component even if a YAMAHA remote control code is initially set as listed above. In this case, try setting other YAMAHA remote control codes.

- 1 Press one of the input selector buttons or ☆/☆☆ to select the component you want to set up.

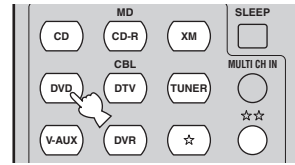

- 2 Press CODE SET using a ballpoint pen or a similar object.

The TRANSMIT indicator on the remote control flashes twice.



- 3 Press the numeric buttons (0 to 9) to enter the five-digit remote control code for the component to be used.

The TRANSMIT indicator on the remote control flashes twice, and the remote control code for the selected component is set.

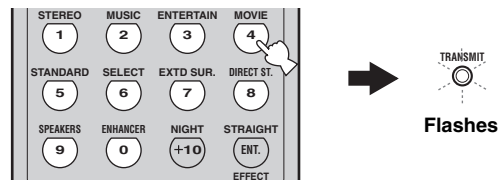

Refer to “LIST OF REMOTE CONTROL CODES” at the end of this manual.

#### Notes

- If the manufacturer of your component has more than one code, try each of them until you find the correct one.
- If you do not press any buttons within 30 seconds in step 3, the setup process is canceled. If this happens, repeat the setup procedure.
- If you enter the code number “9980”, the remote control code previously set for the selected component is cleared.



## Setting library codes

You can operate multiple YAMAHA receivers or amplifiers in the same room with the supplied remote control simultaneously. Set the appropriate library code to select and operate the desired component with the supplied remote control.

### Setting remote control AMP ID library codes

Select one of the following codes to set the remote control AMP ID library code for the component you want to use.

#### 1 Press CODE SET using a ballpoint pen or a similar object.

The TRANSMIT indicator on the remote control flashes twice.



### Setting remote control TUNER ID library codes

Select one of the following codes to set the remote control TUNER ID library code for the component you want to use.

#### 1 Press TUNER to select "TUNER" as the input source.



#### 2 Press CODE SET using a ballpoint pen or a similar object.

The TRANSMIT indicator on the remote control flashes twice.



#### 2 Press the numeric buttons to enter the code number "00001" or "00002".

The TRANSMIT indicator on the remote control flashes twice, and the AMP ID library code is changed.

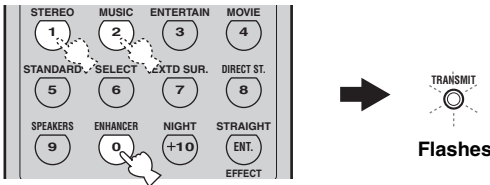

#### 3 Press the numeric buttons to enter the code number "81916" or "81917".

The TRANSMIT indicator on the remote control flashes twice, and the TUNER ID library code is changed.

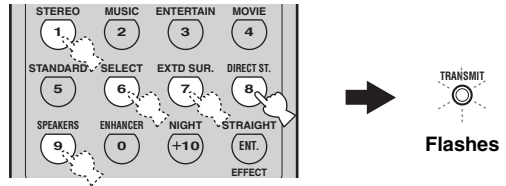

AMP ID library code *1	Function	Remote control AMP ID *2
00001 (initial setting)	To operate this unit using the default code.	ID1 (initial setting)
00002	To operate this unit using an alternative code.	ID2

TUNER ID library code *1	Function	Remote control TUNER ID *2
81916 (initial setting)	To operate this unit using the default code.	ID1 (initial setting)
81917	To operate this unit using an alternative code.	ID2

\*1 The remote control setting

\*2 The setting of this unit (see page 89)

#### Notes

- You need to set the corresponding remote control AMP ID of this unit in the advanced setup (see page 89).
- When using multiple YAMAHA receivers/amplifiers, you may be able to operate the other components simultaneously with the default code setting. In this case, set one of the alternative codes to operate this unit separately.

#### Notes

- You need to set the corresponding remote control TUNER ID of this unit in the advanced setup (see page 89).
- When using multiple YAMAHA receivers/amplifiers, you may be able to operate the other components simultaneously with the default code setting. In this case, set one of the alternative codes to operate this unit separately.

**Setting remote control XM ID library codes (U.S.A. model only)**

Select one of the following codes to set the remote control XM ID library code for the component you want to use.

**1 Press XM to select “XM” as the input source.**



**2 Press CODE SET using a ballpoint pen or a similar object.**

The TRANSMIT indicator on the remote control flashes twice.



**3 Press the numeric buttons to enter the code number “81918” or “81919”.**

The TRANSMIT indicator on the remote control flashes twice, and the XM ID library code is changed.

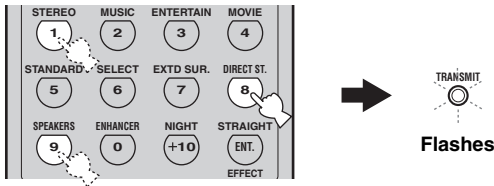

XM ID library code *1	Function	Remote control XM ID *2
81918 (initial setting)	To operate this unit using the default code.	ID1 (initial setting)
81919	To operate this unit using an alternative code.	ID2

\*1 The remote control setting

\*2 The setting of this unit (see page 89)

**Notes**

- You need to set the corresponding remote control XM ID of this unit in the advanced setup (see page 89).
- When using multiple YAMAHA receivers/amplifiers, you may be able to operate the other components simultaneously with the default code setting. In this case, set one of the alternative codes to operate this unit separately.

**Resetting all remote control codes**

Use this feature to clear all the remote control codes previously set and reset all of them to the initial factory settings.

**1 Press CODE SET using a ballpoint pen or a similar object.**

The TRANSMIT indicator on the remote control flashes twice.



**2 Press the numeric buttons to enter the code number “9981”.**

The TRANSMIT indicator on the remote control flashes twice, and all the remote control codes previously set are cleared and reset to the initial factory settings.

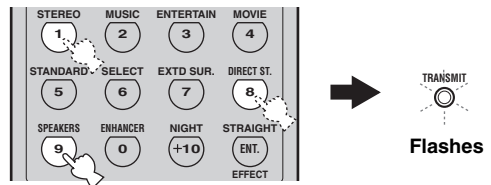

If you do not press any buttons within 30 seconds after step 2, the clearing process is canceled. In this case, repeat the clearing procedure.

# USING iPod®

Once you have stationed your iPod in a YAMAHA iPod universal dock (such as YDS-10 sold separately) connected to the DOCK terminal of this unit (see page 22), you can enjoy playback of your iPod using the supplied remote control. You can also use the Compressed Music Enhancer mode of this unit to improve the sound quality of the compression artifacts (such as the MP3 format) stored on your iPod (see page 36).

## Notes

- Only iPod (Click and Wheel), iPod nano, and iPod mini are supported.
- Compatibility with your iPod may vary depending on the software version of your iPod.
- The controls on your iPod are not operational when you operate your iPod using the OSD of this unit.
- There are some characters that cannot be displayed in the front panel or in the OSD of this unit.
- The name of the song being played appears in the front panel display up to 14 alphanumeric characters.



- For a complete list of the remote control functions used to control your iPod, see the “iPod” column in “Controlling other components” on page 91.
- For a complete list of status messages that appear in the front panel display and in the OSD, see the “iPod” section in “TROUBLESHOOTING” on page 102.

## Setting the remote control code

You need to first assign the remote control code to V-AUX on the remote control to control your iPod when “V-AUX” is selected as the input source.

- 1 Press V-AUX on the remote control to select “V-AUX” as the input source.**



- 2 Press CODE SET on the remote control using a ball point pen or a similar object.**

The TRANSMIT indicator on the remote control flashes twice.



Flashes

- 3 Press the numeric buttons to enter the code number “81981”.**

The TRANSMIT indicator on the remote control flashes twice, and the remote control code for V-AUX is set.

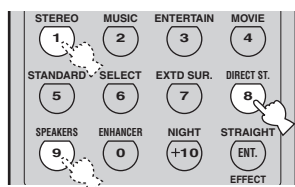

Flashes

## Controlling iPod

Once the remote control code is assigned to V-AUX on the remote control, you can control your iPod when “V-AUX” is selected as the input source. The operations of your iPod can be done with or without the aid of the OSD of this unit.

### ■ Controlling iPod without using the OSD

Once “V-AUX” is selected as the input source, you can perform the basic operations of your iPod (see page 91) using the supplied remote control without the aid of the OSD of this unit.

#### Note

Operations can be also done with the controls on your iPod.



For a complete list of the remote control buttons used to control your iPod, see the “iPod” column in “Controlling other components” on page 91.

## ■ Controlling iPod using the OSD

Once “V-AUX” is selected as the input source, you can perform the advanced operations of your iPod using the supplied remote control with the aid of the OSD of this unit. You can also browse the songs stored on your iPod in the OSD. Further, you can change or adjust settings for your iPod to suit your personal preferences.

### Notes

- Operations cannot be done with the controls on your iPod.
- The YAMAHA logo appears in the display window of your iPod.
- The “Setup” parameters can be changed or adjusted only in the OSD.
- Press ENTER on the remote control to toggle between the “Setup” parameter settings.
- You cannot browse the photos or video clips stored on your iPod in the OSD. Instead, you must use the controls on your iPod to select the desired photos or video clips. For details, see “Controlling iPod without using the OSD” on page 95.



- Press MENU on the remote control to move back to the previous menu level.
- For a complete list of the remote control buttons used to control your iPod, see the “iPod” column in “Controlling other components” on page 91.

### 1 Press DISPLAY on the remote control.

The following display appears in the OSD.



### 2 Press ^ / v on the remote control to select the desired menu and then press ENTER to enter the selected menu.

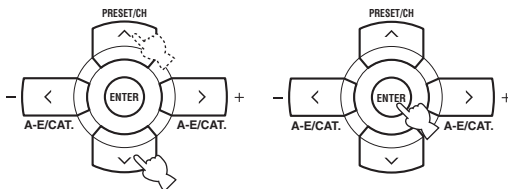

Choices: Playlists (playlists), Artists (artists), Albums (albums), Songs (songs), Genres (genres), Composers (composers), Setup (setup)

- Playlists > Songs
- Artists > Albums > Songs
- Albums > Songs
- Songs
- Genres > Artists > Albums > Songs
- Composers > Albums > Songs
- Setup > Shuffle, Repeat, Onscreen, FL Scroll

### Shuffle Shuffle

Use this feature to set this unit to play songs or albums in a random order.

Choices: **Off**, Songs, Albums

- Select “Off” to deactivate this feature.
- Select “Songs” to set this unit to play songs in a random order.
- Select “Albums” to set this unit to play albums in a random order.

### Note

When “Shuffle” is set to a setting other than “Off”, the highlighted letter “S” appears in the top right corner while songs or albums are being shuffled.

### Repeat Repeat

Use this feature to set this unit to repeat one song or a sequence of songs.

Choices: **Off**, One, All

- Select “Off” to deactivate this feature.
- Select “One” to set this unit to repeat one song.
- Select “All” to set this unit to repeat a sequence of songs.

### Note

When “Repeat” is set to a setting other than “Off”, the highlighted letter “R” appears in the top right corner while one song or a sequence of songs are being repeated.

### On-screen display time Onscreen

Use this feature to set the amount of time for which the OSD is displayed after you perform a certain operation on your iPod.

Choices: **Always**, 5s, 10s

- Select “Always” to display the OSD unceasingly while you are operating your iPod.
- Select “5s” to turn off the OSD 5 seconds after you perform a certain operation on your iPod.
- Select “10s” to turn off the OSD 10 seconds after you perform a certain operation on your iPod.

### Front panel display scroll FL Scroll

Use this feature to set whether to display the iPod operation status in the front panel display in a continuous manner or by 14 alphanumeric characters at once.

Choices: **Cont**, Once

- Select “Cont” to display the iPod operation status in the front panel display in a continuous manner.
- Select “Once” to display the iPod operation status in the front panel display by 14 alphanumeric characters at once.

# RESETTING THE SYSTEM

Use this feature to reset all the parameters of this unit to the initial factory settings.

## Notes

- This procedure completely resets all the parameters of this unit including the “SET MENU” parameters. However, the advanced setup menu parameters will not be initialized.
- The initial factory settings are activated next time you turn on this unit.

 To cancel the initialization procedure at any time without making any changes, press STANDBY/ON on the front panel (or STANDBY on the remote control) to set this unit to the standby mode.

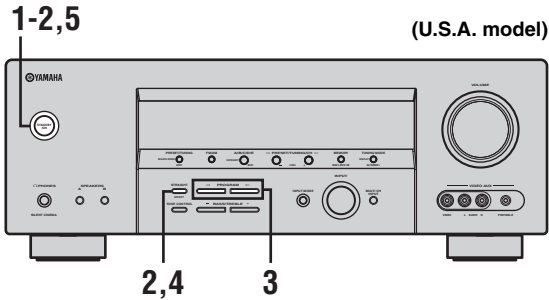

- 1 Press STANDBY/ON on the front panel to set this unit to the standby mode.**



- 2 Press and hold STRAIGHT (EFFECT) on the front panel and then press STANDBY/ON to turn on this unit.**

This unit turns on, and the advanced setup menu appears in the front panel display.

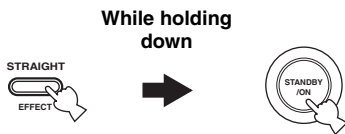

- 3 Press PROGRAM </> on the front panel repeatedly to select “PRESET”.**



- 4 Press STRAIGHT (EFFECT) on the front panel repeatedly to select “RESET”.**



Select “CANCEL” to cancel the initialization procedure without making any changes.

- 5 Press STANDBY/ON on the front panel to confirm your selection and set this unit to the standby mode.**



# TROUBLESHOOTING

Refer to the table below when this unit does not function properly. If the problem you are experiencing is not listed below or if the instruction below does not help, set this unit to the standby mode, disconnect the power cable, and contact the nearest authorized YAMAHA dealer or service center.

## ■ General

Problem	Cause	Remedy	See page
<b>This unit fails to turn on or enters the standby mode soon after the power is turned on.</b>	The power cable is not connected or the plug is not completely inserted.	Connect the power cable firmly.	—
	The speaker impedance setting is incorrect.	Set the speaker impedance to match your speakers.	26
	The protection circuitry has been activated.	Make sure that all speaker wire connections on this unit and on all speakers are secure and that the wire for each connection does not touch anything other than its respective connection.	13
	This unit has been exposed to a strong external electric shock (such as lightning or strong static electricity).	Set this unit to the standby mode, disconnect the power cable, plug it back in after 30 seconds and then use it normally.	—
<b>No sound</b>	Incorrect input or output cable connections.	Connect the cables properly. If the problem persists, the cables may be defective.	18-23
	“INPUT MODE” is set to “DTS” or “ANALOG”.	Set “INPUT MODE” to “AUTO”.	34
	No appropriate input source has been selected.	Select an appropriate input source with the INPUT selector on the front panel (or the input selector buttons on the remote control) and MULTI CH INPUT on the front panel (or MULTI CH IN on the remote control).	31, 37
	Speaker connections are not secure.	Secure the connections.	13
	The front speakers to be used have not been selected properly.	Select the set of front speakers with SPEAKERS A or B on the front panel or SPEAKERS on the remote control.	31
	The volume is turned down.	Turn up the volume.	—
	The sound is muted.	Press MUTE or VOLUME +/- on the remote control to resume audio output and then adjust the volume.	33
	“INPUT MODE” is set to “ANALOG” while playing a source encoded in DTS.	Set “INPUT MODE” to “AUTO” or “DTS”.	34
	Signals this unit cannot reproduce are being input from a source component, such as a CD-ROM.	Play a source whose signals can be reproduced by this unit.	—
<b>No picture</b>	The output and input for the picture are connected to different types of video jacks.	Set “VIDEO CONV.” to “ON”.	85

Problem	Cause	Remedy	See page
<b>The sound suddenly goes off.</b>	The protection circuitry has been activated because of a short circuit, etc.	Check that the speaker impedance setting is correct.	26, 89
		Check that the speaker wires are not touching each other and then turn this unit back on.	—
	The sleep timer has set this unit to the standby mode.	Turn on this unit, and play the source again.	—
	The sound is muted.	Press MUTE or VOLUME +/- on the remote control to resume audio output.	33
<b>Sound is heard from the speaker on one side only.</b>	Incorrect cable connections.	Connect the cables properly. If the problem persists, the cables may be defective.	13
	Incorrect settings in "SPEAKER LEVEL".	Adjust the "SPEAKER LEVEL" settings.	80
<b>Only the center speaker outputs substantial sound.</b>	When playing a monaural source with a CINEMA DSP program, the source signal is directed to the center channel, and the front and surround speakers output effect sounds.		
<b>No sound is heard from the center speaker.</b>	"CENTER SP" in "SET MENU" is set to "NONE".	Set "CENTER SP" to "SML" or "LRG".	79
	One of the HiFi DSP programs (except for "6ch Stereo") has been selected.	Try another sound field program.	63
<b>No sound is heard from the surround speakers.</b>	"SUR. L/R SP" in "SET MENU" is set to "NONE".	Set "SUR. L/R SP" to "SML" or "LRG".	79
	This unit is in the "STRAIGHT" mode and a monaural source is being played back.	Press STRAIGHT (EFFECT) on the front panel so that "STRAIGHT" disappears from the front panel display.	38
<b>No sound is heard from the surround back speaker.</b>	"SUR. L/R SP" in "SET MENU" is set to "NONE" and "SUR. B SP" is automatically set to "NONE".	Set "SUR. L/R SP" and "SUR. B SP" to "SML" or "LRG".	79
	"SUR. B SP" in "SET MENU" is set to "NONE".	Set "SUR. B SP" to "SML" or "LRG".	79
<b>No sound is heard from the subwoofer.</b>	"LFE/BASS OUT" in "SET MENU" is set to "FRNT" when a Dolby Digital or DTS signal is being played.	Set "LFE/BASS OUT" to "SWFR" or "BOTH".	79
	"LFE/BASS OUT" in "SET MENU" is set to "SWFR" or "FRNT" when a 2-channel source is being played.	Set "LFE/BASS OUT" to "BOTH".	79
	The source does not contain low-frequency signals.		

Problem	Cause	Remedy	See page
<b>Dolby Digital or DTS sources cannot be played. (Dolby Digital or DTS indicator in the front panel display does not light up.)</b>	The connected component is not set to output Dolby Digital or DTS digital signals.	Make an appropriate setting following the operating instructions for your component.	—
	“INPUT MODE” is set to “ANALOG”.	Set “INPUT MODE” to “AUTO” or “DTS”.	34
<b>A humming sound is heard.</b>	Incorrect cable connections.	Connect the audio cables firmly. If the problem persists, the cables may be defective.	—
<b>The volume level cannot be increased, or the sound is distorted.</b>	The component connected to the AUDIO OUT (REC) jacks of this unit is turned off.	Turn on the power of the component.	—
<b>The sound effect cannot be recorded.</b>	It is not possible to record the sound effect with a recording component.		
<b>A source cannot be recorded by a digital recording component connected to the DIGITAL OUTPUT jack.</b>	The source component is not connected to the DIGITAL INPUT jacks of this unit.	Connect the source component to the DIGITAL INPUT jacks.	19, 21
	Some components cannot record the Dolby Digital or DTS sources.		
<b>A source cannot be recorded by an analog component connected to the AUDIO OUT (REC) jacks.</b>	The source component is not connected to the analog AUDIO IN jacks of this unit.	Connect the source component to the analog AUDIO IN jacks.	21
<b>The sound field parameters and some other settings of this unit cannot be changed.</b>	“MEMORY GUARD” in “SET MENU” is set to “ON”.	Set “MEMORY GUARD” to “OFF”.	86
<b>This unit does not operate properly.</b>	The internal microcomputer has been frozen by an external electric shock (such as lightning or excessive static electricity) or by a power supply with low voltage.	Disconnect the power cable from the AC wall outlet and then plug it in again after about 30 seconds.	—
<b>“CHECK SP WIRES” appears in the front panel display.</b>	Speaker cables are short-circuited.	Make sure all speaker cables are connected correctly.	13
<b>There is noise interference from digital or radio frequency equipment.</b>	This unit is too close to the digital or high-frequency equipment.	Move this unit further away from such equipment.	—
<b>The picture is disturbed.</b>	The video source uses scrambled or encoded signals to prevent dubbing.		
<b>This unit suddenly enters the standby mode.</b>	The internal temperature becomes too high and the overheat protection circuitry has been activated.	Wait about 1 hour for this unit to cool down and then turn it back on.	—



## ■ Tuner

	Problem	Cause	Remedy	See page
FM	FM stereo reception is noisy.	The characteristics of FM stereo broadcasts may cause this problem when the transmitter is too far away or the antenna input is poor.	Check the antenna connections.	24
			Try using a high-quality directional FM antenna.	—
			Use the manual tuning method.	46
	There is distortion, and clear reception cannot be obtained even with a good FM antenna.	There is multi-path interference.	Adjust the antenna position to eliminate multi-path interference.	—
	The desired station cannot be tuned into with the automatic tuning method.	The signal is too weak.	Use a high-quality directional FM antenna.	—
			Use the manual tuning method.	46
	Previously preset stations can no longer be tuned into.	This unit has been disconnected for a long period.	Set preset stations	47, 48
AM	The desired station cannot be tuned into with the automatic tuning method.	The signal is weak or the antenna connections are loose.	Tighten the AM loop antenna connections and orient it for the best reception.	—
			Use the manual tuning method.	46
	There are continuous crackling and hissing noises.	Noises result from lightning, fluorescent lamps, motors, thermostats and other electrical equipment.	Use an outdoor antenna and a ground wire. This will help somewhat, but it is difficult to eliminate all noise.	—
	There are buzzing and whining noises.	A TV set is being used nearby.	Move this unit away from the TV set.	—

## ■ XM Satellite Radio (U.S.A. model only)

If an operation takes longer than usual or an error occurs, one of the following messages may appear in the front panel display. In this case, read the cause and follow the corresponding remedies.

Status message	Cause	Remedy	See page
CHECK ANTENNA	The XM Connect-and-Play digital antenna accessory is not connected to the XM jack of this unit or does not work properly.	Check the XM Connect-and-Play digital antenna accessory connections and orient it for the best reception level.	52
UPDATING	The XM user encryption code is being updated.	Wait until the encryption code is updated.	—
NO SIGNAL	The signal is too weak.	Check the XM Connect-and-Play digital antenna accessory connections and orient it for the best reception level.	52
LOADING	It takes longer than four seconds for audio or text data to be decoded.	Wait until the decoding process has finished.	—
OFF AIR	The XM Satellite Radio channel you selected is not currently broadcasting any signals.	Check the channel number again or select another XM Satellite Radio channel.	—
<XM> - - -	The Channel Station ID (SID) is no longer available.		
- - - / - - -	No artist name or song title is available.		
<CAT> - - -	No channels are available for the selected category.	Select another channel category by pressing CATEGORY on the front panel (or A-E/CAT. </> on the remote control) repeatedly.	57

## ■ Remote control

Problem	Cause	Remedy	See page	
<b>The remote control does not work nor function properly.</b>	Wrong distance or angle.	The remote control functions within a maximum range of 6 m (20 ft) and no more than 30 degrees off-axis from the front panel.	8	
	Direct sunlight or lighting (from an inverter type of fluorescent lamp, etc.) is striking the remote control sensor of this unit.	Reposition this unit.	—	
	The batteries are weak.	Replace all batteries.	3	
	The remote control code is not correctly set.	Set the remote control code correctly using “LIST OF REMOTE CONTROL CODES” at the end of this manual.		92
		Try setting another code for the same manufacturer using “LIST OF REMOTE CONTROL CODES” at the end of this manual.		92
	The library code of the remote control and the remote control ID of this unit do not match.	Match the remote control ID of this unit with the corresponding remote control library code.		89, 93
Even if the remote control code is correctly set, there are some models that do not respond to the remote control.				

## ■ iPod

### Note

In case of a transmission error without a status message appearing in the front panel and in the OSD, check the connection to your iPod (see page 22).

Status message	Cause	Remedy	See page
Loading...	This unit is in the middle of recognizing the connection with your iPod.		
	This unit is in the middle of acquiring song lists from your iPod.		
Connect error	There is a problem with the signal path from your iPod to this unit.	Set this unit to the standby mode and reconnect the YAMAHA iPod universal dock to the DOCK terminal of this unit.	22
		Try resetting your iPod.	—
Unknown type	The iPod being used is not supported by this unit.	Only iPod (Click and Wheel), iPod nano, and iPod mini are supported.	—
iPod connected	Your iPod is properly stationed in a YAMAHA iPod universal dock (such as YDS-10 sold separately) connected to the DOCK terminal of this unit, and the connection between your iPod and this unit is complete.		
Disconnected	Your iPod was removed from a YAMAHA iPod universal dock (such as YDS-10 sold separately) connected to the DOCK terminal of this unit.	Station your iPod back in a YAMAHA iPod universal dock (such as YDS-10 sold separately) connected to the DOCK terminal of this unit.	22
Unable to play	This unit cannot play back the songs currently stored on your iPod.	Check that the songs currently stored on your iPod are playable.	—
		Store some other playable music files on your iPod.	—

# GLOSSARY

## Audio information

### ■ Dolby Digital

Dolby Digital is a digital surround sound system that gives you completely independent multi-channel audio. With 3 front channels (front L/R and center), and 2 surround stereo channels, Dolby Digital provides 5 full-range audio channels. With an additional channel especially for bass effects, called LFE (Low Frequency Effect), the system has a total of 5.1-channels (LFE is counted as 0.1 channel). By using 2-channel stereo for the surround speakers, more accurate moving sound effects and surround sound environment are possible than with Dolby Surround. The wide dynamic range from maximum to minimum volume reproduced by the 5 full-range channels and the precise sound orientation generated using digital sound processing provide listeners with unprecedented excitement and realism. With this unit, any sound environment from monaural up to a 5.1-channel configuration can be freely selected for your enjoyment.

### ■ Dolby Digital EX

Dolby Digital EX creates 6 full-bandwidth output channels from 5.1-channel sources. This is done using a matrix decoder that derives 3 surround channels from the 2 in the original recording. For the best results, Dolby Digital EX should be used with movie sound tracks recorded with Dolby Digital Surround EX. With this additional channel, you can experience more dynamic and realistic moving sound especially with scenes with “fly-over” and “fly-around” effects.

### ■ Dolby Pro Logic II

Dolby Pro Logic II is an improved technique used to decode vast numbers of existing Dolby Surround sources. This new technology enables a discrete 5-channel playback with 2 front left and right channels, 1 center channel, and 2 surround left and right channels instead of only 1 surround channel for conventional Pro Logic technology. There are three modes available: “Music mode” for music sources, “Movie mode” for movie sources and “Game mode” for game sources.

### ■ Dolby Pro Logic IIx

Dolby Pro Logic IIx is a new technology enabling discrete multi-channel playback from 2-channel or multi-channel sources. There are three modes available: “Music mode” for music sources, “Movie mode” for movie sources (for 2-channel sources only) and “Game mode” for game sources.

### ■ Dolby Surround

Dolby Surround uses a 4-channel analog recording system to reproduce realistic and dynamic sound effects: 2 front left and right channels (stereo), a center channel for dialog (monaural), and a surround channel for special sound effects (monaural). The surround channel reproduces sound within a narrow frequency range. Dolby Surround is widely used with nearly all video tapes and laser discs, and in many TV and cable broadcasts as well. The Dolby Pro Logic decoder built into this unit employs a digital signal processing system that automatically stabilizes the volume on each channel to enhance moving sound effects and directionality.

### ■ DTS 96/24

DTS 96/24 offers an unprecedented level of audio quality for multi-channel sound on DVD video, and is fully backward-compatible with all DTS decoders. “96” refers to a 96 kHz sampling rate compared to the typical 48 kHz sampling rate. “24” refers to 24-bit word length. DTS 96/24 offers sound quality transparent to the original 96/24 master, and 96/24 5.1-channel sound with full-quality full-motion video for music programs and motion picture soundtracks on DVD video.

### ■ DTS (Digital Theater Systems) Digital Surround

DTS digital surround was developed to replace the analog soundtracks of movies with a 6.1-channel digital sound track, and is now rapidly gaining popularity in movie theaters around the world. Digital Theater Systems Inc. has developed a home theater system so that you can enjoy the depth of sound and natural spatial representation of DTS digital surround in your home. This system produces practically distortion-free 6.1-channel sound (technically, front left and right, center, surround left and right, and LFE 0.1 (subwoofer) channels for a total of 5.1 channels). This unit incorporates a DTS-ES decoder that enables 6.1-channel reproduction by adding the surround back channel to the existing 5.1-channel format.

### ■ ITU-R

ITU-R is the radio communication sector of the ITU (International Telecommunication Union). ITU-R recommends a standard speaker placement which is used in many critical listening rooms, especially for mastering purposes.

### ■ LFE 0.1 channel

This channel reproduces low-frequency signals. The frequency range of this channel is from 20 Hz to 120 Hz. This channel is counted as 0.1 because it only enforces a low-frequency range compared to the full-range reproduced by the other 5/6 channels in Dolby Digital or DTS 5.1/6.1-channel systems.

### ■ Neo:6

Neo:6 decodes the conventional 2-channel sources for 6-channel playback by the specific decoder. It enables playback with the full-range channels with higher separation just like digital discrete signal playback. There are two modes available: “Music mode” for music sources and “Cinema mode” for movie sources.

### ■ Neural Surround

Neural Surround™ represents the latest advancement in surround technology and has been adopted by XM Satellite Radio for digital radio broadcast of surround recordings and live events in surround sound. Neural Surround™ employs psychoacoustic frequency domain processing which allows delivery of a more detailed sound stage with superior channel separation and localization of audio elements. System playback is scalable from 5.1 to 7.1 multi-channel surround playback.

### ■ PCM (Linear PCM)

Linear PCM is a signal format under which an analog audio signal is digitized, recorded and transmitted without using any compression. This is used as a method of recording CDs and DVD audio. The PCM system uses a technique for sampling the size of the analog signal per very small unit of time. Standing for “Pulse Code Modulation”, the analog signal is encoded as pulses and then modulated for recording.

### ■ Sampling frequency and number of quantized bits

When digitizing an analog audio signal, the number of times the signal is sampled per second is called the sampling frequency, while the degree of fineness when converting the sound level into a numeric value is called the number of quantized bits. The range of rates that can be played back is determined based on the sampling rate, while the dynamic range representing the sound level difference is determined by the number of quantized bits. In principle, the higher the sampling frequency, the wider the range of frequencies that can be played back, and the higher the number of quantized bits, the more finely the sound level can be reproduced.

## Video information

### ■ Component video signal

With the component video signal system, the video signal is separated into the Y signal for the luminance and the P<sub>B</sub> and P<sub>R</sub> signals for the chrominance. Color can be reproduced more faithfully with this system because each of these signals is independent. The component signal is also called the “color difference signal” because the luminance signal is subtracted from the color signal. A monitor with component input jacks is required in order to output component signals.

### ■ Composite video signal

With the composite video signal system, the video signal is composed of three basic elements of a video picture: color, brightness and synchronization data. A composite video jack on a video component transmits these three elements combined.

### ■ S-video signal

With the S-video signal system, the video signal normally transmitted using a pin cable is separated and transmitted as the Y signal for the luminance and the C signal for the chrominance through the S-video cable. Using the S VIDEO jack eliminates video signal transmission loss and allows recording and playback of even more beautiful images.

## ***Sound field program information***

### ■ **CINEMA DSP**

Since the Dolby Surround and DTS systems were originally designed for use in movie theaters, their effect is best felt in a theater having many speakers designed for acoustic effects. Since home conditions, such as room size, wall material, number of speakers, and so on, can differ so widely, it is inevitable that there are differences in the sound heard. Based on a wealth of actually measured data, YAMAHA CINEMA DSP uses YAMAHA original sound field technology to combine Dolby Pro Logic, Dolby Digital and DTS systems to provide the audiovisual experience of movie theater in the listening room of your own home.

### ■ **SILENT CINEMA**

YAMAHA has developed a natural, realistic sound effect DSP algorithm for headphones. Parameters for headphones have been set for each sound field so that accurate representations of all the sound field programs can be enjoyed on headphones.

### ■ **Virtual CINEMA DSP**

YAMAHA has developed a Virtual CINEMA DSP algorithm that allows you to enjoy DSP sound field surround effects even without any surround speakers by using virtual surround speakers. It is even possible to enjoy Virtual CINEMA DSP using a minimal two-speaker system that does not include a center speaker.

# SPECIFICATIONS

## AUDIO SECTION

- Minimum RMS Output Power for Front, Center, Surround, Surround back  
1 kHz, 0.7% THD, 8 Ω ..... 110 W
- Maximum Power (EIAJ) [China model]  
1 kHz, 10% THD, 8 Ω ..... 135 W
- Dynamic Power (IHF)  
8/6/4/2 Ω ..... 130/165/195/240 W
- Damping Factor (IHF)  
20 Hz to 20 kHz, 8 Ω ..... 120 or more
- Frequency Response  
CD terminal to Front L/R ..... 10 Hz to 100 kHz, -3 dB
- Total Harmonic Distortion  
CD, etc. to Front L/R (20 Hz to 20 kHz, 50 W, 8 Ω)  
..... 0.06% or less
- Signal to Noise Ratio (IHF-A Network)  
CD (250 mV) to Front L/R, Effect Off ..... 100 dB or more
- Residual Noise (IHF-A Network)  
Front L/R ..... 150 μV or less
- Channel Separation (1 kHz/10 kHz)  
CD (5.1 kΩ terminated) to Front L/R ..... 60 dB/45 dB or more
- Tone Control (Front L/R)  
BASS Boost/Cut ..... ±10 dB/60 Hz  
TREBLE Boost/Cut ..... ±10 dB/20 kHz
- Phones Output ..... 150 mV/100 Ω
- Input Sensitivity/Input Impedance  
CD, etc. .... 200 mV/47 kΩ  
MULTI CH INPUT ..... 200 mV/47 kΩ
- Output Level/Output Impedance  
REC OUT ..... 200 mV/1.2 kΩ  
SUBWOOFER ..... 4 V/1.2 kΩ

## VIDEO SECTION

- Video Signal Type ..... PAL/NTSC
- Signal to Noise Ratio ..... 50 dB or more
- Frequency Response (MONITOR OUT)  
Component ..... 5 Hz to 60 MHz, -3 dB

## FM SECTION

- Tuning Range  
[U.S.A. and Canada models] ..... 87.5 to 107.9 MHz  
[Other models] ..... 87.50 to 108.00 MHz
- Usable Sensitivity (IHF) ..... 1.0 μV (11.2 dBf)
- Signal to Noise Ratio (IHF)  
Mono/Stereo ..... 76 dB/70 dB
- Harmonic Distortion (1 kHz)  
Mono/Stereo ..... 0.2%/0.3%
- Stereo Separation (1 kHz) ..... 42 dB
- Frequency Response ..... 20 Hz to 15 kHz, +0.5, -2 dB

## AM SECTION

- Tuning Range  
[U.S.A. and Canada models] ..... 530 to 1710 kHz  
[Other models] ..... 531 to 1611 kHz
- Usable Sensitivity ..... 300 μV/m

## GENERAL

- Power Supply  
[U.S.A. and Canada models] ..... AC 120 V, 60 Hz  
[Australia model] ..... AC 240 V, 50 Hz  
[China model] ..... AC 220 V, 50 Hz
- Power Consumption  
[U.S.A. and Canada models] ..... 350 W/440 VA  
[Other models] ..... 360 W
- Standby Power Consumption ..... 0.1 W or less
- AC Outlets  
[Australia model] ..... 1 (Total 100 W maximum)  
[U.S.A., Canada and China models] ..... 2 (Total 100 W maximum)
- Dimensions (W x H x D) ..... 435 x 161 x 391 mm  
(17.1 x 6.3 x 15.4 in)
- Weight ..... 10.5 kg (23.1 lbs)

# LIST OF REMOTE CONTROL CODES

## CABLE TV RECEIVER

ABC	10003, 10008, 10014, 10017, 10033
AMERICAST	10899
BELL & HOWELL	10014
BELL SOUTH	10899
CLEARMASTER	10883
CLEARMAX	10883
COOLMAX	10883
DIGEO	11187
DIGI	10637
DIRECTOR	10476
DUMONT	10637
GENERAL INSTRUMENT	10003, 10276, 10476, 10810
GOLDSTAR	10144
HAMLIN	10009, 10273
I3 MICRO	11602
JERROLD	10003, 10012, 10014, 10276, 10476, 10810
MACOM	10033
MEMOREX	10000
MOTOROLA	10014, 10276, 10476, 10810, 11187, 11254, 11376
MULTITECH	10883
MYRIO	11602
PACE	10008, 10237, 11877
PANASONIC	10000, 10107
PANTHER	10637
PARAGON	10000
PHILIPS	10317, 11305
PIONEER	10144, 10533, 10877, 11877
PULSAR	10000
QUASAR	10000
RADIO SHACK	10883
RCA	11256
REGAL	10273, 10279
RUNCO	10000
SAMSUNG	10144
SCIENTIFIC ATLANTA	10008, 10017, 10477, 10877, 11877
SEJIN	11602
SONY	11006
STARCOM	10003
SUPERCABLE	10276
SUPERMAX	10883
THOMSON	11256
TOCOM	10012
TORX	10003
TOSHIBA	10000
TRISTAR	10883
V2	10883
VIEWMASTER	10883
VISION	10883
VORTEX VIEW	10883
ZENITH	10000, 10525, 10899

## CABLE/PVR COMBINATION

AMERICAST	10899
DIGEO	11187
GENERAL INSTRUMENT	10476, 10810
JERROLD	10476, 10810
MOTOROLA	10476, 10810, 11187, 11376
PACE	10237, 11877
PIONEER	10877, 11877
RCA	11256
SCIENTIFIC ATLANTA	10877, 11877
SONY	11006
SUPERCABLE	10276
THOMSON	11256
ZENITH	10899

## DBS/PVR COMBINATION

DIRECTV	10099, 10392, 10639, 11076, 11142, 11377, 11392, 11442, 11443, 11444, 11640
DISH NETWORK SYSTEM	10775, 11505
DISHPRO	10775, 11505
ECHOSTAR	10775, 11170, 11505
EXPRESSVU	10775
HUGHES NETWORK SYSTEMS	11142, 11442, 11443, 11444
JVC	11170
MOTOROLA	10869
PHILIPS	11142, 11442
PROSCAN	10392
RCA	11392
SAMSUNG	11442
SONY	10639, 11640
STAR CHOICE	10869

## SATELLITE RECEIVER

ALPHASTAR	10772
CHAPARRAL	10053, 10216
CROSSDIGITAL	11109
DIRECTV	10099, 10247, 10392, 10566, 10639, 10724, 10749, 10819, 11076, 11108, 11109, 11142, 11377, 11392, 11414, 11442, 11443, 11444, 11609, 11639, 11640, 11749, 11856

DISH NETWORK SYSTEM	10775, 11005, 11170, 11505, 11775
---------------------	---

DISHPRO	10775, 11005, 11505, 11775
---------	-------------------------------

ECHOSTAR	10269, 10280, 10775, 11005, 11170, 11505, 11775
----------	--

EXPRESSVU	10775, 11775
GE	10392, 10566

GENERAL INSTRUMENT	10869
--------------------	-------

GOI	10775, 11775
GOODMANS	11246
HISENSE	11535
HITACHI	10819, 11250
HomeCABLE	10238
HTS	10775, 11775
HUGHES	10749, 11442, 11749

## HUGHES NETWORK SYSTEMS

	10749, 11142, 11442, 11443, 11444, 11749
--	--

ILO	11535
IQ	10210
IQ PRISM	10210
JERROLD	10869
JVC	10775, 11170, 11775

LEGEND	10269
LG	11226, 11414
MAGNAVOX	10722, 10724
MEMOREX	10269, 10724

MITSUBISHI	10749
MOTOROLA	10856, 10869
NEC	11270
NEXT LEVEL	10869
PANASONIC	10247, 10701

PAYSAT	10724
PHILIPS	10099, 10722, 10724, 10749, 10819, 11076, 11142, 11442, 11749

PIONEER	11442
PROSCAN	10392, 10566
PROTON	11535

RADIO SHACK	10869
-------------	-------

RCA	10143, 10392, 10566, 10855, 11392
-----	---

REALISTIC	10052
SAMSUNG	11108, 11109, 11142, 11276, 11377, 11442, 11609

SANYO	11219
SONY	10639, 11639, 11640

STAR CHOICE	10869
STS	10210
TIVO	11142, 11442, 11443, 11444

TOSHIBA	10082, 10749, 10790, 10819, 11285, 11749
---------	--

ULTIMATE TV	11392, 11640
-------------	--------------

UNIDEN	10052, 10074, 10238, 10722, 10724
US DIGITAL	11535
USD TV	11535
VOOM	10869
ZENITH	11856

## HDTV DECODER

ACCURIAN	11653
EPSON	11563, 11650
LG	11415
MACRO IMAGE TECHNOLOGY	11383

MOTOROLA	11363
MYHD	11383
PANASONIC	11120
PIONEER	11010
PRINCETON	10113, 10295
SAMSUNG	11190, 11490
SASEM	11641
SENSORY SCIENCE	11126

SHARP	11010
SYLVANIA	11563
TELEMANN	11604
VIEWSONIC	11329
VIZIO	11126

## OTHER VIDEO ACCESSORIES

ABS	11272
ACCURIAN	11653
ALIENWARE	11272
CYBERPOWER	11272

D-LINK	11554
ECS	11553
EPSON	11563, 11650
GATEWAY	11272
HEWLETT PACKARD	11267, 11272

## HOWARD COMPUTERS

	11272
HP	11272
HUSH	11272
IBUYPOWER	11272
INTERVIDEO	11393
KEYSPAN	11344
KWORLD	11403
LEADTEK	11614
LG	11415
LINKSYS	11272, 11365
MACRO IMAGE TECHNOLOGY	11383

MEDIA CENTER PC	11272
MICROSOFT	11272
MIND	11272
MOTOROLA	11363
MYHD	11383
NIVEUS MEDIA	11272

NORTHGATE	11272
PANASONIC	11120
PINNACLE SYSTEMS	11268
PIONEER	11010
PRINCETON	10113, 10295
RICAVISION	11272

ROKU	11486	CURTIS MATHES	JCB	20000	PENNEY	20030, 20047,
SAMSUNG	11190, 11490		JENSEN	20761, 20815,		20051, 20060,
SASEM	11641			20817, 21933		20156, 20178,
SENSORY SCIENCE			JVC	20053, 20069,		21347, 21919,
	11126			20160, 20169,		21926
SHARP	11010		KEC	20731, 21253	PHILCO	20030, 20054
SMC	11456			20180	PHILIPS	20054, 20690,
SONY	11272, 11324,		KENWOOD	20030, 20859		21154, 21454
	11364	CXC	KLH	20765, 20767,	PILOT	20030
STACK 9	11272	DAEWOO		21962	PIONEER	20038, 20166,
STREAMZAP	11309		KTV	20030, 20180		20679, 20866
SYLVANIA	11563		LG	20178, 20442,	POLAROID	20765, 20865
SYSTEMAX	11272			20700, 20856,	PORTLAND	20092
TAGAR SYSTEMS		DELL		21178, 21265	PRIMA	20761, 20783,
	11272		LLOYD'S	21904		20815, 20817,
TELEMANN	11604	DENON	LOEWE	20136		21933
TOSHIBA	11272	DUMONT	LXI	20047, 20054,	PRINCETON	20700, 20717
TOUCH	11272	DURABRAND		20154, 20156,	PRISM	20051
VIEWSONIC	11272, 11329			20178	PROSCAN	20047, 20466,
VIZIO	11126		MAGNASONIC			21347, 21447,
VOODOO	11272	DWIN		21928		21922
ZT GROUP	11272		MAGNAVOX	20030, 20054,	PROTON	20178, 20466
				20706, 20802,	PULSAR	20017
				21254, 21454,	QUASAR	20051, 20250,
				21904, 21931,		20650, 21919
				21944	RADIOSHACK	
<b>TV</b>		ELECTROBAND				
ADMIRAL	20093, 20463					
ADVENT	20761, 20783,	ELECTROGRAPH	MARANTZ	20030, 20054,		20030, 20047,
	20815, 20817,			20704, 20854,		20154, 20178,
	20842, 21933	EMERSON		20855, 21154,		20180, 21904
				21454	RCA	20038, 20047,
AIKO	20092		MATSUSHITA	20250, 20650		20090, 20679,
AIWA	20701		MAXENT	21755		21047, 21147,
AKAI	20030, 20060,	ENVISION	MEGAPOWER			21247, 21347,
	20672, 20702,			20700		21447, 21547,
	20812, 21903	EPSON	MEGATRON	20145, 20178		21917, 21919,
ALBATRON	20700, 20843	ESA	MEMOREX	20150, 20154,		21922, 21948,
AMERICA ACTION		FISHER		20178, 20463,		21953, 21958
	20180	FUJITSU		21926	REALISTIC	20030, 20154,
AMPRO	20751		MGA	20030, 20150,		20178, 20180
ANAM	20180	FUNAI		20155, 20178	RUNCO	20017, 20030,
AOC	20030		MIDLAND	20017, 20047,		20497, 20603
APEX DIGITAL		FUTURETECH		20051	SAMPO	20030, 21755
	20156, 20748,		MITSUBISHI	20014, 20093,	SAMSUNG	20030, 20060,
	20765, 20767,	GATEWAY		20150, 20155,		20178, 20587,
	20879, 21943	GE		20178, 20331,		20702, 20766,
AUDIOVOX	20092, 20180,			20358, 20836,		20812, 20814,
	20451, 20623,			20868, 21250,		21060, 21903,
	20802, 20875,			21917		21959
	21937, 21951,	GIBRALTER	MONIVISION	20700, 20843	SANSUI	20463, 21904,
	21952	GO VIDEO	MOTOROLA	20093		21929, 21935
AVENTURA	20171	GOLDSTAR	MTC	20030, 20060	SANYO	20088, 20154,
AXION	21937		MULTITECH	20180		20484, 20799,
BELL & HOWELL			NAD	20156, 20178,		20893
	20154	GOODMANS		20866	SCOTCH	20178
BENQ	21032	GRUNDIG	NEC	20030, 20497,	SCOTT	20178, 20180,
BOXLIGHT	20893	GRUNPY		20882, 21704		20236
BRADFORD	20180	HAIER	NETTV	21755	SEARS	20047, 20054,
BROKSONIC	20180, 20236,	HALLMARK	NIKKO	20030, 20092,		20154, 20156,
	20463, 21929,	HARLEY DAVIDSON		20178		20171, 20178,
	21935, 21938		NORCENT	20748, 20824		21904, 21926
CANDLE	20030	HARMAN/KARDON	NTC	20092	SHARP	20093, 20153,
CARNIVALE	20030		ONWA	20180		20491, 20688,
CARVER	20054	HARVARD	OPTIMUS	20154, 20166,		20689, 20818,
CELEBRITY	20000	HAVERMY		20250, 20650		20851, 21917
CELERA	20765	HELIOS	OPTOMA	20887	SHENG CHIA	20093
CHANGHONG		HELLO KITTY	OPTONICA	20093	SOLE	20813
	20765		ORION	20236, 20463,	SONY	20000, 20011,
CITIZEN	20030, 20060,	HISENSE		21463, 21929		20080, 20111,
	20092, 21928	HITACHI	PANASONIC	20051, 20226,		20810, 20834,
CLARION	20180			20250, 20650,		20867, 21100,
COMMERCIAL SOLUTIONS				20863, 21410,		21904, 21925
	20047, 21447	HYUNDAI		21919, 21941,	SOUNDESIGN	
CONTEC	20180			21946, 21947		20178, 20180
CRAIG	20180	INFINITY			SOVA	21952
CROSLEY	20054	INTEQ				
CROWN	20180	JBL				



SQUAREVIEW		HOWARD COMPUTERS		DURABRAND		MTC	30240
	20171		31972		30038, 30039	MULTITECH	30072
SSS	20180	HP	31972	ELECTROHOME		NEC	30038, 30041,
STARLITE	20180	HUGHES NETWORK SYSTEMS			30037, 30043		30067, 30104
STUDIO EXPERIENCE			30739	ELECTROPHONIC		NIKKO	30037
	20843	HUMAX	30739		30037	NIVEUS MEDIA	
SUPERSCAN	20093, 20864	HUSH	31972	EMEREX	30032		31972
SUPREME	20000	IBUYPOWER	31972	EMERSON	30002, 30037,	NOBLEX	30240
SVI	20587, 20748,	LG	32010		30043, 30121,	NORTHGATE	31972
	20865, 20870,	LINKSYS	31972		30184, 30209,	OLYMPUS	30035
	20871, 20872	MEDIA CENTER PC			30278, 30479,	OPTIMUS	30037, 30048,
SYLVANIA	20030, 20054,		31972		30593, 31593		30104, 30162,
	20171, 21931,	MICROSOFT	31972	FISHER	30047, 30104		30432, 30593,
	21944	MIND	31972	FUJI	30033, 30035		31048, 31062,
SYMPHONIC	20171, 20180,	NIVEUS MEDIA		FUNAI	30593, 31593		31162, 31262
	21904		31972	GATEWAY	31972	ORION	30002, 30184,
TANDY	20093	NORTHGATE	31972	GE	30035, 30060,		30209, 30479
TATUNG	21756	PANASONIC	30616, 31807,		30240	PANASONIC	30035, 30162,
TECHNICS	20051, 20250		31808, 31809	GO VIDEO	30240, 30432		30616, 31062,
TECHVIEW	20847	PHILIPS	30618, 30739	GOLDSTAR	30037, 30038		31162, 31244,
TECHWOOD	20051	RCA	30880	HARMAN/KARDON			31262, 31562,
TEKNIKA	20054, 20060,	REPLAYTV	30614, 30616		30038, 30081		31807, 31808,
	20092, 20150,	SONIC BLUE	30614, 30616	HARWOOD	30072		31809
	20180	SONY	30636, 31972	HEWLETT PACKARD		PENNEY	30035, 30037,
TELEFUNKEN		STACK 9	31972		31972		30038, 30042,
	20702	SYSTEMAX	31972	HI-Q	30047		30240
THOMAS	21904	TAGAR SYSTEMS		HITACHI	30041, 30042	PENTAX	30042
TMK	20178		31972	HOWARD COMPUTERS		PHILCO	30035
TNCI	20017	TIVO	30618, 30636,		31972	PHILIPS	30035, 30081,
TOSHIBA	20060, 20154,		30739	HP	31972		30618, 30739,
	20156, 20650,	TOSHIBA	31008, 31972	HUGHES NETWORK SYSTEMS			31081, 31181
	20832, 20845,	TOUCH	31972		30042, 30739	PILOT	30037
	21156, 21256,	VIEWSONIC	31972	HUMAX	30739, 31988	PIONEER	30067
	21265, 21356,	VOODOO	31972	HUSH	31972	POLK AUDIO	30081
	21656, 21704,	ZT GROUP	31972	IBUYPOWER	31972	PROFITRONIC	
	21918, 21935,			JENSEN	30041		30240
	21936, 21945			JVC	30041, 30067,	PROSCAN	30060
TVS	20463				31162	PROTEC	30072
VECTOR RESEARCH		<b>VCR</b>		KEC	30037, 30278	PULSAR	30039
	20030	ABS	31972	KENWOOD	30038, 30041,	QUASAR	30035, 30162,
VICTOR	20053	ADMIRAL	30048, 30209,		30067		31162
VIDIKRON	20054		30479	KLH	30072	RADIOSHACK	
VIDTECH	20178	AIKO	30278	KODAK	30035, 30037		31037
VIEWSONIC	20857, 20864,	AIWA	30037	LG	31037, 32010	RADIX	30037
	20885, 21755	AKAI	30041	LINKSYS	31972	RANDEX	30037
VIZIO	20864, 20885,	ALIENWARE	31972	LOGIK	30072	RCA	30042, 30060,
	21756	AMERICA ACTION		LXI	30037		30149, 30240,
WARDS	20030, 20054,		30278	MAGNASONIC			30880
	20080, 20111,	AMERICAN HIGH			30593	REALISTIC	30035, 30037,
	20178, 20866,		30035	MAGNAVOX	30035, 30039,		30047, 30048,
	21156	ASHA	30240		30081, 30149,		30104
WAYCON	20156	AUDIOVOX	30037, 30278		30563, 30593	REPLAYTV	30614, 30616
WESTINGHOUSE		BEAUMARK	30240	MAGNIN	30240	RICAVISION	31972
	20451, 20889	BELL & HOWELL		MARANTZ	30035, 30081	RUNCO	30039
WHITE WESTINGHOUSE			30104	MARTA	30037	SAMSUNG	30045, 30240,
	20463, 20623	BROKSONIC	30002, 30121,	MATSUSHITA	30035, 30162,		30739
YAMAHA	20030, 20650,		30184, 30209,		31162	SANKY	30039, 30048
	20769, 20833,		30479	MEDIA CENTER PC			30041, 30067,
	20839, 21405,	CALIX	30037		31972	SANSUI	30209, 30479
	21406, 21407	CANON	30035	MEI	30035	SANYO	30047, 30104,
ZENITH	20017, 20092,	CARVER	30081	MEMOREX	30035, 30037,		30240
	20178, 20463,	CCE	30072, 30278		30039, 30047,	SCOTT	30043, 30045,
	21145, 21904,	CITIZEN	30037, 30278		30048, 30104,		30121, 30184
	21929	COLT	30072		30162, 30209,	SEARS	30035, 30037,
		CRAIG	30037, 30047,		30240, 30479,		30042, 30047,
			30072, 30240		31037, 31162,		30104
		CURTIS MATHES			31262	SHARP	30048, 30848
			30035, 30041,	MGA	30043, 30240	SHINTOM	30072
			30060, 30162	MGN TECHNOLOGY		SHOGUN	30240
		CYBERNEX	30240		30240	SINGER	30072
		CYBERPOWER		MICROSOFT	31972	SONIC BLUE	30614, 30616
			31972	MIND	31972	SONY	30032, 30033,
		DAEWOO	30045, 30278	MINOLTA	30042		30035, 30636,
		DELL	31972	MITSUBISHI	30043, 30067		31032, 31972
		DENON	30042	MOTOROLA	30035, 30048	STACK 9	31972
		DIRECTV	30739				
<b>PVR</b>							
ABS	31972						
ALIENWARE	31972						
CYBERPOWER	31972						
DELL	31972						
DIRECTV	30739						
GATEWAY	31972						
HEWLETT PACKARD							
	31972						

STS	30042	CALIFORNIA AUDIO LABS		MALATA	40782, 41159	TEAC	40790, 40809
SYLVANIA	30035, 30043, 30081, 30593, 31593	40490		MARANTZ	40539	TECHNICS	40490, 40703
SYMPHONIC	30593, 31593	CINEVISION	40833, 40869, 40876	MCINTOSH	41273, 41533	TECHNOSONIC	
SYSTEMAX	31972	CITIZEN	41277	MEMOREX	40695, 41270		40730
TAGAR SYSTEMS		COBY	40778, 40852, 41107, 41177, 41351	MICROSOFT	40522	TECHWOOD	40692
TATUNG	30041	CURTIS MATHES	41087	MINTEK	40717, 40839	THETA DIGITAL	
TEAC	30041	CYBERHOME		MITSUBISHI	40521, 41521		40571
TECHNICS	30035, 30162		40816, 40874, 41023, 41024, 41117	MOMITSU	41082	TOSHIBA	40503, 40695, 41154
TEKNIKA	30035, 30037	DAEWOO	40705, 40833, 40869, 41169, 41172, 41234, 41242	MYRYAD	40894	TREDEX	40799, 40800, 40803, 40804
TIVO	30618, 30636, 30739, 31503	DAYTEK	40872	NAD	40591, 40692, 40741	URBAN CONCEPTS	
TMK	30240	DENON	40490	NAKAMICHI	41222		40503
TOSHIBA	30043, 30045, 30209, 31008, 31972, 31988	DESAY	41407	NEC	40785	US LOGIC	40839
TOTEVISION	30037, 30240	DISNEY	40675, 41270	NESA	40717	VENTURER	40790
TOUCH	31972	DUAL	41068, 41085	NEXT BASE	40826	VIZIO	41064, 41226
UNITECH	30240	DURABRAND		NORCENT	40872, 41003, 41107, 41265	XBOX	40522
VECTOR	30045		41127	ONKYO	40503, 40627, 40792, 41627	YAMAHA	40490, 40539, 40545, 41543
VECTOR RESEARCH	30038	EMERSON	40591, 40675, 40821, 41268	ORITRON	40651	YAMAKAWA	40872
VIDEO CONCEPTS		ENTERPRISE	40591	PANASONIC	40490, 40503, 40632, 40703, 41762	ZENITH	40503, 40591, 40741, 40869
	30045	FUNAI	40675, 41268	PHILIPS	40503, 40539, 40675, 40854, 41260, 41267, 41354	ZOECE	41265
VIDEOMAGIC	30037	GATEWAY	41073, 41077	PIANODISC	41024		
VIDEOSONIC	30240	GE	40522, 40717, 40815	PIONEER	40525, 40571, 40632, 41571	<b>LD PLAYER</b>	
VIEWSONIC	31972	GO VIDEO	40715, 40741, 40744, 40783, 40833, 40869, 41044, 41075, 41099	POLAROID	41020, 41061	AIWA	40203
VOODOO	31972	GO VISION	41071, 41072	POLK AUDIO	40539	CARVER	40064, 40194, 40323
WARDS	30035, 30042, 30047, 30048, 30060, 30072, 30081, 30149, 30240	GOLDSTAR	40741	PRIMA	41016	DENON	40059, 40172
WHITE WESTINGHOUSE		GPX	40699, 40769	PRINCETON	40674	DISCO VISION	
	30072, 30209	GRADIENTE	40490	PROCEED	40672		40023
XR-1000	30035, 30072	GREENHILL	40717	PROSCAN	40522	FUNAI	40203
YAMAHA	30038	GRUNDIG	40539	PROVISION	40778	HARMAN/KARDON	
ZENITH	30033, 30039, 30209, 30479, 31139	HARMAN/KARDON		QWESTAR	40651		40194
ZT GROUP	31972	HITACHI	40582, 40702, 40573, 40664, 41247	RCA	40522, 40571, 40717, 40790, 40822, 41022, 41132, 41193	HITACHI	40023
		HTEKER	40672	RIO	40869	MAGNAVOX	40194, 40217
		INITIAL	40717	RJTECH	41360	MARANTZ	40064, 40194
		INTEGRA	40571, 40627	ROTEL	40623, 41178	MITSUBISHI	40059
		JATON	41078	ROWA	40823	NAD	40059
		JBL	40702	SAMPO	40698, 40752	OPTIMUS	40059
		JENSEN	41016	SAMSUNG	40490, 40573, 40744, 40820, 40899, 41044, 41075	PANASONIC	40204
		JSI	41423	SANSUI	40695	PHILIPS	40064, 40194
		JVC	40558, 40623, 40867	SANYO	40695, 40873	PIONEER	40023, 40059
		JWIN	41049, 41051	SHARP	40630, 40675, 40752, 41256	POLK AUDIO	
		KAWASAKI	40790	SHARPER IMAGE			40194
		KENWOOD	40490, 40534, 40682, 40737	SHERWOOD	41117	QUASAR	40204
		KLH	40717, 40790, 41020, 41149, 41261	SHINSONIC	40633, 41043, 41077	REALISTIC	40203
ASPIRE DIGITAL		KONKA	40711	SIGMA DESIGNS	40533, 40839	SAMSUNG	40323
	41407	KOSS	40651, 41423		40674	SEGA	40023
AUDIOVOX	40790, 41041, 41071, 41072, 41121, 41122	LANDEL	40826	SONIC BLUE	40869, 41099	SONY	40193, 40201
AXION	41071, 41072	LASONIC	40798, 41173	SONY	40533, 40864, 41017, 41033, 41533	TECHNICS	40204
B & K	40655, 40662	LECSON	41533	SOVA	41122	THETA DIGITAL	
BEL CANTO DESIGN		LENOXX	41127	SUNGALE	41074		40194
	41571	LG	40591, 40741, 40801, 40869	SUPERSCAN	40821	YAMAHA	40217
BLAUPUNKT	40717	LOEWE	40511	SVA	40860, 41105		
BLUE PARADE	40571	MAGNAVOX	40503, 40539, 40675, 40821	SYLVANIA	40675, 40821, 41268	<b>DVD RECORDER</b>	
BROKSONIC	40695, 40868		40675, 40821	SYMPHONIC	40675, 41268	APEX DIGITAL	
				TAG MCLAREN	40894		51056
						ASPIRE DIGITAL	
							51168
						COBY	51086
						CYBERHOME	
							51129
						FUNAI	50675, 51334
						GATEWAY	51073, 51158
						GO VIDEO	50741, 51158, 51304, 51730
						ILO	51348
						JVC	51164, 51275
						LG	50741
						LITEON	51158, 51416, 51440
						MAGNAVOX	50646

PANASONIC 50490, 51010, 51011  
 PHILIPS 50646  
 PIONEER 50631, 51475, 51476  
 POLAROID 51086  
 RCA 50522  
 SAMSUNG 50490  
 SENSORY SCIENCE| 51158  
 SHARP 50675, 51550, 51556, 50630  
 SONY 51033, 51069, 51070, 51431  
 SYLVANIA 50675  
 TOSHIBA 51510  
 VICTOR 51275  
 YAMAHA 51544  
 ZENITH 50741

---

### CD PLAYER

AIWA 60157  
 ARCAM 60157  
 BURMESTER 60420  
 CALIFORNIA AUDIO LABS 60029, 60303  
 CARVER 60157, 60179  
 DENON 60003, 60034  
 DKK 60000  
 DMX ELECTRONICS 60157  
 FISHER 60179  
 GARRARD 60393, 60420  
 GENEXXA 60032  
 HARMAN/KARDON 60157  
 HITACHI 60032  
 INTEGRA 60101  
 JVC 60072  
 KENWOOD 60028, 60190, 60626  
 KLH 61318, 61372, 61711  
 KRELL 60157  
 LINN 60157  
 MAGNAVOX 60038, 60157  
 MARANTZ 60029, 60038, 60157, 60180, 60435, 60626  
 MCINTOSH 60256, 60290, 60660  
 MCS 60029  
 MIRO 60000  
 MISSION 60157  
 MTC 60420  
 NSM 60157  
 ONKYO 60101, 61327  
 OPTIMUS 60000, 60032, 60087, 60179, 60420, 60468  
 PANASONIC 60029, 60303, 60388, 60752  
 PARASOUND 60420

PHILIPS 60157, 60274, 60626  
 PIONEER 60032, 60468, 61062  
 POLK AUDIO 60157  
 PROCEED 60420  
 PROTON 60157  
 QED 60157  
 QUAD 60157  
 QUASAR 60029  
 RCA 60032, 60053, 60179, 60420, 60468, 61062  
 REALISTIC 60179, 60180, 60420  
 ROTEL 60157, 60420  
 SAE 60157  
 SANSUI 60157  
 SANYO 60087, 60179  
 SHARP 60180  
 SHERWOOD 60180  
 SONIC FRONTIERS 60157  
 SONY 60000, 60490  
 SUGDEN 60157  
 TAG MCLAREN 60157  
 TASCAM 60420  
 TEAC 60180, 60378, 60393, 60420  
 TECHNICS 60029, 60303  
 VICTOR 60072  
 WARDS 60053, 60157  
 YAMAHA 60036, 60490, 61907

---

### CD RECORDER

HARMAN/KARDON 71202  
 JVC 71294  
 KENWOOD 70626  
 KLH 71373  
 LG 71208  
 MARANTZ 70626  
 PHILIPS 70626  
 PIONEER 71062, 71087  
 RCA 70053, 70420  
 SONY 70000, 70100, 71364  
 TDK 71208  
 TEAC 70420  
 YAMAHA 70888, 71292

---

### MD RECORDER

DENON 70873  
 KENWOOD 70681, 70826  
 ONKYO 70868  
 OPTIMUS 71063  
 PIONEER 71063  
 SHARP 70861  
 SHERWOOD 71067  
 SONY 70490  
 YAMAHA 70490, 70888, 71909

---

### TAPE DECK

AIWA 70029, 70197  
 CARVER 70029  
 DENON 70076  
 HARMAN/KARDON 70029, 70182  
 JVC 70244, 70273  
 KENWOOD 70070  
 MAGNAVOX 70029  
 MARANTZ 70029  
 ONKYO 70135, 70282  
 OPTIMUS 70027, 70220  
 PANASONIC 70229  
 PHILIPS 70029  
 PIONEER 70027, 70099, 70220  
 POLK AUDIO 70029  
 RCA 70027, 70220  
 SANSUI 70029  
 SONY 70170, 70243, 70291  
 TECHNICS 70229  
 VICTOR 70273  
 WARDS 70027  
 YAMAHA 70094, 70097, 70524

---

### TUNER

ADC 80531  
 ADCOM 80616, 81616, 81617  
 AIWA 80121, 80158, 80189, 81405  
 AMC 81077  
 AMPLIFIER TECHNOLOGIES 81584  
 ANAM 81074, 81609  
 ARCAM 81189  
 ATLANTIC TECHNOLOGY 81487  
 AUDIOTRONIC 81189  
 AUDIOVOX 81627  
 B & K 80701, 80820, 80840  
 BEL CANTO DESIGN 81584  
 BK 80702  
 BOSE 81933  
 BOSTON ACOUSTICS 81918  
 BRIX 81602  
 CAPETRONIC 80531  
 CARVER 80008, 80121, 80189, 80360, 81189  
 CLASSE 81916  
 DELPHI 81414  
 DENON 80121, 81360  
 EMERSON 80424  
 FISHER 80219, 80360  
 FOSGATE 81487

GARRARD 80424  
 GATEWAY 81567  
 HARMAN/KARDON 80110, 80189, 80891, 81304  
 INTEGRA 80135, 81320  
 JBL 80110  
 JVC 80074, 81058, 81811  
 KENWOOD 80027, 80077, 81313, 81569, 81570  
 KLH 81428  
 KOSS 80424  
 LEXICON 81076  
 LINN 80189  
 MAGNAVOX 80189, 80531, 81189, 81269  
 MARANTZ 80039, 80189, 80200, 81189, 81269  
 MCS 80039, 80346  
 MICROMEGA 81189  
 MITSUBISHI 81393  
 MYRYAD 81189, 81918  
 NAD 80320  
 NAKAMICHI 80347, 81313, 81555, 81919  
 NIRO 81908  
 ONKYO 80135, 81320  
 OPTIMUS 80177, 80219, 80531, 80670, 81023, 81074  
 OUTLAW 81487  
 OUTLAW AUDIO 81487  
 PANASONIC 80039, 80309, 81308, 81518  
 PHILIPS 80189, 81189, 81269  
 PIONEER 80014, 80150, 80531, 80630, 81023  
 POLK AUDIO 80189, 81414  
 QUASAR 80039  
 RCA 80054, 80346, 80360, 80531, 81023, 81074, 81154, 81609  
 REALISTIC 80163  
 SAMSUNG 81304  
 SANSUI 80189, 80346, 81189  
 SANYO 80219  
 SCOTT 80163, 80322  
 SHERWOOD 81077, 81423, 81567, 81918  
 SIRIUS 81602, 81627, 81811  
 SONY 80158, 81058, 81406, 81759  
 SOUNDESIGN 80670  
 STEREOPHONICS 81023  
 SUNFIRE 81313

TEAC	80163, 81074	WARDS	80014, 80054,	(TUNER ID1)	81916
TECHNICS	80039, 80309,		80158, 80189	(TUNER ID2)	81917
	81308, 81518	XM	81406, 81414	(XM ID1)	81918
THORENS	81189	YAMAHA	80176, 81176,	(XM ID 2)	81919
TOSHIBA	80135		81276, 81331,		
VICTOR	80074		81375, 81908,		

---

## OTHER AUDIO ACCESSORIES

YAMAHA (iPod) 81981



© 2006 YAMAHA CORPORATION All rights reserved.

YAMAHA ELECTRONICS CORPORATION, USA 6660 ORANGETHORPE AVE., BUENA PARK, CALIF. 90620, U.S.A.  
 YAMAHA CANADA MUSIC LTD. 135 MILNER AVE., SCARBOROUGH, ONTARIO M1S 3R1, CANADA  
 YAMAHA ELECTRONIK EUROPA G.m.b.H. SIEMENSSTR. 22-34, 25462 RELINGEN BEI HAMBURG, GERMANY  
 YAMAHA ELECTRONIQUE FRANCE S.A. RUE AMBROISE CROIZAT BP70 CROISSY-BEAUBOURG 77312 MARNE-LA-VALLEE CEDEX02. FRANCE  
 YAMAHA ELECTRONICS (UK) LTD. YAMAHA HOUSE, 200 RICKMANSWORTH ROAD WATFORD, HERTS WD18 7GQ, ENGLAND  
 YAMAHA SCANDINAVIA A.B. J A WETTERGRENS GATA 1, BOX 30053, 400 43 VÄSTRA FRÖLUNDA, SWEDEN  
 YAMAHA MUSIC AUSTRALIA PTY, LTD. 17-33 MARKET ST., SOUTH MELBOURNE, 3205 VIC., AUSTRALIA

YAMAHA CORPORATION  
 Printed in Malaysia ◀ WG73510