



NS-AP8805

HOME CINEMA SPEAKER PACKAGE

CONTENTS

CONSUMER PRECAUTIONS	2
UNPACKING	3
SETTING UP THE SPEAKERS	4
CONNECTIONS TO THE RECEIVER	6
SPEAKER PLACEMENT	7
SPECIFICATIONS	Back cover

OWNER'S MANUAL







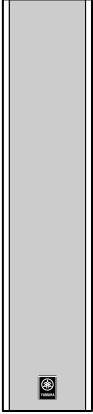

CONSUMER PRECAUTIONS

Read these precautions carefully before operating your NS-AP8805 speakers.

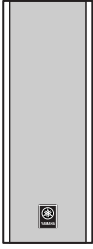
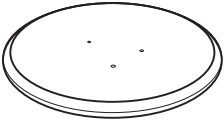
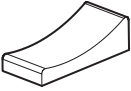
- Since these speakers can be wall mounted, it is essential that they are firmly secured. Be sure to consult a reliable source about the best type of hanger for your particular wall's construction. Secure installation is the purchaser's responsibility.
- Do not attach them to thin plywood or soft wall surface materials as the screws may tear free, causing the speakers to fall and be damaged, or result in personal injury.
- Do not fasten the speakers to walls with nails, adhesives, or other unsafe hardware. Long-term use and vibrations may cause them to pull free.
- Do not place the speakers where they are liable to be knocked over or struck by falling objects. Stable placement will also ensure better sound performance.
- Placing the speakers on the same stand or shelf as a turntable can result in feedback.
- This speaker features a magnetically shielded design, but there is still a chance that placing it too close to a TV set might impair picture color. Should this happen, move the speaker away from the TV set.
- Never touch the woofer or tweeter units with your hands or expose them to excessive physical shock. If they are dented or bent, the sound will be distorted.
- Lower the power amplifier / receiver volume control before changing input sources. Never change input sources (for example, FM to CD) at high listening levels. Always turn the receiver / amplifier unit off when installing or removing input cables.
- Anytime you note distortion, reduce the volume control on your power amplifier / receiver to a lower setting. Never allow your power amplifier to be driven into "clipping".
- Do not attempt to clean the speakers with chemical solvents as this might damage the finish. To clean wipe with a dry, soft cloth.
- To prevent the enclosure from warping or discoloring, do not place the speakers where they will be exposed to direct sunlight or excessive humidity.
- To prevent the speakers from falling over, select a location which is flat and stable.
- To avoid accidents resulting from tripping over loose speaker cables and to prevent the speakers from falling, fix the speaker cables to the wall, etc.
- Secure placement or installation is the owner's responsibility.
YAMAHA shall not be liable for any accident caused by improper placement or installation of speakers.

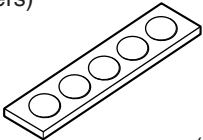
UNPACKING

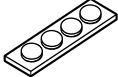
After unpacking, check that following items are contained.

<p>Front speaker x 2</p>  <p>(NS-AP8805F)</p>	<p>Center speaker x 1</p>  <p>(NS-AP8805C)</p>
<p>Spacer for pedestal x 2 (for front speaker)</p> 	<p>Surround speaker x 2</p>  <p>(NS-AP8805S)</p>
<p>Pedestal x 2 (for front speaker)</p> 	<p>Rubber base x 2 (for center speaker)</p> 
<p>Bolts x 6 (Φ 1/4" x 1-1/4" for pedestals)</p> 	<p>Double-sided adhesive tape x 2 (for center speaker)</p> 
<p>Non-skid pads 5 pcs x 2 (for front speakers)</p>  <p>(Φ 15 x 2 mm)</p>	<p>Fastener x 2 (for center speaker)</p> 
	<p>Wall mounting rubber pads 4 pcs x 5 (for all speaker units for wall-mount)</p>  <p>(Φ 10 x 5 mm)</p>
	<p>Speaker cable x 1 (80 feet)</p> 

SETTING UP THE SPEAKERS

- **Attaching the pedestals to the front speakers (When not wall mounting)**

Attach the pedestal to the front speaker as shown right by using bolts supplied with the product.

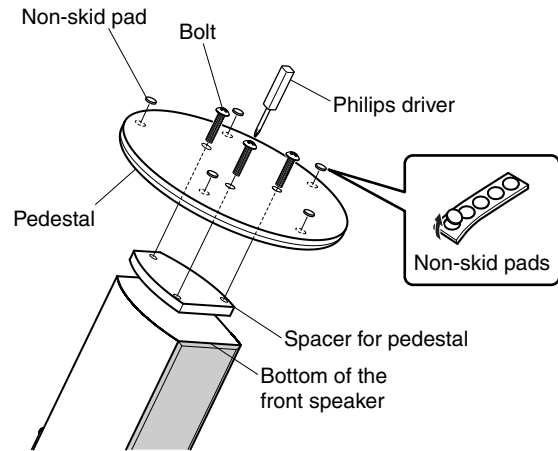

- **Wall mounting the speakers**

When mounting the speakers on a wall, attach one of the wall mounting rubber pads provided near each of the corners on the rear surface of the speaker to prevent the speaker cable from being caught between the wall and the speaker.

You can also use the screw holes on the back of the speaker for installing the speakers on commercially available speaker brackets.

Front Speakers

Surround Speakers

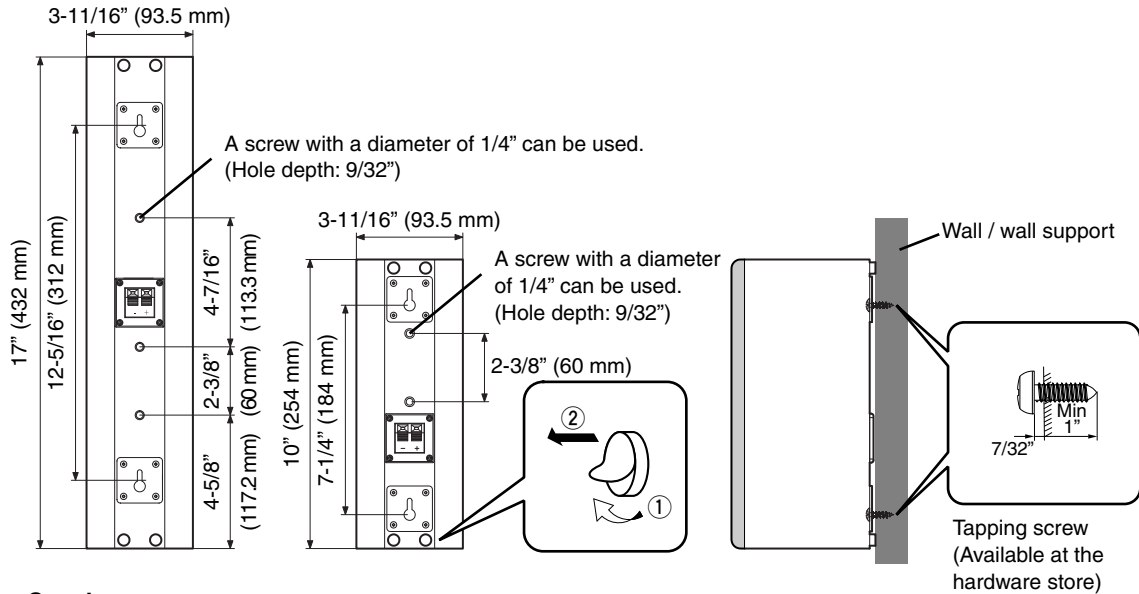

Center Speaker

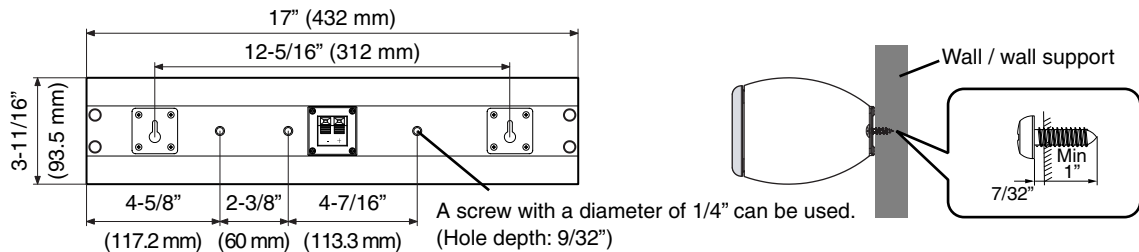

When using speaker brackets to mount the speakers on a wall or ceiling, it is strongly recommended that safety wire, which may be included with the bracket, be used between the speaker and the bracket to prevent the speaker from falling.

Fasten screws into a firm wall or wall support as shown in the figure, and hang the holes of the mounting bracket on the protruding screws.

4 Make sure that the screws are securely caught by the narrow sections of the "key hole" opening.

WARNING

- The each surround speaker weighs 3.53 lbs (1.6 kg) and front/center speaker weighs 5.29 lbs (2.4 kg). Do not mount the speakers on thin plywood or a wall with soft surface material, since the screws may pull away from the surface and fall. This will damage the speakers and can cause personal injury.
- Do not mount the speakers on a wall with nails, adhesives, or any other unstable hardware. Long-term use and vibrations may cause them to fall.
- To avoid accidents resulting from tripping over loose speaker cords, they should be affixed to the wall or floor molding.
- Secure installation is the purchaser's responsibility.

• Placing the center speaker

Place the speaker on the TV or inside the TV rack so that it is stabilized.

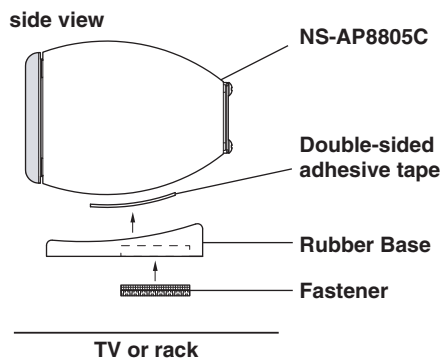

• Placing the center speaker on top of the TV

Affix the supplied fasteners to the bottom of the rubber bases. Peel off the seal and attach the center speaker to the top of the TV.

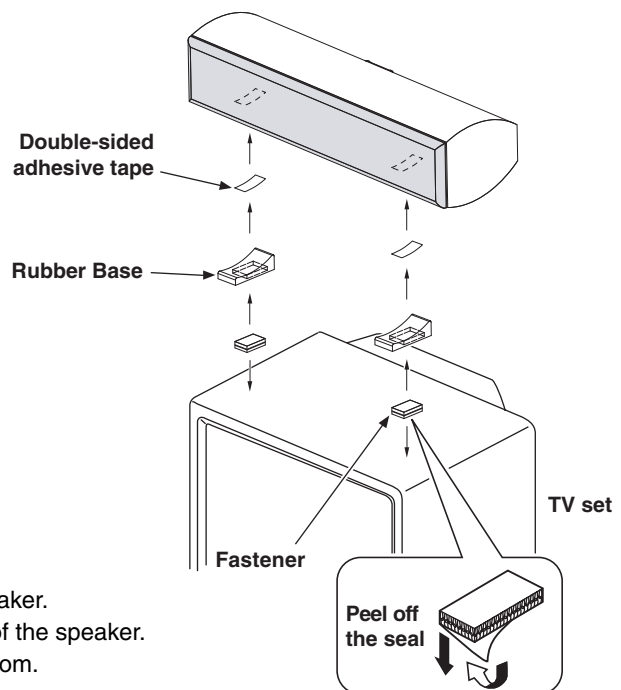

Attaching the rubber base

1. Decide the location where you want to place the speaker.
2. Affix the double-sided adhesive tape on the bottom of the speaker.
3. Attach the supplied rubber bases to the speaker bottom.

Notes

- Do not place the speaker on top of the TV if the area is smaller than the bottom area of the speaker. The speaker may fall and might cause personal injury.
- Do not place the speaker on top of the TV with an inclination.
- Do not touch the adhesive surface after peeling off the seal as this will weaken its adhesive strength.
- Thoroughly wipe clean the surface where the fastener is to be applied. Note that adhesive strength is weakened if the surface is dirty, oily or wet and that this may cause the center speaker to drop.
- Though this speaker is a magnetically shielded type, there may be some influence on a TV picture depending on the type of TV or the placement of the speaker. In such a case, place the speaker apart from TV so that there is no influence on TV picture.

WARNING

- To avoid accidents resulting from tripping over loose speaker cords, they should be affixed to the wall or floor molding.
- Secure installation is the purchaser's responsibility.

CONNECTIONS TO THE RECEIVER

CONNECTIONS

- Check to make sure that the power has been turned off before making connections.
- Connect the (+) terminal of the amplifier to the (+) terminal of the speaker.
Connect the (–) terminal of the amplifier to the (–) terminal of the speaker.
- Reversing polarity (+/–) will result in unnatural sound reproduction.

Note

Do not let the bare speaker wires touch each other as this could damage the speaker, the amplifier, or both.

PROCEDURE

For connections, keep the speaker cords as short as possible. Do not bundle or roll up the excess part of the cords. If the connections are faulty, no sound will be heard from the speakers. Make sure that the + and – polarity markings of the speaker cords are observed and set correctly. If these cords are reversed, the sound will be unnatural and lack bass.

How to Connect:

- ① Press and hold the terminal's tab.
- ② Insert the bare wire into the terminal hole.
[Remove approx. 10 mm (3/8") insulation from the speaker cords.]

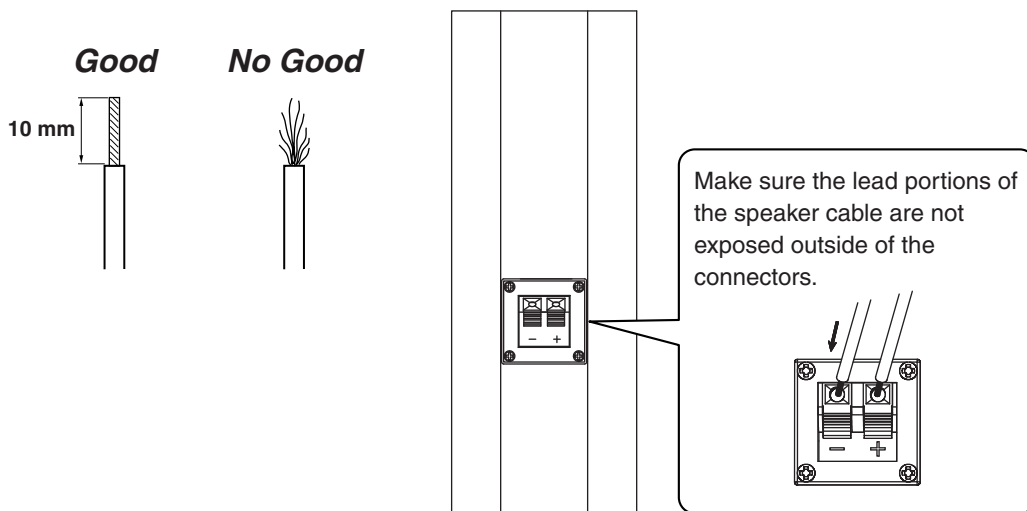

- ③ Release your finger from the tab to allow it to lock securely on the bare wire end.
- ④ Test the firmness of the connection by pulling lightly on the cord at the terminal.

SPEAKER PLACEMENT

This speaker system consists of front, center and surround speakers.

- **Front speaker** placement should be separated by a distance of 6–10ft. If they are placed too close together, there will be a reduction in the stereo effect. Conversely, if placed too far apart, the so called “middle-omission” effect will occur and the vocal center fill will be lost. Height of the speaker should be at least at ear level.
- **Center channel speakers** should be placed centered above or below the TV.
- **Surround speakers** should ideally be placed behind the listening area, at least as far apart as the front speakers and up to 2 additional feet apart per side. The height of the speaker should be at a minimum of ear level or preferably somewhat higher.

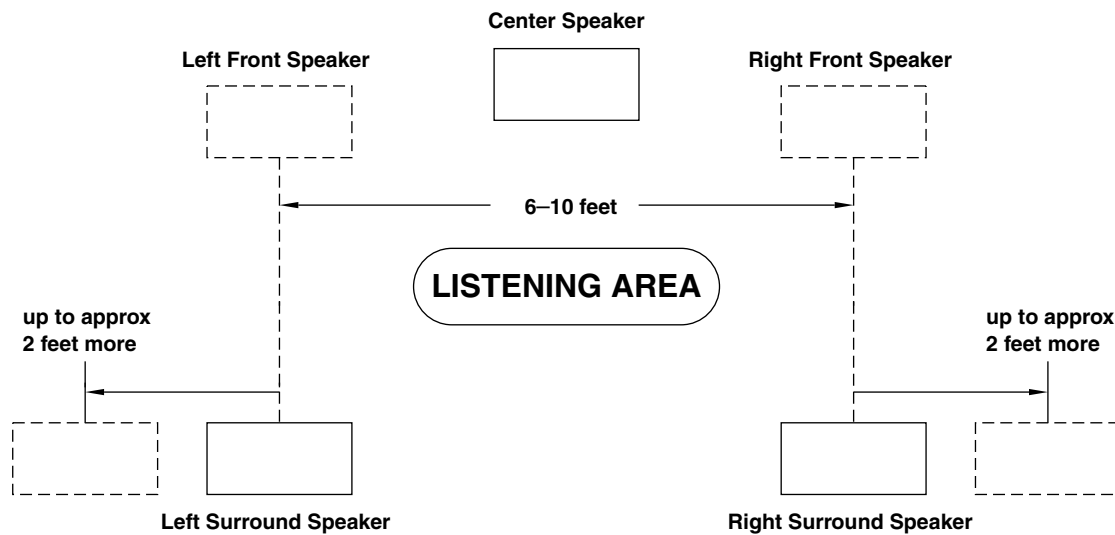

SPECIFICATIONS

Type	Front, Center Surround	3-Way Bass Reflex 2-Way Acoustic Suspension
Speaker	Front, Center Surround	2-1/4" white paper woofer x 4 + 3/4" silk dome tweeter 2-1/4" white paper woofer x 2 + 3/4" silk dome tweeter
Frequency Range	Front, Center Surround	80 Hz – 35 kHz 100 Hz – 35 kHz
Impedance		6 ohms
Nominal Input	Front, Center Surround	40 W 30 W
Maximum Input	Front, Center Surround	120 W 100 W
Sensitivity	Front, Center Surround	83 dB/2.83 V/m 82 dB/2.83 V/m
Crossover Frequency	Front, Center Surround	400 Hz & 4 kHz 4 kHz
Dimension (H x W x D)	Front (Cabinet) (with Pedestal) Center Surround	17" x 3-11/16" x 4-3/4" (432 x 93.5 x 120.5 mm) 18-3/16" x 3-11/16" x 4-3/4" (462 x 93.5 x 120.5 mm) 3-11/16" x 17" x 4-3/4" (93.5 x 432 x 120.5 mm) 10" x 3-11/16" x 4-3/4" (254 x 93.5 x 120.5 mm)
Weight	Front (with Pedestal) (without Pedestal) Center Surround	6.28 lbs/2.85 kg 5.29 lbs/2.4 kg 5.29 lbs/2.4 kg 3.53 lbs/1.6 kg
Magnetic Shielding		Yes.

* Specifications subject to change without notice due to product improvements.



YAMAHA ELECTRONICS CORPORATION, USA
6660 ORANGETHORPE AVE.,
BUENA PARK, CA 90620
<http://www.yamaha.com/yec>
Phone: 1-800-492-6242