



*Portable Grand*

DGX-20

DGX-5 YPG-525

# Owner's Manual



# SPECIAL MESSAGE SECTION

This product utilizes batteries or an external power supply (adapter). DO NOT connect this product to any power supply or adapter other than one described in the manual, on the name plate, or specifically recommended by Yamaha.

This product should be used only with the components supplied or; a cart, rack, or stand that is recommended by Yamaha. If a cart, etc., is used, please observe all safety markings and instructions that accompany the accessory product.

## **SPECIFICATIONS SUBJECT TO CHANGE:**

The information contained in this manual is believed to be correct at the time of printing. However, Yamaha reserves the right to change or modify any of the specifications without notice or obligation to update existing units.

This product, either alone or in combination with an amplifier and headphones or speaker/s, may be capable of producing sound levels that could cause permanent hearing loss. DO NOT operate for long periods of time at a high volume level or at a level that is uncomfortable. If you experience any hearing loss or ringing in the ears, you should consult an audiologist.

**IMPORTANT:** The louder the sound, the shorter the time period before damage occurs.

## **NOTICE:**

Service charges incurred due to a lack of knowledge relating to how a function or effect works (when the unit is operating as designed) are not covered by the manufacturer's warranty, and are therefore the owners responsibility. Please study this manual carefully and consult your dealer before requesting service.

## **ENVIRONMENTAL ISSUES:**

Yamaha strives to produce products that are both user safe and environmentally friendly. We sincerely believe that our products and the production methods used to produce them, meet these goals. In keeping with both the letter and the spirit of the law, we want you to be aware of the following:

## **Battery Notice:**

This product MAY contain a small non-rechargeable battery which (if applicable) is soldered in place. The average life span of this type of battery is approximately five years. When replacement becomes necessary, contact a qualified service representative to perform the replacement.

This product may also use "household" type batteries. Some of these may be rechargeable. Make sure that the battery being charged is a rechargeable type and that the charger is intended for the battery being charged.

When installing batteries, do not mix batteries with new, or with batteries of a different type. Batteries MUST be installed correctly. Mismatches or incorrect installation may result in overheating and battery case rupture.

## **Warning:**

Do not attempt to disassemble, or incinerate any battery. Keep all batteries away from children. Dispose of used batteries promptly and as regulated by the laws in your area. Note: Check with any retailer of household type batteries in your area for battery disposal information.

## **Disposal Notice:**

Should this product become damaged beyond repair, or for some reason its useful life is considered to be at an end, please observe all local, state, and federal regulations that relate to the disposal of products that contain lead, batteries, plastics, etc. If your dealer is unable to assist you, please contact Yamaha directly.

## **NAME PLATE LOCATION:**

The name plate is located on the bottom of the product. The model number, serial number, power requirements, etc., are located on this plate. You should record the model number, serial number, and the date of purchase in the spaces provided below and retain this manual as a permanent record of your purchase.

**Model**

---

**Serial No.**

---

**Purchase Date**

---

# PLEASE KEEP THIS MANUAL

92-BP (bottom)

## FCC INFORMATION (U.S.A.)

### 1. IMPORTANT NOTICE: DO NOT MODIFY THIS UNIT!

This product, when installed as indicated in the instructions contained in this manual, meets FCC requirements. Modifications not expressly approved by Yamaha may void your authority, granted by the FCC, to use the product.

### 2. IMPORTANT:

When connecting this product to accessories and/or another product use only high quality shielded cables. Cable/s supplied with this product MUST be used. Follow all installation instructions. Failure to follow instructions could void your FCC authorization to use this product in the USA.

### 3. NOTE:

This product has been tested and found to comply with the requirements listed in FCC Regulations, Part 15 for Class "B" digital devices. Compliance with these requirements provides a reasonable level of assurance that your use of this product in a residential environment will not result in harmful interference with other electronic devices. This equipment generates/uses radio frequencies and, if not installed and used according to the instructions found in the users manual, may cause interference harmful to the operation of other electronic devices. Compliance with FCC regulations does

not guarantee that interference will not occur in all installations. If this product is found to be the source of interference, which can be determined by turning the unit "OFF" and "ON", please try to eliminate the problem by using one of the following measures:

Relocate either this product or the device that is being affected by the interference.

Utilize power outlets that are on different branch (circuit breaker or fuse) circuits or install AC line filter/s.

In the case of radio or TV interference, relocate/reorient the antenna. If the antenna lead-in is 300 ohm ribbon lead, change the lead-in to co-axial type cable.

If these corrective measures do not produce satisfactory results, please contact the local retailer authorized to distribute this type of product. If you can not locate the appropriate retailer, please contact Yamaha Corporation of America, Electronic Service Division, 6600 Orangethorpe Ave, Buena Park, CA90620

The above statements apply ONLY to those products distributed by Yamaha Corporation of America or its subsidiaries.

\* This applies only to products distributed by YAMAHA CORPORATION OF AMERICA.

(class B)

### OBSERVERA!

Apparaten kopplas inte ur växelströmskällan (nätet) så länge som den är ansluten till vägguttaget, även om själva apparaten har stängts av.

**ADVARSEL:** Netspændingen til dette apparat er IKKE afbrudt, så længe netledningen sidder i en stikkontakt, som er t endt — også selvom der er slukket på apparatets afbryder.

**VAROITUS:** Laitteen toisiopiiriin kytketty käyttökytkin ei irroita koko laitetta verkosta.

(standby)

# PRECAUTIONS

## PLEASE READ CAREFULLY BEFORE PROCEEDING

\* Please keep this manual in a safe place for future reference.



### WARNING

Always follow the basic precautions listed below to avoid the possibility of serious injury or even death from electrical shock, short-circuiting, damages, fire or other hazards. These precautions include, but are not limited to, the following:

#### Power supply/AC power adaptor

- Only use the voltage specified as correct for the instrument. The required voltage is printed on the name plate of the instrument.
- Use the specified adaptor (PA-5D or an equivalent recommended by Yamaha) only. Using the wrong adaptor can result in damage to the instrument or overheating.
- Check the electric plug periodically and remove any dirt or dust which may have accumulated on it.
- Do not place the AC adaptor cord near heat sources such as heaters or radiators, and do not excessively bend or otherwise damage the cord, place heavy objects on it, or place it in a position where anyone could walk on, trip over, or roll anything over it.

#### Do not open

- Do not open the instrument or attempt to disassemble the internal parts or modify them in any way. The instrument contains no user-serviceable parts. If it should appear to be malfunctioning, discontinue use immediately and have it inspected by qualified Yamaha service personnel.

#### Water warning

- Do not expose the instrument to rain, use it near water or in damp or wet conditions, or place containers on it containing liquids which might spill into any openings.
- Never insert or remove an electric plug with wet hands.

#### Fire warning

- Do not put burning items, such as candles, on the unit. A burning item may fall over and cause a fire.

#### If you notice any abnormality

- If the AC adaptor cord or plug becomes frayed or damaged, or if there is a sudden loss of sound during use of the instrument, or if any unusual smells or smoke should appear to be caused by it, immediately turn off the power switch, disconnect the adaptor plug from the outlet, and have the instrument inspected by qualified Yamaha service personnel.



### CAUTION

Always follow the basic precautions listed below to avoid the possibility of physical injury to you or others, or damage to the instrument or other property. These precautions include, but are not limited to, the following:

#### Power supply/AC power adaptor

- When removing the electric plug from the instrument or an outlet, always hold the plug itself and not the cord.
- Unplug the AC power adaptor when not using the instrument, or during electrical storms.
- Do not connect the instrument to an electrical outlet using a multiple-connector. Doing so can result in lower sound quality, or possibly cause overheating in the outlet.

#### Location

- Do not expose the instrument to excessive dust or vibrations, or extreme cold or heat (such as in direct sunlight, near a heater, or in a car during the day) to prevent the possibility of panel discoloration or damage to the internal components.
- Do not use the instrument in the vicinity of a TV, radio, stereo equipment, mobile phone, or other electric devices. Otherwise, the instrument, TV, or radio may generate noise.

- Do not place the instrument in an unstable position where it might accidentally fall over.
- Before moving the instrument, remove all connected adaptor and other cables.
- When setting up the instrument, make sure that the AC outlet you are using is easily accessible. If some trouble or malfunction occurs, immediately turn off the power switch and disconnect the plug from the outlet.
- Use only the stand specified for the instrument. When attaching the stand or rack, use the provided screws only. Failure to do so could cause damage to the internal components or result in the instrument falling over.

## Connections

- Before connecting the instrument to other electronic components, turn off the power for all components. Before turning the power on or off for all components, set all volume levels to minimum. Also, be sure to set the volumes of all components at their minimum levels and gradually raise the volume controls while playing the instrument to set the desired listening level.

## Maintenance

- When cleaning the instrument, use a soft, dry cloth. Do not use paint thinners, solvents, cleaning fluids, or chemical-impregnated wiping cloths.

## Handling caution

- Do not insert a finger or hand in any gaps on the instrument.
- Never insert or drop paper, metallic, or other objects into the gaps on the panel or keyboard. If this happens, turn off the power immediately and unplug the power cord from the AC outlet. Then have the instrument inspected by qualified Yamaha service personnel.
- Do not place vinyl, plastic or rubber objects on the instrument, since this might discolor the panel or keyboard.
- Do not rest your weight on, or place heavy objects on the instrument, and do not use excessive force on the buttons, switches or connectors.
- Do not operate the instrument for a long period of time at a high or uncomfortable volume level, since this can cause permanent hearing loss. If you experience any hearing loss or ringing in the ears, consult a physician.

## Saving data

### Saving and backing up your data

The panel settings and some other types of data are not retained in memory when you turn off the power to the instrument. Save data you want to keep to the Registration Memory (page 85.)

Saved data may be lost due to malfunction or incorrect operation.

Save important data to a USB storage device/or other external device such as a computer. (pages 93, 104)

### Backing up the USB storage device/external media

- To protect against data loss through media damage, we recommend that you save your important data onto two USB storage devices/external media.

Yamaha cannot be held responsible for damage caused by improper use or modifications to the instrument, or data that is lost or destroyed.

Always turn the power off when the instrument is not in use.

Even when the power switch is in the "STANDBY" position, electricity is still flowing to the instrument at the minimum level. When you are not using the instrument for a long time, make sure you unplug the AC power adaptor from the wall AC outlet.

The illustrations and LCD screens as shown in this owner's manual are for instructional purposes only, and may appear somewhat different from those on your instrument.

## ● Trademarks

- The bitmap fonts used in this instrument have been provided by and are the property of Ricoh Co., Ltd.
- Windows is the registered trademarks of Microsoft® Corporation.
- The company names and product names in this Owner's Manual are the trademarks or registered trademarks of their respective companies.

## Copyright Notice

The followings are the titles, credits and copyright notices for three (3) of the songs pre-installed in this electronic keyboard:

Mona Lisa

from the Paramount Picture CAPTAIN CAREY, U.S.A.  
Words and Music by Jay Livingston and Ray Evans  
Copyright © 1949 (Renewed 1976) by Famous Music Corporation  
International Copyright Secured All Rights Reserved

Composition Title : Against All Odds  
Composer's Name : Collins 0007403  
Copyright Owner's Name : EMI MUSIC PUBLISHING LTD /  
HIT & RUN MUSIC LTD

Can't Help Falling In Love

from the Paramount Picture BLUE HAWAII  
Words and Music by George David Weiss,  
Hugo Peretti and Luigi Creatore  
Copyright © 1961 by Gladys Music, Inc.  
Copyright Renewed and Assigned to Gladys Music  
All Rights Administered by Cherry Lane Music Publishing Com-  
pany, Inc. and Chrysalis Music  
International Copyright Secured All Rights Reserved

This device is capable of using various types/formats of music data by optimizing them to the proper format music data for use with the device in advance. As a result, this device may not play them back precisely as their producers or composers originally intended.

This product incorporates and bundles computer programs and contents in which Yamaha owns copyrights or with respect to which it has license to use others' copyrights. Such copyrighted materials include, without limitation, all computer software, style files, MIDI files, WAVE data, musical scores and sound recordings. Any unauthorized use of such programs and contents outside of personal use is not permitted under relevant laws. Any violation of copyright has legal consequences. **DON'T MAKE, DISTRIBUTE OR USE ILLEGAL COPIES.**

Copying of the commercially available musical data including but not limited to MIDI data and/or audio data is strictly prohibited except for your personal use.

## Panel Logos



### GM System Level 1

"GM System Level 1" is an addition to the MIDI standard which ensures that any GM-compatible music data can be accurately played by any GM-compatible tone generator, regardless of manufacturer. The GM mark is affixed to all software and hardware products that support GM System Level.



### XGlite

As its name implies, "XGlite" is a simplified version of Yamaha's high-quality XG tone generation format. Naturally, you can play back any XG song data using an XGlite tone generator. However, keep in mind that some songs may play back differently compared to the original data, due to the reduced set of control parameters and effects.



### XF

The Yamaha XF format enhances the SMF (Standard MIDI File) standard with greater functionality and open-ended expandability for the future. The instrument is capable of displaying lyrics when an XF file containing lyric data is played.



### STYLE FILE

The Style File Format is Yamaha's original style file format which uses a unique conversion system to provide high-quality automatic accompaniment based on a wide range of chord types.



### USB

USB is an abbreviation for Universal Serial Bus. It is a serial interface for connecting a computer with peripheral Devices. It allows "hot swapping" (connecting peripheral devices while the power to the computer is on).

*Congratulations and thank you for purchasing  
the Yamaha DGX-620/520, YPG-625/525 Portable Grand!*

*Please read this owner's manual carefully before using the instrument  
in order to take full advantage of its various features.*

*Make sure to keep this manual in a safe and handy place even after you finish reading,  
and refer to it often when you need to better understand an operation or function.*

## **Accessories**

The DGX-620/520, YPG-625/525 package includes the following items. Please check that you have them all.

- Music rest
- Accessory CD-ROM
- Owner's manual (this book)
- Keyboard stand
- Footswitch
- AC Power Adaptor (May not be included depending on your particular area.  
Please check with your Yamaha dealer.)

# Special Features of the DGX-620/520, YPG-625/525

## Graded Hammer Standard Keyboard (DGX-620/YPG-625 Only)

Thanks to our experience as the world's leading manufacturer of acoustic pianos, we've developed a keyboard with action that's virtually indistinguishable from the real thing. Just as on a traditional acoustic piano, the keys of the lower notes have a heavier touch, while the higher ones are more responsive to lighter playing. The keyboard's sensitivity can even be adjusted to match your playing style. This Graded Hammer technology also enables the DGX-620/YPG-625 to provide authentic touch in a light-weight instrument.

### Performance assistant technology ▶ Page 35

Play along with a song on the instrument's keyboard and produce a perfect performance every time ... even if you play wrong notes! All you have to do is play on the keyboard—alternately on the left- and right-hand ranges of the keyboard, for example—and you'll sound like a pro as long as you play in time with the music.

And if you can't play with both hands, you can still play the melody simply by tapping one key.



All you need is one finger!

### Play a Variety of Instrument Voices ▶ Page 15

With the DGX-620/520, YPG-625/525, the instrument voice that sounds when you play the keyboard can be changed to violin, flute, harp, or any of an extensive range of voices. You can change the mood of a song written for piano, for example, by using violin to play it instead. Experience a whole new world of musical variety.



### Play Along with Styles ▶ Page 24

Want to play with full accompaniment? Try the auto-accompaniment Styles. The accompaniment styles provide the equivalent of a full backing band covering wide variety of styles from waltzes to 8-beat to euro-trance ... and much more. Select a style that matches the music you want to play, or experiment with new styles to expand your musical horizons.

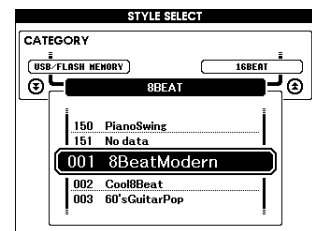

### Easy Performance with Music Notation Display ▶ Page 33

When you play back a song, the corresponding score will be shown on the display as the song plays. This is a great way to learn how to read music. If the song contains lyric and chord data\*, the lyrics and chords will also appear on the score display.

\* No lyrics or chords will appear on the display if the song you are using with the score display function does not contain the appropriate lyric and chord data.

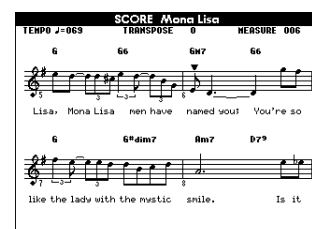



# Contents

Copyright Notice .....	6
Panel Logos .....	6
Accessories .....	7
Special Features of the DGX-620/520, YPG-625/525 .....	8
<b>Setting Up</b> .....	<b>10</b>
Power Requirements .....	10
Connecting Headphones (PHONES/OUTPUT Jack) .....	10
Connecting a Footswitch (SUSTAIN Jack) .....	10
Connecting to a Computer (USB Terminal) .....	11
Turning the Power On .....	11
<b>Panel Controls and Terminals</b> .....	<b>12</b>
Front Panel .....	12
Rear Panel .....	13
<b>Quick Guide</b>	
<b>Changing the Display Language</b> .....	<b>14</b>
<b>Try Playing a Variety of Instrument Voices</b> .....	<b>15</b>
Select and Play a Voice—MAIN .....	15
Play Two Voices Simultaneously—DUAL .....	16
Play Different Voices with the Left and Right Hands—SPLIT .....	17
Play the Grand Piano Voice .....	18
<b>Fun Sounds</b> .....	<b>19</b>
Drum Kits .....	19
Sound Effects .....	19
<b>The Metronome</b> .....	<b>20</b>
Start the Metronome .....	20
Adjusting the Metronome Tempo .....	20
Setting the Number of Beats per Measure, and the Length of Each Beat .....	21
Adjusting the Metronome Volume .....	22
<b>Playing Styles</b> .....	<b>23</b>
Select a Style Rhythm .....	23
Play Along with a Style .....	24
Playing Auto-accompaniment Chords .....	28
<b>Using Songs</b> .....	<b>29</b>
Select and Listen to a Song .....	29
Song Fast Forward, Fast Reverse, and Pause .....	30
Types of Songs .....	32
Displaying the Song Score .....	33
Display the Lyrics .....	34
<b>The Easy Way to Play Piano</b> .....	<b>35</b>
CHORD Type—Play with Both Hands .....	36
CHORD/FREE Type— Applying the Chord Type to the Left Hand Only .....	38
MELODY Type—Play with One Finger .....	40
CHORD/MELODY— Chord Type with the Left Hand, Melody with the Right .....	42
Change the Song Tempo .....	46
Play the Demo Song .....	46
<b>Select a Song For a Lesson</b> .....	<b>47</b>
Lesson 1—Waiting .....	47
Lesson 2—Your Tempo .....	50
Lesson 3—Minus One .....	51
Practice Makes Perfect—Repeat and Learn .....	52
<b>Play Using the Music Database</b> .....	<b>53</b>
<b>Change a Song's Style</b> .....	<b>54</b>
Try Out the Easy Song Arranger .....	54
Using the Easy Song Arranger .....	54
<b>Record Your Own Performance</b> .....	<b>56</b>
Track Configuration .....	56
Recording Procedure .....	57
Song Clear—Deleting User Songs .....	59
Track Clear—Deleting a Specified Track from a User Song .....	60
<b>Backup and Initialization</b> .....	<b>61</b>
Backup .....	61
Initialization .....	61
<b>Basic Operation</b> .....	<b>62</b>
Basic Operation .....	62
The Displays .....	64
MAIN Display Items .....	65

## Reference

<b>Play with a Variety of Effects</b> .....	<b>66</b>
Adding Harmony .....	66
Adding Reverb .....	67
Adding Chorus .....	68
Panel Sustain .....	69
Pitch Bend .....	69
<b>Handy Performance Features</b> .....	<b>70</b>
Tap Start .....	70
Touch Response Sensitivity .....	70
One Touch Setting .....	71
Select an EQ Setting for the Best Sound .....	72
Pitch Controls .....	73
<b>Style (Auto-accompaniment) Functions</b> .....	<b>74</b>
Pattern Variation (Sections) .....	74
Setting the Split Point .....	77
Play a Style with Chords but No Rhythm (Stop Accompaniment) .....	78
Adjusting the Style Volume .....	78
Chord Basics .....	79
Style File .....	81
Playing Styles Using the Entire Keyboard .....	81
Looking Up Chords Using the Chord Dictionary .....	82
<b>Song Settings</b> .....	<b>83</b>
Song Volume .....	83
A-B Repeat .....	83
Muting Independent Song Parts .....	84
Change the Melody Voice .....	84
<b>Memorize Your Favorite Panel Settings</b> .....	<b>85</b>
Saving to the Registration Memory .....	85
Recalling a Registration Memory .....	86
<b>The Functions</b> .....	<b>87</b>
Selecting and Setting Functions .....	87
<b>Using USB Flash Memory</b> .....	<b>90</b>
USB Flash Memory .....	90
Connecting a USB Flash Memory .....	91
Formatting USB Flash Memory .....	92
Saving Data .....	93
Convert a User Song to SMF Format and Save .....	94
Loading User Files and Style Files .....	95
Deleting Data from a USB Flash Memory .....	96
Playing Songs Saved to USB Flash Memory .....	96
<b>Connections</b> .....	<b>97</b>
Connectors .....	97
Connection to a USB Storage Device .....	97
Connecting a Personal Computer .....	99
Transferring Performance Data to and from a Computer .....	100
Remote Control of MIDI Devices .....	101
Initial Send .....	102
Transferring Data Between the Computer and Instrument .....	102
<b>Accessory CD-ROM Installation Guide</b> .....	<b>105</b>
Important Notices about the CD-ROM .....	105
CD-ROM Contents .....	106
System Requirements .....	107
Software Installation .....	107
<b>Appendix</b>	
Troubleshooting .....	112
Messages .....	114
 <b>Keyboard Stand Assembly</b> .....	<b>116</b>
Scores .....	118
Voice List .....	124
Drum Kit List .....	128
Style List .....	130
Music Database List .....	131
Songs Provided On the Supplied CD-ROM .....	132
Effect Type List .....	133
MIDI Implementation Chart .....	134
MIDI Data Format .....	136
Specifications .....	137
Index .....	138



# Setting Up

Be sure to do the following operations **BEFORE** turning on the power.

## Power Requirements

- 1 Make sure that the [STANDBY/ON] switch of the instrument is set to STANDBY.

### ⚠ WARNING

- Use **ONLY** a Yamaha PA-5D AC Power Adaptor (or other adaptor specifically recommended by Yamaha) to power your instrument from the AC mains. The use of other adaptors may result in irreparable damage to both the adaptor and the instrument.

- 2 Connect the AC adaptor (PA-5D or other adaptor specifically recommended by Yamaha) to the power supply jack.

- 3 Plug the AC adaptor into an AC outlet.

### ⚠ CAUTION

- Unplug the AC Power Adaptor when not using the instrument, or during electrical storms.

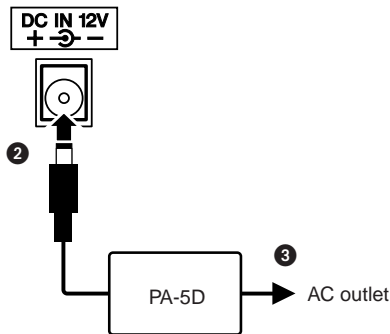

Make all necessary connections below **BEFORE** turning the power on.

## Connecting Headphones (PHONES/OUTPUT Jack)

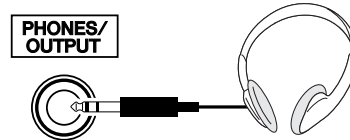

The instrument speakers are automatically shut off when a plug is inserted into this jack. The PHONES/OUTPUT jack also functions as an external output. You can connect the PHONES/OUTPUT jack to a keyboard amplifier, stereo system, mixer, tape recorder, or other line-level audio device to send the instrument's output signal to that device.

### ⚠ WARNING

- Avoid listening with the headphones at high volume for long periods of time; doing so may not only result in ear fatigue, it may be damaging to your hearing.

### ⚠ CAUTION

- To prevent damage to the speakers, set the volume of the external devices at the minimum setting before connecting them. Failure to observe these cautions may result in electric shock or equipment damage. Also, be sure to set the volumes of all devices at their minimum levels and gradually raise the volume controls while playing the instrument to set the desired listening level.

## Connecting a Footswitch (SUSTAIN Jack)

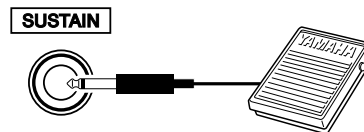

The sustain function lets you produce a natural sustain as you play by pressing a footswitch. Plug the Yamaha FC5 footswitch into this jack and use it to switch sustain on and off.

### NOTE

- Make sure that the footswitch plug is properly connected to the SUSTAIN jack before turning on the power.
- Do not press the footswitch while turning the power on. Doing this changes the recognized polarity of the footswitch, resulting in reversed footswitch operation.

## Connecting to a Computer (USB Terminal)

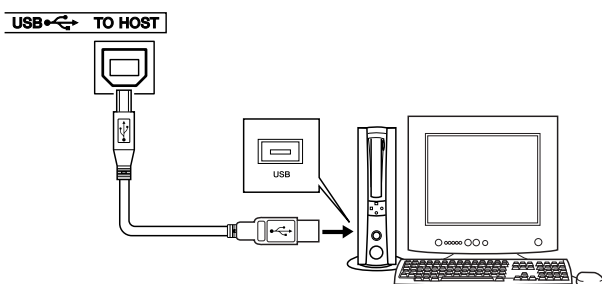

Connect the instrument's USB terminal to the USB terminal of a computer, and you can transfer performance data and song files between the two (page 99). To use the USB data-transfer features you'll need to do the following:

- First, make sure the POWER switch on the instrument is set to OFF, then use a USB cable to connect the instrument to the computer. After making the connections, turn the instrument's power on.
- Install the USB MIDI driver on your computer.

Installation of the USB MIDI driver is described on page 107.

## Turning the Power On

Turn down the volume by turning the [MASTER VOLUME] control to the left and press the [STANDBY/ON] switch to turn on the power. Press the [STANDBY/ON] switch again to turn the power OFF.

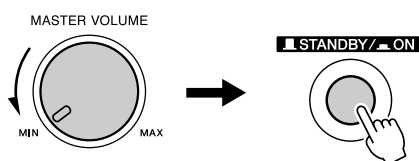

Backup data in the flash memory is loaded to the instrument when the power is turned on. If no backup data exists on flash memory, all instrument settings are restored to the initial factory defaults when the power is turned on.

### **CAUTION**

- Even when the switch is in the "STANDBY" position, electricity is still flowing to the instrument at the minimum level. When you are not using the instrument for a long time, make sure you unplug the AC power adaptor from the wall AC outlet.

### **CAUTION**

- Never attempt to turn the power off when a "WRITING!" message is shown in the display. Doing so can damage the flash memory and result in a loss of data.

## ● Music Rest

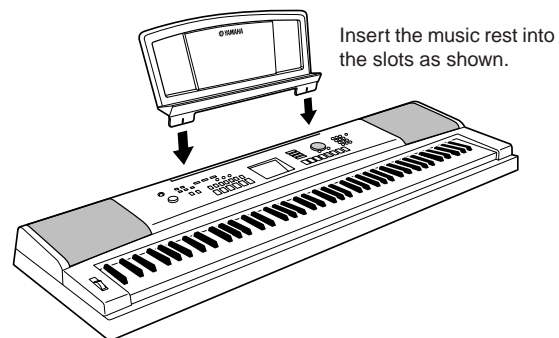



# Panel Controls and Terminals

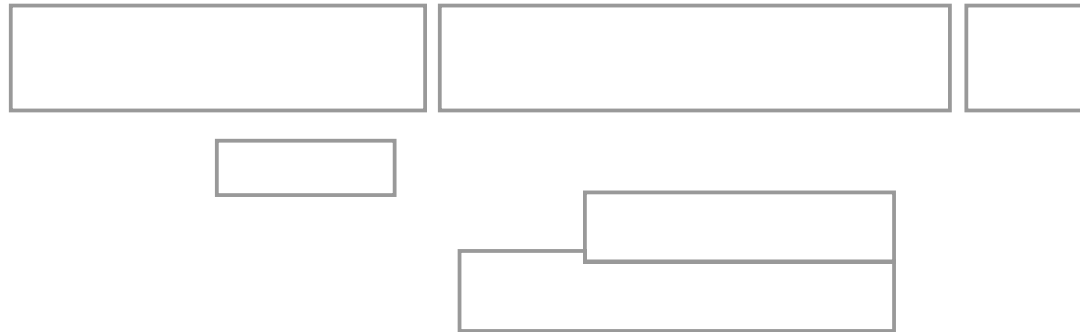

- ① [STANDBY/ON] switch ..... page 11
- ② [MASTER VOLUME] control.... pages 11, 62
- ③ FILE CONTROL [MENU],  
[EXECUTE] buttons..... pages 91–96
- ④ [LYRICS] button ..... page 34
- ⑤ [SCORE] button ..... page 33
- ⑥ [CHORD FINGERING] button ..... page 81
- ⑦ [P.A.T. ON/OFF] button ..... page 36
- ⑧ [MUSIC DATABASE] button ..... page 53
- ⑨ [FUNCTION] button ..... pages 64, 87
- ⑩ LESSON [L], [R],  
[START] buttons ..... page 48
- ⑪ [METRONOME ON/OFF] button ..... page 20
- ⑫ [TEMPO/TAP] button ..... pages 46, 70
- ⑬ SONG MEMORY  
[REC], [1]–[5], [A] buttons..... page 57
- ⑭ [REPEAT & LEARN]/  
[ACMP ON/OFF] button .....pages 52, 24
- ⑮ [A-B REPEAT]/  
[INTRO/ENDING/rit.] button.....pages 83, 74
- ⑯ [REW]/  
[MAIN/AUTO FILL] button .....pages 30, 74
- ⑰ [FF]/[SYNC STOP] button .....pages 30, 76
- ⑱ [PAUSE]/  
[SYNC START] button .....pages 30, 75
- ⑲ [START/STOP] button .....pages 23, 30, 63
- ⑳ [SONG] button ..... page 29
- ㉑ [EASY SONG  
ARRANGER] button ..... page 54
- ㉒ [STYLE] button ..... page 23
- ㉓ [VOICE] button ..... page 15

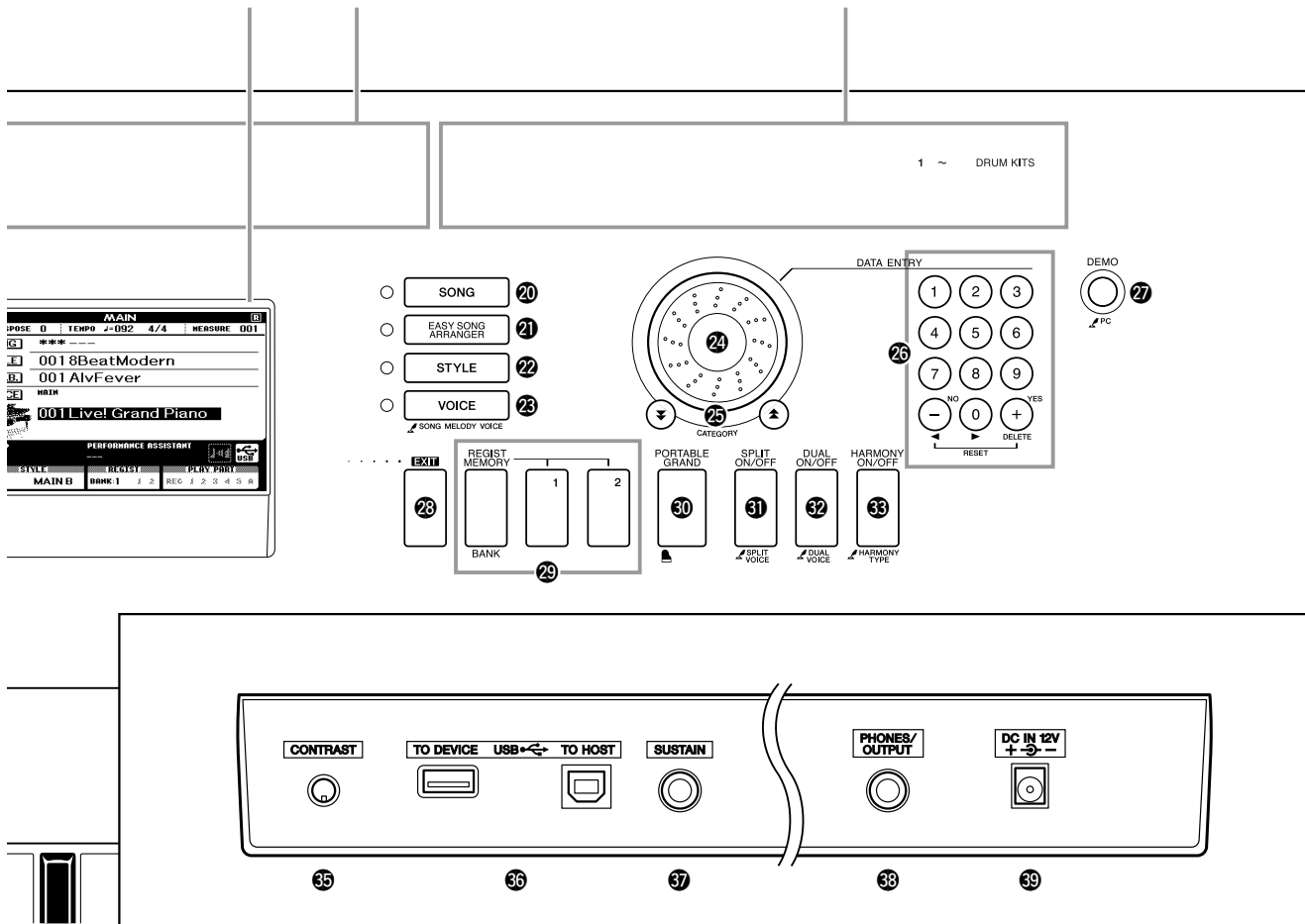

- 24 Dial..... pages 63, 87
- 25 CATEGORY [ ] and [ ] buttons ..... pages 63, 87
- 26 Number buttons [0]–[9], [+ ] and [- ] buttons..... pages 63, 87
- 27 [DEMO] button..... page 46
- 28 [EXIT] button..... page 64
- 29 REGIST MEMORY [MEMORY/BANK], [1], [2] buttons.. page 85
- 30 [PORTABLE GRAND] button ..... page 18
- 31 [SPLIT ON/OFF] button ..... page 17
- 32 [DUAL ON/OFF] button ..... page 16
- 33 [HARMONY ON/OFF] button ..... page 66
- 34 [PITCH BEND] wheel..... page 69
- 35 CONTRAST knob ..... page 65
- 36 USB TO DEVICE, TO HOST terminals .....pages 11, 99
- 37 SUSTAIN jack..... page 10
- 38 PHONES/OUTPUT jack ..... page 10
- 39 DC IN 12V jack..... page 10

# Changing the Display Language

This instrument allows you to select English or Japanese as the display language. The default display language is English, but if you switch to Japanese the lyrics, file names, demo display, and some messages will be displayed in Japanese where appropriate.

## 1 Press the [FUNCTION] button.

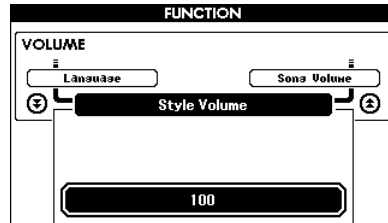
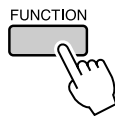

## 2 Press the CATEGORY [▲] and [▼] buttons a number of times until the “Language” item appears.

The currently selected display language will appear below the “Language” item.

When highlighted you can use the [+] and [-] buttons to select the language as required.

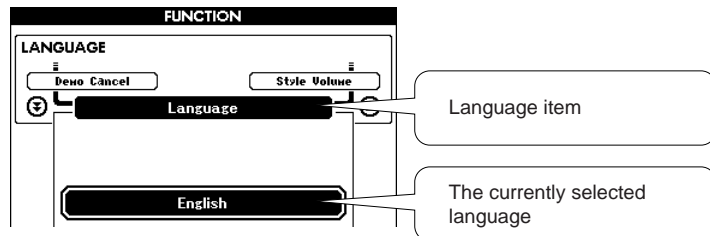
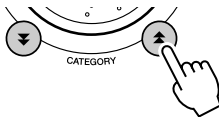

## 3 Select a display language.

The [+] button selects English and the [-] button selects Japanese.

The language selection will be stored in the internal flash memory so that it is retained even when the power is turned off.

## 4 Press the [EXIT] button to return to the MAIN display.



# Try Playing a Variety of Instrument Voices

In addition to piano, organ, and other “standard” keyboard instruments, this instrument has a large range of voices that includes guitar, bass, strings, sax, trumpet, drums and percussion, sound effects ... a wide variety of musical sounds.

## Select and Play a Voice—MAIN

This procedure selects the main voice you will play on the keyboard.

### 1 Press the [VOICE] button.

The main voice selection display will appear.  
The currently selected voice number and name will be highlighted.

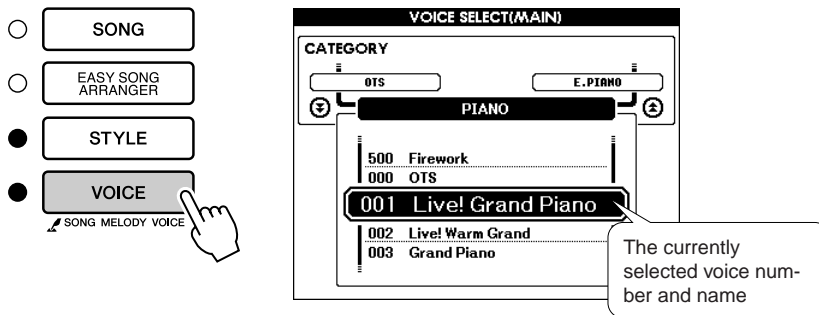

### 2 Select the voice you want to play.

While watching the highlighted voice name rotate the dial. The available voices will be selected and displayed in sequence. The voice selected here becomes the main voice.  
For this example select the “102 Flute” voice.

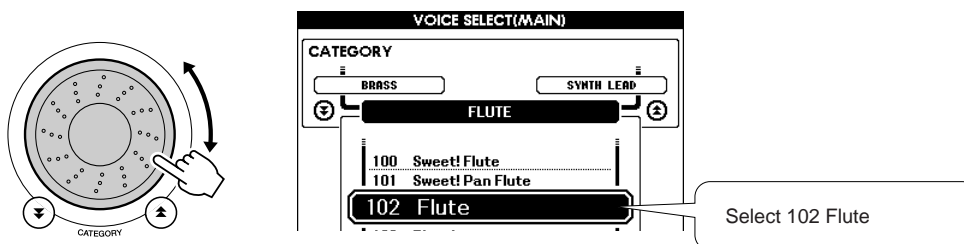

### 3 Play the keyboard.

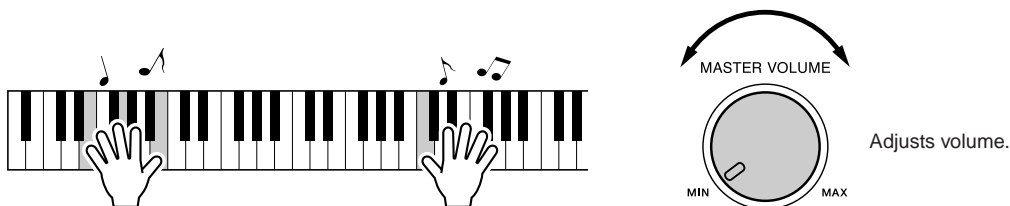

Try selecting and playing a variety of voices.  
Press the [EXIT] button to return to the MAIN display.

## Play Two Voices Simultaneously—DUAL

You can select a second voice which will play in addition to the main voice when you play the keyboard. The second voice is known as the “dual” voice.

### 1 Press the [DUAL ON/OFF] button.

The [DUAL ON/OFF] button turns the dual voice on or off. When turned on the dual voice “DUAL” will appear in the MAIN display. The currently selected dual voice will sound in addition to the main voice when you play the keyboard.

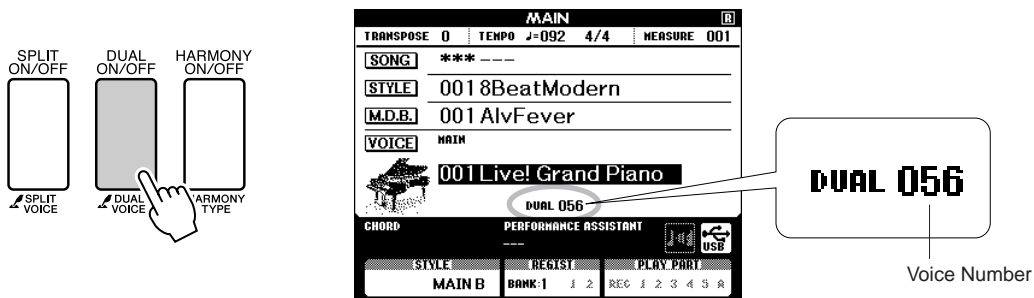

### 2 Press and hold the [DUAL ON/OFF] button for longer than a second.

The dual voice selection display will appear.

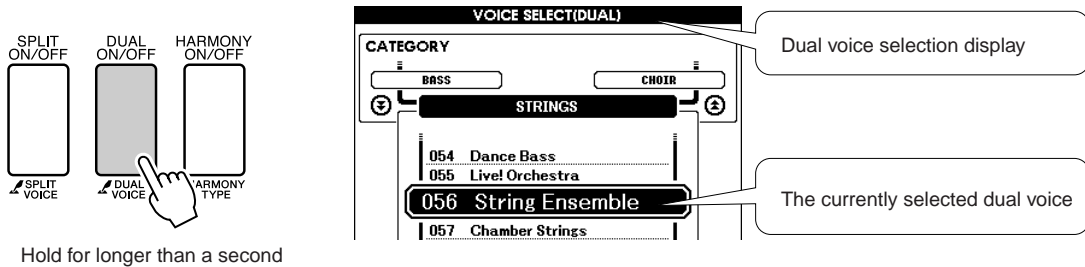

### 3 Select the desired dual voice.

Watch the displayed dual voice and rotate the dial until the voice you want to use is selected. The voice selected here becomes the dual voice. For this example try selecting the “120 Vibraphone” voice.

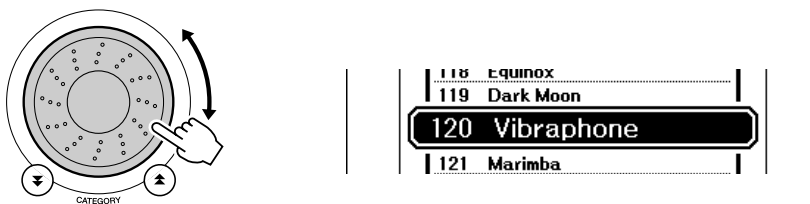



# 4 Play the keyboard.

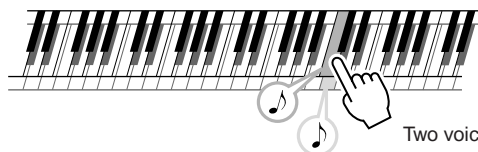

Two voices will sound at the same time.

Try selecting and playing a range of dual voices.

Press the [EXIT] button to return to the MAIN display.

## Play Different Voices with the Left and Right Hands—SPLIT

In the split mode you can play different voices to the left and right of the keyboard “split point”. The main and dual voices can be played to the right of the split point, while the voice played to the left of the split point is known as the “split voice”. The split point setting can be changed as required (page 77).

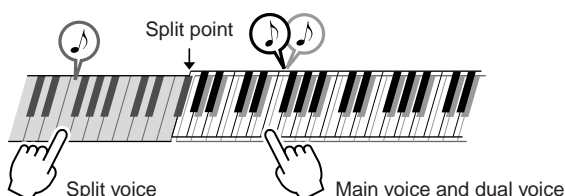

# 1 Press the [SPLIT ON/OFF] button.

The [SPLIT ON/OFF] button turns the split voice on or off. When turned on the split voice “SPLIT” will appear in the MAIN display. The currently selected split voice will sound to the left of the keyboard split point.

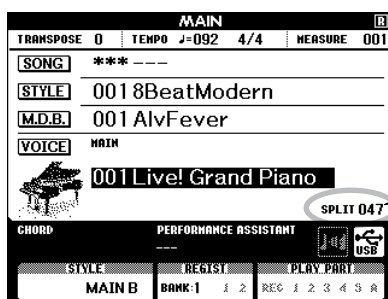
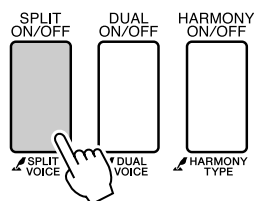

**SPLIT 047**

Voice Number

# 2 Press and hold the [SPLIT ON/OFF] button for longer than a second.

The split voice selection display will appear.

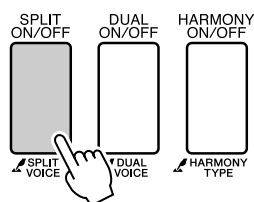

Hold for longer than a second

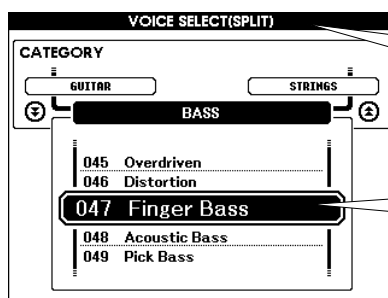

Split voice selection display

The currently selected split voice

### 3 Select the desired split voice.

Watch the highlighted split voice and rotate the dial until the voice you want to use is selected. The voice selected here becomes the split voice which will play to the left of the keyboard split point. For this example try selecting the “038 Folk Guitar” voice.

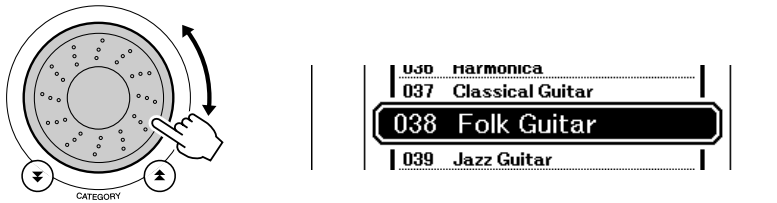

### 4 Play the keyboard.

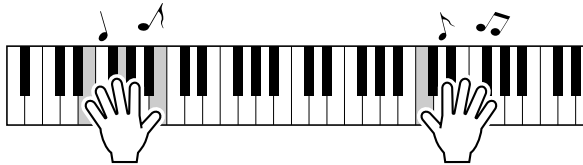

Try selecting and playing a range of split voices.

Press the [EXIT] button to return to the MAIN display.

## Play the Grand Piano Voice

When you just want to play piano, all you have to do is press one convenient button.

Press the [PORTABLE GRAND] button.

The “001 Grand Piano” voice will be selected.

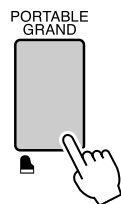

#### NOTE

- When you press the [PORTABLE GRAND] button all settings other than touch sensitivity are turned off. The dual and split voices will also be turned off, so only the Grand Piano voice will play over the entire keyboard.



# Fun Sounds

This instrument includes a range of drum kits and unique sound effects you can use for entertainment. Laughter, babbling brooks, jet fly-bys, eerie effects, and much more. These sounds can be a great way to enhance the mood at parties.

## Drum Kits

Drum kits are collections of drum and percussion instruments. When you select a violin or other normal instrument main voice, for example, all keys produce the sound of the same violin, only at different pitches. If you select a drum kit as the main voice, however, each key produces the sound of a different drum or percussion instrument.

### ◆ Drum Kit Selection Procedure → (refer to steps 1 and 2 on page 15)

- 1 Press the [VOICE] button.
- 2 Use the dial to select “128 Standard Kit 1”.
- 3 Try out each key and enjoy the drum and percussion sounds!

Try out each key and enjoy the drum and percussion sounds! Don't forget the black keys! You'll hear a triangle, maracas, bongos, drums ... a comprehensive variety of drum and percussion sounds. For details on the instruments included in the drum kit voices (voice numbers 128 to 139), see the “Drum Kit List” on page 128.

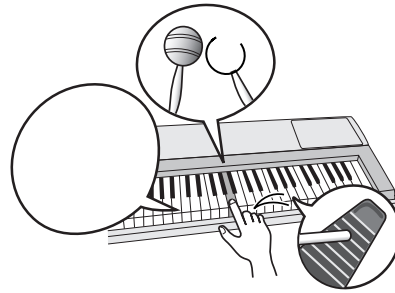

The sound effects are included in the drum kit voice group (voice numbers 138 and 139). When either of these voices are selected you will be able to play a range of sound effects on the keyboard.

### ◆ Sound Effect Selection Procedure → (refer to steps 1 and 2 on page 15)

- 1 Press the [VOICE] button.
- 2 Use the dial to select “139 SFX Kit 2”.
- 3 Try out each key and enjoy the sound effects!

As you try out the various keys you'll hear the sound of a submarine, a telephone bell, a creaking door, and many other useful effects. “138 SFX Kit 1” includes lightning, running water, dogs barking, and others. Some keys do not have assigned sound effects, and will therefore produce no sound.

For details on the instruments included in the SFX kit voices, see “SFX Kit 1” and “SFX Kit 2” in the “Drum Kit List” on page 129.





# The Metronome

The instrument includes a metronome with adjustable tempo and time signature. Play and set the tempo that is most comfortable for you.

## Start the Metronome

Turn the metronome on and start it by pressing the [METRONOME ON/OFF] button.

To stop the metronome, press the [METRONOME ON/OFF] button again.



MEASURE 1

Indicates the beat number in the measure

## Adjusting the Metronome Tempo

- 1 Press the [TEMPO/TAP] button to call up the tempo setting.

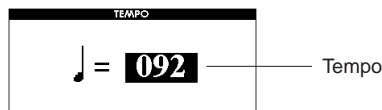
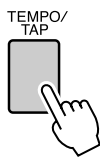

- 2 Use the dial to select a tempo from 11 to 280.

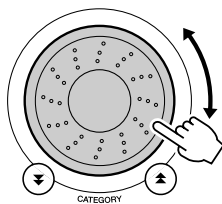

## Setting the Number of Beats per Measure, and the Length of Each Beat

In this example we'll set up a 5/8 time signature.

- 1 Press and hold the [METRONOME ON/OFF] button for longer than a second to select the function "Time Signature–Numerator".**

MET



- 2 Use the dial to select the number of beats per measure.**  
A chime will sound on the first beat of each measure while the other beats will click. All beats will simply click with no chime at the beginning of each measure if you set this parameter to "00".  
The available range is from 0 through 60. Select 5 for this example.
- 3 Press the CATEGORY [ ] and [ ] buttons as many times as necessary to select the beat length function "Time Signature–Denominator".**

- 4 Use the dial to select the beat length.**  
Select the required length for each beat: 2, 4, 8, or 16 (half note, quarter note, eighth note, or 16<sup>th</sup> note). Select 8 for this example.

## Adjusting the Metronome Volume

**1** Press the [FUNCTION] button.

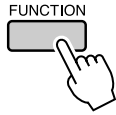

**2** Use the CATEGORY [▲] and [▼] buttons to select the Metronome Volume item.

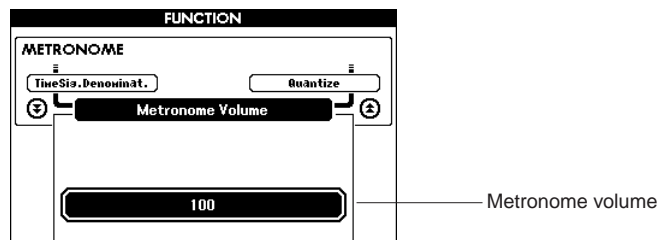
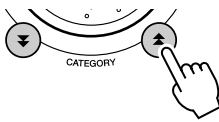

**3** Use the dial to set the metronome volume as required.



# Playing Styles

This instrument has an auto accompaniment feature that produces accompaniment (rhythm + bass + chords) in the style you choose to match chords you play with your left hand. You can select from 150 different styles covering a range of musical genres and time signatures (see page 130 for a complete list of the available styles). In this section we'll learn how to use the auto accompaniment features.

## Select a Style Rhythm

Most styles includes a rhythm part. You can select from a wide variety of rhythmic types—rock, blues, Euro trance, and many, many more. Let's begin by listening to just the basic rhythm. The rhythm part is played using percussion instruments only.

### 1 Press the [STYLE] button.

The style select display will appear. The currently selected style number and name will be highlighted.

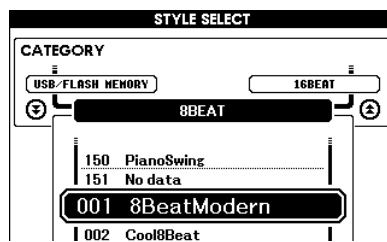
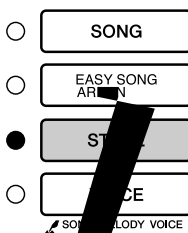

### 2 Select a style.

Use the dial to select the style you want to use. A list of all the available styles is provided on page 130.

second time when you want to stop

## Play Along with a Style

You learned how to select a style rhythm on the preceding page.

Here we'll see how to add bass and chord accompaniment to the basic rhythm to produce a full, rich accompaniment that you can play along with.

**1** Press the [STYLE] button and select the desired style.

**2** Turn automatic accompaniment on.

Press the [ACMP ON/OFF] button.

Pressing this button a second time will turn automatic accompaniment off.

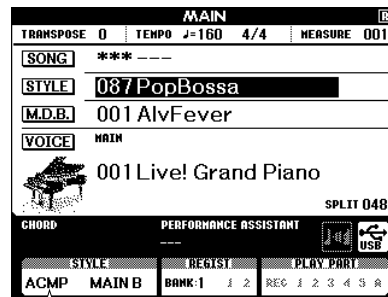
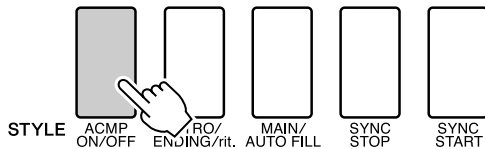

This icon appears when automatic accompaniment is on.

● **When automatic accompaniment is on ...**

The area of the keyboard to the left of the split point (54 : F#2) becomes the “auto accompaniment region” and is used only for specifying the accompaniment chords.

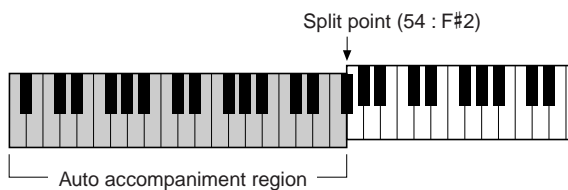

**NOTE**

- The keyboard split point can be changed as required; refer to page 77.

**3** Turn sync start on.

Press the [SYNC START] button to turn the sync start function on.

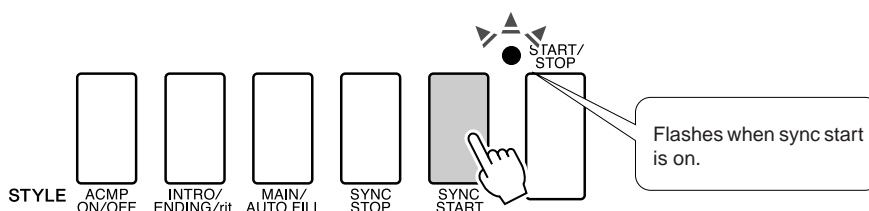



When sync start is on, the bass and chord accompaniment included in a style will start playing as soon as you play a note to left of the keyboard split point. Press the button a second time to turn the sync start function off.

## 4 Play a left-hand chord to start the style.

You can still “play” chords even if you don’t actually know any chords. This instrument will recognize even a single note as a chord. Try playing from one to three notes at the same time to the left of the split point. The accompaniment will change according to the left-hand notes you play.

### Try this!

Scores for some chord progressions are provided on page 26. These examples should help you get a feel for what types of chord progressions sound good with the styles.

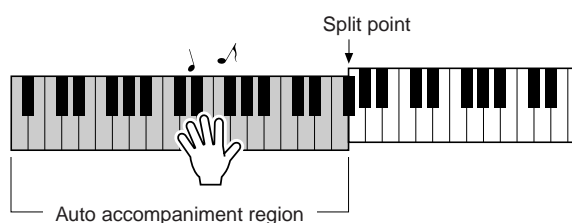

## 5 Play a variety of left-hand chords while playing a melody with your right hand.

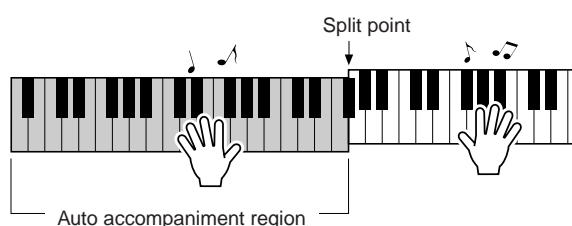

## 6 Press the [START/STOP] button to stop style playback when you’re done.

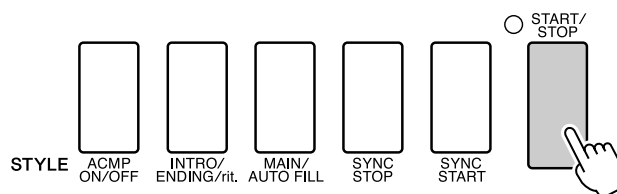

You can switch style “sections” to add variety to the accompaniment. Refer to “Pattern Variation (Sections)” on page 74.

## Styles Are More Fun When You Understand Chords

Chords, created by playing multiple notes at the same time, are the basis for harmonic accompaniment. In this section we'll take a look at sequences of different chords played one after another, or "chord sequences." Since each chord has its own unique "color"—even if it's different fingerings of the same chord—the chords you choose to use in your chord progressions have a huge influence on the overall feel of the music you play.

On page 24 you learned how to play colorful accompaniments using styles. Chord progressions are vital to creating interesting accompaniments, and with a little chord know-how you should be able to take your accompaniments to a new level.

On these pages we'll introduce three easy-to-use chord progressions. Be sure to try them out with the instrument's accompaniment styles. The style will respond to the chord progression you play, effectively creating a complete song.

### ■ Playing the Chord Progressions .....

Play the scores with the left hand.

Before playing the scores follow steps 1 through 3 of "Play Along with a Style" on page 24.

\* The scores provided here are not standard song scores, but rather simplified scores that indicate which notes to play to produce the chord progressions.

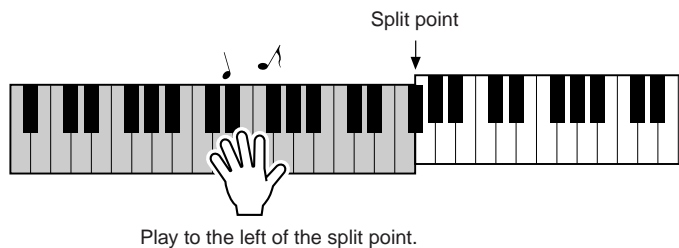

<b>Recommended Style</b>	<b>031 Euro Trance</b>
--------------------------	------------------------

—Dance music with simple chords—

Press the [INTRO/ENDING/rit.] button.

F	C	G	Am

This is a simple-but-effective chord progression. When you play through to the end of the score, start again from the beginning. When you're ready to stop playing press the [INTRO/ENDING/rit.] button and the auto accompaniment function will create a perfect ending.

**Recommended Style**      **138 Piano Boogie**

—3-chord boogie-woogie—

Press the [INTRO/ENDING/rit.] button.

Press the [INTRO/ENDING/rit.] button.

This progression provides varied harmonic backing with just three chords. When you get a feel for the progression in the score, try changing the order of the chords!

**Recommended Style**      **086 Bossa Nova**

—Bossa nova with jazz-style chords—

Press the [INTRO/ENDING/rit.] button.

Press the [INTRO/ENDING/rit.] button.

This progression includes jazzy “two-five” (II-V) changes. Try playing it through several times. When you’re ready to stop playing press the [INTRO/ENDING/rit.] button.

## Playing Auto-accompaniment Chords

There are two ways of playing auto-accompaniment chords:

- Easy Chords
- Standard Chords

The instrument will automatically recognize the different chord types. The function is called Multi Fingering.

Press the [ACMP ON/OFF] button to turn auto-accompaniment on (page 24). The keyboard to the left of the split point (default: 54/F#2) becomes the “accompaniment range”. Play the accompaniment chords in this area of the keyboard.

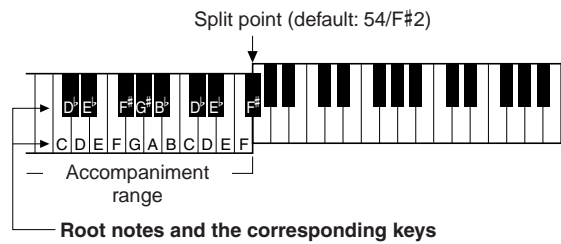

### ■ Easy Chords .....

This method lets you easily play chords in the accompaniment range of the keyboard using only one, two, or three fingers.

<p><b>C</b></p>	<p>• <b>To play a major chord</b> Press the root note of the chord.</p>
<p><b>C<sub>m</sub></b></p>	<p>• <b>To play a minor chord</b> Press the root note together with the nearest black key to the left of it.</p>
<p><b>C<sub>7</sub></b></p>	<p>• <b>To play a seventh chord</b> Press the root note together with the nearest white key to the left of it.</p>
<p><b>C<sub>m7</sub></b></p>	<p>• <b>To play a minor seventh chord</b> Press the root note together with the nearest white and black keys to the left of it (three keys altogether).</p>

### ■ Standard Chords .....

This method lets you produce accompaniment by playing chords using normal fingerings in the accompaniment range of the keyboard.

● **How to play Standard Chords [Example for “C” chords]**

<b>C</b>	<b>C<sup>(9)</sup></b>	<b>C<sub>6</sub></b>	<b>C<sub>6</sub><sup>(9)</sup></b>
<b>C<sub>M7</sub></b>	<b>C<sub>M7</sub><sup>(9)</sup></b>	<b>C<sub>M7</sub><sup>(#11)</sup></b>	<b>C<sup>(-5)</sup></b>
<b>C<sub>M7</sub><sup>(-5)</sup></b>	<b>C<sub>sus4</sub></b>	<b>C<sub>aug</sub></b>	<b>C<sub>M7aug</sub></b>
<b>C<sub>m</sub></b>	<b>C<sub>m</sub><sup>(9)</sup></b>	<b>C<sub>m6</sub></b>	<b>C<sub>m7</sub></b>
<b>C<sub>m7</sub><sup>(9)</sup></b>	<b>C<sub>m7</sub><sup>(11)</sup></b>	<b>C<sub>mM7</sub></b>	<b>C<sub>mM7</sub><sup>(9)</sup></b>
<b>C<sub>m7</sub><sup>(-5)</sup></b>	<b>C<sub>mM7</sub><sup>(-5)</sup></b>	<b>C<sub>dim</sub></b>	<b>C<sub>dim7</sub></b>
<b>C<sub>7</sub></b>	<b>C<sub>7</sub><sup>(-9)</sup></b>	<b>C<sub>7</sub><sup>(-13)</sup></b>	<b>C<sub>7</sub><sup>(9)</sup></b>
<b>C<sub>7</sub><sup>(#11)</sup></b>	<b>C<sub>7</sub><sup>(13)</sup></b>	<b>C<sub>7</sub><sup>(#9)</sup></b>	<b>C<sub>7</sub><sup>(-5)</sup></b>
<b>C<sub>7aug</sub></b>	<b>C<sub>7sus4</sub></b>	<b>C<sub>sus2</sub></b>	

\* Notes enclosed in parentheses (Ⓜ) are optional; the chords will be recognized without them.

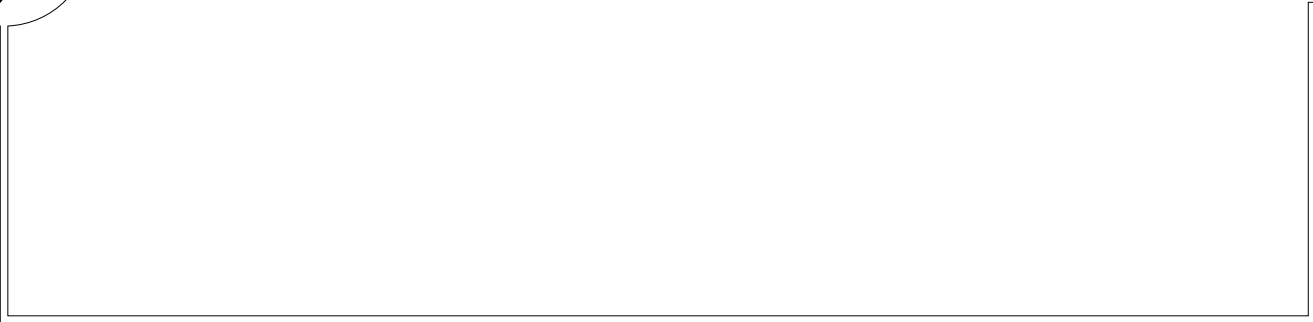

001–030	Built in Songs (see next page)
031–035	User Songs (Songs you record yourself).
036–	Songs transferred from a computer (pages 102–104) or Songs in a USB flash memory connected to the instrument (page 91)

### 3 Listen to the song.

Press the [START/STOP] button to begin playback of the selected song. You can stop playback at any time by pressing the [START/STOP] button again.

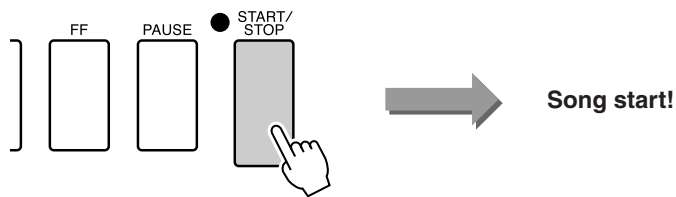

## Song Fast Forward, Fast Reverse, and Pause

These are just like the transport controls on a cassette deck or CD player, letting you fast forward [FF], rewind [REW] and pause [PAUSE] playback of the song.

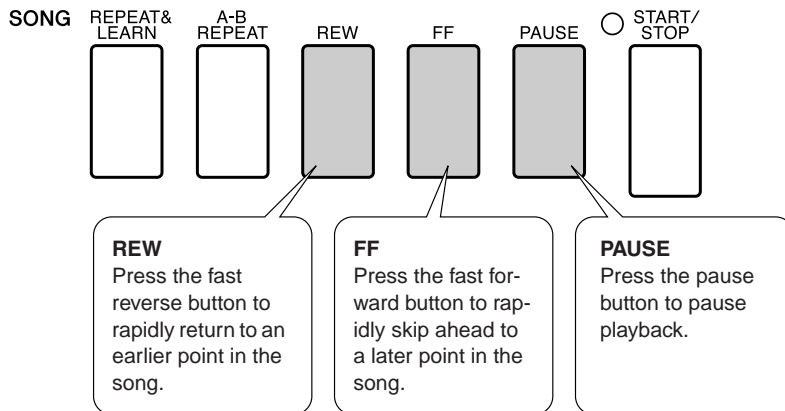

**NOTE**

- When an A-B repeat range is specified the fast reverse and forward function will only work within that range.

## ● Song List

These 30 songs include songs that effectively demonstrate the instrument's Easy Song Arranger feature, songs that are ideally suited for use with the performance assistant technology feature, and more. The "Suggested Uses" column provides some ideas as to how the songs can most effectively be used.

Category	No.	Name	Suggested Uses
Main Demo	1 <b>CHORD</b>	Magnetic	The songs in this category have been created to give you an idea of the advanced capabilities of this instrument. They're great for listening, or for use with the various features.
	2 <b>CHORD</b>	Jessica	
	3 <b>CHORD</b>	Winter Serenade	
Voice Demo	4 <b>CHORD</b>	Live! Grand Demo	These songs features some of the instrument's many useful voices. They make maximum use of the characteristics of each voice, and might serve as inspiration for your own compositions.
	5 <b>CHORD</b>	Live! Orchestra Demo	
	6 <b>CHORD</b>	Cool! RotorOrgan Demo	
	7 <b>CHORD</b>	Cool! Galaxy Electric Piano Demo	
Function Demo	8 <b>CHORD</b>	ModernHarp & Sweet Soprano Demo	Use these songs to experience some of the instrument's advanced features: song number 9 for the easy song arranger, and songs 10 and 11 for the performance assistant technology feature.
	9 <b>CHORD</b>	Hallelujah Chorus	
	10 <b>CHORD</b>	Ave Maria	
Piano Solo	11 <b>CHORD</b>	Nocturne op.9-2	These piano solo pieces are ideally suited for use as lesson songs.
	12	For Elise	
	13	Maple Leaf Rag	
Piano Ensemble	14	Jeanie with the Light Brown Hair	A selection of piano ensemble songs that are also well suited for use as lesson songs.
	15 <b>CHORD</b>	Amazing Grace	
	16 <b>CHORD</b>	Mona Lisa (Jay Livingston and Ray Evans)	
	17	Piano Concerto No.21 2nd mov.	
	18 <b>CHORD</b>	Scarborough Fair	
Piano Accompaniment	19 <b>CHORD</b>	Old Folks at Home	When you need to practice backing (accompaniment) patterns, these are the songs to do it with. This is ability you'll need if you're invited to play with a band. These songs allow you to practice backing parts one hand at a time, which can be the easiest way to master this important skill.
	20 <b>CHORD</b>	Ac Ballad (Against All Odds: Collins 0007403)	
	21 <b>CHORD</b>	Ep Ballad	
	22 <b>CHORD</b>	Boogie Woogie	
	23 <b>CHORD</b>	Rock Piano	
	24 <b>CHORD</b>	Salsa	
	25 <b>CHORD</b>	Country Piano	
	26 <b>CHORD</b>	Gospel R&B	
	27 <b>CHORD</b>	Medium Swing	
	28 <b>CHORD</b>	Jazz Waltz	
29 <b>CHORD</b>	Medium Bossa		
	30 <b>CHORD</b>	SlowRock (Can't Help Falling In Love: George David Weiss, Hugo Peretti and Luigi Creatore)	

**CHORD** : Includes chord data.

The scores for the internal songs—except for songs 1–11, and song 16, 20 and 30 which is copyrighted, are provided in the Song Book on the CD-ROM. The scores for songs 9–11 are provided in this manual.

Some of the classic and/or traditional songs have been edited for length or for ease in learning, and may not be exactly the same as the original.

## Types of Songs

The following three types of songs can be used by the DGX-620/520, YPG-625/525.

- **Preset Songs (the 30 songs built into the instrument)..... Song numbers 001–030.**
- **User Songs (recordings of your own performances) ..... Song numbers 031–035.**
- **External song files (song data transferred from a computer\*) ... Song numbers 036–.**

\* The Accessory CD-ROM includes a selection of 70 MIDI songs. See page 103 for instructions on how to transfer the songs to the instrument.

The chart below shows the basic processes flow for using the preset songs, user songs, and external song files from storage to playback.

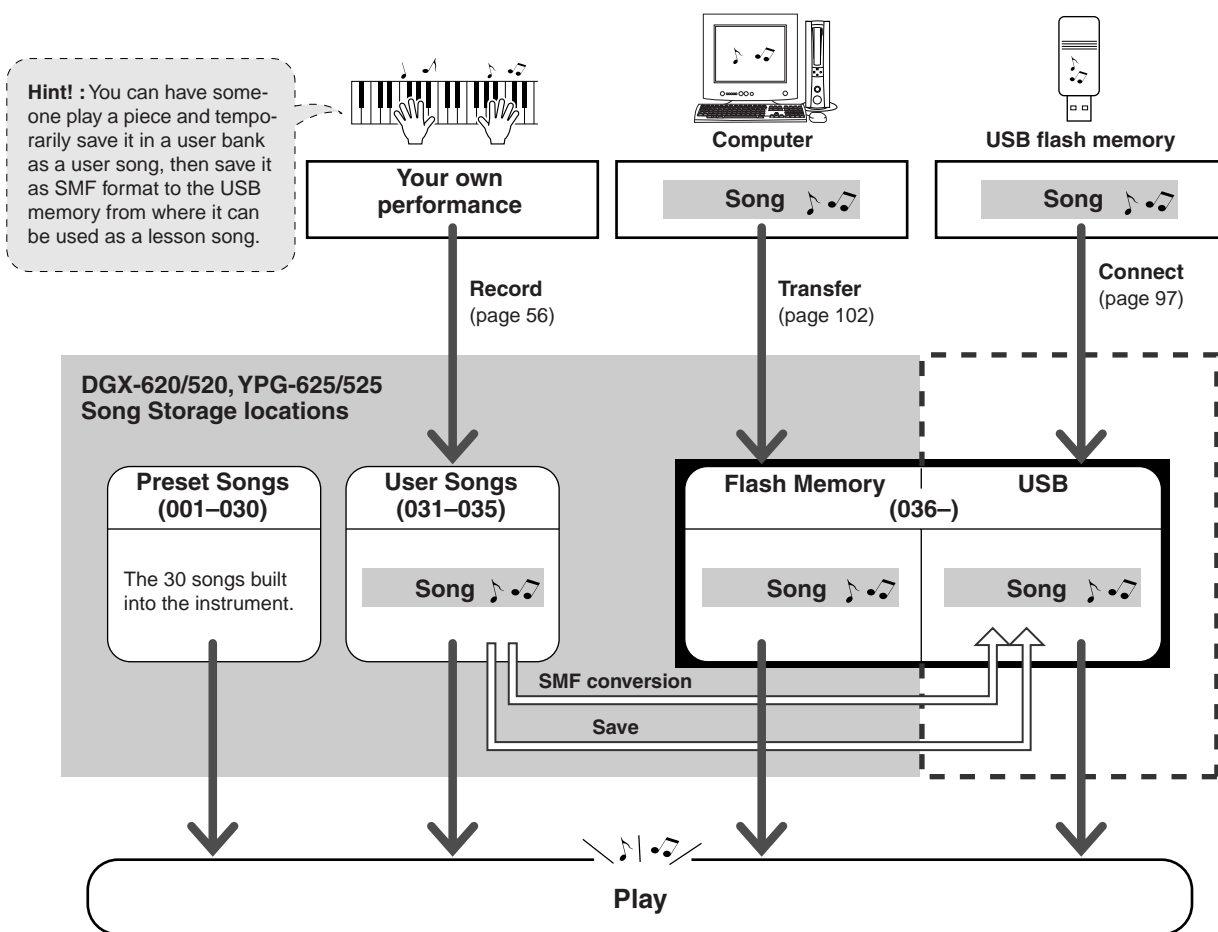

**NOTE**

- User songs cannot produce score display as they are. If you convert a user song file to SMF and save it to USB flash memory, however, it becomes capable of producing score display and can be used with the lesson features.

**NOTE**

- Different flash memory areas are used to store user songs and external song files transferred from a computer. User songs cannot be directly transferred to the external song file flash memory area, and vice versa.



## Displaying the Song Score

This instrument is capable of displaying the scores of songs.

Scores are displayed for the 30 internal preset songs as well as songs stored in USB flash memory or flash memory.

And although user songs you record yourself cannot display a score as is, they can be converted to SMF (Standard MIDI File) format and stored to USB flash memory, from where they can be played with score display.

### 1 Select a song.

Follow steps 1 and 2 of the procedure described on page 29.

### 2 Press the [SCORE] button and a single-staff score will appear.

There are two types of score display: single-staff and double-staff.

These are alternately selected each time the [SCORE] button is pressed.

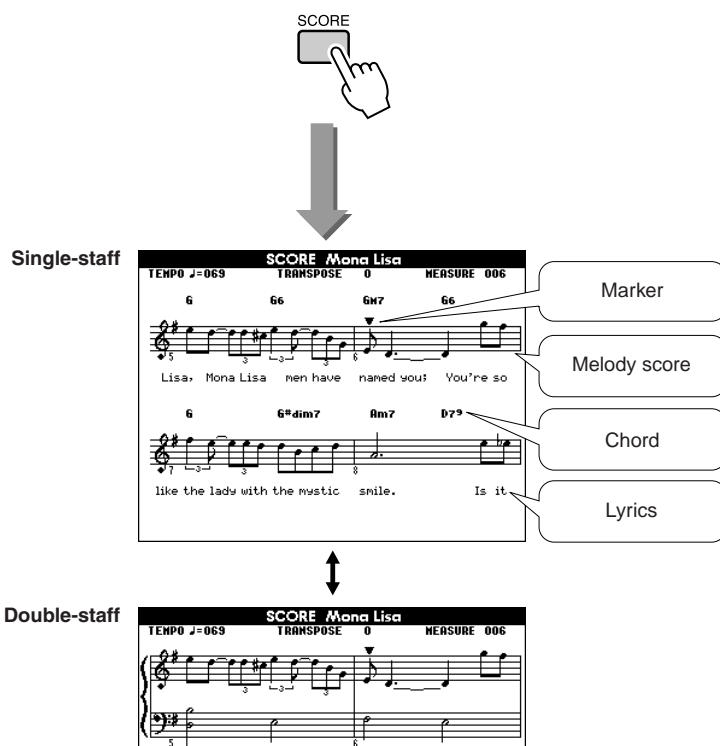

#### NOTE

- Both chords and lyrics will be shown in single-staff score display of a song that includes chord and lyric data.
- When there are many lyrics they may be displayed in two rows a measure.
- Some lyrics or chords may be abbreviated if the selected song has a lot of lyrics.
- Small notes that are hard to read may be easier to read after you use the quantize function (page 89).

#### NOTE

- No lyrics are shown in double-staff.

### 3 Press the [START/STOP] button.

The song will begin playing. The triangular will move across the top of the score to indicate the current location.

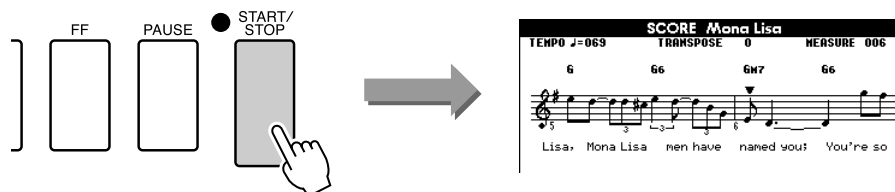

### 4 Press the [EXIT] button to return to the MAIN display.

## Display the Lyrics

If a song contains lyric data, the lyrics can be made to appear on the display. No lyrics will be displayed for a song that contains no lyric data even if the [LYRICS] button is pressed.

### 1 Select a song.

Select a song between 16, 20, and 30 by performing steps 1 and 2 described on page 29.

### 2 Press the [LYRICS] button.

The title, lyricist, and composer of the song will appear on the display.

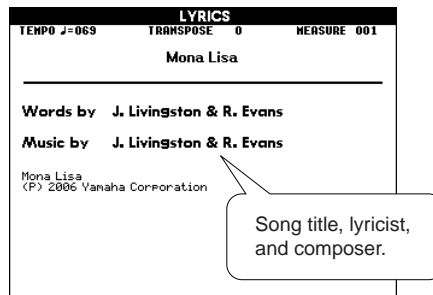

**NOTE**

- Songs downloaded from the Internet or commercially available song files, including XF format files (page 6), are compatible with the lyrics display features as long as they are standard MIDI file format files containing lyric data. Lyrics display may not be possible with some files.

**NOTE**

- If the lyrics display shows garbled characters, try changing the display language (page 14).

### 3 Press the [START/STOP] button.

The song will play back while the lyrics and chords are shown on the display. The lyrics will be highlighted to show the current location in the song.

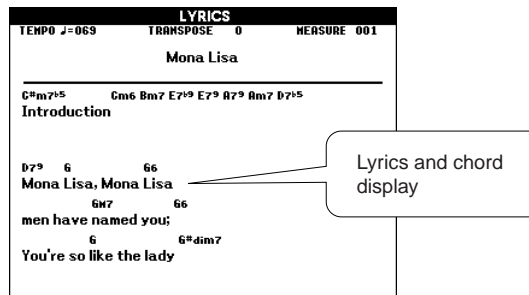
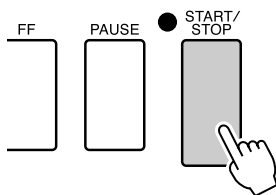

### ■ Preset Songs That Can be Used For Lyrics Display

Number	Name
016	Mona Lisa (Jay Livingston and Ray Evans)
020	Against all odds (Collins 0007403)
030	Can't Help Falling In Love (George David Weiss, Hugo Peretti and Luigi Creatore)



# The Easy Way to Play Piano

This instrument includes a performance assistant technology feature that lets you play along with a song and sound like a great pianist (even though you might be making lots of mistakes)! In fact, you can play any notes and still sound good! You could even just tap one key and the results would be a beautiful melody. So even if you can't play piano and can't read a note of music, you can have some musical fun.

Performance assistant technology offers four selectable types. Select the type that produces the best results for you.

- **Chord** ..... No matter where or what you play, the result will be musical, well-balanced sound. This type offers the greatest freedom, allowing you to play anything with both your left and right hands.

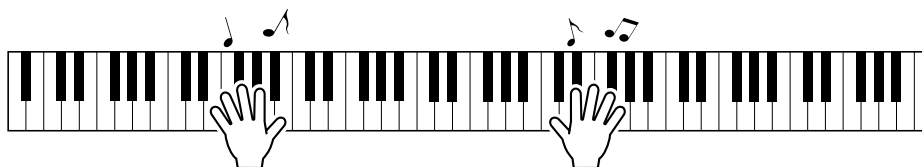

- **Chord/Free** ..... If you can play simple right-hand melodies but have trouble with left-hand chords, this is the type for you. The Chord type applies to only the left-hand section of the keyboard, allowing you to easily play chords to support the melody you are playing with your right hand.

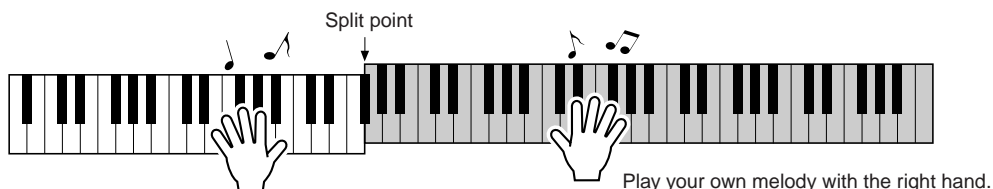

- **Melody** ..... This type lets you play the melody of the selected song by playing any keys with just one finger. Start playing melodies right away, even if you've never played a keyboard instrument before!

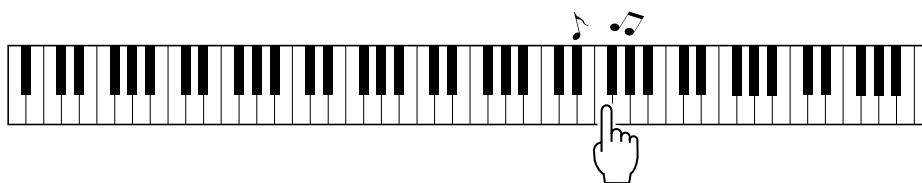

- **Chord/Melody** .... Play the melody of the selected song with one finger on the right-hand section of the keyboard, and play chords on the left-hand section of the keyboard using the Chord type.

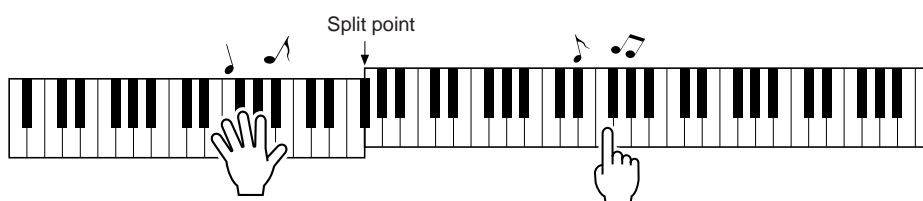

Refer to page 44 for more information on using performance assistant technology to help you play.

## CHORD Type—Play with Both Hands

### 1 Press the [P.A.T. ON/OFF] button.

This turns on the performance assistant technology feature. The indicator lights when the performance assistant technology feature is on.

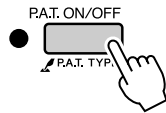

### 2 Select the CHORD type.

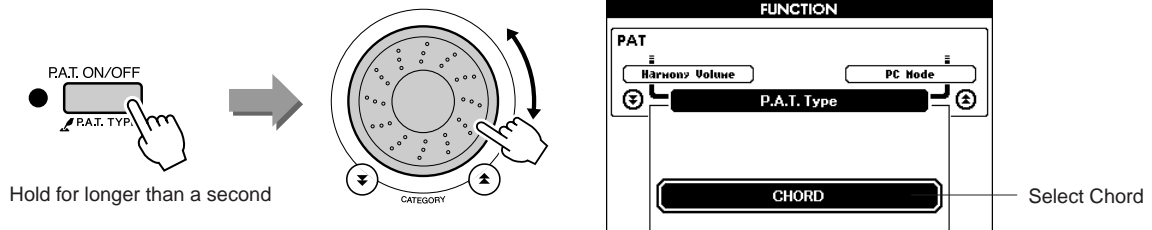

Press and hold the [P.A.T. ON/OFF] button for longer than a second so that the performance assistant technology type appears. Select the Chord type by using the dial.

### 3 Select a song.

Press the [SONG] button, and the Song Select display appears. Select a song by using the dial. For this example try selecting the “010 Ave Maria”.

**NOTE**  
• Using Songs (page 29)

When the Chord type is selected, features only available for this song can be seen in the display!

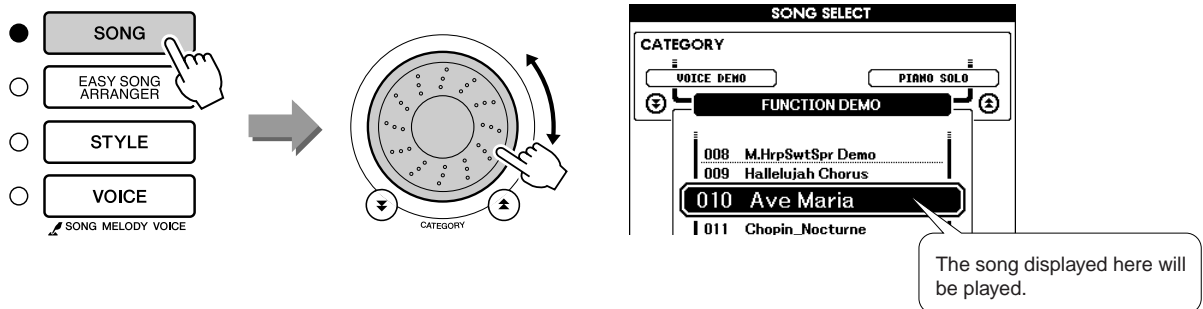

#### ● What is a Song?

You know the normal meaning of this word, but in this instrument the term “Song” refers to the data that makes up a complete song. The performance assistant technology features uses the chord and melody data, and should always be used with a song (page 29).

## 4 Press the [START/STOP] button.

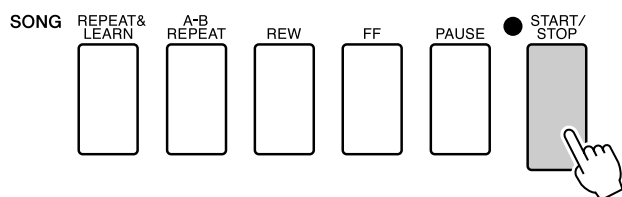

Song playback will begin.

The basic pattern will play repeatedly. Listen to the basic pattern for four measures while getting a feel for the basic pattern, then begin playing yourself from the fifth measure. The keys you should play will be shown in the display.

## 5 Play on the keyboard.

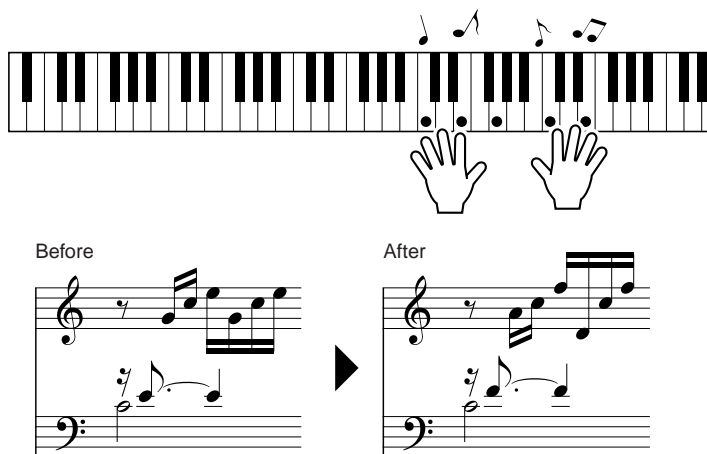

Try playing the score on the left with both hands. You can even play the same keys over and over: C, E, G, C, E, G, C, E. You'll notice that at measure five the notes will come out according to the score on the right. Keep playing, and performance assistant technology Chord type will continue to "correct" the notes that you play. This is the performance assistant technology Chord type.

You can stop song playback at any time by pressing the [START/STOP] button.

## 6 Press the [P.A.T. ON/OFF] button to turn the performance assistant technology feature off.

### NOTE

- The score for Ave Maria is provided on page 120.

## CHORD/FREE Type—Applying the Chord Type to the Left Hand Only

### 1 Press the [P.A.T. ON/OFF] button.

This turns on the performance assistant technology feature. The indicator lights when the performance assistant technology feature is on.

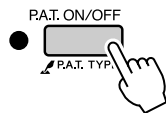

### 2 Select the CHORD/FREE type.

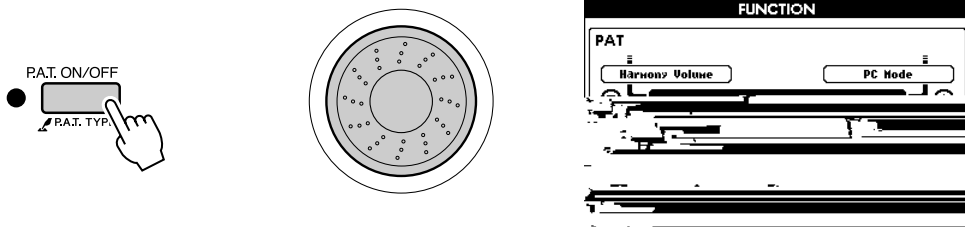

Press and hold the [P.A.T. ON/OFF] button for longer than a second so that the performance assistant technology type appears. Select the Chord/Free type by using the dial.

### 3 Select a song.

Press the [SONG] button, and the Song Select display appears. Select a song by using the dial. For this example try selecting the “011 Nocturne”.

## 4 Press the [START/STOP] button.

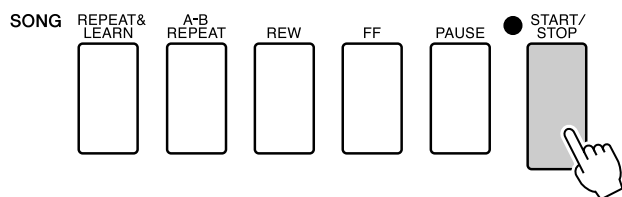

Song playback will begin.  
The left-hand keys you should play will be shown on the display.

## 5 Play on the keyboard.

Play to the right of the split point with your right hand, and to the left of the split point with your left hand.

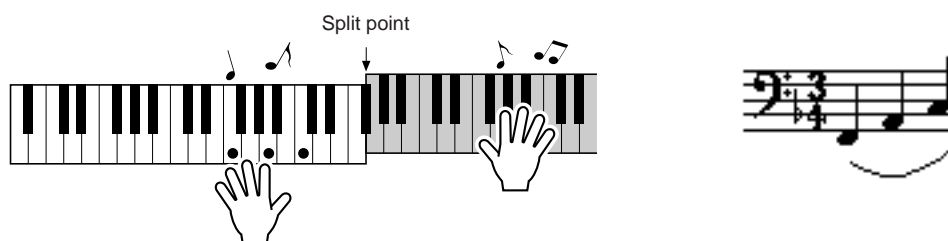

With this type notes played on the left-hand side of the split point will actually sound an octave higher.

Play the Nocturne melody with your right hand. Continually play an F-A-C arpeggio with your left hand as indicated by the score shown in the display. Although you're repeatedly playing the same notes with your left hand, the actual notes produced will change to match the music. This is the performance assistant technology Chord/Free type.

### NOTE

- The score for Nocturne is provided on page 122.

Press the [SCORE] button if you want to see the score for the right-hand part in the display.  
You can stop song playback at any time by pressing the [START/STOP] button.

## 6 Press the [P.A.T. ON/OFF] button to turn the performance assistant technology feature off.

## MELODY Type—Play with One Finger

See page 44 for some hints on how to play melodies.

### 1 Press the [P.A.T. ON/OFF] button.

This turns on the performance assistant technology feature. The indicator lights when the performance assistant technology feature is on.

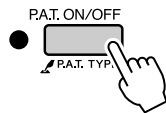

### 2 Select the MELODY type.

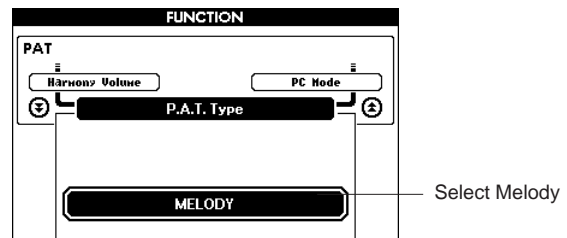
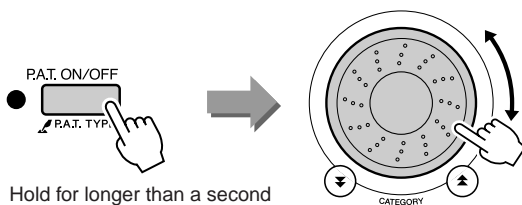

Press and hold the [P.A.T. ON/OFF] button for longer than a second so that the performance assistant technology type appears. Select the Melody type by using the dial.

### 3 Select a song.

Press the [SONG] button, and the Song Select display appears. Select a song by using the dial.

**NOTE**

• Using Songs (page 29)

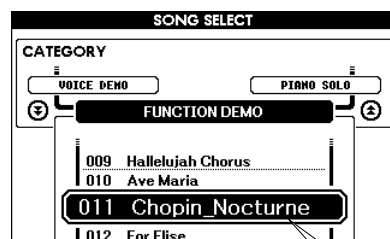
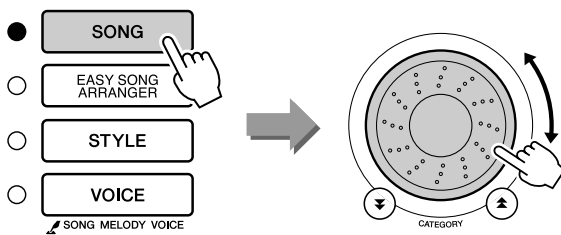

The song displayed here will be played.



## 4 Press the [START/STOP] button.

Song playback will begin.

Because the Melody type has been selected, the song melody will not sound. You can enjoy playing the melody yourself (step 5).

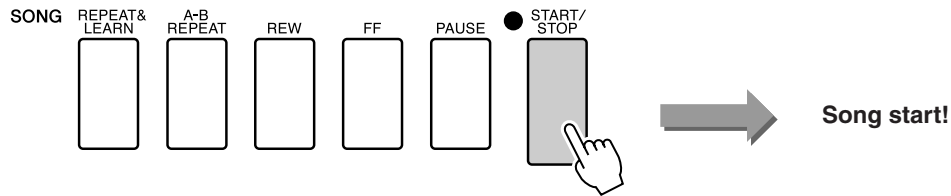

## 5 Play on the keyboard.

To begin, try to feel the rhythm of the song. Then tap a key with one finger of your right hand in time with the music. You can play any key. If you want to play the melody with the melody score, press the [SCORE] button to call up the melody score in the display.

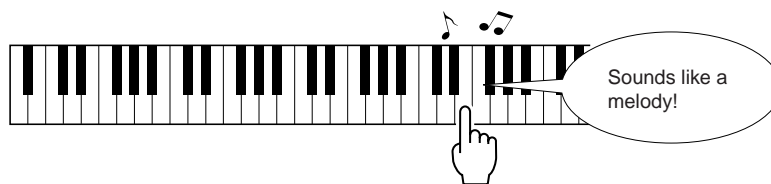

How does it sound? You've played the melody using only one finger thanks to the performance assistant technology Melody type!

You can stop song playback at any time by pressing the [START/STOP] button.

## 6 Press the [P.A.T. ON/OFF] button to turn the performance assistant technology feature off.

# CHORD/MELODY—Chord Type with the Left Hand, Melody with the Right

## 1 Press the [P.A.T. ON/OFF] button.

This turns on the performance assistant technology feature. The indicator lights when the performance assistant technology feature is on.

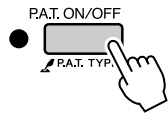

## 2 Select the CHORD/MELODY type.

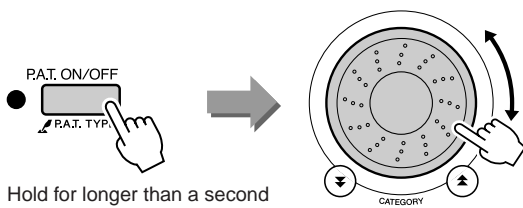

Hold for longer than a second

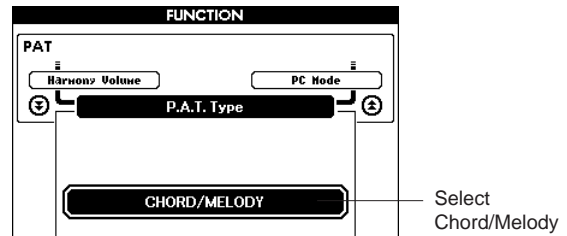

Press and hold the [P.A.T. ON/OFF] button for longer than a second so that the performance assistant technology type appears. Select the Chord/Melody type by using the dial.

## 3 Select a song.

Press the [SONG] button, and the Song Select display appears. Select a song by using the dial.

**NOTE**  
• Using Songs (page 29)

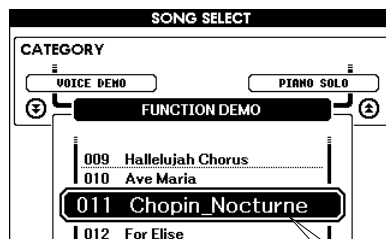
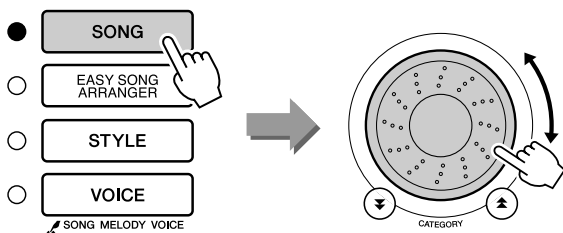

The song displayed here will be played.

## 4 Press the [START/STOP] button.

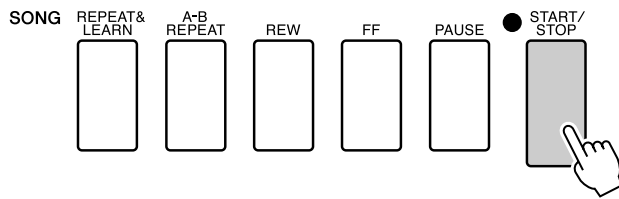

Song playback will begin.

The basic pattern will repeat. Listen to eight measures while memorizing the basic pattern. It's your turn to play the part from the ninth measure.

## 5 Play on the keyboard.

Play to the right of the split point with your right hand, and to the left of the split point with your left hand.

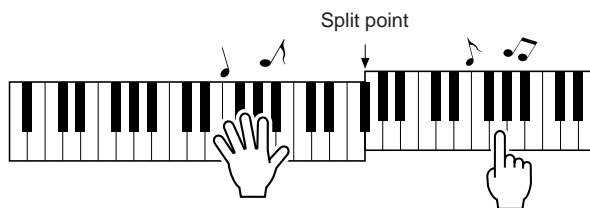

With this type notes played on the left-hand side of the split point will actually sound an octave higher.

Play along with the rhythm of the song melody with your right hand. You can play any keys as long as you're playing to the right of the split point. At the same time play accompaniment-like chords and phrases with your left hand. No matter what you play, you'll produce the song melody with your right hand and beautiful chords and phrases with your left hand.

This is the performance assistant technology Chord/Melody type.

If you want to play the melody with the melody score, press the [SCORE] button to call up the melody score in the display.

You can stop song playback at any time by pressing the [START/STOP] button.

## 6 Press the [P.A.T. ON/OFF] button to turn the performance assistant technology feature off.

## Use the Performance Assistant to Play Like a Pro!

Here are a few hints for using the Chord type.

If you select Chord/Free or Chord/Melody, the left-hand section of the keyboard becomes the Chord type section, so use these hints on the left-hand section of the keyboard.

To begin, try to feel the rhythm of the song. Then, with your hands spread as shown in the illustration, simply play the keyboard alternately with your left and right hands (any notes will do).

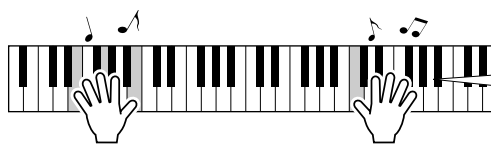

Sounds like you're playing the right notes!

**CHORD**  
**Am7**

The chord information included in the song is displayed in the lower area of the MAIN display. You will get even better results if you match your left-hand rhythm to rhythm of the chord indicator in the display.

How does it sound? You'll get acceptable results no matter where you play thanks to the performance assistant technology Chord type!

Next try the three playing methods illustrated below. Different ways of playing produce different results.

- Play with the left and right hands at the same timing—type 1.

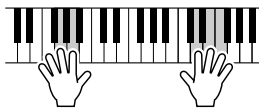

Play 3 notes at once with your right hand.

- Play with the left and right hands at the same timing—type 2.

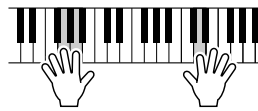

Play 1 note at a time with your right hand (for example: index finger → middle finger → ring finger).

- Play alternately with the left and right hands—type 3.

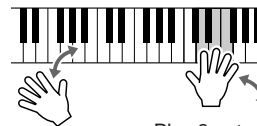

Play 3 notes at once with your right hand.

Once you get a feel for it, try playing chords with your left hand and a melody with your right ... or any other combination.

## Make Use of the Score in the Melody Type.

If you want to play the melody with the correct rhythm, use the onscreen score feature.

### Displaying the Score.

After performing steps 1 to 4 on page 40, press the [SCORE] button. The melody score will appear.

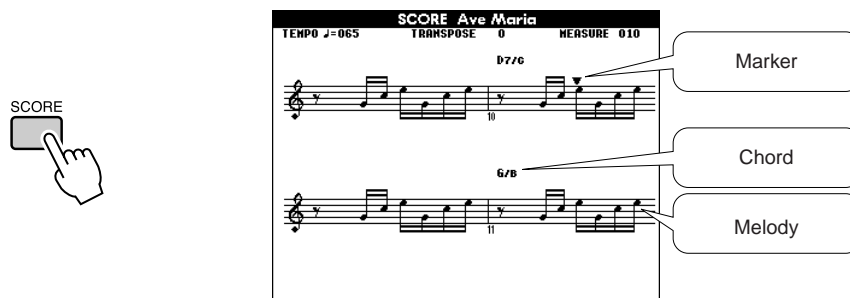

The marker will indicate the current position in the score during playback. If you play a key each time the marker appears above a note in the score you will be able to play the melody with the correct “original” rhythm.

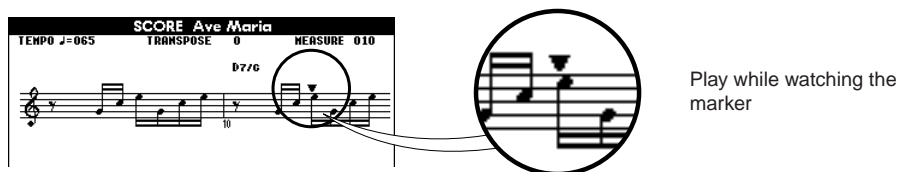

### ● Songs That Can Be Used With the performance assistant technology.

When the Chord type is selected the performance assistant technology can only be used with songs that include chord data. When the Melody type is selected the performance assistant technology will only work with songs that include melody data. In order to find out if a song includes the required data, first select the song and then press the [SCORE] button. If chords appear on the display when you press the [SCORE] button you can use the Chord type or any combination type that includes the Chord type. If melody appear on the display when you press the [SCORE] button you can use the Melody type or any combination type that includes the Melody type.

### ● External Songs and the performance assistant technology.

Songs downloaded from the Internet can also be used with the performance assistant technology as long as they include the required chord and/or melody data. See page 103 for instructions on how to transfer the songs to the instrument.

## Change the Song Tempo

When using the performance assistant technology or in other situations in which the tempo of the song is too fast or too slow for you, you can change the tempo as required. Press the [TEMPO/TAP] button. The tempo display will appear and you can use the dial, the [+] and [-] buttons, or the [0] to [9] number buttons to set to tempo to anywhere from 011 and 280 quarter-note beats per minute.



You can return to the original tempo by simultaneously pressing the [+] and [-] buttons. Press the [EXIT] button to return to the MAIN display.

## Play the Demo Song

You can use the performance assistant technology Chord type with the demo song (other types cannot be used).

### 1 Press the [DEMO] button.

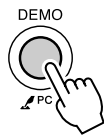

The demo display that introduces some of the instrument's features will appear, and the demo song will start playing. Listen to some of the outstanding instrument voices provided!

### 2 Try playing the keyboard.

The following display will appear after the demo song has been playing for a while.

This indicates that the performance assistant technology feature is now ON, and you can start playing along on the keyboard.

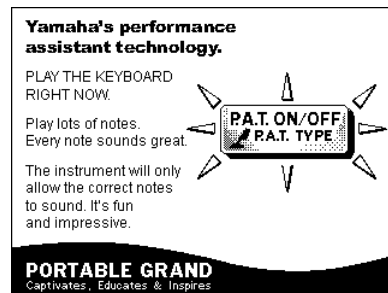
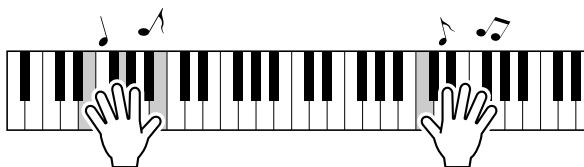

After a little while, the performance assistant technology feature will automatically be OFF, which is indicated on the display.

The demo song will automatically repeat from the beginning after it has played all the way through.

You can stop demo playback at any time by pressing the [START/STOP] button.



# Select a Song For a Lesson

## Yamaha Education Suite

You can select song you like and use it for a left-hand, right-hand, or both-hands lesson. You can also use songs (only SMF format 0) downloaded from the Internet and saved to flash memory. (page 102) During the lesson you can play as slowly as you like, and you can even play wrong notes. Song playback will slow down to a speed you can handle. It's never too late to start learning!

### Lesson Flow:

Select a song from the Piano Solo, Piano Ensemble category!

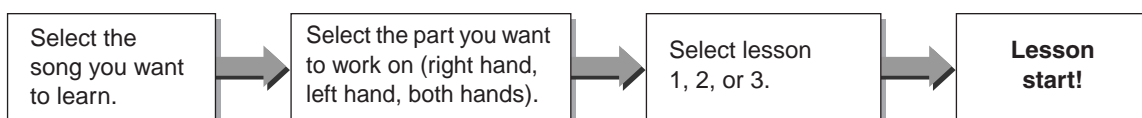

### The practice methods:

- **Lesson 1** ..... Learn to play the correct notes.
- **Lesson 2** ..... Learn to play the correct notes with the correct timing.
- **Lesson 3** ..... Learn to play the correct notes at the correct timing along with the song.

## Lesson 1—Waiting

In this lesson, try playing the correct notes. Play the note shown in the display. The song will wait until you play the right note.

### 1 Select a song for your lesson.

Press the [SONG] button, and rotate the dial to select the song you want to use for your lesson. As listed on page 31 there are a variety of song types.

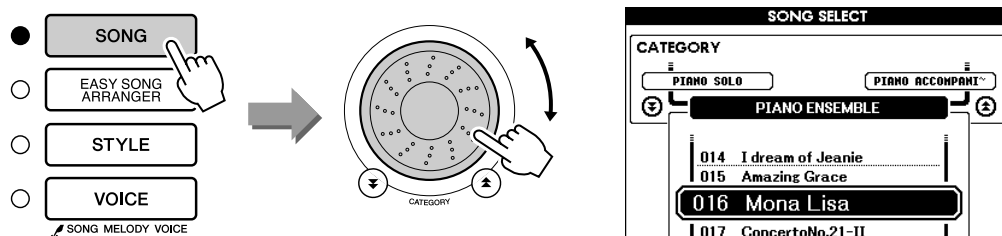

### 2 Press [EXIT] button to return to the MAIN display.

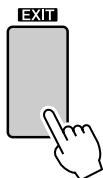

### 3 Select the part you want to practice.

Press the [R] button for a right-hand lesson, [L] button for a left-hand lesson, or press both the [R] and [L] buttons simultaneously for a both-hands lesson. The currently selected part is shown in the upper right corner of the display.

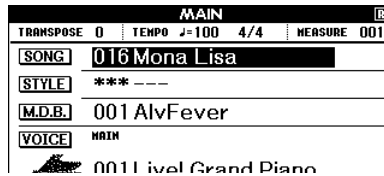
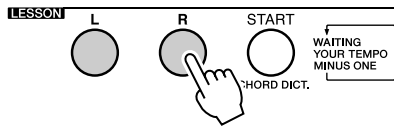

Select R for right-hand lesson.  
Select L for left-hand lesson.  
Select LR for bothhands lesson.

### 4 Start Lesson 1.

Press the LESSON [START] button to select Lesson 1. Each time the LESSON [START] button is pressed the lesson modes are selected in sequence: Lesson 1 → Lesson 2 → Lesson 3 → Off → Lesson 1 ... An explanation of the selected lesson will appear on the display for a few seconds before the lesson begins.

**NOTE**

- If the score display is not ready by the time the explanation display disappears, prepare-in-progress message will appear on the display until the score is ready.

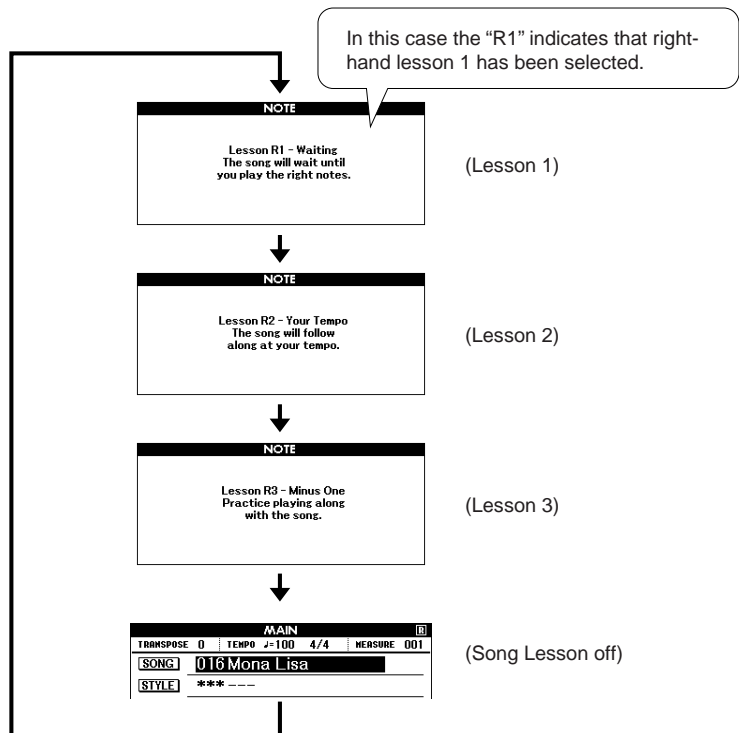
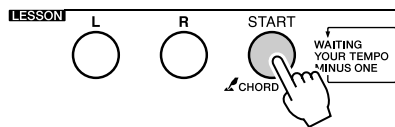

**Song playback will begin automatically when you select Lesson 1.**



Play the notes shown in the on-screen score. The next note to be played is indicated by a dot (●) on the appropriate key of the graphic on-screen keyboard. When you play the correct note the marker will move to the next key to be played. Playback will pause and wait for you to play the correct note. The triangular marker (▼) above the score indicates playback progress.

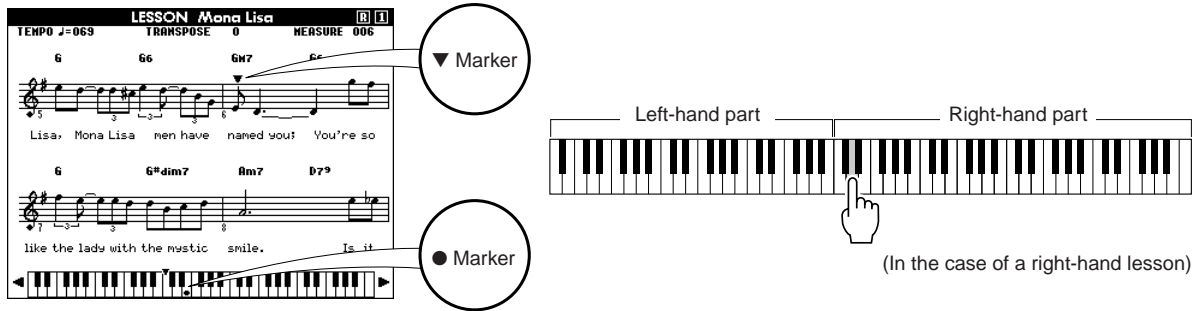

● **Shifting the keyboard left or right.**

The hidden ( ) areas of the keyboard can be brought into view by pressing the [+] or [-] button.



61 keys of the keyboard's range are shown on the display. The DGX-620/520 and YPG-625/525 actually have 88 keys. In some songs that include very high or low notes, those notes may fall outside the displayed range and may not be shown on the display. In such cases an "over" indicator appear to the left or right of the graphic keyboard. Use the [+] or [-] button to shift the keyboard left or right so you can see the notes (the ● marker will appear on the appropriate key in the display). Notes that actually fall outside the keyboard's range cannot be used in the lesson.

# 5 Stop the Lesson mode

You can stop the Lesson mode at any time by pressing the [START/STOP] button.

Once you've mastered Lesson 1, move on to Lesson 2.

## ■ See How You've Done .....



When the lesson song has played all the way through your performance will be evaluated in 4 levels: OK, Good, Very Good, or Excellent. "Excellent!" is the highest evaluation.

After the evaluation display has appeared, the lesson will start again from the beginning.

**NOTE**

- The evaluation feature can be turned off via the FUNCTION Grade item (page 89).

## Lesson 2—You

...ay the corre  
...aying at. The

...select the s  
...on page 4

### Start Less

Each time  
selected in  
son 1 ...

### Son sele

The  
inc  
tin  
w  
t

## Lesson 3—Minus One

Here's where you can perfect your technique. The song will play at the normal tempo, minus the part you have chosen to play. Play along while listening to the song.

**1** Select the song and part you want to practice (steps 1 and 3 on page 47).

**2** Start Lesson 3.

Each time the LESSON [START] button is pressed the lesson modes are selected in sequence: Lesson 1 → Lesson 2 → Lesson 3 → Off → Lesson 1 ...

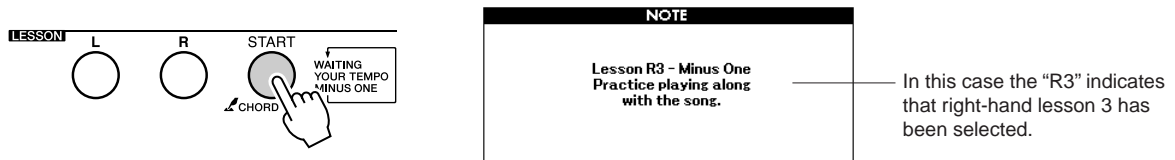

**Song playback will begin automatically when Lesson 3 is selected.**

Play along while listening to the song. The score marker and keyboard marker in the display will indicate the notes to play.

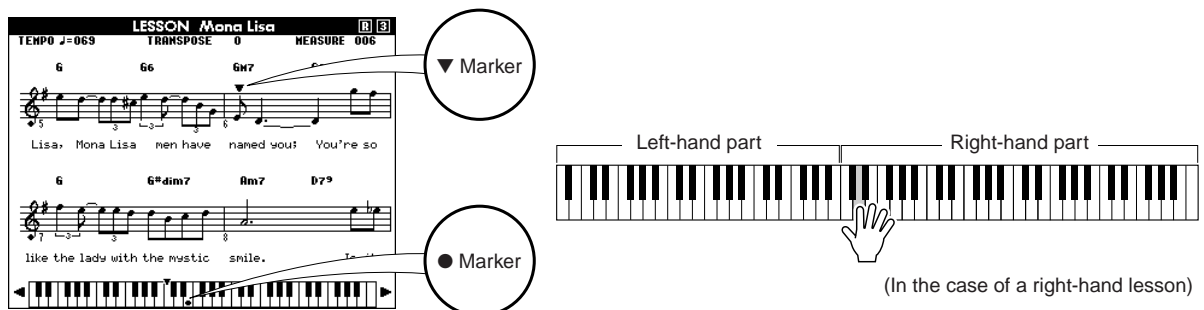

**3** Stop the Lesson mode.

You can stop the Lesson mode at any time by pressing the [START/STOP] button.

## Practice Makes Perfect—Repeat and Learn

Use this feature when you want to start again just ahead of a section on which you made a mistake, or to repeatedly practice a section you find difficult.

### Press the [REPEAT & LEARN] button during a lesson.

The song location will move back four measures from the point at which you pressed the button, and playback will begin after a one-measure count-in. Playback will continue up to the point at which you pressed the [REPEAT & LEARN] button, and then jump back four measures and begin again after a count-in. This process will repeat, so all you have to do is press the [REPEAT & LEARN] button when you make a mistake in order to repeat practice of that section until you get it right

**NOTE**

- You can change the number of measures the Repeat and learn function jumps back by pressing a number button [1]–[9] during repeat playback.

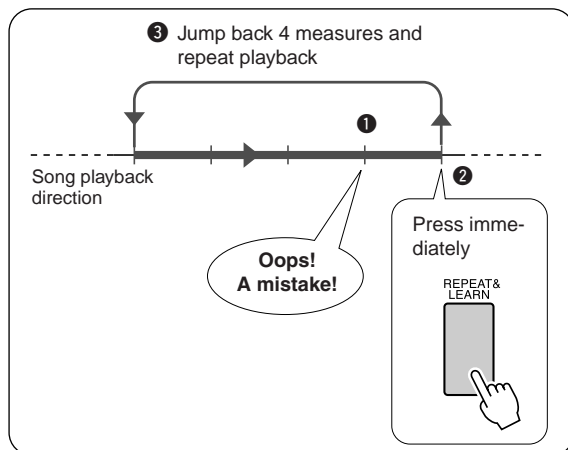
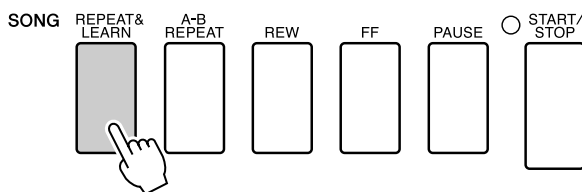



# Play Using the Music Database

You want to play music in your favorite style, but you're not sure how to select the best voice and style for the type of music you want to play ... simply select the appropriate style from the Music Database. The panel settings will automatically be adjusted for the ideal combination of sounds and style!

## 1 Press the [MUSIC DATABASE] button.

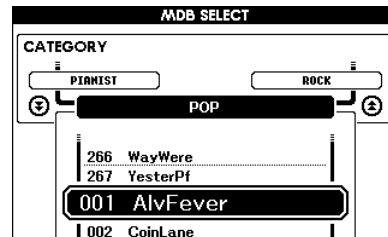

A Music Database list will appear in the display.

## 2 Select a Music Database.

Referring to the list on the panel or Music Database List on page 131 of the manual, use the dial to select a music database. Select one that matches the image of the song you intend to play. For this example select the “115 DayOfW&R”.

## 3 Play the chords with your left hand and melody with your right.

The jazz style will start playing when you play a left-hand chord to the left of the split point (page 24). Refer to pages 26–28 for information about playing chords.

If you press the [EXIT] button to return to the MAIN display at this point you can check the assigned voice and style.

## 4 Press the [START/STOP] button to stop playback.



# Change a Song's Style

In addition to each song's default style, you can select any other style to play the song with the Easy Song Arranger feature. This means that you can play a song that is normally a ballad, for example, as a bossa nova, as a hip-hop tune, etc. You can create totally different arrangements by changing the style with which a song is played.

You can also change the song's melody voice and the keyboard voice for a complete change of image.

## Try Out the Easy Song Arranger

You can try out the Easy Song Arranger feature using the internal Hallelujah Chorus song.

Press the [SONG] button and use the dial to select "009 Hallelujah Chorus." Press the [START/STOP] button begin playback of the song. An explanation of the Easy Song Arranger feature will appear on the display.

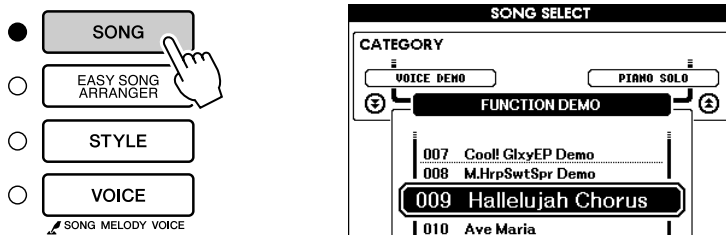

As the song progresses the styles will change, changing the overall image of the song.

Keep in mind that you can enjoy using Easy Song Arranger with other songs as well—any songs that include chord data.

### NOTE

- The score for Hallelujah Chorus is provided on page 118.

## Using the Easy Song Arranger

### 1 Press the [EASY SONG ARRANGER] button.

The Song Select display will appear. The currently selected song name and number will be highlighted.

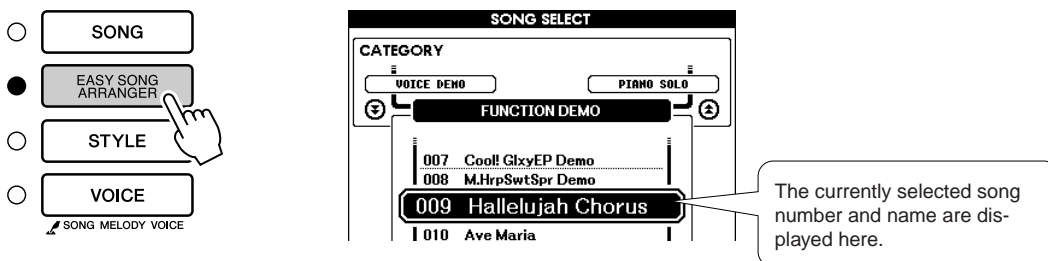

### 2 Select a Song.

Use the dial to select the song you want to arrange.

### 3 Listen to the song.

Press the [START/STOP] button to begin playback of the song. Move on to the next step while the song is playing.

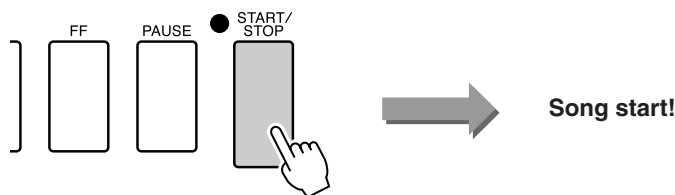

**NOTE**

• When playing song numbers 010, 011, and 020 to 030 while using the Easy Song Arranger, melody tracks will be automatically muted and no melody will sound. In order to hear the melody tracks you will need to press the SONG MEMORY buttons [3] to [5].

### 4 Press the [EASY SONG ARRANGER] button.

The Style Select display will appear. The currently selected style name and number will be highlighted.

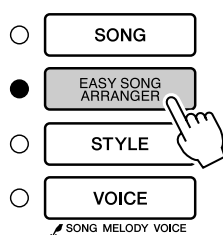

The currently selected style number and name are displayed here.

### 5 Select a style.

Rotate the dial and listen to how the song sounds with different styles. As you select different styles the song will remain the same while only the styles change. When you have selected a suitable style move on to the next step while the song is still playing (if you have stopped the song, start it again by pressing the [START/STOP] button).

**NOTE**

• Because the Easy Song Arranger uses song data you can't specify chords by playing in the accompaniment range of the keyboard. The [ACMP ON/OFF] button will not function.  
 • If the time signature of the song and style are different, the time signature of the song will be used.

### 6 Select a voice part.

If you press and hold the [VOICE] button for longer than a second a voice list will appear. The Melody R and Melody L displays will be selected alternately each time you press the [VOICE] button.

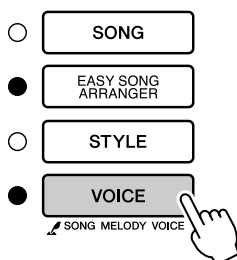

Hold for longer than a second

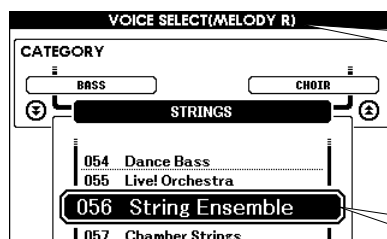

The Melody R and Melody L displays will be selected alternately each time you press the [VOICE] button.

The currently selected melody voice will be displayed.

### 7 Select a voice you want to play as a song melody.

Use the dial to change the melody voice. As you select different melody voices the song will remain the same while only the melody voice changes (if you have stopped the song, start it again by pressing the [START/STOP] button).

**NOTE**

• **The Difference Between MELODY R and MELODY L ...**  
 Songs are a combination of a melody and an auto-accompaniment style. Normally "melody" refers to the right-hand part, but in this instrument "melody" parts are provided for both the right and left hands. MELODY R is the melody part played by the right hand, and MELODY L is the melody part played by the left hand.



# Record Your Own Performance

You can record up to 5 of your own performances and save them as user songs 031 through 035. Once your performances have been saved as user songs, they can be converted to SMF (Standard MID File) format files and saved to USB flash memory (page 94) and used with score display. So when inspiration strikes and you create a great melody, you can save it in both listenable and written score form.

## Recordable Data

You can record to a total of 6 tracks: 5 melody tracks and 1 style (chord) track. Each track can be recorded individually.

- **Melody Track [1]–[5]** ..... Record the melody parts.
- **Style Track [A]** ..... Records the chord part.

### NOTE

- Up to approximately 10,000 notes can be recorded if you record only to the melody tracks. Up to approximately 5,500 chord changes can be recorded if you record only to the style track.
- User songs cannot display a score as is, but they can be converted to SMF (Standard MIDI File) format and stored to USB flash memory (page 94), from which they can be played with score display.

## Track Configuration

To record your own performance, first use the SONG MEMORY [1]–[5] and [A] buttons to specify the track(s) you want to record on. The track you record on determines the part that plays back later.

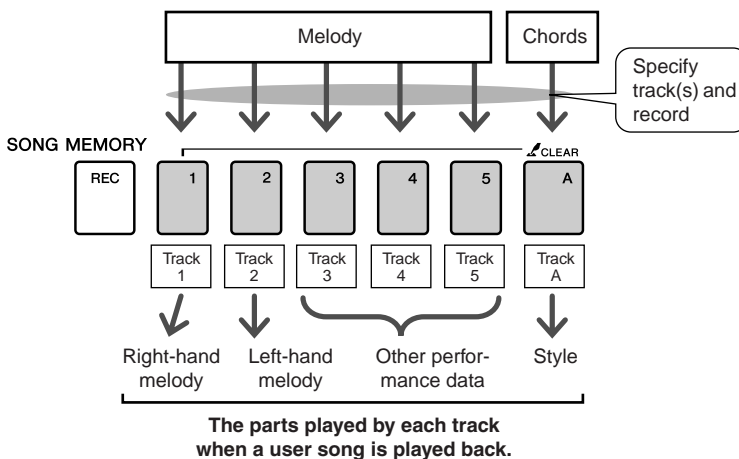

- **Track [1]**—Will play back as the right-hand melody part (MELODY R)
- **Track [2]**—Will play back as the left-hand melody part (MELODY L)
- **Tracks [3]–[5]**—Will play back as “other” performance data.
- **Track [A]**—Will play back as the Style (auto-accompaniment) part.

### NOTE

- **The Difference Between MELODY R and MELODY L ...** Songs are a combination of a melody and an auto-accompaniment style. Normally “melody” refers to the right-hand part, but in this instrument “melody” parts are provided for both the right and left hands. MELODY R is the melody part played by the right hand, and MELODY L is the melody part played by the left hand.



## Recording Procedure

- 1** From the MAIN display press the [SONG] button, then use the dial to select the user song number (031–035) you want to record to.

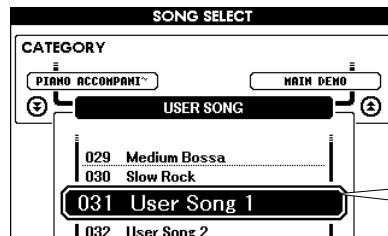
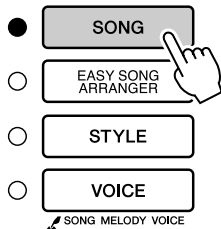

Rotate the dial to select a song number between 031 and 035.

- 2** Select the track(s) you want to record to and confirm your selection on the display.

### ◆ Record a Melody Track and the Accompaniment Track Together

Press the melody track button [1]–[5] you want to record to while holding the [REC] button.

Next, press the [A] button while holding the [REC] button. The selected tracks will be highlighted in the display.

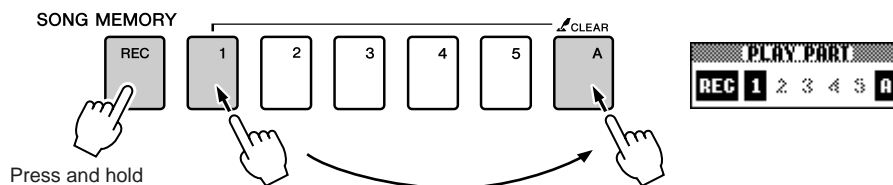

### ⚠ CAUTION

- If you record to track that contains previously-recorded data the previous data will be overwritten and lost.

### NOTE

- Style accompaniment is automatically turned on when you select the style track [A] for recording.
- Style accompaniment cannot be turned on or off while recording is in progress.

### ◆ Record a Melody track

Press the melody track button [1]–[5] you want to record to while holding the [REC] button.

The selected track will be highlighted in the display.

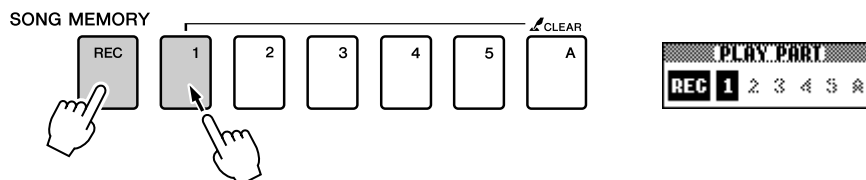

### NOTE

- If style accompaniment is on and track [A] has not yet been recorded, the style track [A] will automatically be selected for recording when a melody track is selected. If you only want to record a melody track, be sure to turn the style track [A] off.

To cancel recording to a selected track, press that track button a second time. Style accompaniment cannot be turned on or off while recording is in progress.

### 3 Recording will start when you play on the keyboard.

You can also start recording by pressing the [START/STOP] button. The current measure will be shown on the display during recording.

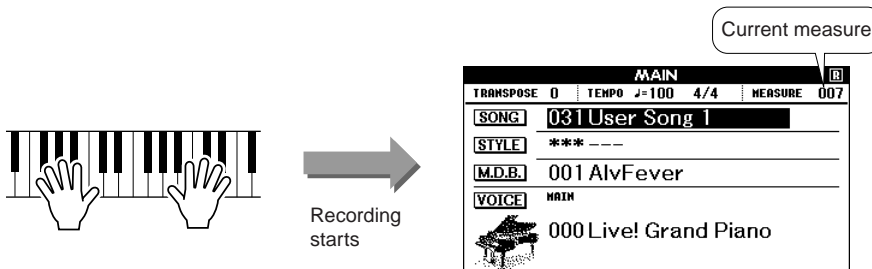

**NOTE**

• If the memory becomes full during recording a warning message will appear and recording will stop automatically. Use the song clear or track clear (page 59) function to delete unwanted data and make more room available for recording, then do the recording again.

### 4 Stop recording by pressing the [START/STOP] or [REC] button.



If you press the [INTRO/ENDING/rit.] button while recording the style track an appropriate ending pattern will play and then recording will stop. When recording stops the current measure number will return to 001 and the recorded track numbers in the display will be shown in a box border.

● **To Record Other Tracks**

Repeat steps 2 through 4 to record any of the remaining tracks. By selecting an unrecorded track—SONG MEMORY buttons [1]–[5], [A]—you can record the new track while listening to previously recorded tracks (the playback tracks will appear in the display). You can also mute previously recorded tracks (the muted tracks will not appear in the display) while recording new tracks.

● **To Re-record a Track**

Simple select the track you want to re-record for recording in the normal way. The new material will overwrite the previous data.

### 5 When the recording is done ...

◆ **To Play Back a User Song**

User songs are played back in the same way as regular songs (page 29).

- 1 Press the [SONG] button from the MAIN display.
- 2 The current song number/name will be highlighted—use the dial to select the user song (031–035) you want to play.
- 3 Press the [START/STOP] button to start playback.

◆ **To Save a User Song to USB flash memory → page 93**

◆ **To save a User Song to USB flash memory in SMF format → page 94.**

● **Data that cannot be recorded**

- Split voice
- The following items are recorded at the beginning of the track. Changes made during the song will not be recorded.  
     Reverb type, Chorus type, Time signature, Style number, Style volume,  
     Tempo (When the style track is recorded)

## Song Clear—Deleting User Songs

This function clears an entire user song (all tracks).

**1** From the MAIN display select the user song (031–035) you want to clear.

• If you only want to clear a specific track from a user song use the Track Clear function.

**2** Press and hold the SONG MEMORY [1] button for longer than a second while holding the SONG MEMORY [A] button.

A confirmation message will appear on the display.

**3** Press the [+] button.

A confirmation message will appear on the display.  
 You can cancel the clear operation by pressing the [-] button.

**4** Press the [+] button to clear the song.

The clear-in-progress message will appear briefly on the display while the song is being cleared.

## Track Clear—Deleting a Specified Track from a User Song

This function lets you delete a specified track from a user song.

- 1** From the MAIN display select the user song (031–035) you want to clear.
- 2** Press and hold the SONG MEMORY track button ([1]–[5], [A]) corresponding to the track you want to clear for longer than a second.

A confirmation message will appear on the display.

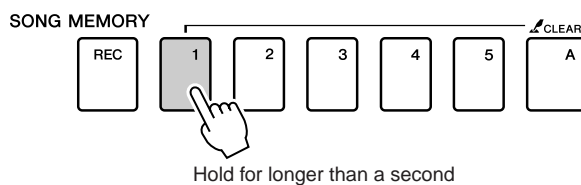

- 3** Press the [+] button.  
A confirmation message will appear on the display.  
You can cancel the clear operation by pressing the [-] button.
- 4** Press the [+] button to clear the track.  
The clear-in-progress message will appear briefly on the display while the track is being cleared.

### NOTE

- To execute the Track Clear function press the [+] button. Press [-] to cancel the Track Clear operation.



# Backup and Initialization

## Backup

The following settings are always backed up, and are maintained even when the power is turned off. If you want to initialize the settings, use the Initialize operation as explained below.

### ● The Backup Parameters

- User Songs
- Style Files
- Registration Memory
- FUNCTION Settings: Tuning, Split Point, Touch Sensitivity, Style Volume, Song Volume, Metronome Volume, Grade, Demo Cancel, Language Selection, Panel Sustain, Master EQ type, Chord Fingering

## Initialization

Initialization. This function erases all backup data in the instrument's flash memory and restores the initial default settings. The following initialization procedures are provided.

### ■ Backup Clear .....

To clear data backed up to the internal flash memory—panel user setting, registration memory, user songs, style file—turn the power on by pressing the [STANDBY/ON] switch while holding the highest white key on the keyboard. The backed up data will be erased and the default values restored.

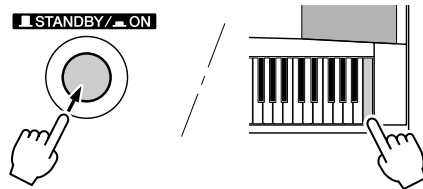

### ■ Flash Clear .....

To clear song data and style files that have been transferred to the internal flash memory from a computer, turn the power on by pressing the [STANDBY/ON] switch while simultaneously holding the highest white key on the keyboard and the three highest black keys.

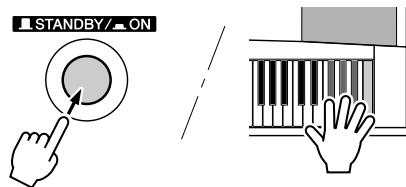

#### ⚠ CAUTION

- When you execute the Flash Clear operation, song data you have purchased will also be cleared. Be sure to save data you want to keep to a computer.

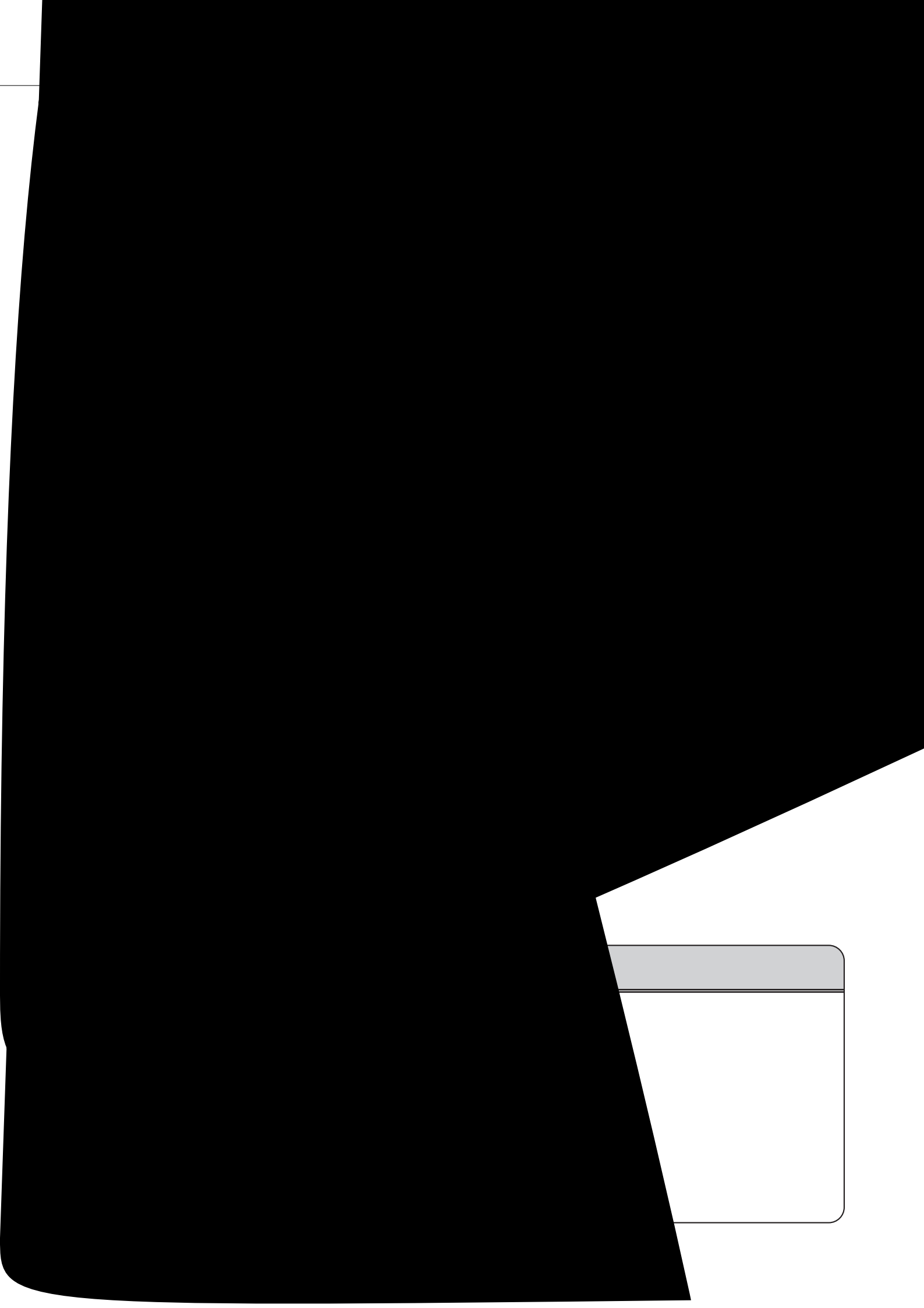

## 2 Use the dial to select an item or value

When you select a basic function, the item corresponding to that function will be listed in the display. You can then use the dial or the number buttons [0]–[9] to select the desired item.

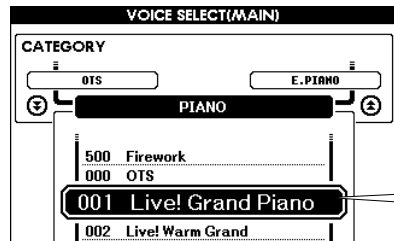

The currently selected item is highlighted in the display. In this example the [VOICE] button has been pressed.

### ■ Changing Values

#### ● Dial

Rotate the dial clockwise to increase the value of the selected item, or counterclockwise to decrease its value. Rotate the dial continuously to continuously increase or decrease the value.

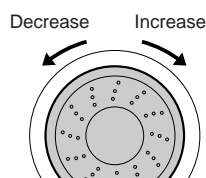

#### ● [+] and [-] Buttons

Press the [+] button briefly to increment the value by 1, or press the [-] button briefly to decrement the value by 1. Press and hold either button to continuously increment or decrement the value in the corresponding direction.

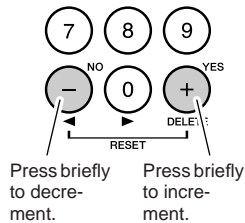

#### ● Number Buttons [0]–[9]

The number buttons can be used to directly enter a song number or parameter value. Hundreds or tens digits that are “0” can be omitted (see below).

**Example: Song number “003” can be entered in three ways.**

- [0] → [0] → [3]
- [0] → [3]  
 (“003” will appear on the display after a brief delay)
- [3]  
 (“003” will appear on the display after a brief delay)

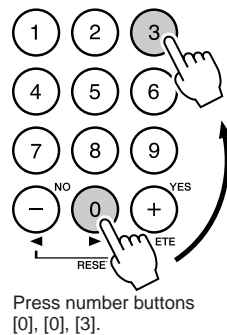

#### ● CATEGORY [▲] and [▼] buttons

When selecting a song, style, or voice, you can use these buttons to jump to the first item in the next or previous category.

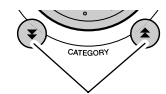

Jump to the first item in the next or previous category.

The CATEGORY [▲] and [▼] buttons are useful for selecting categorized items, as in the example below.

#### Example: VOICE SELECT Display

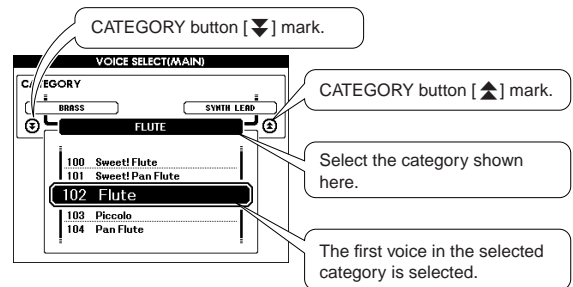

In a display in which a category appears, selection is easy if you first use the CATEGORY [▲] and [▼] buttons to select the category containing the desired item, then use the dial or [+] and [-] buttons to select the item. This can be particularly handy when you have to select from a large number of voices.

In most procedures described throughout this owner's manual the dial is recommended for selection simply because it is the easiest and most intuitive selection method. Please note however, that most items or values that can be selected using the dial can also be selected using the [+] and [-] buttons.

## 3 Start a function.

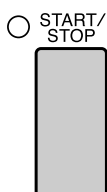

This is the [START/STOP] button.

Press the [START/STOP] button after pressing the [SONG] or [STYLE] button to start playback of the selected song or style (rhythm).

# The Displays

## ● Display Names

All operations are carried out while watching the display. A number of display types are provided for different modes and functions. The name of the current display appears at the top of the display.

## ● MAIN Display

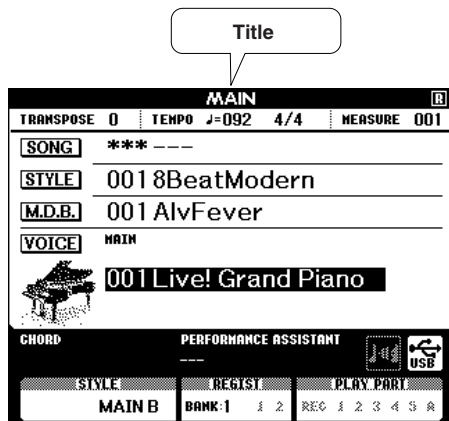

### To Return To the MAIN Display

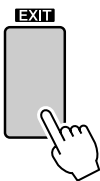

Most basic operations are carried out from the instrument's MAIN display. You can return to the MAIN display from any other display by pressing the [EXIT] button near the lower right corner of the display panel.

## ● FUNCTION Display (page 87)

The FUNCTION display provides access to 46 utility functions. The FUNCTION display appears when the [FUNCTION] button is pressed. In the FUNCTION display you can use the CATEGORY [▲] and [▼] buttons (page 63) to select 46 different groups of functions. Press the CATEGORY button(s) as many times as necessary until the required function appears. You can then use the dial, the [+] and [-] buttons, or the number [0]–[9] buttons to adjust the value of the function as required.

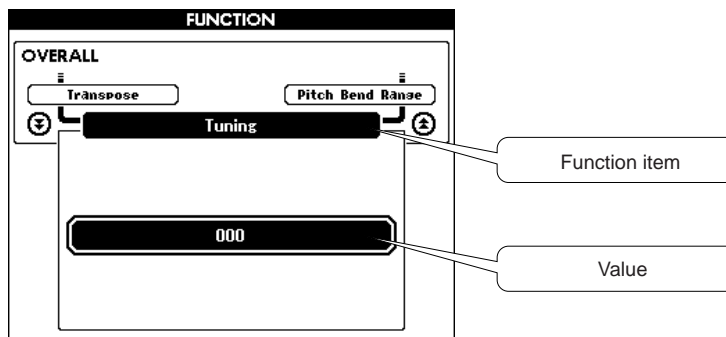

### The "Press & Hold" Symbol

The "  " symbol that appears next to some buttons indicates that the button can be pressed and held for longer than a second to call up a related function. This provides convenient direct access to a range of functions.

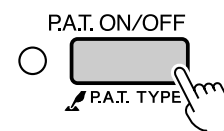



# MAIN Display Items

The MAIN display shows all of the current basic settings: song, style, voice. It also includes a range of indicators that show the on/off status of a range of functions.

\* Adjust the LCD CONTRAST control on the rear panel of the instrument for optimum display legibility.

CONTRAST

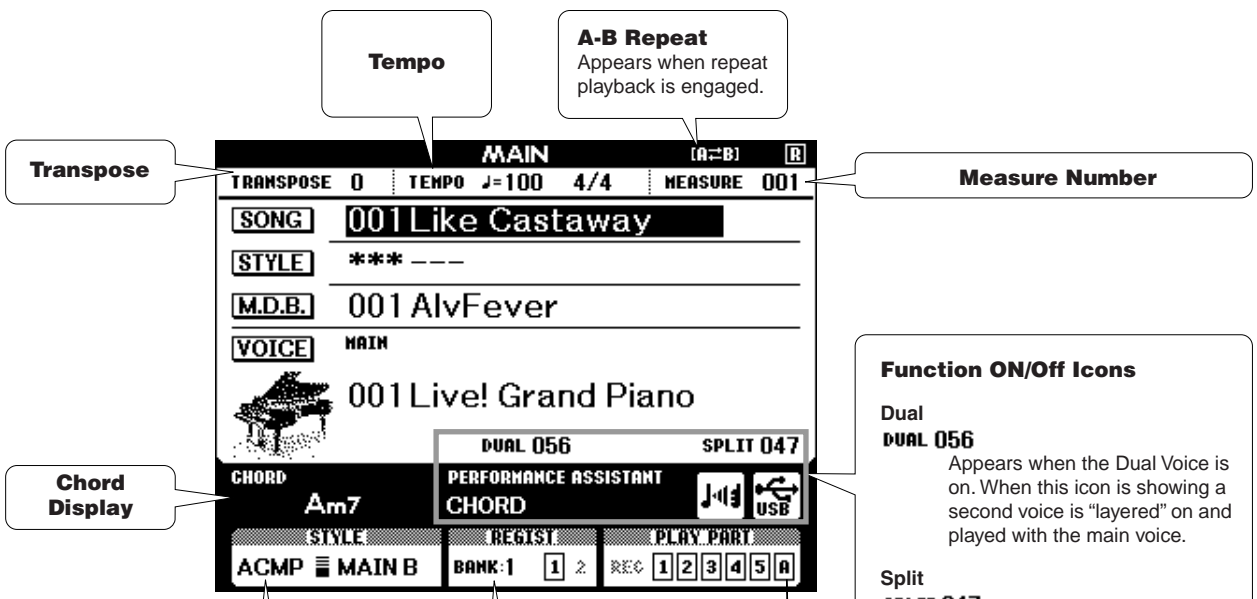

**Style (Auto-accompaniment) Status (page 24)**

**STYLE**  
ACMP MAIN B

**ACMP** Appears when the [ACMP ON/OFF] button is pressed to turn accompaniment on after selecting a style. When showing the keyboard range to the left of the split point is used for accompaniment chord recognition.

**MAIN B** The style pattern name.

**Registration Memory Status (page 85)**

**REGIST**  
BANK: 1 1 2

**BANK: 1** Shows the selected bank number.

**1 2** Shows the memory numbers that contain data. A border appears around the selected number.

**Song Track Status (pages 56, 84)**

**PLAY.PART**  
REC 1 2 3 4 5 A

**REC** Highlighted during user song recording.

**1 2 3 4 5 A**  
The track(s) selected for recording are highlighted during user-song recording. Only tracks that contain data are displayed. A border appears around a selected track that contains data. No border appears around a Muted track.

**Function ON/Off Icons**

**Dual DUAL 056**  
Appears when the Dual Voice is on. When this icon is showing a second voice is "layered" on and played with the main voice.

**Split SPLIT 047**  
Appears when the Split Voice is on. When this icon is showing different voices can be played to the left and right of the keyboard split point.

**Performance assistant technology PERFORMANCE ASSISTANT CHORD**  
Appears when the performance assistant technology is on.

**Harmony**  
Appears when Harmony is on. When this icon is showing harmony notes will be added to the main voice.

**File Control**  
When this icon is showing you can control file operations.

## Adding Harmony

This feature adds harmony notes to the main voice.

### 1 Press the [HARMONY ON/OFF] button to turn Harmony feature on.

To turn Harmony off, press the [HARMONY ON/OFF] button again.

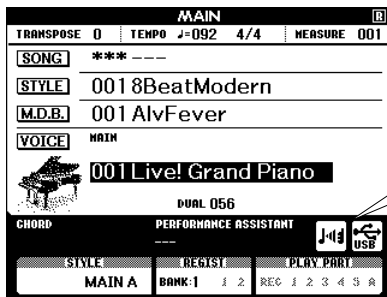
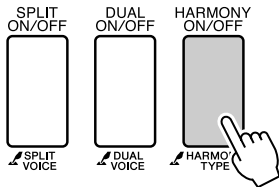

 When harmony is on the harmony icon will appear in the display.

#### NOTE

- When you press the [HARMONY ON/OFF] button to turn this feature on, the appropriate harmony type for the currently selected main voice is automatically selected.

### 2 Press and hold the [HARMONY] button for longer than a second.

The currently selected harmony type will be displayed.

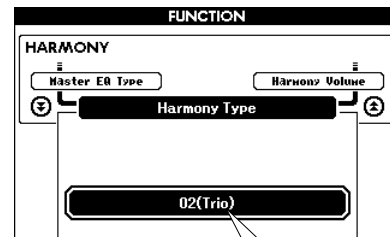
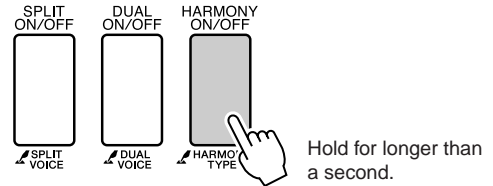

The currently selected harmony type

### 3 Use the dial to select a harmony type.

Refer to the Effect Type List on page 133 for information about the available harmony types. Try playing the keyboard with the harmony function. The effect and operation of each Harmony Type is different—refer to the below section “How to sound each Harmony Type” as well as the Effect Type List for details.

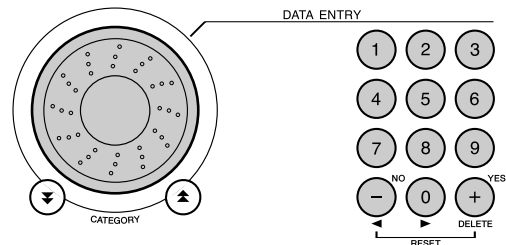

#### NOTE

- The harmony notes can be added only to the Main Voice, not to Dual or Split Voices.
- The keys left of the Split Point of the keyboard produce no harmony notes when the auto accompaniment is on (ACMP ON is lit).

#### ● How to sound each Harmony Type

- Harmony type 01 to 05

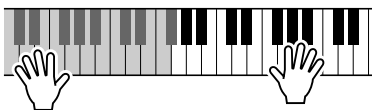

Press the right-hand keys while playing chords in the auto accompaniment range of the keyboard when the Auto Accompaniment is on (page 24).

- Harmony type 06 to 12 (Trill)

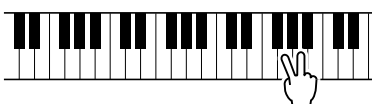

Hold down two keys.

- Harmony type 13 to 19 (Tremolo)



Keep holding down the keys.

- Harmony type 20 to 26 (Echo)



Keep holding down the keys.

You can adjust the Harmony Volume in the Function Settings (page 89).

## Adding Reverb

Reverb lets you play with a rich concert hall type ambience.

When you select a style or song the optimum reverb type for the voice used is automatically selected. If you want to select a different reverb type, use the procedure described below. Refer to the Effect Type List on page 133 for information about the available reverb types.

- 1 Press the [FUNCTION] button to call up the FUNCTION display.

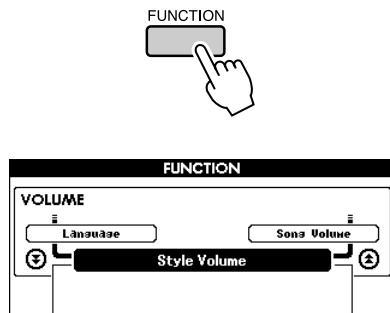

- 2 Use the CATEGORY [▲] and [▼] buttons to select the Reverb Type item.

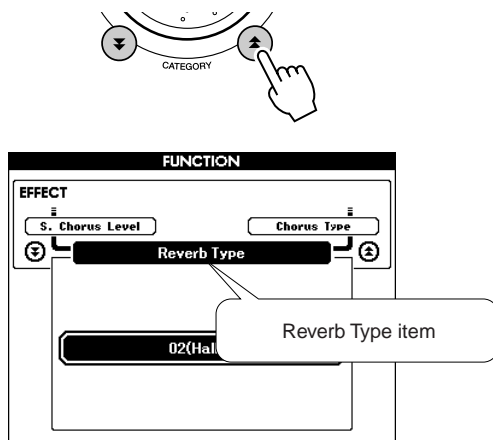

- 3 Use the dial to select a reverb type.

You can check how the selected reverb type sounds by playing on the keyboard.

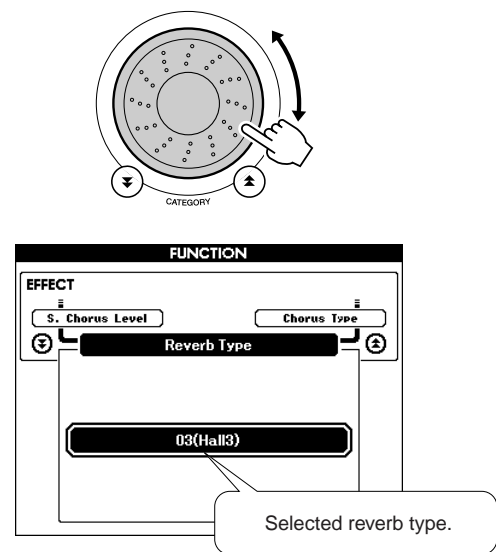

Refer to the Effect Type List on page 133 for information about the available reverb types.

### ● Adjusting the Reverb Level

You can individually adjust the amount of reverb that is applied to the main, dual, and split voices. (See page 88).

## Adding Chorus

The chorus effect creates a thick sound that is similar to many of the same voices being played in unison. When you select a style or song the optimum chorus type for the voice used is automatically selected. If you want to select a different chorus type, use the procedure described below.

- 1 Press the [FUNCTION] button to call up the FUNCTION display.**

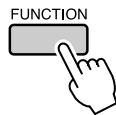

- 2 Use the CATEGORY [▲] and [▼] buttons to select the Chorus Type item.**

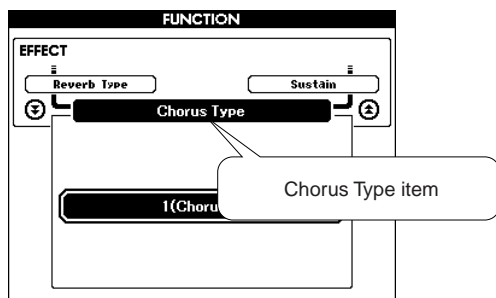
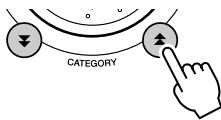

- 3 Use the dial to select a chorus type.**

You can check how the selected chorus type sounds by playing on the keyboard.

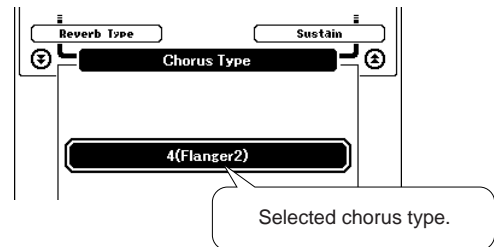
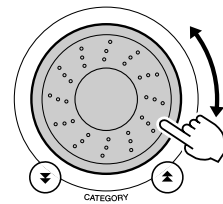

### ● Adjusting the Chorus Level

You can individually adjust the amount of chorus that is applied to the main, dual, and split voices. (See page 88).

## Panel Sustain

This function adds sustain to the keyboard voices. Use it when you want to add sustain to the voices at all times, regardless of footswitch operation. The sustain function does not affect split voice.

- 1 Press the [FUNCTION] button to call up the FUNCTION display.

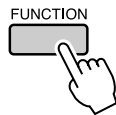

- 2 Use the CATEGORY [▲] and [▼] buttons to select the Sustain item.

The current setting is displayed.

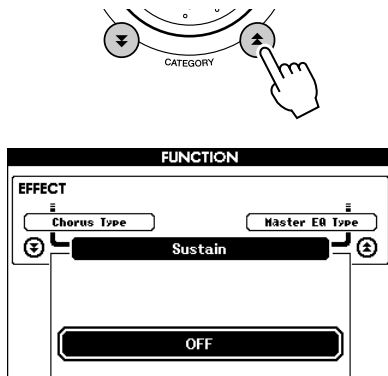

- 3 You can then use the [+] and [-] buttons to turn panel sustain on or off.

### NOTE

- The sustain of some voices may not be markedly affected when the panel sustain function is turned on.

## Pitch Bend

The pitch bend wheel can be used to add smooth pitch variations to notes you play on the keyboard. Roll the wheel upward to raise the pitch, or downward to lower the pitch.

If you use this feature with a voice such as the “045 Overdriven” guitar voice (page 15), you can produce remarkably realistic string-bending effects.

You can change the amount of pitch bend produced by the wheel, as described on page 88.

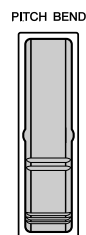

# Handy Performance Features

## Tap Start

You can start the song/style by simply tapping the [TEMPO/TAP] button at the required tempo—4 times for time signatures in 4, and three times for time signatures in 3. You can change the tempo during song playback by pressing the button just twice.

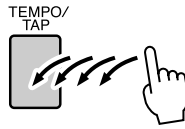

## Touch Response Sensitivity

You can adjust the keyboard's sensitivity to dynamics in three steps.

### 1 Press the [FUNCTION] button.

The currently selected function will appear in the display.

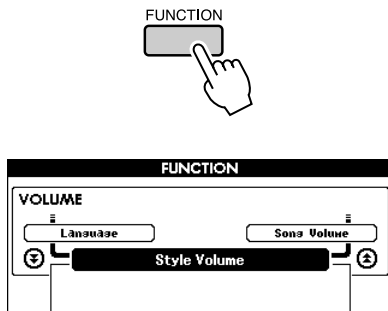

### 2 Use the CATEGORY [▲] and [▼] buttons to select the Touch Sensitivity item.

The currently selected touch sensitivity will be displayed.

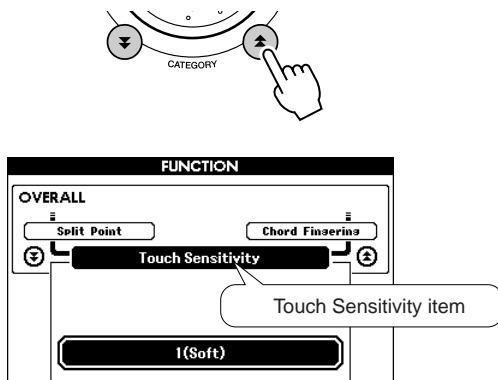

### 3 Use the dial to select a touch sensitivity setting between 1 and 3. Higher values produce greater (easier) volume variation in response to keyboard dynamics—i.e. greater sensitivity.

A setting of “4” results in a fixed touch response, or no level change no matter how hard or how soft you play the keys.

**NOTE**

- The initial default touch sensitivity setting is “2”.

## One Touch Setting

Sometimes selecting the ideal voice to play with a song or style can be confusing. The One Touch Setting feature automatically selects a well-balanced voice for you when you select a style or song. Simply select voice number “000” to activate this feature.

- 1** Select voice number “000” (steps 1 to 2 on page 15).

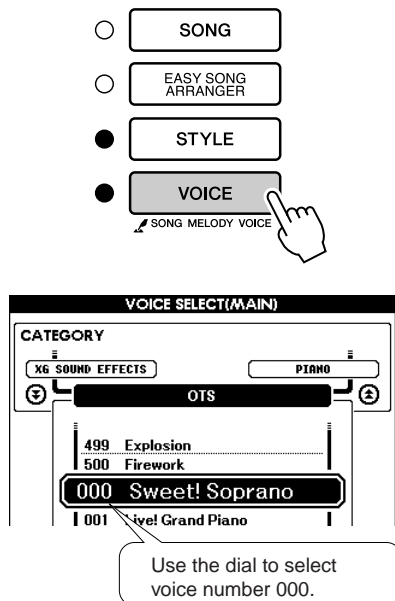

- 2** Select and play back any song (steps 1 to 3 on page 29).

- 3** Play the keyboard and remember the sound of the voice.

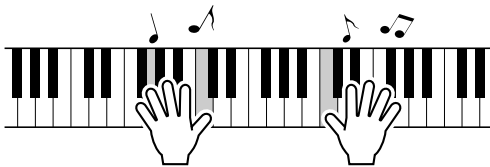

If you have stopped playback at some point during this procedure press the [START/STOP] button to start playback again.

- 4** Use the dial to change songs, then play the keyboard and listen to the voice.

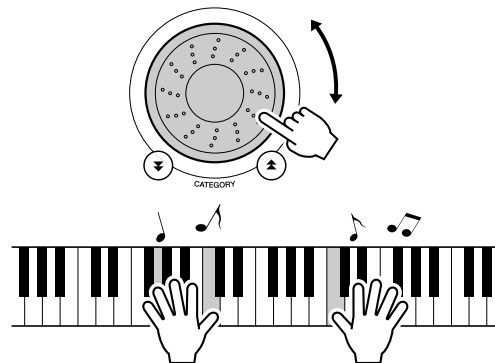

You should hear a different keyboard voice than you played in step 3. Watch the display while changing songs and you will see that different voices are selected for each song.

## Select an EQ Setting for the Best Sound

Five different master equalizer (EQ) settings are provided to give you the best possible sound when listening through different reproduction systems—the instrument’s internal speakers, headphones, or an external speaker system.

### 1 Press the [FUNCTION] button.

The currently selected function will appear in the display.

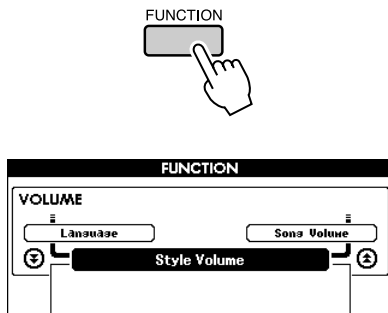

### 2 Press the CATEGORY [▲] and [▼] buttons as many times as necessary to select the master EQ type function “Master EQ Type”.

The currently selected EQ type will appear.

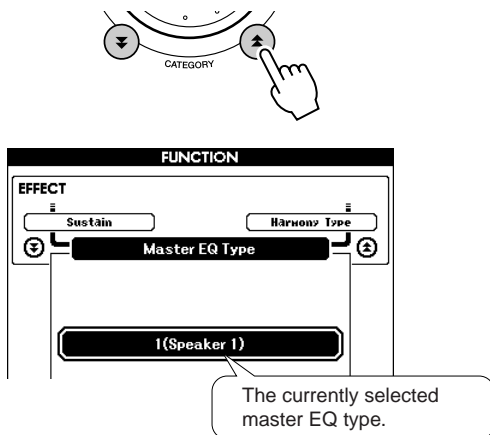

### 3 Use the dial to select the desired Master EQ setting.

Five settings are available: 1–5. Settings 1 and 2 are best for listening via the instrument’s built-in speakers, setting 3 is for headphones, and settings 4 and 5 are ideal for listening via external speakers.



## Pitch Controls

### ◆ Large Pitch Changes (Transpose)

The overall pitch of the instrument can be shifted up or down by a maximum of 1 octave in semitone increments.

#### 1 Press the [FUNCTION] button.

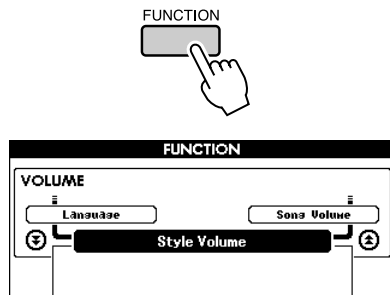

#### 2 Use the CATEGORY [▲] and [▼] buttons to select the Transpose item.

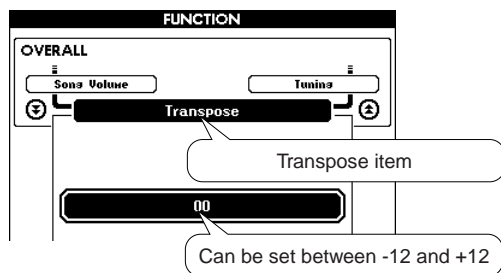

#### 3 Use the dial to set the transpose value between -12 and +12 as required.

##### NOTE

- The pitch of Drum Kits voices cannot be changed.

### ◆ Small Pitch Changes (Tuning)

The overall tuning of the instrument can be shifted up or down by a maximum of 100 cents in 1-cent increments (100 cents = 1 semitone).

#### 1 Press the [FUNCTION] button.

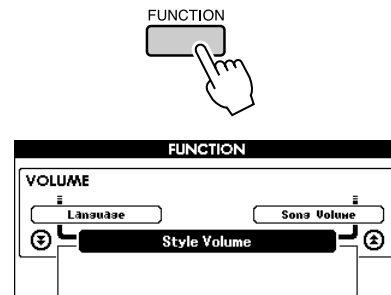

#### 2 Use the CATEGORY [▲] and [▼] buttons to select the Tuning item.

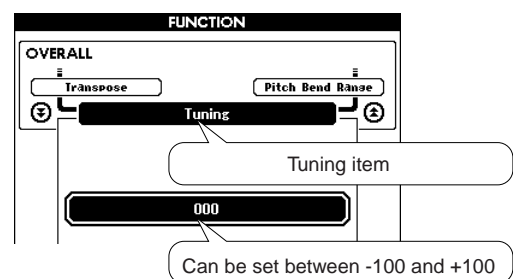

#### 3 Use the dial to set the tuning value between -100 and +100 as required.

##### NOTE

- The pitch of Drum Kits voices cannot be changed.



# Style (Auto-accompaniment) Functions

Basic operation of the Style (auto-accompaniment) feature is described on page 23 of the Quick Guide.

Here are some other ways you can play the styles, the style volume adjustment procedure, how you can play chords using the styles, and more.

## Pattern Variation (Sections)

The DGX-620/520, YPG-625/525 features a wide variety of style “sections” that allow you to vary the arrangement of the accompaniment to match the song you are playing.

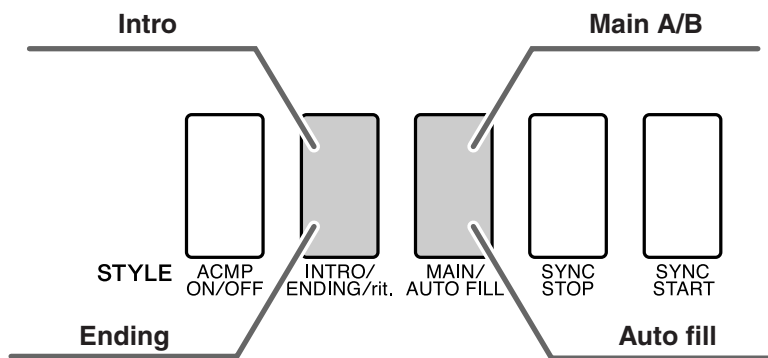

### ● INTRO section

This is used for the beginning of the Song. When the intro finishes playing, accompaniment shifts to the main section. The length of the intro (in measures) differs depending on the selected Style.

### ● MAIN section

This is used for playing the main part of the Song. It plays a main accompaniment pattern, and repeats indefinitely until another section's button is pressed. There are two variations on the basic pattern (A and B), and the Style playback sound changes harmonically based on the chords you play with your left hand.

### ● Fill-in section

This is automatically added before changing to section A or B.

### ● ENDING section

This is used for the ending of the Song. When the ending is finished, the auto accompaniment stops automatically. The length of the ending (in measures) differs depending on the selected Style.

**1** Press the [STYLE] button and then select a style.

**2** Press the [ACMP ON/OFF] button to turn auto accompaniment on.

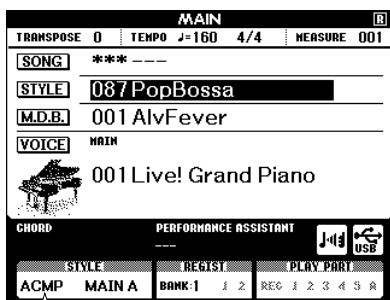
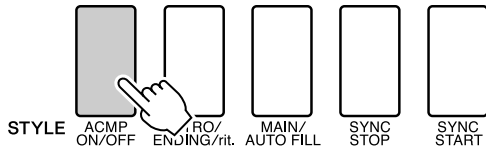

**STYLE:**  
ACMP MAIN A

Appears when auto accompaniment is on.

**3** Press the [SYNC START] button to turn synchro start on.

The indicator will flash when the synchro start standby mode will be engaged.

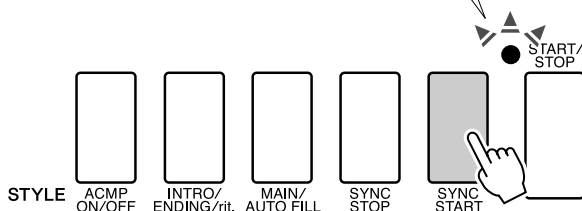

● **Synchro Start**

When the synchro start standby mode is engaged, style playback will begin as soon as you play a chord in the accompaniment range of the keyboard. You can disengage the synchro-start standby mode by pressing the [SYNC START] button again.

**4** Press the [MAIN/AUTO FILL] button.

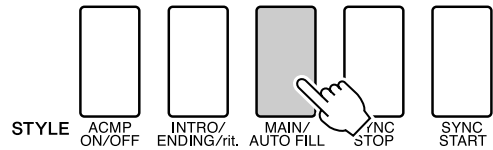

**STYLE:**  
ACMP MAIN A

The name of the selected section—MAIN A or MAIN B—will be displayed.

**5** Press the [INTRO/ENDING/rit.] button.

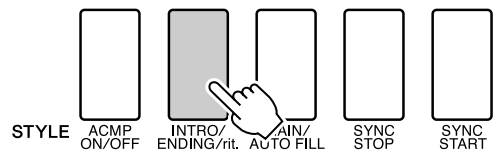

**STYLE:**  
ACMP INTRO A

You're now ready to play the intro.

**6** As soon as you play a chord with your left hand, the Intro of the selected Style starts.

For this example, play a C major chord (as shown below). For information on how to enter chords, see “Playing Auto-accompaniment Chords” on page 28.

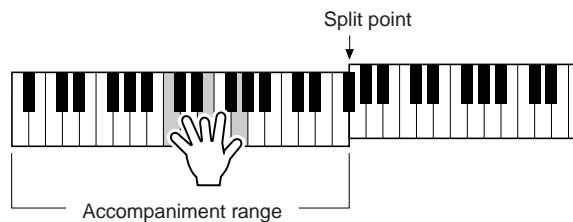

**7 Press the [MAIN/AUTO FILL] button.**

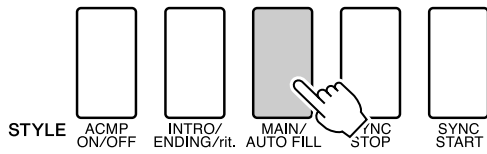

When the fill-in is finished, it leads smoothly into the selected main section A/B.

**8 Press the [INTRO/ENDING/rit.] button.**

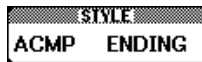
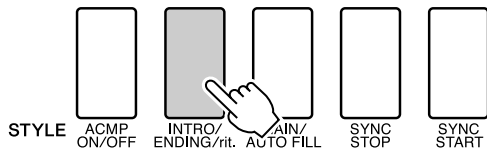

This switches to the ending section. When the ending is finished, the auto accompaniment stops automatically. You can have the ending gradually slow down (ritardando) by pressing the [INTRO/ENDING/rit.] button again while the ending is playing back.

**● Synchro Stop**

When this function is selected the accompaniment style will only play while you are playing chords in the accompaniment range of the keyboard. Style playback will stop when you release the keys. To turn the function on, press the [SYNC STOP] button.

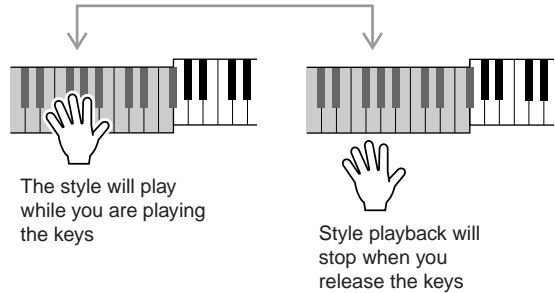
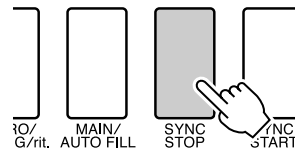

## Setting the Split Point

The initial default split point is key number 54 (the F#2 key), but you can change it to another key using the procedure described below.

### 1 Press the [FUNCTION] button.

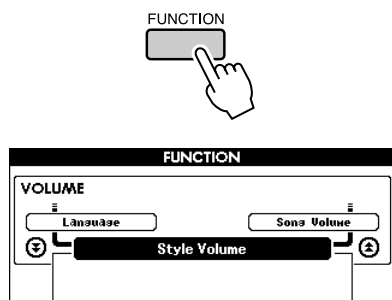

### 2 Use the CATEGORY [▲] and [▼] buttons to select the Split point item.

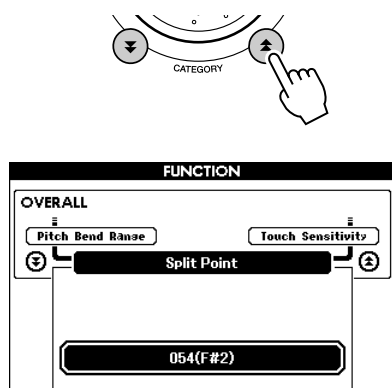

### 3 Use the dial to set the split point to any key from 000 (C-2) through 127 (G8).

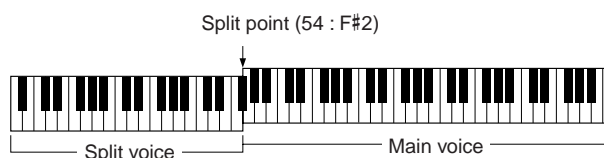

#### NOTE

- When you change the split point the auto-accompaniment split point also changes.
- The split point cannot be changed during a song lesson.
- The split voice sounds when the split-point key is played.

#### NOTE

- You can also access the Split Point item by pressing the [FUNCTION] button and using the CATEGORY [▲] and [▼] buttons to locate the item (page 87).

## Play a Style with Chords but No Rhythm (Stop Accompaniment)

When auto accompaniment is on (the ACMP ON icon is showing) and Synchro Start is off, you can play chords in the left-hand accompaniment range of the keyboard while the style is stopped and still hear the accompaniment chords. This is “Stop Accompaniment”, and any of the chord fingerings recognized by the instrument can be used (page 28).

Press the [ACMP ON/OFF] button to turn auto accompaniment on after pressing the [STYLE] button.

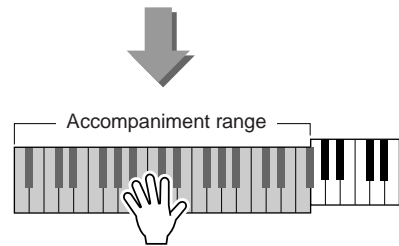
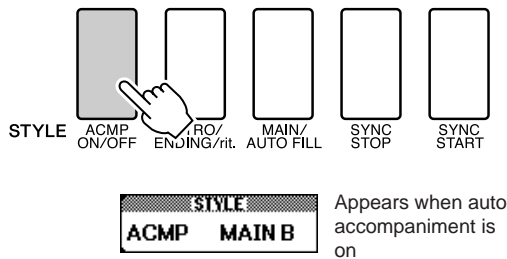

## Adjusting the Style Volume

Press the [STYLE] button to engage the style function.

**1** Press the [FUNCTION] button.

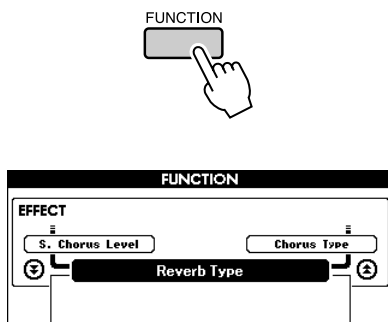

**2** Use the CATEGORY [▲] and [▼] buttons to select the Style Volume item.

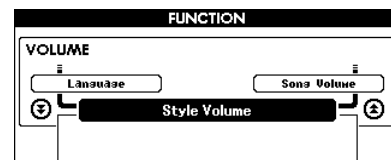
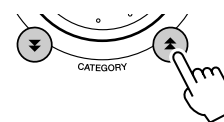

**3** Use the dial to set the style volume between 000 and 127.

## Chord Basics

Two or more notes played together constitute a “chord”.

The most basic chord type is the “triad” consisting of three notes: the root, third, and fifth degrees of the corresponding scale. A C major triad, for example, is made up of the notes C (the root), E (the third note of the C major scale), and G (the fifth note of the C major scale).

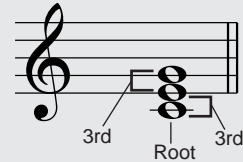

In the C major triad shown above, the lowest note is the “root” of the chord (this is the chord’s “root position” ... using other chord notes for the lowest note results in “inversions”). The root is the central sound of the chord, which supports and anchors the other chord notes.

The distance (interval) between adjacent notes of a triad in root position is either a major or minor third.

Major third—four half steps (semitones)

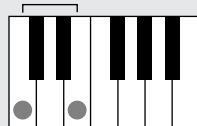

Minor third—three half steps (semitones)

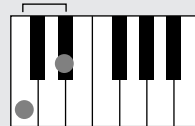

The lowest interval in our root-position triad (between the root and the third) determines whether the triad is a major or minor chord, and we can shift the highest note up or down by a semitone to produce two additional chords, as shown below.



The basic characteristics of the chord sound remain intact even if we change the order of the notes to create different inversions. Successive chords in a chord progression can be smoothly connected, for example, by choosing the appropriate inversions (or chord “voicings”).

### ● Reading Chord Names

Chord names tell you just about everything you need to know about a chord (other than the inversion/voicing). The chord name tells you what the root of the chord is, whether it is a major, minor, or diminished chord, whether it requires a major or flattened seventh, what alterations or tensions it uses ... all at a glance.

### ● Some Chord Types (These are just some of the “Standard” chord types recognized by the DGX-620/520, YPG-625/525.)

## ■ Recognized Standard Chords.....

All chords in the chart are “C-root” chords.

Chord Name/[Abbreviation]	Normal Voicing	Chord (C)	Display
Major [M]	1 - 3 - 5	C	C
Add ninth [(9)]	1 - 2 - 3 - 5	C <sup>(9)</sup>	C9
Sixth [6]	1 - (3) - 5 - 6	C <sub>6</sub>	C6
Sixth ninth [6(9)]	1 - 2 - 3 - (5) - 6	C <sub>6</sub> <sup>(9)</sup>	C6 <sup>9</sup> *
Major seventh [M7]	1 - 3 - (5) - 7 or 1 - (3) - 5 - 7	CM7	CM7
Major seventh ninth [M7(9)]	1 - 2 - 3 - (5) - 7	CM <sub>7</sub> <sup>(9)</sup>	CM7 <sup>9</sup> *
Major seventh add sharp eleventh [M7(#11)]	1 - (2) - 3 - #4 - 5 - 7 or 1 - 2 - 3 - #4 - (5) - 7	C <sup>(#11)</sup> CM7	CM7 <sup>#11</sup> *
Flatted fifth [(b5)]	1 - 3 - b5	C <sup>(b5)</sup>	C <sup>b5</sup> *
Major seventh flatted fifth [M7b5]	1 - 3 - b5 - 7	CM <sub>7</sub> <sup>(b5)</sup>	CM7 <sup>b5</sup> *
Suspended fourth [sus4]	1 - 4 - 5	Csus4	Csus4
Augmented [aug]	1 - 3 - #5	Caug	Caug
Major seventh augmented [M7aug]	1 - (3) - #5 - 7	CM7aug	CM7aug *
Minor [m]	1 - b3 - 5	Cm	Cm
Minor add ninth [m(9)]	1 - 2 - b3 - 5	C <sub>m</sub> <sup>(9)</sup>	Cm9
Minor sixth [m6]	1 - b3 - 5 - 6	Cm6	Cm6
Minor seventh [m7]	1 - b3 - (5) - b7	Cm7	Cm7
Minor seventh ninth [m7(9)]	1 - 2 - b3 - (5) - b7	C <sub>m7</sub> <sup>(9)</sup>	Cm7 <sup>9</sup>
Minor seventh add eleventh [m7(11)]	1 - (2) - b3 - 4 - 5 - (b7)	C <sub>m7</sub> <sup>(11)</sup>	Cm7 <sup>11</sup> *
Minor major seventh [mM7]	1 - b3 - (5) - 7	CmM7	CmM7
Minor major seventh ninth [mM7(9)]	1 - 2 - b3 - (5) - 7	C <sub>mM7</sub> <sup>(9)</sup>	CmM7 <sup>9</sup> *
Minor seventh flatted fifth [m7b5]	1 - b3 - b5 - b7	C <sub>m7</sub> <sup>(b5)</sup>	Cm7 <sup>b5</sup>
Minor major seventh flatted fifth [mM7b5]	1 - b3 - b5 - 7	C <sub>mM7</sub> <sup>(b5)</sup>	CmM7 <sup>b5</sup> *
Diminished [dim]	1 - b3 - b5	Cdim	Cdim
Diminished seventh [dim7]	1 - b3 - b5 - 6	Cdim7	Cdim7
Seventh [7]	1 - 3 - (5) - b7 or 1 - (3) - 5 - b7	C7	C7
Seventh flatted ninth [7(b9)]	1 - b2 - 3 - (5) - b7	C <sub>7</sub> <sup>(b9)</sup>	C7 <sup>b9</sup>
Seventh add flatted thirteenth [7(b13)]	1 - 3 - 5 - b6 - b7	C <sub>7</sub> <sup>(b13)</sup>	C7 <sup>b13</sup>
Seventh ninth [7(9)]	1 - 2 - 3 - (5) - b7	C <sub>7</sub> <sup>(9)</sup>	C7 <sup>9</sup>
Seventh add sharp eleventh [7(#11)]	1 - (2) - 3 - #4 - 5 - b7 or 1 - 2 - 3 - #4 - (5) - b7	C <sub>7</sub> <sup>(#11)</sup>	C7 <sup>#11</sup>
Seventh add thirteenth [7(13)]	1 - 3 - (5) - 6 - b7	C <sub>7</sub> <sup>(13)</sup>	C7 <sup>13</sup>
Seventh sharp ninth [7(#9)]	1 - #2 - 3 - (5) - b7	C <sub>7</sub> <sup>(#9)</sup>	C7 <sup>#9</sup>
Seventh flatted fifth [7b5]	1 - 3 - b5 - b7	C7 <sup>b5</sup>	C7 <sup>b5</sup> *
Seventh augmented [7aug]	1 - 3 - #5 - b7	C7aug	C7aug
Seventh suspended fourth [7sus4]	1 - 4 - (5) - b7	C7sus4	C7sus4
Suspended second [sus2]	1 - 2 - 5	Csus2	Csus2 *

\* These chords are not shown in the Dictionary function.

**NOTE**

- Notes in parentheses can be omitted.
- Playing two same root keys in the adjacent octaves produces accompaniment based only on the root.
- A perfect fifth (1 + 5) produces accompaniment based only on the root and fifth which can be used with both major and minor chords.
- The chord fingerings listed are all in “root” position, but other inversions can be used—with the following exceptions: m7, m7b5, 6, m6, sus4, aug, dim7, 7b5, 6(9), sus2.

**NOTE**

- Inversion of the 7sus4 and m7(11) chords are not recognized if the notes shown in parentheses are omitted.
- The auto accompaniment will sometimes not change when related chords are played in sequence (e.g. some minor chords followed by the minor seventh).
- Two-note fingerings will produce a chord based on the previously played chord.



## Style File

This instrument features 150 internal styles, but other styles, such as those provided on the CD-ROM and others that can be obtained from the internet (only styles with the “.sty” suffix), can be loaded into style number 151 and used in the same way as the internal styles. For details on loading the style file, see “Loading User Files and Style Files” on page 95.

In order to load a style file it is necessary to first either transfer the style file to the instrument from a computer, or connect a USB flash memory containing the style file to the USB TO DEVICE connector. Refer to “Transferring Performance Data to and from a Computer” on page 100 for details on the file transfer procedure. If you use a USB flash memory refer to “Loading User Files and Style Files” on page 95.

## Playing Styles Using the Entire Keyboard

In “Play Along with a Style” on page 24 we described a method of playing styles in which chords were detected only to the left of the keyboard split point. By making the settings described below, however, chord detection for style accompaniment occurs over the entire range of the keyboard, allowing for even more dynamic style performance. In this mode only chords played in the normal way (page 28) can be detected.

**1** Press the [CHORD FINGERING] button to select the function “Chord Fingering”.

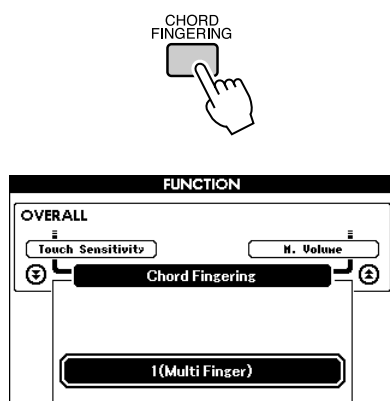

**2** Use the dial to select 2 “FullKeyboard”.

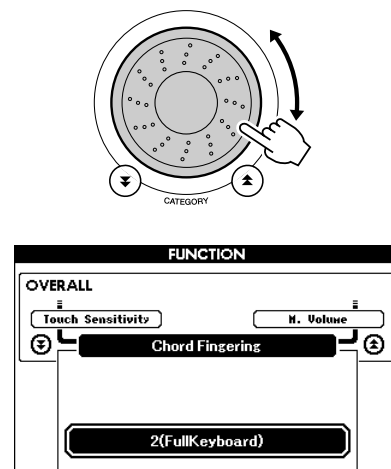

## Looking Up Chords Using the Chord Dictionary

The Dictionary function is essentially a built-in “chord book” that shows you the individual notes of chords. It is ideal when you know the name of a certain chord and want to quickly learn how to play it.

- 1 Press and hold the LESSON [START] button for longer than a second.

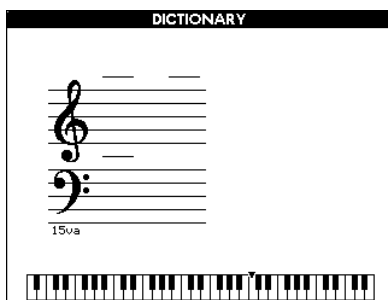
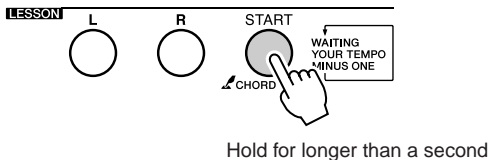

- 2 As an example, we'll learn how to play a GM7 (G major seventh) chord. Press the “G” key in the section of the keyboard labeled “ROOT”. (The note doesn't sound.) The root note you set is shown in the display.

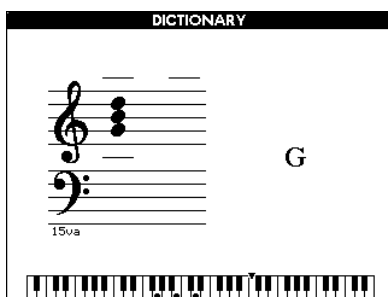
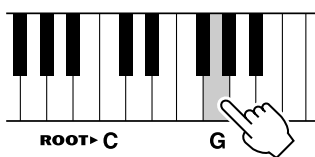

- 3 Press the “M7” (major seventh) key in the section of the keyboard labeled “CHORD TYPE”. (The note doesn't sound.) The notes you should play for the specified chord (root note and chord type) are shown in the display, both as notation and in the keyboard diagram.

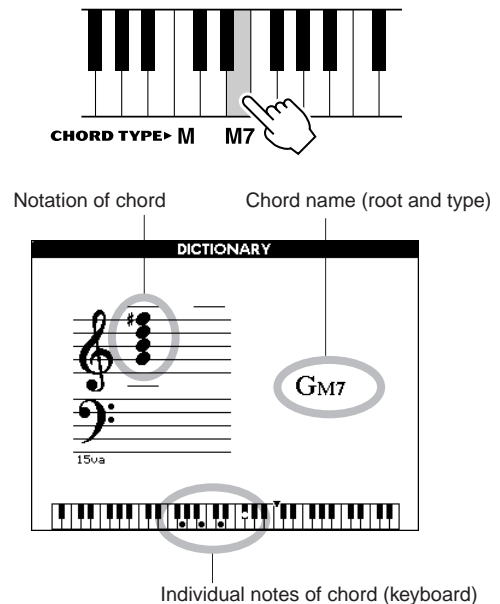

To call up possible inversions of the chord, press the [+]/[-] buttons.

**NOTE**

- About major chords: Simple major chords are usually indicated only by the root note. For example, “C” refers to C major. However, when specifying major chords here, make sure to select “M” (major) after pressing the root note.
- Be aware that the chord types explained here are the left-hand notes applied to various styles and different from the one for the performance assistant technology feature.

- 4 Try playing a chord in the auto accompaniment section of the keyboard, checking the indications in the display. When you've played the chord properly, a bell sound signals your success and the chord name in the display flash.

Press the [EXIT] button to return to the MAIN display.

## Song Volume

**1** Press the [FUNCTION] button.

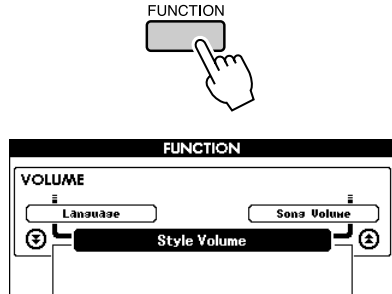

**2** Use the CATEGORY [ $\blacktriangle$ ] and [ $\blacktriangledown$ ] buttons to select the Song Volume item.

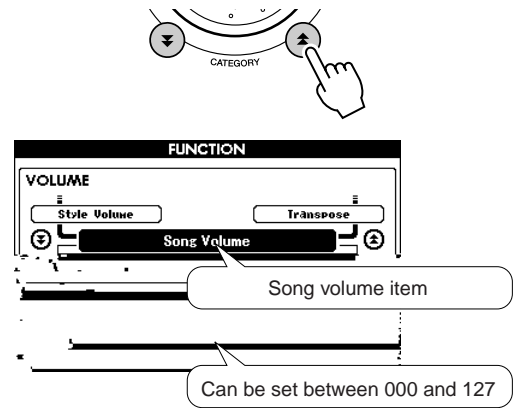

**3** Use the dial to set the song volume between 000 and 127.

**NOTE**

- Song volume can be adjusted while a song is selected.

## A-B Repeat

You can specify a section of a song—"A" is the start point and "B" is the end point—for repeat playback.



**1** Play the song (page 29) and press the [A-B REPEAT] button at the beginning of the section you want to repeat (the "A" point).

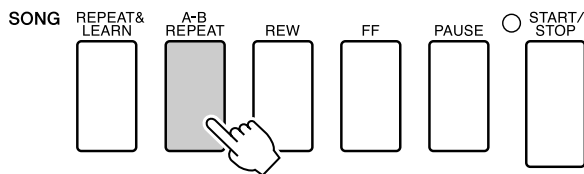

**2** Press the [A-B REPEAT] button a second time at the end of the section you want to repeat (the "B" point).

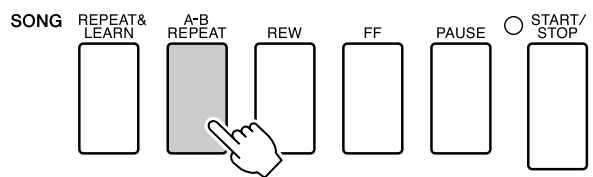

**3** The specified A-B section of the song will now play repeatedly.

You can stop repeat playback at any time by pressing the [A-B REPEAT] button.

**NOTE**

- The repeat start and end points can be specified in one-measure increments.
- The current measure number is shown in the display during playback.
- If you want to set the start point "A" at the very beginning of the song press the [A-B REPEAT] button before starting playback of the song.

Each “track” of a song plays a different part of the song—melody, percussion, accompaniment, etc. You can mute individual tracks and play the muted part on the keyboard yourself, or simply mute tracks other than the ones you want to listen to. Use the SONG MEMORY [1]–[5] and [A] buttons to mute or un-mute the corresponding tracks. The border around the track number in the display disappears when that track is muted. Refer to page 56 for information about the song track configuration.

You can change a song’s melody voice to any other voice you prefer.

**Press the lesson [L] and [R] buttons simultaneously so that “LR” appears in the upper right corner of the MAIN display. Select the song and play it.**

**1 Press the [VOICE] button for longer than a second.**

# Memorize Your Favorite Panel Settings

This instrument has a Registration Memory feature that lets you save your favorite settings for easy recall whenever they're needed. Up to 16 complete setups can be saved (8 banks of two setups each).

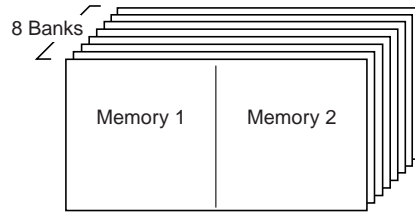

Up to 16 presets (eight banks of two each) can be memorized.

## Saving to the Registration Memory

- 1 Set the panel controls as required—select a voice, accompaniment style, etc.
- 2 Press the [MEMORY/BANK] button. A bank number will appear in the display when you release the button.

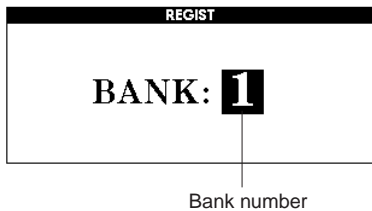
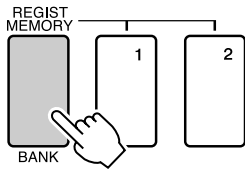

- 3 Use the dial or the [1]–[8] number buttons to select a bank number from 1 to 8.

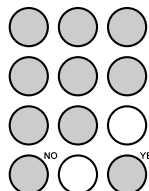
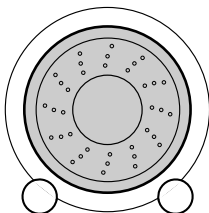

- 4 Press the REGIST MEMORY [1] or [2] button while holding the [MEMORY/BANK] button to store the current panel settings to the specified registration memory.

Press the [EXIT] button to return to the MAIN display in order to check the bank and registration memory numbers.

## Recalling a Registration Memory

- 1 Press the [MEMORY/BANK] button. A bank number will appear in the display when you release the button.

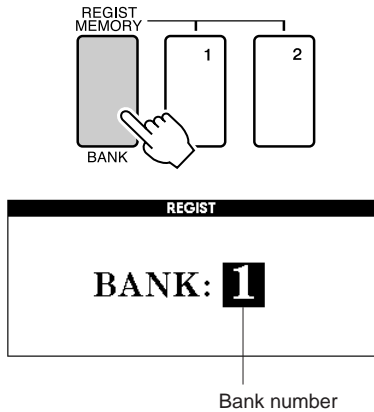

- 2 Use the dial or the [1]–[8] number buttons to select bank you want to recall.

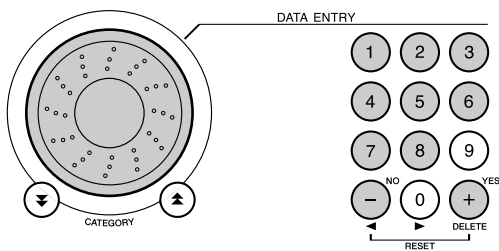

You can check whether the panel settings are stored in registration memory 1 or 2 by pressing the [EXIT] button to return to the MAIN display.

- 3 Press the REGIST MEMORY button, [1] or [2], containing the settings you want to recall. The panel controls will be instantly set accordingly.

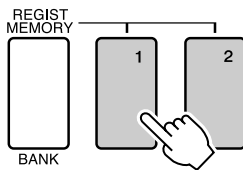

### ● Settings That Can be Saved to the Registration Memory

#### • Style settings\*

Style number, Auto Accompaniment ON/OFF, Split Point, Style settings (Main A/B), Style Volume, Tempo, Chord Fingering

#### • Voice settings

Main Voice setting (Voice number, Volume, Octave, Pan, Reverb Level, Chorus Level), Dual Voice settings (Dual ON/OFF, Voice number, Volume, Octave, Pan, Reverb Level, Chorus Level), Split Voice settings (Split ON/OFF, Voice number, Volume, Octave, Pan, Reverb Level, Chorus Level)

#### • Effect settings

Reverb Type, Chorus Type, Panel Sustain ON/OFF

#### • Harmony settings

Harmony ON/OFF, Harmony Type, Harmony Volume

#### • Other settings

Transpose, Pitch Bend Range

\* Style settings are not available for Registration Memory when using the Song features.

# The Functions

The “Functions” provide access to a range of detailed instrument parameters for tuning, setting the split point, and adjusting the voices and effects. Take a look at the function list starting on the opposite page. There are 46 function parameters in all.

When you locate a function you want to set up, simply select the function’s display name (shown to the right of the function name in the list) and adjust as required.

## Selecting and Setting Functions

**1** Find the function you want to set in the list that begins on page 88.

**2** Press the [FUNCTION] button.

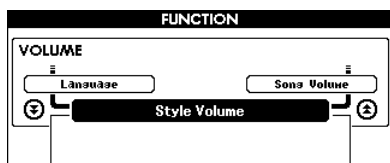
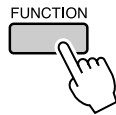

**3** Select a function.

Press the CATEGORY [ $\blacktriangle$ ] and [ $\blacktriangledown$ ] buttons as many times as necessary until the function’s display name appears in the display.

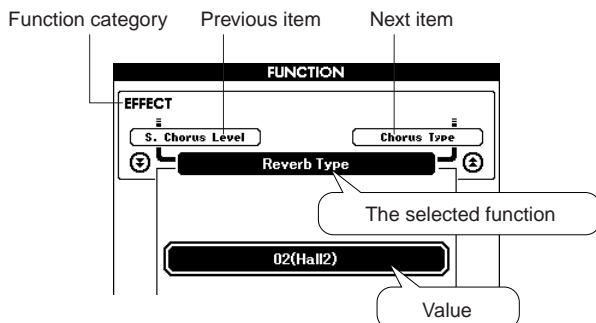
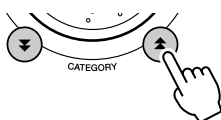

**4** Use the dial, the [+] and [-] buttons, or the [0]–[9] number buttons to set the selected function as required.

The [+] and [-] buttons are used to make ON/OFF type settings: [+] = ON, [-] = OFF. In some cases the [+] button will initiate execution of the selected function, and the [-] will cancel the selection.

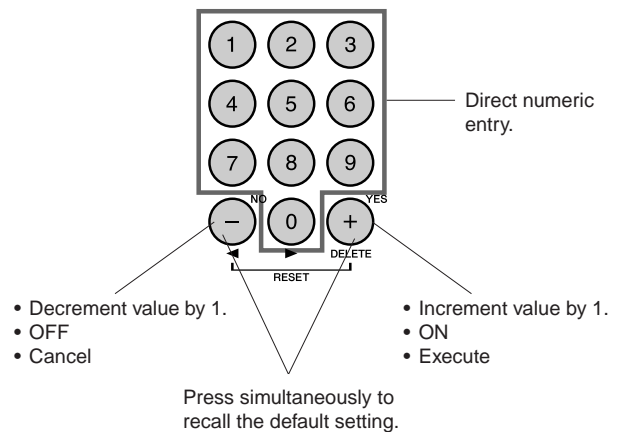

Function settings are stored in memory as soon as they are changed. To restore all initial factor default settings perform the “Backup Clear” procedure described in the “Initialization” section on page 61.

● **Function Setting List**

Category	Function Item	Range/Settings	Description
VOLUME	Style Volume	000–127	Determines the volume of the Style.
	Song Volume	000–127	Determines the volume of the Song.
OVERALL	Transpose	-12→+12	Determines the pitch of the instrument by semitone increments.
	Tuning	-100→+100	Sets the pitch of the instrument's sound in 1-cent increments.
	Pitch Bend Range	01–12	Sets the pitch bend range in semitone increments.
	Split Point	000–127(C-2–G8)	Determines the highest key for the Split voice and sets the Split "point"—in other words, the key that separates the Split (lower) and Main (upper) voices. The Split Point setting and Accompaniment Split Point setting are automatically set to the same value.
	Touch Sensitivity	1(Soft), 2(Medium), 3(Hard), 4(Off)	Determines the sensitivity of the feature.
	Chord Fingering	1(Multi Finger), 2(FullKeyboard)	Sets the chord detection mode. In the Multi Finger mode both normal chords and simple chords played to the left of the split point are detected. In the Full Keyboard mode normal chords played anywhere on the keyboard will be detected, and the notes played will be sound as well.
MAIN VOICE	Main Volume	000–127	Determines the volume of the Main voice.
	Main Octave	-2→+2	Determines the octave range for the Main voice.
	Main Pan	000 (left)–64 (center)–127 (right)	Determines the pan position of the Main voice in the stereo image. The value "0" results in the sound being panned full left; the value "127" results in the sound being panned full right.
	Main Reverb Level	000–127	Determines how much of the Main voice's signal is sent to the Reverb effect.
	Main Chorus Level	000–127	Determines how much of the Main voice's signal is sent to the Chorus effect.
DUAL VOICE	Dual Volume	000–127	Determines the volume of the Dual voice.
	Dual Octave	-2→+2	Determines the octave range for the Dual voice.
	Dual Pan	000 (left)–64 (center)–127 (right)	Determines the pan position of the Dual voice in the stereo image. The value "0" results in the sound being panned full left; the value "127" results in the sound being panned full right.
	Dual Reverb Level	000–127	Determines how much of the Dual voice's signal is sent to the Reverb effect.
	Dual Chorus Level	000–127	Determines how much of the Dual voice's signal is sent to the Chorus effect.
SPLIT VOICE	Split Volume	000–127	Determines the volume of the Split voice.
	Split Octave	-2→+2	Determines the octave range for the Split voice.
	Split Pan	000 (left)–64 (center)–127 (right)	Determines the pan position of the Split voice in the stereo image. The value "0" results in the sound being panned full left; the value "127" results in the sound being panned full right.
	Split Reverb Level	000–127	Determines how much of the Split voice's signal is sent to the Reverb effect.
	Split Chorus Level	000–127	Determines how much of the Split voice's signal is sent to the Chorus effect.
EFFECT	Reverb Type	01–10	Determines the Reverb type, including off (10). (See the list on page 133)
	Chorus Type	1–5	Determines the Chorus type, including off (05). (See the list on page 133)
	Sustain	ON/OFF	Determines whether or not panel sustain is always applied to the MAIN/ DUAL voices. Panel sustain is applied continuously when ON, or not applied when OFF. (page 69)
	Master EQ Type	1(Speaker 1), 2(Speaker 2), 3(Headphones), 4(Line Out 1), 5(Line Out 2)	Sets the equalizer applied to the speaker output for optimum sound in different listening situations.



Category	Function Item	Range/Settings	Description
HARMONY	Harmony Type	01–26	Determines the Harmony type. (See the list on page 133)
	Harmony Volume	000–127	Determines the volume of the Harmony effect.
PAT	P.A.T. Type	CHORD, CHORD/FREE, MELODY, CHORD/MELODY	Determines the performance assistant technology feature type. (See the list on page 35)
PC	PC Mode	PC1/PC2/OFF	Optimizes the MIDI settings when you connect to a computer (page 100).
MIDI	Local	ON/OFF	Determines whether the instrument's keyboard controls the internal tone generator (ON) or not (OFF). (page 100)
	External Clock	ON/OFF	Determines whether the instrument synchronizes to the internal clock (OFF) or an external clock (ON). (page 100)
	Keyboard Out	ON/OFF	Determines whether keyboard performance data of the instrument is transmitted (ON) or not (OFF).
	Style Out	ON/OFF	Determines whether Style data is transmitted (ON) via USB or not (OFF) during Style playback.
	Song Out	ON/OFF	Determines whether Song data is transmitted (ON) via USB or not (OFF) during Song playback.
	Initial Setup	YES/NO	Lets you send the data of the panel settings to a computer. Press [+] to send, or press [-] to cancel.
METRONOME	Time Signature - Numerator	00–60	Determines the time signature of the Metronome.
	Time Signature - Denominator	2, 4, 8, 16	Sets the length of each metronome beat.
	Metronome Volume	000–127	Determines the volume of the Metronome.
SCORE	Quantize	1(1/4 note), 2(1/4 note triplet), 3(1/8 note), 4(1/8 note triplet), 5(1/16 note), 6(1/16 note triplet), 7(1/32 note), 8(1/32 note triplet)	Depending on the song data, you can make the score more readable by adjusting the timing of the notes. This determines the minimum timing resolution used in the song. For example, if there are both quarter notes and eighth notes in the song, you should set this value to "eighth note". Any notes or rests shorter than this value will not be shown in the score.
LESSON	Right-Part	GuideTrack 1–16	Determines the guide track number for your right hand lesson. The setting is only effective for songs in SMF format 0 transferred from a computer.
	Left-Part	GuideTrack 1–16	Determines the guide track number for your left hand lesson. The setting is only effective for songs in SMF format 0 transferred from a computer.
	Grade	ON/OFF	Determines whether the Grade function is on or off.
UTILITY	Demo Cancel	ON/OFF	Determines whether Demo cancel is enabled or not. When this is set to ON, the Demo Song will not play, even if the [DEMO] button is pressed.
LANGUAGE	Language	English/Japanese	Determines the display language for the demo displays, song file names, lyrics and certain display messages. All other messages and names are displayed in English. When this is set to Japanese, the file names are displayed in the Japanese font. The lyrics display follows the language setting originally made in the song data; however, when no such setting exists, the setting here is used.

\* All these settings can be conveniently reset to their initial default values by pressing the [+] and [-] buttons simultaneously. (The exception to this is Initial Send, which is an operation, not a setting.)



# Using USB Flash Memory

USB flash memory is a memory medium used for storing data.

When a USB flash memory is inserted in this instrument's USB TO DEVICE terminal, user songs created on the instrument and the registered settings can be saved to or loaded from the memory medium. USB flash memory can also be used to transfer song data downloaded from the Internet to the instrument, where it can be used with the performance assistant technology (page 35) and Lesson (page 47) features described in the Quick Guide. Furthermore, user songs saved to USB flash memory in MIDI file format can also be used with these features.

In this section we'll look at the procedures for setting up and formatting USB flash memory devices, as well as for saving and loading data to and from them.

If you don't have a USB flash memory, you will need to purchase one (or more, as needed).

The instrument does not necessarily support all commercially available USB storage devices. Yamaha cannot guarantee operation of USB storage devices that you purchase. Before purchasing USB storage devices, please consult your Yamaha dealer, or an authorized Yamaha distributor (see list at end of the Owner's Manual) for advice.

## USB Flash Memory

Before using a USB device, read through the "Precautions when using the USB TO DEVICE terminal" section on page 99. For information about USB devices compatible with the instrument, see "Connection to a USB Storage Device" on page 97.

### ● To protect your data (write-protect switch)

Some USB flash memory devices are equipped with a write-protect switch. To prevent accidental erasure of important data saved in USB flash memory, slide the write-protect switch on the device to the "protect" position. When saving data, make sure that the write-protect switch is set to the "overwrite" position.

## Connecting a USB

- 1 Connect a USB flash drive to the **USB TO DEVICE** terminal on the front panel. To insert it with the

TO DEVICE USB

## Formatting USB Flash Memory

New USB flash memory must be formatted before they can be used by this instrument.

**CAUTION**

- If you format a USB flash memory that already contains data, all of the data will be erased. Be careful not to erase important data when using the format function.

**1** After connecting the USB flash memory to be formatted to the instrument's USB TO DEVICE terminal, check that the icon is showing in the MAIN display.

**2** Press the FILE CONTROL [MENU] button.

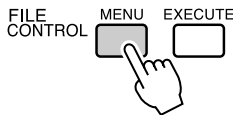

**3** Use the CATEGORY [▲] and [▼] buttons to select the Format item.

The display prompts you for confirmation.

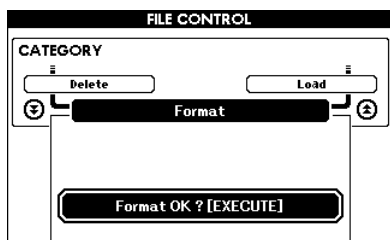
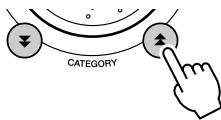

**4** Press the [EXECUTE] button and the display prompts you for confirmation.

You can press the [-] button at this point to cancel the operation.

**5** Press the [EXECUTE] button again, or the [+] button, and the format operation will begin.

**CAUTION**

- Once the format-in-progress message appears on the display the format operation cannot be canceled. Never turn off the power or remove the USB flash memory during this operation.

**6** A message will appear on the display to inform you that the operation has finished.

Press the [EXIT] button to return to the MAIN display.

**NOTE**

- If the USB flash memory has been write-protected, an appropriate message will appear on the display and you will not be able to execute the operation.

...s the [DELETE] button  
...n and below the first  
... the file name.

## **5** Change the file name as necessary

- The [-] button moves the cursor to the left, and the [0] button moves it to the right.
- Use the dial to select a character for the current cursor location.
- The [+] button deletes the character at the cursor location.

## Convert a User Song to SMF Format and Save

This operation converts a user song (song numbers 031–035) to SMF Format 0 and saves the file to USB flash memory.

### ● What is SMF (Standard MIDI File)?

The SMF (Standard MIDI File) format is one of the most common and widely compatible sequence formats used for storing sequence data. There are two variations: Format 0 and Format 1. A large number of MIDI devices are compatible with SMF Format 0, and most commercially available MIDI sequence data is provided in SMF Format 0.

**1** Make sure that a properly formatted USB flash memory has been properly connected to the instrument's **USB TO DEVICE** terminal, and that the icon is showing in the **MAIN** display.

**2** Press the **FILE CONTROL [MENU]** button.

**3** Use the **CATEGORY [▲]** and **[▼]** buttons to locate the **SMF Save** item.

The **SOURCE FILE**—a user song name—will be highlighted.

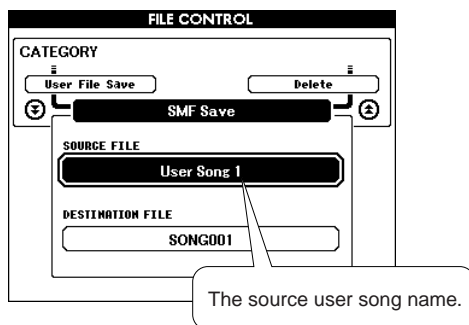
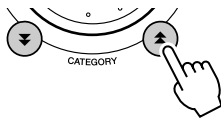

**4** Select the source user song.

You can press the **[+]** and **[-]** buttons simultaneously to select the first user song.

**5** Press the **[EXECUTE]** button.

The **DESTINATION SONG** will be highlighted, and a default name will appear for the converted song file.

### ● To Overwrite an Existing File

If you want to overwrite a file that already exists on the USB flash memory, use the dial or the **[+]** and **[-]** buttons to select the file, then skip ahead to step 7.

**6** Press the **[EXECUTE]** button.

A cursor will appear below the first character in the file name.

**7** Change the file name as necessary.

Refer to “Saving Data” on page 93 for filename entry.

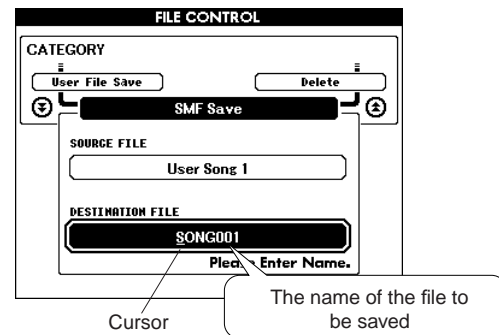

**8** Press the **[EXECUTE]** button. The display prompts you for confirmation.

You can cancel the save operation at this point by pressing the **[-]** button.

**9** Press the **[EXECUTE]** button again, or the **[+]** button, and the save operation will begin.

The user song will be stored to the **USER FILE** folder in the USB flash memory.

### ⚠ CAUTION

- Once the save-in-progress message appears on the display the operation cannot be canceled. Never turn off the power or remove the USB flash memory during this operation.

**10** A message will appear on the display to inform you that the operation has finished.

Press the **[EXIT]** button to return to the **MAIN** display.

### NOTE

- If an existing filename is specified the display prompts you for confirmation. Press **[EXECUTE]** or **[+]** if it is OK to overwrite the file, or **[-]** to cancel.
- The amount of time it will take to perform the save operation will depend on the condition of the USB flash memory.

## Loading User Files and Style Files

User files, style files, and styles residing on a USB flash memory can be loaded into the instrument. If the required style file has already been transferred to the instrument from a computer using the Musicsoft Downloader application, start from step 2, below. Refer to “Transferring Performance Data to and from a Computer” on page 100 for details on transferring style files.

### **⚠ CAUTION**

- If you load a User File user song (031–035), style file, and registration memory data will be overwritten by the newly loaded data. If you only load a style file, only the style file will be overwritten. Save important data to a USB flash memory before loading data that will overwrite it.

- 1** With the USB flash memory containing the file you want to load connected to the USB TO DEVICE connector, check that the File Control icon is shown in the MAIN display.
- 2** Press the FILE CONTROL [MENU] button.
- 3** Use the CATEGORY [▲] and [▼] buttons to locate the Load item.

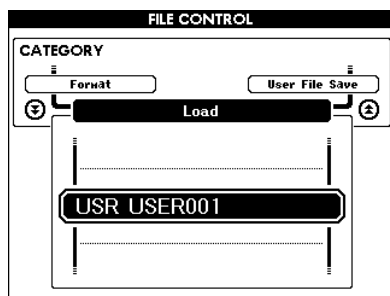
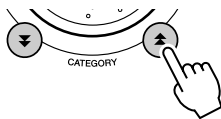

- 4** Use the dial to select the user file or style file you want to load.

All user files in the USB flash memory will be displayed first, followed by the style files.

### **NOTE**

- Style files must be located in the root directory. Style files located within folders will not be recognized.

- 5** Press the [EXECUTE] button. The display prompts you for confirmation.

You can cancel the load operation at this point by pressing the [-] button.

- 6** Press the [EXECUTE] button again, or the [+] button, and the load operation will begin.

### **⚠ CAUTION**

- Once the load-in-progress message appears on the display the operation cannot be canceled. Never turn off the power or remove the USB flash memory during this operation.

- 7** A message will appear on the display to inform you that the operation has finished.

Press the [EXIT] button to return to the MAIN display.

## Deleting Data from a USB Flash Memory

This procedure deletes user file and SMF file from a USB flash memory.

- 1** Make sure that the USB flash memory containing the file(s) you want to delete has been properly connected to the instrument's USB TO DEVICE terminal, and that the icon is showing in the MAIN display.
- 2** Press the FILE CONTROL [MENU] button.
- 3** Use the CATEGORY [▲] and [▼] buttons to locate the Delete item.

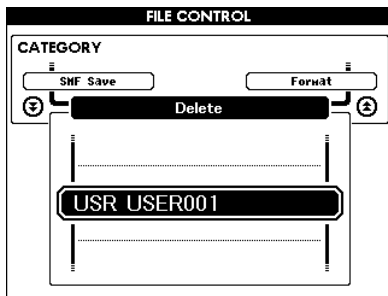
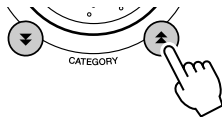

- 4** Select the file you want to delete.

You can press the [+] and [-] buttons simultaneously to select the first song or user file on the USB flash memory.

- 5** Press the [EXECUTE] button. The display prompts you for confirmation.

You can cancel the delete operation at this point by pressing the [-] button.

- 6** Press the [EXECUTE] button again, or the [+] button, and the delete operation will begin.

### CAUTION

- Once the delete-in-progress message appears on the display the operation cannot be canceled. Never turn off the power or remove the USB flash memory during this operation.

- 7** A message will appear on the display to inform you that the operation has finished.

Press the [EXIT] button to return to the MAIN display.

### NOTE

- If the USB flash memory has been write-protected, an appropriate message will appear on the display and you will not be able to execute the operation.

## Playing Songs Saved to USB Flash Memory

- 1** Make sure that the USB flash memory containing the song you want to play has been properly connected to the instrument's USB TO DEVICE terminal, and that the icon is showing in the MAIN display.
- 2** Press the [SONG] button.

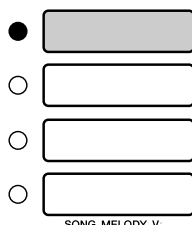

- 3** Use the dial to select the song you want to play (036-).
- 4** Press the [START/STOP] button.



## Connectors

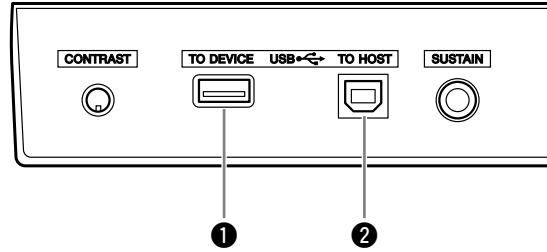

### 1 USB TO DEVICE terminal

This terminal allows connection to USB storage devices. Refer to “Connection to a USB Storage Device” on page 97.

### 2 USB TO HOST terminal

This terminal allows direct connection to a personal computer. Refer to “Connecting a Personal Computer” on page 99 for more information.

## Connection to a USB Storage Device

By connecting the instrument to a USB storage device with a standard USB cable, you can save data you’ve created to the connected device, as well as read data from the connected device.

### Compatible USB storage devices.....

A USB storage device, such as a floppy disk drive, hard disk drive, CD-ROM drive, flash memory, reader/writer, etc., can be connected to the USB TO DEVICE terminal. Other USB devices such as a computer keyboard or mouse cannot be used.

Before purchasing USB storage devices, please consult your Yamaha dealer, or an authorized Yamaha distributor (see list at end of the Owner’s Manual) for advice.

#### CAUTION

- Avoid frequently turning the power on/off to the USB storage device, or connecting/disconnecting the cable too often. Doing so may result in the operation of the instrument “freezing” or hanging up. While the instrument is accessing data (such as in the Save and Delete operations), do NOT unplug the USB cable, do NOT remove the media from the device, and do NOT turn the power off to either device. Doing so may corrupt the data on either or both devices.

### Connection to a USB storage device .....

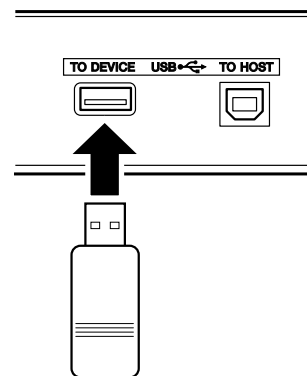

#### CAUTION

- Some USB memory devices may require more current than the instrument can supply, causing the instrument’s over-current protection function to be activated and making it impossible to use the device. If this occurs “OverCurrent” will appear in the upper area of the MAIN display. To restore normal operation remove the USB device from the USB TO DEVICE connector and turn the instrument’s power off and then back on again.

### Backing up the instrument data to a computer

Once you've saved data to a USB storage device, you can copy the data to the hard disk of your computer, then archive and organize the files as desired. Simply reconnect the device as shown below.

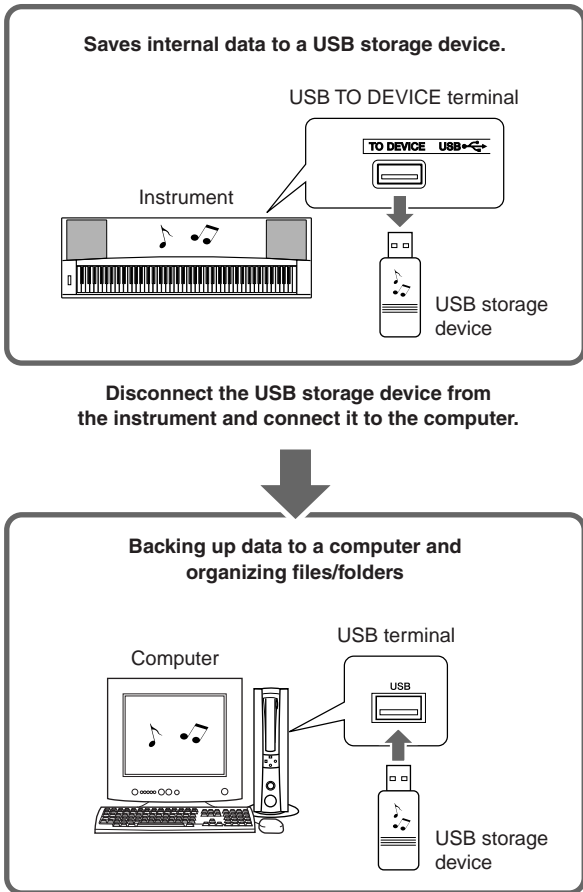

### Copying files from a computer hard disk to a USB storage device

Files on a computer's hard disk can be transferred to the instrument by first copying them to the storage media, then connecting/inserting the media to the instrument. User files, style files and MIDI songs can be copied to a USB storage device from the hard disk of the computer. Once you've copied the data, connect the device to the USB TO DEVICE terminal of the instrument and play back the MIDI songs, or load the user file or style file on the instrument.

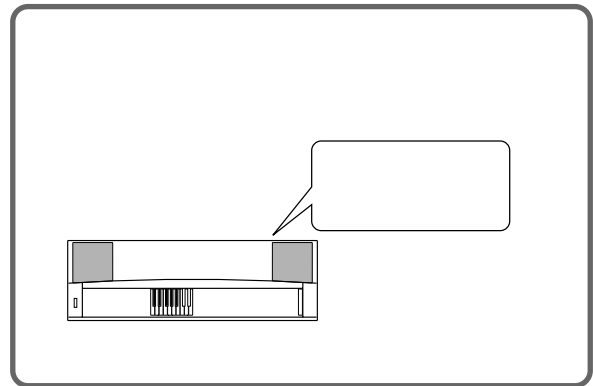
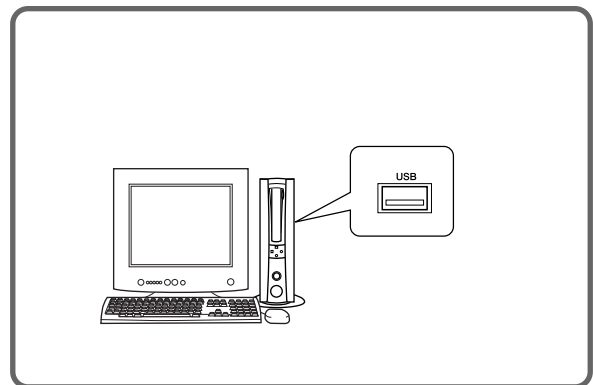

## Connecting a Personal Computer

The following functions become available when this instrument is connected to a computer.

- Performance data can be transferred between the instrument and the computer (page 100).
- Files can be transferred between the instrument and the computer (page 102).

The connection procedure is as follows:

### 1 Install the USB-MIDI driver on your computer.

The USB-MIDI driver is included on the CD-ROM. Installation of the USB MIDI driver is described on pages 108–109.

### 2 Connect the USB terminal of the computer to the USB terminal on the instrument using a standard USB cable (USB cable sold separately).

The supplied CD-ROM also includes a Musicsoft Downloader application that allows you to transfer song files from your computer to the instrument's flash memory. For instructions about how to install Musicsoft Downloader and how to transfer song files, see pages 102, 109.

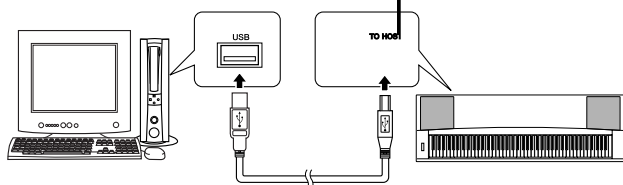

### ■ USB Precautions

Please observe the following precautions when connecting the instrument to a computer via a USB cable.

Failure to do so can cause the instrument and/or the computer to hang up (freeze), possibly causing corruption or loss of data.

If the instrument or computer does hang up, turn the power to both devices off and then on again, and restart the computer.

## Transferring Performance Data to and from a Computer

By connecting the instrument to a computer, the instrument's performance data can be used on the computer, and performance data from the computer can be played on the instrument.

- When the instrument is connected with computer, it transmits/receives performance data.

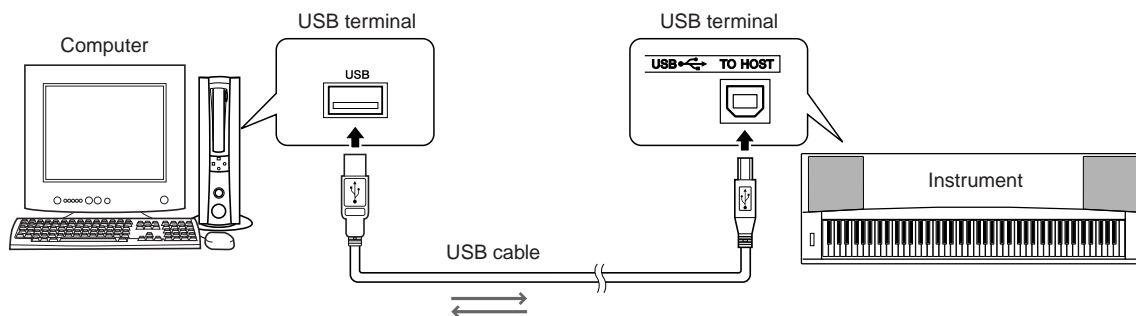

## MIDI settings .....

These settings pertain to performance data transmission and reception.

Item	Range/Settings	Description
Local	ON/OFF	Local control determines whether or not notes played on the instrument are sounded by its internal tone generator system: the internal tone generator is active when local control is on, and inactive when local control is off.
External Clock	ON/OFF	These settings determine whether the instrument is synchronized to its own internal clock (OFF), or to a clock signal from an external device (ON).
Keyboard Out	ON/OFF	These settings determine whether keyboard performance data of the instrument is transmitted (ON) or not (OFF).
Style Out	ON/OFF	These settings determine whether Style data is transmitted (ON) or not (OFF) during Style playback.
Song Out	ON/OFF	These settings determine whether Song data is transmitted (ON) or not (OFF) during Song playback.

**CAUTION**

- If you can't get any sound out of the instrument, this may be the most likely cause.

**CAUTION**

- If External Clock is ON and no clock signal is being received from an external device, the song, style, and metronome functions will not start.

**1** Press the [FUNCTION] button.

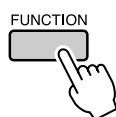

**2** Use the CATEGORY [▲] and [▼] buttons to select the item you want to change its value.

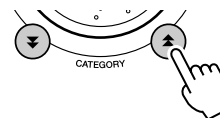

**3** Use the dial to select ON or OFF.

## ■ PC Mode .....

A number of MIDI settings need to be made when you want to transfer performance data between the computer and the instrument. The PC Mode item can conveniently make multiple settings for you in one operation. Three settings are available: PC1, PC2, and OFF.

This setting is not necessary when transferring song or backup files between the computer and the instrument.

\* Set the PC mode to PC2 when using Digital Music Notebook.

	PC1	PC2*	OFF
Local	OFF	OFF	ON
External Clock	ON	OFF	OFF
Song Out	OFF	OFF	OFF
Style Out	OFF	OFF	OFF
Keyboard Out	OFF	ON	ON

**1** Press and hold the [DEMO] button for longer than a second so that the PC Mode item appears.

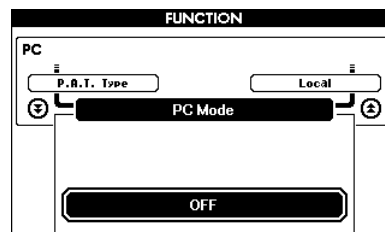
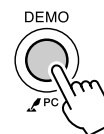

**2** Use the dial to select PC1, PC2, or OFF.

**NOTE**

- When the PC2 setting is selected the instrument's style, song, demo, song recording, and lesson features cannot be used.

**NOTE**

- You can also access the PC Mode item by first pressing the [FUNCTION] button and then using the CATEGORY [▲] and [▼] buttons to locate it (page 87).

## Remote Control of MIDI Devices

You can also use this instrument as a remote control device for the Digital Music Notebook application on your computer (via the USB connection)—controlling playback, stop and transport functions from the panel.

## ■ Remote control keys .....

To use the remote control functions, simultaneously hold down the lowest two keys on the keyboard (A-1 and A#-1) and press the appropriate key (shown below).

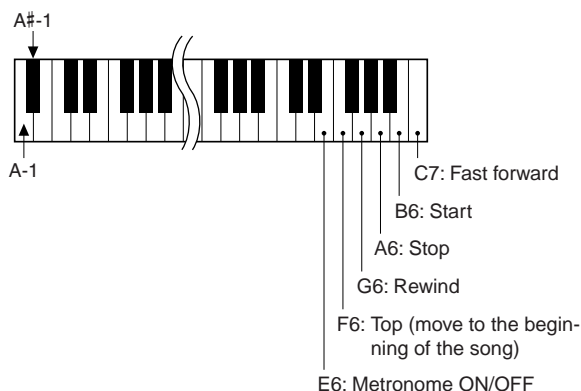

**NOTE**

- Remote control of MIDI devices will function independently of the PC2 mode.

## Initial Send

This function lets you send the data you record performance data to a software application. You can send the data to a computer for the first time and record the panel settings before the actual performance.

Press the [FUNCTION] button, then the [SEND] button. Press [+ / YES] to send, or press [- / NO] to cancel.

OR Press the [FUNCTION] button, then the [SEND] button. Press [+ / YES] buttons to send, or press [- / NO] buttons to cancel.

## Music on the Accessory CD-ROM

You can transfer MIDI songs you have downloaded from the Internet or created on your computer from the computer to the instrument's flash memory.

⇒ refer to the procedure described on page 103.

The procedure for transferring songs included on the Accessory CD-ROM from your computer to the instrument is given as an example.

- Backup file can be transferred from the instrument to a computer and back.

⇒ refer to the procedure described on page 104.

## ■ Use Musicsoft Downloader To Transfer Songs From the Accessory CD-ROM To the Instrument's flash memory.....

**NOTE**

• If a song or style is being played, stop playback before proceeding.

**1** Install the Musicsoft Downloader and USB MIDI driver to your computer, then connect the computer and the instrument (page 107).

**2** Insert the included CD-ROM into the CD-ROM drive.

A start window will appear automatically.

**3** Double-click the Musicsoft Downloader shortcut icon that is created on the desktop.

This will launch the Musicsoft Downloader application and the main window will appear.

**NOTE**

• The instrument cannot be operated while the Musicsoft Downloader is running.

**4** Click the “Add File” button and the Add File window will appear.

**5** Click the button to the right of “Look in” and select the CD-ROM drive from the drop-down menu that appears. Double-click the “SongData” Folder on the window. Select the file you want to transfer to the instrument, and click “Open”.

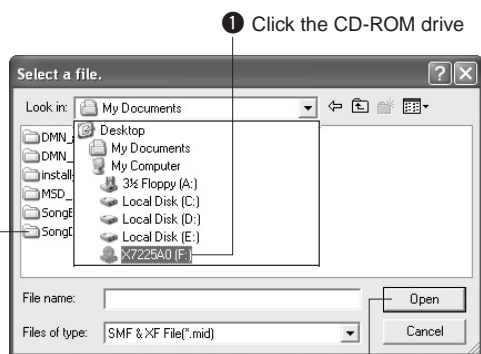

**2** Double-click the “SongData” Folder and click a song file.

**3** Click “Open”

**6** A copy of the selected MIDI song file will appear in the “List of files stored temporarily” at the top of the window.

The memory medium will also be displayed at the bottom of the window to specify the destination for the transfer. Click “Instrument”, and then “Flash memory”.

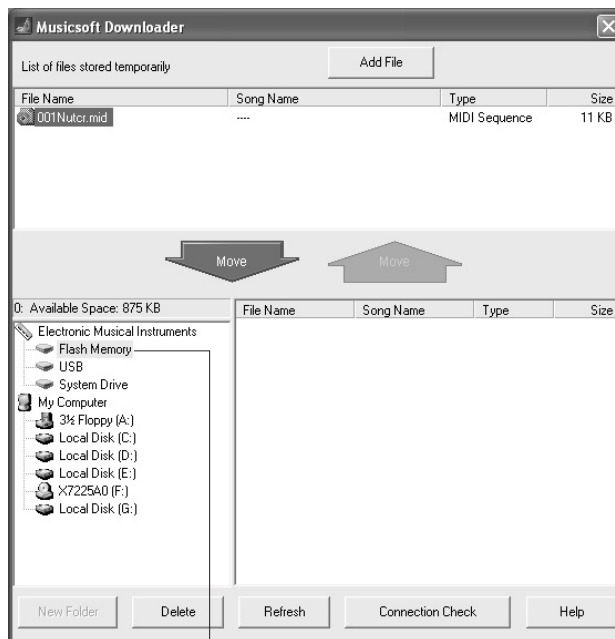

**1** Click “Instrument”, and then “Flash Memory”

**7** After selecting the file in the “List of files stored temporarily”, click the downward [Move] button and a confirmation message will appear. Click [OK] and the song will be transferred from the “List of files stored temporarily” to the instrument’s memory.

**8** Close the window to end the Musicsoft Downloader.

**NOTE**

• End the Musicsoft Downloader to playback the song transferred from your computer.

- 9** To playback a song stored in flash memory, press the [SONG] button. Use the dial to select the song you want to play, then press the [START/STOP] button to start playback.

Style files (files with the “.STY” extension) can be transferred to Flash memory using the same procedure as described above. Style files transferred to the Flash Memory can be loaded into style number 151 and then played (pages 81, 103).

**⚠ CAUTION**

- Do not unplug the USB cable during a data transfer. Not only will the data not be transferred and saved, but operation of the memory media may become unstable and its contents may disappear completely when the power is turned on or off.

**⚠ CAUTION**

- Store data can be lost due to equipment malfunction or improper operation. For safety we recommend that you keep a copy of all important data stored on your computer.

**● To Use transferred Songs For Lessons...**

In order to use songs (only SMF format 0) transferred from a computer for lessons it is necessary to specify which channels are to be played back as the right-hand and left-hand parts.

- 1 Press the [SONG] button and select the song (036–) residing in flash memory for which you want to set the guide track.
- 2 Press the [FUNCTION] button.
- 3 Use the CATEGORY [**▲**] and [**▼**] buttons to select the R-Part or L-Part item.
- 4 Use the dial to select the channel you want to play back as the specified right- or left-hand part.

We recommend that you select channel 1 for the right-hand part and channel 2 for the left-hand part.

**■ Transfer a Backup file from the instrument to a computer . . .**

You can use the Musicsoft Downloader to transfer “Backup file” containing backup data (page 61), including the five User Songs stored on the instrument, to a computer. If you click “Electronic Musical Instruments” in the Musicsoft Downloader display, and then “System Drive”, a file named “06PG88.BUP” will appear in the lower right corner of the Musicsoft Downloader display. This is the backup file. For details about how to transfer backup files using the Musicsoft Downloader application, refer to the Online help in the application.

**NOTE**

- Preset Song data cannot be transmitted from the instrument.

**⚠ CAUTION**

- The backup data, including the five User Songs’ is transmitted/received as a single file. As a result, all backup data will be overwritten every time you transmit or receive. Keep this in mind when transferring data.

**⚠ CAUTION**

- Do not rename the backup file on the computer. If you do so it will not be recognized when transferred to the instrument.





# Accessory CD-ROM Installation Guide

## SPECIAL NOTICES

- ⚠** This CD-ROM is copy-protected. Yamaha makes no representations or warranties with regard to any problems while attempting to copy the CD-ROM or software and cannot be held responsible for the results of attempts to copy the data.
- The software and this owner's manual are the exclusive copyrights of Yamaha Corporation.
  - Use of the software and this manual is governed by the license agreement which the purchaser fully agrees to upon breaking the seal of the software packaging. (Please read carefully the Software Licensing Agreement at the end of this manual before installing the application.)
  - Copying of the software or reproduction of this manual in whole or in part by any means is expressly forbidden without the written consent of the manufacturer.
  - Yamaha makes no representations or warranties with regard to the use of the software and documentation and cannot be held responsible for the results of the use of this manual and the software.
  - This disk is a CD-ROM. Do not attempt to play the disk on an audio CD player. Doing so may result in irreparable damage to your audio CD player.
  - Future upgrades of application and system software and any changes in specifications and functions will be announced separately.
  - The screen displays as illustrated in this owner's manual are for instructional purposes, and may appear somewhat different from the screens which appear on your computer.

## Important Notices about the CD-ROM

### ● Data Types

This CD-ROM includes application software. Please refer to page 107 for software installation instructions.

#### **⚠ CAUTION**

- *Do not attempt to play this CD-ROM on an audio CD player. The result high-volume noise can potentially cause hearing damage or damage your CD player and speakers.*

### ● Operating System (OS)

The applications in this CD-ROM are provided in versions for Windows operating systems.

## CD-ROM Contents



Folder Name	Application / Data Name	Contents
① MSD_	Musicsoft Downloader	This application can be used to download MIDI song data from the Internet and transfer it from the computer to the instrument's memory.
②	DMN_FlashDemo	Flash Demo Digital Music Notebook is an educational content that lets you enjoy music while learning. Full motion demo software which introduces all features of the Digital Music Notebook.
	DMN_DemoSong	Demo Song You can experience Digital Music Notebook functions with the demo song. You need to download and install Digital Music Notebook on your computer prior to using the demo song.
③	SongBook	Song Book Includes score data for the 30 internal songs provided on the instrument as well as 70 MIDI songs provided on the CD-ROM. The exceptions are songs 1–11, 16, 20 and song 30 which is copyrighted. The scores for songs 9–11 are provided in this manual beginning on page 118.
④	USB-MIDI Driver (Windows 98/Me)	This driver software is necessary to connect MIDI devices to your computer via USB.
	USBdrv2k	
	SongData	MIDI 70 songs These songs can be transferred to the instrument and played or used with the instrument's functions.
	StyleData	5 style files These styles can be transferred to the instrument and played or used with the instrument's functions.

In order to view PDF scores, you will need to install Adobe Reader in your computer. You can download the Adobe Reader. Please check the following URL: <http://www.adobe.com/>

### ■ Using the CD-ROM .....

Please read the Software License Agreement on page 111 before opening the CD-ROM package.

- 1 Check the system requirements to make sure that the software will run on your computer.**
- 2 Insert the included CD-ROM into the CD-ROM drive.**  
The start window should appear automatically.
- 3 Install the USB MIDI driver to the computer.**  
Refer to “Installing the USB-MIDI Driver” on page 107 for installation and setup instructions.

### **4 Connect the instrument to the computer.**

The connection procedure is described on page 99.

### **5 Install the software.**

Musicsoft Downloader:  
See page 109.

### **6 Launch the software.**

For further software operation refer to the online help supplied with the software.

Refer to the “Troubleshooting” on page 110 when you have trouble with installing the driver.

## System Requirements

Application/Data	OS	CPU	Memory	Hard Disk	Display
Musicsoft Downloader	Windows 98SE/Me/2000/XP Home Edition/XP Professional	233 MHz or higher; Intel® Pentium®/Celeron® processor family	64 MB or more (256 MB or more is recommended)	at least 128 MB of free space (at least 512 MB of free space is recommended)	800 x 600 HighColor (16-bit)
USB Driver for Windows 98/Me	Windows 98/Me	166 MHz or higher; Intel® Pentium®/Celeron® processor family	32 MB or more (64 MB or more is recommended)	at least 2 MB of free space	—
USB Driver for Windows 2000/XP	Windows 2000/XP Home Edition/XP Professional				
Digital Music Notebook	Windows® XP Professional Edition, SP1a more	400MHz or higher; Intel® Pentium®/Celeron® Processor family (1GHz or more is recommended)	128 MB or more (256 MB or more is recommended)	at least 50 MB of free space	1024 x 768 HighColor (16-bit)
Digital Music Notebook (Requirements for playing content with video included.)	Windows® XP Home Edition, SP1a more Windows 2000 Professional, SP4 more	1GHz or higher; Intel® Pentium®/Celeron® Processor family (1.4GHz or more is recommended)	256 MB or more		

## Software Installation

### ● Uninstall (Removing the Software)

Installed software can be removed from your computer as follows:  
 From the Windows Start menu select Start → Settings → Control panel → Add or Remove Applications → Install and Uninstall. Select the item you want to remove and click [Add or Remove]. Follow the on-screen instructions to remove the selected software.

**NOTE**

• The actual names of the menu items and buttons will depend on the OS version you are using.

### ■ Installing the USB-MIDI Driver....

In order to be able to communicate with and use MIDI devices connected to your computer, the appropriate driver software must be properly installed on your computer.  
 The USB-MIDI driver allows sequence software and similar applications on your computer to transmit and receive MIDI data to and from MIDI devices via a USB cable.

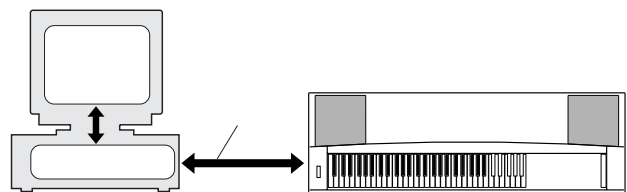

- Windows 98/Me installation → page 108.
- Windows 2000 installation → page 108.
- Windows XP installation → page 109.

Check the drive name of the CD-ROM drive you will be using (D:, E:, Q: etc.) The drive name is displayed beside the CD-ROM icon in your “My Computer” folder. The root directory of the CD-ROM drive will be D:\ , E:\ , or Q:\ , respectively.

**Installing the driver on Windows 98/Me**

- 1** Start the computer.
- 2** Insert the supplied CD-ROM into the CD-ROM drive. A start window will appear automatically.
- 3** First, make sure the POWER switch on the instrument is set to OFF, then use a USB cable to connect the USB terminal of the computer to the USB connector of the instrument. When the instrument is turned on, the computer automatically displays the “Add New Hardware Wizard. Otherwise, refer to “Troubleshooting” in the “Accessory CD-ROM Installation Guide” section of the Owner’s Manual.

For Windows Me users, check the radio button to the left of “Automatic search for a better driver (Recommended)” and click [Next]. The system automatically starts searching and installing the driver. Proceed to Step 8. If the system does not detect the driver, select “Specify the location of the driver (Advanced)” and specify the CD-ROM drive’s root directory to install the driver and click [Next]. Execute the installation by following the onscreen instructions and proceed to Step 8.

**NOTE**

• If you are using Windows Me, skip Step 4–7.

- 4** Click [Next].  
The window enables you to select the search method.
- 5** Check the radio button to the left of “Search for the best driver for your device. (Recommended)”. Click [Next].  
The window enables you to select a location in which to install the driver.
- 6** Check the “Specify a location” box, click “Browse..”, then specify the root directory of the CD-ROM drive and continue the installation. The CD-ROM drive letter may vary depending on your computer’s configuration.
- 7** When the system detects the driver on the CD-ROM and is ready for installation, it is shown as a message on the screen. Make sure that the “YAMAHA USB MIDI Driver” is listed, and click [Next]. The system starts the installation.
- 8** When installation is complete, a message indicating so appears. Click [Finish].  
The driver has been installed.

**NOTE**

• Some computers may take about ten seconds to show this screen after the installation is complete.

**Installing the driver on Windows 2000**

- 1** Start the computer and use the “Administrator” account to log into Windows 2000.
- 2** Select [My Computer] → [Control Panel] → [System] → [Hardware] → [Driver Signing] → [File Signature Verification], and check the radio button to the left of “Ignore—Install all files, regardless of file signature” and click [OK].
- 3** Insert the supplied CD-ROM into the CD-ROM drive. A start window will appear automatically.
- 4** First, make sure the POWER switch on the MIDI device is set to OFF, then use a USB cable to connect the MIDI device to the computer. After making the connections, turn on the power of the MIDI device. The system automatically launches the Found New Hardware Wizard.  
Otherwise, refer to “Troubleshooting” in the “Accessory CD-ROM Installation Guide” section of the Owner’s Manual. Click [Next]. (Some computers may take a while to display the Wizard window.)
- 5** Select the radio button for “Search for a suitable driver for my device [recommended]”, then click [Next].

**NOTE**

• If the Wizard panel informs you that “The software you are about to install does not contain a Microsoft digital signature”, click [Yes].

- 6** Check the “CD-ROM drives” check box, deselect all other check boxes, then click [Next].

**NOTE**

• If the system prompts you to insert the Windows CD-ROM during detection of the drivers, point to the “USBdrv2k\_” folder (e.g., D:\USBdrv2k\_) and continue the installation.

- 7** Deselect the “Install one of the other drivers”, then click [Next].
- 8** When the installation is complete, the Wizard displays “Completing the Found New Hardware Wizard”.  
Click [Finish]. (Some computers may take a while to display the Wizard window.)
- 9** Restart the computer.  
The USB-MIDI driver installation is complete.

## Installing the driver on Windows XP

- 1** Start the computer and use the “Administrator” account to log into Windows.
- 2** Select [Start] → [Control Panel]. If the control panel appears as “Pick a category”, click “Switch to Classic View” in the upper left of the window. All control panels and icons will be displayed.
- 3** Go to [System] → [Hardware] → [Driver Signing Options] and check the radio button to the left of “Ignore” and click [OK].
- 4** Click the [OK] button to close System Properties, and then click “X” in the upper right of the window to close the Control Panel.
- 5** Insert the supplied CD-ROM into the CD-ROM drive. A start window will appear automatically.
- 6** First, make sure the POWER switch on the MIDI device is set to OFF, then use a USB cable to connect the MIDI device to the computer. After making the connections, turn on the power of the MIDI device. The system launches the Found New Hardware Wizard automatically. Otherwise, refer to “Troubleshooting” in the “Accessory CD-ROM Installation Guide” section of the Owner’s Manual. If the system displays “Found New Hardware” in the lower right corner, wait until Wizard window is displayed. (Some computers may take a while to display the window.)  
If the Wizard window prompts you to specify whether or not to connect to Windows Update, select the radio button for “No, not this time”, then click [Next].
- 7** Select the radio button for “Install the software automatically (recommended)”, then click [Next].

### NOTE

- If during the installation the system displays “...has not passed Windows Logo testing to verify its compatibility with Windows XP”, click [Continue Anyway].

- 8** When the installation is complete, the Wizard displays “Completing the Found New Hardware Wizard”.  
Click [Finish]. (Some computers may take a while to display the Wizard window.)
- 9** Restart the computer.  
If the system displays “Found New Hardware” in the lower right corner, wait until the Wizard window is displayed. (Some computers may take a while to display the Wizard window.)

The USB-MIDI driver installation is complete.

## ■ Installing the Musicsoft Downloader and Digital Music Notebook Applications...

### IMPORTANT

- You will need to log in with administrator (root) privileges in order to install Musicsoft Downloader on a computer running Windows 2000 or XP.
- You will need to log in with administrator (root) privileges in order to install Digital Music Notebook on a computer running Windows 2000 or XP.

### IMPORTANT

- When installing the Digital Music Notebook, make sure that Internet Explorer 6.0 (with SP1) or higher is installed to your computer.

### IMPORTANT

- Credit card settlement is required to purchase Digital Music Notebook content. Credit card processing may not be possible for some areas, so please check with your local authorities to make sure that your credit card can be used.

- 1** Insert the Accessory CD-ROM into your computer’s CD-ROM drive. The start window will appear automatically showing software applications.

### NOTE

- If the start window does not appear automatically, double click your “My Computer” folder to open it. Right-click the CD-ROM icon and select “Open” from the pop-up menu. Double click “Start.exe” and proceed to step 2, below.

- 2** Click [Musicsoft Downloader] or [Digital Music Notebook].
- 3** Click the [install] button or [Digital Music Notebook Download] button, and follow the onscreen instructions to install the software.

For Digital Music Notebook operating instructions see the help menu: launch the Digital Music Notebook application and click “Help”.

For Musicsoft Downloader operating instructions see the Help menu: launch the Musicsoft Downloader application and click “Help”.

- \* You can obtain the latest version of the Musicsoft Downloader at the following Internet URL.

<http://music.yamaha.com/download/>

### IMPORTANT

- Only Musicsoft Downloader can be used to transfer files between this instrument and a computer. No other file transfer application can be used.

## ■ Troubleshooting

### The driver cannot be installed.

- **Is the USB cable connected correctly?**  
Check the USB cable connection. Disconnect the USB cable, then connect it again.

- **Is the USB function enabled on your computer?**

When you connect the instrument to the computer for the first time, if the “Add New Hardware Wizard” does not appear, the USB function on the computer may be disabled. Perform the following steps.

- 1** Select [Control Panel] → [System] → [Device Manager] (for Windows 98/Me), or select [Control Panel]\* → [System] → [Hardware] → [Device Manager] (for Windows 2000/XP).

\* Classic View only in Windows XP.

- 2** Make sure that no “!” or “x” marks appear at “Universal serial bus controller” or “USB Root Hub”. If you see an “!” or “x” mark, the USB controller is disabled.

- **Is any unknown device registered?**  
If driver installation fails, the instrument will be marked as an “Unknown device”, and you will not be able to install the driver. Delete the “Unknown device” by following the steps below.

- 1** Select [Control Panel] → [System] → [Device Manager] (for Windows 98/Me), or select [Control Panel]\* → [System] → [Hardware] → [Device Manager] (for Windows 2000/XP).

\* Classic View only in Windows XP.

- 2** Look for “Other devices” in the menu “View devices by type”.
- 3** If you find “Other devices”, double-click it to extend the tree to look for “Unknown device”. If one appears, select it and click the [Remove] button.
- 4** Remove the USB cable from the instrument, and make the connection again.
- 5** Install the driver again.
  - Windows 98/Me users... see page 108
  - Windows 2000 users..... see page 108
  - Windows XP users..... see page 109

### When controlling the instrument from your computer via USB, the instrument does not operate correctly or no sound is heard.

- Did you install the driver? (page 107)
- Is the USB cable connected correctly?
- Are the volume settings of the instrument, playback device, and application program set to the appropriate levels?
- Have you selected an appropriate port in the sequence software?
- Are you using the latest USB MIDI driver?  
The latest driver can be downloaded from the following web site.

<http://music.yamaha.com/download/>

### Playback response is delayed.

- Does your computer satisfy the system requirements?
- Is any other application or device driver running?

### Cannot suspend or resume the computer correctly.

- Do not suspend the computer while the MIDI application is running.  
If you are using Windows 2000, you may not be able to suspend/resume normally, depending on the particular environment (USB Host Controller, etc.). Even so, simply disconnecting and connecting the USB cable will allow you to use the instrument functions again.

### How can I delete or re-install the driver?

#### [Windows Me/98]

- 1** When the instrument is recognized correctly, double-click “System” in the Control Panel to open the System window.
- 2** Double-click the “Device Manager” tab, select “YAMAHA USB MIDI Driver” and delete it.
- 3** Use the MS-DOS prompt or Explorer to delete the following three files.

**NOTE**

- To delete these files using Explorer, select "Folder Options" from the Tool (View) menu, and select "Show all files (and folders)."
- \WINDOWS\INF\OTHER\1039.INF
- \WINDOWS\SYSTEM\Xgusb.drv
- \WINDOWS\SYSTEM\Ymidusb.sys

- 4 Disconnect the USB cable.
- 5 Restart the computer.
- 6 Re-install the driver.

## ATTENTION

### SOFTWARE LICENSE AGREEMENT

PLEASE READ THIS SOFTWARE LICENSE AGREEMENT ("AGREEMENT") CAREFULLY BEFORE USING THIS SOFTWARE. YOU ARE ONLY PERMITTED TO USE THIS SOFTWARE PURSUANT TO THE TERMS AND CONDITIONS OF THIS AGREEMENT. THIS AGREEMENT IS BETWEEN YOU (AS AN INDIVIDUAL OR LEGAL ENTITY) AND YAMAHA CORPORATION ("YAMAHA"). BY BREAKING THE SEAL OF THIS PACKAGE YOU ARE AGREEING TO BE BOUND BY THE TERMS OF THIS LICENSE. IF YOU DO NOT AGREE WITH THE TERMS, DO NOT INSTALL, COPY, OR OTHERWISE USE THIS SOFTWARE.

#### 1. GRANT OF LICENSE AND COPYRIGHT

Yamaha hereby grants you the right to use one copy of the software program(s) and data ("SOFTWARE") accompanying this Agreement. The term SOFTWARE shall encompass any updates to the accompanying software and data. The SOFTWARE is owned by Yamaha and/or Yamaha's licensor(s), and is protected by relevant copyright laws and all applicable treaty provisions. While you are entitled to claim ownership of the data created with the use of SOFTWARE, the SOFTWARE will continue to be protected under relevant copyrights.

- You may use the SOFTWARE on a **single computer**.
- You may make one copy of the SOFTWARE in machine-readable form for backup purposes only, if the SOFTWARE is on media where such backup copy is permitted. On the backup copy, you must reproduce Yamaha's copyright notice and any other proprietary legends that were on the original copy of the SOFTWARE.
- You may permanently transfer to a third party all your rights in the SOFTWARE, provided that you do not retain any copies and the recipient reads and agrees to the terms of this Agreement.

#### 2. RESTRICTIONS

- You may not engage in reverse engineering, disassembly, decompilation or otherwise deriving a source code form of the SOFTWARE by any method whatsoever.
- You may not reproduce, modify, change, rent, lease, or distribute the SOFTWARE in whole or in part, or create derivative works of the SOFTWARE.
- You may not electronically transmit the SOFTWARE from one computer to another or share the SOFTWARE in a network with other computers.
- You may not use the SOFTWARE to distribute illegal data or data that violates public policy.
- You may not initiate services based on the use of the SOFTWARE without permission by Yamaha Corporation

Copyrighted data, including but not limited to MIDI data for songs, obtained by means of the SOFTWARE, are subject to the following restrictions which you must observe.

- Data received by means of the SOFTWARE may not be used for any commercial purposes without permission of the copyright owner.
- Data received by means of the SOFTWARE may not be duplicated, transferred, or distributed, or played back or performed for listeners in public without permission of the copyright owner.
- The encryption of data received by means of the SOFTWARE may not be removed nor may the electronic watermark be modified without permission of the copyright owner.

#### 3. TERMINATION

This Agreement becomes effective on the day that you receive the SOFTWARE and remains effective until terminated. If any copyright law or provisions of this Agreement is violated, the Agreement shall terminate automatically and immediately without notice from Yamaha. Upon such termination, you must immediately destroy the licensed SOFTWARE, any accompanying written documents and all copies thereof.

#### 4. LIMITED WARRANTY ON MEDIA

As to SOFTWARE sold on tangible media, Yamaha warrants that the tangible media on which the SOFTWARE is recorded will be free from defects in materials and workmanship under normal use for a period of fourteen (14) days from the date of receipt, as evidenced by a copy of the receipt. Yamaha's entire liability and your exclusive remedy will be replacement of the defective media if it is returned to Yamaha or an authorized Yamaha dealer within fourteen days with a copy of the receipt. Yamaha is not responsible for replacing media damaged by accident, abuse or misapplication. TO THE FULLEST EXTENT PERMITTED BY LAW, YAMAHA EXPRESSLY DISCLAIMS ANY IMPLIED WARRANTIES ON THE TANGIBLE MEDIA, INCLUDING THE IMPLIED WARRANTIES OF MERCHANTABILITY AND FITNESS FOR A PARTICULAR PURPOSE.

#### 5. DISCLAIMER OF WARRANTY ON SOFTWARE

You expressly acknowledge and agree that use of the SOFTWARE is at your sole risk. The SOFTWARE and related documentation are provided "AS IS" and without warranty of any kind. NOTWITHSTANDING ANY OTHER PROVISION OF THIS AGREEMENT, YAMAHA EXPRESSLY DISCLAIMS ALL WARRANTIES AS TO THE SOFTWARE, EXPRESS, AND IMPLIED, INCLUDING BUT NOT LIMITED TO THE IMPLIED WARRANTIES OF MERCHANTABILITY, FITNESS FOR A PARTICULAR PURPOSE AND NON-INFRINGEMENT OF THIRD PARTY RIGHTS. SPECIFICALLY, BUT WITHOUT LIMITING THE FOREGOING, YAMAHA DOES NOT WARRANT THAT THE SOFTWARE WILL MEET YOUR REQUIREMENTS, THAT THE OPERATION OF THE SOFTWARE WILL BE UNINTERRUPTED OR ERROR-FREE, OR THAT DEFECTS IN THE SOFTWARE WILL BE CORRECTED.

#### 6. LIMITATION OF LIABILITY

YAMAHA'S ENTIRE OBLIGATION HEREUNDER SHALL BE TO PERMIT USE OF THE SOFTWARE UNDER THE TERMS HEREOF. IN NO EVENT SHALL YAMAHA BE LIABLE TO YOU OR ANY OTHER PERSON FOR ANY DAMAGES, INCLUDING, WITHOUT LIMITATION, ANY DIRECT, INDIRECT, INCIDENTAL OR CONSEQUENTIAL DAMAGES, EXPENSES, LOST PROFITS, LOST DATA OR OTHER DAMAGES ARISING OUT OF THE USE, MISUSE OR INABILITY TO USE THE SOFTWARE, EVEN IF YAMAHA OR AN AUTHORIZED DEALER HAS BEEN ADVISED OF THE POSSIBILITY OF SUCH DAMAGES. In no event shall Yamaha's total liability to you for all damages, losses and causes of action (whether in contract, tort or otherwise) exceed the amount paid for the SOFTWARE.

#### 7. THIRD PARTY SOFTWARE

Third party software and data ("THIRD PARTY SOFTWARE") may be attached to the SOFTWARE. If, in the written materials or the electronic data accompanying the Software, Yamaha identifies any software and data as THIRD PARTY SOFTWARE, you acknowledge and agree that you must abide by the provisions of any Agreement provided with the THIRD PARTY SOFTWARE and that the party providing the THIRD PARTY SOFTWARE is responsible for any warranty or liability related to or arising from the THIRD PARTY SOFTWARE. Yamaha is not responsible in any way for the THIRD PARTY SOFTWARE or your use thereof.

- Yamaha provides no express warranties as to the THIRD PARTY SOFTWARE. IN ADDITION, YAMAHA EXPRESSLY DISCLAIMS ALL IMPLIED WARRANTIES, INCLUDING BUT NOT LIMITED TO THE IMPLIED WARRANTIES OF MERCHANTABILITY AND FITNESS FOR A PARTICULAR PURPOSE, as to the THIRD PARTY SOFTWARE.
- Yamaha shall not provide you with any service or maintenance as to the THIRD PARTY SOFTWARE.
- Yamaha is not liable to you or any other person for any damages, including, without limitation, any direct, indirect, incidental or consequential damages, expenses, lost profits, lost data or other damages arising out of the use, misuse or inability to use the THIRD PARTY SOFTWARE.

#### 8. GENERAL

This Agreement shall be interpreted according to and governed by Japanese law without reference to principles of conflict of laws. Any dispute or procedure shall be heard before the Tokyo District Court in Japan. If for any reason a court of competent jurisdiction finds any portion of this Agreement to be unenforceable, the remainder of this Agreement shall continue in full force and effect.

#### 9. COMPLETE AGREEMENT

This Agreement constitutes the entire agreement between the parties with respect to use of the SOFTWARE and any accompanying written materials and supersedes all prior or contemporaneous understandings or agreements, written or oral, regarding the subject matter of this Agreement. No amendment or revision of this Agreement will be binding unless in writing and signed by a fully authorized representative of Yamaha.



# Troubleshooting

## ■ For the Instrument

Problem	Possible Cause and Solution
When the instrument is turned on or off, a popping sound is temporarily produced.	This is normal and indicates that the instrument is receiving electrical power.
When using a mobile phone, noise is produced.	Using a mobile phone in close proximity to the instrument may produce interference. To prevent this, turn off the mobile phone or use it further away from the instrument.
There is no sound even when the keyboard is played or when a song or style is being played back.	Check that nothing is connected to the PHONES/OUTPUT jack on the rear panel. When a set of headphones is plugged into this jack, no sound is output.
	Check the Local Control on/off. (See page 100.)
	Is the FILE CONTROL display showing? The instrument's keyboard, etc., will not produce any sound while the FILE CONTROL display is showing. Press the [EXIT] button to return to the MAIN display.
Playing keys in the right hand area of the keyboard does not produce any sound.	When using the Dictionary function (page 82), the keys in the right hand area are used only for entering the chord root and type.
The style or song does not play back when the [START/STOP] button is pressed.	Is External Clock set to ON? Make sure External Clock is set to OFF; refer to "External Clock" on page 100.
The style does not sound properly.	Make sure that the Style Volume (page 88) is set to an appropriate level.
	Is the split point set at an appropriate key for the chords you are playing? Set the split point at an appropriate key (page 77). Is the "ACMP" indicator showing in the display? If it is not showing press the [ACMP ON/OFF] button so that it does show.
No rhythm accompaniment plays when the [START/STOP] button is pressed after selecting style number 121 or a style between 133 and 150 (Pianist).	This is not a malfunction. Style number 121 and style numbers 133–150 (Pianist) have no rhythm parts, so no rhythm will play. The other parts will begin playing when you play a chord in the accompaniment range of the keyboard if style playback is turned on.
Not all of the voices seem to sound, or the sound seems to be cut off.	The instrument is polyphonic up to a maximum of 32 notes. If the Dual voice or Split voice is being used and a style or song is playing back at the same time, some notes/sounds may be omitted (or "stolen") from the accompaniment or song.
The footswitch (for sustain) seems to produce the opposite effect. For example, pressing the footswitch cuts off the sound and releasing it sustains the sounds.	The polarity of the footswitch is reversed. Make sure that the footswitch plug is properly connected to the SUSTAIN jack before turning on the power.
The sound of the voice changes from note to note.	This is normal. The AWM tone generation method uses multiple recordings (samples) of an instrument across the range of the keyboard; thus, the actual sound of the voice may be slightly different from note to note.
The Demo display is shown in Japanese, and/or there are Japanese characters in the display messages.	Make sure the Language setting in the FUNCTION display is set to English. (See page 14)



Problem	Possible Cause and Solution
The appropriate display does not appear when the [SONG], [EASY SONG ARRANGER], [STYLE], or [VOICE] button is pressed.	Is another display showing? Try pressing the [EXIT] button to return to the MAIN display, and then pressing one of the mentioned buttons.
The wrong notes sound when the keyboard is played.	Perhaps the performance assistant technology is turned on. Press the [PERFORMANCE ASSISTANT] button to turn it off.
The ACMP indicator does not appear when the [ACMP ON/OFF] button is pressed.	Is the [STYLE] button lit? Always press the [STYLE] button first when you are going to use any style-related function.
There is no harmony sound.	The harmony effects (01–26) behave differently according to their type. Types 01–05 function when style playback is on, chords are played in the accompaniment range of the keyboard, and a melody is played in the right-hand range. Types 06–26 will function whether style playback is on or off. For types 06–12 you need to play two notes at the same time.



# Messages

LCD Message	Comment
Access error!	Indicates the failure in reading or writing from/to the media or the flash memory.
All Memory Clearing...	Displayed while erasing all data in the flash memory. Never turn the power off during data transmission.
Are you sure?	Confirms whether Song Clear or Track Clear is executed or not.
Backup Clearing...	Displayed while clearing the back-up data in the flash memory.
Cancel	Displayed when the transmission of Initial Send is cancelled.
Clearing...	Displayed while executing Song Clear or Track Clear of the user songs.
Com Mode	Displayed when the Musicsoft Downloader is started on the PC connected to the keyboard. This will not be displayed while the instrument is played back.
Completed	Indicates the specified job completion such as data saving and transmission.
Copy File	Displayed while copying a file in the Musicsoft Downloader.
Create Directory	Displayed while creating a folder in the Musicsoft Downloader application.
Data Error!	Displayed when the user song contains illegal data.
Delete File	Displayed while deleting a file in the Musicsoft Downloader.
Delete OK ?	Confirms whether the Delete job is executed or not.
Delete Directory	Displayed while deleting a folder in the Musicsoft Downloader.
Deleting...	Displayed while the delete function is engaged.
End	Displayed when the transmission of Initial Send has been completed.
Error!	Displayed when writing has failed.
"File information area is not large enough."	Indicates that saving data in the media cannot be executed since the total number of files have become too many.
File is not found.	Indicates there is no file.
"File too large. Loading is impossible."	Indicates that loading data cannot be executed since the file data is too large.
Flash Clearing...	Displayed while clearing the song or style data transmitted to the internal flash memory.
Format OK ? [EXECUTE]	Confirms whether formatting the media is executed or not.
Formatting...	Displayed while formatting.
Load OK ?	Confirms whether loading is executed or not.
Loading...	Displayed while loading data.
Media is not inserted.	Displayed when accessing the media while it is not inserted.
Media capacity is full.	Displayed when saving data cannot be executed since the media memory becomes full.
Memory Full	Displayed when the internal memory becomes full during song recording.
"MIDI receive buffer overflow."	Displayed when too much MIDI data was received at one time and failed to proceed.
Move File	Displayed while moving a file in the Musicsoft Downloader.
"Now Writing... (Don't turn off the power now, otherwise the data may be damaged.)"	Displayed while writing data in the memory. Never turn the power off while writing. Doing so may result in data loss.
Overwrite ?	Confirms whether overwriting is executed or not.
Please Wait...	Displayed when executing the jobs that take some time, such as displaying scores and lyrics.

LCD Message	Comment
Rename File	Displayed while rewriting the file name in the Musicsoft Downloader.
Save OK ?	Confirms whether saving is executed or not.
Saved data is not found.	Displayed when the data to be saved doesn't exist.
Saving...	Displayed while saving data in the memory. Never turn the power off while saving. Doing so may result in data loss.
Send OK?	Confirms whether the data transmission is executed or not.
Sending...	Displayed while transmitting data.
"Since the media is in use now, this function is not available."	Indicates that the file control function is currently unavailable since the media is being accessed.
Sure ? [YES/NO]	Reconfirms whether each operation is executed or not.
"The limit of the media has been reached."	Indicates that saving data cannot be executed since the folder/directory structure has become too complicated.
The media is not formatted.	Indicates the inserted media has not been formatted.
"The media is write-protected."	Indicates that the inserted media cannot be written since it is write-protected. Set to the write-protect switch to the "overwrite" position before use.
"The song data is too large to be converted to notation."	Indicates that the score cannot be displayed since the song data is too large.
There are too many files.	Indicates that saving data cannot be executed since the total number of files exceeds the capacity.
"This function is not available now."	Indicates the designated function is not available since the instrument is executing another job.
[nnn] "file name"	Indicates the file name of the currently transmitting. "nnn" indicates the receiving block.

**NOTE**

- Not all the messages are listed in the table: the messages necessary to be explained only.



# Keyboard Stand Assembly

## CAUTION

Read these cautions carefully before you assemble or use the keyboard stand. These cautions are to promote safe use of the stand and to prevent injury and damage from occurring to you and others. By following these cautions carefully, your keyboard stand will provide you with safe and prolonged use.

- Be careful not to confuse parts, and be sure to install all parts in the correct direction. Please assemble in accordance with the sequence given below.
- Assembly should be carried out by at least two persons.
- Be sure to use the correct screw size, as indicated above. Use of incorrect screws can cause damage.
- Use the stand after assembly is complete. An uncompleted stand may overturn or the keyboard may drop.
- Always place the stand on a flat, stable surface. Placing the stand on uneven surfaces may cause it to become unstable or overturn, the keyboard to drop, or injury.
- Do not use the stand for anything other than its designed purpose. Placing other objects on the stand may result in the object dropping or the stand overturning.
- Do not apply excessive force to the keyboard as it may cause the stand to overturn or the keyboard to drop.
- Make sure the stand is sturdy and safe, and all screws have been tight and firm before use. If not, the stand may overturn, the keyboard may drop, or may result in injury to the user.
- To disassemble, reverse the assembly sequence given below.

Have a phillips-head (+) screwdriver ready.

The parts shown in the “Assembly Parts” illustration will be used. Follow the assembly instructions and select the parts as needed.

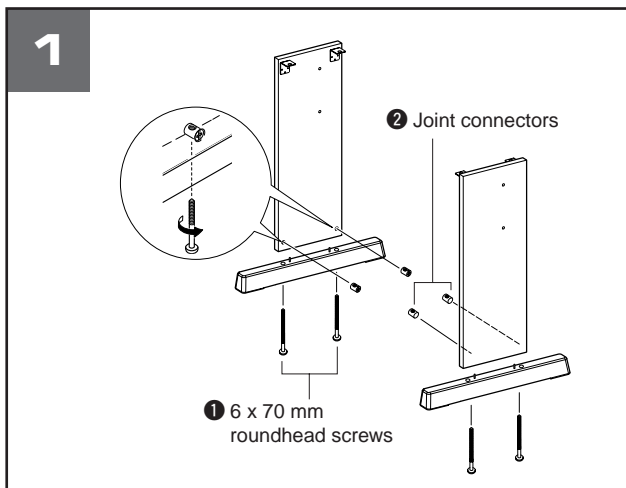
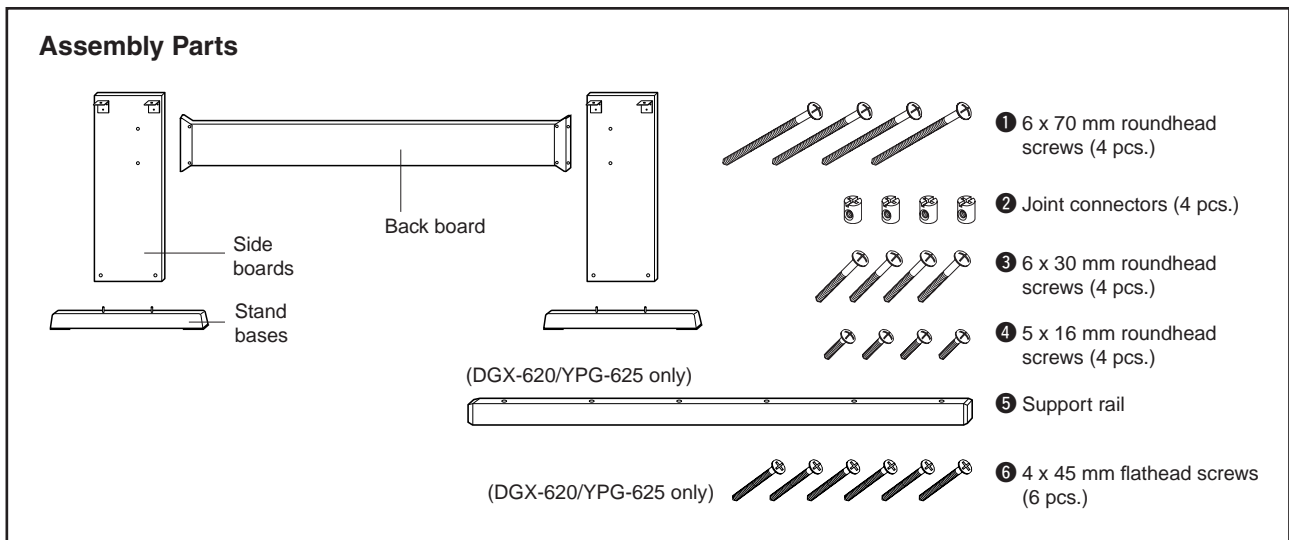

## 1 Attach the stand bases.

Making sure that the boards are facing the proper direction (the holes should face inside). The left and right side boards for the DGX-520 and YPG-525 are the same shape. Insert the joint connectors 2 into the holes as shown. The joint connectors have been installed properly if you can see a plus mark on the connector.

Attach the stand bases to the rear of the side boards, using the 6 x 70 mm roundhead screws 1. The left and right stand bases are the same shape, and there is no difference between their front-to-back orientation. If you have trouble screwing in the screws, use a screwdriver to rotate the joint connectors to the appropriate position—the → mark on the joint connectors indicates the location of the screw hole.

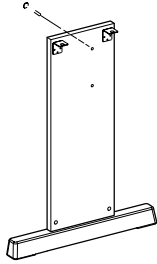
**2****2 Attach the back board.**

Attach the back board, using the 6 x 30 mm roundhead screws **3**. DGX-620 and YPG-625 owners : Check the back-to-front orientation for the side boards.

Make sure the non-colored surface is facing down.

**3 DGX-620 and YPG-625 owners: please follow these instructions.****Attach the support rail.**

Spread a large soft cloth (such as a blanket) on the floor. Place the instrument on the cloth with the keyboard side facing down. Align the support rail **5** into the groove on the bottom of the instrument and attach the rail, using the 4 x 45mm flathead screws **6**.

**4 Put the keyboard on the stand.**

Check the back-to-front orientation for stand, and carefully place the keyboard on the side boards. Slowly move the keyboard so that the holes on the bottom of the keyboard are properly aligned with the holes on the angle brackets.

**5 Install the keyboard to the stand.**

Fix the keyboard to the angle brackets, using the 5 x 16 mm roundhead screws **4**.



# Scores

This demo is an example of how the Easy Song Arranger can be used to change styles throughout a piece.

Song No. 9

♩ = 123

(Function Demo for Easy Song Arranger)

## Hallelujah Chorus

Melody

The score shows a melody line in treble clef with a key signature of one sharp (F#) and a common time signature (C). The melody starts with a whole note rest, followed by a half note rest, and then a quarter note G4. The arrangement below the melody is divided into sections: a <Clubdance> section with a 'Main' box, a 'Fill' box, and a '1st time' section with a 'Main' box. The '2nd time' section is marked <Hard Rock> and also has a 'Main' box. Chord symbols 'D' and 'G/D D' are placed above the melody line.

The score continues the melody line with a 5/23 time signature. The melody starts with a quarter note G4, followed by a quarter note A4, and then a quarter note B4. The arrangement below the melody is divided into sections: a 'Main' box, a 'Fill' box, and a '1st time' section with a 'Main' box. The '2nd time' section is marked <Hard Rock> and also has a 'Main' box. Chord symbols 'D', 'G/D D', and 'G/D D' are placed above the melody line.

17/35

Musical notation for measures 17-35. It consists of a treble clef staff with a key signature of one sharp (F#) and a common time signature (C). Below the staff are two empty bass clef staves.

21/39

Musical notation for measures 21-39. It consists of a treble clef staff with a key signature of one sharp (F#) and a common time signature (C). Below the staff are two empty bass clef staves.

Musical notation for measure 39. It consists of a treble clef staff with a key signature of one sharp (F#). Below the staff is one empty bass clef staff.

This score is provided with the intent that the pitch will be corrected by the performance assistant technology feature. If you play the “Play These Notes” part using the performance assistant technology feature, the part will be corrected and played so that it matches the backing part.

Song No. 10

♩ = 61

(Function Demo for performance assistant technology)

### Ave Maria

The image displays two systems of musical notation for the piece "Ave Maria". Each system consists of five staves: a vocal line, a piano accompaniment (treble and bass clefs), a percussion line, and a grand staff (treble and bass clefs). The first system covers measures 1 through 4. Measure 1 is marked with a first ending bracket. The piano accompaniment in the first system includes a treble clef staff with a sixteenth-note arpeggiated pattern and a bass clef staff with a dotted quarter note. Measures 2, 3, and 4 contain rests for the piano parts, indicated by a slash symbol. The second system covers measures 5 through 8. Measure 5 is marked with a fifth ending bracket. The piano accompaniment in the second system includes a treble clef staff with a sixteenth-note arpeggiated pattern and a bass clef staff with a dotted quarter note. Measures 6, 7, and 8 contain rests for the piano parts, indicated by a slash symbol.



The image displays a musical score for a piano piece, partially obscured by a large, abstract black graphic. The score consists of several staves:

- Top Staff:** A single treble clef staff containing a short melodic line of notes.
- Middle Staves:** A grand staff consisting of a treble clef staff and a bass clef staff. Both are marked with a double slash (/ /) in each measure, indicating they are silent.
- Bottom Staff:** A grand staff with a treble clef staff and a bass clef staff. The treble staff contains a complex, fast-moving melodic line with many sixteenth notes. The bass staff contains a rhythmic accompaniment with dotted eighth and sixteenth notes.



19/35

Dm + Bdim7 + C7sus4 + C7

1. 2.

23

F + F + F + F

42

*rit.*

F + F + F + F



# Voice List

## Maximum Polyphony

The instrument has 32-note maximum polyphony. This means that it can play a maximum of up to 32 notes at once, regardless of what functions are used. Auto accompaniment uses a number of the available notes, so when auto accompaniment is used the total number of available notes for playing on the keyboard is correspondingly reduced. The same applies to the Split Voice and Song functions. If the maximum polyphony is exceeded, earlier played notes will be cut off and the most recent notes have priority (last note priority).

### NOTE

- The Voice List includes MIDI program change numbers for each voice. Use these program change numbers when playing the instrument via MIDI from an external device.
- Program Numbers 001 to 128 directly relate to MIDI Program Change Numbers 000 to 127. That is, Program Numbers and Program Change Numbers differ by a value of 1. Remember to take this into consideration.
- Some voices may sound continuously or have a long decay after the notes have been released while the sustain pedal (footswitch) is held.

## Panel Voice List

Voice No.	Bank Select		MIDI Program Change# (1-128)	Voice Name
	MSB (0-127)	LSB (0-127)		
<b>PIANO</b>				
001	000	113	001	Live! Grand Piano
002	000	114	001	Live! Warm Grand Piano
003	000	112	001	Grand Piano
004	000	112	002	Bright Piano
005	000	112	007	Harpsichord
006	000	112	004	Honky-tonk Piano
007	000	112	003	MIDI Grand Piano
008	000	113	003	CP 80
<b>E.PIANO</b>				
009	000	114	005	Cool! Galaxy Electric Piano
010	000	118	005	Cool! Suitcase Electric Piano
011	000	119	005	Cool! Electric Piano
012	000	113	006	Hyper Tines
013	000	112	005	Funky Electric Piano
014	000	112	006	DX Modern Electric Piano
015	000	114	006	Venus Electric Piano
016	000	114	008	E.Clavichord
017	000	112	008	Clavi
<b>ORGAN</b>				
018	000	118	019	Cool! Organ
019	000	117	019	Cool! Rotor Organ
020	000	112	017	Jazz Organ 1
021	000	113	017	Jazz Organ 2
022	000	112	019	Rock Organ
023	000	114	019	Purple Organ
024	000	112	018	Click Organ
025	000	116	017	Bright Organ
026	000	127	019	Theater Organ
027	000	121	020	16'+2' Organ
028	000	120	020	16'+4' Organ
029	000	113	020	Chapel Organ
030	000	112	020	Church Organ
031	000	112	021	Reed Organ
<b>ACCORDION</b>				
032	000	112	022	Musette Accordion
033	000	113	022	Traditional Accordion
034	000	113	024	Bandoneon
035	000	113	023	Modern Harp
036	000	112	023	Harmonica
<b>GUITAR</b>				
037	000	112	025	Classical Guitar
038	000	112	026	Folk Guitar
039	000	112	027	Jazz Guitar
040	000	117	028	60's Clean Guitar
041	000	113	026	12Strings Guitar
042	000	112	028	Clean Guitar
043	000	113	027	Octave Guitar
044	000	112	029	Muted Guitar
045	000	112	030	Overdriven Guitar
046	000	112	031	Distortion Guitar
<b>BASS</b>				
047	000	112	034	Finger Bass
048	000	112	033	Acoustic Bass
049	000	112	035	Pick Bass
050	000	112	036	Fretless Bass

Voice No.	Bank Select		MIDI Program Change# (1-128)	Voice Name
	MSB (0-127)	LSB (0-127)		
051	000	112	037	Slap Bass
052	000	112	039	Synth Bass
053	000	113	039	Hi-Q Bass
054	000	113	040	Dance Bass
<b>STRINGS</b>				
055	000	116	050	Live! Orchestra
056	000	112	049	String Ensemble
057	000	112	050	Chamber Strings
058	000	113	050	Slow Strings
059	000	112	045	Tremolo Strings
060	000	112	051	Synth Strings
061	000	112	046	Pizzicato Strings
062	000	112	041	Violin
063	000	112	043	Cello
064	000	112	044	Contrabass
065	000	112	047	Harp
066	000	112	106	Banjo
067	000	112	056	Orchestra Hit
<b>CHOIR</b>				
068	000	112	053	Choir
069	000	113	053	Vocal Ensemble
070	000	112	055	Air Choir
071	000	112	054	Vox Humana
<b>SAXOPHONE</b>				
072	000	117	067	Sweet! Tenor Sax
073	000	113	065	Sweet! Soprano Sax
074	000	114	072	Sweet! Clarinet
075	000	118	067	Growl Sax
076	000	112	067	Tenor Sax
077	000	112	066	Alto Sax
078	000	112	065	Soprano Sax
079	000	112	068	Baritone Sax
080	000	114	067	Breathy Tenor Sax
081	000	112	072	Clarinet
082	000	112	069	Oboe
083	000	112	070	English Horn
084	000	112	071	Bassoon
<b>TRUMPET</b>				
085	000	115	057	Sweet! Trumpet
086	000	117	058	Sweet! Trombone
087	000	114	060	Sweet! Muted Trumpet
088	000	112	057	Trumpet
089	000	112	058	Trombone
090	000	113	058	Trombone Section
091	000	112	060	Muted Trumpet
092	000	112	061	French Horn
093	000	112	059	Tuba
<b>BRASS</b>				
094	000	112	062	Brass Section
095	000	113	062	Big Band Brass
096	000	113	063	80's Brass
097	000	119	062	Mellow Horns
098	000	114	063	Techno Brass
099	000	112	063	Synth Brass
<b>FLUTE</b>				
100	000	114	074	Sweet! Flute

Voice No.	Bank Select		MIDI Program Change# (1-128)	Voice Name
	MSB (0-127)	LSB (0-127)		
101	000	113	076	Sweet! Pan Flute
102	000	112	074	Flute
103	000	112	073	Piccolo
104	000	112	076	Pan Flute
105	000	112	075	Recorder
106	000	112	080	Ocarina
<b>SYNTH LEAD</b>				
107	000	112	081	Square Lead
108	000	112	082	Sawtooth Lead
109	000	115	082	Analogon
110	000	119	082	Fargo
111	000	112	099	Star Dust
112	000	112	086	Voice Lead
113	000	112	101	Brightness
<b>SYNTH PAD</b>				
114	000	118	089	SweetHeaven
115	000	112	092	Xenon Pad
116	000	112	095	Equinox
117	000	112	089	Fantasia
118	000	113	090	Dark Moon
119	000	113	101	Bell Pad
<b>PERCUSSION</b>				
120	000	112	012	Vibraphone
121	000	112	013	Marimba
122	000	112	014	Xylophone
123	000	112	115	Steel Drums
124	000	112	009	Celesta
125	000	112	011	Music Box
126	000	112	015	Tubular Bells
127	000	112	048	Timpani
<b>DRUM KITS</b>				
128	127	000	001	Standard Kit 1
129	127	000	002	Standard Kit 2
130	127	000	009	Room Kit
131	127	000	017	Rock Kit
132	127	000	025	Electronic Kit
133	127	000	026	Analog Kit
134	127	000	113	Dance Kit
135	127	000	033	Jazz Kit
136	127	000	041	Brush Kit
137	127	000	049	Symphony Kit
138	126	000	001	SFX Kit 1
139	126	000	002	SFX Kit 2

### ● XGlite Voice/XGlite Optional Voice\* List

Voice No.	Bank Select		MIDI Program Change# (1-128)	Voice Name
	MSB (0-127)	LSB (0-127)		
<b>XG PIANO</b>				
140	000	000	001	Grand Piano
141	000	001	001	Grand Piano KSP
142	000	040	001	Piano Strings
143	000	041	001	Dream
144	000	000	002	Bright Piano
145	000	001	002	Bright Piano KSP
146	000	000	003	Electric Grand Piano
147	000	001	003	Electric Grand Piano KSP
148	000	032	003	Detuned CP80
149	000	000	004	Honky-tonk Piano
150	000	001	004	Honky-tonk Piano KSP
151	000	000	005	Electric Piano 1
152	000	001	005	Electric Piano 1 KSP
153	000	032	005	Chorus Electric Piano 1
154	000	000	006	Electric Piano 2
155	000	001	006	Electric Piano 2 KSP
*156	000	032	006	Chorus Electric Piano 2
157	000	041	006	DX + Analog Electric Piano
158	000	000	007	Harpsichord
159	000	001	007	Harpsichord KSP
160	000	035	007	Harpsichord 2

Voice No.	Bank Select		MIDI Program Change# (1-128)	Voice Name
	MSB (0-127)	LSB (0-127)		
161	000	000	008	Clavi
162	000	001	008	Clavi KSP
<b>XG CHROMATIC</b>				
163	000	000	009	Celesta
164	000	000	010	Glockenspiel
165	000	000	011	Music Box
166	000	064	011	Orgel
167	000	000	012	Vibraphone
168	000	001	012	Vibraphone KSP
169	000	000	013	Marimba
170	000	001	013	Marimba KSP
171	000	064	013	Sine Marimba
172	000	097	013	Balimba
173	000	098	013	Log Drums
174	000	000	014	Xylophone
175	000	000	015	Tubular Bells
176	000	096	015	Church Bells
177	000	097	015	Carillon
178	000	000	016	Dulcimer
179	000	035	016	Dulcimer 2
180	000	096	016	Cimbalom
181	000	097	016	Santur
<b>XG ORGAN</b>				
182	000	000	017	Drawbar Organ
183	000	032	017	Detuned Drawbar Organ
184	000	033	017	60's Drawbar Organ 1
185	000	034	017	60's Drawbar Organ 2
186	000	035	017	70's Drawbar Organ 1
187	000	037	017	60's Drawbar Organ 3
188	000	040	017	16+2'2/3
189	000	064	017	Organ Bass
190	000	065	017	70's Drawbar Organ 2
191	000	066	017	Cheezy Organ
192	000	067	017	Drawbar Organ 2
193	000	000	018	Percussive Organ
194	000	024	018	70's Percussive Organ
195	000	032	018	Detuned Percussive Organ
196	000	033	018	Light Organ
197	000	037	018	Percussive Organ 2
198	000	000	019	Rock Organ
199	000	064	019	Rotary Organ
200	000	065	019	Slow Rotary
201	000	066	019	Fast Rotary
202	000	000	020	Church Organ
203	000	032	020	Church Organ 3
204	000	035	020	Church Organ 2
205	000	040	020	Notre Dame
206	000	064	020	Organ Flute
207	000	065	020	Tremolo Organ Flute
208	000	000	021	Reed Organ
209	000	040	021	Puff Organ
210	000	000	022	Accordion
211	000	000	023	Harmonica
212	000	032	023	Harmonica 2
213	000	000	024	Tango Accordion
214	000	064	024	Tango Accordion 2
<b>XG GUITAR</b>				
215	000	000	025	Nylon Guitar
216	000	043	025	Velocity Guitar Harmonics
217	000	096	025	Ukulele
218	000	000	026	Steel Guitar
219	000	035	026	12-string Guitar
220	000	040	026	Nylon & Steel Guitar
221	000	041	026	Steel Guitar with Body Sound
222	000	096	026	Mandolin
223	000	000	027	Jazz Guitar
224	000	032	027	Jazz Amp
225	000	000	028	Clean Guitar
226	000	032	028	Chorus Guitar
227	000	000	029	Muted Guitar
228	000	040	029	Funk Guitar
229	000	041	029	Muted Steel Guitar
230	000	045	029	Jazz Man

# Voice List

Voice No.	Bank Select		MIDI Program Change# (1-128)	Voice Name
	MSB (0-127)	LSB (0-127)		
231	000	000	030	Overdriven Guitar
232	000	043	030	Guitar Pinch
233	000	000	031	Distortion Guitar
234	000	040	031	Feedback Guitar
235	000	041	031	Feedback Guitar 2
236	000	000	032	Guitar Harmonics
237	000	065	032	Guitar Feedback
238	000	066	032	Guitar Harmonics 2
<b>XG BASS</b>				
239	000	000	033	Acoustic Bass
240	000	040	033	Jazz Rhythm
241	000	045	033	Velocity Crossfade Upright Bass
242	000	000	034	Finger Bass
243	000	018	034	Finger Dark
244	000	040	034	Bass & Distorted Electric Guitar
245	000	043	034	Finger Slap Bass
246	000	045	034	Finger Bass 2
247	000	065	034	Modulated Bass
248	000	000	035	Pick Bass
249	000	028	035	Muted Pick Bass
250	000	000	036	Fretless Bass
251	000	032	036	Fretless Bass 2
252	000	033	036	Fretless Bass 3
253	000	034	036	Fretless Bass 4
254	000	000	037	Slap Bass 1
255	000	032	037	Punch Thumb Bass
256	000	000	038	Slap Bass 2
257	000	043	038	Velocity Switch Slap
258	000	000	039	Synth Bass 1
259	000	040	039	Techno Synth Bass
260	000	000	040	Synth Bass 2
261	000	006	040	Mellow Synth Bass
262	000	012	040	Sequenced Bass
263	000	018	040	Click Synth Bass
264	000	019	040	Synth Bass 2 Dark
*265	000	040	040	Modular Synth Bass
266	000	041	040	DX Bass
<b>XG STRINGS</b>				
267	000	000	041	Violin
268	000	008	041	Slow Violin
269	000	000	042	Viola
270	000	000	043	Cello
271	000	000	044	Contrabass
272	000	000	045	Tremolo Strings
273	000	008	045	Slow Tremolo Strings
274	000	040	045	Suspense Strings
275	000	000	046	Pizzicato Strings
276	000	000	047	Orchestral Harp
277	000	040	047	Yang Chin
278	000	000	048	Timpani
<b>XG ENSEMBLE</b>				
279	000	000	049	Strings 1
280	000	003	049	Stereo Strings
281	000	008	049	Slow Strings
282	000	035	049	60's Strings
283	000	040	049	Orchestra
284	000	041	049	Orchestra 2
285	000	042	049	Tremolo Orchestra
286	000	045	049	Velocity Strings
287	000	000	050	Strings 2
288	000	003	050	Stereo Slow Strings
289	000	008	050	Legato Strings
290	000	040	050	Warm Strings
291	000	041	050	Kingdom
292	000	000	051	Synth Strings 1
293	000	000	052	Synth Strings 2
294	000	000	053	Choir Aahs
295	000	003	053	Stereo Choir
296	000	032	053	Mellow Choir
297	000	040	053	Choir Strings
298	000	000	054	Voice Oohs
299	000	000	055	Synth Voice

Voice No.	Bank Select		MIDI Program Change# (1-128)	Voice Name
	MSB (0-127)	LSB (0-127)		
300	000	040	055	Synth Voice 2
301	000	041	055	Choral
302	000	064	055	Analog Voice
303	000	000	056	Orchestra Hit
304	000	035	056	Orchestra Hit 2
305	000	064	056	Impact
<b>XG BRASS</b>				
306	000	000	057	Trumpet
307	000	032	057	Warm Trumpet
308	000	000	058	Trombone
309	000	018	058	Trombone 2
310	000	000	059	Tuba
311	000	000	060	Muted Trumpet
312	000	000	061	French Horn
313	000	006	061	French Horn Solo
314	000	032	061	French Horn 2
315	000	037	061	Horn Orchestra
316	000	000	062	Brass Section
317	000	035	062	Trumpet & Trombone Section
318	000	000	063	Synth Brass 1
319	000	020	063	Resonant Synth Brass
320	000	000	064	Synth Brass 2
321	000	018	064	Soft Brass
322	000	041	064	Choir Brass
<b>XG REED</b>				
323	000	000	065	Soprano Sax
324	000	000	066	Alto Sax
325	000	040	066	Sax Section
326	000	000	067	Tenor Sax
327	000	040	067	Breathy Tenor Sax
328	000	000	068	Baritone Sax
329	000	000	069	Oboe
330	000	000	070	English Horn
331	000	000	071	Bassoon
332	000	000	072	Clarinet
<b>XG PIPE</b>				
333	000	000	073	Piccolo
334	000	000	074	Flute
335	000	000	075	Recorder
336	000	000	076	Pan Flute
337	000	000	077	Blown Bottle
338	000	000	078	Shakuhachi
339	000	000	079	Whistle
340	000	000	080	Ocarina
<b>XG SYNTH LEAD</b>				
341	000	000	081	Square Lead
342	000	006	081	Square Lead 2
343	000	008	081	LM Square
344	000	018	081	Hollow
345	000	019	081	Shroud
346	000	064	081	Mellow
347	000	065	081	Solo Sine
348	000	066	081	Sine Lead
349	000	000	082	Sawtooth Lead
350	000	006	082	Sawtooth Lead 2
351	000	008	082	Thick Sawtooth
352	000	018	082	Dynamic Sawtooth
353	000	019	082	Digital Sawtooth
354	000	020	082	Big Lead
355	000	096	082	Sequenced Analog
356	000	000	083	Calliope Lead
357	000	065	083	Pure Lead
358	000	000	084	Chiff Lead
359	000	000	085	Charang Lead
360	000	064	085	Distorted Lead
361	000	000	086	Voice Lead
362	000	000	087	Fifths Lead
363	000	035	087	Big Five
364	000	000	088	Bass & Lead
365	000	016	088	Big & Low
366	000	064	088	Fat & Perky
367	000	065	088	Soft Whirl

Voice No.	Bank Select		MIDI Program Change# (1-128)	Voice Name
	MSB (0-127)	LSB (0-127)		
<b>XG SYNTH PAD</b>				
368	000	000	089	New Age Pad
369	000	064	089	Fantasy
370	000	000	090	Warm Pad
371	000	000	091	Poly Synth Pad
372	000	000	092	Choir Pad
373	000	066	092	Itopia
374	000	000	093	Bowed Pad
375	000	000	094	Metallic Pad
376	000	000	095	Halo Pad
377	000	000	096	Sweep Pad
<b>XG SYNTH EFFECTS</b>				
378	000	000	097	Rain
379	000	065	097	African Wind
380	000	066	097	Carib
381	000	000	098	Sound Track
382	000	027	098	Prologue
383	000	000	099	Crystal
384	000	012	099	Synth Drum Comp
385	000	014	099	Popcorn
386	000	018	099	Tiny Bells
387	000	035	099	Round Glockenspiel
388	000	040	099	Glockenspiel Chimes
389	000	041	099	Clear Bells
390	000	042	099	Chorus Bells
391	000	065	099	Soft Crystal
392	000	070	099	Air Bells
393	000	071	099	Bell Harp
394	000	072	099	Gamelimba
395	000	000	100	Atmosphere
396	000	018	100	Warm Atmosphere
397	000	019	100	Hollow Release
398	000	040	100	Nylon Electric Piano
399	000	064	100	Nylon Harp
400	000	065	100	Harp Vox
401	000	066	100	Atmosphere Pad
402	000	000	101	Brightness
403	000	000	102	Goblins
404	000	064	102	Goblins Synth
405	000	065	102	Creeper
406	000	067	102	Ritual
407	000	068	102	To Heaven
408	000	070	102	Night
409	000	071	102	Glisten
410	000	096	102	Bell Choir
411	000	000	103	Echoes
412	000	000	104	Sci-Fi
<b>XG WORLD</b>				
413	000	000	105	Sitar
414	000	032	105	Detuned Sitar
415	000	035	105	Sitar 2
416	000	097	105	Tamboura
417	000	000	106	Banjo
418	000	028	106	Muted Banjo
419	000	096	106	Rabab
420	000	097	106	Gopichant
421	000	098	106	Oud
422	000	000	107	Shamisen
423	000	000	108	Koto
424	000	096	108	Taisho-kin
425	000	097	108	Kanoon
426	000	000	109	Kalimba
427	000	000	110	Bagpipe
428	000	000	111	Fiddle
429	000	000	112	Shanai
<b>XG PERCUSSIVE</b>				
430	000	000	113	Tinkle Bell
431	000	096	113	Bonang
432	000	097	113	Altair
433	000	098	113	Gamelan Gongs

Voice No.	Bank Select		MIDI Program Change# (1-128)	Voice Name
	MSB (0-127)	LSB (0-127)		
434	000	099	113	Stereo Gamelan Gongs
435	000	100	113	Rama Cymbal
436	000	000	114	Agogo
437	000	000	115	Steel Drums
438	000	097	115	Glass Percussion
439	000	098	115	Thai Bells
440	000	000	116	Woodblock
441	000	096	116	Castanets
442	000	000	117	Taiko Drum
443	000	096	117	Gran Cassa
444	000	000	118	Melodic Tom
445	000	064	118	Melodic Tom 2
446	000	065	118	Real Tom
447	000	066	118	Rock Tom
448	000	000	119	Synth Drum
449	000	064	119	Analog Tom
450	000	065	119	Electronic Percussion
451	000	000	120	Reverse Cymbal
<b>XG SOUND EFFECTS</b>				
452	000	000	121	Fret Noise
453	000	000	122	Breath Noise
454	000	000	123	Seashore
455	000	000	124	Bird Tweet
456	000	000	125	Telephone Ring
457	000	000	126	Helicopter
458	000	000	127	Applause
459	000	000	128	Gunshot
460	064	000	001	Cutting Noise
461	064	000	002	Cutting Noise 2
462	064	000	004	String Slap
463	064	000	017	Flute Key Click
464	064	000	033	Shower
465	064	000	034	Thunder
466	064	000	035	Wind
467	064	000	036	Stream
468	064	000	037	Bubble
469	064	000	038	Feed
470	064	000	049	Dog
471	064	000	050	Horse
472	064	000	051	Bird Tweet 2
473	064	000	056	Maou
474	064	000	065	Phone Call
475	064	000	066	Door Squeak
476	064	000	067	Door Slam
477	064	000	068	Scratch Cut
478	064	000	069	Scratch Split
479	064	000	070	Wind Chime
480	064	000	071	Telephone Ring 2
481	064	000	081	Car Engine Ignition
482	064	000	082	Car Tires Squeal
483	064	000	083	Car Passing
484	064	000	084	Car Crash
485	064	000	085	Siren
486	064	000	086	Train
487	064	000	087	Jet Plane
488	064	000	088	Starship
489	064	000	089	Burst
490	064	000	090	Roller Coaster
491	064	000	091	Submarine
492	064	000	097	Laugh
493	064	000	098	Scream
494	064	000	099	Punch
495	064	000	100	Heartbeat
496	064	000	101	Footsteps
497	064	000	113	Machine Gun
498	064	000	114	Laser Gun
499	064	000	115	Explosion
500	064	000	116	Firework

The voice number with an asterisk (\*) is XGlite optional voice.



# Drum Kit List

- “ ” indicates that the drum sound is the same as “Standard Kit 1”.
- Each percussion voice uses one note.
- The MIDI Note # and Note are actually one octave lower than keyboard Note # and Note. For example, in “128: Standard Kit 1”, the “Seq Click H” (Note# 36/Note C1) corresponds to (Note# 24/Note C0).
- Key Off: Keys marked “O” stop sounding the instant they are released.
- Voices with the same Alternate Note Number (\*1 ... 4) cannot be played simultaneously. (They are designed to be played alternately with each other.)

	Voice No.						128	129	130	131	132	133
	MSB (0-127) / LSB (0-127) / PC (1-128)						127/000/001	127/000/002	127/000/009	127/000/017	127/000/025	127/000/026
	Keyboard		MIDI		Key Off	Alternate assign	Standard Kit 1	Standard Kit 2	Room Kit	Rock Kit	Electronic Kit	Analog Kit
Note#	Note	Note#	Note									
D0	C#0	25	C# 0	13	C# -1		3	Surdo Mute				
		26	D 0	14	D -1		3	Surdo Open				
E0	D#0	27	D# 0	15	D# -1			Hi Q				
		28	E 0	16	E -1			Whip Slap				
F0	F#0	29	F 0	17	F -1		4	Scratch H				
		30	F# 0	18	F# -1		4	Scratch L				
G0	G#0	31	G 0	19	G -1			Finger Snap				
		32	G# 0	20	G# -1			Click Noise				
A0	A#0	33	A 0	21	A -1			Metronome Click				
		34	A# 0	22	A# -1			Metronome Bell				
B0	B#0	35	B 0	23	B -1			Seq Click L				
		36	C 1	24	C 0			Seq Click H				
C1	C#1	37	C# 1	25	C# 0			Brush Tap				
		38	D 1	26	D 0	O		Brush Swirl				
D1	D#1	39	D# 1	27	D# 0			Brush Slap				
		40	E 1	28	E 0	O		Brush Tap Swirl				
E1	F#1	41	F 1	29	F 0	O		Snare Roll	Snare Roll 2		Reverse Cymbal	Reverse Cymbal
		42	F# 1	30	F# 0			Castanet			Hi Q 2	Hi Q 2
F1	G#1	43	G 1	31	G 0			Snare Soft	Snare Soft 2		Snare Noisy	Snare Snappy Electro
		44	G# 1	32	G# 0			Sticks			Snare Snappy Electro	Snare Noisy 4
G1	A#1	45	A 1	33	A 0			Kick Soft			Kick Tight 2	Kick 3
		46	A# 1	34	A# 0			Open Rim Shot	Open Rim Shot H Short		Kick 3	Kick Tight 2
A1	B#1	47	B 1	35	B 0			Kick Tight	Kick Tight Short		Kick 2	Kick Gate
		48	C 2	36	C 1			Kick	Kick Short		Kick Gate	Kick Gate Heavy
B1	C#2	49	C# 2	37	C# 1			Side Stick				Kick Analog
		50	D 2	38	D 1			Snare	Snare Short	Snare Snappy	Snare Rock	Side Stick Analog
D2	D#2	51	D# 2	39	D# 1			Hand Clap			Snare Noisy 2	Snare Analog
		52	E 2	40	E 1			Snare Tight	Snare Tight H	Snare Tight Snappy	Snare Rock Rim	Snare Noisy 3
E2	F#2	53	F 2	41	F 1			Floor Tom L	Tom Room 1	Tom Rock 1	Tom Electro 1	Snare Analog 2
		54	F# 2	42	F# 1	1		Hi-Hat Closed			Tom Electro 1	Tom Analog 1
F2	G#2	55	G 2	43	G 1			Floor Tom H	Tom Room 2	Tom Rock 2	Tom Electro 2	Tom Analog 2
		56	G# 2	44	G# 1	1		Hi-Hat Pedal			Tom Electro 2	Hi-Hat Closed Analog
G2	A#2	57	A 2	45	A 1			Low Tom	Tom Room 3	Tom Rock 3	Tom Electro 3	Tom Analog 2
		58	A# 2	46	A# 1	1		Hi-Hat Open			Tom Electro 3	Hi-Hat Closed Analog 2
A2	B#2	59	B 2	47	B 1			Mid Tom L	Tom Room 4	Tom Rock 4	Tom Electro 4	Tom Analog 3
		60	C 3	48	C 2			Mid Tom H	Tom Room 5	Tom Rock 5	Tom Electro 5	Hi-Hat Open Analog
B2	C#3	61	C# 3	49	C# 2			Crash Cymbal 1				Tom Analog 4
		62	D 3	50	D 2			High Tom	Tom Room 6	Tom Rock 6	Tom Electro 6	Tom Analog 5
D3	D#3	63	D# 3	51	D# 2			Ride Cymbal 1				Crash Analog
		64	E 3	52	E 2			Chinese Cymbal				Tom Analog 6
E3	F#3	65	F 3	53	F 2			Ride Cymbal Cup				Tom Analog 6
		66	F# 3	54	F# 2			Tambourine				
F3	G#3	67	G 3	55	G 2			Splash Cymbal				
		68	G# 3	56	G# 2			Cowbell				Cowbell Analog
G3	A#3	69	A 3	57	A 2			Crash Cymbal 2				
		70	A# 3	58	A# 2			Vibraslap				
A3	B#3	71	B 3	59	B 2			Ride Cymbal 2				
		72	C 4	60	C 3			Bongo H				
B3	C#4	73	C# 4	61	C# 3			Bongo L				
		74	D 4	62	D 3			Conga H Mute				Conga Analog H
D4	D#4	75	D# 4	63	D# 3			Conga H Open				Conga Analog M
		76	E 4	64	E 3			Conga L				Conga Analog L
E4	F#4	77	F 4	65	F 3			Timbale H				
		78	F# 4	66	F# 3			Timbale L				
F4	G#4	79	G 4	67	G 3			Agogo H				
		80	G# 4	68	G# 3			Agogo L				
G4	A#4	81	A 4	69	A 3			Cabasa				
		82	A# 4	70	A# 3			Maracas				Maracas 2
A4	B#4	83	B 4	71	B 3	O		Samba Whistle H				
		84	C 5	72	C 4	O		Samba Whistle L				
B4	C#5	85	C# 5	73	C# 4			Guiro Short				
		86	D 5	74	D 4	O		Guiro Long				
D5	D#5	87	D# 5	75	D# 4			Claves				Claves 2
		88	E 5	76	E 4			Wood Block H				
E5	F#5	89	F 5	77	F 4			Wood Block L				
		90	F# 5	78	F# 4			Cuica Mute		Scratch H 2		Scratch H 2
F5	G#5	91	G 5	79	G 4			Cuica Open		Scratch L 2		Scratch L 3
		92	G# 5	80	G# 4			Triangle Mute				
G5	A#5	93	A 5	81	A 4	2		Triangle Open				
		94	A# 5	82	A# 4	2		Shaker				
A5	B#5	95	B 5	83	B 4			Jingle Bells				
		96	C 6	84	C 5			Bell Tree				
B5	C#6	97	C# 6	85	C# 5							
		98	D 6	86	D 5							
D6	D#6	99	D# 6	87	D# 5							
		100	E 6	88	E 5							
E6	F#6	101	F 6	89	F 5							
		102	F# 6	90	F# 5							
F6	G#6	103	G 6	91	G 5							



		Voice No.						128	134	135	136	137	138	139
		MSB (0-127) / LSB (0-127) / PC (1-128)						127/000/001	127/000/113	127/000/033	127/000/041	127/000/049	126/000/001	126/000/002
		Keyboard		MIDI		Key Off	Alternate assign	Standard Kit 1	Dance Kit	Jazz Kit	Brush Kit	Symphony Kit	SFX Kit 1	SFX Kit 2
		Note#	Note	Note#	Note									
D0	C#0	25	C# 0	13	C# -1		3	Surdo Mute						
		26	D 0	14	D -1		3	Surdo Open						
E0	D#0	27	D# 0	15	D# -1			Hi Q						
		28	E 0	16	E -1			Whip Slap						
F0	F#0	29	F 0	17	F -1		4	Scratch H						
		30	F# 0	18	F# -1		4	Scratch L						
G0	G#0	31	G 0	19	G -1			Finger Snap						
		32	G# 0	20	G# -1			Click Noise						
A0	A#0	33	A 0	21	A -1			Metronome Click						
		34	A# 0	22	A# -1			Metronome Bell						
B0		35	B 0	23	B -1			Seq Click L						
		36	C 1	24	C 0			Seq Click H						
C1	C#1	37	C# 1	25	C# 0			Brush Tap						
		38	D 1	26	D 0	O		Brush Swirl						
D1	D#1	39	D# 1	27	D# 0			Brush Slap						
		40	E 1	28	E 0	O		Brush Tap Swirl	Reverse Cymbal					
E1	F#1	41	F 1	29	F 0	O		Snare Roll						
		42	F# 1	30	F# 0			Castanet	Hi Q 2					
G1	G#1	43	G 1	31	G 0			Snare Soft	Snare Techno	Snare Jazz H	Brush Slap 2			
		44	G# 1	32	G# 0			Sticks						
A1	A#1	45	A 1	33	A 0			Kick Soft	Kick Techno Q			Kick Soft 2		
		46	A# 1	34	A# 0			Open Rim Shot	Rim Gate					
B1		47	B 1	35	B 0			Kick Tight	Kick Techno L			Gran Cassa		
		48	C 2	36	C 1			Kick	Kick Techno	Kick Jazz	Kick Small	Gran Cassa Mute	Cutting Noise	Phone Call
C2	C#2	49	C# 2	37	C# 1			Side Stick	Side Stick Analog				Cutting Noise 2	Door Squeak
		50	D 2	38	D 1			Snare	Snare Clap	Snare Jazz L	Brush Slap 3	Band Snare		Door Slam
D2	D#2	51	D# 2	39	D# 1			Hand Clap					String Slap	Scratch Cut
		52	E 2	40	E 1			Snare Tight	Snare Dry	Snare Jazz M	Brush Tap 2	Band Snare 2		Scratch H 3
E2	F#2	53	F 2	41	F 1			Floor Tom L	Tom Analog 1	Tom Jazz 1	Tom Brush 1	Tom Jazz 1		Wind Chime
		54	F# 2	42	F# 1		1	Hi-Hat Closed	Hi-Hat Closed Analog3					Telephone Ring 2
F2	G#2	55	G 2	43	G 1			Floor Tom H	Tom Analog 2	Tom Jazz 2	Tom Brush 2	Tom Jazz 2		
		56	G# 2	44	G# 1		1	Hi-Hat Pedal	Hi-Hat Closed Analog 4					
G2	A#2	57	A 2	45	A 1			Low Tom	Tom Analog 3	Tom Jazz 3	Tom Brush 3	Tom Jazz 3		
		58	A# 2	46	A# 1		1	Hi-Hat Open	Hi-Hat Open Analog 2					
A2		59	B 2	47	B 1			Mid Tom L	Tom Analog 4	Tom Jazz 4	Tom Brush 4	Tom Jazz 4		
		60	C 3	48	C 2			Mid Tom H	Tom Analog 5	Tom Jazz 5	Tom Brush 5	Tom Jazz 5		
B2	C#3	61	C# 3	49	C# 2			Crash Cymbal 1	Crash Analog			Hand Cymbal		
		62	D 3	50	D 2			High Tom	Tom Analog 6	Tom Jazz 6	Tom Brush 6	Tom Jazz 6		
D3	D#3	63	D# 3	51	D# 2			Ride Cymbal 1				Hand Cymbal Short		
		64	E 3	52	E 2			Chinese Cymbal					Flute Key Click	Car Engine Ignition
E3	F#3	65	F 3	53	F 2			Ride Cymbal Cup						Car Tires Squeal
		66	F# 3	54	F# 2			Tambourine						Car Passing
F3	G#3	67	G 3	55	G 2			Splash Cymbal						Car Crash
		68	G# 3	56	G# 2			Cowbell	Cowbell Analog					Siren
G3	A#3	69	A 3	57	A 2			Crash Cymbal 2				Hand Cymbal 2		Train
		70	A# 3	58	A# 2			Vibraslap						Jet Plane
A3		71	B 3	59	B 2			Ride Cymbal 2				Hand Cymbal 2 Short		Starship
		72	C 4	60	C 3			Bongo H						Burst
C4	C#4	73	C# 4	61	C# 3			Bongo L						Roller Coaster
		74	D 4	62	D 3			Conga H Mute	Conga Analog H					Submarine
D4	D#4	75	D# 4	63	D# 3			Conga H Open	Conga Analog M					
		76	E 4	64	E 3			Conga L	Conga Analog L					
E4	F#4	77	F 4	65	F 3			Timbale H						
		78	F# 4	66	F# 3			Timbale L						
F4	G#4	79	G 4	67	G 3			Agogo H						
		80	G# 4	68	G# 3			Agogo L					Shower	Laugh
G4	A#4	81	A 4	69	A 3			Cabasa					Thunder	Scream
		82	A# 4	70	A# 3			Maracas	Maracas 2				Wind	Punch
A4		83	B 4	71	B 3	O		Samba Whistle H					Stream	Heartbeat
		84	C 5	72	C 4	O		Samba Whistle L					Bubble	Footsteps
C5	C#5	85	C# 5	73	C# 4			Guiro Short				Feed		
		86	D 5	74	D 4	O		Guiro Long						
D5	D#5	87	D# 5	75	D# 4			Claves	Claves 2					
		88	E 5	76	E 4			Wood Block H						
E5	F#5	89	F 5	77	F 4			Wood Block L						
		90	F# 5	78	F# 4			Cuica Mute	Scratch H 2					
F5	G#5	91	G 5	79	G 4			Cuica Open	Scratch L 3					
		92	G# 5	80	G# 4			Triangle Mute						
G5	A#5	93	A 5	81	A 4		2	Triangle Open						
		94	A# 5	82	A# 4		2	Shaker						
A5		95	B 5	83	B 4			Jingle Bells						
		96	C 6	84	C 5			Bell Tree					Dog	Machine Gun
C6	C#6	97	C# 6	85	C# 5								Horse	Laser Gun
		98	D 6	86	D 5								Bird Tweet 2	Explosion
D6	D#6	99	D# 6	87	D# 5									Firework
		100	E 6	88	E 5									
E6	F#6	101	F 6	89	F 5									
		102	F# 6	90	F# 5									
F6	G#6	103	G 6	91	G 5								Maou	



# Style List

Style No.	Style Name
<b>8BEAT</b>	
001	8BeatModern
002	Cool8Beat
003	60'sGuitarPop
004	8BeatAdria
005	60's8Beat
006	BubblegumPop
007	BritPopSwing
008	8Beat
009	OffBeat
010	60'sRock
011	HardRock
012	RockShuffle
013	8BeatRock
<b>16BEAT</b>	
014	16Beat
015	PopShuffle1
016	PopShuffle2
017	GuitarPop
018	16BeatUptempo
019	KoolShuffle
020	JazzRock
021	HipHopLight
<b>BALLAD</b>	
022	PianoBallad
023	LoveSong
024	6/8ModernEP
025	6/8SlowRock
026	6/8OrchBallad
027	OrganBallad
028	PopBallad
029	16BeatBallad1
030	16BeatBallad2
<b>DANCE</b>	
031	EuroTrance
032	Ibiza
033	DreamDance
034	HouseMusik
035	SwingHouse
036	TechnoPolis
037	Clubdance
038	ClubLatin
039	Garage1
040	Garage2
041	TechnoParty
042	UKPop
043	HipHopGroove
044	HipShuffle
045	HipHopPop
<b>DISCO</b>	
046	70'sDisco1
047	70'sDisco2
048	LatinDisco
049	DiscoPhilly
050	SaturdayNight
051	DiscoChocolate
052	DiscoHands

Style No.	Style Name
<b>SWING&amp;JAZZ</b>	
053	BigBandFast
054	BigBandMedium
055	BigBandBallad
056	BigBandShuffle
057	JazzClub
058	Swing1
059	Swing2
060	OrchestraSwing
061	Five/Four
062	JazzBallad
063	Dixieland
064	Ragtime
065	AfroCuban
066	Charleston
<b>R&amp;B</b>	
067	Soul
068	DetroitPop1
069	60'sRock&Roll
070	6/8Soul
071	CrocoTwist
072	Rock&Roll
073	DetroitPop2
074	BoogieWoogie
075	ComboBoogie
076	6/8Blues
<b>COUNTRY</b>	
077	Country8Beat
078	CountryPop
079	CountrySwing
080	CountryBallad
081	Country2/4
082	CowboyBoogie
083	CountryShuffle
084	Bluegrass
<b>LATIN</b>	
085	BrazilianSamba
086	BossaNova
087	PopBossa
088	Tijuana
089	DiscoLatin
090	Mambo
091	Salsa
092	Beguine
093	GuitarRumba
094	RumbaFlamenco
095	RumbalIsland
096	Reggae
<b>BALLROOM</b>	
097	VienneseWaltz
098	EnglishWaltz
099	Slowfox
100	Foxtrot
101	Quickstep
102	Tango
103	Pasodoble
104	Samba

Style No.	Style Name
105	ChaChaCha
106	Rumba
107	Jive
<b>TRADITIONAL</b>	
108	USMarch
109	6/8March
110	GermanMarch
111	PolkaPop
112	OberPolka
113	Tarantella
114	Showtune
115	ChristmasSwing
116	ChristmasWaltz
117	ScottishReel
118	Hawaiian
<b>WALTZ</b>	
119	ItalianWaltz
120	MariachiWaltz
121	GuitarSerenade
122	SwingWaltz
123	JazzWaltz1
124	JazzWaltz2
125	CountryWaltz
126	OberWaltzer
127	Musette
<b>CHILDREN</b>	
128	Learning2/4
129	Learning4/4
130	Learning6/8
131	Fun 3/4
132	Fun 4/4
<b>PIANIST</b>	
133	Stride
134	PianoBlues1
135	PianoBlues2
136	PianoRag
137	PianoRock&Roll
138	PianoBoogie
139	PianoJazzWaltz
140	PianoJazzBld
141	Arpeggio
142	Musical
143	Habanera
144	SlowRock
145	8BtPianoBallad
146	PianoMarch
147	6/8PianoMarch
148	PianoWaltz
149	PianoBeguine
150	PianoSwing



# Music Database List

MDB No.	Song Name
<b>POP</b>	
001	AlvFever
002	CoinLane
003	Croco Rk
004	DayPdise
005	DwnTown
006	EasySday
007	GoMyWay
008	HowDeep!
009	HurryLuv
010	I breath
011	I'IBTher
012	I'm Torn
013	Imagine
014	ISurvive
015	JustCall
016	JustWay
017	LeadPack
018	LoveFeel
019	LoveMeT
020	LveMeDo
021	Mi Shell
022	My Baby
023	NikitTrp
024	NoMatter
025	ProudGtr
026	RainOnMe
027	SailingSx
028	SeeAgain
029	Sept.Pop
030	SultanSw
031	SweetLrd
032	ThnkMsc
033	TitanicH
034	UNeedLv
035	UptnGirl
036	WantToBe
037	WatchGrl
038	WhatALoo
039	WhitePle
040	Woman
041	YellowSub
042	Yesterdy
<b>ROCK</b>	
043	DavAgain
044	JumpRock
045	OyComCha
046	PickUpPc
047	RdRiverR
048	SatsfyGt
049	Sheriff
050	SmokeWtr
051	TwistAgn
052	VenusPop
<b>DANCE</b>	
053	2 of Us
054	B Leave
055	Back St
056	Crockett
057	DsrtRose
058	FunkyTwn
059	Kids
060	KillSoft
061	Nine PM
062	SingBack
063	StrandD
<b>BALLAD</b>	
064	AdelineB
065	ArgenCry
066	BeautBdy

MDB No.	Song Name
067	BI Bayou
068	CatMemry
069	CavaSolo
070	E Weiss
071	ElizSere
072	ElvGhett
073	Feeling
074	Fly Away
075	Fnl Date
076	GreenSlv
077	GtCncert
078	HrdToSay
079	LonlyPan
080	MBoxDnce
081	Mn Rivr
082	My Song
083	NorwWood
084	OnMyMnd
085	OverRbow
086	Red Lady
087	ReleseMe
088	SavingLv
089	Shore Cl
090	SierraMd
091	SilverMn
092	SmokyEye
093	SndOfSil
094	SumerPlc
095	TblWater
096	WhereLov
097	WhisprSx
098	WomanLov
<b>R &amp; B</b>	
099	AmazingG
100	BoogiePf
101	Clock Rk
102	CU later
103	GreenDor
104	HappyDay
105	JohnnyB
106	MercySax
107	RisingSn
108	S Preems
109	SuperStv
110	TeddyBer
111	Yeh Orgn
<b>SWING &amp; JAZZ</b>	
112	Alex Rag
113	Blue Set
114	ChooChoo
115	DayOfW&R
116	HighMoon
117	InMood
118	MisJones
119	MistySax
120	MoonLit
121	New York
122	PantrSw
123	PetiteCl
124	RedRoses
125	SaintMch
126	SatinDil
127	SF Heart
128	ShearJz
129	SplnkyTb
130	SunnySde
131	TstHoney
132	Tunisia
133	TwoFoot5
134	USPatrol

MDB No.	Song Name
135	WhatsNew
136	Wild Cat
<b>EASY LISTENING</b>	
137	BlackFst
138	ByeBlues
139	CaliBlue
140	CiaoCpri
141	Close2U
142	DAmorStr
143	DolanesM
144	EIcondor
145	Entrtain
146	Frippers
147	LoveLove
148	LuckySax
149	LuvStory
150	MyPrince
151	OSoleMio
152	PupetStr
153	Raindrop
154	RedMouln
155	R'ticGtr
156	Schiwago
157	ShadowGt
158	SingRain
159	SmallWld
160	SpkSoft
161	SpnishEy
162	StrangeN
163	TieRibbn
164	TimeGoes
165	WhiteXmas
166	WishStar
167	WonderN
168	WondrWld
<b>LATIN</b>	
169	BambaLa
170	BeHappy!
171	CopaLola
172	DayNight
173	Ipanema
174	JamboMbo
175	MarinaAc
176	MuchoTrp
177	SmoothLt
178	SunOfLif
179	Sunshine
180	Tico Org
181	TrbWave
<b>COUNTRY</b>	
182	ABitMore
183	BlownWnd
184	Bonanza
185	BoxerFlt
186	CntryRds
187	GreenGrs
188	Jambala
189	LondonSt
190	LooseEL
191	TopWorld
192	YlwRose
<b>DISCO &amp; PARTY</b>	
193	AlhHwii
194	Babylon
195	Barbados
196	DnceBird
197	FestaMex
198	HandsPty
199	LuvTheme
200	ModrnTlk

MDB No.	Song Name
201	NxtAlice
202	PalomaFl
203	Tijuana
204	Why MCA?
<b>BALLROOM</b>	
205	BrazilBr
206	CherryTp
207	DanubeWv
208	MantoStr
209	SandmnFx
210	SpainTwn
211	SundyNvr
212	TangoAc
213	Tea4Two
214	TulipWtz
215	YesSirQk
<b>TRADITIONAL</b>	
216	AlpenTri
217	AnchorAw
218	Balalaik
219	BlkSheep
220	CampRace
221	Ceilidh
222	Cielito
223	CielPari
224	Cl Polka
225	Comrades
226	DAmorCl
227	FrogSong
228	Funiculi
229	GrndClok
230	HappyPlk
231	Herzlin
232	HornPipe
233	JacknJil
234	JinglBel
235	Kufstein
236	MexiHat
237	MickMrch
238	RkABaby
239	RIBarrel
240	Showbiz
241	SnowWtz
242	StarMrch
243	WashPost
244	WdCuttrs
245	XmasWalz
246	YankDood
<b>PIANIST</b>	
247	CatMemry
248	DoReMi
249	Entrtain
250	Extra
251	Favorite
252	FineRmce
253	Foggy
254	I Woman
255	JBGood
256	NitTrain
257	Obaladi
258	OldHouse
259	PubPiano
260	RinSpain
261	Sera
262	ShookUp
263	Swonder
264	TedPicnc
265	Twirler
266	WayWere
267	YesterPf



# Songs Provided On the Supplied CD-ROM

File Name	Song Name	Composer
001Nutcr.mid	Danse des Mirlitons from "The Nutcracker"	P.I. Tchaikovsky
002Orphe.mid	"Orphée aux Enfers" Overture	J. Offenbach
003Slavo.mid	Slavonic Dances op.72-2	A. Dvořák
004Prima.mid	La Primavera (from Le Quattro Stagioni)	A. Vivaldi
005Medit.mid	Méditation (Thaïs)	J. Massenet
006Guill.mid	Guillaume Tell	G. Rossini
007Fruhl.mid	Frühlingslied	F. Mendelssohn
008Ungar.mid	Ungarische Tänze Nr.5	J. Brahms
009Fruhl.mid	Frühlingsstimmen	J. Strauss II
010Dolly.mid	Dolly's Dreaming and Awakening	T.Oesten
011Cande.mid	La Candeur	J.F.Burgmüller
012Arabe.mid	Arabesque	J.F.Burgmüller
013Pasto.mid	Pastorale	J.F.Burgmüller
014Petit.mid	Petite Réunion	J.F.Burgmüller
015Innoc.mid	Innocence	J.F.Burgmüller
016Progr.mid	Progrès	J.F.Burgmüller
017Taren.mid	Tarentelle	J.F.Burgmüller
018Cheva.mid	La Chevaleresque	J.F.Burgmüller
019Etude.mid	Etude op.10-3 "Chanson de l'adieu"	F.Chopin
020Marci.mid	Marcia alla Turca	L.v. Beethoven
021Turki.mid	Turkish March	W.A. Mozart
022Valse.mid	Valse op.64-1 "Petit Chien"	F.Chopin
023Menue.mid	Menuett	L. Boccherini
024Momen.mid	Moments Musicaux op.94-3	F. Schubert
025Enter.mid	The Entertainer	S. Joplin
026Prelu.mid	Prelude (Wohltemperierte Klavier 1-1)	J.S. Bach
027Violl.mid	La Violette	L. Streabbog
028Angel.mid	Angels Serenade	Traditional
029Saraf.mid	Krasnyj Sarafan	Traditional
030Ameri.mid	America the Beautiful	S.A. Ward
031Brown.mid	Little Brown Jug	Traditional
032Lomon.mid	Loch Lomond	Traditional
033Bonni.mid	My Bonnie	Traditional
034Londo.mid	Londonderry Air	Traditional
035Banjo.mid	Ring de Banjo	S.C. Foster
036Vogle.mid	Wenn ich ein Vöglein wär ?	Traditional
037Lorel.mid	Die Lorelei	F. Silcher
038Funic.mid	Funiculi Funicula	L. Denza
039Turke.mid	Turkey in the Straw	Traditional
040Camp.mid	Camp Town Races	S.C. Foster
041Jingl.mid	Jingle Bells	J.S. Pierpont
042Muss.mid	Muss i denn	F. Silcher
043Liebe.mid	Liebesträume Nr.3	F. Liszt
044Jesu.mid	Jesu, Joy Of Man's Desiring	J.S. Bach
045Joy.mid	Ode to Joy	L.v. Beethoven
046Pearl.mid	Pearl Fisher	G. Bizet
047Gavot.mid	Gavotte	F.J. Gossec
048Seren.mid	Serenade/Haydn	F.J. Haydn
049Menue.mid	Menuett BWV. Anh.114	J.S. Bach
050Canon.mid	Canon in D	J. Pachelbel
051Vogel.mid	Der Vogelfanger Bin Ich Ja "Die Zauberflote"	W.A. Mozart
052Piano.mid	Piano Sonate No.14 op.27-2 "Mondschein"	L.v. Beethoven
053Surpr.mid	The "Surprise" Symphony No.94	F.J. Haydn
054WildR.mid	To a Wild Rose	E.A. MacDowell
055Chans.mid	Chanson du Toreador	G. Bizet
056Babbi.mid	O Mio Babbino Caro	G. Puccini
057RowRo.mid	Row Row Row Your Boat (DUET)	Traditional
058Smoky.mid	On Top of Old Smoky (DUET)	Traditional
059WeWis.mid	We Wish You A Merry Christmas (DUET)	Traditional
060ImMai.mid	Im Mai (DUET)	Traditional
061Chris.mid	O Christmas Tree (DUET)	Traditional
062MaryH.mid	Mary Had a Little Lamb (DUET)	Traditional
063TenLi.mid	Ten Little Indians (DUET)	S. Winner
064PopGo.mid	Pop Goes The Weasel (DUET)	Traditional
065Twink.mid	Twinkle Twinkle Little Star (DUET)	Traditional
066Close.mid	Close Your Hands, Open Your Hands (DUET)	J.J. Rousseau
067Cucko.mid	The Cuckoo (DUET)	Traditional
068Augus.mid	O du lieber Augustin (DUET)	Traditional
069Londo.mid	London Bridge (DUET)	Traditional
070Three.mid	Three Blind Mice (DUET)	Traditional

The easy song arranger can only be used with songs that include chord data.



# Effect Type List

## ● Harmony Types

No.	Harmony Type	Description
01	Duet	Harmony types 01–05 are pitch-based and add one-, two- or three-note harmonies to the single-note melody played in the right hand. These types sound when chords are played in the auto accompaniment range of the keyboard. These Harmony types will also work when playing songs that contain chord data.
02	Trio	
03	Block	
04	Country	
05	Octave	
06	Trill 1/4 note	<p>Types 6–26 are rhythm-based effects and add embellishments or delayed repeats in time with the auto accompaniment. These types sound whether the auto accompaniment is on or not; however, the actual speed of the effect depends on the Tempo setting (page 46). The individual note values in each type let you synchronize the effect precisely to the rhythm. Triplet settings are also available: 1/6 = quarter-note triplets, 1/12 = eighth-note triplets, 1/24 = sixteenth-note triplets.</p> <ul style="list-style-type: none"> <li>• The Trill effect Types (06–12) create two-note trills (alternating notes) when two notes are held.</li> <li>• The Tremolo effect Types (13–19) repeat all held notes (up to four).</li> <li>• The Echo effect Types (20–26) create delayed repeats of each note played.</li> </ul>
07	Trill 1/6 note	
08	Trill 1/8 note	
09	Trill 1/12 note	
10	Trill 1/16 note	
11	Trill 1/24 note	
12	Trill 1/32 note	
13	Tremolo 1/4 note	
14	Tremolo 1/6 note	
15	Tremolo 1/8 note	
16	Tremolo 1/12 note	
17	Tremolo 1/16 note	
18	Tremolo 1/24 note	
19	Tremolo 1/32 note	
20	Echo 1/4 note	
21	Echo 1/6 note	
22	Echo 1/8 note	
23	Echo 1/12 note	
24	Echo 1/16 note	
25	Echo 1/24 note	
26	Echo 1/32 note	

## ● Reverb Types

No.	Reverb Type	Description
01–03	Hall 1–3	Concert hall reverb.
04–05	Room 1–2	Small room reverb.
06–07	Stage 1–2	Reverb for solo instruments.
08–09	Plate 1–2	Simulated steel plate reverb.
10	Off	No effect.

## ● Chorus Types

No.	Chorus Type	Description
01–02	Chorus 1–2	Conventional chorus program with rich, warm chorusing.
03–04	Flanger 1–2	Pronounced three-phase modulation with a slight metallic sound.
05	Off	No effect.



# MIDI Implementation Chart

YAMAHA [ Portable Grand ] Date:17-NOV-2005  
 Model DGX-620/520, YPG-625/525 MIDI Implementation Chart Version:1.0

Function...	Transmitted	Recognized	Remarks
Basic Channel Default Changed	1 - 16 x	1 - 16 x	
Mode Default Messages Altered	3 x *****	3 x x	
Note Number : True voice	0 - 127 *****	0 - 127 0 - 127	
Velocity Note ON Note OFF	0 9nH, v=1-127 x 9nH, v=0	0 9nH, v=1-127 x	
After Touch Key's Ch's	x x	x x	
Pitch Bend	0 0-24 semi	0 0-24 semi	
Control Change	0, 32 1, 11, 84 6, 38 7, 10 64 71 72 73 74 91, 93 96-97 100-101	0 x 0 0 0 x 0 x x 0 x 0 0	Bank Select Data Entry Sustain Harmonic Content Release Time Attack Time Brightness Effect Depth RPN Inc,Dec RPN LSB,MSB

Prog Change : True #	o 0 - 127 *****	o 0 - 127
System Exclusive	o	
: Song Pos.	x	x
: Song Sel.	x	x
: Tune	x	x
System : Clock	o	o
Real Time: Commands	o	o
Aux :All Sound OFF	x	o (120, 126, 127)
:Reset All Cntrl's	x	o (121)
:Local ON/OFF	x	o (122)
:All Notes OFF	x	o (123-125)
Mes- :Active Sense	o	o
sages:Reset	x	x

\*1 Refer to #2 on page 136.

Mode 1 : OMNI ON , POLY

Mode 3 : OMNI OFF, POLY

Mode 2 : OMNI ON , MONO

Mode 4 : OMNI OFF, MONO

o : Yes

x : No



# MIDI Data Format

## NOTE:

- 1 By default (factory settings) the instrument ordinarily functions as a 16-channel multi-timbral tone generator, and incoming data does not affect the panel voices or panel settings. However, the MIDI messages listed below do affect the panel voices, auto accompaniment, and songs.
  - MIDI Master Tuning
  - System exclusive messages for changing the Reverb Type and Chorus Type.
- 2 Messages for these control change numbers cannot be transmitted from the instrument itself. However, they may be transmitted when playing the accompaniment, song or using the Harmony effect.
- 3 Exclusive
  - <GM System ON> F0H, 7EH, 7FH, 09H, 01H, F7H
    - This message automatically restores all default settings for the instrument, with the exception of MIDI Master Tuning.
  - <MIDI Master Volume> F0H, 7FH, 7FH, 04H, 01H, II, mm, F7H
    - This message allows the volume of all channels to be changed simultaneously (Universal System Exclusive).
    - The values of "mm" is used for MIDI Master Volume. (Values for "II" are ignored.)

- <MIDI Master Tuning> F0H, 43H, 1nH, 27H, 30H, 00H, 00H, mm, II, cc, F7H
  - This message simultaneously changes the tuning value of all channels.
  - The values of "mm" and "II" are used for MIDI Master Tuning.
  - The default value of "mm" and "II" are 08H and 00H, respectively. Any values can be used for "n" and "cc".
- <Reverb Type> F0H, 43H, 1nH, 4CH, 02H, 01H, 00H, mmH, IIH, F7H
  - mm : Reverb Type MSB
  - II : Reverb Type LSB
  - Refer to the Effect Map (page 136) for details.
- <Chorus Type> F0H, 43H, 1nH, 4CH, 02H, 01H, 20H, mmH, IIH, F7H
  - mm : Chorus Type MSB
  - II : Chorus Type LSB
  - Refer to the Effect Map (page 136) for details.
- 4 When the accompaniment is started, an FAH message is transmitted. When accompaniment is stopped, an FCH message is transmitted. When the clock is set to External, both FAH (accompaniment start) and FCH (accompaniment stop) are recognized.
- 5 Local ON/OFF
  - <Local ON> Bn, 7A, 7F
  - <Local OFF> Bn, 7A, 00
  - Value for "n" is ignored.

## Effect map

- \* When a Type LSB value is received that corresponds to no effect type, a value corresponding to the effect type (coming the closest to the specified value) is automatically set.
- \* The numbers in parentheses in front of the Effect Type names correspond to the number indicated in the display.

## REVERB

TYPE MSB	TYPE LSB									
	00	01	02	08	16	17	18	19	20	
000	No Effect									
001	(01)Hall1				(02)Hall2	(03)Hall3				
002	Room					(04)Room1		(05)Room2		
003	Stage				(06)Stage1	(07)Stage2				
004	Plate				(08)Plate1	(09)Plate2				
005...127	No Effect									

## CHORUS

TYPE MSB	TYPE LSB									
	00	01	02	08	16	17	18	19	20	
000...063	No Effect									
064	Thru									
065	Chorus		(02)Chorus2							
066	Celeste					(01)Chorus1				
067	Flanger			(03)Flanger1		(04)Flanger2				
068...127	No Effect									





# Specifications

## Keyboards

- DGX-620/YPG-625: 88 Graded Hammer Standard keys (A-1–C7), with Touch Response.
- DGX-520/YPG-525: 88-key box type (A-1–C7), with Touch Response.

## Display

- 320 x 240 dots LCD display (backlit)

## Setup

- STANDBY/ON
- MASTER VOLUME: MIN–MAX
- LCD CONTRAST

## Panel Controls

- SONG, VOICE, STYLE, EASY SONG ARRANGER, P.A.T. ON/OFF, LESSON L, LESSON R, LESSON START, METRONOME ON/OFF, PORTABLE GRAND, DEMO, FUNCTION, MUSIC DATABASE, HARMONY ON/OFF, DUAL ON/OFF, SPLIT ON/OFF, TEMPO/TAP, [0]–[9], [+], [-], CATEGORY, Dial, REPEAT & LEARN (ACMP ON/OFF), A-B REPEAT (INTRO/ENDING/rit.), PAUSE (SYNC START), START/STOP, REW (MAIN/AUTO FILL), FF (SYNC STOP), REGIST MEMORY ([MEMORY/BANK], [1], [2]), SONG MEMORY (REC, [1]–[5], [A]), File Control [MENU], File Control [EXECUTE], [EXIT], [LYRICS], [SCORE], [CHORD FINGERING]

## Realtime Control

- Pitch Bend Wheel

## Voice

- 127 panel voices + 12 drum/SFX kits + 361 XGlite voices
- Polyphony: 32
- DUAL
- SPLIT

## Style

- 150 Preset Styles + 1 User Style File
- Style Control: ACMP ON/OFF, SYNC STOP, SYNC START, START/STOP, INTRO/ENDING/rit., MAIN/AUTO FILL
- Fingering: Multi Finger, Full Keyboard
- Style Volume

## Music Database

- 267

## Education Feature

- Dictionary
- Lesson 1–3, Repeat & Learn

## Registration Memory

- 8 banks x 2 types

## Function

- VOLUME: Style Volume, Song Volume
- OVERALL: Tuning, Transpose, Split Point, Touch Sensitivity, Pitch Bend Range, Chord Fingering
- MAIN VOICE: Volume, Octave, Pan, Reverb Level, Chorus Level
- DUAL VOICE: Volume, Octave, Pan, Reverb Level, Chorus Level
- SPLIT VOICE: Volume, Octave, Pan, Reverb Level, Chorus Level
- EFFECT: Reverb Type, Chorus Type, Master EQ Type, Sustain
- HARMONY: Harmony Type, Harmony Volume
- Performance assistant technology: Performance assistant technology Type
- PC: PC Mode
- MIDI: Local On/Off, External Clock, Initial Send, Keyboard Out, Style Out, Song Out
- METRONOME: Time Signature Numerator, Time Signature Denominator, Metronome Volume
- SCORE: Quantize
- LESSON: Lesson Track (R), Lesson Track (L), Grade
- UTILITY: Demo Cancel, Language

## Effects

- Reverb: 9 types
- Chorus: 4 types
- Harmony: 26 types

## Song

- 30 Preset Songs + 5 User Songs + Accessory CD-ROM Songs (70)
- Song Clear, Track Clear
- Song Volume
- Song Control: REPEAT & LEARN, A-B REPEAT, PAUSE, REW, FF, START/STOP

## Performance assistant technology

- Chord, Chord/Free, Melody, Chord/Melody

## Recording

- Song
  - User Song: 5 Songs
  - Recording Tracks: 1, 2, 3, 4, 5, STYLE

## MIDI

- Local On/Off
- Initial Send
- External Clock
- Keyboard Out
- Style Out
- Song Out

## Auxiliary jacks

- PHONES/OUTPUT, DC IN 12V, USB TO HOST, USB TO DEVICE, SUSTAIN

## Amplifier

- 6W + 6W

## Speakers

- 12cm x 2 + 3cm x 2

## Power Consumption

- 22W

## Power Supply

- Adaptor: Yamaha PA-5D AC power adaptor

## Dimensions (W x D x H)

- DGX-620/YPG-625:
  - 1,398 x 457 x 153 mm (55-1/16" x 18" x 6")
  - with keyboard stand:
    - 1,405 x 485 x 773 mm (55-1/3" x 19-1/8" x 30-3/8")
- DGX-520/YPG-525:
  - 1,340 x 422 x 145 mm (52-3/4" x 16-5/8" x 5-3/4")
  - with keyboard stand:
    - 1,354 x 485 x 775 mm (53-1/3" x 19-1/8" 30-1/2")

## Weight

- DGX-620/YPG-625: 18.0kg (39 lbs. 11 oz.)  
with keyboard stand: 25.5kg (56 lbs. 3 oz.)
- DGX-520/YPG-525: 11.0kg (24 lbs. 4 oz.)  
with keyboard stand: 17.0kg (37 lbs. 8 oz.)

## Supplied Accessories

- Music Rest
- Accessory CD-ROM
- Keyboard Stand
- Owner's Manual
- Footswitch FC5
- AC Power adaptor (May not be included depending on your particular area.)

## Optional Accessories

- Headphones: HPE-150

\* Specifications and descriptions in this owner's manual are for information purposes only. Yamaha Corp. reserves the right to change or modify products or specifications at any time without prior notice. Since specifications, equipment or options may not be the same in every locale, please check with your Yamaha dealer.



- Metronome ..... 20  
MIDI ..... 100  
MIDI Data Format ..... 136  
MIDI Implementation Chart ..... 134  
Music Database ..... 53  
Music Rest ..... 11  
Mute ..... 84
- N**  
notation ..... 65
- O**  
One Touch Setting ..... 71
- P**  
P.A.T. Type ..... 35, 89  
Panel Sustain ..... 69, 88  
PC Mode ..... 101  
performance assistant technology ..... 35  
Pitch Bend Range ..... 88  
Power Adaptor ..... 10  
Preset Song ..... 29, 31–32
- Q**  
Quantize ..... 89
- R**  
Recording ..... 56  
Registration Memory ..... 85  
Remote control ..... 101  
Repeat ..... 52, 83  
Reverb ..... 67  
Reverb Type ..... 133  
R-Part ..... 89, 104
- S**  
Save (File Control) ..... 93  
Score ..... 33, 45, 118  
Single-Staff Score ..... 33  
SMF (Standard MIDI File) ..... 94  
SMF Save ..... 94  
Song ..... 29  
Song Clear ..... 59  
Song List ..... 31  
Song Memory ..... 56–57  
Song Out ..... 89, 100  
Song Volume ..... 83  
Specifications ..... 137  
Split Chorus Level ..... 88  
Split Octave ..... 88  
Split Pan ..... 88  
Split Point ..... 17, 77  
Split Reverb Level ..... 88  
Split Voice ..... 17  
Split Volume ..... 88  
Standard Chords ..... 28  
Style ..... 23, 26, 74  
Style File ..... 81, 95  
Style List ..... 130  
Style Out ..... 89, 100  
Style Volume ..... 78  
Sustain (Footswitch) ..... 10  
Sustain (Panel) ..... 69, 88  
Synchro Start ..... 24, 75  
Synchro Stop ..... 76
- T**  
Tempo ..... 46, 70  
TimeSignature  
(Denominator, Numerator) ..... 21  
Touch Response ..... 70  
Touch Sensitivity ..... 70  
Track ..... 56  
Track Clear ..... 60  
Transfer ..... 100, 102  
Transpose ..... 73  
Troubleshooting ..... 110, 112  
Tuning ..... 73
- U**  
USB ..... 97  
USB MIDI Driver ..... 108–109  
User file ..... 93, 95  
User File Save ..... 93  
User Song ..... 32, 56
- V**  
Voice ..... 15  
Voice List ..... 124
- X**  
XF ..... 6, 34  
XGlite ..... 6

# Limited Warranty

**90 DAYS LABOR**

**1 YEAR PARTS**

Yamaha Corporation of America, hereafter referred to as Yamaha, warrants to the original consumer of a product included in the categories listed below, that the product will be free of defects in materials and/or workmanship for the periods indicated. This warranty is applicable to all models included in the following series of products:

## **DGX, YPG SERIES OF Portable Grand ELECTRONIC KEYBOARDS**

If during the first 90 days that immediately follows the purchase date, your new Yamaha product covered by this warranty is found to have a defect in material and/or workmanship, Yamaha and/or its authorized representative will repair such defect without charge for parts or labor.

If parts should be required after this 90 day period but within the one year period that immediately follows the purchase date, Yamaha will, subject to the terms of this warranty, supply these parts without charge. However, charges for labor, and/or any miscellaneous expenses incurred are the consumers responsibility. Yamaha reserves the right to utilize reconditioned parts in repairing these products and/or to use reconditioned units as warranty replacements.

**THIS WARRANTY IS THE ONLY EXPRESS WARRANTY WHICH YAMAHA MAKES IN CONNECTION WITH THESE PRODUCTS. ANY IMPLIED WARRANTY APPLICABLE TO THE PRODUCT, INCLUDING THE WARRANTY OF MERCHANT ABILITY IS LIMITED TO THE DURATION OF THE EXPRESS WARRANTY. YAMAHA EXCLUDES AND SHALL NOT BE LIABLE IN ANY EVENT FOR INCIDENTAL OR CONSEQUENTIAL DAMAGES.**

Some states do not allow limitations that relate to implied warranties and/or the exclusion of incidental or consequential damages. Therefore, these limitations and exclusions may not apply to you.

This warranty gives you specific legal rights. You may also have other rights which vary from state to state.

## **CONSUMERS RESPONSIBILITIES**

If warranty service should be required, it is necessary that the consumer assume certain responsibilities:

1. Contact the Customer Service Department of the retailer selling the product, or any retail outlet authorized by Yamaha to sell the product for assistance. You may also contact Yamaha directly at the address provided below.
2. Deliver the unit to be serviced under warranty to: the retailer selling the product, an authorized service center, or to Yamaha with an explanation of the problem. Please be prepared to provide proof purchase date (sales receipt, credit card copy, etc.) when requesting service and/or parts under warranty.
3. Shipping and/or insurance costs are the consumers responsibility.\* Units shipped for service should be packed securely.

\*Repaired units will be returned PREPAID if warranty service is required within the first 90 days.

**IMPORTANT:** Do NOT ship anything to ANY location without prior authorization. A Return Authorization (RA) will be issued that has a tracking number assigned that will expedite the servicing of your unit and provide a tracking system if needed.

4. Your owners manual contains important safety and operating instructions. It is your responsibility to be aware of the contents of this manual and to follow all safety precautions.

## **EXCLUSIONS**

This warranty does not apply to units whose trade name, trademark, and/or ID numbers have been altered, defaced, exchanged removed, or to failures and/or damages that may occur as a result of:

1. Neglect, abuse, abnormal strain, modification or exposure to extremes in temperature or humidity.
2. Improper repair or maintenance by any person who is not a service representative of a retail outlet authorized by Yamaha to sell the product, an authorized service center, or an authorized service representative of Yamaha.
3. This warranty is applicable only to units sold by retailers authorized by Yamaha to sell these products in the U.S.A., the District of Columbia, and Puerto Rico. This warranty is not applicable in other possessions or territories of the U.S.A. or in any other country.

Please record the model and serial number of the product you have purchased in the spaces provided below.

Model \_\_\_\_\_ Serial # \_\_\_\_\_ Sales Slip # \_\_\_\_\_

Purchased from \_\_\_\_\_ Date \_\_\_\_\_  
(Retailer)

**YAMAHA CORPORATION OF AMERICA**  
**Electronic Service Division**  
**6600 Orangethorpe Avenue**  
**Buena Park, CA 90620**

**KEEP THIS DOCUMENT FOR YOUR RECORDS. DO NOT MAIL!**

For details of products, please contact your nearest Yamaha representative or the authorized distributor listed below.

Pour plus de détails sur les produits, veuillez-vous adresser à Yamaha ou au distributeur le plus proche de vous figurant dans la liste suivante.

Die Einzelheiten zu Produkten sind bei Ihrer unten aufgeführten Niederlassung und bei Yamaha Vertragshändlern in den jeweiligen Bestimmungsländern erhältlich.

Para detalles sobre productos, contacte su tienda Yamaha más cercana o el distribuidor autorizado que se lista debajo.

## NORTH AMERICA

### CANADA

**Yamaha Canada Music Ltd.**  
135 Milner Avenue, Scarborough, Ontario,  
M1S 3R1, Canada  
Tel: 416-298-1311

### U.S.A.

**Yamaha Corporation of America**  
6600 Orangethorpe Ave., Buena Park, Calif. 90620,  
U.S.A.  
Tel: 714-522-9011

## CENTRAL & SOUTH AMERICA

### MEXICO

**Yamaha de México S.A. de C.V.**  
Calz. Javier Rojo Gómez #1149,  
Col. Guadalupe del Moral  
C.P. 09300, México, D.F., México  
Tel: 55-5804-0600

### BRAZIL

**Yamaha Musical do Brasil Ltda.**  
Av. Reboucas 2636-Pinheiros CEP: 05402-400  
Sao Paulo-SP, Brasil  
Tel: 011-3085-1377

### ARGENTINA

**Yamaha Music Latin America, S.A.**  
**Sucursal de Argentina**  
Viamonte 1145 Piso2-B 1053,  
Buenos Aires, Argentina  
Tel: 1-4371-7021

### PANAMA AND OTHER LATIN AMERICAN COUNTRIES/ CARIBBEAN COUNTRIES

**Yamaha Music Latin America, S.A.**  
Torre Banco General, Piso 7, Urbanización Marbella,  
Calle 47 y Aquilino de la Guardia,  
Ciudad de Panamá, Panamá  
Tel: +507-269-5311

## EUROPE

### THE UNITED KINGDOM

**Yamaha-Kemble Music (U.K.) Ltd.**  
Sherbourne Drive, Tilbrook, Milton Keynes,  
MK7 8BL, England  
Tel: 01908-366700

### IRELAND

**Danfay Ltd.**  
61D, Sallynoggin Road, Dun Laoghaire, Co. Dublin  
Tel: 01-2859177

### GERMANY

**Yamaha Music Central Europe GmbH**  
Siemensstraße 22-34, 25462 Rellingen, Germany  
Tel: 04101-3030

### SWITZERLAND/LIECHTENSTEIN

**Yamaha Music Central Europe GmbH,  
Branch Switzerland**  
Seefeldstrasse 94, 8008 Zürich, Switzerland  
Tel: 01-383 3990

### AUSTRIA

**Yamaha Music Central Europe GmbH,  
Branch Austria**  
Schleiergasse 20, A-1100 Wien, Austria  
Tel: 01-60203900

### CZECH REPUBLIC/SLOVAKIA/ HUNGARY/SLOVENIA

**Yamaha Music Central Europe GmbH,  
Branch Austria, CEE Department**  
Schleiergasse 20, A-1100 Wien, Austria  
Tel: 01-602039025

### POLAND

**Yamaha Music Central Europe GmbH  
Sp.z o.o. Oddział w Polsce**  
ul. 17 Stycznia 56, PL-02-146 Warszawa, Poland  
Tel: 022-868-07-57

### THE NETHERLANDS/ BELGIUM/LUXEMBOURG

**Yamaha Music Central Europe GmbH,  
Branch Benelux**  
Clarissenhof 5-b, 4133 AB Vianen, The Netherlands  
Tel: 0347-358 040

### FRANCE

**Yamaha Musique France**  
BP 70-77312 Marne-la-Vallée Cedex 2, France  
Tel: 01-64-61-4000

### ITALY

**Yamaha Musica Italia S.P.A.**  
Viale Italia 88, 20020 Lainate (Milano), Italy  
Tel: 02-935-771

### SPAIN/PORTUGAL

**Yamaha-Hazen Música, S.A.**  
Ctra. de la Corona km. 17, 200, 28230  
Las Rozas (Madrid), Spain  
Tel: 91-639-8888

### GREECE

**Philippos Nakas S.A. The Music House**  
147 Skiathou Street, 112-55 Athens, Greece  
Tel: 01-228 2160

### SWEDEN

**Yamaha Scandinavia AB**  
J. A. Wettergrens Gata 1  
Box 30053  
S-400 43 Göteborg, Sweden  
Tel: 031 89 34 00

### DENMARK

**YS Copenhagen Liaison Office**  
Generatorvej 6A  
DK-2730 Herlev, Denmark  
Tel: 44 92 49 00

### FINLAND

**F-Musiikki Oy**  
Kluuvikatu 6, P.O. Box 260,  
SF-00101 Helsinki, Finland  
Tel: 09 618511

### NORWAY

**Norsk filial av Yamaha Scandinavia AB**  
Grini Næringspark 1  
N-1345 Østerås, Norway  
Tel: 67 16 77 70

### ICELAND

**Skifan HF**  
Skeifan 17 P.O. Box 8120  
IS-128 Reykjavik, Iceland  
Tel: 525 5000

### OTHER EUROPEAN COUNTRIES

**Yamaha Music Central Europe GmbH**  
Siemensstraße 22-34, 25462 Rellingen, Germany  
Tel: +49-4101-3030

## AFRICA

**Yamaha Corporation,  
Asia-Pacific Music Marketing Group**  
Nakazawa-cho 10-1, Hamamatsu, Japan 430-8650  
Tel: +81-53-460-2312

## MIDDLE EAST

### TURKEY/CYPRUS

**Yamaha Music Central Europe GmbH**  
Siemensstraße 22-34, 25462 Rellingen, Germany  
Tel: 04101-3030

### OTHER COUNTRIES

**Yamaha Music Gulf FZE**  
LB21-128 Jebel Ali Freezone  
P.O.Box 17328, Dubai, U.A.E.  
Tel: +971-4-881-5868

## ASIA

### THE PEOPLE'S REPUBLIC OF CHINA

**Yamaha Music & Electronics (China) Co.,Ltd.**  
25/F., United Plaza, 1468 Nanjing Road (West),  
Jingan, Shanghai, China  
Tel: 021-6247-2211

### HONG KONG

**Tom Lee Music Co., Ltd.**  
11/F., Silvercord Tower 1, 30 Canton Road,  
Tsimshatsui, Kowloon, Hong Kong  
Tel: 2737-7688

### INDONESIA

**PT. Yamaha Music Indonesia (Distributor)  
PT. Nusantik**  
Gedung Yamaha Music Center, Jalan Jend. Gatot  
Subroto Kav. 4, Jakarta 12930, Indonesia  
Tel: 21-520-2577

### KOREA

**Yamaha Music Korea Ltd.**  
Tong-Yang Securities Bldg. 16F 23-8 Yoido-dong,  
Youngdungpo-ku, Seoul, Korea  
Tel: 02-3770-0660

### MALAYSIA

**Yamaha Music Malaysia, Sdn., Bhd.**  
Lot 8, Jalan Perbandaran, 47301 Kelana Jaya,  
Petaling Jaya, Selangor, Malaysia  
Tel: 3-78030900

### PHILIPPINES

**Yupangco Music Corporation**  
339 Gil J. Puyat Avenue, P.O. Box 885 MCPO,  
Makati, Metro Manila, Philippines  
Tel: 819-7551

### SINGAPORE

**Yamaha Music Asia Pte., Ltd.**  
#03-11 A-Z Building  
140 Paya Lebar Road, Singapore 409015  
Tel: 747-4374

### TAIWAN

**Yamaha KHS Music Co., Ltd.**  
3F, #6, Sec.2, Nan Jing E. Rd. Taipei.  
Taiwan 104, R.O.C.  
Tel: 02-2511-8688

### THAILAND

**Siam Music Yamaha Co., Ltd.**  
891/1 Siam Motors Building, 15-16 floor  
Rama 1 road, Wangmai, Pathumwan  
Bangkok 10330, Thailand  
Tel: 02-215-2626

### OTHER ASIAN COUNTRIES

**Yamaha Corporation,  
Asia-Pacific Music Marketing Group**  
Nakazawa-cho 10-1, Hamamatsu, Japan 430-8650  
Tel: +81-53-460-2317

## OCEANIA

### AUSTRALIA

**Yamaha Music Australia Pty. Ltd.**  
Level 1, 99 Queensbridge Street, Southbank,  
Victoria 3006, Australia  
Tel: 3-9693-5111

### NEW ZEALAND

**Music Houses of N.Z. Ltd.**  
146/148 Captain Springs Road, Te Papapa,  
Auckland, New Zealand  
Tel: 9-634-0099

### COUNTRIES AND TRUST TERRITORIES IN PACIFIC OCEAN

**Yamaha Corporation,  
Asia-Pacific Music Marketing Group**  
Nakazawa-cho 10-1, Hamamatsu, Japan 430-8650  
Tel: +81-53-460-2312

**HEAD OFFICE** Yamaha Corporation, Pro Audio & Digital Musical Instrument Division  
Nakazawa-cho 10-1, Hamamatsu, Japan 430-8650  
Tel: +81-53-460-3273



Yamaha Home Keyboards Home Page (English Only)  
<http://music.yamaha.com/homekeyboard>  
Yamaha Manual Library  
<http://www.yamaha.co.jp/manual/>

U.R.G., Pro Audio & Digital Musical Instrument Division, Yamaha Corporation  
© 2006 Yamaha Corporation

WG29380 XXXPOXXX.X-01A0  
Printed in China