





RX-497

Stereo Receiver

OWNER'S MANUAL

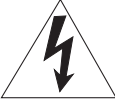
IMPORTANT SAFETY INSTRUCTIONS

	CAUTION RISK OF ELECTRIC SHOCK DO NOT OPEN	
<p>CAUTION: TO REDUCE THE RISK OF ELECTRIC SHOCK, DO NOT REMOVE COVER (OR BACK). NO USER-SERVICEABLE PARTS INSIDE. REFER SERVICING TO QUALIFIED SERVICE PERSONNEL.</p>		

• Explanation of Graphical Symbols



The lightning flash with arrowhead symbol, within an equilateral triangle, is intended to alert you to the presence of uninsulated “dangerous voltage” within the product’s enclosure that may be of sufficient magnitude to constitute a risk of electric shock to persons.



The exclamation point within an equilateral triangle is intended to alert you to the presence of important operating and maintenance (servicing) instructions in the literature accompanying the appliance.

Note to CATV system installer:

This reminder is provided to call the CATV system installer’s attention to Article 820-40 of the NEC that provides guidelines for proper grounding and, in particular, specifies that the cable ground shall be connected to the grounding system of the building, as close to the point of cable entry as practical.

IMPORTANT

Please record the serial number of this unit in the space below.

MODEL:

Serial No.:

The serial number is located on the rear of the unit.

Retain this Owner’s Manual in a safe place for future reference.

- 1 Read these instructions.
- 2 Keep these instructions.
- 3 Heed all warnings.
- 4 Follow all instructions.
- 5 Do not use this apparatus near water.
- 6 Clean only with dry cloth.
- 7 Do not block any ventilation openings. Install in accordance with the manufacturer’s instructions.
- 8 Do not install near any heat sources such as radiators, heat registers, stoves, or other apparatus (including amplifiers) that produce heat.
- 9 Do not defeat the safety purpose of the polarized or grounding-type plug. A polarized plug has two blades with one wider than the other. A grounding type plug has two blades and a third grounding prong. The wide blade or the third prong are provided for your safety. If the provided plug does not fit into your outlet, consult an electrician for replacement of the obsolete outlet.
- 10 Protect the power cord from being walked on or pinched particularly at plugs, convenience receptacles, and the point where they exit from the apparatus.
- 11 Only use attachments/accessories specified by the manufacturer.
- 12 Use only with the cart, stand, tripod, bracket, or table specified by the manufacturer, or sold with the apparatus. When a cart is used, use caution when moving the cart/apparatus combination to avoid injury from tip-over.
- 13 Unplug this apparatus during lightning storms or when unused for long periods of time.
- 14 Refer all servicing to qualified service personnel. Servicing is required when the apparatus has been damaged in any way, such as power-supply cord or plug is damaged, liquid has been spilled or objects have fallen into the apparatus, the apparatus has been exposed to rain or moisture, does not operate normally, or has been dropped.



We Want You Listening For A Lifetime

YAMAHA and the Electronic Industries Association’s Consumer Electronics Group want you to get the most out of your equipment by playing it at a safe level. One that lets the sound come through loud and clear without annoying blaring or distortion – and, most importantly, without affecting your sensitive hearing. Since hearing damage from loud sounds is often undetectable until it is too late, YAMAHA and the Electronic Industries Association’s Consumer Electronics Group recommend you to avoid prolonged exposure from excessive volume levels.



FCC INFORMATION (for US customers)

1 **IMPORTANT NOTICE: DO NOT MODIFY THIS UNIT!**

This product, when installed as indicated in the instructions contained in this manual, meets FCC requirements. Modifications not expressly approved by Yamaha may void your authority, granted by the FCC, to use the product.

2 **IMPORTANT:** When connecting this product to accessories and/or another product use only high quality shielded cables. Cable/s supplied with this product **MUST** be used. Follow all installation instructions. Failure to follow instructions could void your FCC authorization to use this product in the USA.

3 **NOTE:** This product has been tested and found to comply with the requirements listed in FCC Regulations, Part 15 for Class "B" digital devices. Compliance with these requirements provides a reasonable level of assurance that your use of this product in a residential environment will not result in harmful interference with other electronic devices.

This equipment generates/uses radio frequencies and, if not installed and used according to the instructions found in the users manual, may cause interference harmful to the operation of other electronic devices.

Compliance with FCC regulations does not guarantee that interference will not occur in all installations. If this product is found to be the source of interference, which can be determined by turning the unit "OFF" and "ON", please try to eliminate the problem by using one of the following measures:

Relocate either this product or the device that is being affected by the interference.

Utilize power outlets that are on different branch (circuit breaker or fuse) circuits or install AC line filter/s.

In the case of radio or TV interference, relocate/reorient the antenna. If the antenna lead-in is 300 ohm ribbon lead, change the lead-in to coaxial type cable.

If these corrective measures do not produce satisfactory results, please contact the local retailer authorized to distribute this type of product. If you can not locate the appropriate retailer, please contact Yamaha Electronics Corp., U.S.A. 6660 Orangethorpe Ave, Buena Park, CA 90620.

The above statements apply **ONLY** to those products distributed by Yamaha Corporation of America or its subsidiaries.

CAUTION: READ THIS BEFORE OPERATING YOUR UNIT.

- 1 To assure the finest performance, please read this manual carefully. Keep it in a safe place for future reference.
- 2 Install this sound system in a well ventilated, cool, dry, clean place – away from direct sunlight, heat sources, vibration, dust, moisture, and/or cold. Allow ventilation space of at least 30 cm on the top, 20 cm on the left and right, and 20 cm on the back of this unit.
- 3 Locate this unit away from other electrical appliances, motors, or transformers to avoid humming sounds.
- 4 Do not expose this unit to sudden temperature changes from cold to hot, and do not locate this unit in an environment with high humidity (i.e. a room with a humidifier) to prevent condensation inside this unit, which may cause an electrical shock, fire, damage to this unit, and/or personal injury.
- 5 Avoid installing this unit where foreign objects may fall onto this unit and/or this unit may be exposed to liquid dripping or splashing. On the top of this unit, do not place:
 - Other components, as they may cause damage and/or discoloration on the surface of this unit.
 - Burning objects (i.e. candles), as they may cause fire, damage to this unit, and/or personal injury.
 - Containers with liquid in them, as they may fall and liquid may cause electrical shock to the user and/or damage to this unit.
- 6 Do not cover this unit with a newspaper, tablecloth, curtain, etc. in order not to obstruct heat radiation. If the temperature inside this unit rises, it may cause fire, damage to this unit, and/or personal injury.
- 7 Do not plug in this unit to a wall outlet until all connections are complete.
- 8 Do not operate this unit upside-down. It may overheat, possibly causing damage.
- 9 Do not use force on switches, knobs and/or cords.
- 10 When disconnecting the power cable from the wall outlet, grasp the plug; do not pull the cable.
- 11 Do not clean this unit with chemical solvents; this might damage the finish. Use a clean, dry cloth.
- 12 Only voltage specified on this unit must be used. Using this unit with a higher voltage than specified is dangerous and may cause fire, damage to this unit, and/or personal injury. YAMAHA will not be held responsible for any damage resulting from use of this unit with a voltage other than specified.
- 13 To prevent damage by lightning, keep the power cord and outdoor antennas disconnected from a wall outlet or the unit during a lightning storm.
- 14 Do not attempt to modify or fix this unit. Contact qualified YAMAHA service personnel when any service is needed. The cabinet should never be opened for any reasons.
- 15 When not planning to use this unit for long periods of time (i.e. vacation), disconnect the AC power plug from the wall outlet.
- 16 Install this unit near the AC outlet and where the AC power plug can be reached easily.
- 17 Be sure to read the “TROUBLESHOOTING” section on common operating errors before concluding that this unit is faulty.
- 18 Before moving this unit, press MASTER ON/OFF to release it outward to the OFF position, and disconnect the AC power plug from the wall outlet.
- 19 **VOLTAGE SELECTOR (Asia and General models only)**
The VOLTAGE SELECTOR on the rear panel of this unit must be set for your local main voltage BEFORE plugging into the AC main supply. Voltages are:
General modelAC 110/120/220/230–240 V, 50/60 Hz
Asia model AC 220/230–240 V, 50/60 Hz

WARNING

TO REDUCE THE RISK OF FIRE OR ELECTRIC SHOCK, DO NOT EXPOSE THIS UNIT TO RAIN OR MOISTURE.

As long as this unit is connected to the AC wall outlet, it is not disconnected from the AC power source even if you turn off this unit by MASTER ON/OFF, or MAIN ZONE ON/OFF and ZONE 2 ON/OFF. In this state, this unit is designed to consume a very small quantity of power.

FOR CANADIAN CUSTOMERS

To prevent electric shock, match wide blade of plug to wide slot and fully insert.
This Class B digital apparatus complies with Canadian ICES-003.

POUR LES CONSOMMATEURS CANADIENS

Pour éviter les chocs électriques, introduire la lame la plus large de la fiche dans la borne correspondante de la prise et pousser jusqu'au fond.
Cet appareil numérique de la classe B est conforme à la norme NMB-003 du Canada.

CONTENTS

INTRODUCTION

FEATURES	2
SUPPLIED ACCESSORIES	2
CONTROLS AND FUNCTIONS	3
Front panel.....	3
Front panel display.....	5
Rear panel.....	6
Remote control.....	7
Installing batteries in the remote control.....	9
Using the remote control.....	9

PREPARATION

CONNECTIONS	10
Connecting speakers.....	11
Connecting the AM and FM antennas.....	12
Connecting the power supply cord.....	14
Turning on and off this unit.....	14

BASIC OPERATION

PLAYING AND RECORDING	15
Playing a source.....	15
Adjusting the tonal quality.....	16
Recording a source.....	17
Using the sleep timer.....	18
Muting the sound output.....	19
FM/AM TUNING	20
Automatic tuning.....	20
Manual tuning.....	21
Automatic preset tuning.....	22
Manual preset tuning.....	24
Selecting preset stations.....	25
Exchanging preset stations.....	25
XM SATELLITE RADIO TUNING	26
What is XM Satellite Radio?.....	26
XM Satellite Radio connections.....	26
XM Satellite Radio functions.....	27
Activating XM Satellite Radio.....	29
Basic XM Satellite Radio operations.....	30
XM Satellite Radio search modes.....	31
Setting XM Satellite Radio preset channels.....	33

ADVANCED OPERATION

ADVANCED SETUP	35
Changing the ADVANCED SETUP menu parameters.....	35
Switching the remote control ID.....	36
ZONE 2	37
Connecting the Zone 2 components.....	37
Controlling Zone 2.....	38
REMOTE CONTROL FEATURES	39
Control area.....	39
Controlling other components.....	40
Setting remote control codes.....	41

ADDITIONAL INFORMATION

TROUBLESHOOTING	42
SPECIFICATIONS	45

INTRODUCTION

PREPARATION

BASIC OPERATION

ADVANCED OPERATION

ADDITIONAL INFORMATION

FEATURES

Built-in 2-channel power amplifier

- ◆ Minimum RMS output power
75 W + 75 W (8 Ω), 0.04% THD, 20 Hz to 20 kHz
- ◆ Highly dynamic power, low impedance drive capability

Sophisticated AM/FM tuner

- ◆ 40-station random access preset tuning
- ◆ Automatic preset tuning
- ◆ Preset station exchanging capability
- ◆ Radio Data System tuning capability
(Europe model only)

XM Satellite Radio

(U.S.A. model only)

- ◆ XM Satellite Radio tuning capability using the XM Connect-and-Play™ digital antenna accessory (sold separately)

Other features

- ◆ PURE DIRECT button used to reproduce the purest source sound
- ◆ Continuously variable loudness control
- ◆ Sleep timer
- ◆ Remote control capability
- ◆ Zone 2 remote control (sold separately) capability
- ◆ Zone 2 custom installation facility

•  indicates a tip for your operation.

- Some operations can be performed by using either the buttons on the front panel of this unit or those on the remote control. In case the button names differ between this unit and the remote control, the names of the buttons on the remote control are given in parentheses.
- This manual is printed prior to production. Design and specifications are subject to change in part as a result of improvements, etc. In case of differences between the manual and the product, the product has priority.

SUPPLIED ACCESSORIES

Please check that you received all of the following parts.

Remote control

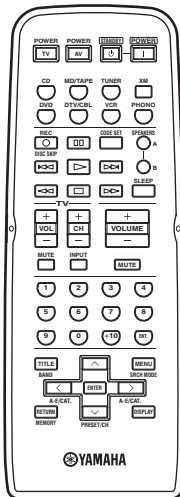

Batteries (x2) (AA, R6, UM-3)

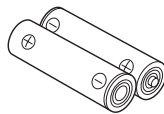

AM loop antenna



Indoor FM antenna (U.S.A., Canada and General models)

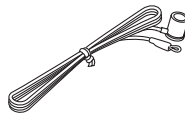

Indoor FM antenna (Europe and Australia models)

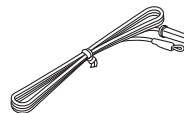

CONTROLS AND FUNCTIONS

Front panel

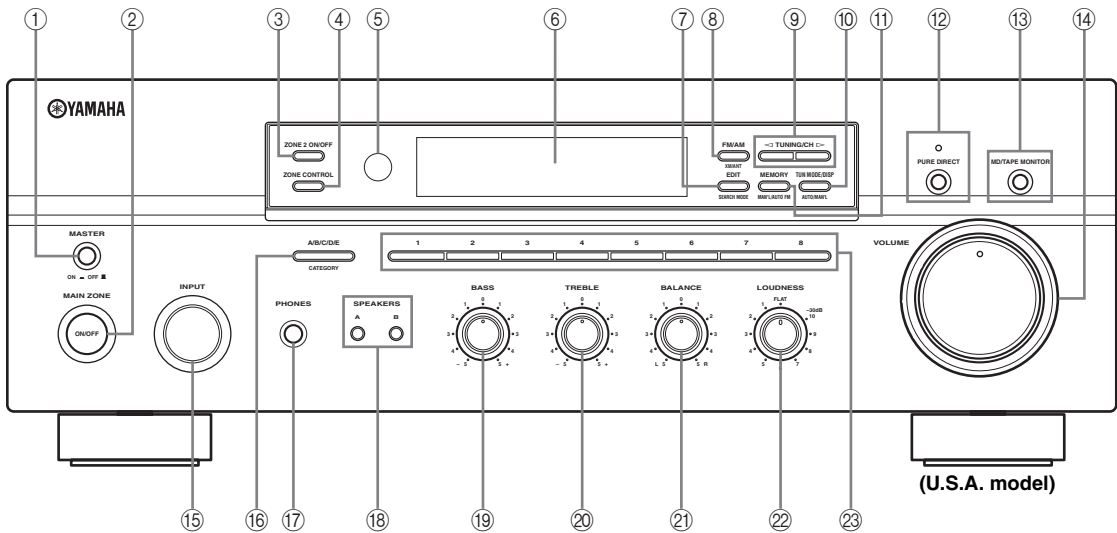

① MASTER ON/OFF

Press inward to the ON position to turn on the power of this unit. Press again to release it outward to the OFF position to turn off this unit. See page 14 for details.

Note

Even when this unit is turned off, this unit consumes a small amount of power to preserve the memory.

Memory back-up

The memory back-up circuit prevents the stored data from being lost. However, the stored data will be lost if the power cord is disconnected from the AC wall outlet for more than one week.

② MAIN ZONE ON/OFF

Turns on Main Zone of this unit or sets it to the standby mode. See page 14 for details.

Notes

- This switch is operational only when MASTER ON/OFF is pressed inward to the ON position.
- In the standby mode, this unit consumes a small amount of power to receive infrared signals from the remote control.

③ ZONE 2 ON/OFF

Turns on Zone 2 or set it to the standby mode. When Zone 2 is turned on, signals are output at the ZONE 2 OUT jacks.

Note

This switch is operational only when MASTER ON/OFF is pressed inward to the ON position.

④ ZONE CONTROL

Press to control the input source of Zone 2.

Notes

- This button is operational only when Zone 2 is turned on.
- When you press this button, the ZONE 2 indicator flashes in the front panel display for approximately 5 seconds. Select the input source of Zone 2 while the indicator is flashing.
- You can select the preset station or channel when TUNER or XM is selected as the input source of Zone 2.

⑤ Remote control sensor

Receives infrared signals from the remote control.

Note

Switch the remote control ID between ID1 and ID2 when using multiple YAMAHA receivers or amplifiers (see pages 35, 36).

⑥ Front panel display

Shows information about the operational status of this unit.

⑦ EDIT, SEARCH MODE

Exchanges the assignment of two preset stations with each other when TUNER is selected as the input source (see page 25).

Switches between search modes when XM is selected as the input source (see page 29).

⑧ FM/AM, XM ANT (ANTENNA)

Switches the reception band between AM and FM when TUNER is selected as the input source (see page 20).

Shows the reception level of the XM Connect-and-Play digital antenna (sold separately) when XM is selected as the input source (see page 27).

⑨ TUNING/CH ◀ / ▶

Selects the tuning frequency when TUNER is selected as the input source (see page 20).

Searches for a radio channel or selects the preset channel number when XM is selected as the input source (see page 27).

⑩ TUN (TUNING) MODE/DISP (DISPLAY)

Switches the tuning mode between automatic (the AUTO indicator turns on as a result) and manual (the AUTO indicator turns off as a result) when TUNER is selected as the input source.

Switches the XM Satellite Radio information shown in the front panel display between channel number/name, category and artist name/song title when XM is selected as the input source (see page 30).

⑪ MEMORY

Stores a station in the system memory (see page 24).

Sets this unit to the automatic preset tuning mode (see page 22).

Stores a radio channel in the system memory when XM is selected as the input source (see page 33).

⑫ PURE DIRECT and indicator

Allows you to listen to a source in the purest possible sound. The indicator above it lights up when this function is turned on (see page 16).

⑬ MD/TAPE MONITOR

Allows you to listen to the sound played back on the component connected to the MD/TAPE jacks on the rear panel of this unit.

When the tape deck is used for recording, you can also monitor the sound being recorded.

The MD/TAPE MON indicator in the front panel display lights up when this function is turned on.

Notes

- When this function is on (the indicator lights up), MD/TAPE cannot be selected with the INPUT selector.
- To listen to the source selected with the INPUT selector, press again to turn off the function (the indicator turns off as a result).
- When MD/TAPE is selected with the INPUT selector, this function will not turn on even if MD/TAPE MONITOR is pressed.

⑭ VOLUME

Increases or decreases the sound output level.

Note

This does not affect the OUT (REC) level.

⑮ INPUT selector

Selects the input source you want to listen to or watch.

⑯ A/B/C/D/E, CATEGORY

Selects the preset station group (A to E) when TUNER is selected as the input source (see page 23).

Switches between channel categories or selects the preset channel group when XM is selected as the input source (see page 31).

⑰ PHONES jack

Outputs audio for private listening with your headphones.

Note

Press SPEAKERS A/B so that the SP A/B indicators turn off before you connect your headphones to the PHONES jack.

⑱ SPEAKERS A/B

Turns on or off the speaker set connected to the SPEAKERS A and/or SPEAKERS B terminals on the rear panel each time the corresponding button is pressed (see page 15).

⑲ BASS

Increases or decreases the low frequency response. The 0 position produces a flat response (see page 16).

⑳ TREBLE

Increases or decreases the high frequency response. The 0 position produces a flat response (see page 16).

㉑ BALANCE

Adjusts the sound output balance of the left and right speakers to compensate for sound imbalances caused by speaker locations or listening room conditions (see page 16).

㉒ LOUDNESS

Retains a full tonal range at any volume level to compensate for the human ears' loss of sensitivity to high and low-frequency ranges at a low volume level (see page 16).

㉓ Preset station/channel number buttons (1 to 8)

Selects the preset station number (1 to 8) directly when TUNER or XM is selected as the input source (see page 25).

Note

The XM Satellite Radio features (XM ANT, CH, SEARCH MODE, DISP, CATEGORY, MEMORY and the preset channel number buttons) are only applicable to the U.S.A. model and are operational only when XM is selected as the input source. For details, see "XM SATELLITE RADIO TUNING" on page 26.

Front panel display

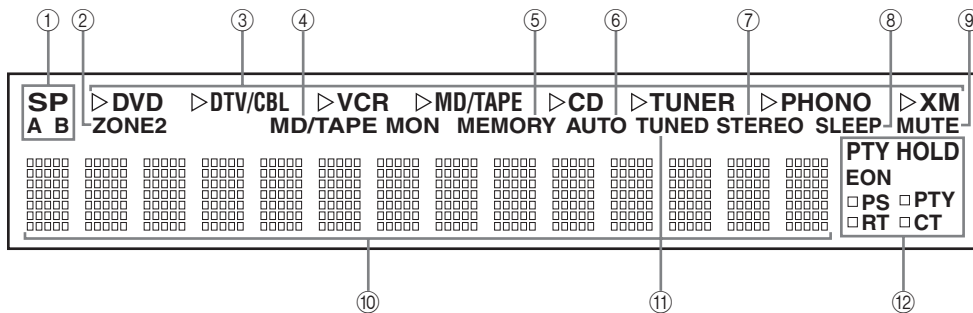

① SP (SPEAKERS) A/B indicators

Light up according to the set of speakers selected. Both indicators light up when both sets of speakers are selected.

② ZONE 2 indicator

Lights up when Zone 2 is turned on.

③ Input source indicators

Light up when this unit is in the corresponding mode.

Note

The XM indicator is only applicable to the U.S.A. model.

④ MD/TAPE MON (MONITOR) indicator

Lights up while the MD/TAPE monitor function is turned on.

⑤ MEMORY indicator

Flashes for approximately 5 seconds after MEMORY on the front panel is pressed. While the MEMORY indicator is flashing, store the displayed station in the system memory by using A/B/C/D/E and one of the preset station number buttons on the front panel.

⑥ AUTO indicator

Lights up when this unit is in the automatic tuning mode.

⑦ STEREO indicator

Lights up when this unit is receiving a strong signal for an FM stereo broadcast while the AUTO indicator is lit.

⑧ SLEEP indicator

Lights up when the sleep timer is turned on.

⑨ MUTE indicator

Flashes while the MUTE function is turned on.

⑩ Multi-information display

Shows information when adjusting or changing settings.

⑪ TUNED indicator

Lights up when this unit is tuned into a station.

■ Europe model only

⑫ Radio Data System indicators

The box-shaped indicator beside the name of each Radio Data System mode lights up when the corresponding Radio Data System mode is selected.

PTY HOLD indicator

Lights up while searching for stations in the PTY SEEK mode.

EON indicator

Lights up when the Radio Data System station that offers the EON data service is being received.

Rear panel

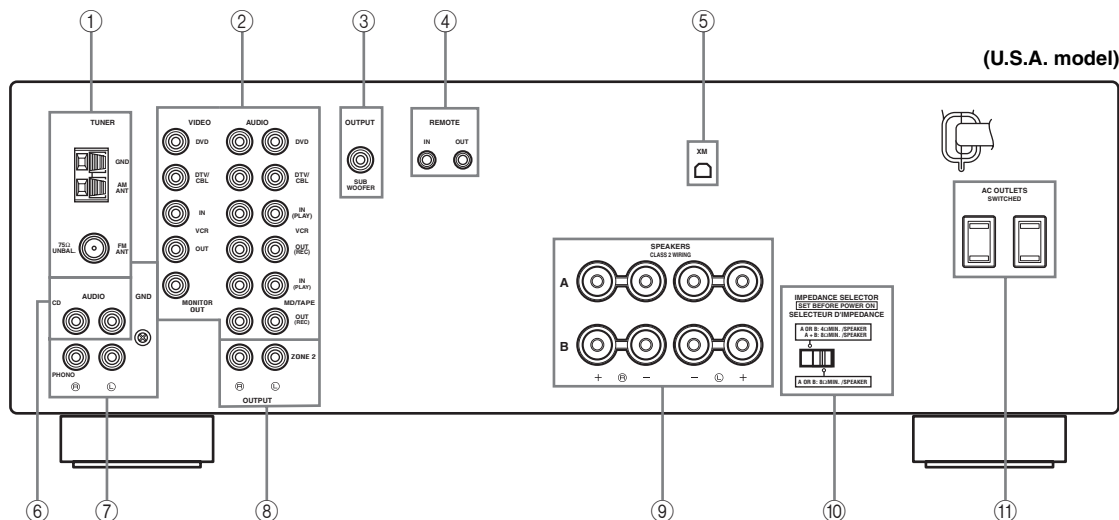

(U.S.A. model)

① Antenna terminals

Connect FM and AM antennas.
See page 12 for connections information.

② AUDIO/VIDEO jacks

Connect audio and video components.
See page 10 for connection information.

③ SUB WOOFER OUTPUT jack

Connect a subwoofer with built-in amplifier.

④ REMOTE jacks

These jacks are used to input/output remote control signals.
See page 37 for connection information.

**⑤ XM jack
(U.S.A. model only)**

Connect XM Connect-and-Play digital antenna accessory.
See page 26 for connection information.

⑥ CD jacks

Connect a CD player.
See page 10 for connection information.

⑦ PHONO jacks and GND terminal

Connect a turntable.
See page 10 for connection information.

⑧ ZONE 2 jacks

Connect a Zone 2 component.
See page 37 for connection information.

⑨ SPEAKERS terminals

Connect speakers.
See page 11 for connection information.

⑩ IMPEDANCE SELECTOR switch

Switches the impedance setting.
See page 11 for details.

⑪ AC OUTLET(S) (SWITCHED)

Use to supply power to your other audio and video components.
See page 14 for details.

■ Asia and General models only

VOLTAGE SELECTOR

VOLTAGE SELECTOR on the rear panel of this unit must be set for your local main voltage BEFORE plugging the power supply cord into the AC wall outlet.

Voltages are as follows:

Asia model AC 220/230–240 V, 50/60 Hz
General model..... AC 110/120/220/230–240 V, 50/60 Hz

Remote control

This section describes the function of each button on the remote control used to control this unit or other components made by YAMAHA or other manufacturers. The functions of the buttons used to control your other audio and video components are the same as those of the corresponding buttons on those components. Refer to those components' instruction manuals for details. To operate other components using this remote control, see "REMOTE CONTROL FEATURES" on page 39.

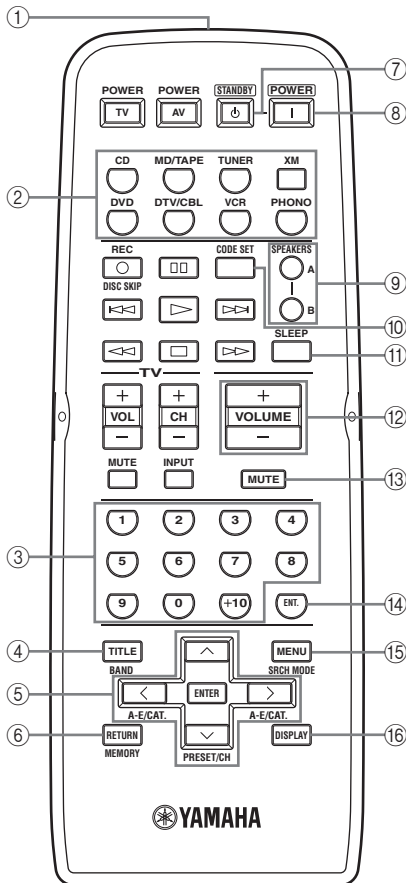

(U.S.A. model)

① Infrared signal transmitter

Sends infrared signals.

② Input selector buttons

Select the desired input source and change the control area (see page 39).

③ Numeric buttons

Select the preset station number (1 to 8) when TUNER is selected as the input source.

Select the preset channel number when XM is selected as the input source.

④ BAND

Switches to the previously used reception band (FM or AM) when TUNER is selected as the input source.

Note

The frequency of the previously received station is automatically recalled.

⑤ A-E/CAT. (CATEGORY) < / >

Selects the preset station group (A to E) when TUNER is selected as the input source (see page 25).

Switches between channel categories or selects the preset channel group (A to E) when XM is selected as the input source (see page 31).

PRESET/CH ^ / v

Selects the preset station number (1 to 8) when TUNER is selected as the input source (see page 25).

Searches for a radio channel or selects the preset channel number (1 to 8) when XM is selected as the input source (see page 29).

⑥ MEMORY

Stores a radio channel in the system memory when XM is selected as the input source (see page 33).

⑦ STANDBY

Sets this unit to the standby mode.

Notes

- This button is operational only when MASTER ON/OFF on the front panel is pressed inward to the ON position.
- In the standby mode, this unit consumes a small amount of power to receive infrared signals from the remote control.
- This button does not set Zone 2 to the standby mode.

⑧ POWER

Turns on this unit.

Notes

- This button is operational only when MASTER ON/OFF on the front panel is pressed inward to the ON position.
- This button does not turn on Zone 2.

⑨ SPEAKERS A/B

Turns on or off the set of speakers connected to the SPEAKERS A and/or SPEAKERS B terminals on the rear panel of this unit when the corresponding button is pressed each time.

⑩ CODE SET

Use to set up remote control codes (see page 41).

⑪ SLEEP

Sets the sleep timer.

⑫ VOLUME +/-

Increases or decreases the sound output level.

Notes

- This does not affect the OUT (REC) level.
- When you press VOLUME +/- to control the sound output level of this unit, VOLUME on the front panel rotates.

⑬ MUTE

Mutes the sound output. Press again to restore the sound output to the previous volume level (see page 19).

Note

The sound output to Zone 2 is not muted.

⑭ ENT. (ENTER)

Confirms an entered channel number during the Direct Number Access mode when XM is selected as the input source.

⑮ SRCH (SEARCH) MODE

Switches between the XM Satellite Radio search modes (see page 31) when XM is selected as the input source.

⑯ DISPLAY

Switches the XM Satellite Radio information shown in the front panel display between channel number/name, category and artist name/song title when XM is selected as the input source.

Note

The XM Satellite Radio features (XM, SRCH MODE, DISPLAY, A-E/CAT. < / >, PRESET/CH ^ / v, MEMORY and ENT.) are only applicable to the U.S.A. model and are operational only when XM is selected as the input source. For details, see "XM SATELLITE RADIO TUNING" on page 26.

Installing batteries in the remote control

■ Notes on batteries

- Change all of the batteries if the operation range of the remote control decreases.
- Use AA, R6, UM-3 batteries for the remote control.
- Make sure that the polarities are correct. See the illustration inside the battery compartment of each remote control.
- Remove the batteries if the remote control is not used for an extended period of time.
- Do not use old batteries together with new ones.
- Do not use different types of batteries (such as alkaline and manganese batteries) together. Read the packaging carefully as these different types of batteries may have the same shape and color.
- We strongly recommend using alkaline batteries.
- If the batteries have leaked, dispose of them immediately. Avoid touching the leaked material or letting it come into contact with clothing, etc. Clean the battery compartment thoroughly before installing new batteries.
- Do not throw away batteries with general house waste; dispose of them correctly in accordance with your local regulations.

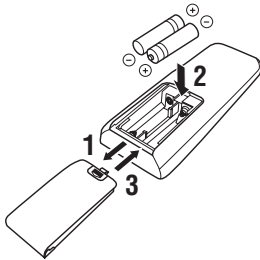

1 Open the battery compartment cover.

2 Insert the supplied batteries in each remote control according to the polarity markings (+ and -) on the inside of the battery compartment.

3 Close the cover back.

Using the remote control

The remote control transmit a directional infrared beam.

Be sure to aim the remote control directly at the remote control sensor on the front panel of this unit or on the infrared signal receiver in Zone 2 during operation.

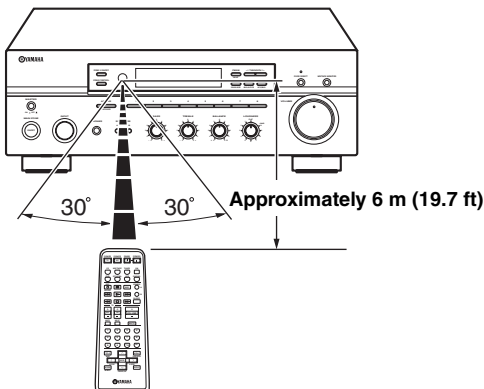

■ Handling the remote control

- The area between the remote control and this unit (or the infrared signal receiver in Zone 2) must be clear of large obstacles.
- Do not spill water or other liquids on the remote control.
- Do not drop the remote control.
- Do not leave or store the remote control in the following types of conditions:
 - places of high humidity, such as near a bath
 - places of high temperature, such as near a heater or a stove
 - places of extremely low temperatures
 - dusty places
- Do not expose the remote control sensor to strong lighting, in particular, an inverter type fluorescent lamp; otherwise, the remote control may not work properly. If necessary, position this unit away from direct lighting.

CONNECTIONS

CAUTION

- Do not connect this unit or other components to the main power until all connections between components are complete.
- Do not let the bare speaker wires touch each other or do not let them touch any metal part of this unit. This could damage this unit and/or the speakers.
- All connections must be correct: L (left) to L, R (right) to R, “+” to “+” and “-” to “-”. If the connections are faulty, no sound will be heard from the speakers, and if the polarity of the speaker connections is incorrect, the sound will be unnatural and lack bass. Also, refer to the owner’s manual for each of your components.
- Use the RCA type pin plug cables for audio and video components except speakers.



- The PHONO jacks are designed to connect a turntable with an MM or high-output MC cartridge. If you have a turntable with a low-output MC cartridge, use an in-line boosting transformer or an MC-head amplifier when connecting your turntable to the PHONO jacks.
- Connect your turntable to the GND terminal to reduce noise in the signal. However, you may hear less noise without the connection to the GND terminal for some record players.

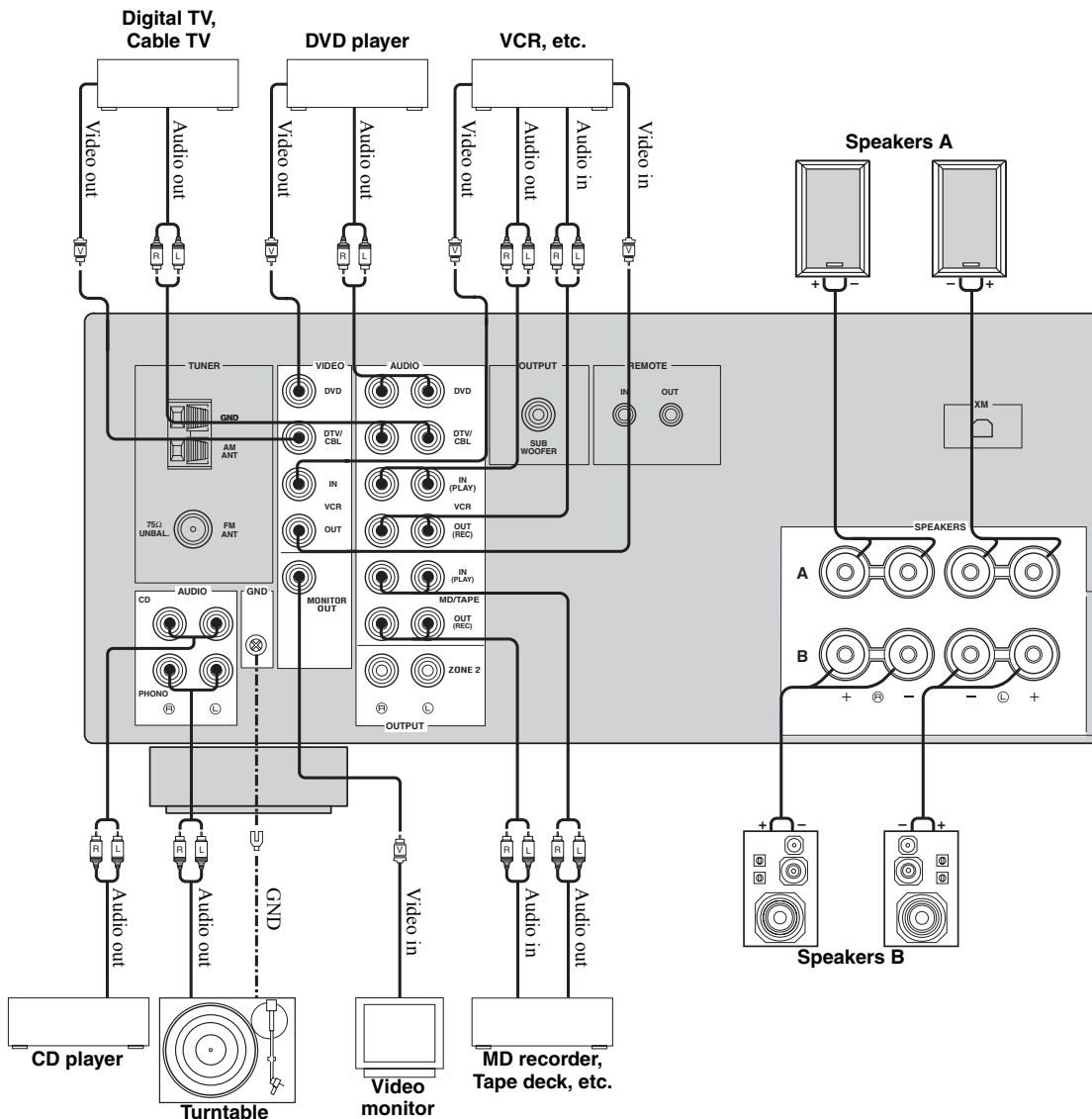

Connecting speakers

- 1 Remove approximately 10 mm (3/8 in) of insulation from the end of each speaker cable and twist the exposed wires of the cable together to prevent short circuits.

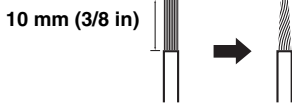

- 2 Unscrew the knob.

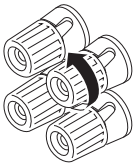

Red: positive (+)
Black: negative (-)

- 3 Insert one bare wire into the hole in the side of each terminal.

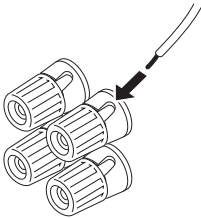

Red: positive (+)
Black: negative (-)

- 4 Tighten the knob to secure the wire.

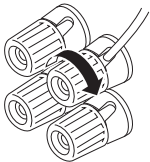

Red: positive (+)
Black: negative (-)

Connecting the banana plug (U.S.A., Canada, Australia and General models only)

First, tighten the knob and then insert the banana plug into the end of the corresponding terminal.

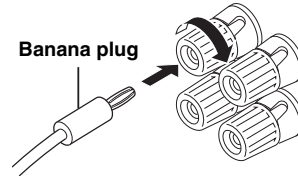

Notes

- One or two speaker sets can be connected to this unit. If you use only one speaker set, connect it to either the SPEAKERS A or B terminals.
- Use speakers with the specified impedance shown on the rear panel of this unit.

IMPEDANCE SELECTOR

CAUTION

Do not slide the IMPEDANCE SELECTOR switch while the power of this unit is turned on, as doing so may damage the unit.

Select the switch position (left or right) according to the impedance of the speakers in your system.

Switch position	Impedance level
Right	If you use one set (A or B), the impedance of each speaker must be 8 Ω or higher.
	If you use two sets (A and B), the impedance of each speaker must be 16 Ω or higher.
Left	If you use one set (A or B), the impedance of each speaker must be 4 Ω or higher.
	If you use two sets (A and B), the impedance of each speaker must be 8 Ω or higher.

Notes

- The Canada model cannot use two speaker sets (A and B) simultaneously when the IMPEDANCE SELECTOR switch is slid to the right position.
- If this unit fails to turn on, the IMPEDANCE SELECTOR switch may not be fully slid to either position. If this is the case, slide the switch all the way to either position when the power supply to this unit is completely cut off.

Connecting the AM and FM antennas

Both AM and FM indoor antennas are included with this unit. In general, these antennas should provide sufficient signal strength. Connect each antenna correctly to the designated terminals.

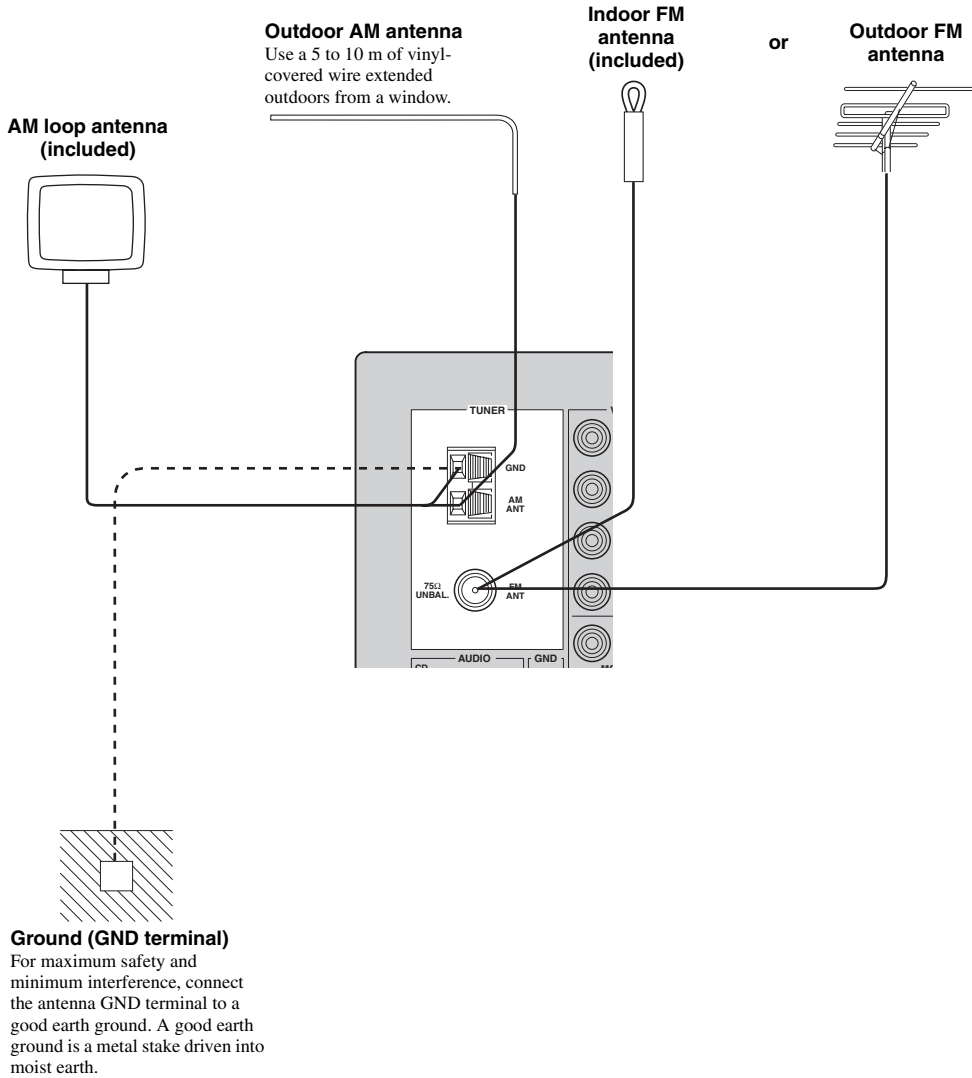

Notes

- A properly installed outdoor antenna provides clearer reception than an indoor one. If you experience poor reception quality, an outdoor antenna may improve the quality. Consult your nearest authorized YAMAHA dealer or service center about outdoor antennas.
- If you connect an outdoor FM antenna to this unit, do not connect the indoor FM antenna to this unit.
- To minimize interference from automobile ignition, locate the antenna as far from heavy traffic as possible.
- Keep the feeder cable or coaxial cable as short as possible. Do not bundle or roll up excess cable.
- The antenna should be placed at least 2 meters from reinforced concrete walls or metal structures.

■ Connecting the AM loop antenna

1 Set up the AM loop antenna.

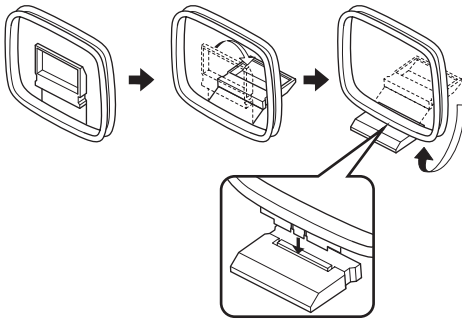

2 Press and hold the tab.

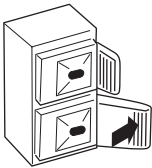

3 Insert the AM loop antenna lead wires into the AM ANT terminal.

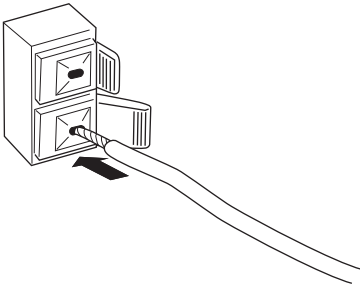

4 Release the tab.

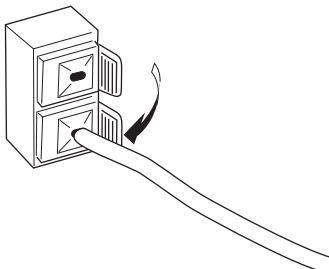

5 Repeat steps 2 to 4 to insert the AM loop antenna lead wires into the GND terminal.

6 Orient the AM loop antenna for the best reception.

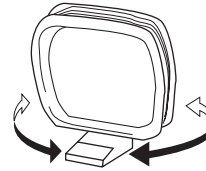

Notes

- The AM loop antenna should be placed away from this unit.
- A properly installed outdoor antenna provides clearer reception than an indoor one. If you experience poor reception quality, an outdoor antenna may improve the quality. It is recommended that you should connect a 5 to 10 m of vinyl-covered wire to the AM ANT terminal and extend it outdoors from a window. Consult your nearest authorized YAMAHA dealer or service center about outdoor antennas.
- The AM loop antenna should always be connected, even if an outdoor AM antenna is connected to this unit.

Connecting the power supply cord

Plug the power supply cord into the AC wall outlet after all other connections are complete.

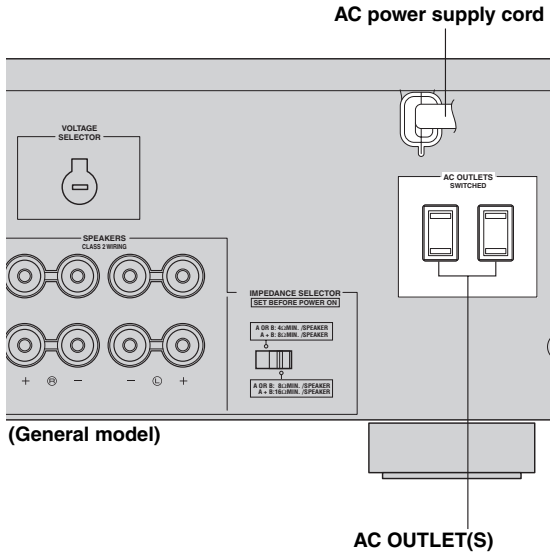

■ AC OUTLET(S) (SWITCHED)

Australia model 1 outlet
 Other models 2 outlets

Use these outlets to connect the power supply cords from your other components to this unit. The outlets supply power to any connected components whenever the power of this unit is turned on. For information on the maximum power (total power consumption of components), see "SPECIFICATIONS" on page 45.

Turning on and off this unit

When all connections are complete, turn on the power of this unit.

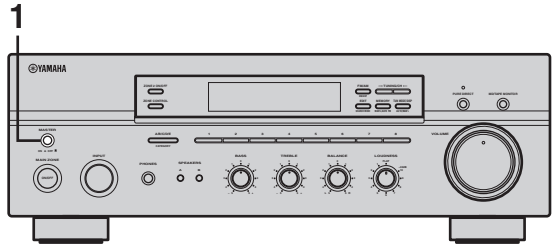

1 Press MASTER ON/OFF on the front panel inward to the ON position to turn on the power of this unit.

Main Zone of this unit turns on.



- You can set Main Zone of this unit to the standby mode by pressing MAIN ZONE ON/OFF on the front panel or STANDBY on the remote control.
 Press MAIN ZONE ON/OFF on the front panel or POWER on the remote control to turn Main Zone on again.
- Press MASTER ON/OFF on the front panel again to release it outward to the OFF position to turn off this unit.



While MASTER ON/OFF on the front panel is pressed inward to the ON position, you can turn on Zone 2 or set it to the standby mode independently (see page 38).

PLAYING AND RECORDING

CAUTION

Extreme caution should be exercised when you play back CDs encoded in DTS.

If you play back a CD encoded in DTS on a DTS-incompatible CD player, you will only hear some unwanted noise that may damage your speakers. Check whether your CD player supports CDs encoded in DTS. Also, check the sound output level of your CD player before you play back a CD encoded in DTS.

Playing a source

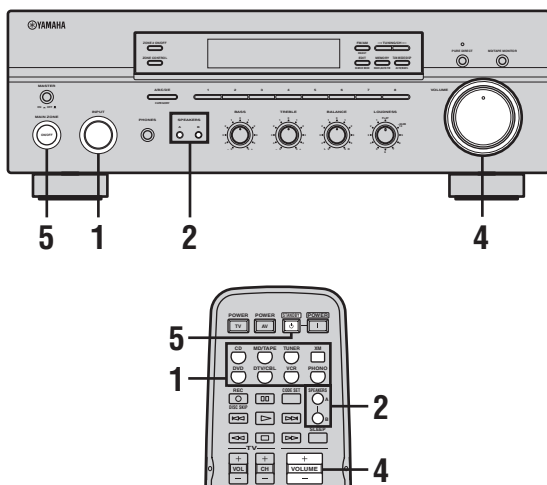

- 1 Rotate the **INPUT** selector on the front panel (or press one of the input selector buttons on the remote control) to select the desired input source.

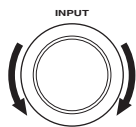

Front panel

or

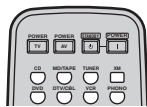

Remote control

- 2 Press **SPEAKERS A** and/or **SPEAKERS B** on the front panel or on the remote control to select speakers **A** and/or speakers **B**.

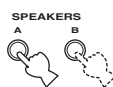

Front panel

or



Remote control

Notes

- Both **SPEAKERS A** and **B** can be selected.
- Make sure that the **IMPEDANCE SELECTOR** switch is correctly set (see page 11).

- 3 Play the source.

- 4 Rotate **VOLUME** on the front panel (or press **VOLUME +/-** on the remote control) to adjust the sound output level.

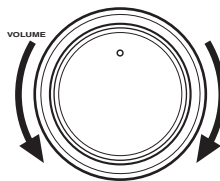

Front panel

or

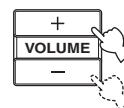

Remote control

- 5 Press **MAIN ZONE ON/OFF** on the front panel again (or press **STANDBY** on the remote control) to finish using this unit and set it to the standby mode.



Front panel

or



Remote control

Adjusting the tonal quality

■ Adjusting the BALANCE control

Adjusts the sound output balance of the left and right speakers to compensate for sound imbalance caused by speaker locations or listening room conditions.

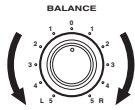

■ Using the PURE DIRECT button

Routes input signals from your audio sources so that the input signals bypass the BASS, TREBLE, BALANCE and LOUDNESS controls, thus eliminating any alterations to the audio signals and creating the purest possible sound.



■ Adjusting the BASS and TREBLE controls

Adjust the high and low frequency response.

BASS

Increases or decreases the low frequency response.

TREBLE

Increases or decreases the high frequency response.

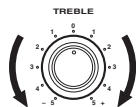
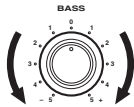

■ Adjusting the LOUDNESS control

Retains a full tonal range at any volume level, thus compensating for the human ears' loss of sensitivity to high and low-frequency ranges at a low volume level.

CAUTION

If the PURE DIRECT button is turned on with the LOUDNESS control set at a certain level, the input signals bypass the LOUDNESS control, resulting in a sudden increase in the sound output level. To prevent your ears or the speakers from being undesirably damaged, be sure to press the PURE DIRECT button AFTER lowering the sound output level or AFTER checking that the LOUDNESS control is properly set.

- 1 Rotate the LOUDNESS control on the front panel to the FLAT position.

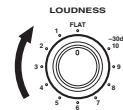

- 2 Rotate VOLUME on the front panel (or press VOLUME +/- on the remote control) to set the sound output level to the loudest listening level that you would listen to.

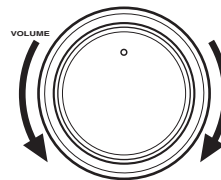

Front panel

or



Remote control

- 3 Rotate the LOUDNESS control until the desired volume is obtained.

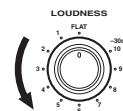

Recording a source

Notes

- The VOLUME, BASS, TREBLE, BALANCE and LOUDNESS controls and the PURE DIRECT buttons have no effect on the source being recorded.
- Check the copyright laws in your country to record from records, CDs, radio, etc. Recording copyright-protected material may infringe on copyright laws.

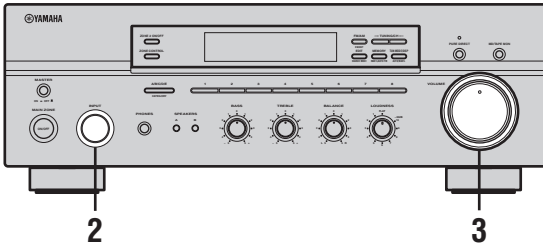

1 Play the selected source to record from.

2 Rotate the INPUT selector on the front panel (or press one of the input selector buttons on the remote control) to select the source you want to record from.

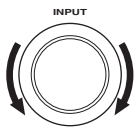

Front panel

or



Remote control

Note

You cannot select any input source while the MD/TAPE MON indicator in the front panel display lights on.

3 Rotate VOLUME on the front panel (or press VOLUME +/- on the remote control) to adjust the sound output level of the selected source to record from.

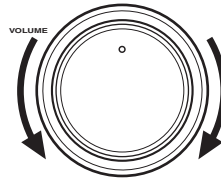

Front panel

or



Remote control

4 Begin recording on the MD recorder, the tape deck or the VCR connected to this unit.



If the 3-head tape deck is used for recording, you can monitor the sound of recording by pressing MD/TAPE MONITOR on the front panel.

Using the sleep timer

Use this feature to automatically set this unit to the standby mode after a certain amount of time. The sleep timer is useful when you are going to sleep while this unit is playing or recording a source. The sleep timer also automatically turns off any external components connected to the AC OUTLETS.

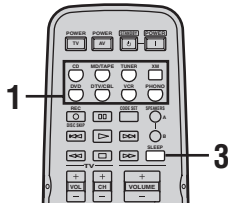

Notes

- The sleep timer can only be set with the remote control.
- The sleep timer automatically turns off Zone 2. However, the power of Zone 2 components are not turned off.

- 1 Press one of the input selector buttons on the remote control to select an input source.**



- 2 Start playback on the selected input source.**

- 3 Press SLEEP repeatedly to set the amount of time before this unit is set to the standby mode.**

Each time you press SLEEP, the front panel display changes as shown below.

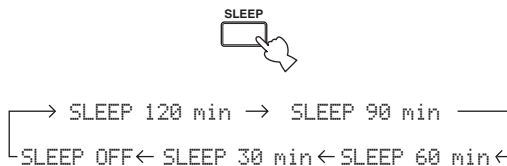

The SLEEP indicator flashes while switching the amount of time for the sleep timer.

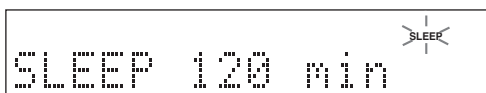

- 4 Press SLEEP repeatedly so that SLEEP OFF appears in the front panel display.**



After a few seconds, SLEEP OFF disappears from the front panel display, and the SLEEP indicator turns off.



The sleep timer setting can also be canceled by pressing STANDBY on the remote control (or MAIN ZONE ON/OFF or MASTER ON/OFF on the front panel) to set this unit to the standby mode.

Muting the sound output

1 Press MUTE on the remote control to mute the sound output.

The MUTE indicator flashes in the front panel display.

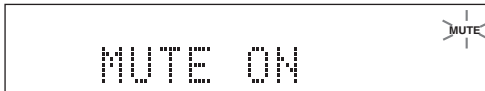

After a few seconds, MUTE ON disappears from the front panel display.

2 Press MUTE on the remote control again to resume the sound output.

The MUTE indicator disappears from the front panel display.



FM/AM TUNING

There are 2 tuning methods; automatic and manual. Select either method according to your preference and the strength of station signals.

Automatic tuning

Automatic tuning is effective when station signals are strong and there is no interference.

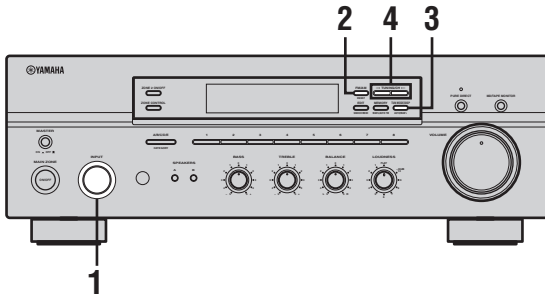

- 1 Rotate the INPUT selector (or press TUNER on the remote control) to select TUNER as the input source.

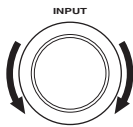

Front panel

or



Remote control

- 2 Press FM/AM on the front panel to select the reception band (FM or AM).

FM or AM appears in the front panel display.



- 3 Press TUN MODE on the front panel so that the AUTO indicator lights up in the front panel display.



AUTO
Lights up

- 4 Press TUNING/CH </> once to begin automatic tuning.

Press > to tune into a higher frequency.

Press < to tune into a lower frequency.

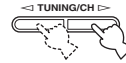

Notes

- When you tune into a station, the frequency of the received station is shown in the front panel display.
- To search for another station, press TUNING/CH </> once more.
- If the tuning search does not stop at the desired station because the station signals are weak, try using the manual tuning method.

Manual tuning

Manual tuning is effective when station signals are weak.

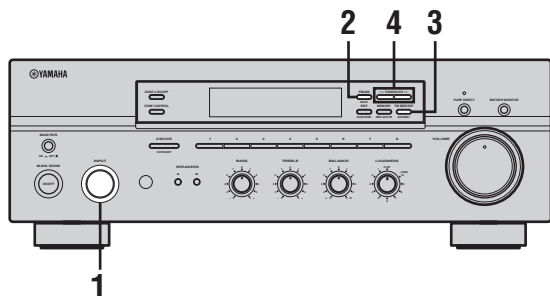

4 Press TUNING/CH </> / > to manually tune into the desired station.

Hold down the button to continue tuning search.



Notes

- When you tune into a station, the frequency of the received station is shown in the front panel display.
- If you tune into an FM station, it is automatically received in the monaural mode to increase signal quality.

1 Rotate the INPUT selector (or press TUNER on the remote control) to select TUNER as the input source.

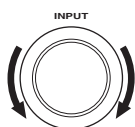

Front panel

or



Remote control

2 Press FM/AM on the front panel to select the reception band (FM or AM).

FM or AM appears in the front panel display.



3 Press TUN MODE on the front panel so that the AUTO indicator disappears from the front panel display.



AUTO
Disappears

Automatic preset tuning

You can use the automatic preset tuning method to automatically store FM stations. This function enables this unit to automatically tune into FM stations with strong signals and store up to 40 (8 stations in each of the 5 groups, A1 to E8) of those received stations in order. You can then easily recall any preset stations by selecting the preset station numbers where they are stored.

Notes

- Any station data stored under a preset station number is cleared when you store a new station under that preset station number.
- If the number of received stations does not reach 40 (E8), automatic preset tuning automatically stops once searching all available stations are tuned into and stored.
- Only FM stations with sufficient signal strength are stored automatically by automatic preset tuning. If the station you want to store is weak in signal strength, try using the manual preset tuning method.

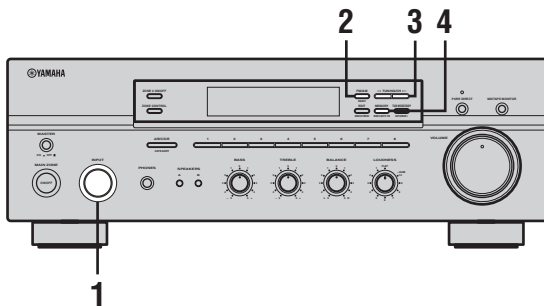

- 1 Rotate the INPUT selector (or press TUNER on the remote control) to select TUNER.

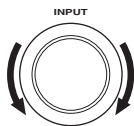

Front panel

or



Remote control

- 2 Press FM/AM on the front panel to select FM as the reception band.

FM appears in the front panel display.



- 3 Press and hold MEMORY on the front panel for more than 3 seconds.

The preset station group and the MEMORY and AUTO indicators flash in the front panel display.



- 4 Press TUNING/CH <|/> once to begin automatic preset tuning.

Press > to tune into higher frequencies.

Press < to tune into lower frequencies.

When automatic preset tuning is complete, the frequency of the last preset station is shown in the front panel display.



Notes

- If TUNING/CH <|/> is not pressed within approximately 5 seconds while the MEMORY and AUTO indicators are flashing, automatic preset tuning automatically begins from the currently displayed frequency and proceeds toward higher frequencies.
- Received stations are sequentially programmed to 8 stations in each preset station group. If 8 stations are all programmed in a preset station group, another 8 stations are sequentially programmed in the next preset station group.

■ Customized automatic preset tuning

You can specify a preset station group and a preset station number from which this unit stores the FM stations received by automatic preset tuning.

1 Press and hold MEMORY on the front panel for more than 3 seconds.



2 Press A/B/C/D/E and then press one of the preset station/channel number buttons on the front panel to select the preset station group and the preset station number where the first received station will be stored.

For example, if you select C5, the first received station is automatically programmed to C5 and the next received stations are sequentially programmed to C6, C7, etc.

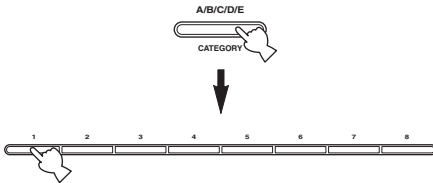

3 Press TUNING/CH <|/> on the front panel to begin automatic preset tuning.

Press > to tune into higher frequencies.

Press < to tune into lower frequencies.

When automatic preset tuning is complete, the frequency of the last preset station is shown in the front panel display.

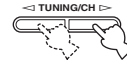

Note

Automatic preset tuning stops when the received stations have all been stored up to E8.

Manual preset tuning

You can also manually store up to 40 stations (8 stations in each of the 5 groups, A1 to E8). You can then easily recall any preset stations by selecting the preset station numbers where they are stored.

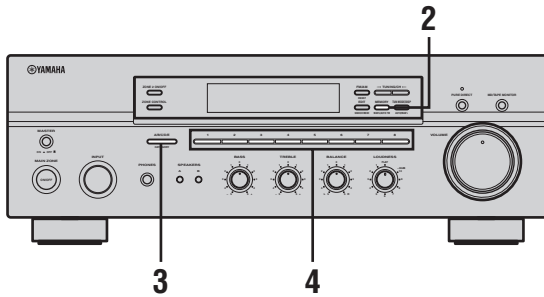

1 Repeat steps 1 to 4 in “Automatic tuning” or in “Manual tuning” to tune into a station.

When you tune into a station, the frequency of the received station is shown in the front panel display.

2 Press MEMORY on the front panel.

The MEMORY indicator flashes in the front panel display for approximately 5 seconds.



**MEMORY
Flashes**

3 Press A/B/C/D/E on the front panel repeatedly to select a preset station group (A to E).

The selected preset station group is shown in the front panel display.

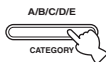

4 Press one of the preset station/channel number buttons on the front panel to select a preset station number (1 to 8) where you want to store the station.



Note

This operation must be done within 5 seconds while the MEMORY indicator is flashing in the front panel display. Otherwise, the manual preset tuning process is automatically canceled.

5 Press MEMORY on the front panel to store the station.

6 Repeat steps 1 to 5 to store other stations.

Notes

- Any station data stored under a preset station number is cleared when you store a new station under that preset station number.
- The reception mode (stereo or monaural) is stored along with the station frequency.

Selecting preset stations

You can tune into the desired station simply by selecting the preset station number where it is stored.

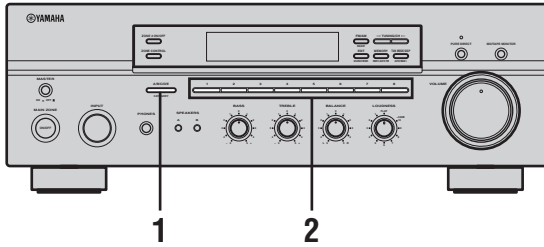

- 1 Press **A/B/C/D/E** on the front panel repeatedly (or press **A-E/CAT. </>** on the remote control) to select a preset station group (**A to E**).

The selected preset station group is shown in the front panel display.

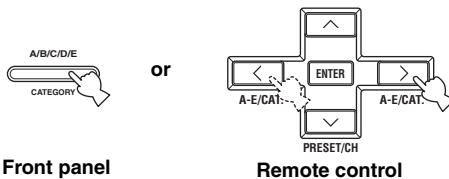

- 2 Press one of the preset station/channel number buttons on the front panel (or **PRESET/CH ^ / v** on the remote control) to select a preset station number (**1 to 8**).

The preset station number appears in the front panel display along with the reception band and the frequency.

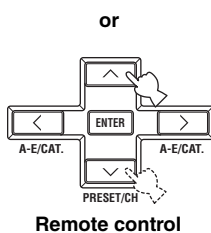
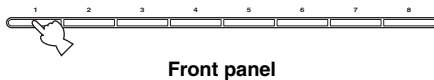

Exchanging preset stations

You can exchange the assignment of two preset stations with each other. The following procedure describes an example where a preset station E1 is exchanged with another preset station A5.

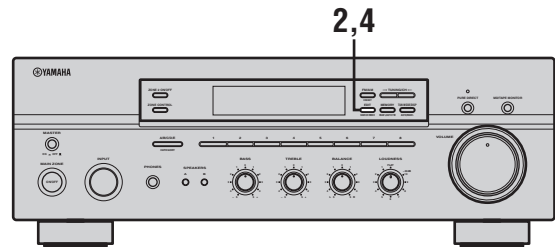

- 1 Repeat steps 1 and 2 in “Selecting preset stations” to select a preset station **E1**.

- 2 Press **EDIT** on the front panel. **E1** and the **MEMORY** indicator flash in the front panel display.



- 3 Repeat steps 1 and 2 in “Selecting preset stations” to select another preset station **A5**.

A5 and the **MEMORY** indicator flash in the front panel display.

MEMORY
Flashes

- 4 Press **EDIT** on the front panel again.

E1-A5 appears in the front panel display, indicating that the two preset station assignments have been exchanged.



XM SATELLITE RADIO TUNING

What is XM Satellite Radio?

XM Satellite Radio is the satellite radio service with millions of listeners across the United States broadcasting live daily. The XM Satellite Radio channel lineup includes more than 150 digital channels of choice from coast to coast: 67 commercial-free music channels, featuring hip hop to opera, classical to country, bluegrass to blues; 64 channels of premier sports, talk, comedy, children's and entertainment programming; and more than 26 channels of the traffic and weather information for major metropolitan areas nationwide.

Because XM Satellite Radio is a subscription service, you will need to set up an account and activate service with XM using your XM Satellite Radio ID number. To check your ID number, follow "Activating XM Satellite Radio" on page 29. For further information on XM Satellite Radio services, visit the XM Satellite Radio website at "<http://www.xmradio.com>".

Notes

- The XM Satellite Radio service is only available in the 48 contiguous United States (not available in Alaska and Hawaii).
- XM Connect-and-Play digital antenna accessory and monthly subscription are sold separately. For details, visit the XM Satellite Radio website at "<http://www.xmradio.com>".



Information from XM Satellite Radio, Inc.

Hardware and required basic monthly subscription sold separately. Premium Channel available at additional monthly cost. Installation costs and other fees and taxes, including a one-time activation fee may apply. Subscription fee is consumer only. All fees and programming subject to change. Subscriptions subject to Customer Agreement available at xmradio.com. Only available in the 48 contiguous United States.

© 2005 XM Satellite Radio Inc. All rights reserved. All other trademarks are the property of their respective owners.

XM Satellite Radio connections

Connect the XM Connect-and-Play digital antenna accessory (sold separately) to the XM jack on the rear of this unit. (For details, refer to the operating instructions provided with the XM Connect-and-Play digital antenna accessory.)

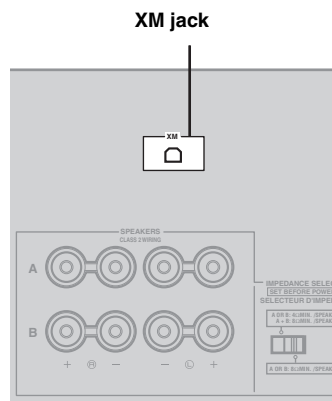

Notes

- For information on obtaining the XM Connect-and-Play digital antenna accessory, visit the XM Satellite Radio website at "<http://www.xmradio.com>" or consult your local retailer that sells XM Ready products.
- To ensure the optimal reception of the XM Satellite Radio signals, the XM Connect-and-Play digital antenna accessory must be placed at or near a southerly facing window with no obstacles in the path to the sky. You can mount it indoors or outdoors.

XM Satellite Radio functions

This section describes the functions of each control used for the XM Satellite Radio tuning.

Note

The following controls on the front panel and the remote control are only available when XM is selected as the input source and the XM Connect-and-Play digital antenna accessory is connected to the XM jack on the rear panel of this unit (see “XM Satellite Radio connections”).

■ Controls on the front panel

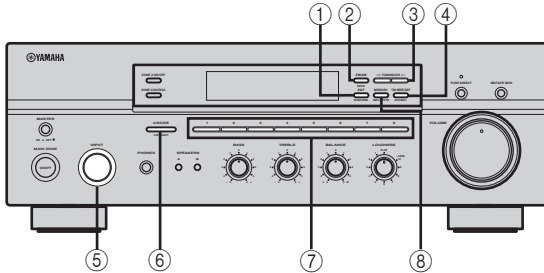

① SEARCH MODE

Switches between the All Channel Search, Category Search, and Preset Search modes (see page 31).

② XM ANT (ANTENNA)

Shows the reception level of the XM Connect-and-Play digital antenna (sold separately).

③ TUNING/CH </>

All Channel Search mode

Searches for a radio channel within all channels. Press and hold for quick search.

Category Search mode

Searches for a radio channel within the selected category. Press and hold for quick search.

Preset Search mode

Selects the preset channel number (1 to 8).

④ DISP (DISPLAY)

Switches the XM Satellite Radio information shown in the front panel display between channel number/name, category and artist name/song title (see page 30).

⑤ INPUT selector

Selects XM as the input source.

⑥ CATEGORY

All Channel Search mode

Switches between channel categories while staying in the All Channel Search mode.

Category Search mode

Switches between channel categories.

Preset Search mode

Selects the preset channel group (A to E).

⑦ Preset channel number buttons

Select the preset channel number (1 to 8) directly.

Pressing these buttons switches the search mode to the Preset Search mode.

⑧ MEMORY

Stores a radio channel in the system memory.

■ Controls on the remote controls

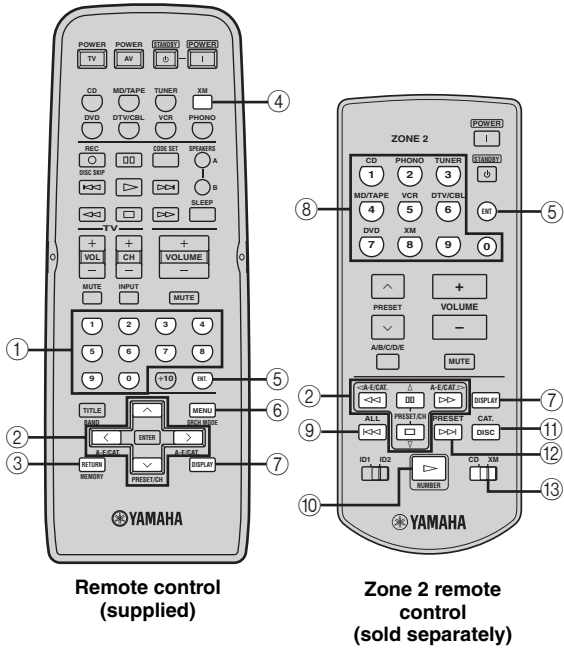

① **Numeric buttons**

All Channel Search or Category Search mode

Use 1 to 9 and 0 to enter a channel number directly.

Preset Search mode

Use 1 to 8 to enter a preset channel number directly.

② **A-E/CAT. (CATEGORY) </> (</>)**

All Channel Search mode

Switches between channel categories while staying in the All Channel Search mode.

Category Search mode

Switches between channel categories.

Preset Search mode

Selects the preset channel group (A to E).

PRESET/CH ^ / ∇ (Δ / ▽)

All Channel Search mode

Searches for a radio channel within all channels. Press and hold for quick search.

Category Search mode

Searches for a radio channel within the selected category. Press and hold for quick search.

Preset Search mode

Selects the preset channel number (1 to 8).

③ **MEMORY**

Stores a radio channel in the system memory.

④ **XM**

Selects XM as the input source.

⑤ **ENT. (ENT) (ENTER)**

Confirms an entered channel number when this unit is in the Direct Number Access mode (see page 33).

⑥ **SRCH (SEARCH) MODE**

Switches between the All Channel Search, Category Search, and Preset Search modes. (see page 31)

⑦ **DISPLAY**

Switches XM information such as channel number/name, category, or artist name/song title displayed in the front panel display and on-screen display. (see page 30).

■ **Zone 2 remote control (sold separately) only**

⑧ **Input selector/numeric buttons**

All Channel Search or Category Search mode

Use 1 to 9 and 0 to enter a channel number directly. Also refer to ⑩ NUMBER.

Preset Search mode

Use 1 to 8 to enter a preset channel number directly. Also refer to ⑩ NUMBER.

Note

You must press and hold ⑩ NUMBER before you press any of these buttons to enter numbers.

⑨ **ALL**

Selects the All Channel Search mode.

⑩ **NUMBER**

Press and hold before you press the input selector/numeric buttons to switch the function to enter numbers.

⑪ **CAT. (CATEGORY)**

Selects the Category Search mode.

⑫ **PRESET**

Selects the Preset Search mode.

⑬ **CD/XM switch**

Switches the function of the control buttons on the Zone 2 remote control numbered ②, ⑦, ⑨, ⑩, ⑪ and ⑫ between controlling YAMAHA CD players and controlling the XM Satellite Radio features.

Activating XM Satellite Radio

To sign up for an account with the XM Satellite Radio service, an XM Satellite Radio ID number is required. Follow the procedure below to check your ID number, and then visit the website at “<http://activate.xmradio.com>” or call “1-800-XM-RADIO (1-800-967-2346)” to sign up with your major credit card handy.

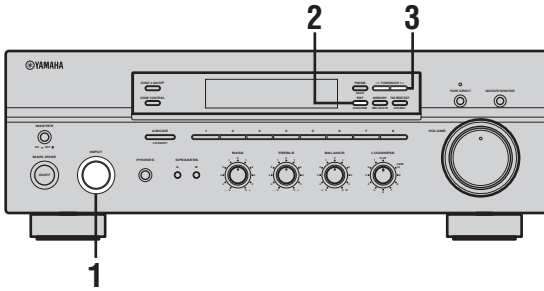

- 1 Rotate the INPUT selector on the front panel (or press XM on the remote control) to select XM as the input source.

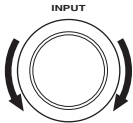

Front panel

or



Remote control

If CHECK ANTENNA appears in the front panel display, the XM Connect-and-Play digital antenna accessory may not be connected to the XM jack on the rear panel of this unit properly. See “XM Satellite Radio connections” on page 26 and check the connection.

- 2 Press SEARCH MODE on the front panel (or SRCH MODE on the remote control) repeatedly to select the All Channel Search mode.

ALL CH SEARCH appears in the front panel display.



Front panel

or



Remote control

- 3 Press TUNING/CH < / > on the front panel (or PRESET/CH ^ / v on the remote control) to select channel 0.



Front panel

or

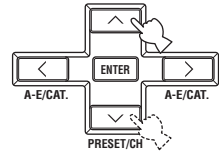

Remote control

- 4 Check the XM Satellite Radio ID number shown in the front panel display and write it down.

ID: _____

Basic XM Satellite Radio operations

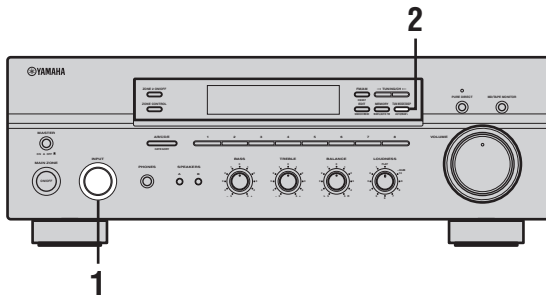

- 1 Rotate the INPUT selector on the front panel (or press XM on the remote control) to select XM as the input source.

The XM information (channel number/name, category or artist name/song title) for the currently selected channel appears in the front panel display.

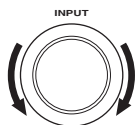

Front panel

or



Remote control



Selecting XM as the input source automatically recalls the previously selected channel.

- 2 Press DISP on the front panel (or DISPLAY on the remote control) repeatedly to toggle between the following channel information display modes.

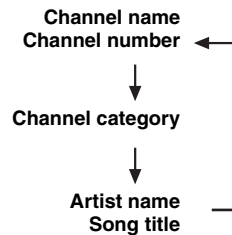
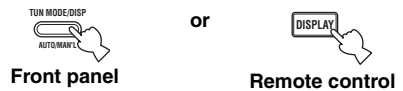

When the channel number and the channel name are displayed:



When the channel category is displayed:

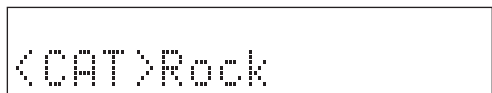

When the artist name and the song title are displayed:



- Up to 14 alphanumeric characters can be shown in the front panel display at once. If the information contains more than 14 characters, the information scrolls from the right to the left.
- If the information contains a character that cannot be recognized by this unit, the character will be shown with an underbar “_”.

Note

If a status message or an error message appears in the front panel display, see “XM Satellite Radio” on page 44.

XM Satellite Radio search modes

You can search for the desired channel by using one of the three search modes (All Channel Search mode, Category Search mode or Preset Search mode). You can also enter the number directly to select the desired channel (For details, see “Direct Number Access mode” on page 33).

■ All Channel Search mode

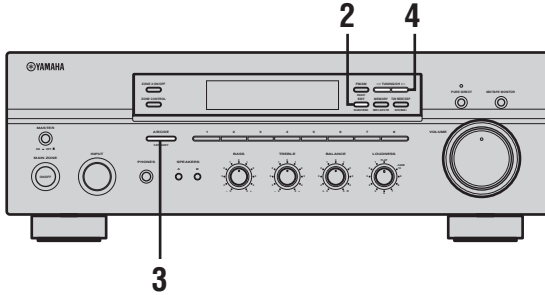

1 Repeat step 1 in “Basic XM Satellite Radio operations”.

2 Press **SEARCH MODE** on the front panel (or **SRCH MODE** on the remote control) repeatedly to select the All Channel Search mode.

ALL CH SEARCH appears in the front panel display.

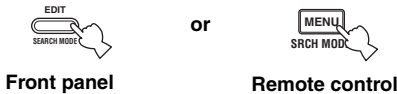

3 Press **CATEGORY** on the front panel (or **A-E/CAT.** </> on the remote control) repeatedly to switch between channel categories.

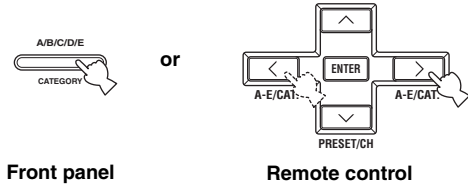

4 Press **TUNING/CH** </> on the front panel (or **PRESET/CH** ^ / v on the remote control) repeatedly to search for a channel within all channels.

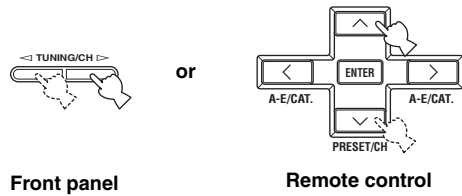

To quickly search for a channel, press and hold **TUNING/CH** </> on the front panel (or **PRESET/CH** ^ / v on the remote control).

■ Category Search mode

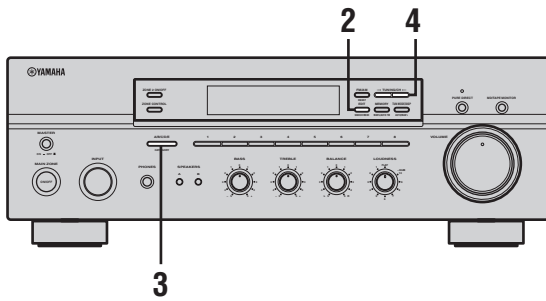

1 Repeat step 1 in “Basic XM Satellite Radio operations”.

2 Press **SEARCH MODE** on the front panel (or **SRCH MODE** on the remote control) repeatedly to select the **Category Search mode**.

CAT SEARCH appears in the front panel display.

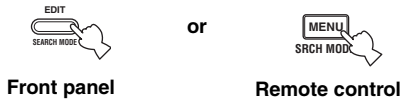

Front panel

Remote control

3 Press **CATEGORY** on the front panel (or **A-E/CAT.</>** on the remote control) repeatedly to switch between channel categories.

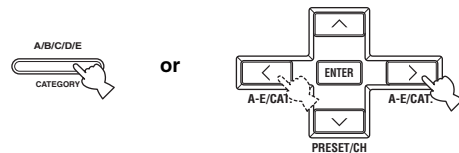

Front panel

Remote control

4 Press **TUNING/CH </>** on the front panel (or **PRESET/CH ^/∨** on the remote control) repeatedly to search for a channel within the selected channel category.

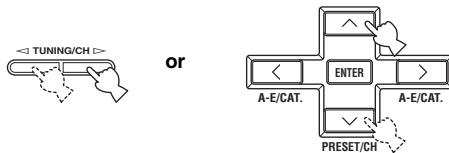

Front panel

Remote control



To quickly search for a channel, press and hold **TUNING/CH </>** (or **PRESET/CH ^/∨** on the remote control).

■ Preset Search mode

Prior to selecting a preset channel in the Preset Search mode, you must preset the XM Satellite Radio channels (see page 33). All preset channels (A1 to E8) recall “001 Preview” as the factory setting.

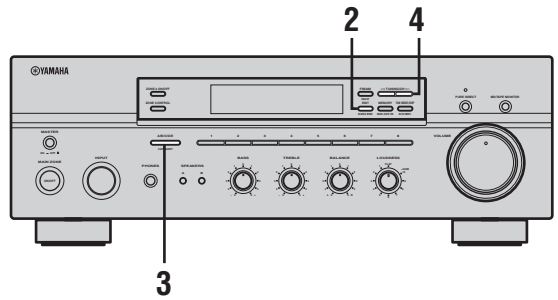

1 Repeat step 1 in “Basic XM Satellite Radio operations”.

2 Press **SEARCH MODE** on the front panel (or **SRCH MODE** on the remote control) repeatedly to select the **Preset Search mode**. **PRESET SEARCH** appears in the front panel display.

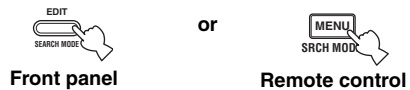

Front panel

Remote control

3 Press **CATEGORY** on the front panel (or **A-E/CAT.</>** on the remote control) repeatedly to select the preset channel group (A to E).

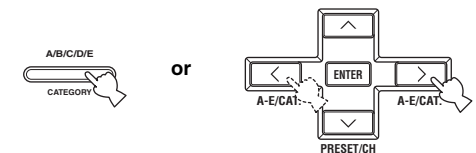

Front panel

Remote control

4 Press **TUNING/CH </>** on the front panel (or **PRESET/CH ^/∨** on the remote control) repeatedly to select the preset channel number (1 to 8).

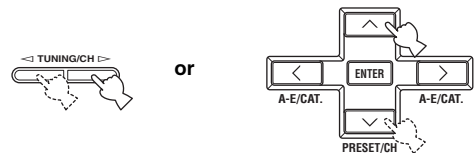

Front panel

Remote control



You can also select the preset channel number directly by pressing the preset channel number buttons (1 to 8) on the front panel or the numeric buttons (1 to 8) on the remote control.

■ Direct Number Access mode

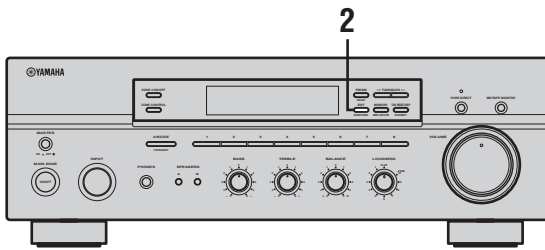

1 Repeat step 1 in “Basic XM Satellite Radio operations”.

2 Press **SEARCH MODE** on the front panel (or **SRCH MODE** on the remote control) repeatedly to select the **All Channel Search mode** or the **Category Search mode**.

ALL CH SEARCH or CAT SEARCH appears in the front panel display.



or



Front panel

Remote control

3 Press numeric buttons on the remote control sequentially to enter the desired channel number.



4 Press **ENT.** on the remote control to immediately tune into the channel with fewer than three digits for the channel number.



- ☀️
- If no button is pressed within a few seconds after entering one-digit or two-digit channel number, this unit automatically confirms the entered channel number and tunes into the selected channel.
- Pressing a button other than the numeric buttons or ENT. on the remote control cancels the Direct Number Access procedure.

Setting XM Satellite Radio preset channels

You can use this feature to store up to 40 XM Satellite Radio channels (8 preset channel numbers in each of the 5 preset channel groups, A1 to E8). You can then easily recall any preset channel by selecting the preset channel group and the preset channel number as described in “Preset Search mode” on page 32.

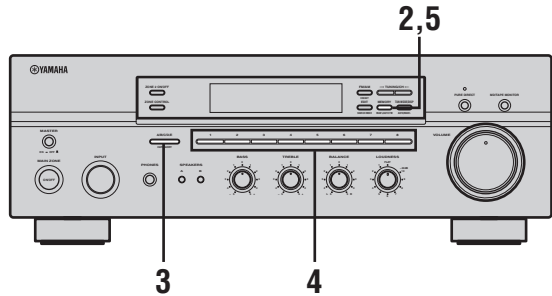

1 Search for the XM Satellite Radio channel you want to set as a preset channel.

To search for the desired channel, perform the steps in “All Channel Search mode”, “Category Search mode” or “Direct Number Access mode”.

2 Press **MEMORY** on the front panel or on the remote control.

The MEMORY indicator flashes in the front panel display for approximately 5 seconds.



or



Front panel

Remote control

↓
MEMORY Flashes

- 3 Press CATEGORY on the front panel (or A-E/CAT. </> on the remote control) to select the preset channel group (A to E).**

The preset channel group letter appears.

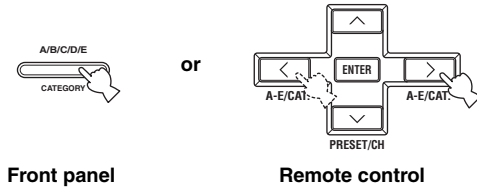

- 4 Press one of the preset station/channel number buttons on the front panel (or PRESET/CH ^ / v on the remote control) to select the preset channel number (1 to 8).**

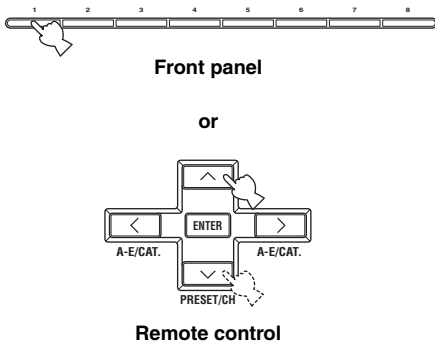

- 5 Press MEMORY on the front panel or on the remote control to preset the selected XM Satellite Radio channel.**

A colon appears next to the preset channel number for confirmation, and the MEMORY indicator turns off.

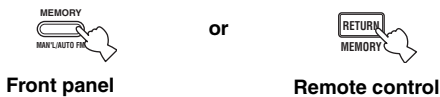

Notes

- Steps 3 to 5 must be done respectively within 5 seconds while the MEMORY indicator is flashing in the front panel display. Otherwise, the XM Satellite Radio channel presetting procedure is automatically canceled.
- Presetting a new channel clears the former preset channel stored in the same preset channel group and number.

ADVANCED SETUP

■ ADVANCED SETUP menu parameters

Change the initial settings (indicated in bold under each parameter) to reflect the needs of your listening environment.

Factory presets PRESET

Use to reset all parameters to the factory presets.

Choices: **CANCEL**, RESET

- Select **CANCEL** if you do not want the parameters of this unit to be initialized when you reset the factory presets.
- Select **RESET** if you want all of the parameters of this unit to be initialized when you reset the factory presets.

Notes

- This setting does not affect the parameters in the ADVANCED SETUP menu.
- The resetting process starts next time you turn on the power of this unit.

Remote REMOTE

Use to switch the remote control ID of this unit.

Choices: ID1, **ID2**

- Select ID1 to operate this unit using an alternative code.
- Select ID2 to operate this unit using the default code.

Note

You must also make settings for the remote control (see page 36).

Tuner TU

(Asia and General models only)

Use to switch the frequency step selection according to the frequency spacing in your area.

Choices: **AM10/FM100**, AM9/FM50

- North, Central and South America: AM10/FM100 (kHz)
- Other areas: AM9/FM50 (kHz)

Changing the ADVANCED SETUP menu parameters

The ADVANCED SETUP menu is displayed in the front panel display.



- During the ADVANCED SETUP procedure, audio output is muted.
- During the ADVANCED SETUP procedure, only MASTER ON/OFF, A/B/C/D/E and the preset station/channel number buttons (1 and 2) on the front panel are operational.

1,2,5

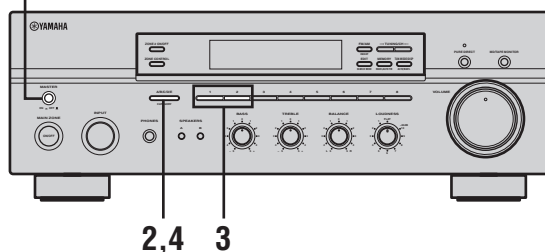

- 1 Press **MASTER ON/OFF** on the front panel to release it outward to the **OFF** position.



- 2 Press and hold **A/B/C/D/E** on the front panel and then press **MASTER ON/OFF** inward to the **ON** position.

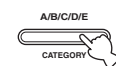

While holding down, press



- 3** Press the preset station/channel number buttons (1 and 2) on the front panel repeatedly to move through the menu and select the parameter you want to adjust.

See page 35 for a complete list of available parameters.

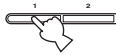

- 4** Press A/B/C/D/E on the front panel repeatedly to toggle between the available parameters.

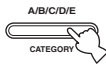

- 5** Press MASTER ON/OFF to release it outward to the OFF position to confirm your setting.



Note

The settings you made are reflected next time you turn on the power of this unit.

Switching the remote control ID

You can select the unit you want to operate with the remote control by switching the remote control ID.

- 1** Press and hold CODE SET on the remote control and then press TUNER on the remote control.



- 2** While holding down CODE SET on the remote control, use the numeric buttons on the remote control to enter the three-digit code number listed in the table below.

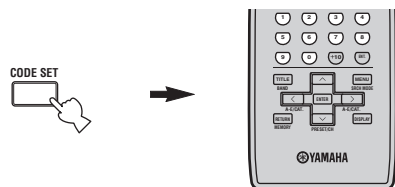

Remote control ID* (this unit's setting)	Function	Code number
ID1	To operate this unit using an alternative code.	801
ID2 (default setting)	To operate this unit using the default code.	802

* When you change the remote control ID, you must switch the remote control ID of this unit (see page 35).

When using multiple YAMAHA receivers or amplifiers with the same default code setting, you may unwantedly operate those components simultaneously. In this case, set one of the alternative codes for this unit to operate this unit separately.

Note

Also change the remote control ID of the Zone 2 remote control (sold separately) (see page 9).

ZONE 2

Connecting the Zone 2 components

This unit allows you to configure a multi-room audio and video system. The Zone 2 feature enables you to set this unit to reproduce separate input sources in the main room and in Zone 2 (the second room) simultaneously. You can also control this unit from the second room using the Zone 2 remote control (sold separately).

You need the following additional equipment to use the multi-room system of this unit:

- Zone 2 remote control
- An infrared signal receiver for the second room
- An infrared emitter for the main room. This emitter transmits the infrared signals sent by the Zone 2 remote control in Zone 2 to the components in the main room.
- An amplifier and speakers for the second room



Some YAMAHA models are able to connect directly to the REMOTE OUT jack on the rear panel of this unit. If you own these products, you may not need to use an infrared emitter. Up to six YAMAHA components can be connected as shown below.

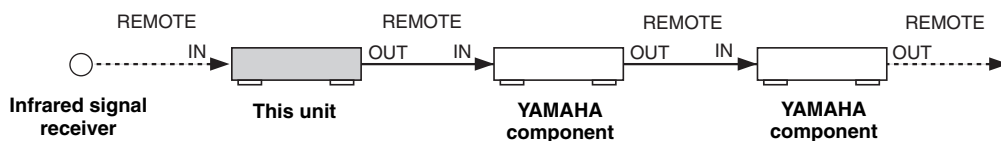

■ Multi-room configuration and connections

The following illustration shows an example of the multi-room system configuration and connections.

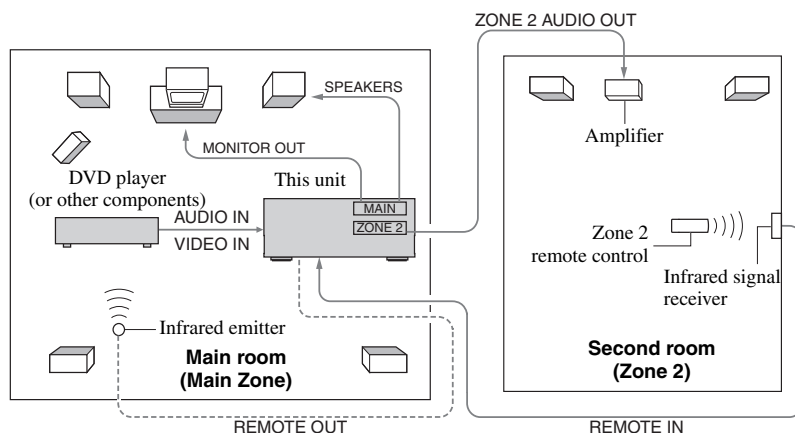

Since there are many possible ways to connect and use this unit in a multi-room configuration, we recommend that you consult with your nearest authorized YAMAHA dealer or service center for the Zone 2 connections that best meet your requirements.

Controlling Zone 2

You can control the input source of Zone 2 independently of the listening conditions in the main room.

- 1 Press ZONE 2 ON/OFF on the front panel to turn on Zone 2.**



- 2 Press ZONE 2 CONTROL on the front panel**
The ZONE 2 indicator flashes in the front panel display.



- 3 While the ZONE 2 indicator is flashing, rotate the INPUT selector on the front panel to select the input source of Zone 2.**

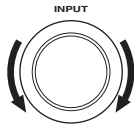

- You can also select the input source by using the Zone 2 remote control (sold separately). Press POWER on the Zone 2 remote control to turn on Zone 2, and then press one of the input selector buttons to select the input source.
- You can mute the sound output to Zone 2 by pressing MUTE on the ZONE 2 remote control. Press again to restore the sound output.

REMOTE CONTROL FEATURES

Control area

■ Controlling this unit

The shaded areas below can be used to control this unit.

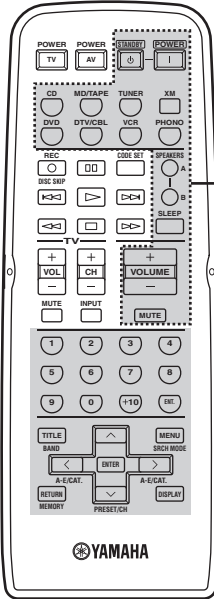

The buttons inside the dotted lines control this unit in any mode (POWER, STANDBY, SLEEP, the input selector buttons, VOLUME +/- and MUTE).

■ Controlling other components

The shaded areas below can be used to control other audio and video components made by YAMAHA and other manufacturers. Each button has a different function depending on the selected component. Select the component you want to control by pressing one of the input selector buttons. The name of the selected component appears in the front panel display.

The input selector buttons switch the function of the component control area below.

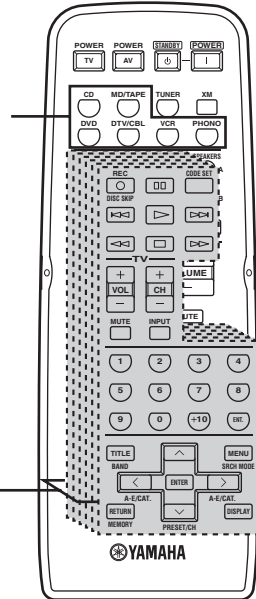

Component control area

You can control up to 6 different components by setting the appropriate remote control codes (see page 41).

Controlling other components

In addition to controlling this unit, you can also control other audio and video components made by YAMAHA and other manufacturers using the supplied remote control. To control other components, you must set the appropriate remote control codes.

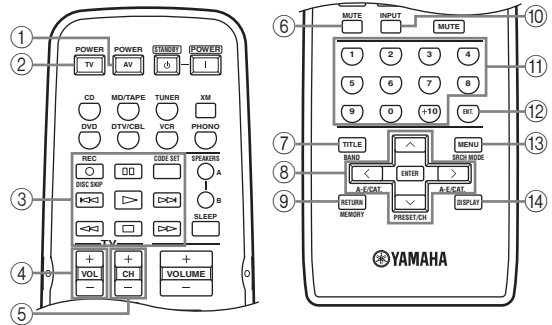

	DVD player	VCR	Digital TV/ Cable TV	TV	CD player	Tape deck	MD recorder	Tuner
① AV POWER	Power *1	Power *1	Power *1	VCR power	Power *1	Power *1	Power *1	Power *1
② TV POWER	TV power	TV power	TV power	Power *1	TV power	TV power	TV power	TV power
③ ◀◀	Search backward	Search backward	VCR search backward	VCR search backward	Search backward	Search backward	Search backward	PTY MODE *2
▶▶	Search forward	Search forward	VCR search forward	VCR search forward	Search forward	Search forward	Search forward	PTY START *2
◀◀	Skip backward				Skip backward	Direction A	Skip backward	FREQ/TEXT *2
▶▶	Skip forward				Skip forward	Direction B	Skip forward	EON *2
REC/ DISC SKIP	Disc skip	Rec	VCR rec	VCR rec	Disc skip	Rec	Rec	
□	Stop	Stop	VCR stop	VCR stop	Stop	Stop	Stop	
⏸	Pause	Pause	VCR pause	VCR pause	Pause	Deck A/B	Pause	
▷	Play	Play	VCR play	VCR play	Play	Play	Play	
④ TV VOL +	TV volume +	TV volume +	TV volume +	Volume +	TV volume +	TV volume +	TV volume +	TV volume +
TV VOL -	TV volume -	TV volume -	TV volume -	Volume -	TV volume -	TV volume -	TV volume -	TV volume -
⑤ TV CH +	TV channel +	Channel +	Channel +	Channel +	TV channel +	TV channel +	TV channel +	TV channel +
TV CH -	TV channel -	Channel -	Channel -	Channel -	TV channel -	TV channel -	TV channel -	TV channel -
⑥ TV MUTE	TV mute	TV mute	TV mute	Mute	TV mute	TV mute	TV mute	TV mute
⑦ TITLE	Title	Title	Title	Title				Band
⑧ ENTER	Menu enter		Menu select	Menu select				
PRESET/CH ^	Menu up		Menu up	Menu up				Preset up (1 to 8)
PRESET/CH v	Menu down		Menu down	Menu down				Preset down (1 to 8)
A-E/CAT. <	Menu left		Menu left	Menu left				Preset down (A to E)
A-E/CAT. >	Menu right		Menu right	Menu right				Preset up (A to E)
⑨ RETURN	Return	Return	Return	Return				
⑩ TV INPUT	TV input	TV input	TV input	Input	TV input	TV input	TV input	TV input
⑪ 1-9, 0, +10	Numeric buttons	Numeric buttons	Numeric buttons	Numeric buttons	Numeric buttons		Numeric buttons	Preset stations (1-8)
⑫ ENT.		Enter	Enter/recall	Enter/ numeric button			Index	
⑬ MENU	Menu		Menu	Menu				
⑭ DISPLAY	Display		Display	Display	Display		Display	

*1 This button functions only when the original remote control of the component has the POWER button.

*2 These buttons function for Europe model only.

Setting remote control codes

You can control other components by setting the appropriate remote control codes. Codes can be set up for each input source. For a complete list of available remote control codes, refer to “LIST OF REMOTE CONTROL CODES” at the end of this manual.

The following table show the default component category (Library) and the remote control code for each input source.

Remote control code default settings

Input source	Default component category (Library)	Manufacturer	Default YAMAHA code
CD	CD	YAMAHA	199
MD/TAPE	TAPE	YAMAHA	499
DVD	DVD	YAMAHA	699
DTV/CBL*	—	—	—
VCR	—	—	—
PHONO	—	—	—

* You can only set the TV remote control codes for the DTV/CBL button. However, other remote control codes can be set for any input selector buttons except DTV/CBL.

Note

You may not be able to operate your other YAMAHA components even if the YAMAHA remote control code is initially set as listed above. In this case, try setting other YAMAHA remote control codes.

- 1 Press and hold CODE SET on the remote control and then press one of the input selector buttons on the remote control to select the input source you want to set up.

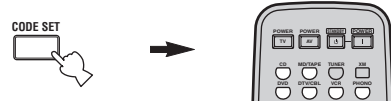

Note

You must press and hold CODE SET throughout this operation.

- 2 While holding down CODE SET on the remote control, use the numeric buttons on the remote control to enter the three-digit remote control code for the selected input source.

When the setting succeeds, “PRESET OK” appears; however, when it does not, “PRESET NG” appears in the front panel display.

To reset the code, enter the default code for each input source listed in the remote control code default settings table.

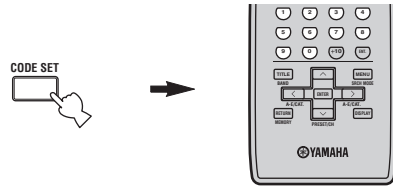

Notes

- If the manufacturer of your component has more than one code, try setting each of them until you find the correct one.
- You can only assign one remote control code to each input selector button.

TROUBLESHOOTING

Refer to the chart below if this unit does not function properly. If the problem you are experiencing is not listed below or if the instructions below do not help, set this unit to the standby mode, disconnect the power cord, and contact the nearest authorized YAMAHA dealer or service center.

■ General

Problem	Cause	Remedy	See page
This unit fails to turn on.	The power supply cord is not connected or the plug is not completely inserted.	Connect the power supply cord firmly.	—
	The impedance setting is incorrect.	Set the impedance to match your speakers.	11
	The protection circuitry has been activated because of a short circuit, etc.	Check that the speaker wires are not touching each other and then turn the power of this unit back on.	11
	The IMPEDANCE SELECTOR switch on the rear panel is not set to either end.	Set the IMPEDANCE SELECTOR switch to either end when the power of this unit is turned off.	11
	This unit has been exposed to a strong external electric shock (such as lightning or strong static electricity).	Set this unit to the standby mode, disconnect the power supply cord, plug it back in after 30 seconds, then use it normally.	—
No sound	Incorrect input or output cable connections.	Connect the cables properly. If the problem persists, the cables may be defective.	10
	No appropriate input source has been selected.	Select an appropriate input source with the INPUT selector on the front panel (or one of the input selector buttons on the remote control).	15
	The SPEAKERS A/B switches are not set properly.	Turn on the corresponding SPEAKERS A or SPEAKERS B.	15
	Speaker connections are not secure.	Secure the connections.	11
The sound suddenly goes off.	The protection circuitry has been activated because of a short circuit, etc.	Check that the IMPEDANCE SELECTOR setting is correct.	11
		Check that the speaker wires are not touching each other and then turn the power of this unit back on.	11
Only the speaker on one side can be heard.	Incorrect cable connections.	Connect the cables properly. If the problem persists, the cables may be defective.	10
	Incorrect setting for the BALANCE control.	Set the BALANCE control to the appropriate position.	16
There is a lack of bass and no ambience.	The + and – wires are connected in reverse at the amplifier or the speakers.	Connect the speaker wires to the correct + and – phase.	11
A “humming” sound can be heard.	Incorrect cable connections.	Connect the audio plugs firmly. If the problem persists, the cables may be defective.	10
	No connection from the turntable to the GND terminal.	Make the GND connection between the turntable and this unit.	10
The volume level is low while playing a record.	The record is being played on a turntable with an MC cartridge.	The turntable should be connected to this unit through the MC head amplifier.	—
The volume level cannot be increased, or the sound is distorted.	The component connected to the MD/TAPE OUT jacks of this unit is turned off.	Turn on the power of the component.	—

The sound is degraded when listening with the headphones connected to the CD player or the tape deck connected to this unit.	The power of this unit is turned off, or this unit is set to the standby mode.	Turn on the power of this unit.	14
The sound level is low.	The LOUDNESS control is functioning.	Set the LOUDNESS control to the FLAT position.	16
Using the BASS, TREBLE, BALANCE and LOUDNESS controls does not affect the tonal quality.	The PURE DIRECT button is turned on.	The PURE DIRECT button must be turned off to use those controls.	16

■ Tuner

Problem		Cause	Remedy	See page
FM	FM stereo reception is noisy.	The particular characteristics of the FM stereo broadcasts being received may cause this problem when the transmitter is too far away or the antenna input is poor.	Check the antenna connections. Try using a high-quality directional FM antenna.	12
			Try using the manual tuning method.	21
	There is distortion, and clear reception cannot be obtained even with a good FM antenna.	There is multipath interference.	Adjust the antenna position to eliminate the multipath interference.	—
	The desired station cannot be tuned in with the automatic tuning method.	The signal is too weak.	Try using a high-quality directional FM antenna.	12
			Try using the manual tuning method.	21
	Previously preset stations can no longer be tuned in.	This unit has been disconnected for a long period.	Preset the stations again.	22
AM	The desired station cannot be tuned in with the automatic tuning method.	The signal is weak or the antenna connections are loose.	Tighten the AM loop antenna connections and orient it for the best reception.	—
			Try using the manual tuning method.	21
	There are continuous crackling and hissing noises.	The noises may result from lightning, fluorescent lamps, motors, thermostats or other electrical equipment.	Try using an outdoor antenna and a ground wire. This will help somewhat, but it is difficult to eliminate all noise.	—
	There are buzzing and whining noises.	A TV set is being used nearby.	Move this unit away from the TV set.	—

■ **XM Satellite Radio**

Error message	Cause	Remedy
CHECK ANTENNA	The XM Connect-and-Play digital antenna accessory is not connected, or does not work properly.	Check the XM Connect-and-Play digital antenna accessory connections.
UPDATING	The XM user encryption code is being updated.	Wait until the encryption code is updated.
NO SIGNAL	The signal is too weak.	Check the XM Connect-and-Play digital antenna accessory connections and orient it for the best reception.
LOADING	It takes longer than four seconds for audio or text data to be decoded.	Wait until the decoding process has finished.
OFF AIR	The XM Satellite Radio channel you selected is not currently broadcasting any signal.	Check the channel number again or select another XM Satellite Radio channel.
<XM> - - -	The channel station ID (SID) is no longer available.	
- - - / - - -	No artist name/feature or song/program title is available.	
<CAT> - - -	No channels are available for the selected category.	Select another channel category by pressing CATEGORY on the front panel (or A-E/CAT. </> on the remote control) repeatedly.

■ **Remote control**

Problem	Cause	Remedy	See page
The remote control does not work nor function properly.	Wrong distance or angle.	The remote control will function within a maximum range of 6 m (19.7 ft) and no more than 30 degrees off-axis from the front panel.	9
	Direct sunlight or lighting (from an inverter type of fluorescent lamp, etc.) is striking the remote control sensor of this unit.	Reposition this unit.	—
	The batteries are weak.	Replace all batteries.	9
	The remote control ID and this unit's ID do not match.	Switch the remote control ID or this unit's ID.	35, 36
	The remote control code was not correctly set.	Try setting another code of the same manufacturer using "LIST OF REMOTE CONTROL CODES" at the end of this manual.	41
	Even if the remote control code is correctly set, there are some models that do not respond to the remote control.	Use the supplied remote control for the components.	—

SPECIFICATIONS

AUDIO SECTION

- Minimum RMS Output Power
(8 Ω, 20 Hz to 20 kHz, 0.04% THD) 75 W + 75 W
- Dynamic Power (IHF)
(8/6/4/2 Ω) 105/125/150/178 W
- Maximum Output Power [Europe model only]
(1 kHz, 0.7% THD, 4 Ω) 105 W
- IEC Output Power [Europe model only]
(1 kHz, 0.04% THD, 8 Ω) 84 W
- Power Band Width
(0.08% THD, 35 W, 8 Ω) 10 Hz to 50 kHz
- Damping Factor (SPEAKERS A)
20 Hz to 20 kHz, 8 Ω 150 or more
- Maximum Output Power (EIAJ)
[Asia and General models only]
(1 kHz, 10% THD, 8 Ω) 115 W
- Maximum Input Signal
PHONO (1 kHz, 0.04% THD) 70 mV or more
CD, etc. (1 kHz, 0.04% THD) 2.2 V or more
- Frequency Response
CD, etc. (20 Hz to 20 kHz) 0 ± 0.5 dB
CD, etc. PURE DIRECT ON (10 Hz to 100 kHz)..... 0 ± 1.0 dB
- RIAA Equalization Deviation
PHONO ± 0.5 dB
- Total Harmonic Distortion
PHONO to OUT (REC)
(20 Hz to 20 kHz, 3 V) 0.02% or less
CD, etc. to SPEAKERS
(20 Hz to 20 kHz, 35 W, 8 Ω) 0.02% or less
- Signal to Noise Ratio (IHF-A Network)
PHONO (5 mV input shorted) 82 dB or more
CD, etc. (185 mV input shorted) 108 dB or more
- Residual Noise (IHF-A Network)
PURE DIRECT ON 100 μV
- Gain Tracking Error (0 to -60 dB) 2 dB or less
- Input Sensitivity/Input Impedance
PHONO 2.5 mV/47 kΩ
CD, etc. 185 mV/47 kΩ
- Output Level/Output Impedance
OUT (REC)..... 185 mV/1.2 kΩ or less
SUB WOOFER OUTPUT 4 V/1.2 kΩ
ZONE 2 OUTPUT 185 mV/1.2 kΩ
- Headphone Output/Impedance
(Input 1 kHz, 185 mV, 8 Ω, 0.015% THD)
CD, etc. 0.47 V/390 Ω
- Channel Separation
CD, etc. (5.1 kΩ input shorted, 1/10 kHz) 65/50 dB or more
- Tone Control Characteristics
BASS
Boost/Cut (20 Hz) ±10 dB
Turnover Frequency 350 Hz
TREBLE
Boost/Cut (20 kHz) ±10 dB
Turnover Frequency 3.5 kHz
- Continuous Loudness Control
Attenuation (1 kHz) -30 dB

VIDEO SECTION

- Video Signal Type
[U.S.A., Canada and General models] NTSC
[Other models] PAL
- Signal to Noise Ratio 50 dB or more
- Frequency Response (MONITOR OUT)
Composite 5 Hz to 10 MHz, -3 dB

FM SECTION

- Tuning Range
[U.S.A. and Canada models] 87.5 to 107.9 MHz
[Asia and General models] 87.5/87.50 to 107.9/108.00 MHz
[Other models] 87.50 to 108.00 MHz
- Usable Sensitivity (IHF)..... 1.0 μV (11.2 dBf)
- Signal to Noise Ratio (IHF)
Mono/Stereo 76 dB/70 dB
- Harmonic Distortion (1 kHz)
Mono/Stereo 0.2%/0.3%
- Stereo Separation (1 kHz) 45 dB
- Frequency Response 20 Hz to 15 kHz, +0.5/-2 dB

AM SECTION

- Tuning Range
[U.S.A. and Canada models] 530 to 1710 kHz
[Asia and General models] 530/531 to 1710/1611 kHz
[Other models] 531 to 1611 kHz
- Usable Sensitivity 300 μV/m

GENERAL

- Power Supply
[U.S.A. and Canada models] AC 120 V, 60 Hz
[Asia model] AC 220/230-240 V, 50/60 Hz
[General model] AC 110/120/220/230-240 V, 50/60 Hz
[Australia model] AC 240 V, 50 Hz
[Europe model] AC 230 V, 50 Hz
- Power Consumption 180 W
- Standby Power Consumption 0.1 W
- Maximum Power Consumption [General model only]
(8 Ω, 1 kHz, 10% THD) 400 W
- AC Outlets
[Australia model] 1 (Total 100 W maximum)
[General model] 2 (Total 50 W maximum)
[Other models] 2 (Total 100 W maximum)
- Dimensions (W x H x D) 435 x 151 x 308 mm
(17-1/8" x 5-15/16" x 12-1/8")
- Weight 8.7 kg (19 lbs. 3 oz.)

* Specifications are subject to change without notice.

LIST OF REMOTE CONTROL CODES

TV		Pioneer	226, 235, 254, 255, 268	JC Penny	392, 393, 394, 328, 333, 349, 396, 363	Tashiro	396
Admiral	292, 293	Portland	297, 256			Tatung	392, 394
Aiwa	294, 276, 283, 284	Proscan	293	JVC	392, 394, 344, 345, 346, 347	Teac	392, 394, 397
Akai	295, 296	Proton	297			Technics	325, 328
Alba	296	Quasar	234, 235	Kendo	396	Teknika	396
AOC	297	Radio Shack	299, 293, 297	Kenwood	392, 394, 396	Telefunken	376, 377
Bell&Howell	292	RCA	293, 297, 234, 256, 257, 258	Loewe	396, 337	Thomas	397
Bestar	298	SABA	223, 269, 265, 266	Luxor	395	Thorn	393, 396
Blaupunkt	229, 222	Sampo	297	LXI	393, 396, 397, 336, 349	Toshiba	335, 389
Blue sky	298	Samsung	297, 239, 248, 262, 275	Magnavox	325, 326, 328	Totevison	363, 396
Brandt	223	Sanyo	295, 233, 279, 272, 273, 274, 212	Marantz	392, 394	Unitech	363
Brocsonic	297	Schneider	296	Marta	396	Universum	396, 327, 376
Bush	296	Scott	297	Matsui	396	Videosonic	363
Clatronic	298	Sharp	292, 239, 232, 213, 216	Memorex	328, 336, 396, 397	W.WHouse	396
Craig	224	Siemens	229	Minolta	333, 349	Wards	395, 396, 336
Croslex	225	Signature	292	Mitsubishi	399, 344, 348, 359, 353	Yamaha	399, 392, 393, 394
Curtis Mathis	297, 226	Sony	263, 214			Zenith	344, 368, 379, 396, 397
Daewoo	297, 298, 224, 227, 228	Sylvania	297, 225	MTC	363, 397		
Daytron	239	Telefunken	269, 264, 265, 266	Multitech	397, 348, 354	DVD player	
Dual	298	Thomson	223, 266	NEC	392, 394, 344, 383	DENON	623, 624
Dwin	293	Toshiba	292, 226, 267, 215	Nokia	393, 395	Funai	625
Emerson	297, 224, 239, 232	Videch	297, 242	Nokia Oceanic	395	HITACHI	626
Ferguson	223, 265, 266	Wards	297, 239, 232	Okano	323	JVC	627
First line	298	Yamaha	299, 292, 253, 242	Olympic	325, 328	KENWOOD	628
Funai	277, 278			Orion	327	Mitsubishi	629
Fisher	295, 233	VCR		Panasonic	325, 328, 355, 378, 384, 385, 386	Onkyo	632, 633, 634
Fraba	298	Admiral	395	Pentax	333, 349	Panasonic	623, 635
GE	293, 297, 234, 235, 236	Aiwa	396, 397, 398, 329	Philco	325, 328, 397	Philips	699, 647
LG/Goldstar	297, 298, 239, 237	Akai	322, 323, 324	Philips	325, 326, 328, 337, 356, 357	Pioneer	636, 637, 638
Goodmans	296, 298, 223	Audio Dynamic	392, 394	Phonola	337	RCA	639
Grundig	229, 238, 249	Bell&Howell	393	Pilot	396	Samsung	642
Hitachi	297, 239, 242, 243, 285	Blaupunkt	325, 326	Pioneer	325	Sharp	643
ICE	296	Brocsonic	327	Quasar	325, 328	Sony	644
Irradio	296	Bush	322	RCA/PROSCAN	325, 326, 328, 333, 335, 349, 358, 363, 397	Toshiba	634
Itt/Nokia	244, 245	Canon	325, 328			LG/GOLD STAR	645
JC Penny	293, 297, 234, 237	CGM	396, 332	Realistic	393, 397, 328, 336, 359, 396, 363	THOMSON	646
JVC	296, 246, 247, 286	Citizen	396	Samsung	354, 358, 363, 364, 366	Yamaha	699, 622, 623
Kendo	298	Craig	396, 363			CD player	
KTV	297, 239	Curtis Mathis	397, 328, 333	Sansui	394	Yamaha	199
Loewe	298, 248	Daewoo	328, 334, 335	Sanyo	393, 336, 367	CD recorder	
LXI	293, 297, 225, 226, 233	DBX	392, 394	Schneider	337	Yamaha	499
Magnavox	297, 225, 239	Dimensia	333	Scott	399, 335, 336, 348, 359, 354, 358	MD recorder	
Marantz	298	Dynatech	397	Selecto	322	Yamaha	599
Matsui	295	Emerson	327, 334, 396, 397	Sharp	395, 382	Tape deck	
Memorex	297	Fisher	393, 336	Siemens	393	Yamaha	799
Mitsubishi	299, 297, 259, 287	Funai	397	Signature 2000	395, 397		
NEC	297, 252, 282	GE	328, 333, 387	Sony	368, 379, 372, 373, 374, 375		
Nokia	244, 245	Go Video	353	Sylvania	397, 325, 326, 328		
Nokia Oceanic	245	LG/Goldstar	396, 388	Symphonic	397		
Nordmende	265, 266	Goodmans	334, 337	Tandberg	334		
Onwa	296	Grundig	332, 338	Tandy	397		
Panasonic	234, 235, 236, 253, 288, 211	Hitachi	325, 333, 349, 342, 343				
Philco	297, 225, 239	Instant Replay	325, 328				
Philips	225, 298	Itt/Nokia	393				



This product mainly uses lead-free solder.

© 2005 YAMAHA CORPORATION All rights reserved.

YAMAHA ELECTRONICS CORPORATION, USA 6660 ORANGETHORPE AVE., BUENA PARK, CALIF. 90620, U.S.A.
YAMAHA CANADA MUSIC LTD. 135 MILNER AVE., SCARBOROUGH, ONTARIO M1S 3R1, CANADA
YAMAHA ELECTRONIK EUROPA G.m.b.H. SIEMENSSTR. 22-34, 25462 RELLINGEN BEI HAMBURG, GERMANY
YAMAHA ELECTRONIQUE FRANCE S.A. RUE AMBROISE CROIZAT BP70 CROISSY-BEAUBOURG 77312 MARNE-LA-VALLEE CEDEX02, FRANCE
YAMAHA ELECTRONICS (UK) LTD. YAMAHA HOUSE, 200 RICKMANSWORTH ROAD WATFORD, HERTS WD18 7GQ, ENGLAND
YAMAHA SCANDINAVIA A.B. J A WETTERGRENS GATA 1, BOX 30053, 400 43 VÄSTRA FRÖLUNDA, SWEDEN
YAMAHA MUSIC AUSTRALIA PTY, LTD. 17-33 MARKET ST., SOUTH MELBOURNE, 3205 VIC., AUSTRALIA

YAMAHA CORPORATION
Printed in Malaysia ◀ WG05020

Read the following instructions instead of “IMPORTANT SAFETY INSTRUCTIONS” (1 to 14 on page i) on the OWNER’S MANUAL.

IMPORTANT SAFETY INSTRUCTIONS

- 1 Read Instructions – All the safety and operating instructions should be read before the product is operated.
- 2 Retain Instructions – The safety and operating instructions should be retained for future reference.
- 3 Heed Warnings – All warnings on the product and in the operating instructions should be adhered to.
- 4 Follow Instructions – All operating and use instructions should be followed.
- 5 Cleaning – Unplug this product from the wall outlet before cleaning. Do not use liquid cleaners or aerosol cleaners.
- 6 Attachments – Do not use attachments not recommended by the product manufacturer as they may cause hazards.
- 7 Water and Moisture – Do not use this product near water – for example, near a bath tub, wash bowl, kitchen sink, or laundry tub; in a wet basement; or near a swimming pool; and the like.
- 8 Accessories – Do not place this product on an unstable cart, stand, tripod, bracket, or table. The product may fall, causing serious injury to a child or adult, and serious damage to the product. Use only with a cart, stand, tripod, bracket, or table recommended by the manufacturer, or sold with the product. Any mounting of the product should follow the manufacturer’s instructions, and should use a mounting accessory recommended by the manufacturer.
- 9 A product and cart combination should be moved with care. Quick stops, excessive force, and uneven surfaces may cause the product and cart combination to overturn. 
- 10 Ventilation – Slots and openings in the cabinet are provided for ventilation and to ensure reliable operation of the product and to protect it from overheating, and these openings must not be blocked or covered. The openings should never be blocked by placing the product on a bed, sofa, rug, or other similar surface. This product should not be placed in a built-in installation such as a bookcase or rack unless proper ventilation is provided or the manufacturer’s instructions have been adhered to.
- 11 Power Sources – This product should be operated only from the type of power source indicated on the marking label. If you are not sure of the type of power supply to your home, consult your product dealer or local power company. For products intended to operate from battery power, or other sources, refer to the operating instructions.
- 12 Grounding or Polarization – This product may be equipped with a polarized alternating current line plug (a plug having one blade wider than the other). This plug will fit into the power outlet only one way. This is a safety feature. If you are unable to insert the plug fully into the outlet, try reversing the plug. If the plug should still fail to fit, contact your electrician to replace your obsolete outlet. Do not defeat the safety purpose of the polarized plug.
- 13 Power-Cord Protection – Power-supply cords should be routed so that they are not likely to be walked on or pinched by items placed upon or against them, paying particular attention to cords at plugs, convenience receptacles, and the point where they exit from the product.
- 14 Lightning – For added protection for this product during a lightning storm, or when it is left unattended and unused for long periods of time, unplug it from the wall outlet and disconnect the antenna or cable system. This will prevent damage to the product due to lightning and power-line surges.
- 15 Power Lines – An outside antenna system should not be located in the vicinity of overhead power lines or other electric light or power circuits, or where it can fall into such power lines or circuits. When installing an outside antenna system, extreme care should be taken to keep from touching such power lines or circuits as contact with them might be fatal.
- 16 Overloading – Do not overload wall outlets, extension cords, or integral convenience receptacles as this can result in a risk of fire or electric shock.
- 17 Object and Liquid Entry – Never push objects of any kind into this product through openings as they may touch dangerous voltage points or short-out parts that could result in a fire or electric shock. Never spill liquid of any kind on the product.
- 18 Servicing – Do not attempt to service this product yourself as opening or removing covers may expose you to dangerous voltage or other hazards. Refer all servicing to qualified service personnel.
- 19 Damage Requiring Service – Unplug this product from the wall outlet and refer servicing to qualified service personnel under the following conditions:
 - a) When the power-supply cord or plug is damaged,
 - b) If liquid has been spilled, or objects have fallen into the product,
 - c) If the product has been exposed to rain or water,
 - d) If the product does not operate normally by following the operating instructions. Adjust only those controls that are covered by the operating instructions as an improper adjustment of other controls may result in damage and will often require extensive work by a qualified technician to restore the product to its normal operation,
 - e) If the product has been dropped or damaged in any way, and
 - f) When the product exhibits a distinct change in performance - this indicates a need for service.

- 20 Replacement Parts** – When replacement parts are required, be sure the service technician has used replacement parts specified by the manufacturer or have the same characteristics as the original part. Unauthorized substitutions may result in fire, electric shock, or other hazards.
- 21 Safety Check** – Upon completion of any service or repairs to this product, ask the service technician to perform safety checks to determine that the product is in proper operating condition.
- 22 Wall or Ceiling Mounting** – The unit should be mounted to a wall or ceiling only as recommended by the manufacturer.
- 23 Heat** – The product should be situated away from heat sources such as radiators, heat registers, stoves, or other products (including amplifiers) that produce heat.
- 24 Outdoor Antenna Grounding** – If an outside antenna or cable system is connected to the product, be sure the antenna or cable system is grounded so as to provide some protection against voltage surges and built-up static charges. Article 810 of the National Electrical Code, ANSI/NFPA 70, provides information with regard to proper grounding of the mast and supporting structure, grounding of the lead-in wire to an antenna discharge unit, size of grounding conductors, location of antenna discharge unit, connection to grounding electrodes, and requirements for the grounding electrode.

EXAMPLE OF ANTENNA GROUNDING

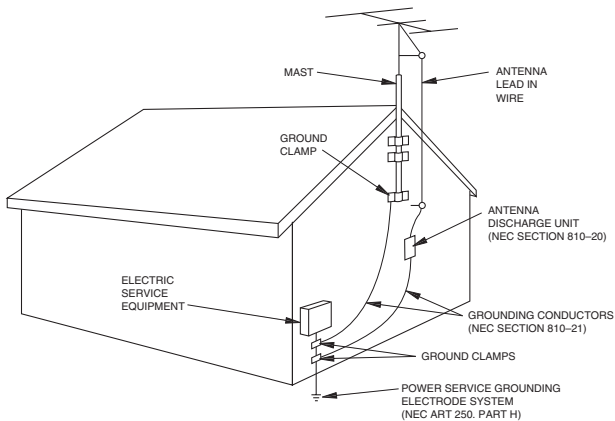

NEC – NATIONAL ELECTRICAL CODE