



AV Receiver

RX-A1020

Owner's Manual

Read the supplied booklet "Safety Brochure" before using the unit.

English

CONTENTS

Accessories	5
-------------------	---

FEATURES 6

What you can do with the unit	6
-------------------------------------	---

Part names and functions	8
--------------------------------	---

Front panel	8
Front display (indicators)	10
Rear panel	11
Remote control	12

PREPARATIONS 13

General setup procedure	13
-------------------------------	----

1 Connecting speakers	14
-----------------------------	----

Basic speaker configuration	15
Advanced speaker configuration	19

Input/output jacks and cables	24
-------------------------------------	----

2 Connecting a TV	25
-------------------------	----

3 Connecting playback devices	31
-------------------------------------	----

Connecting video devices (such as BD/DVD players)	31
Connecting audio devices (such as CD players)	33
Connecting to the jacks on the front panel	34

4 Connecting the FM/AM antennas	34
---------------------------------------	----

5 Connecting to a network	35
---------------------------------	----

6 Connecting other devices	36
----------------------------------	----

Connecting recording devices	36
Connecting a device with analog multi-channel output	36
Connecting a device that supports SCENE link playback (remote connection)	37
Connecting a device compatible with the trigger function	37

7 Connecting the power cable	38
------------------------------------	----

8 Selecting an on-screen menu language	39
--	----

9 Optimizing the speaker settings automatically (YPAO)	40
--	----

Measuring at one listening position (single measure)	42
Measuring at multiple listening positions (multi measure)	43
Checking the measurement results	44
Reloading the previous YPAO adjustments	45
Error messages	46
Warning messages	47

PLAYBACK 48

Basic playback procedure	48
--------------------------------	----

Selecting an HDMI output jack	48
-------------------------------------	----

Selecting the input source and favorite settings with one touch (SCENE)	49
---	----

Configuring scene assignments	50
Selecting setting items to be included as scene assignments	50

Selecting the sound mode	51
--------------------------------	----

Enjoying sound field effects (CINEMA DSP)	52
Enjoying unprocessed playback	54
Enjoying pure high fidelity sound (Pure Direct)	55
Enjoying compressed music with enhanced sound (Compressed Music Enhancer)	56
Enjoying surround sound with headphones (SILENT CINEMA)	56

Listening to FM/AM radio	57
--------------------------------	----

Setting the frequency steps	57
Selecting a frequency for reception	57
Registering favorite radio stations (presets)	58
HD Radio™ tuning	59
Radio Data System tuning	61
Operating the radio on the TV	62

Playing back iPod music	64
Connecting an iPod	64
Playback of iPod content	65
Playing back music stored on a USB storage device	68
Connecting a USB storage device	68
Playback of USB storage device contents	68
Playing back music stored on media servers (PCs/NAS)	71
Media sharing setup	71
Playback of PC music contents	71
Listening to Internet radio	74
Playing back iTunes/iPod music via a network (AirPlay)	76
Playback of iTunes/iPod music contents	76
Playing back music in multiple rooms (multi-zone)	78
Preparing Zone2	78
Controlling Zone2	81
Viewing the current status	83
Switching information on the front display	83
Viewing the status information on the TV	83
Configuring playback settings for different playback sources	
(Option menu)	84
Option menu items	84
CONFIGURATIONS	89
Configuring input sources (Input menu)	89
Input menu items	89
Configuring the SCENE function (Scene menu)	91
Scene menu items	92
Configuring sound programs/surround decoders	
(Sound Program menu)	94
Sound Program menu items	95

Configuring various functions (Setup menu)	97
Setup menu items	98
Speaker (Manual Setup)	100
Sound	103
Video	105
HDMI	106
Network	107
Multi Zone	109
Function	111
ECO	113
Language	113
Viewing information about the unit (Information menu)	114
Types of information	114
Configuring the system settings (ADVANCED SETUP menu)	115
ADVANCED SETUP menu items	116
Changing the speaker impedance setting (SPEAKER IMP.)	116
Turning on/off the remote control sensor (REMOTE SENSOR)	116
Selecting the remote control ID (REMOTE CON AMP)	116
Changing the FM/AM tuning frequency setting (TUNER FRQ STEP)	117
Switching the video signal type (TV FORMAT)	117
Removing the limitation on HDMI video output (MONITOR CHECK)	117
Backing up/recovering the settings (RECOV./BACKUP)	118
Restoring the default settings (INITIALIZE)	118
Updating the firmware (FIRM UPDATE)	118
Checking the firmware version (VERSION)	118
Controlling external devices with the remote control	119
Registering the remote control code for a TV	119
Registering the remote control codes for playback devices	120
Programming from other remote controls (learning)	121
Clearing functions learned from other remote controls	122
Resetting remote control codes	123
Updating the unit's firmware	124

Frequently asked questions	125
Troubleshooting	126
Power and system	126
Audio	127
Video	128
FM/AM radio	129
USB and network	130
Remote control	131
Error indications on the front display	132
Glossary	133
Audio information	133
HDMI and video information	134
Yamaha technologies	135
Video signal flow	136
Information on HDMI	137
HDMI Control	137
HDMI signal compatibility	138
Reference diagram (rear panel)	139
Trademarks	140
Specifications	141
Index	144

Accessories

Check that the following accessories are supplied with the product.

Remote control

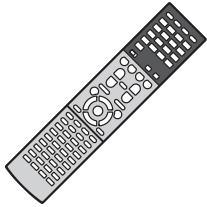

Batteries (AAA, R03, UM-4) (x2)

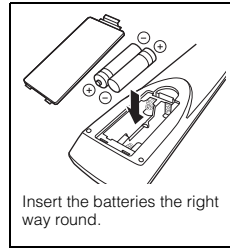
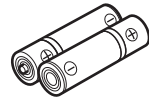

AM antenna

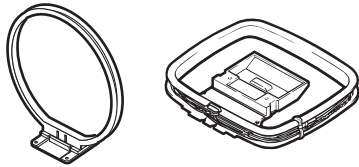

*One of the above is supplied depending on the region of purchase.

FM antenna

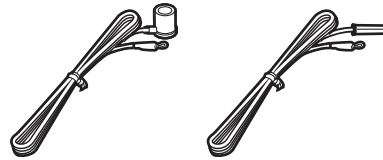

*One of the above is supplied depending on the region of purchase.

YPAO microphone

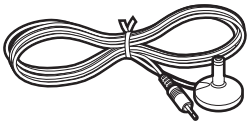

Power cable



*The supplied power cable varies depending on the region of purchase.

CD-ROM
(Owner's Manual)



Easy Setup Guide



Safety Brochure



Operating range of the remote control

- Point the remote control at the remote control sensor on the unit and remain within the operating range shown below.

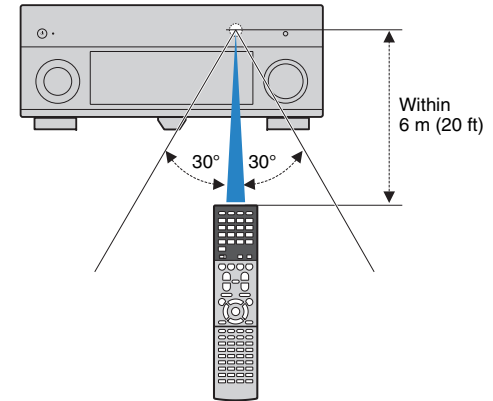

- The illustrations of the main unit used in this manual are of the U.S.A. model, unless otherwise specified.

- Some features are not available in certain regions.
- Due to product improvements, specifications and appearance are subject to change without notice.
- This manual explains operations using the supplied remote control.
- This manual describes all the "iPod", "iPhone" and "iPad" as the "iPod". "iPod" refers to "iPod", "iPhone" and "iPad", unless otherwise specified.

- indicates precautions for use of the unit and its feature limitations.
- indicates supplementary explanations for better use.

FEATURES

What you can do with the unit

Wide variety of supported content

- iPod/iPhone/iPad [➔ p.64](#)
- USB [➔ p.68](#)
- Media server (PC/NAS) [➔ p.71](#)
- Internet radio [➔ p.74](#)
- AirPlay [➔ p.76](#)

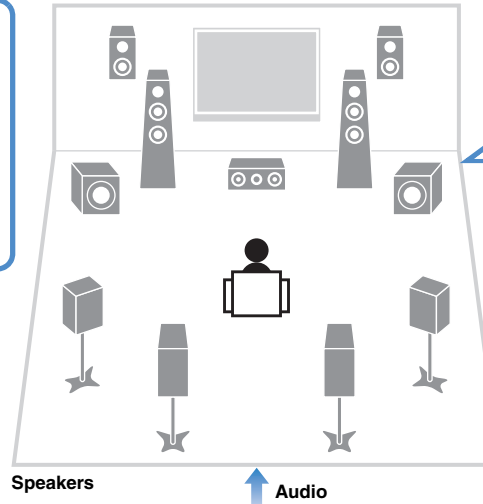
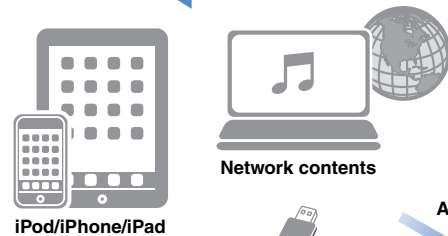

Supports 2- to 7-channel (plus front presence) speaker system and up to 2 subwoofer connections. Allows you to enjoy favorite acoustic spaces in various styles.

- Automatically optimizing the speaker settings to suit your room (YPAO) [➔ p.40](#)
- Reproducing stereo or multichannel sounds with the sound fields like actual movie theaters and concert halls (CINEMA DSP) [➔ p.52](#)
- Enjoying compressed music with enhanced sound (Compressed Music Enhancer) [➔ p.56](#)
- Bi-amp connections, channel expansion (with external power-amp) and multi-zone configurations to enhance your system [➔ p.19](#)

3D and 4K signals supported

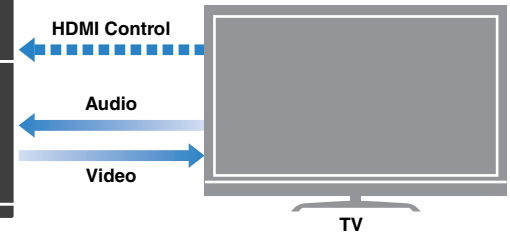
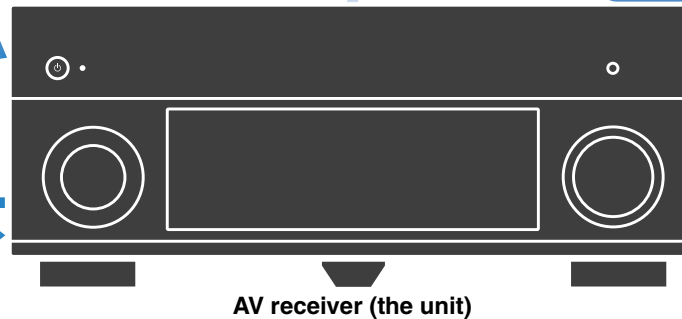
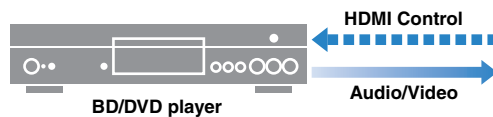

Operating external devices with the supplied remote control

[➔ p.119](#)

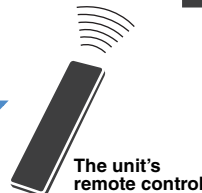

Change the input source and favorite settings with one touch (SCENE)

[➔ p.49](#)



Sequential operation of a TV, AV receiver, and BD/DVD player (HDMI Control)

[➔ p.137](#)

Full of useful functions!

❑ Connecting various devices (p.31)

A number of HDMI jacks and various input/output jacks on the unit allow you to connect video devices (such as BD/DVD players), audio devices (such as CD players), game consoles, camcorders, and other devices.

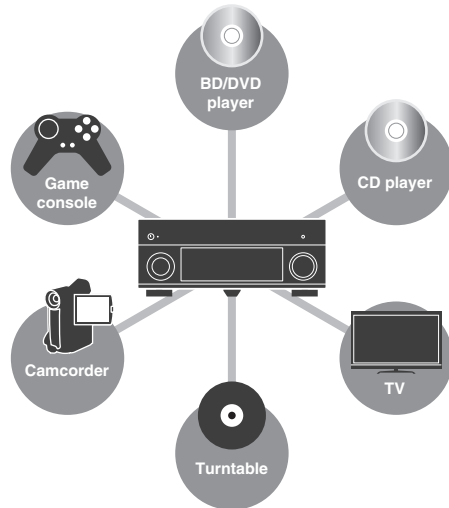

❑ Playing back TV audio in surround sound with a single HDMI cable connection (Audio Return Channel: ARC) (p.25)

When using an ARC-compatible TV, you only need one HDMI cable to enable video output to the TV, audio input from the TV, and the transmission of HDMI Control signals.

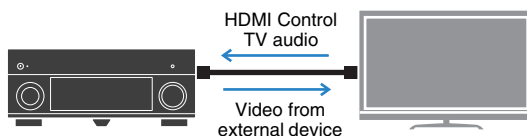

❑ Creating 3-dimensional sound fields (p.52)

Connecting front presence speakers allows you to create a natural 3-dimensional sound field in your own room (CINEMA DSP 3D). Even when no front presence speakers are connected, the Virtual Presence Speaker (VPS) function produces 3D surround sound.

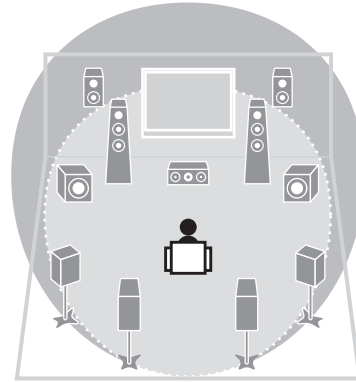

❑ Listening to FM/AM radio (p.57)

The unit is equipped with a built-in FM/AM tuner. You can register up to 40 favorite radio stations as presets.

❑ Enjoying pure high fidelity sound (p.55)

When the Pure Direct mode is enabled, the unit plays back the selected source with the least circuitry, which lets you to enjoy Hi-Fi sound quality.

❑ Easy operation with a TV screen

You can navigate through different types of content (such as iPod, USB, and network), view information, or easily configure the settings using the on-screen menu.

❑ Low power consumption

The ECO mode (power saving function) reduces the unit's power consumption (p.113).

Useful tips

I want to connect a playback device using HDMI for video and non-HDMI for audio...

Use "Audio Select" in the "Option" menu to specify the type of an audio input jack to be used for the corresponding input source (p.87).

Video and audio are not synchronized...

Use "Lipsync" in the "Setup" menu to adjust the delay between video and audio output (p.103).

I want to hear audio from the TV speakers...

Use "Audio Output" in the "Setup" menu to select the output destination of signals input into the unit (p.106). Your TV speakers may be selected as an output destination.

I want to change the on-screen menu language...

Use "Language" in the "Setup" menu to select a language from English, Japanese, French, German, Spanish, Russian and Chinese (p.39).

I want to update the firmware...

Use "FIRM UPDATE" in the "ADVANCED SETUP" menu to update the unit's firmware (p.118). If the unit is connected to the Internet, a message will be displayed on the TV when a firmware update is available (p.124).

Many other settings are available that let you to customize the unit. For details, see the following pages.

- Input settings (p.89)
- Scene settings (p.92)
- Sound program and surround decoder settings (p.95)
- Various function settings (p.98)
- Information view (such as audio signal and video signal) (p.114)
- System settings (p.116)

Part names and functions

Front panel

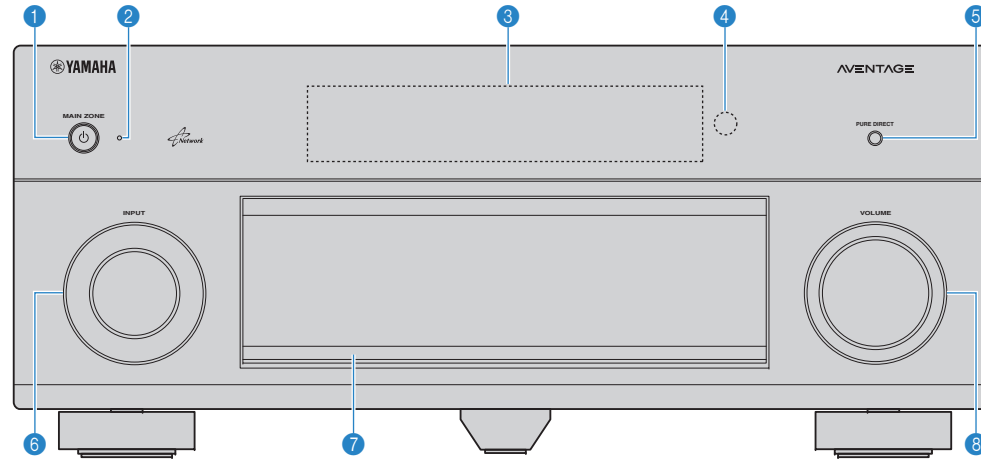

1 MAIN ZONE  key

Turns on/off (standby) the unit.

2 Standby indicator

Lights up when the unit is in standby mode under any of the following conditions.

- HDMI Control is enabled (p.106)
- Standby Through is enabled (p.107)
- Network Standby is enabled (p.108)
- An iPod is being charged (p.64)

3 Front display

Displays information (p.10).

4 Remote control sensor

Receives remote control signals (p.5).

5 PURE DIRECT key

Enables/disables Pure Direct (p.55).

6 INPUT knob

Selects an input source.

7 Front panel door

For protecting controls and jacks (p.9)

8 VOLUME knob

Adjusts the volume.

Opening the front panel door

- To use controls or jacks behind the front panel door, gently press the bottom of the door to open it. Keep the door closed when not using controls or jacks behind the front panel door. (Be careful not to trap your fingers.)

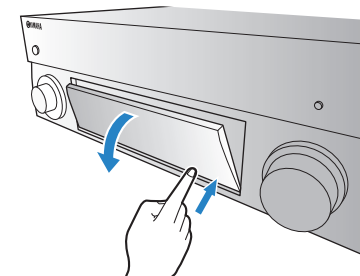

■ Inside of the front panel door

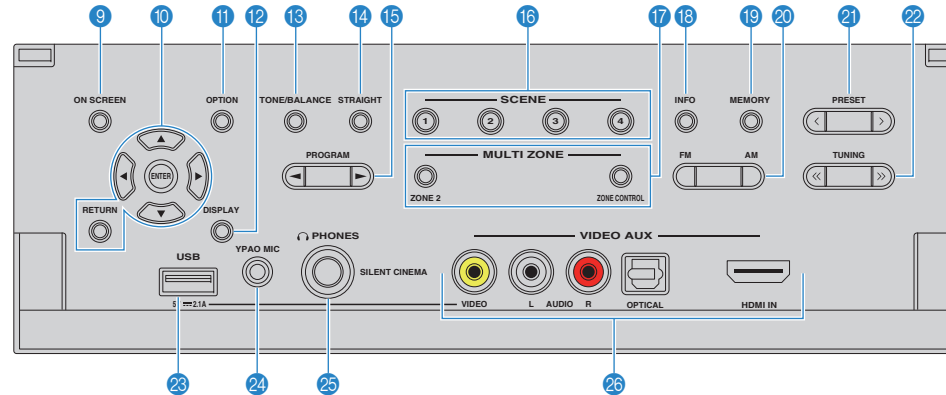

9 ON SCREEN key

Displays the on-screen menu on the TV.

10 Menu operations keys

Cursor keys Select a menu or a parameter.

ENTER Confirms a selected item.

RETURN Returns to the previous screen.

11 OPTION key

Displays the option menu (p.84).

12 DISPLAY key

Displays status information on the TV (p.83).

13 TONE/BALANCE key

Adjusts the high-frequency range and low-frequency range of output sounds (p.85).

Adjusts the right/left channel volume balance for Zone2 (p.82).

14 STRAIGHT key

Enables/disables the straight decode mode (p.54).

15 PROGRAM keys

Select a sound program or a surround decoder (p.51).

16 SCENE keys

Select the registered input source, sound program, and various settings with one touch. Also, turns on the unit when it is in standby mode (p.49).

17 MULTI ZONE keys

ZONE 2 Enables/disables the audio output to Zone2 (p.81).

ZONE CONTROL Changes the zone (main zone or Zone2) that is controlled by the keys and knobs on the front panel (p.81).

18 INFO key

Selects the information displayed on the front display (p.83).

19 MEMORY key

Registers FM/AM radio stations as preset stations (p.58).

20 FM and AM keys

Switch between FM and AM (p.57).

21 PRESET keys

Select a preset FM/AM radio station (p.58).

22 TUNING keys

Select the radio frequency (p.57).

23 USB jack

For connecting a USB storage device (p.68) or an iPod (p.64).

24 YPAO MIC jack

For connecting the supplied YPAO microphone (p.40).

25 PHONES jack

For connecting headphones.

26 VIDEO AUX jacks

For connecting devices, such as camcorders and game consoles (p.34).

Front display (indicators)

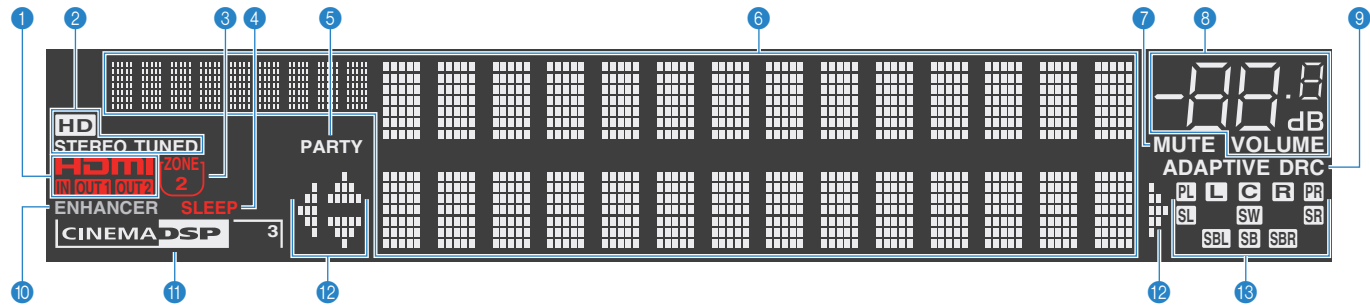

1 HDMI

Lights up when HDMI signals are being input or output.

IN

Lights up when HDMI signals are being input.

OUT1/OUT2

Indicates the HDMI OUT jacks currently outputting an HDMI signal.

2 STEREO

Lights up when the unit is receiving a stereo FM radio signal.

TUNED

Lights up when the unit is receiving an FM/AM radio station signal.

HD

(U.S.A. model only)

Lights up when the unit is receiving an HD Radio station signal.

3 ZONE2

Lights up when Zone2 is enabled (p.81).

4 SLEEP

Lights up when the sleep timer is on.

5 PARTY

Lights up when the unit is in the party mode. (p.82)

6 Information display

Displays the current status (such as input name and sound mode name). You can switch the information by pressing INFO (p.83).

7 MUTE

Blinks when audio is muted.

8 Volume indicator

Indicates the current volume.

9 ADAPTIVE DRC

Lights up when Adaptive DRC (p.85) is working.

10 ENHANCER

Lights up when Compressed Music Enhancer (p.56) is working.

11 CINEMA DSP

Lights up when CINEMA DSP (p.52) is working. "CINEMA DSP 3" lights up when CINEMA DSP 3D (p.54) is activated.

12 Cursor indicators

Indicate the remote control cursor keys currently operational.

13 Speaker indicators

Indicate speaker terminals from which signals are output.

L Front speaker (L)

R Front speaker (R)

C Center speaker

SL Surround speaker (L)

SR Surround speaker (R)

SBL Surround back speaker (L)

SBR Surround back speaker (R)

SB Surround back speaker

PL Front presence speaker (L)

PR Front presence speaker (R)

SW Subwoofer

Rear panel

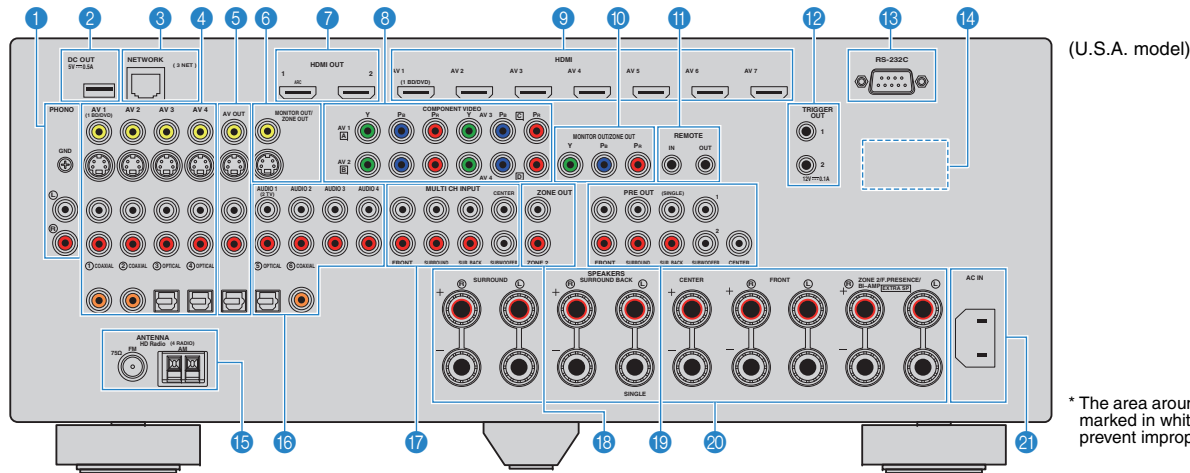

(U.S.A. model)

* The area around the video/audio output jacks is marked in white on the actual product to prevent improper connections.

1 PHONO jacks

For connecting to a turntable (p.33).

2 DC OUT jack

For connecting to an optional accessory.

3 NETWORK jack

For connecting to a network (p.35).

4 AV 1–4 jacks

For connecting to video/audio playback devices and inputting video/audio signals (p.31).

5 AV OUT jacks

For outputting video/audio to a recording device (such as a VCR) (p.36).

6 MONITOR OUT/ZONE OUT (composite video/S-video) jacks

For connecting to a TV that supports composite video or S-video and outputting video signals (p.29) or for connecting to a Zone2 video monitor (p.79).

7 HDMI OUT 1–2 jacks

For connecting to HDMI-compatible TVs and outputting video/audio signals (p.25). When using ARC, TV audio signal can also be input through the HDMI OUT 1 jack.

8 COMPONENT VIDEO (AV 1–4) jacks

For connecting to video playback devices that support component video and inputting video signals (p.31).

9 HDMI (AV 1–7) jacks

For connecting to HDMI-compatible playback devices and inputting video/audio signals (p.31).

10 MONITOR OUT/ZONE OUT (component video) jacks

For connecting to a TV that supports component video and outputting video signals (p.29) or for connecting to a Zone2 video monitor (p.79).

11 REMOTE IN/OUT jacks

For connecting to a Yamaha product that supports SCENE link playback (p.37) or for connecting to an infrared signal receiver/emitter that allows you to operate the unit and other devices from another room (p.80).

12 TRIGGER OUT 1–2 jacks

For connecting to devices that support the trigger function (p.37).

13 RS-232C terminal

This is a control expansion terminal for custom installation. Consult your dealer for details.

14 VOLTAGE SELECTOR

(General model only)

Selects the switch position according to your local voltage (p.38).

15 ANTENNA jacks

For connecting to FM and AM antennas (p.34).

16 AUDIO 1–4 jacks

For connecting to audio playback devices and inputting audio signals (p.33).

17 MULTI CH INPUT jacks

For connecting to a device that supports multi-channel output and inputting audio signals (p.36).

18 ZONE OUT jacks

For connecting to the external amplifier used in Zone2 and for outputting audio (p.79).

19 PRE OUT jacks

For connecting to a subwoofer with built-in amplifier (p.17) or to an external power amplifier (p.23).

20 SPEAKERS terminals

For connecting to speakers (p.14).

21 AC IN jack

For connecting the supplied power cable (p.38).

Remote control

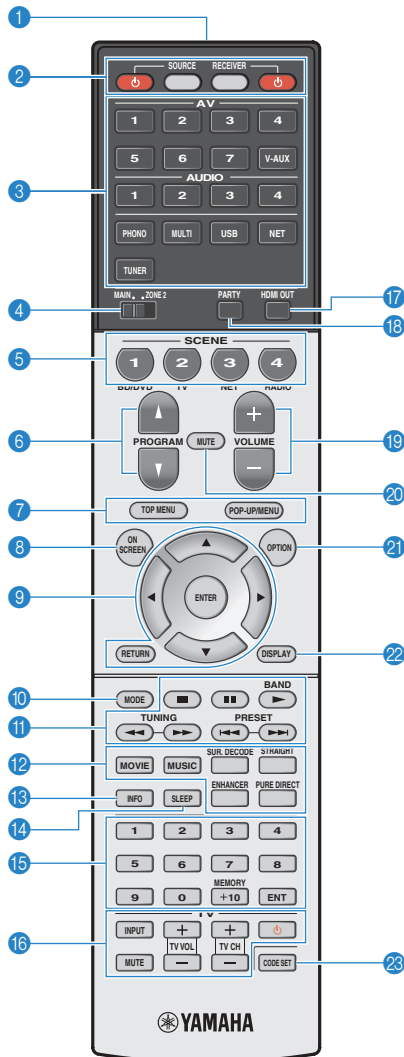

1 Remote control signal transmitter

Transmits infrared signals.

2 SOURCE key

Turns on/off an external device.

SOURCE key

Sets the remote control to operate external devices (p.120). This key lights up in green after pressed.

RECEIVER key

Sets the remote control to operate the unit (p.120). This key lights up in orange after pressed.

RECEIVER key

Turns on/off (standby) the unit.

3 Input selection keys

Select an input source for playback.

- AV 1-7** AV 1-7 jacks
- V-AUX** VIDEO AUX jacks (on the front panel)
- AUDIO 1-4** AUDIO 1-4 jacks
- PHONO** PHONO jacks
- MULTI** MULTI CH INPUT jacks
- USB** USB jack (on the front panel)
- NET** NETWORK jack (press repeatedly to select a desired network source)

TUNER

FM/AM radio

4 MAIN/ZONE2 switch

Changes the zone (main zone or Zone2) that is controlled by the remote control (p.81).

5 SCENE keys

Select the registered input source, sound program, and various settings with one touch. Also, turns on the unit when it is in standby mode (p.49).

6 PROGRAM keys

Select a sound program (p.51).

7 External device operation keys

Select menus for external devices (p.120).

8 ON SCREEN key

Displays the on-screen menu on the TV.

9 Menu operation keys

- Cursor keys** Select a menu or a parameter.
- ENTER** Confirms a selected item.
- RETURN** Returns to the previous screen.

10 MODE key

Switches the iPod operation modes (p.66).
(U.S.A. model only) Selects an HD Radio audio program (p.59).

11 Radio keys

Operate the FM/AM radio when "TUNER" is selected as the input source (p.57).

BAND Switches between FM and AM radio.

PRESET Select a preset station.

TUNING Select the radio frequency.

External device operation keys

Let you play back and perform other operations for external devices when an input source other than "TUNER" is selected (p.120).

12 Sound mode keys

Select a sound mode (p.51).

13 INFO key

Selects the information displayed on the front display (p.83).

14 SLEEP key

Switches the unit to standby mode automatically after a specified period of time has elapsed (sleep timer). Press repeatedly to set the time (120 min, 90 min, 60 min, 30 min, off).

15 Numeric keys

Let you enter numerical values, such as radio frequencies.

MEMORY key

Registers FM/AM radio stations as presets (p.58).

16 TV operation keys

Let you select TV input and volume, and perform other TV operations (p.119).

17 HDMI OUT key

Selects HDMI OUT jacks to be used for video/audio output (p.48).

18 PARTY key

Turns on/off the party mode (p.82).

19 VOLUME keys

Adjust the volume.

20 MUTE key

Mutes the audio output.

21 OPTION key

Displays the option menu (p.84).

22 DISPLAY key

Displays status information on the TV (p.83).

23 CODE SET key

Registers remote control codes of external devices on the remote control (p.119).



- To operate external devices with the remote control, register a remote control code for each device before using (p.119).

PREPARATIONS

General setup procedure

- 1 Connecting speakers (p.14)**
 - Basic speaker configuration (p.15)**

Select the speaker layout and connect the speakers to the unit.
 - Advanced speaker configuration (p.19)**

Apply bi-amp connections, channel expansion (using an external power amplifier) or multi-zone configurations to enhance the system.
- 2 Connecting a TV (p.25)**

Connect a TV to the unit.
- 3 Connecting playback devices (p.31)**

Connect video devices (such as BD/DVD players) and audio devices (such as CD players) to the unit.
- 4 Connecting the FM/AM antennas (p.34)**

Connect the supplied FM/AM antennas to the unit.
- 5 Connecting to a network (p.35)**

Connect the unit to a network.
- 6 Connecting other devices (p.36)**

Connect external devices such as recording devices.
- 7 Connecting the power cable (p.38)**

After all the connections are complete, plug in the power cable.
- 8 Selecting an on-screen menu language (p.39)**

Select the desired on-screen menu language (default: English).
- 9 Optimizing the speaker settings automatically (YPAO) (p.40)**

Optimize the speaker settings, such as volume balance and acoustic parameters, to suit your room (YPAO).

This completes all the preparations. Enjoy playing movies, music, radio and other content with the unit!

1 Connecting speakers

The unit has 7 built-in amplifiers. You can connect 2 to 9 speakers and up to 2 subwoofers to create the favorite acoustic space in your room. You can also apply bi-amp connections, channel expansion (using an external power amplifier) or multi-zone configurations to enhance your system (p.19).

Caution

- Under its default settings, the unit is configured for 8-ohm speakers. When connecting 6-ohm speakers, set the unit's speaker impedance to "6 Ω MIN". In this case, you can also use 4-ohm speakers as the front speakers. For details, see "Setting the speaker impedance" (p.16).

Functions of each speaker

Speaker type	Abbr.	Function
Front (L)	FL	Produce front right/left channel sounds (stereo sounds).
Front (R)	FR	
Center	C	Produces center channel sounds (such as movie dialogues and vocals).
Surround (L)	SL	Produce surround right/left channel sounds. Surround speakers also produce surround back channel sounds when no surround back speakers are connected.
Surround (R)	SR	
Surround back (L)	SBL	Produce surround back right/left channel sounds.
Surround back (R)	SBR	
Front presence (L)	FPL	Produce CINEMA DSP effect sounds. In combination with CINEMA DSP 3D (p.54), the front presence speakers create a natural 3-dimensional sound field in your room.
Front presence (R)	FPR	
Subwoofer	SW	Produces LFE (low-frequency effect) channel sounds and reinforces bass parts of other channels. This channel is counted as "0.1". You can connect 2 subwoofers to the unit and place them on the right/left (or front/rear) sides of the room.



- We recommend using front presence speakers to have a full effect of the 3-dimensional sound fields. However, the unit creates Virtual Presence Speaker (VPS) using the front, center and surround speakers to produce 3-dimensional sound fields even when no front presence speakers are connected (p.54).
- Use "Ideal speaker layout" (diagram on the right) as reference. You do not need to exactly adjust the speaker layout to this diagram since the YPAO function of the unit will automatically optimize the speaker settings (such as distances) to suit the speaker layout.
- When using only one surround back speaker, place it straight behind the listening position (middle of "SBL" and "SBR" in the diagram).

Ideal speaker layout

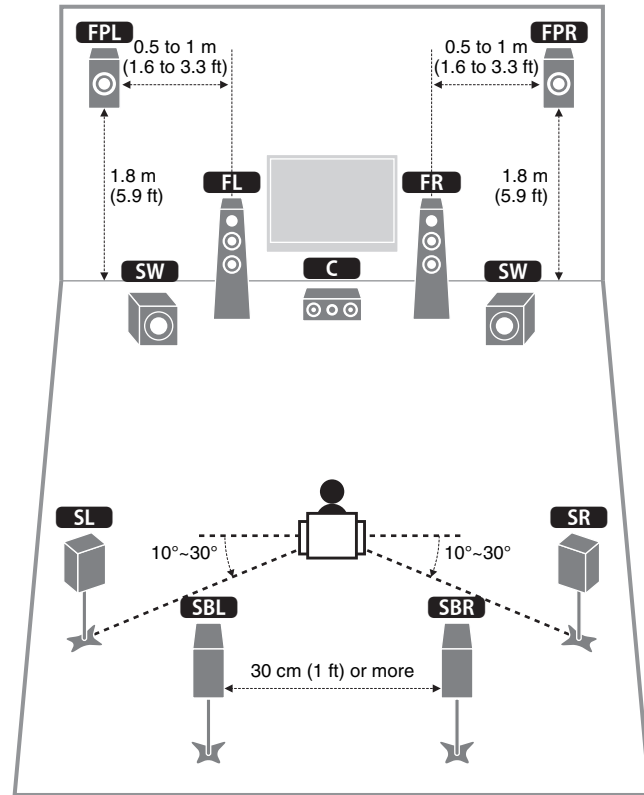

Basic speaker configuration

■ Placing speakers in your room

Depending on the number of speakers, place the speakers and subwoofer in your room. This section describes the representative speaker layout examples.

□ 7.1+2-channel system (using both surround back and front presence speakers)

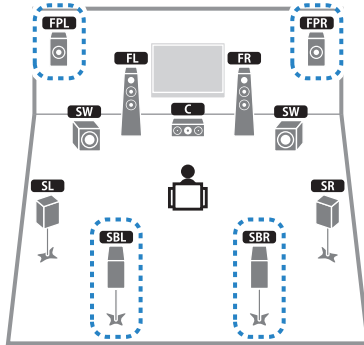

This speaker system brings out the full performance of the unit and allows you to enjoy a highly-natural 3-dimensional sound field with any contents.



- The surround back speakers and front presence speakers do not produce sounds simultaneously. The unit automatically changes the speakers to be used, depending on the selected CINEMA DSP (p.52).

□ 7.1-channel system (using front presence speakers)

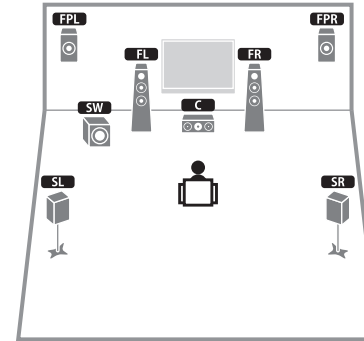

This speaker system uses the front presence speakers to produce a highly-natural 3-dimensional sound field, and is suited for enjoying 5.1-channel contents.

□ 7.1-channel system (using surround back speakers)

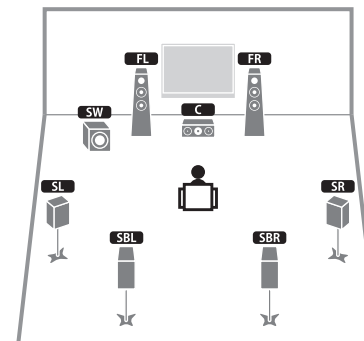

This speaker system creates Virtual Presence Speaker (VPS) using the front, center and surround speakers to produce a 3-dimensional sound field, and also allows you to enjoy extended surround sounds using the surround back speakers.

5.1-channel system

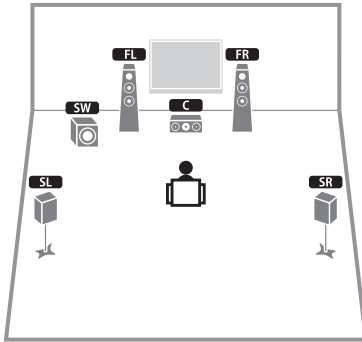

This speaker system creates Virtual Presence Speaker (VPS) using the front, center and surround speakers to produce a 3-dimensional sound field, and is suited for enjoying 5.1-channel contents.

2.1-channel system

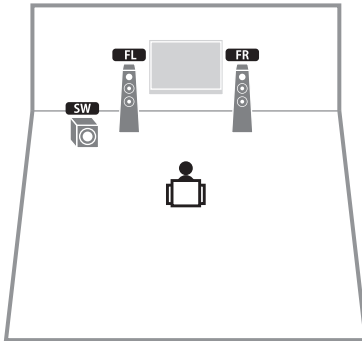

Even when no surround speakers are connected, the unit creates the virtual surround speakers using the front speakers to allow you to enjoy multi-channel surround sound (Virtual CINEMA DSP).



- Add the center speaker to configure a 3.1-channel system.

Setting the speaker impedance

Under its default settings, the unit is configured for 8-ohm speakers. When connecting 6-ohm speakers, set the speaker impedance to "6 Ω MIN". In this case, you can also use 4-ohm speakers as the front speakers.

- 1 Before connecting speakers, connect the power cable to an AC wall outlet.
- 2 While holding down STRAIGHT on the front panel, press MAIN ZONE .

MAIN ZONE  STRAIGHT

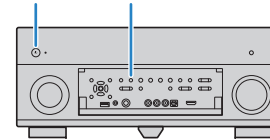

- 3 Check that "SPEAKER IMP." is displayed on the front display.



- 4 Press STRAIGHT to select "6 Ω MIN".
- 5 Press MAIN ZONE  to set the unit to standby mode and remove the power cable from the AC wall outlet.

You are now ready to connect the speakers.

■ Connecting speakers

Connect the speakers placed in your room to the unit.

Caution

- Remove the unit's power cable from an AC wall outlet and turn off the subwoofer before connecting the speakers.
- Ensure that the core wires of the speaker cable do not touch one another or come into contact with the unit's metal parts. Doing so may damage the unit or the speakers. If the speaker cables short circuit, "Check SP Wires" will appear on the front display when the unit is turned on.

Speakers to be connected

Room	Speaker type	Abbr.	Speaker system (the number of channels)				Power Amp Assign (p.100)
			7+2	7	5	2	
Main zone	Front (L)	FL	●	●	●	●	Basic (default)
	Front (R)	FR	●	●	●	●	
	Center	C	●	●	●		
	Surround (L)	SL	●	●	●		
	Surround (R)	SR	●	●	●		
	Surround back (L)	SBL	●	○*1			
	Surround back (R)	SBR	●	○*1			
	Front presence (L)	FPL	●	○*2			
	Front presence (R)	FPR	●	○*2			

If you have seven speakers, use two of them as surround back speakers (*1) or front presence speakers (*2).



- You can also connect up to 2 subwoofers (with built-in amplifier) to the unit.
- To use an external power amplifier (Hi-Fi amplifier, etc.) to enhance speaker output, see "Connecting an external power amplifier" (p.23).

Cables necessary for connection (commercially available)

Speaker cables (x the number of speakers)



Audio pin cable (two for connecting two subwoofers)



Connection diagram

Refer to the following diagram and connect the speakers to the unit.

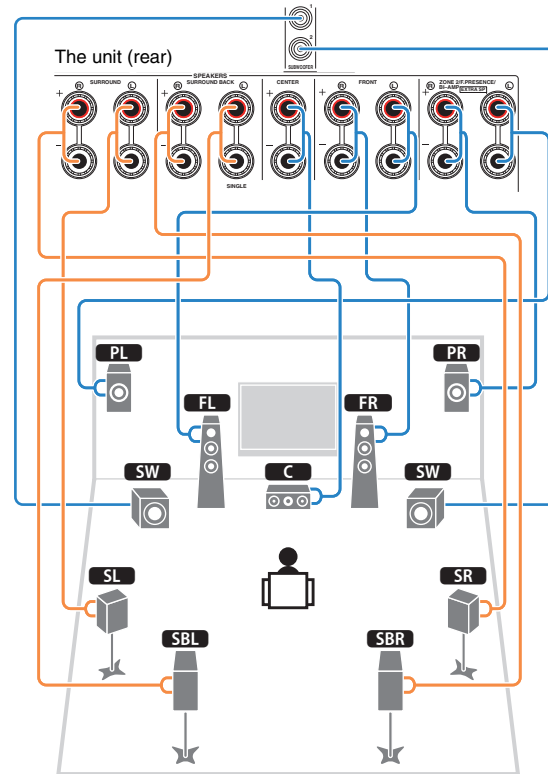

- When using only one surround back speaker, connect it to the SINGLE jack (L side).

❑ Connecting speaker cables

Speaker cables have two wires. One is for connecting the negative (-) terminal of the unit and the speaker, and the other is for the positive (+) terminal. If the wires are colored to prevent confusion, connect the black wire to the negative and the other wire to the positive terminal.

- ① Remove approximately 10 mm (3/8") of insulation from the ends of the speaker cable, and twist the bare wires of the cable firmly together.
- ② Loosen the speaker terminal.
- ③ Insert the bare wires of the cable into the gap on the side (upper right or bottom left) of the terminal.
- ④ Tighten the terminal.

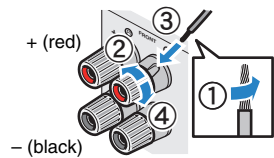

Using a banana plug

(U.S.A., Canada, China, Australia and General models only)

- ① Tighten the speaker terminal.
- ② Insert a banana plug into the end of the terminal.

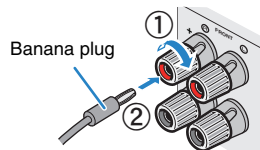

❑ Connecting the subwoofer (with built-in amplifier)

Use an audio pin cable to connect the subwoofer.

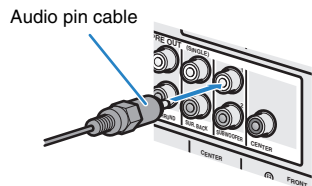

Advanced speaker configuration

In addition to the basic speaker configuration (p.15), the unit also allows you to apply the following speaker configurations to enhance your system.

Using the four internal amplifiers for front speakers to have more high-quality sounds

Bi-amp connection

(Example)

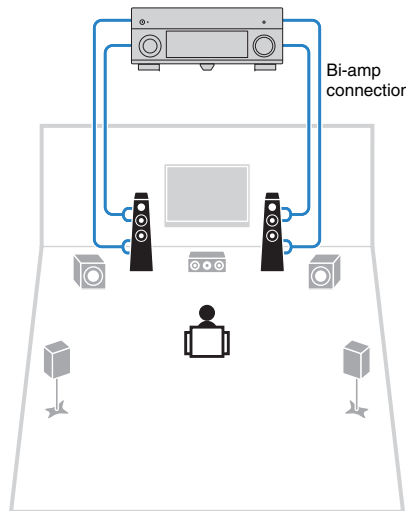

Combining with an external power amplifier (Hi-Fi amplifier, etc.) to build an extended system

Power-amp channel expansion

(Example)

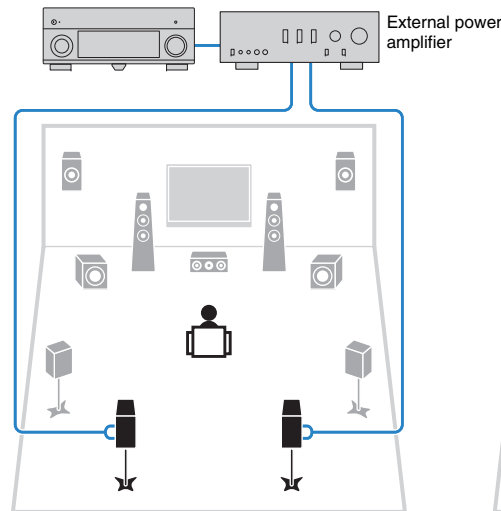

Using the excess internal amplifiers for stereo speakers in another room

Multi-zone configuration

(Example)

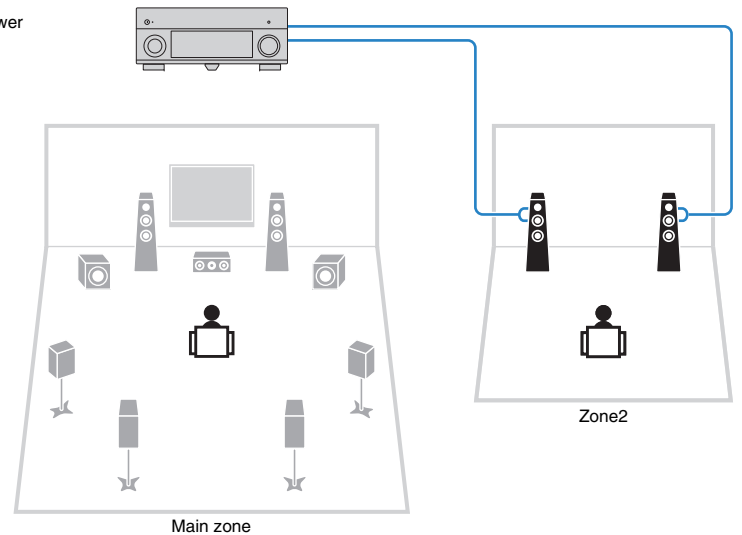

Available speaker configurations

Main zone			Multi-zone	Power Amp Assign (p.100)	Page
Output channel (max)	Bi-amp	External power amplifier (required)			
5	○			5ch BI-AMP	20
7	○	Surround back		5ch BI-AMP +SB	21
7			+1 (Zone2)	7ch +1ZONE	21



- When applying one of these configurations, you need to configure the "Power Amp Assign" setting (p.100) in the "Setup" menu.

5ch BI-AMP

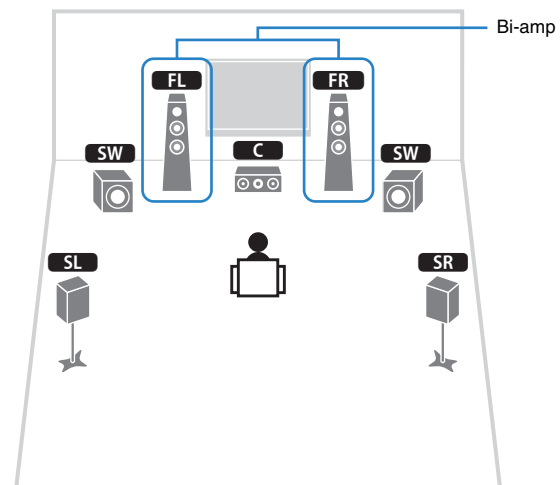

Speaker	Connect to
FL FR	FRONT and EXTRA SP (bi-amp connection)
C	CENTER
SL SR	SURROUND
SBL SBR	(not used)
FPL FPR	(not used)
SW	SUBWOOFER 1-2

5ch BI-AMP +SB

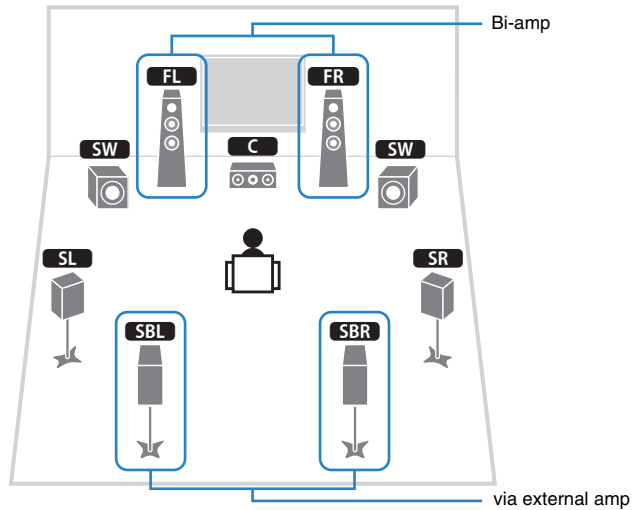

7ch +1ZONE

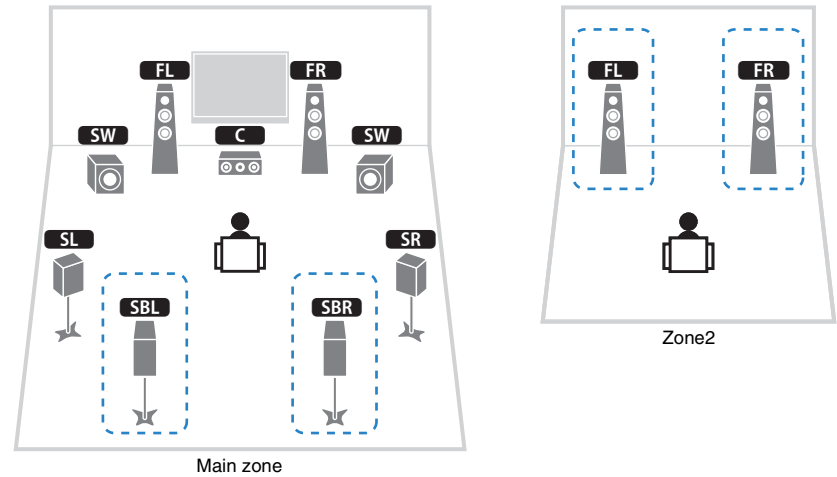

Speaker	Connect to
FL FR	FRONT and EXTRA SP (bi-amp connection)
C	CENTER
SL SR	SURROUND
SBL SBR	SUR.BACK (PRE OUT) via external power amplifier
FPL FPR	(not used)
SW	SUBWOOFER 1-2

Speaker	Connect to
FL FR	FRONT
C	CENTER
SL SR	SURROUND
SBL SBR	SURROUND BACK
FPL FPR	(not used)
SW	SUBWOOFER 1-2
Zone2 speakers	EXTRA SP



- When Zone2 output is enabled (p.81), the surround back speakers in the main zone do not output sound.

■ Connecting front speakers that support bi-amp connections

When using front speakers that support bi-amp connections, connect them to the FRONT terminals and EXTRA SP terminals.

To enable the bi-amp function, configure the “Power Amp Assign” setting (p.100) in the “Setup” menu after connecting the power cable to an AC wall outlet.

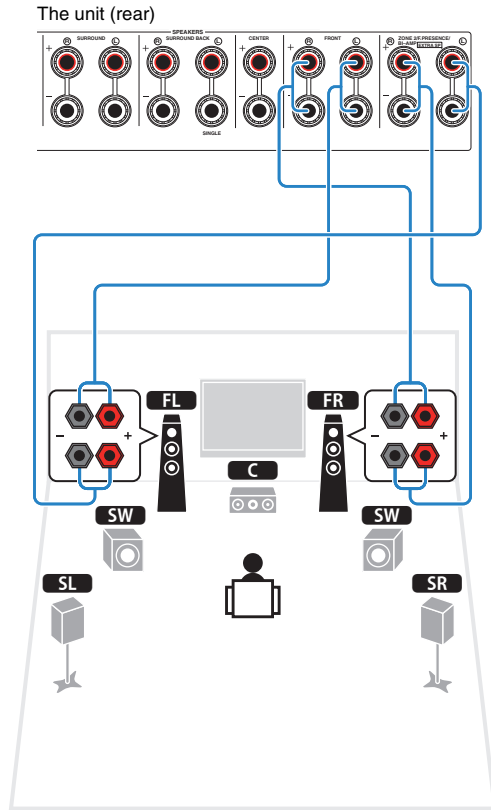

Caution

- Before making bi-amp connections, remove any brackets or cables that connect a woofer with a tweeter. Refer to the instruction manual of the speakers for details. If you are not making bi-amp connections, make sure that the brackets or cables are connected before connecting the speaker cables.

■ Connecting Zone2 speakers

When using Zone2 speakers, connect them to the EXTRA SP terminals.

To utilize the EXTRA SP terminals for Zone2 speakers, configure the “Power Amp Assign” setting (p.100) in the “Setup” menu after connecting the power cable to an AC wall outlet.

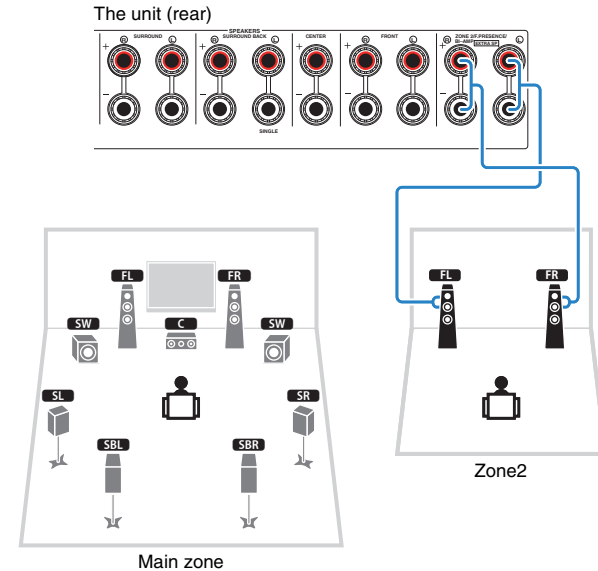

- You can also connect Zone2 speakers using an external amplifier (p.79).

■ Connecting an external power amplifier

When connecting an external power amplifier (pre-main amplifier) to enhance speaker output, connect the input jacks of the power amplifier to the PRE OUT jacks of the unit. The same channel signals are output from the PRE OUT jacks as from their corresponding SPEAKERS terminals.

Caution

- To prevent the generation of loud noises or abnormal sounds, make sure the followings before making connections.
 - Remove the power cable of the unit and turn off the external power amplifier before connecting them.
 - When using the PRE OUT jacks, do not connect speakers to the corresponding SPEAKERS terminals.
 - When using a pre-main amplifier that does not have the volume control bypass, turn up the volume of the pre-main amplifier enough and fix it. In this case, do not connect other devices (except the unit) to the pre-main amplifier.

The unit (rear)

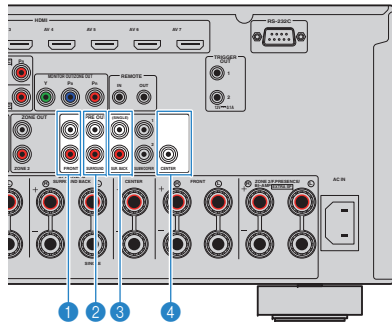

1 FRONT jacks

Output front channel sounds.

2 SURROUND jacks

Output surround channel sounds.

3 SUR. BACK jacks

Output surround back channel sounds. When using only one surround back speaker, connect the external amplifier to the SINGLE jack (L side).

4 CENTER jack

Outputs center channel sounds.

(Example)

Connecting front speakers via an external power amplifier

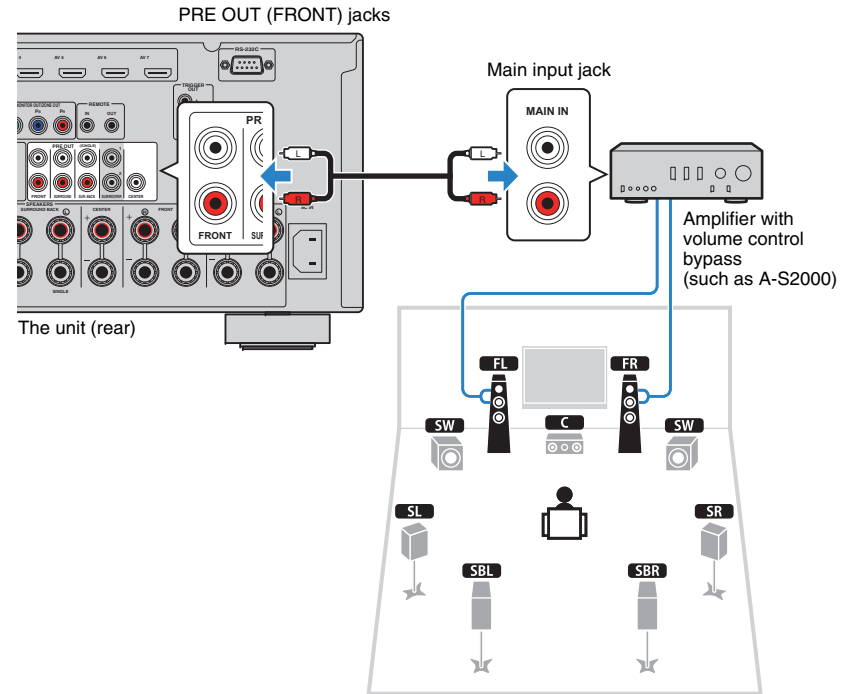

About external power amplifiers

We recommend using power amplifiers that meet the following conditions.

- With unbalanced inputs
- With volume control bypass (or without volume control circuit)
- Output power: about 100 W (6 to 8 Ω)

Input/output jacks and cables

Video/audio jacks

HDMI jacks

Transmit digital video and digital sound through a single jack. Use an HDMI cable.



HDMI cable

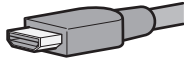

- Use a 19-pin HDMI cable with the HDMI logo. We recommend using a cable less than 5.0 m (16.4 ft) long to prevent signal quality degradation.



- The unit's HDMI jacks support the HDMI Control, Audio Return Channel (ARC), and 3D and 4K video transmission features.
- Use high speed HDMI cables to enjoy 3D or 4K videos.

Video jacks

COMPONENT VIDEO jacks

Transmit video signals separated into three components: luminance (Y), chrominance blue (Pb), and chrominance red (Pr). Use a component video cable with three plugs.

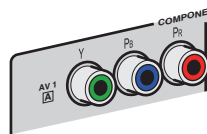

Component video cable

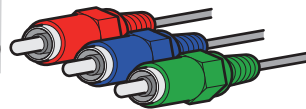

S VIDEO jack

Transmits S-video signals that include luminance (Y) and chrominance (C) components. Use an S-video cable.

S-video cable

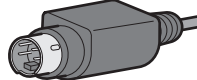

VIDEO jacks

Transmit analog video signals. Use a video pin cable.



Video pin cable

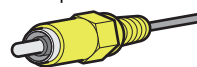

Audio jacks

OPTICAL jacks

Transmit digital audio signals. Use a digital optical cable. Remove the tip protector (if available) before using the cable.



Digital optical cable

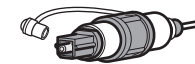

COAXIAL jacks

Transmit digital audio signals. Use a digital coaxial cable.



Digital coaxial cable

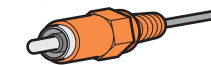

AUDIO jacks

Transmit analog stereo audio signals. Use a stereo pin cable.



Stereo pin cable

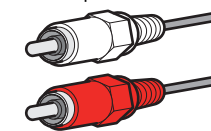

2 Connecting a TV

Connect a TV to the unit so that video input to the unit can be output to the TV. You can also enjoy playback of TV audio on the unit. The connection method varies depending on the functions and video input jacks available on your TV. Refer to the instruction manual of the TV and choose a connection method.

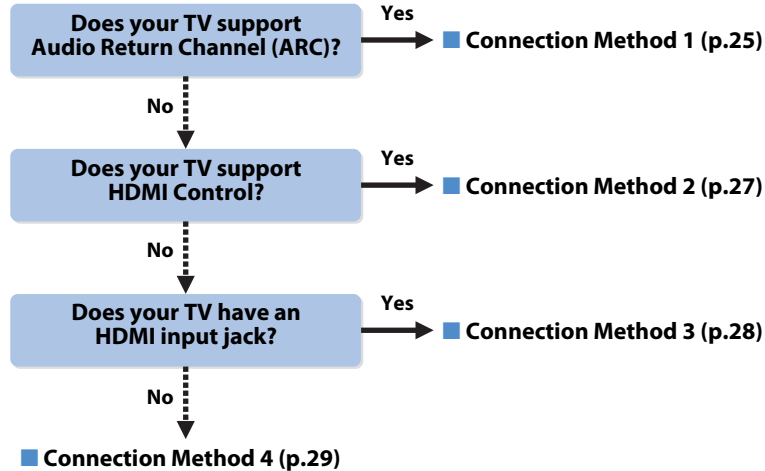

About HDMI Control

HDMI Control allows you to operate external devices via HDMI. If you connect a TV that supports HDMI Control to the unit with an HDMI cable, you can control the unit's power and volume with the TV's remote control. You can also control playback devices (such as an HDMI Control-compatible BD/DVD player) connected to the unit with an HDMI cable. For details, see "HDMI Control" (p.137).

About Audio Return Channel (ARC)

ARC allows audio signals to travel both ways under HDMI Control. If you connect a TV that supports HDMI Control and ARC to the unit with a single HDMI cable, you can output video/audio to the TV or input TV audio to the unit.

■ Connection Method 1 (HDMI Control/ARC-compatible TV)

Connect the TV to the unit with an HDMI cable.



- The following explanation is based on the assumption that you have not changed the "HDMI" parameters (p.106) in the "Setup" menu.
- HDMI Control is available only on the HDMI OUT 1 jack.
- Use an HDMI cable that supports ARC.

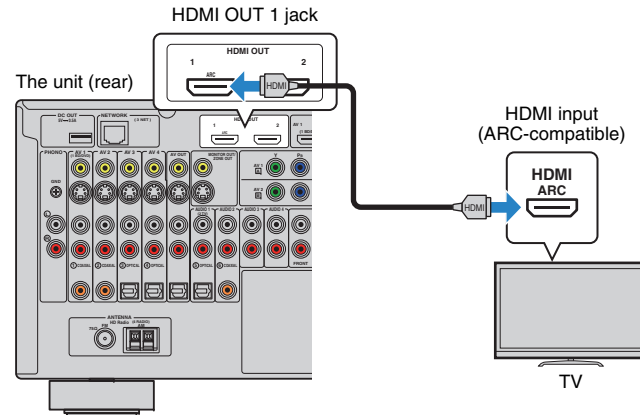

- By connecting a TV to the unit with an HDMI cable, any video input to the unit can be output to the TV, regardless of the method used to connect the video device to the unit. For details, see "Video signal flow" (p.136).
- By connecting a TV to the unit with an HDMI cable, you can navigate the iPod, USB storage device and network sources, or configure the settings of the unit with the menu displayed on the TV.
- You can connect another TV or a projector by using the HDMI OUT 2 jack (p.30).

❑ Necessary settings

To use HDMI Control and ARC, you need to configure the following settings.
For details on settings and operating your TV, refer to the instruction manual for the TV.

1 After connecting external devices (such as a TV and playback devices) and the power cable to the unit, turn on the unit, TV, and playback devices.

2 Configure the settings of the unit.

- ① Check that ARC is enabled on the TV.
- ② Switch the TV input to display video from the unit.
- ③ Press ON SCREEN.

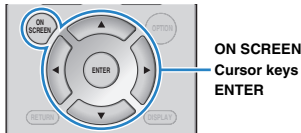

- ④ Use the cursor keys to select “Setup” and press ENTER.

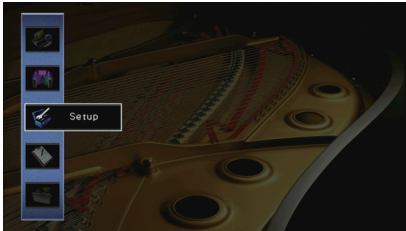

- ⑤ Use the cursor keys (</>) to select “HDMI”.



- ⑥ Use the cursor keys (Δ/▽) to select “HDMI Control” and press ENTER.
- ⑦ Use the cursor keys to select “On”.
- ⑧ Press ON SCREEN.

3 Configure the settings for HDMI Control.

- ① Enable HDMI Control on the TV and playback devices (such as HDMI Control-compatible BD/DVD player).
- ② Turn off the TV's main power and then turn off the unit and playback devices.
- ③ Turn on the unit and playback devices and then turn on the TV's main power.
- ④ Switch the TV input to display video from the unit.
- ⑤ Check the following.

On the unit: The input to which the playback device is connected is selected. If not, select the input source manually.

On the TV: The video from the playback device is displayed.

- ⑥ Check that the unit is properly synchronized with the TV by turning off the TV or adjusting the TV volume with the TV remote control.

This completes the necessary settings.

If you select a TV program with the TV remote control, the input source of the unit will be automatically switched to “AUDIO 1” and the TV audio will be played back on the unit. If you cannot hear the TV's audio, check that “ARC” (p.106) in the “Setup” menu is set to “On”.



- If HDMI Control does not work properly, try turning off and on (or unplugging and then plugging in again) the devices. It may solve the problem.
- If the unit is not synchronized to the TV's power operations, check the priority of the audio output setting on the TV.
- If the audio is interrupted while using ARC, set “ARC” (p.106) in the “Setup” menu to “Off” and use an audio cable (digital optical or stereo pin cable) to input TV audio to the unit (p.27).



- “AUDIO 1” is set as TV audio input at the factory. If you have connected any external device to the AUDIO 1 jacks, use “TV Audio Input” (p.106) in the “Setup” menu to change the TV audio input assignment. To use the SCENE function (p.49), you also need to change the input assignment for SCENE(TV).

■ Connection Method 2 (HDMI Control-compatible TV)

Connect the TV to the unit with an HDMI cable and an audio cable (digital optical or stereo pin cable).



- The following explanation is based on the assumption that you have not changed the “HDMI” parameters (p.106) in the “Setup” menu.
- HDMI Control is available only on the HDMI OUT 1 jack.

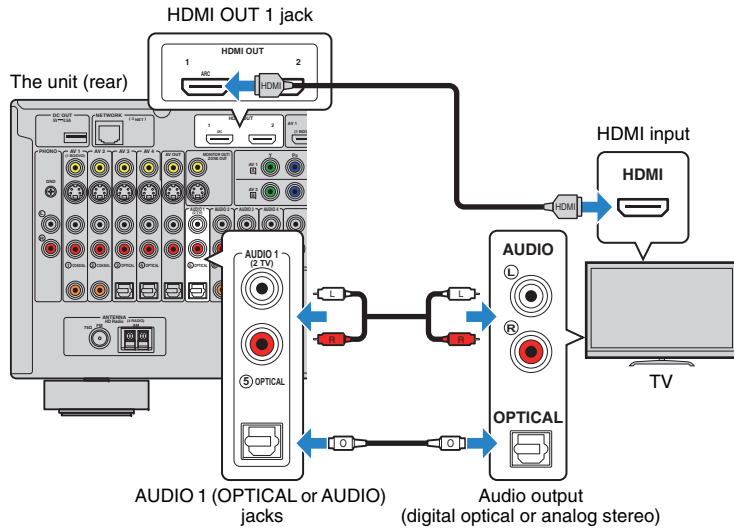

- By connecting a TV to the unit with an HDMI cable, any video input to the unit can be output to the TV, regardless of the method used to connect the video device to the unit. For details, see “Video signal flow” (p.136).
- By connecting a TV to the unit with an HDMI cable, you can navigate the iPod, USB storage device and network sources, or configure the settings of the unit with the menu displayed on the TV.
- You can connect another TV or a projector by using the HDMI OUT 2 jack (p.30).

□ Necessary settings

To use HDMI Control, you need to configure the following settings.

For details on settings and operating your TV, refer to the instruction manual for the TV.

1 After connecting external devices (such as a TV and playback devices) and power cable of the unit, turn on the unit, TV, and playback devices.

2 Configure the settings of the unit.

- ① Switch the TV input to display video from the unit.
- ② Press ON SCREEN.

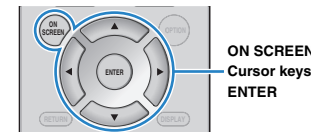

- ③ Use the cursor keys to select “Setup” and press ENTER.

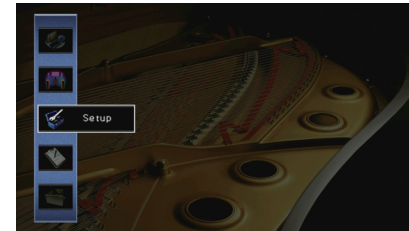

- ④ Use the cursor keys (</>) to select “HDMI”.



- ⑤ Use the cursor keys (Δ/▽) to select “HDMI Control” and press ENTER.
- ⑥ Use the cursor keys to select “On”.
- ⑦ Press ON SCREEN.

3 Configure the settings for HDMI Control.

- ① Enable HDMI Control on the TV and playback devices (such as a HDMI Control-compatible BD/DVD player).
- ② Turn off the TV's main power and then turn off the unit and playback devices.
- ③ Turn on the unit and playback devices and then turn on the TV.
- ④ Switch the TV input to display video from the unit.
- ⑤ Check the following.

On the unit: The input to which the playback device is connected is selected. If not, select the input source manually.

On the TV: The video from the playback device is displayed.

- ⑥ Check that the unit is properly synchronized with the TV by turning off the TV or adjusting the TV volume with the TV remote control.

This completes the necessary settings.

If you select a TV program with the TV remote control, the input source of the unit will be automatically switched to "AUDIO 1" and the TV audio will be played back on the unit.



- If HDMI Control does not work properly, try turning off and on (or unplugging and then plugging in again) the devices. It may solve the problem.
- If the unit is not synchronized to the TV's power operations, check the priority of the audio output setting on the TV.



- "AUDIO 1" is set as TV audio input at the factory. If you have connected any external device to the AUDIO 1 jacks, use "TV Audio Input" (p.106) in the "Setup" menu to change the TV audio input assignment. To use the SCENE function (p.49), you also need to change the input assignment for SCENE(TV).

■ Connection Method 3 (TV with HDMI input jacks)

Connect the TV to the unit with an HDMI cable and an audio cable (digital optical or stereo pin cable).

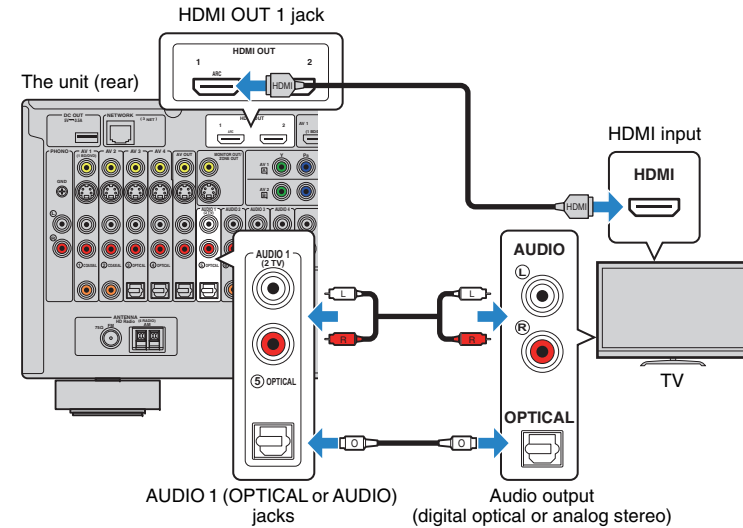

If you select "AUDIO 1" as the input source by pressing AUDIO 1 or SCENE(TV) on the remote control, the TV audio will be played back on the unit.



- By connecting a TV to the unit with an HDMI cable, any video input to the unit can be output to the TV, regardless of the method used to connect the video device to the unit. For details, see "Video signal flow" (p.136).
- By connecting a TV to the unit with an HDMI cable, you can navigate the iPod, USB storage device and network sources, or configure the settings of the unit with the menu displayed on the TV.
- If you have connected any external device to the AUDIO 1 jacks, connect the TV to one of the AUDIO 2-4 jacks. To use the SCENE function (p.49), you also need to change the input assignment for SCENE(TV).
- You can connect another TV or a projector by using the HDMI OUT 2 jack (p.30).

■ Connection Method 4 (TV without HDMI input jacks)

Depending on the video input jacks available on your TV, choose one of the following connections.

If you select "AUDIO 1" as the input source by pressing AUDIO 1 or SCENE(TV) on the remote control, the TV audio will be played back on the unit.



- If you connect your TV to the unit with a cable other than HDMI, video input to the unit via HDMI cannot be output to the TV.
- Operations with TV screen are available only when your TV is connected to the unit via HDMI.



- If you have connected any external device to the AUDIO 1 jacks, connect the TV to one of the AUDIO 2-4 jacks. To use the SCENE function (p.49), you also need to change the input assignment for SCENE(TV).

□ COMPONENT VIDEO connection (with a component video cable)

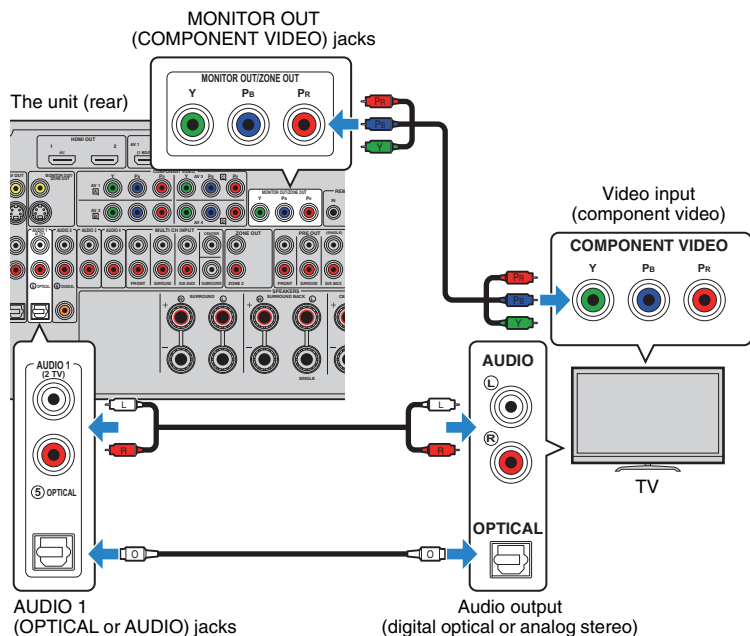

□ S VIDEO connection (with an S-video cable)

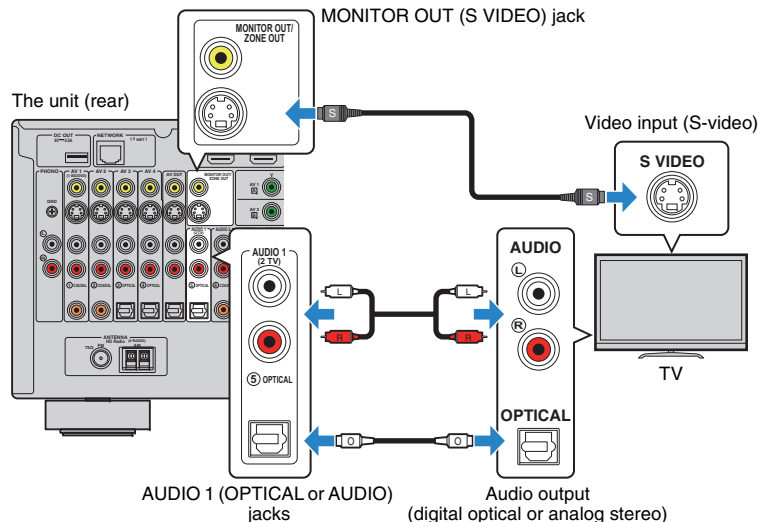

□ VIDEO (composite video) connection (with a video pin cable)

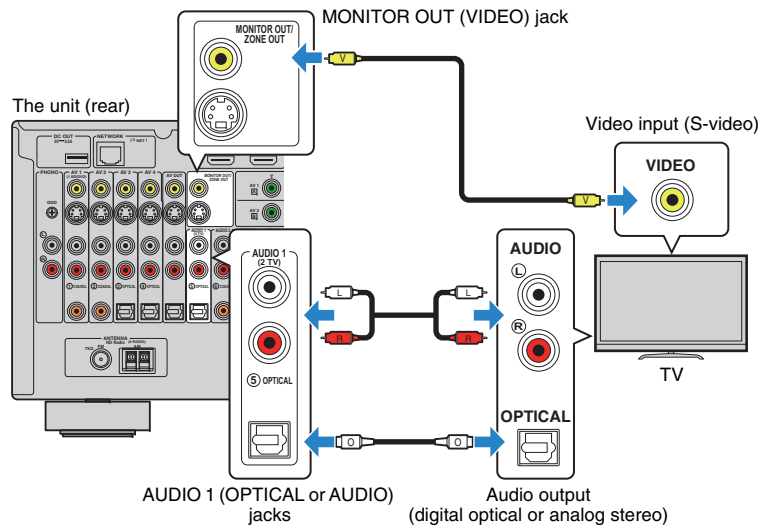

■ Connecting another TV or a projector

The unit has two HDMI output jacks. If you connect another TV or a projector to the unit with an HDMI cable, you can switch the TV (or projector) to be used for watching videos with the remote control (p.48).

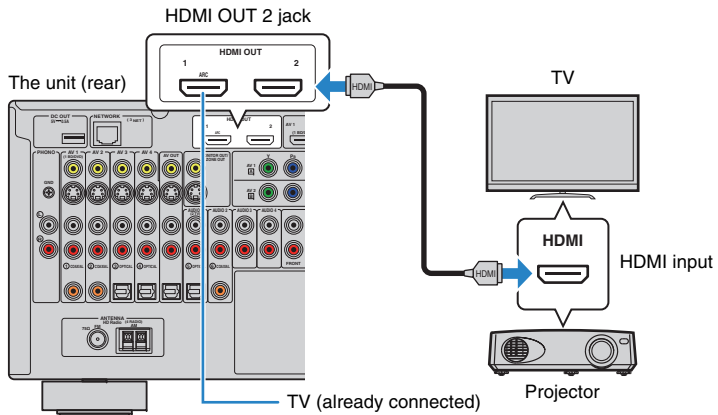

- HDMI Control is not available on the HDMI OUT 2 jack.

3 Connecting playback devices

The unit is equipped with a variety of input jacks including HDMI input jacks to allow you to connect different types of playback devices. For information on how to connect an iPod or a USB storage device, see the following pages.

- Connecting an iPod (p.64)
- Connecting a USB storage device (p.68)

Connecting video devices (such as BD/DVD players)

Connect video devices such as BD/DVD players, set-top boxes (STBs) and game consoles to the unit. Depending on the video/audio output jacks available on your video device, choose one of the following connections. We recommend using an HDMI connection if the video device has an HDMI output jack.



- Videos input to the unit via HDMI cannot be output to a TV connected to the unit with a cable other than HDMI.
- The following explanation is based on the assumption that you have not changed the "Input Assignment" setting (p.111) in the "Setup" menu. As necessary, you can assign the COMPONENT VIDEO (A, B, C, D), COAXIAL (1, 2, 6) and OPTICAL (3, 4, 5) jacks to another input source.



- If you make more than one audio connection for one input source, an audio signal played back on the unit will be determined according to the "Audio Select" setting (p.87) in the "Option" menu.

HDMI connection

Connect a video device to the unit with an HDMI cable.

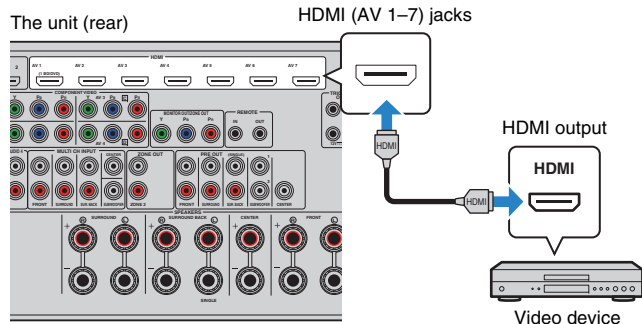

If you select the input source by pressing AV 1-7 on the remote control, the video/audio played back on the video device will be output from the unit.

Component video connection

Connect a video device to the unit with a component video cable and an audio cable (digital coaxial, digital optical or stereo pin cable). Choose a set of input jacks (on the unit) depending on the audio output jacks available on your video device.

Output jacks on video device		Input jacks on the unit
Video	Audio	
Component video	Digital optical	AV 1-2 (COMPONENT VIDEO + OPTICAL)
	Digital coaxial	AV 3-4 (COMPONENT VIDEO + COAXIAL)
	Analog stereo	AV 1-4 (COMPONENT VIDEO + AUDIO)

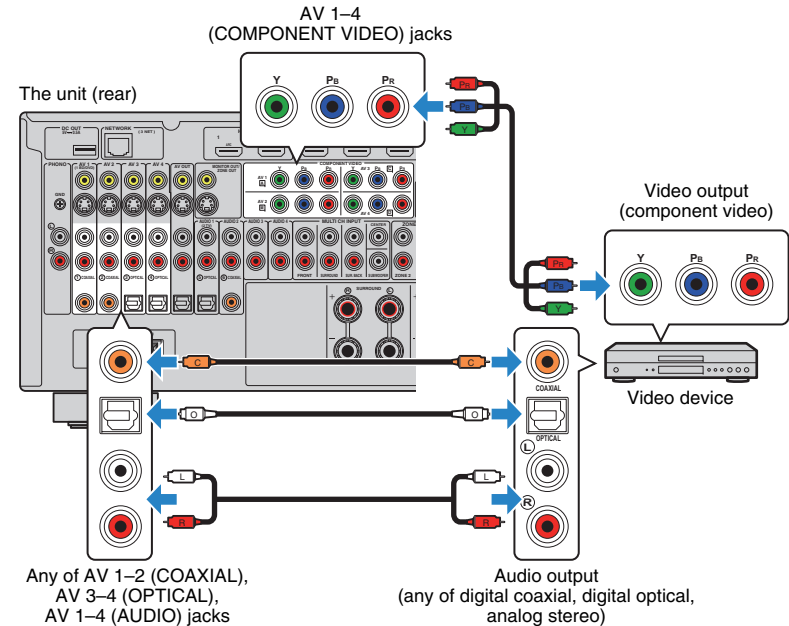

If you select the input source by pressing AV 1-4 on the remote control, the video/audio played back on the video device will be output from the unit.

S-video connection

Connect a video device to the unit with an S-video cable and an audio cable (digital coaxial, digital optical or stereo pin cable). Choose a set of input jacks (on the unit) depending on the audio output jacks available on your video device.

Output jacks on video device		Input jacks on the unit
Video	Audio	
S-video	Digital coaxial	AV 1-2 (S VIDEO + COAXIAL)
	Digital optical	AV 3-4 (S VIDEO + OPTICAL)
	Analog stereo	AV 1-4 (S VIDEO + AUDIO)

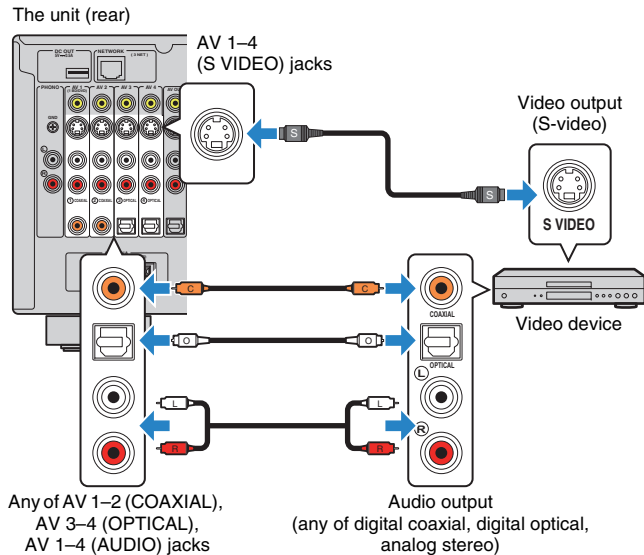

If you select the input source by pressing AV 1-4 on the remote control, the video/audio played back on the video device will be output from the unit.

Composite video connection

Connect a video device to the unit with a video pin cable and an audio cable (digital coaxial, digital optical, or stereo pin cable). Choose a set of input jacks (on the unit) depending on the audio output jacks available on your video device.

Output jacks on video device		Input jacks on the unit
Video	Audio	
Composite video	Digital coaxial	AV 1-2 (VIDEO + COAXIAL)
	Digital optical	AV 3-4 (VIDEO + OPTICAL)
	Analog stereo	AV 1-4 (VIDEO + AUDIO)

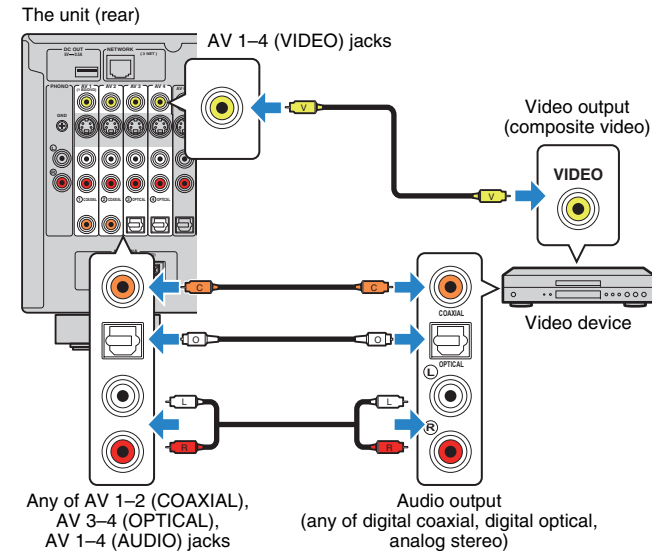

If you select the input source by pressing AV 1-4 on the remote control, the video/audio played back on the video device will be output from the unit.

Connecting audio devices (such as CD players)

Connect audio devices such as CD players, MD players, and a turntable to the unit. Depending on the audio output jacks available on your audio device, choose one of the following connections.



- The following explanation is based on the assumption that you have not changed the "Input Assignment" setting (p.111) in the "Setup" menu. As necessary, you can assign the COAXIAL (①, ②, ⑥) and OPTICAL (③, ④, ⑤) jacks to another input source.



- If you make more than one audio connection for one input source, an audio signal played back on the unit will be determined according to the "Audio Select" setting (p.87) in the "Option" menu.

Audio output jacks on audio device	Audio output jacks on the unit
Digital optical	AV 1-2 (COAXIAL) AUDIO 2 (COAXIAL)
Digital coaxial	AV 3-4 (OPTICAL) AUDIO 1 (OPTICAL)
Analog stereo	AV 1-4 (AUDIO) AUDIO 1-4 (AUDIO)
Turntable (PHONO)	PHONO

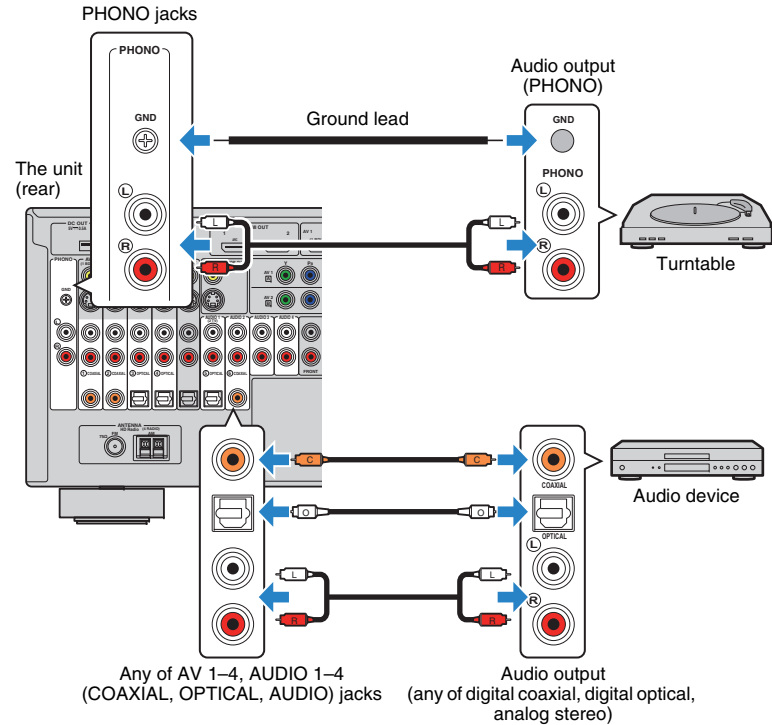

If you select the input source by pressing AV 1-4, AUDIO 1-4 or PHONO on the remote control, the audio played back on the audio device will be output from the unit.

When connecting a turntable

- The PHONO jack of the unit is compatible with an MM cartridge. To connect a turntable with a low-output MC cartridge, use a boosting transformer.
- Connecting the turntable to the GND terminal of the unit may reduce noise in the signal.

Connecting to the jacks on the front panel

Use the VIDEO AUX jack to temporarily connect devices such as game consoles and camcorders to the unit.

Before making a connection, stop playback on the device and turn down the volume on the unit.

The unit (front)

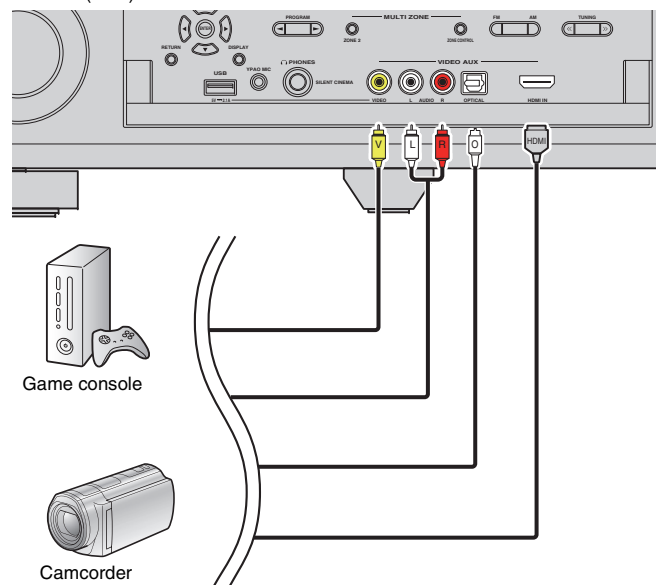

If you select "V-AUX" as the input source by pressing V-AUX on the remote control, the video/audio played back on the device will be output from the unit.



- You need to prepare a cable that match the output jacks on your device.



- If you connect video devices to both the HDMI IN jack and analog video/audio jacks, the unit outputs video/audio input through the HDMI IN jack.
- When "USB" is selected as the input source, video signals input to the VIDEO AUX (VIDEO) jack are output from the HDMI OUT and MONITOR OUT (VIDEO) jacks.

4 Connecting the FM/AM antennas

Connect the supplied FM/AM antennas to the unit.

Fix the end of the FM antenna to a wall, and place the AM antenna on a flat surface.

- The supplied antennas and the location of the antenna jacks vary depending on the region of purchase.

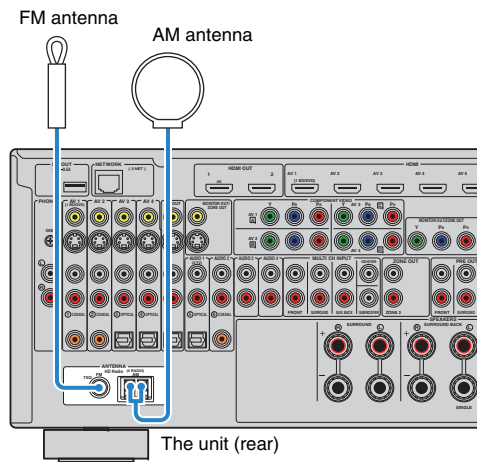

Assembling the AM antenna

(U.S.A. model)

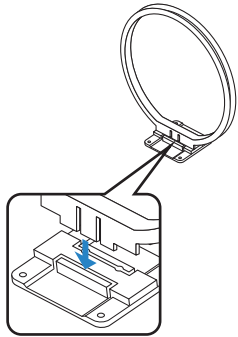

(Other models)

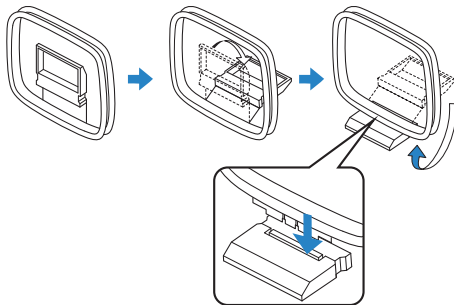

Connecting the AM antenna

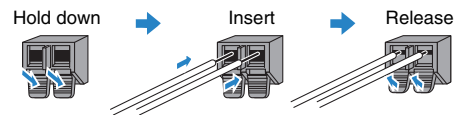

- Unwind only the length of cable needed from the AM antenna unit.
- The wires of the AM antenna have no polarity.

5 Connecting to a network

Connect the unit to your router with a commercially-available STP network cable (CAT-5 or higher straight cable).

You can enjoy Internet radio or music files stored on media servers, such as PCs and Network Attached Storage (NAS), on the unit.

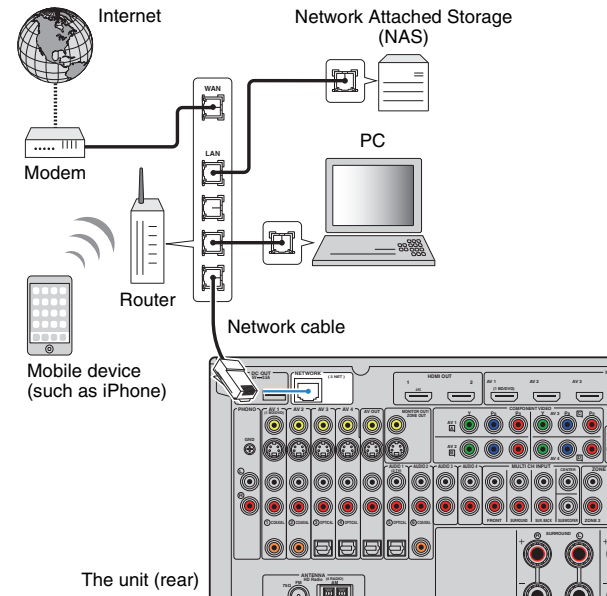

- If you are using a router that supports DHCP, you do not need to configure any network settings for the unit, as the network parameters (such as the IP address) will be assigned automatically to it. You only need to configure the network settings if your router does not support DHCP or if you want to configure the network parameters manually (p.107).
- You can check whether the network parameters (such as IP address) are properly assigned to the unit in "Network" (p.115) in the "Information" menu.



- Some security software installed on your PC or the firewall settings of network devices (such as a router) may block the access of the unit to the network devices or the Internet. In these cases, configure the security software or firewall settings appropriately.
- Each server must be connected to the same subnet as the unit.
- To use the service via the Internet, broadband connection is strongly recommended.

6 Connecting other devices

Connecting recording devices

You can connect video/audio recording devices to the AV OUT jacks. These jacks output video/audio signals selected as the input.



- The AV OUT jacks cannot output video/audio signals input through the HDMI or COMPONENT VIDEO jacks.
- Be sure to use the AV OUT jacks only for connecting recording devices.

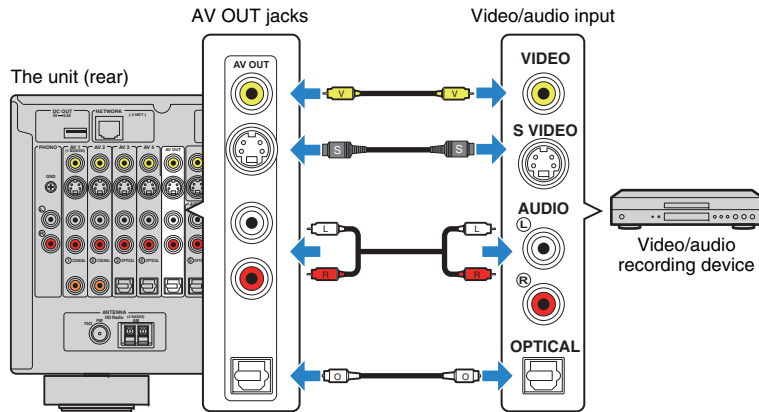

Connecting a device with analog multi-channel output

You can connect an analog multi-channel output device such as a DVD player and an SACD player to the MULTI CH INPUT jacks.

The unit (rear)

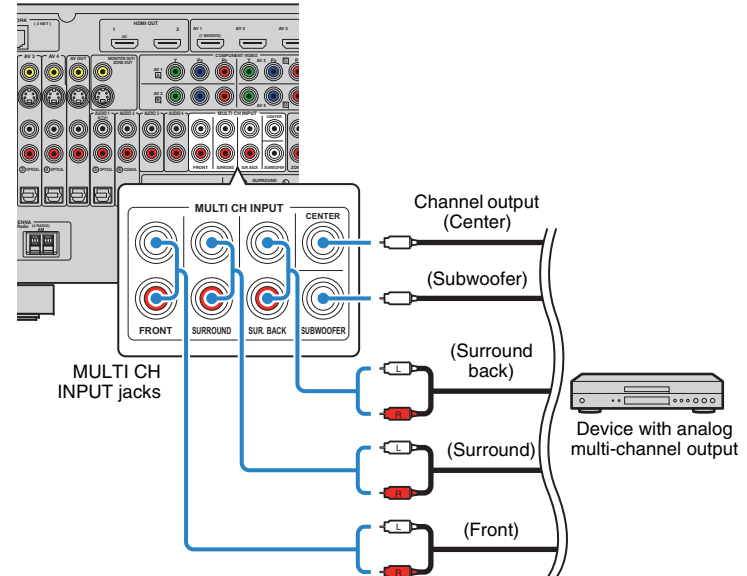

If you select "MULTI CH" as the input source by pressing MULTI on the remote control, the audio played back on the device will be output from the unit.



- You can select a video source to be displayed when "MULTI CH" is selected as the input source using "Video Out" (p.90) in the "Input" menu. When connecting a video device (such as a DVD player) to the MULTI CH INPUT jacks, use the input jack specified in "Video Out" for the video connection.
- Since the unit does not redirect signals input to the MULTI CH INPUT jacks to accommodate for missing speakers, make appropriate settings on the external device (such as a DVD player) that suit to the speaker configuration.
- When "MULTI CH" is selected as the input source, sound mode selection and tone control adjustment are not available.

Connecting a device that supports SCENE link playback (remote connection)

If you have a Yamaha product that supports SCENE control signal transmission, you can operate it remotely by connecting it to the REMOTE OUT jack, using a monaural mini-jack cable, and linking with the SCENE function (p.49).

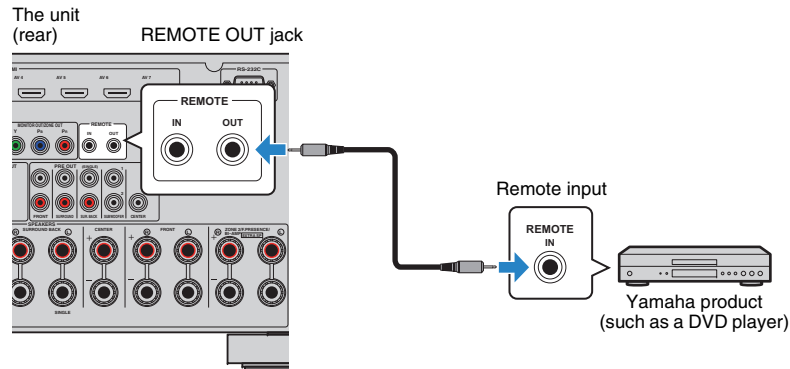

- If you connect a Yamaha product that supports the SCENE link playback function to the REMOTE OUT jack, you can remotely start playback on it by linking with a scene selection (p.49). To enable the SCENE link playback function, specify the device type in "Device Control" (p.92) in the "Scene" menu.
- You can also connect an infrared signal receiver/emitter to operate devices in the main zone from Zone2 (p.80).

Connecting a device compatible with the trigger function

The trigger function can control an external device in conjunction with operating the unit (such as powering on/off and input selection). If you have a Yamaha subwoofer that supports a system connection or a device with a trigger input jack, you can use the trigger function by connecting the external device to one of the TRIGGER OUT jacks.

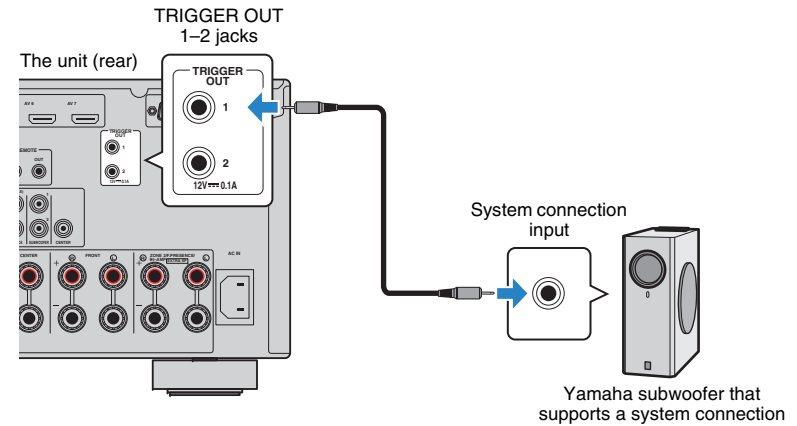

- You can configure the trigger function settings in "Trigger Output1" and "Trigger Output2" (p.112) in the "Setup" menu.

7 Connecting the power cable

Before connecting the power cable (General model only)

Set the switch position of VOLTAGE SELECTOR according to your local voltage. Voltages are AC 110–120/220–240 V, 50/60 Hz.



- Make sure you set VOLTAGE SELECTOR of the unit BEFORE plugging the power cable into an AC wall outlet. Improper setting of VOLTAGE SELECTOR may cause damage to the unit and create a potential fire hazard.

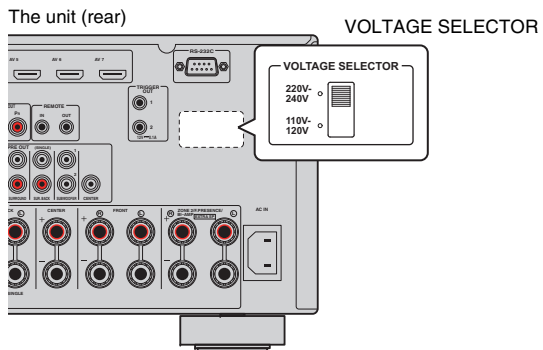

After all the connections are complete, connect the supplied power cable to the unit and then to an AC wall outlet.

The unit (rear)

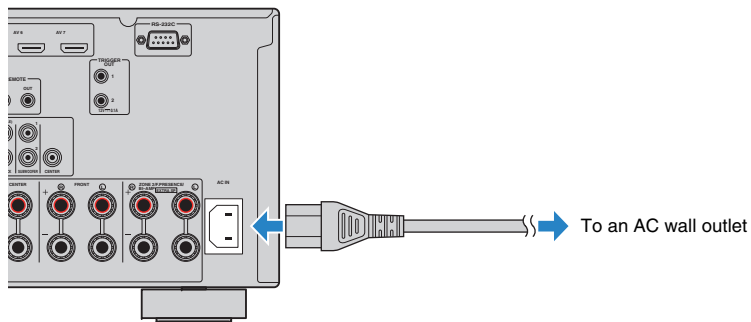

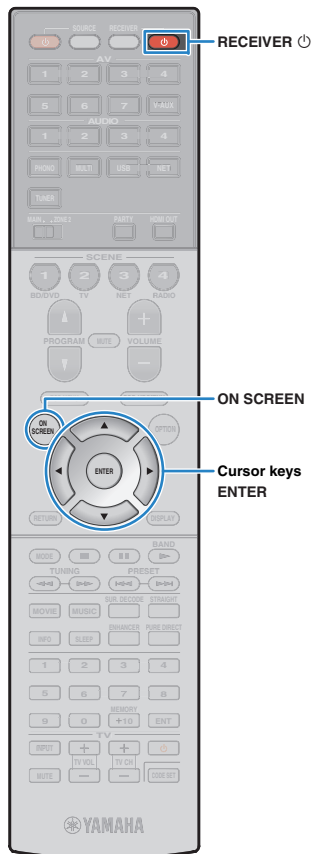

8 Selecting an on-screen menu language

Select the desired on-screen menu language from English (default), Japanese, French, German, Spanish, Russian and Chinese.

- 1 Press RECEIVER to turn on the unit.
- 2 Turn on the TV and switch the TV input to display video from the unit (HDMI OUT jack).
- 3 Press ON SCREEN.
- 4 Use the cursor keys to select “Setup” and press ENTER.

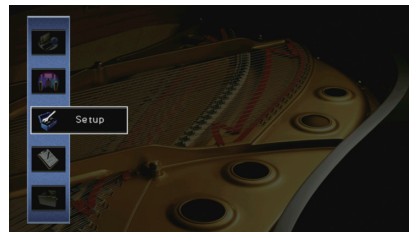

- 5 Use the cursor keys (</>) to select “Language” and the cursor keys (Δ/▽) to select the desired language.

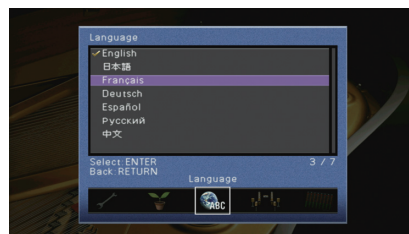

6 To confirm the setting, press ENTER.

7 To exit from the menu, press ON SCREEN.



• The information on the front display is provided in English only.

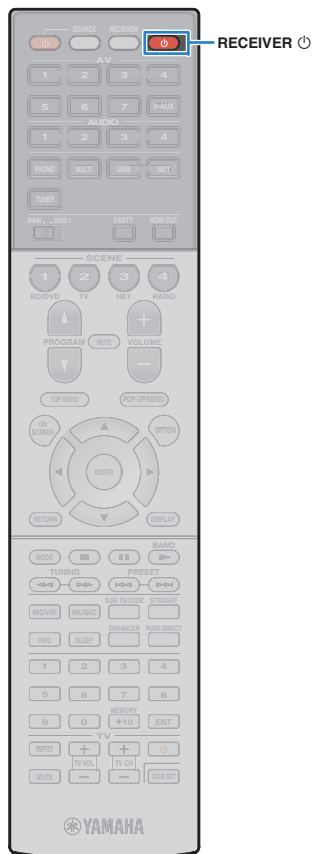

9 Optimizing the speaker settings automatically (YPAO)

The Yamaha Parametric room Acoustic Optimizer (YPAO) function detects speaker connections, measures the distances from them to your listening position(s), and then automatically optimizes the speaker settings, such as volume balance and acoustic parameters, to suit your room.



- Please note the following when using YPAO.
 - Use YPAO after connecting a TV and speakers to the unit.
 - During the measuring process, test tones are output at high volume. Ensure that the test tones do not frighten small children. Also, refrain from using this function at night when it may be a nuisance to others.
 - During the measuring process, you cannot adjust the volume.
 - During the measuring process, keep the room as quiet as possible.
 - Do not connect headphones.

- 1 Press **RECEIVER** to turn on the unit.
- 2 Turn on the TV and switch the TV input to display video from the unit (HDMI OUT jack).
- 3 Turn on the subwoofer and set the volume to half. If the crossover frequency is adjustable, set it to maximum.

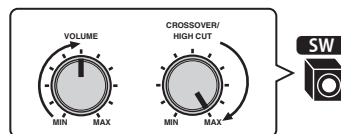

- 4 According to your speaker configuration, configure the “Power Amp Assign” setting (p.100) in the “Setup” menu.

For the basic speaker configuration (p.15): set to “Basic” (default).

For any of the advanced speaker configurations (p.19): set to the appropriate setting.

- 5 Place the YPAO microphone at your listening position (same height as your ears) and connect it to the YPAO MIC jack on the front panel.

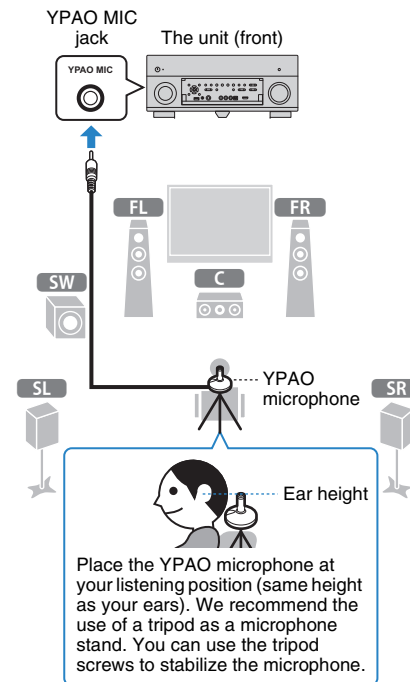



Cursor keys
ENTER

The following screen appears on the TV.

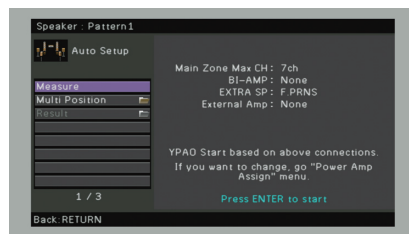

- To cancel the operation, disconnect the YPAO microphone before starting the measurement.

6 If desired, change the measuring method (multi/single).

- ① Use the cursor keys to select “Multi Position” and press ENTER.
- ② Use the cursor keys to select a setting and then press ENTER.

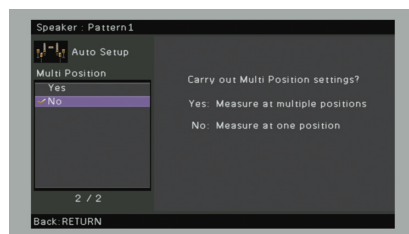

Settings

Yes	Select this option if you will have several listening positions or if you want others to enjoy surround sound. You can take measurements at up to 8 different positions in the room. The speaker settings will be optimized to suit the area defined by those positions (multi measure).
No (default)	Select this option if your listening position will always be fixed. Take the measurements at only one position. The speaker settings will be optimized to suit that position (single measure).



- If you perform the multi measure, the speaker settings will be optimized for you to enjoy surround sound in a wider space.
- If you perform the multi measure, first place the YPAO microphone at the listening position you will be seated most frequently.

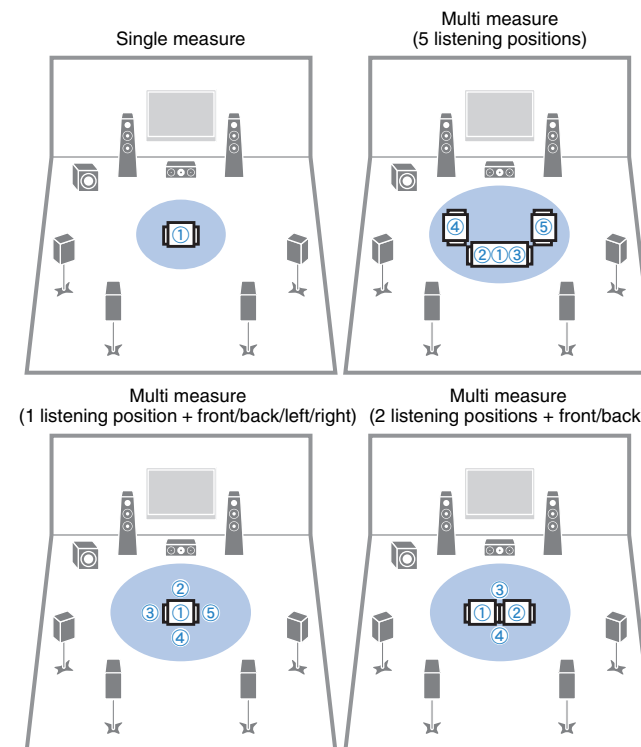

This completes the preparations. See the following page to start the measurement.

When “Multi Position” is set to “Yes”:

“Measuring at multiple listening positions (multi measure)” (p.43)

When “Multi Position” is set to “No”:

“Measuring at one listening position (single measure)” (p.42)

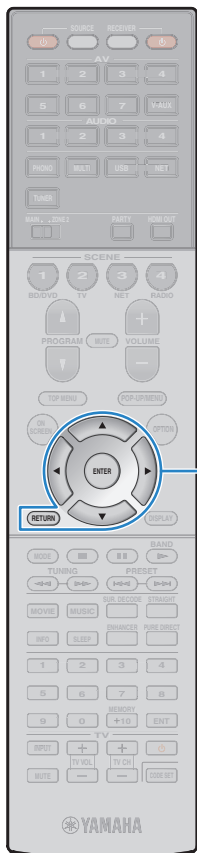

Cursor keys
ENTER
RETURN

Measuring at one listening position (single measure)

When "Multi Position" is set to "No", follow the procedure below for measurement.



- Do not stand between the speakers and the YPAO microphone during the measurement process (about 3 minutes).
- Move to the corner of the room or leave the room.

1 To start the measurement, use the cursor keys to select "Measure" and press ENTER.

The measurement will start in 10 seconds. Press ENTER again to start the measurement immediately.



- To cancel the measurement temporarily, press RETURN.

The following screen appears on the TV when the measurement finishes.



- If any error message (such as E-1) or warning message (such as W-1) appears, see "Error messages" (p.46) or "Warning messages" (p.47).



- To check the measurement results, select "Result". For details, see "Checking the measurement results" (p.44).

2 Use the cursor keys to select "Save/Cancel" and press ENTER.

3 To save the measurement results, use the cursor keys (</>) to select "SAVE" and press ENTER.

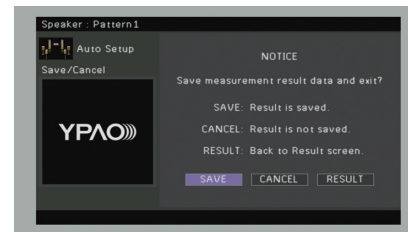

The adjusted speaker settings are applied.



- To finish the measurement without saving the result, select "CANCEL".

4 Disconnect the YPAO microphone from the unit.

This completes optimization of the speaker settings.

Caution

- The YPAO microphone is sensitive to heat, so should not be placed anywhere where it could be exposed to direct sunlight or high temperatures (such as on top of AV equipment).



Cursor keys
ENTER
RETURN

Measuring at multiple listening positions (multi measure)

When "Multi Position" is set to "Yes", follow the procedure below for measurement.



- Do not stand between the speakers and the YPAO microphone during the measurement process. It takes about 10 minutes to measure 8 listening positions.
- Move to the corner of the room or leave the room.
- If any error message (such as E-1) or warning message (such as W-1) appears, see "Error messages" (p.46) or "Warning messages" (p.47).

1 To start the measurement, use the cursor keys to select "Measure" and press ENTER.

The measurement will start in 10 seconds. Press ENTER again to start the measurement immediately.



- To cancel the measurement temporarily, press RETURN.

The following screen appears on the TV when the measurement at the first position finishes.

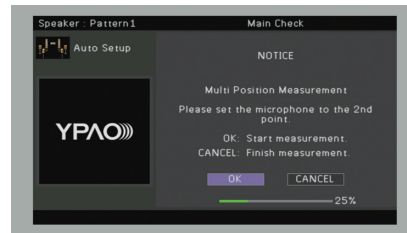

2 Move the YPAO microphone to the next listening position and press ENTER.

Repeat step 2 until measurements at all listening positions (up to 8) have been taken.

3 When the measurements at the positions you want to measure are completed, use the cursor keys to select "CANCEL" and press ENTER.

When you have taken measurements at 8 listening positions, the following screen appears automatically.



- To check the measurement results, select "Result". For details, see "Checking the measurement results" (p.44).

4 Use the cursor keys to select "Save/Cancel" and press ENTER.

5 To save the measurement result, use the cursor keys to select "SAVE" and press ENTER.



The adjusted speaker settings are applied.



- To finish the measurement without saving the result, select "CANCEL".

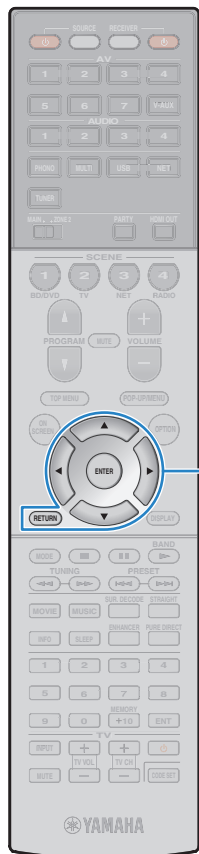

Cursor keys
ENTER
RETURN

6 Disconnect the YPAO microphone from the unit.

This completes optimization of the speaker settings.

Caution

- The YPAO microphone is sensitive to heat, so should not be placed anywhere where it could be exposed to direct sunlight or high temperatures (such as on top of AV equipment).

Checking the measurement results

You can check the YPAO measurement results.

1 After the measurement, use the cursor keys to select “Result” and press ENTER.



- You can also select “Result” from “Auto Setup” (p.98) in the “Setup” menu, which displays the previous measurement results.

The following screen appears.

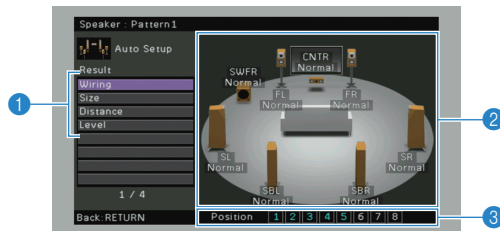

- Measurement result items
- Measurement result details
- The number of measured positions (when multi measure is performed)

2 Use the cursor keys to select an item.

Wiring	Polarity of each speaker Normal: The speaker cable is connected with the correct polarity (+/-). Reverse: The speaker cable may be connected with the reverse polarity (+/-).
	Size of each speaker (cross-over frequency of the subwoofer) Large: The speaker can reproduce low-frequency signals effectively. Small: The speaker cannot reproduce low-frequency signals effectively.
Distance	Distance from the listening position to each speaker
Level	Output level adjustment for each speaker



- A speaker with a problem is indicated with a message enclosed in a red box.

3 To finish checking the results and return to the previous screen, press RETURN.

Reloading the previous YPAO adjustments

When the speaker settings you have configured manually are not suitable, follow the procedure below to discard the manual settings and reload the previous YPAO adjustments.

- 1 In the “Setup” menu, select “Speaker”, “Auto Setup”, and then “Result” (p.97).
- 2 Use the cursor keys to select “Setup Reload” and press ENTER.

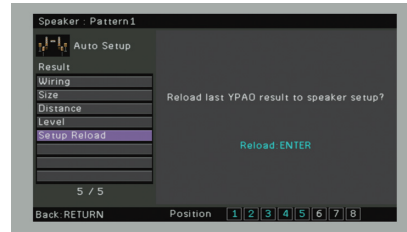
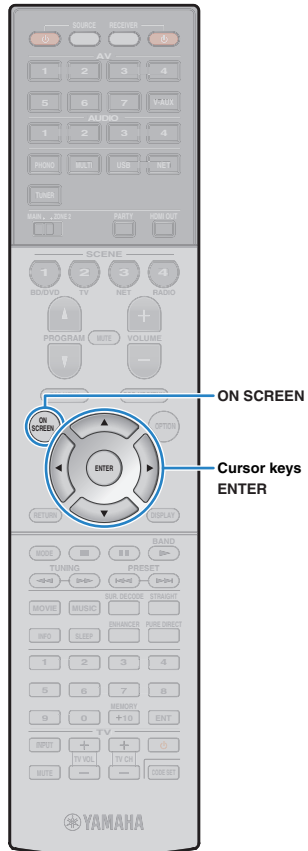

- 3 To exit from the menu, press ON SCREEN.

Error messages

If any error message is displayed during the measurement, resolve the problem and perform YPAO again.

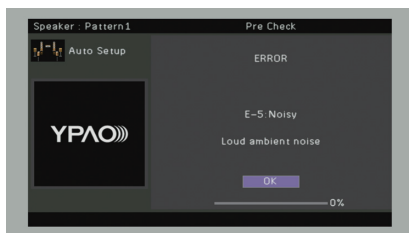

Error message	Cause	Remedy
E-1: No Front SP	Front speakers are not detected.	
E-2: No Sur. SP	One of the surround speakers cannot be detected.	Follow the on-screen instructions to exit YPAO, turn off the unit, and then check the speaker connections.
E-3: No F.PRNS SP	One of the front presence speakers cannot be detected.	
E-4: SBR → SBL	A surround back speaker is connected to the R side only.	When using only one surround back speaker, you need to connect it to the SINGLE jack (L side). Follow the on-screen instructions to exit YPAO, turn off the unit, and then reconnect the speaker.
E-5: Noisy	The noise is too loud.	Keep the room quiet and follow the on-screen instructions to start the measurement again. If you select "PROCEED", YPAO takes the measurement again and ignores any noise detected.
E-6: Check Sur.	Surround back speakers are connected, but no surround speakers are connected.	Surround speakers need to be connected in order to use surround back speakers. Follow the on-screen instructions to exit YPAO, turn off the unit, and then reconnect the speakers.
E-7: No MIC	The YPAO microphone has been removed.	Connect the YPAO microphone to the YPAO MIC jack firmly and follow the on-screen instructions to start the measurement again.
E-8: No Signal	The YPAO microphone cannot detect test tones.	Connect the YPAO microphone to the YPAO MIC jack firmly and follow the on-screen instructions to start the measurement again. If this error occurs repeatedly, contact the nearest authorized Yamaha dealer or service center.
E-9: User Cancel	The measurement has been canceled.	Follow the on-screen instructions to start the measurement again. To cancel the measurement, select "EXIT".
E-10: Internal Error	An internal error has occurred.	Follow the on-screen instructions to exit YPAO, turn off and on the unit. If this error occurs repeatedly, contact the nearest authorized Yamaha dealer or service center.

Warning messages

If a warning message is displayed after the measurement, you can still save the measurement results by following on-screen instructions. However, we recommend you perform YPAO again in order to use the unit with the optimal speaker settings.

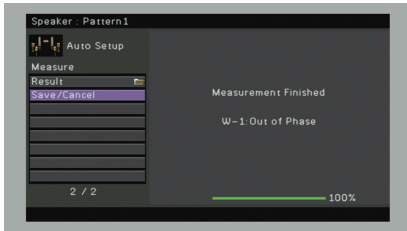

Warning message	Cause	Remedy
W-1: Out of Phase	A speaker cable may be connected with the reverse polarity (+/-).	Select "Wiring" in "Result" (p.44) and check the cable connections (+/-) of the speaker identified by "Reverse". If the speaker is connected incorrectly, turn off the unit and then reconnect the speaker cable. Depending on the type of speakers or room environment, this message may appear even if the speakers are connected correctly. In this case, you can ignore the message.
W-2: Over Distance	A speaker is placed more than 24 m (80 ft) from the listening position.	Select "Distance" in "Result" (p.44) and move the speaker identified by ">24.00m (>80.0ft)" within 24 m (80 ft) of the listening position.
W-3: Level Error	There are significant volume differences between the speakers.	Check the usage environment and cable connections (+/-) of each speaker, and the volume of the subwoofer. We recommend using the same speakers or speakers with specifications that are as similar as possible.

PLAYBACK

Basic playback procedure

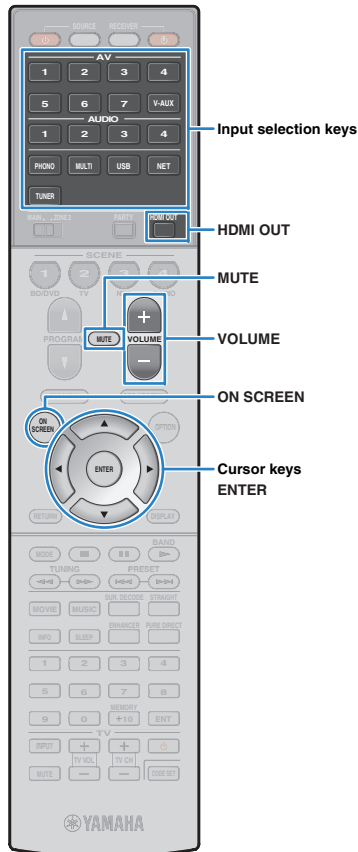

- 1 Turn on the external devices (such as a TV or BD/DVD player) connected to the unit.
- 2 Use the input selection keys to select an input source.
- 3 Start playback on the external device or select a radio station.

Refer to the instruction manual for the external device.

For details on the following operations, see the corresponding pages.

- Listening to FM/AM radio (p.57)
- Playing back iPod music (p.64)
- Playing back music stored on a USB storage device (p.68)
- Playing back music stored on media servers (PCs/NAS) (p.71)
- Listening to Internet radio (p.74)
- Playing back iTunes/iPod music via a network (AirPlay) (p.76)

- 4 Press **VOLUME** to adjust the volume.



- To mute the audio output, press MUTE. Press MUTE again to unmute.
- To adjust the treble/bass settings, use the "Option" menu or TONE/BALANCE on the front panel (p.85).

On-screen input selection

- ① Press ON SCREEN.
- ② Use the cursor keys to select "Input" and press ENTER.
- ③ Use the cursor keys to select the desired input source and press ENTER.

Selecting an HDMI output jack

- 1 Press **HDMI OUT** to select an HDMI OUT jack.

Each time you press the key, the HDMI OUT jack to be used for signal output changes.



OUT 1+2	Outputs the same signal at both the HDMI OUT 1 and HDMI OUT 2 jacks.
OUT 1	Output the signals at the selected HDMI OUT jack.
OUT 2	Output the signals at the selected HDMI OUT jack.
Off	Does not output the signals at the HDMI OUT jacks.



- You can also select an HDMI output jack by selecting a scene (p.49).
- When "OUT 1+2" is selected, the unit outputs video signals at the highest resolution supported by both TVs (or projectors) connected to the unit. (For example, if you have connected a 1080p TV to the HDMI OUT 1 jack and a 720p TV to the HDMI OUT 2 jack, the unit outputs 720p video signals.)

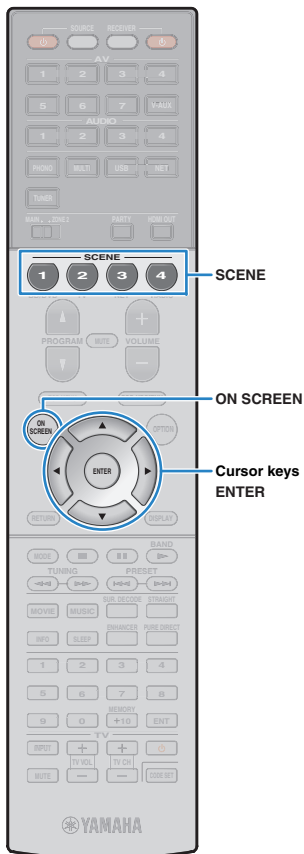

Selecting the input source and favorite settings with one touch (SCENE)

The SCENE function allows you to select the assigned input source, sound program, HDMI output and various settings with just one touch. You can use up to 12 scenes to register your favorite settings and switch them depending on a playback source.

1 Press SCENE.

The input source and settings registered to the corresponding scene are selected. The unit turns on automatically when it is in standby mode.

By default, the following settings are registered for each scene.

SCENE (SCENE key)		1 (BD/DVD)	2 (TV)	3 (NET)	4 (RADIO)
Input	Input (p.48)	AV 1	AUDIO 1	NET RADIO	TUNER
	Audio Select (p.87)	Auto	Auto	—	—
HDMI Output	HDMI Output (p.48)	OUT 1+2	OUT 1+2	OUT 1+2	OUT 1+2
	Sound Program (p.51)	Sci-Fi	STRAIGHT	7ch Stereo	7ch Stereo
Mode	Pure Direct Mode (p.104)	Auto	Auto	Auto	Auto
	Enhancer (p.56)	Off	On	On	On



- You can select SCENE 1–4 by pressing SCENE on the remote control. Additionally, you can create 8 scenes (SCENE 5–12) and select those scenes from the “Scene” menu (p.91).



On-screen scene selection

- Press ON SCREEN.
- Use the cursor keys to select “Scene” and press ENTER.
- Use the cursor keys to select a desired scene and press ENTER.

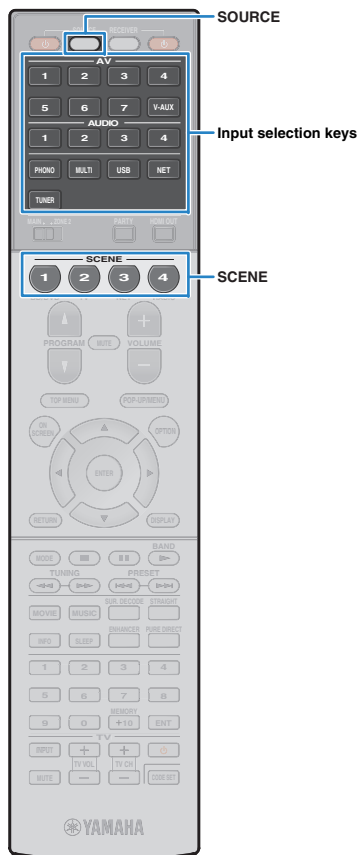

Configuring scene assignments

- 1 Set the unit to the condition (such as input source and sound program) that you want to assign to a scene.
 - 2 Hold down the desired SCENE key until “SET Complete” appears on the front display.
- 
- 3 If you want to control the corresponding playback device after selecting the scene, hold down the corresponding SCENE key and input selection key together for more than 3 seconds.

Once the setting is completed successfully, SOURCE blinks twice.



- If you have not registered the remote control code of the playback device yet, see “Registering the remote control codes for playback devices” (p.120) to register it.
- The SCENE link playback function allows you to start playback of an external device connected to the unit via HDMI or of a Yamaha product connected to the REMOTE OUT jack. To enable SCENE link playback, specify the device type in “Device Control” (p.92) in the “Scene” menu.

Selecting setting items to be included as scene assignments

In addition to the default scene assignments (Input, HDMI Output and Mode), you can also include the following setting items as the scene assignments in “Detail” (p.93) in the “Scene” menu.

Sound	Tone Control, Adaptive DRC
Surround	CINEMA DSP 3D Mode, Dialogue Lift, Dialogue Level, Subwoofer Trim, Extended Surround
Video	Video Mode
Volume	Master Volume
Lipsync	Lipsync, Delay
Speaker Setup	Setting Pattern, PEQ Select

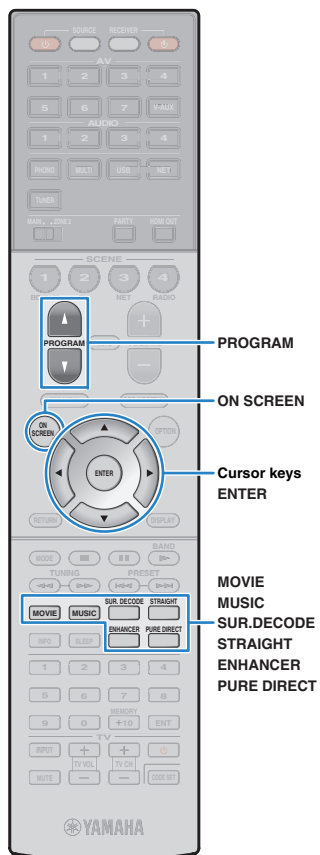

Selecting the sound mode

The unit is equipped with a variety of sound programs and surround decoders that allow you to enjoy playback sources with your favorite sound mode (such as sound field effect or stereo playback).

Selecting a sound program suitable for movies (p.52)

Press MOVIE repeatedly.

Selecting a sound program suitable for music or stereo playback (p.53)

Press MUSIC repeatedly.

Selecting a surround decoder (p.55)

Press SUR.DECODE repeatedly.

Switching to the straight decode mode (p.54)

Press STRAIGHT.

Switching to the Pure Direct mode (p.55)

Press PURE DIRECT.

Enable Compressed Music Enhancer (p.56)

Press ENHANCER.

On-screen sound program/surround decoder selection

- ① Press ON SCREEN.
- ② Use the cursor keys to select "Sound Program" and press ENTER.
- ③ Use the cursor keys to select a sound program/surround decoder and press ENTER.



- You can also switch the sound programs and surround decoder by pressing PROGRAM.
- You can change the settings of the surround programs and surround decoders in the "Sound Program" menu (p.94).
- The sound mode can be applied separately to each input source.
- When you play back audio signals with a sampling rate of higher than 96 kHz, the straight decode mode (p.54) is automatically selected.
- You can check which speakers are currently outputting sound by looking at the speaker indicators on the unit's front panel (p.10) or at the "Audio Signal" screen in the "Information" menu (p.114).

Enjoying sound field effects (CINEMA DSP)

CINEMA DSP

The unit is equipped with a variety of sound programs that utilize Yamaha's original DSP technology (CINEMA DSP). It allows you to easily create sound fields like actual movie theaters or concert halls in your room.

Sound program category



"CINEMA DSP" lights up Sound program

■ Sound programs suitable for movies (MOVIE)

The following sound programs are optimized for viewing video sources, such as movies, TV programs, and games.

□ MOVIE THEATER

Standard	This program creates a sound field that emphasizes the surround feeling without disturbing the original acoustic positioning of multichannel audio, such as Dolby Digital and DTS. Its design is based on the concept of the ideal movie theater, in which the audience is surrounded by beautiful reverberations from the left, right, and rear.
Spectacle	This program delivers the scale and grandeur of spectacular movie productions. It delivers an expansive sound space to match the cinemascope wide-screen, and boasts a broad dynamic range, providing everything from small delicate sounds to powerful loud booms.
Sci-Fi	This program clearly reproduces the finely elaborated sound design of the latest Sci-Fi and SFX movies. You can enjoy a variety of cinematographically created virtual spaces reproduced with clear separation between dialogue, sound effects, and background music.
Adventure	This program is ideal for reproducing the sound design of action and adventure movies precisely. The sound field restrains reverberations, but puts emphasis on reproducing a sensation of expansiveness on both sides, powerful space expanded widely to the left and right. The restrained depth creates a clear and powerful space, while also maintaining the articulation of the sounds and the separation of the channels.

Drama	This program features stable reverberations that match a wide range of movie genres, from serious dramas to musicals and comedies. The reverberations are modest, but suitably stereophonic. The sound effects and background music are reproduced with a gentle echo that does not impinge on the articulation of the dialogue. You'll never get tired listening for long periods.
Mono Movie	This program reproduces monaural video sources, such as classic movies, in an atmosphere of a good old movie theater. The program creates a pleasant space with depth, by adding breadth and the appropriate reverberation to the original audio.

□ ENTERTAINMENT

Sports	This program allows listeners to enjoy the rich vividness of sport broadcasts and light entertainment programs. In sports broadcasts, the commentators' voices are positioned clearly at the center, while the atmosphere inside the stadium is realistically conveyed by the peripheral delivery of the sounds of the fans in a suitable space.
Action Game	This program is suitable for action games, such as car racing and fighting games. The reality of, and emphasis on, various effects makes the player feel like they are right in the middle of the action, allowing for greater concentration. Use this program in combination with Compressed Music Enhancer for a more dynamic and strong sound field.
Roleplaying Game	This program is suitable for role-playing and adventure games. This program adds depth to the sound field for natural and realistic reproduction of background music, special effects, and dialogue from a wide variety of scenes. Use this program in combination with Compressed Music Enhancer for a clearer and more spatial sound field.
Music Video	This program allows you to enjoy videos of pop, rock, and jazz concerts, as if you were there yourself. Immerse yourself in the hot concert atmosphere thanks to the vividness of the singers and solos on stage, a presence sound field that emphasizes the beat of rhythm instruments, and a surround sound field that reproduces the space of a big live hall.

■ Sound programs suitable for music/stereo playback (MUSIC)

The following sound programs are optimized for listening to music sources.

You can also select stereo playback.

□ CLASSICAL

Hall in Munich	This program simulates a Munich concert hall with approximately 2,500 seats that uses stylish wood for the interior finishing. Fine, beautiful reverberations spread richly, creating a calming atmosphere. The listener's virtual seat is at the center left of the arena.
Hall in Vienna	This program simulates a 1,700-seat, middle-sized concert hall with a shoebox shape that is traditional in Vienna. Pillars and ornate carvings create extremely complex reverberations from all around the audience, producing a very full, rich sound.
Chamber	This program creates a relatively wide space with a high ceiling, like an audience hall in a palace. It offers pleasant reverberations that are suitable for courtly music and chamber music.

□ LIVE/CLUB

Cellar Club	This program simulates an intimate concert venue with a low ceiling and homey atmosphere. A realistic, live sound field delivers powerful sounds that make you feel as if you are sitting in the front row in front of a small stage.
The Roxy Theatre	This program creates the sound field of a 460-seat rock music concert venue in Los Angeles. The listener's virtual seat is at the center left of the hall.
The Bottom Line	This program creates the sound field at stage front in The Bottom Line, a famous New York jazz club once. The floor can seat 300 people to the left and right in a sound field offering real and vibrant sound.

□ STEREO

2ch Stereo	Use this program to mix down multichannel sources to 2 channels. When multichannel signals are input, they are down mixed to 2 channels and output from the front speakers (this program does not utilize CINEMA DSP).
7ch Stereo	Use this program to output sound from all speakers. When you play back multichannel sources, the unit mixes down the source to 2 channels, and then outputs the sound from all speakers. This program creates a larger sound field and is ideal for background music at parties.



■ Enjoying stereoscopic sound fields (CINEMA DSP 3D)



CINEMA DSP 3D creates a natural stereoscopic sound field in your room.

CINEMA DSP 3D functions when both of the following conditions are met.

- One of the sound programs (except 2ch Stereo and 7ch Stereo) is selected (p.52).
- “CINEMA DSP 3D Mode” (p.85) in the “Option” menu is set to “On”.



“CINEMA DSP 3D” lights up



- We recommend using front presence speakers in order to experience the full effect of the stereoscopic sound fields. However, even when no front presence speakers are connected, the unit creates Virtual Presence Speaker (VPS) using the front, center, and surround speakers to produce stereoscopic sound fields.

■ Enjoying sound field effects without surround speakers (Virtual CINEMA DSP)

If you select one of the sound programs (except 2ch Stereo and 7ch Stereo) when no surround speakers are connected, the unit creates the surround sound field using the front-side speakers.

Enjoying unprocessed playback

You can play back input sources without any sound field effect processing.

■ Playing back in original channels (straight decode)

When the straight decode mode is enabled, the unit produces stereo sound from the front speakers for 2-channel sources such as CDs, and produces unprocessed multichannel sounds for multichannel sources.

1 Press STRAIGHT.

Each time you press the key, the straight decode mode is enabled or disabled.



- To enable 6.1/7.1-channel playback from 5.1-channel sources when surround back speakers are used, set “Extended Surround” (p.86) in the “Option” menu to a setting other than “Off”.



■ Playing back 2-channel sources in multichannel (surround decoder)

The surround decoder enables unprocessed multichannel playback from 2-channel sources. When a multichannel source is input, it works the same way as the straight decode mode.

For details on each decoder see “Glossary” (p.133).

1 Press SUR.DECODE to select a surround decoder.

Each time you press the key, the surround decoder changes.



Pro Logic	Uses the Dolby Pro Logic decoder suitable for all sources.
PLIIX Movie	Use the Dolby Pro Logic IIX decoder (or Dolby Pro Logic II decoder) suitable for movies.
PLIIX Music	Use the Dolby Pro Logic IIX decoder (or Dolby Pro Logic II decoder) suitable for music.
PLIIX Game	Use the Dolby Pro Logic IIX decoder (or Dolby Pro Logic II decoder) suitable for games.
Neo:6 Cinema	Uses the DTS Neo:6 decoder suitable for movies.
Neo:6 Music	Uses the DTS Neo:6 decoder suitable for music.



- You cannot select the Dolby Pro Logic IIX decoders when headphones are connected or when “Surround Back” (p.101) in the “Setup” menu is set to “None”.

Enjoying pure high fidelity sound (Pure Direct)

When the Pure Direct mode is enabled, the unit plays back the selected source with the least circuitry in order to reduce the electrical noise from other circuitry (such as the front display). It allows you to enjoy Hi-Fi sound quality.

1 Press PURE DIRECT.

Each time you press the key, the Pure Direct mode is enabled or disabled.



- When the Pure Direct mode is enabled, the following functions are not available.
 - Some settings for the speakers or sound programs
 - Operating the on-screen menu
 - Using the multi-zone function
 - Output from the AV OUT jacks
 - Viewing information on the front display (when not in operation)



Enjoying compressed music with enhanced sound (Compressed Music Enhancer)

compressed music ENHANCER

Compressed Music Enhancer adds depth and breadth to the sound, allowing you to enjoy a dynamic sound close to the original sound before it was compressed. This function can be used along with any other sound modes.

1 Press ENHANCER.

Each time you press the key, Compressed Music Enhancer is enabled or disabled.



“ENHANCER” lights up



- Compressed Music Enhancer does not work on signals whose sampling rate is over 48 kHz.



- You can also use “Enhancer” (p.87) in the “Option” menu to enable/disable Compressed Music Enhancer.

Enjoying surround sound with headphones (SILENT CINEMA)



You can enjoy surround or sound field effects, like a multichannel speaker system, with stereo headphones by connecting the headphones to the PHONES jack and selecting a sound program or a surround decoder.

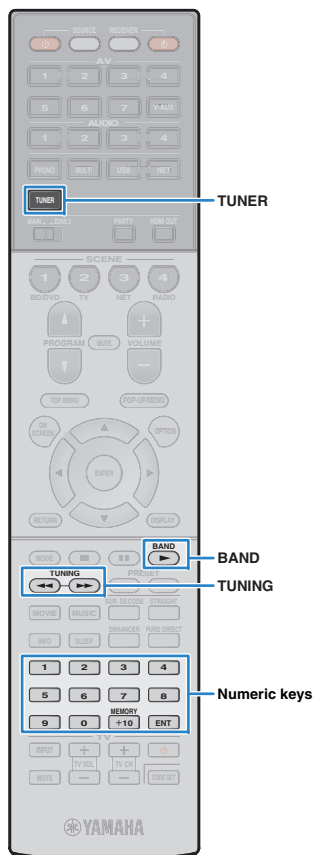

Listening to FM/AM radio

You can tune into a radio station by specifying its frequency or selecting from registered radio stations.



- The radio frequencies differ depending on the country or region where the unit is being used. The explanation of this section uses a display with frequencies used in U.K. and Europe models.
- If you cannot obtain good reception on the radio, adjust the direction of the FM/AM antennas.

Setting the frequency steps

(Asia and General models only)

At the factory, the frequency step setting is set to 50 kHz for FM and 9 kHz for AM. Depending on your country or region, set the frequency steps to 100 kHz for FM and 10 kHz for AM.

- 1 Set the unit to standby mode.
- 2 When holding down **STRAIGHT** on the front panel, press **MAIN ZONE** .

MAIN ZONE  STRAIGHT

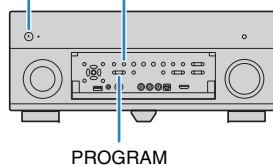

- 3 Press **PROGRAM** repeatedly to select “TUNER FRQ STEP”.



- 4 Press **STRAIGHT** to select “FM100/AM10”.
- 5 Press **MAIN ZONE**  to set the unit to standby mode and turn it on again.

Selecting a frequency for reception

- 1 Press **TUNER** to select “TUNER” as the input source.
- 2 Press **BAND** to select a band (FM or AM).



- 3 Use the following keys to set a frequency.

TUNING: Increase/decrease the frequency. Hold down the key for about a second to search stations automatically.

Numeric keys: Enter a frequency directly. For example, to select 98.50 MHz, press “9”, “8”, “5” and “0” (or ENT).



“TUNED” lights up when a signal is received from a radio station.

“STEREO” also lights up when a stereo signal is received.



- “Wrong Station!” appears when you enter a frequency that is out of reception range.



- (U.S.A. model only)
You can switch between “Auto” (stereo) and “Mono” (monaural) for FM radio reception in “Audio Mode” (p.87) in the “Option” menu. When the signal reception for an FM radio station is unstable, switching to monaural may improve it. (HD Radio stations are not available when the unit is in the monaural reception mode.)
- (Except for U.S.A. model)
You can switch between “Stereo” (stereo) and “Mono” (monaural) for FM radio reception in “FM Mode” (p.88) in the “Option” menu. When the signal reception for an FM radio station is unstable, switching to monaural may improve it.

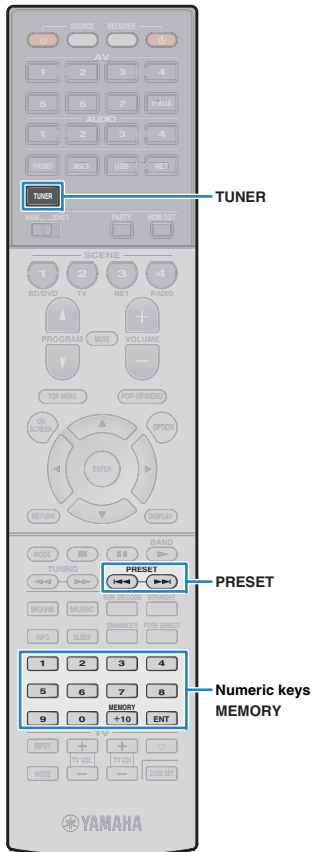

Registering favorite radio stations (presets)

You can register up to 40 radio stations as presets. Once you have registered stations, you can easily tune into them by selecting their preset numbers.



- You can automatically register FM radio stations that have strong signals and HD Radio stations (U.S.A. model only) by using “Auto Preset” (p.61, p.63).

Registering a radio station

Select a radio station manually and register it to a preset number.

1 Follow “Selecting a frequency for reception” (p.57) to tune into the desired radio station.



- (U.S.A. model only)
To register a specific HD Radio program, select an audio program (p.59) after tuning into the radio station.

2 Hold down MEMORY for more than 2 seconds.

The first time that you do register a station, the selected radio station will be registered to the preset number “01”. Thereafter, each radio station you select will be registered to the next empty (unused) preset number after the most recently registered number.

Preset number



- To select a preset number for registering, press MEMORY once after tuning into the desired radio station, use PRESET or numeric keys to select a preset number, and then press MEMORY again.

“Empty” (not in use) or the frequency currently registered



Selecting a preset station

Tune into a registered radio station by selecting its preset number.

1 Press TUNER to select “TUNER” as the input source.

2 Press PRESET repeatedly to select the desired radio station.

You can also enter a preset number (01 to 40) directly by using the numeric keys after pressing PRESET once.



- “No Presets” appears when no radio stations are registered.
- “Wrong Num.” appears when an invalid number is entered.
- “Empty” appears when a preset number not in use is entered.



- To clear preset stations, use “Clear Preset” or “Clear All Preset” (p.61, p.63).

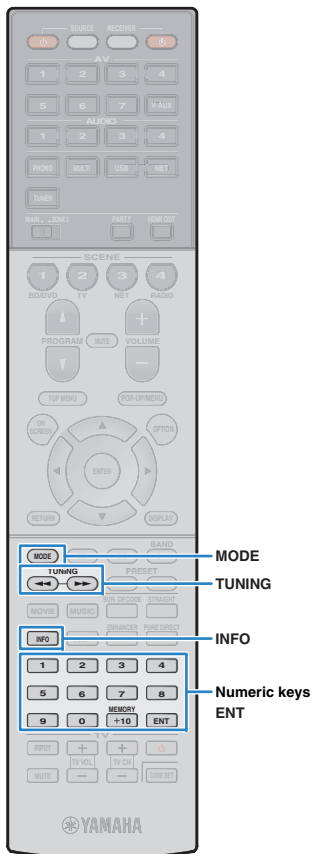

HD Radio™ tuning

(U.S.A. model only)

HD Radio Technology is a new technology that enables FM/AM radio stations to broadcast programs digitally. Digital broadcasting provides listeners with radically improved audio quality and reception as well as new data services. Furthermore, supplemental program services allow listeners to select from up to 8 HD Radio programs multicast on a single FM HD Radio channel. For further information on HD Radio Technology, visit “<http://www.ibiquity.com/>”.

The unit is equipped with an HD Radio reception feature, facilitating CD quality FM broadcasts as well as analog FM stereo quality AM broadcasts. In addition, the unit can receive both audio and data (such as song titles, artist names, album titles and program types) from all HD Radio programs (HD1 to HD8).

PSD ● Program Service Data: Contributes to the superior user experience of HD RadioTechnology. Presents song name, artist, station IDs, HD2/HD3 Channel Guide, and other relevant data streams.

HD2/HD3 ● Adjacent to traditional main stations are extra local FM channels. These HD2/HD3 Channels provide new, original music as well as deep cuts into traditional genre.

Digital Sound ● Digital, CD-quality sound. HD Radio Technology enables local radio stations to broadcast a clean digital signal. AM sounds like today’s FM and FM sounds like a CD.

When tuning into an HD Radio station

Relative/total program number
(when multiple programs are available)



“HD” lights up

Absolute program number
(when multiple programs are available)



- The unit is capable of receiving both hybrid and all-digital FM/AM radio stations. If you cannot search the desired all-digital HD Radio station by holding down TUNING, enter the frequency directly using the numeric keys.
- When the unit is in the monaural reception mode (p.87), you can tune into the analog part of a hybrid HD Radio station only.

Selecting an HD Radio™ audio program

You can select an audio program when the unit is tuned into an HD Radio station that provides multiple audio programs (up to 8).

1 Press MODE repeatedly to select a desired audio program.

You can also enter an audio program number (1 to 8) directly by using the numeric keys. For example, to select program 3, press 3 and then ENT (or just leave it).



Displaying the HD Radio™ information

You can switch the HD Radio information displayed on the front display.

1 Press INFO.

Each time you press the key, the item switches.



Item name

About 3 seconds later, the information is displayed.



Station Info	Frequency, station name (call sign)
Category	Station name (call sign), program category
Artist/Song	Station name (call sign), artist name/song title
Album	Station name (call sign), album title
DSP Program	Frequency, sound program selected on the unit
Audio Decoder	Frequency, decoder selected on the unit



- Some audio programs may not provide information depending on the station or period of time.

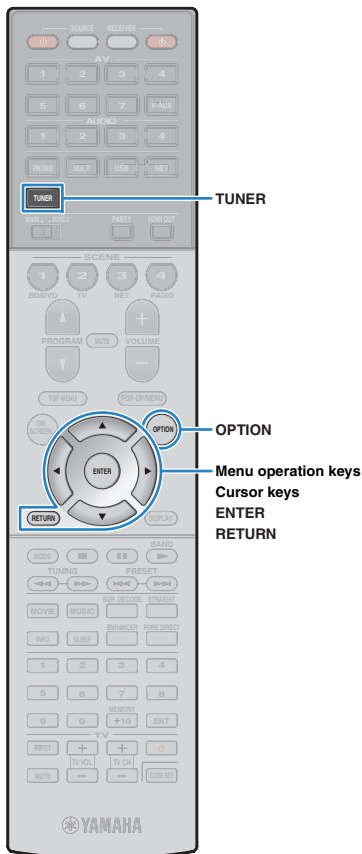

■ Holding HD Radio™ information display

You can hold the HD Radio information currently displayed on the TV (playback screen) and front display by using the hold function.

1 When the desired HD Radio information is displayed, press **OPTION**.

2 Use the cursor keys to select “Hold/Unhold” (Hold/Unhold) and press **ENTER**.

The current information will remain displayed until “Hold/Unhold” is selected again.



- Texts in parentheses denote indications on the front display.
- The hold function is automatically disabled if the unit is set to standby mode or if another input source or another radio station is selected.

3 To exit from the menu, press **OPTION**.

■ Operating HD Radio™ on the TV

You can view the HD Radio information or select a radio station on the TV.

1 Press **TUNER** to select “TUNER” as the input source.

The playback screen is displayed on the TV.

□ Playback screen



1 **HOLD** indicator

Flashes when the hold function (p.60) is enabled.

2 **Radio station information**

Displays the information of the selected radio station such as the selected band (FM/AM) and frequency.

When tuning into an HD Radio station, the selected audio program number and HD Radio information (station name [call sign], program category, artist name, album name and song title) are also displayed. Use the cursor keys to select HD Radio information to be scrolled.

3 **HD indicator**

Lights up when an HD Radio station signal is received.

4 **TUNED/STEREO indicators**

“TUNED” lights up when a signal is received from a radio station. “STEREO” lights up when a stereo signal is received.

5 **Operation menu**

Use the cursor keys to select an item and press **ENTER** to confirm the selection.

To close the submenu, press **RETURN**.

Menu	Submenu	Function
	FM	Switches to FM/AM.
	AM	
	Tuning (+/-)	Selects a frequency.
	Auto (+/-)	Selects a radio station automatically.
Manual Tuning	Program (+/-)	Selects an audio program (when multiple audio programs are available).
	Memory	Registers the selected station as presets.
	Direct	Enters a frequency directly.
Browse		Moves to the browse screen (preset station list).
Screen Off		Closes the screen display and shows the background. Press one of the menu operation keys to redisplay it.



Browse screen

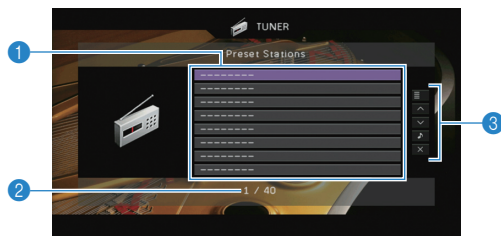

1 Preset station list

Displays the list of preset stations. Use the cursor keys to select a preset station and press ENTER to tune into it.

2 Preset number

3 Operation menu

Use the cursor keys to select an item and press ENTER to confirm the selection.

To close the submenu, press RETURN.

Menu	Submenu	Function
	Memory	Registers the current station to the preset number selected in the list.
Utility	Auto Preset	Automatically registers HD Radio (FM/AM) stations and FM radio stations with strong signals (up to 40 stations).
	Clear Preset	Clear the preset station selected in the list.
	Clear All Preset	Clear all the preset stations.

1 Page Up	Moves to the previous/next page of the list.
1 Page Down	
Now Playing	Moves to the playback screen.
Screen Off	Closes the screen display and shows the background. Press one of the menu operation keys to redisplay it.



- If HD Radio stations are detected by "Auto Preset", only the audio program 1 (HD1) will be registered. If you want to register a specific HD Radio program, register it manually (p.58).

Radio Data System tuning

(U.K. and Europe models only)

Radio Data System is a data transmission system used by FM stations in many countries. The unit can receive various types of Radio Data System data, such as "Program Service", "Program Type," "Radio Text" and "Clock Time", when it is tuned into a Radio Data System broadcasting station.

Displaying the Radio Data System information

1 Tune into the desired Radio Data System broadcasting station.



- We recommend using "Auto Preset" to tune into the Radio Data System broadcasting stations (p.63).

2 Press INFO.

Each time you press the key, the displayed item changes.



Item name

About 3 seconds later, the corresponding information for the displayed item appears.



Information

Program Service	Program service name
Program Type	Current program type
Radio Text	Information on the current program
Clock Time	Current time
DSP Program	Sound mode name
Audio Decoder	Decoder name

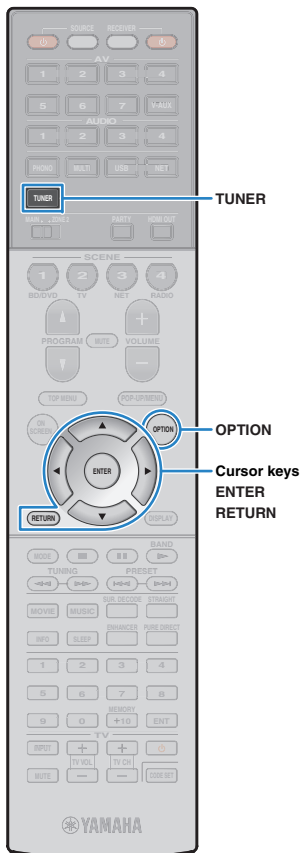

- “Program Service”, “Program Type”, “Radio Text”, and “Clock Time” are not displayed if the radio station does not provide the Radio Data System service.

■ Receiving traffic information automatically

When “TUNER” is selected as the input source, the unit automatically receives traffic information. To enable this function, follow the procedure below to set the traffic information station.

- 1 When “TUNER” is selected as the input source, press **OPTION**.
- 2 Use the cursor keys to select “Traffic Program” (TrafficProgram) and press **ENTER**.

The traffic information station search will start in 5 seconds. Press **ENTER** again to start the search immediately.



- To search upward/downward from the current frequency, press the cursor keys (△/▽) while “READY” is displayed.
- To cancel the search, press **RETURN**.
- Texts in parentheses denote indicators on the front display.

The following screen appears for about 3 seconds when the search finishes.



Traffic information station (frequency)



- “TP Not Found” appears for about 3 seconds when no traffic information stations are found.

Operating the radio on the TV

You can view the radio information or select a radio station on the TV.

- (U.S.A. model only)
See “Operating HD Radio™ on the TV” (p.60) to operate the radio on the TV.

- 1 Press **TUNER** to select “TUNER” as the input source.

The playback screen is displayed on the TV.

■ Playback screen

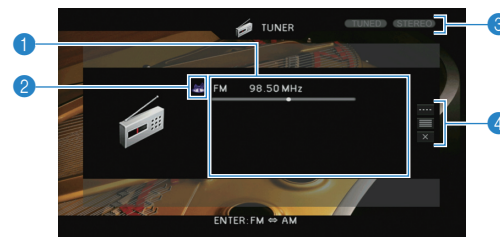

- 1 **Radio station information**

Displays the information of the selected radio station such as the selected band (FM/AM) and frequency.

(U.K. and Europe models only)

When tuning into a Radio Data System broadcasting station (p.61), the Radio Data System information (“Program Service”, “Program Type”, “Radio Text” and “Clock Time”) is also displayed.

- 2 **Band icon**

(Except for U.K. and Europe models)

Select this icon and press **ENTER** to switch between FM and AM.

- 3 **TUNED/STEREO indicators**

“TUNED” lights up when a signal is received from a radio station. “STEREO” lights up when a stereo signal is received.

- 4 **Operation menu**

Use the cursor keys to select an item and press **ENTER** to confirm the selection.

To close the submenu, press **RETURN**.

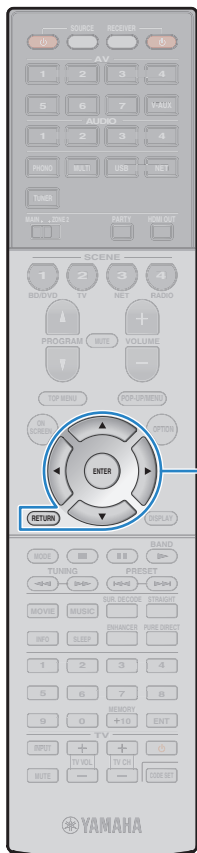

Menu operation keys
Cursor keys
ENTER
RETURN

Menu	Submenu	Function
Manual Tuning	FM	(U.K. and Europe models only)
	AM	Switches to FM/AM.
	Tuning (+/-)	Selects a frequency.
	Auto (+/-)	Selects a radio station automatically.
	Memory	Registers the selected station as presets.
	Direct	Enters a frequency directly.
Browse		Moves to the browse screen (preset station list).
Screen Off		Closes the screen display and shows the background. Press one of the menu operation keys to redisplay it.

Browse screen

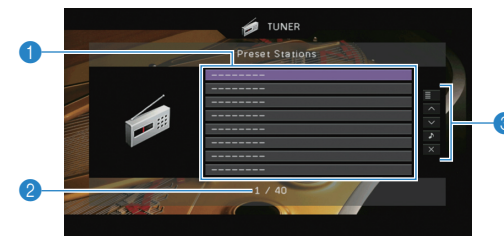

1 Preset station list

Displays the list of preset stations. Use the cursor keys to select a preset station and press ENTER to tune into it.

2 Preset number

3 Operation menu

Use the cursor keys to select an item and press ENTER to confirm the selection.

To close the submenu, press RETURN.

Menu	Submenu	Function
Utility	Memory	Registers the current station to the preset number selected in the list.
	Auto Preset	Automatically registers FM radio stations with strong signals (up to 40 stations).
	Clear Preset	Clear the preset station selected in the list.
	Clear All Preset	Clear all the preset stations.
1 Page Up		Moves to the previous/next page of the list.
1 Page Down		Moves to the previous/next page of the list.
Now Playing		Moves to the playback screen.
Screen Off		Closes the screen display and shows the background. Press one of the menu operation keys to redisplay it.



- (U.K. and Europe models only)
Only Radio Data System broadcasting stations are stored automatically by "Auto Preset".

Playing back iPod music

You can play back iPod music on the unit using a USB cable supplied with the iPod.



- An iPod may not be detected by the unit or some features may not be compatible, depending on the model or software version of the iPod.
- To play back iPod videos on the unit, an Apple Composite AV Cable (not supplied) is required. Connect the USB and composite video plugs of the Apple Composite AV cable to the USB jack and VIDEO AUX (VIDEO) jack on the front panel. To select a video, operate the iPod itself in the simple play mode (p.66).

Supported iPods (as of April 2012)

- iPod touch, iPod nano (2nd gen. to 6th gen.)
- iPhone 4S, iPhone 4, iPhone 3GS, iPhone 3G, iPhone
- iPad2, iPad

Connecting an iPod

Connect your iPod to the unit with the USB cable supplied with the iPod.

1 Connect the USB cable to the iPod.

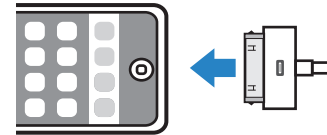

2 Connect the USB cable to the USB jack.

The unit (front)

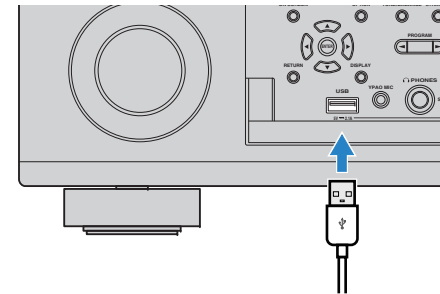

- The iPod charges while it is connected to the unit. If you set the unit to standby mode while the iPod is charging, the iPod continues to charge up to 4 hours. If "Network Standby" (p.108) in the "Setup" menu is set to "On", it continues to charge without limit.



- Disconnect the iPod from the USB jack when it is not in use.

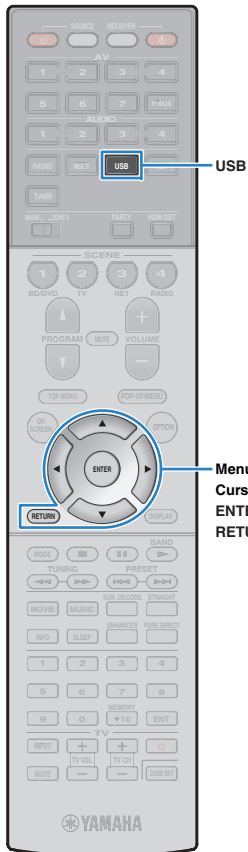

Playback of iPod content

Follow the procedure below to operate the iPod contents and start playback.

You can control the iPod with the menu displayed on the TV screen.

1 Press USB to select “USB” as the input source.

The browse screen is displayed on the TV.

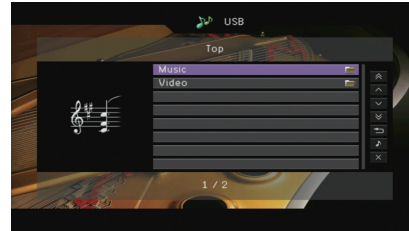

- If playback is ongoing on your iPod, the playback screen is displayed.

2 Use the cursor keys to select an item and press ENTER.

If a song is selected, playback starts and the playback screen is displayed.

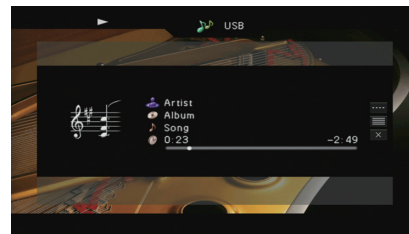

- To return to the previous screen, press RETURN.
- To operate the iPod manually to select content or control playback, switch to the simple play mode (p.66).

Browse screen

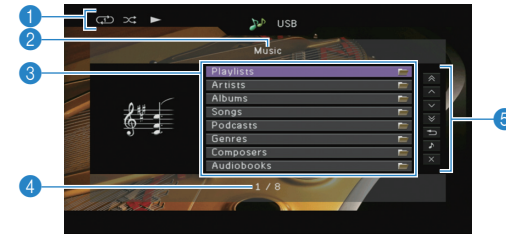

1 Status indicators

Display the current repeat/shuffle settings (p.67) and playback status (such as play/pause).

2 List name

3 Contents list

Displays the list of iPod content. Use the cursor keys to select an item and press ENTER to confirm the selection.

4 Item number/total

5 Operation menu

Use the cursor keys to select an item and press ENTER to confirm the selection.

Menu	Function
1 Page Up	Moves to the previous/next page of the list.
1 Page Down	
10 Pages Up	Moves 10 pages forward/backward.
10 Pages Down	
Return	Returns to the higher-level list.
Now Playing	Moves to the playback screen.
Screen Off	Closes the screen display and shows the background. Press one of the menu operation keys to redisplay it.



■ Playback screen

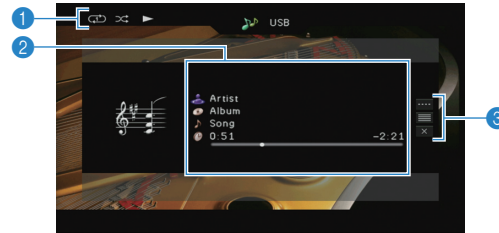

1 Status indicators

Display the current repeat/shuffle settings (p.67) and playback status (such as play/pause).

2 Playback information

Displays the artist name, album name, song title, and elapsed/remaining time.

Use the cursor keys to select scrollable information.

3 Operation menu

Use the cursor keys to select an item and press ENTER to confirm the selection.

To close the submenu, press RETURN.

Menu	Submenu	Function
	▶	Resumes playback from pause.
	■	Stops playback.
	⏸	Stops playback temporarily.
Play Control	⏮	Skips forward/backward.
	⏭	Skips forward/backward.
	⏪	Searches forward/backward (by holding down).
	⏩	Searches forward/backward (by holding down).
Browse		Moves to the browse screen.
Screen Off		Closes the screen display and shows the background. Press one of the menu operation keys to redisplay it.



- You can also use the external device operation keys on the remote control to control playback.

■ Operating the iPod itself or remote control (simple play)

1 Press MODE to switch to the simple play mode.

The TV menu screen turns off and iPod operations are enabled.

To display the TV menu screen, press MODE again.

2 Operate your iPod itself or the remote control to start playback.

Operational remote control keys	Function	
Cursor keys	Select an item.	
ENTER	Confirms the selection.	
RETURN	Returns to the previous screen.	
	▶	Starts playback or stops playback temporarily.
	⏸	Stops playback.
External device operation keys	⏮	Skips forward/backward.
	⏭	Skips forward/backward.
	⏪	Searches forward/backward (by holding down).
	⏩	Searches forward/backward (by holding down).

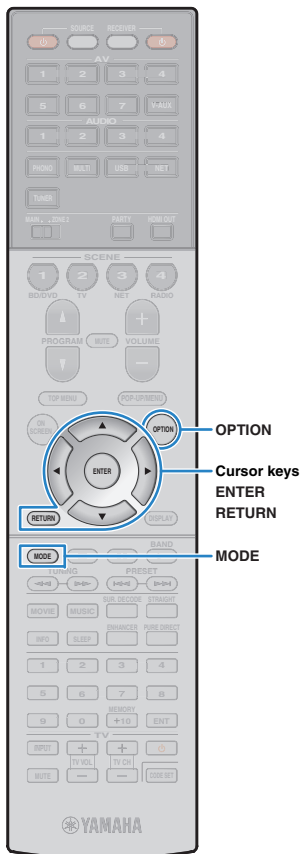

Repeat/shuffle settings

You can configure the repeat/shuffle settings of your iPod.



- During simple play, configure the repeat/shuffle settings directly on your iPod or press MODE to display the TV menu screen and then follow the procedure below.

1 When “USB” is selected as the input source, press **OPTION**.

2 Use the cursor keys to select “Shuffle” (Shuffle) or “Repeat” (Repeat) and press **ENTER**.



- To return to the previous screen during menu operations, press RETURN.
- Texts in parentheses denote indicators on the front display.

3 Use the cursor keys (</>) to select a setting.

Item	Setting	Function
Shuffle (Shuffle)	Off (Off)	Turns off the shuffle function.
	Songs (Songs)	Plays back songs in random order. “⌘” appears in the TV screen.
	Albums (Albums)	Plays back albums in random order. “⌘” appears in the TV screen.
Repeat (Repeat)	Off (Off)	Turns off the repeat function.
	One (One)	Plays back the current song repeatedly. “↺” appears in the TV screen.
	All (All)	Plays back all songs repeatedly. “↻” appears in the TV screen.

4 To exit from the menu, press **OPTION**.



Playing back music stored on a USB storage device

You can play back music files stored on a USB storage device on the unit. Refer to the instruction manuals for the USB storage device for more information.

The unit supports USB mass storage class devices (FAT16 or FAT32 format).



- The unit supports WAV (PCM format only), MP3, WMA, MPEG-4 AAC and FLAC files (1- or 2-channel audio only).
- The unit is compatible with sampling rate of up to 96 kHz for WAV and FLAC files, and 48 kHz for other files.
- Some features may not be compatible, depending on the model or manufacturer of the USB storage device.
- Digital Rights Management (DRM) contents cannot be played back.

Connecting a USB storage device

1 Connect the USB storage device to the USB jack.

The unit (front)

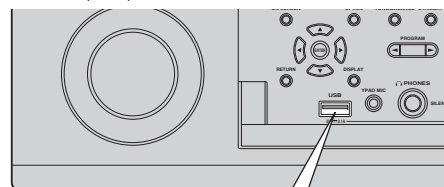

USB storage device



- If the USB storage device contains many files, it may take time to load the them. In this case, "Loading..." appears in the front display.



- Stop playback of the USB storage device before disconnect it from the USB jack.
- Disconnect the USB storage device from the USB jack when it is not in use.

Playback of USB storage device contents

Follow the procedure below to operate the USB storage device contents and start playback.

You can control the USB memory device with the menu displayed on the TV screen.

1 Press USB to select "USB" as the input source.

The browse screen is displayed on the TV.

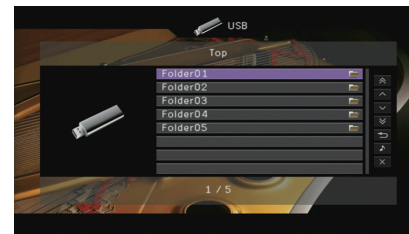

- If playback is ongoing on your USB storage device, the playback screen is displayed.



Menu operation keys
Cursor keys
ENTER
RETURN

2 Use the cursor keys to select an item and press ENTER.

If a song is selected, playback starts and the playback screen is displayed.

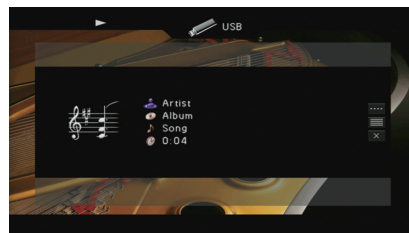

- To return to the previous screen, press RETURN.
- Files not supported by the unit cannot be selected.
- If the unit detects a series of unsupported files (such as images and hidden files) during playback, playback stops automatically.

■ Browse screen



1 Status indicators

Display the current repeat/shuffle settings (p.70) and playback status (such as play/pause).

2 List name

3 Contents list

Displays the list of USB storage device contents. Use the cursor keys to select an item and press ENTER to confirm the selection.

4 Item number/total

5 Operation menu

Use the cursor keys to select an item and press ENTER to confirm the selection.

Menu	Function
1 Page Up	Moves to the previous/next page of the list.
1 Page Down	
10 Pages Up	Moves 10 pages forward/backward.
10 Pages Down	
Return	Returns to the higher-level list.
Now Playing	Moves to the playback screen.
Screen Off	Closes the screen display and shows the background. Press one of the menu operation keys to redisplay it.



■ Playback screen

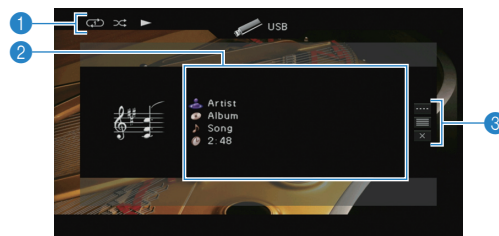

1 Status indicators

Display the current repeat/shuffle settings (p.70) and playback status (such as play/pause).

2 Playback information

Displays the artist name, album name, song title, and elapsed time. Use the cursor keys to select scrollable information.

3 Operation menu

Use the cursor keys to select an item and press ENTER to confirm the selection. To close the submenu, press RETURN.

Menu	Submenu	Function
	▶	Resumes playback from pause.
	■	Stops playback.
Play Control	■	Stops playback temporarily.
	⏮	Skips forward/backward.
	⏭	
Browse		Moves to the browse screen.
Screen Off		Closes the screen display and shows the background. Press one of the menu operation keys to redisplay it.



- You can also use the external device operation keys (▶, ■, ■, ⏮, ⏭) on the remote control to control playback.

■ Repeat/shuffle settings

You can configure the repeat/shuffle settings for playback of USB storage device contents.

1 When “USB” is selected as the input source, press **OPTION**.

2 Use the cursor keys to select “Shuffle” (Shuffle) or “Repeat” (Repeat) and press **ENTER**.



- To return to the previous screen during menu operations, press RETURN.
- Texts in parentheses denote indicators on the front display.

3 Use the cursor keys (<|>) to select a setting.

Item	Setting	Function
Shuffle (Shuffle)	Off (Off)	Turns off the shuffle function.
	On (On)	Plays back songs in the current album (folder) in random order. “⌘” appears on the TV screen.
Repeat (Repeat)	Off (Off)	Turns off the repeat function.
	One (One)	Plays back the current song repeatedly. “1” appears on the TV screen.
	All (All)	Plays back all songs in the current album (folder) repeatedly. “∞” appears on the TV screen.

4 To exit from the menu, press **OPTION**.

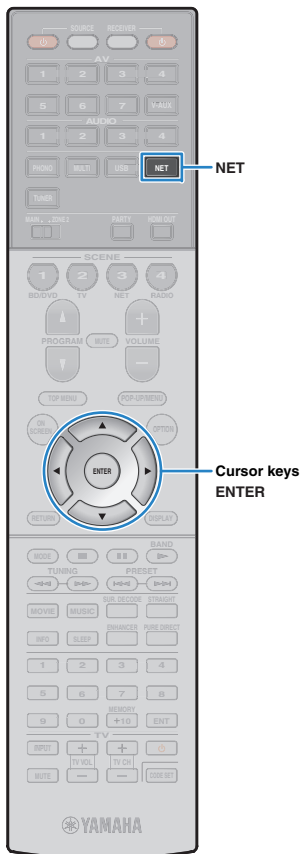

Playing back music stored on media servers (PCs/NAS)

You can play back music files stored on your PC or DLNA-compatible NAS on the unit.



- To use this function, the unit and your PC must be connected to the same router (p.35). You can check whether the network parameters (such as the IP address) are properly assigned to the unit in “Network” (p.115) in the “Information” menu.
- The unit supports playback of WAV (PCM format only), MP3, WMA, MPEG-4 AAC and FLAC files (1- or 2-channel audio only).
- The unit is compatible with sampling rates of up to 96 kHz for WAV and FLAC files, and 48 kHz for other files.
- To play back FLAC files, you need to install server software that supports sharing of FLAC files via DLNA on your PC or use a NAS that supports FLAC files.

Media sharing setup

To play back music files stored on your PC or DLNA-compatible NAS, first you need to configure the media sharing setting on each music server.

■ For a PC with Windows Media Player installed

- 1 Check that Windows Media Player 11 or later is installed on your PC.
- 2 In the media sharing settings, enable media sharing and allow media to be shared with the device.

■ For a PC or a NAS with other DLNA server software installed

Refer to the instruction manual for the device or software and configure the media sharing settings.

Playback of PC music contents

Follow the procedure below to operate the PC music contents and start playback.

You can control the PC/NAS with the menu displayed on the TV screen.

- 1 Press NET repeatedly to select “SERVER” as the input source.

The browse screen is displayed on the TV.

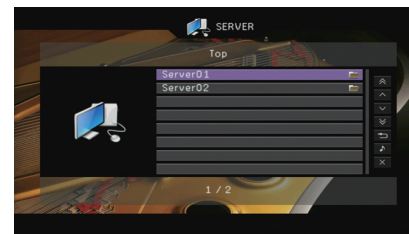

- If playback of a music file selected from the unit is ongoing on your PC, the playback screen is displayed.

- 2 Use the cursor keys to select a music server and press ENTER.



Menu operation keys
 Cursor keys
 ENTER
 RETURN

3 Use the cursor keys to select an item and press ENTER.

If a song is selected, playback starts and the playback screen is displayed.

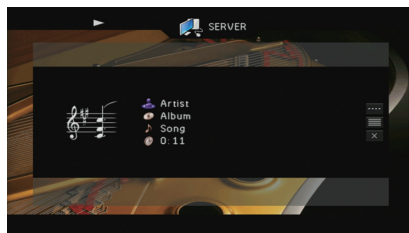

- To return to the previous screen, press RETURN.
- Files not supported by the unit cannot be selected.
- If the unit detects a series of unsupported files (such as images and hidden files) during playback, playback stops automatically.

Browse screen

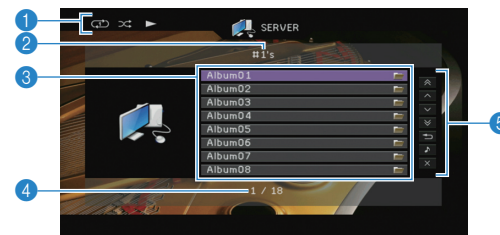

1 Status indicators

Display the current repeat/shuffle settings (p.73) and playback status (such as play/pause).

2 List name

3 Contents list

Displays the list of PC content. Use the cursor keys to select an item and press ENTER to confirm the selection.

4 Item number/total

5 Operation menu

Use the cursor keys to select an item and press ENTER to confirm the selection.

Menu	Function
1 Page Up	Moves to the previous/next page of the list.
1 Page Down	
10 Pages Up	Moves 10 pages forward/backward.
10 Pages Down	
Return	Returns to the higher-level list.
Now Playing	Moves to the playback screen.
Screen Off	Closes the screen display and shows the background. Press one of the menu operation keys to redisplay it.



■ Playback screen

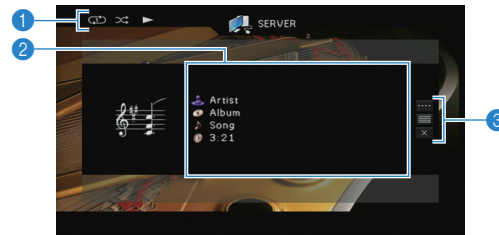

1 Status indicators

Display the current repeat/shuffle settings (p.73) and playback status (such as play/pause).

2 Playback information

Displays the artist name, album name, song title, and elapsed time. Use the cursor keys to select scrollable information.

3 Operation menu

Use the cursor keys to select an item and press ENTER to confirm the selection. To close the submenu, press RETURN.

Menu	Submenu	Function
	▶	Resumes playback from pause.
	■	Stops playback.
Play Control	■	Stops playback temporarily.
	⏮	Skips forward/backward.
	⏭	
Browse		Moves to the browse screen.
Screen Off		Closes the screen display and shows the background. Press one of the menu operation keys to redisplay it.



- You can also use the external device operation keys (▶, ■, ■, ⏮, ⏭) on the remote control to control playback.
- You can also use a DLNA-compatible Digital Media Controller (DMC) to control playback. For details, see “DMC Control” (p.91).

■ Repeat/shuffle settings

You can configure the repeat/shuffle settings for the playback of PC music content.

- When “SERVER” is selected as the input source, press **OPTION**.
- Use the cursor keys to select “Shuffle” (Shuffle) or “Repeat” (Repeat) and press **ENTER**.



- To return to the previous screen during menu operations, press RETURN.
- Text in parentheses denotes indicators on the front display.

3 Use the cursor keys (</>) to select a setting.

Item	Setting	Function
Shuffle (Shuffle)	Off (Off)	Turns off the shuffle function.
	On (On)	Plays back songs in the current album (folder) in random order. “⌘” appears on the TV screen.
Repeat (Repeat)	Off (Off)	Turns off the repeat function.
	One (One)	Plays back the current song repeatedly. “1” appears on the TV screen.
	All (All)	Plays back all songs in the current album (folder) repeatedly. “∞” appears on the TV screen.

4 To exit from the menu, press **OPTION**.

Listening to Internet radio

You can listen to Internet radio stations from all over the world.



- To use this function, the unit must be connected to the Internet (p.35). You can check whether the network parameters (such as the IP address) are properly assigned to the unit in "Network" (p.115) in the "Information" menu.
- This service may be discontinued without notice.
- You may not be able to receive some Internet radio stations.
- The unit uses the vTuner Internet radio station database service.

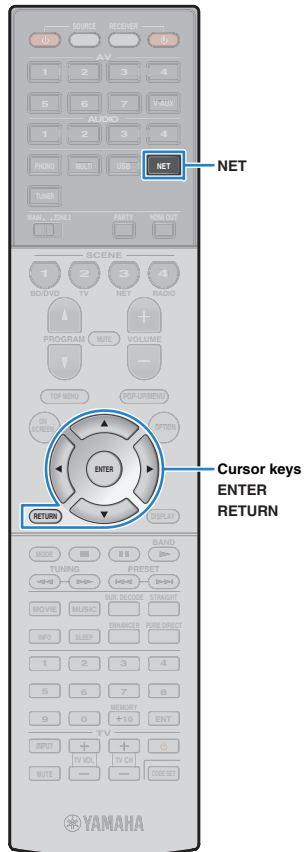

- 1 Press NET repeatedly to select "NET RADIO" as the input source.**

The browse screen is displayed on the TV.



- 2 Use the cursor keys to select an item and press ENTER.**

If an Internet radio station is selected, playback starts and the playback screen is displayed.

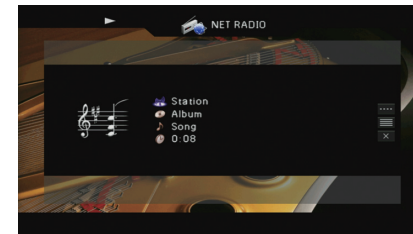

- To return to the previous screen, press RETURN.



Menu operation keys
Cursor keys
ENTER
RETURN

External device
operation keys

Browse screen

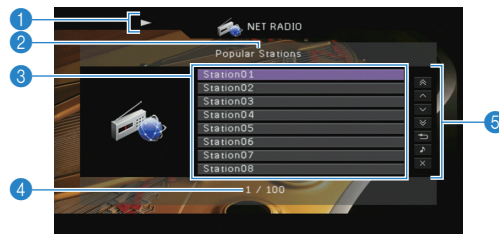

1 Playback indicator

2 List name

3 Contents list

Displays the list of Internet radio content. Use the cursor keys to select an item and press ENTER to confirm the selection.

4 Item number/total

5 Operation menu

Use the cursor keys to select an item and press ENTER to confirm the selection.

Menu	Function
1 Page Up	Moves to the previous/next page of the list.
1 Page Down	
10 Pages Up	Moves 10 pages forward/backward.
10 Pages Down	
Return	Returns to the higher-level list.
Now Playing	Moves to the playback screen.
Screen Off	Closes the screen display and shows the background. Press one of the menu operation keys to redisplay it.



- You can register your favorite Internet radio stations to the "Bookmarks" folder by accessing the following website with the web browser on your PC. To use this feature, you need the unit's vTuner ID and your e-mail address in order to create your personal account. You can find the vTunerID (MAC address of the unit) in "Network" (p.115) in the "Information" menu.
<http://yradio.vtuner.com/>

Playback screen



1 Playback indicator

2 Playback information

Displays the station name, album name, song title, and elapsed time.

3 Operation menu

Use the cursor keys to select an item and press ENTER to confirm the selection.

To close the submenu, press RETURN.

Menu	Submenu	Function
Play Control	■	Stops playback.
Browse		Moves to the browse screen.
Screen Off		Closes the screen display and shows the background. Press one of the menu operation keys to redisplay it.



- You can also use the external device operation key (■) on the remote control to stop playback.
- Some information may not be available depending on the station.

Playing back iTunes/iPod music via a network (AirPlay)

The AirPlay function allows you to play back iTunes/iPod music on the unit via network.

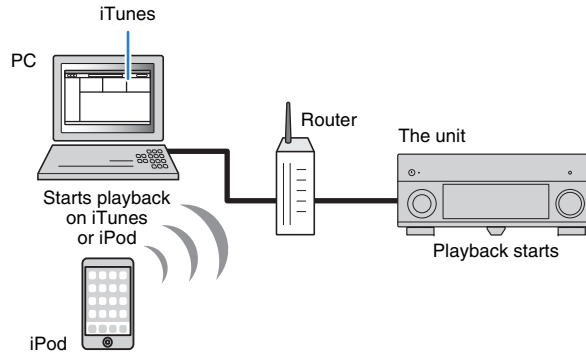

- To use this function, the unit and your PC or iPod must be connected to the same router (p.35). You can check whether the network parameters (such as the IP address) are properly assigned to the unit in "Network" (p.115) in the "Information" menu.

Supported iTunes/iPods (as of April 2012)

- iTunes 10.2.2 or later (Windows/Mac)
- iPod touch, iPhone or iPad with iOS 4.3.3 or later

Playback of iTunes/iPod music contents

Follow the procedure below to play back iTunes/iPod music contents on the unit.

1 Turn on the unit, and start iTunes on the PC or display the playback screen on the iPod.

If the iTunes/iPod recognizes the unit, the AirPlay icon () appears.

iTunes (example)



iPod (example)

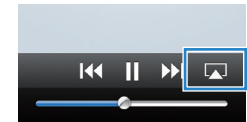

- If the icon does not appear, check whether the unit and PC/iPod are connected to the router properly.

2 On the iTunes/iPod, click (tap) the AirPlay icon and select the unit (network name of the unit) as the audio output device.

iTunes (example)

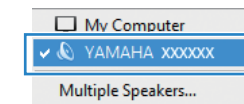

iPod (example)

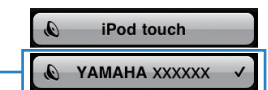

Network name of the unit

3 Select a song and start playback.

The unit automatically selects "AirPlay" as the input source and starts playback.

The playback screen is displayed on the TV.



Menu operation keys
Cursor keys
ENTER
RETURN

External device
operation keys



- You can turn on the unit automatically when starting playback on iTunes or iPod by setting "Network Standby" (p.108) in the "Setup" menu to "On".
- You can edit the network name (the unit's name on the network) displayed on iTunes/iPod in "Network Name" (p.108) in the "Setup" menu.
- If you select the other input source on the unit during playback, playback on the iTunes/iPod stops automatically.
- You can adjust the unit's volume from the iTunes/iPod during playback. To disable volume controls from iTunes/iPod, set "Volume Interlock" (p.90) in the "Input" menu to "Off".
- To start AirPlay playback when AirPlay from another device is ongoing, first stop the current playback.

Caution

- When you use iTunes/iPod controls to adjust volume, the volume may be unexpectedly loud. This could result in damage to the unit or speakers. If the volume suddenly increases during playback, stop playback on the iTunes/iPod immediately.

■ Playback screen

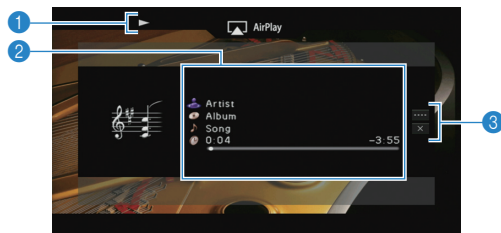

1 Playback indicator

2 Playback information

Displays the artist name, album name, song title, and elapsed/remaining time.

3 Operation menu

Use the cursor keys to select an item and press ENTER to confirm the selection.

To close the submenu, press RETURN.

Menu	Submenu	Function
Play Control	▶	Resumes playback from pause.
	■	Stops playback temporarily.
	⏮ ⏭	Skips forward/backward.
Screen Off		Closes the screen display and shows the background. Press one of the menu operation keys to redisplay it.



- You can also use the external device operation keys (▶, ■, ⏮, ⏭) on the remote control to control playback.



- To control iTunes playback with the remote control of the unit, you need to configure the iTunes preferences to enable iTunes control from remote speakers in advance.

iTunes (example of English version)

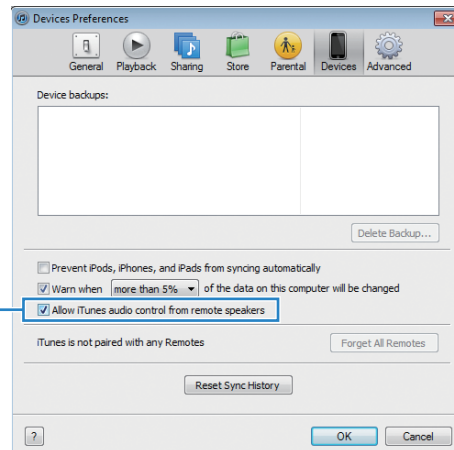

Check this box

Playing back music in multiple rooms (multi-zone)

The multi-zone function allows you to play back different input sources in the room where the unit is installed (main zone) and in another room (Zone2).

For example, while you are watching TV in the living room (main zone), another person can listen to radio in the study room (Zone2).



- Since there are many possible ways to use the unit in a multi-zone configuration, we recommend that you consult with your nearest authorized Yamaha dealer or service center about the multi-zone connections that best meet your requirements.

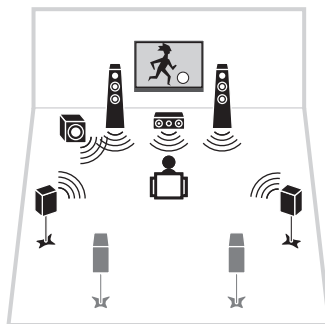

Living room (main zone)

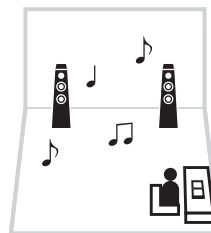

Study room (Zone2)



- Analog audio sources (including FM/AM radio), and USB and network sources can be output to Zone2. To listen to the playback of an external device in Zone2, you need to connect the device to the AUDIO jacks of the unit. The party mode (p.82) allows you to play back the same audio output in main zone as Zone2, whatever the input audio signal type.

Preparing Zone2

Connect the device that will be used in Zone2 to the unit. The connection method varies depending on the amplifier being used (the unit or an external amplifier).

Caution

- Remove the unit's power cable from the AC wall outlet before connecting speakers or an external amplifier.
- Ensure that the core wires of the speaker cable do not touch one another or come into contact with the unit's metal parts. Doing so may damage the unit or the speakers. If the speaker cables short circuit, "Check SP Wires" will appear on the front display when the unit is turned on.

Using the unit's internal amplifier

Connect the speakers placed in Zone2 to the unit with speaker cables. For details, see "Connecting Zone2 speakers" (p.22).

■ Using an external amplifier

Connect the external amplifier (with volume control) placed in Zone2 to the unit with a stereo pin cable.

The unit (rear)

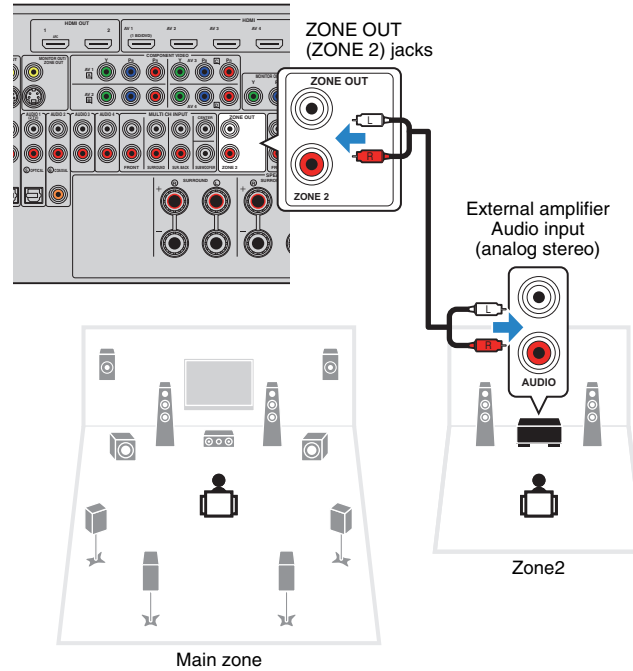

■ Connecting a video monitor for Zone2

Connect a video monitor for Zone2 to watch videos at Zone2. Depending on the video input jacks available on your video monitor, choose one of the video connection methods.



- To watch videos played back on a video device on the Zone2 video monitor, you need to connect the video monitor to the unit in the same way as the video device. For example, if you want to watch videos input from the DVD player via a component video cable, connect the video monitor to the MONITOR OUT/ZONE OUT (COMPONENT VIDEO) jacks with a component video cable.

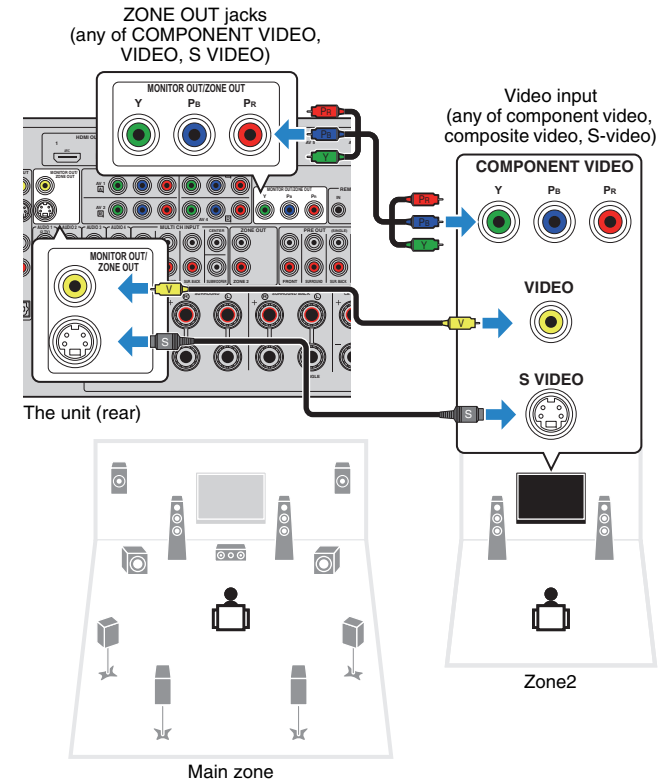

To assign the MONITOR OUT/ZONE OUT jacks to the Zone2 video monitor, set "Monitor Out Assign" (p.110) in the "Setup" menu to "Zone2".

■ Operating the unit from Zone2 (remote connection)

You can operate the unit and external devices from Zone2 using the supplied remote control if you connect an infrared signal receiver/emitter to the unit's REMOTE IN/OUT jacks.



- To operate external devices with the supplied remote control, you must register a remote control code for each device before using (p.119).

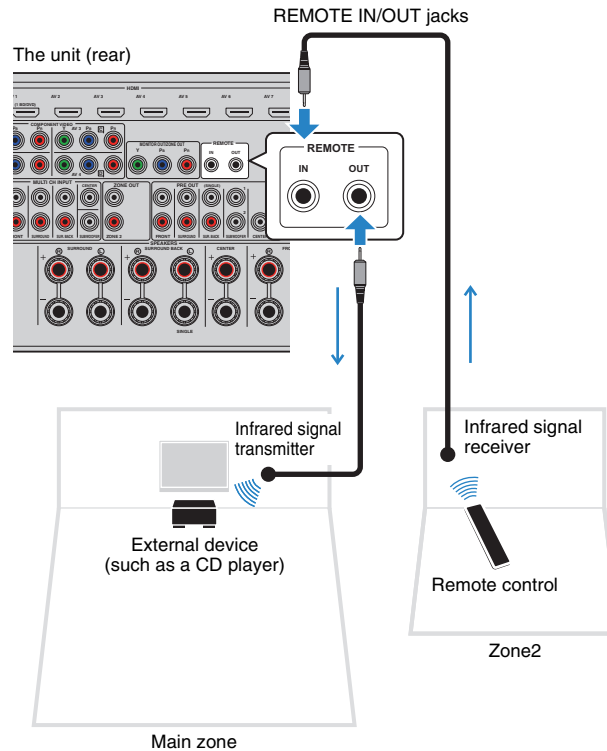

Remote connections between Yamaha products

An infrared signal transmitter is not required if you are using Yamaha products that support remote connections, as the unit does. You can transmit remote control signals by connecting the REMOTE IN/OUT jacks with monaural mini-jack cables and an infrared signal receiver.

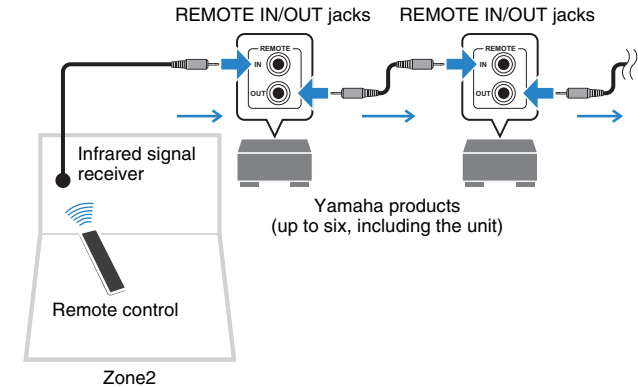

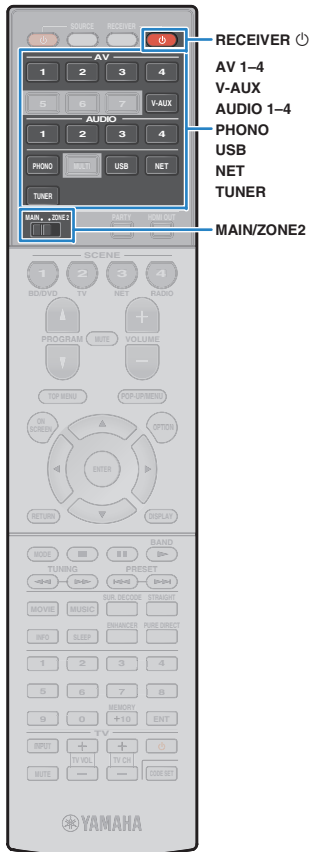

Controlling Zone2

1 Set MAIN/ZONE2 to “ZONE2”.

2 Press RECEIVER .

Each time you press the key, Zone2 is enabled or disabled. When Zone2 is enabled, “ZONE2” lights up in the front display.

3 Use the following keys to select an input source.

AV 1-4: AV 1-4 (AUDIO) jacks

V-AUX: VIDEO AUX (AUDIO) jacks (on the front panel)

AUDIO 1-4: AUDIO 1-4 (AUDIO) jacks

PHONO: PHONO jacks

USB: USB jack (on the front panel)

NET: NETWORK jack (press repeatedly to select a desired network source)

TUNER: FM/AM radio



- You cannot select USB and network sources exclusively for each zone. For example, if you select “SERVER” for Zone2 when “USB” is selected for the main zone, the input source for the main zone also switches to “SERVER”.

4 Start playback on the external device or select a radio station.

Refer to the instruction manual for the external device. For details on the following operations, see the corresponding pages.

- Listening to FM/AM radio (p.57)
- Playing back iPod music (p.64)
- Playing back music stored on a USB storage device (p.68)
- Playing back music stored on media servers (PCs/NAS) (p.71)
- Listening to Internet radio (p.74)
- Playing back iTunes/iPod music via a network (AirPlay) (p.76)



- The on-screen operations are not available for Zone2. Use the web control to control Zone2. For details on the web control function, refer to “Supplement for Web Control” on the CD-ROM.
- AirPlay is available in Zone2 only when AirPlay playback is ongoing in the main zone.

Caution

- To avoid unexpected noise, never play back DTS-CDs in Zone2.

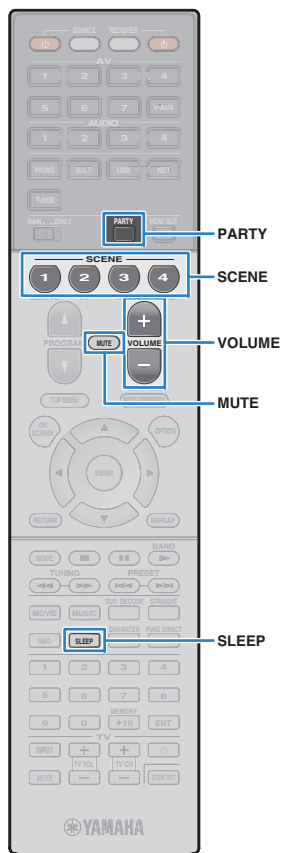

■ Other operations for Zone2

The following functions are also available when Zone2 is enabled.

Adjusting the volume

Press VOLUME or MUTE.

Selecting the input source and settings at once (SCENE)

Press SCENE.



- To register the current settings (input source, volume and tone control) to a scene, hold down the desired SCENE key until “SET Complete” appears on the front display.

Setting the sleep timer

Press SLEEP repeatedly to set the time (120 min, 90 min, 60 min, 30 min, off).

Adjusting the high-/low-frequency range of sounds

- ① Press ZONE CONTROL on the front panel.
- ② Press TONE/BALANCE repeatedly to select “Treble” or “Bass”.
- ③ Press PROGRAM to make an adjustment.

Setting range

-10.0 dB to +10.0 dB (2.0 dB steps)

Default

0.0 dB

Adjusting the Zone2 front speaker balance

- ① Press ZONE CONTROL on the front panel.
- ② Press TONE/BALANCE repeatedly to select “Balance”.
- ③ Press PROGRAM to make an adjustment.

■ Enjoying the same source in multiple rooms (party mode)

The party mode allows you to play back in Zone2 the same music that is being played back in the main zone. During the party mode, stereo playback is automatically selected for all zones. Utilize this function when you want to use main zone music as background music for a house party.

1 Press PARTY.

Each time you press the key, the party mode is turned on or off.

When the party mode is turned on, “PARTY” lights up in the front display.



- If the party mode does not work on Zone2, set “Party Mode Set” (p.110) in the “Setup” menu to “Enable” (default).

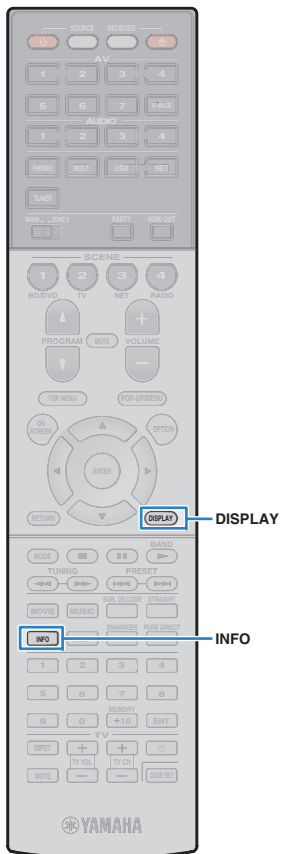

Viewing the current status

Switching information on the front display

1 Press INFO.

Each time you press the key, the displayed item changes.



Item name

About 3 seconds later, the corresponding information for the displayed item appears.



Information



- Available items vary depending on the selected input source. The displayed item can also be applied separately to each input source group.

Input source group	Item
AV 1-7 V-AUX AUDIO 1-4 PHONO	DSP Program (sound mode name), Audio Decoder (decoder name)
TUNER	DSP Program (sound mode name), Audio Decoder (decoder name) * (U.S.A. model only) HD Radio data is also available when the unit is tuned into an HD Radio station (p.59). * (U.K. and Europe models only) Radio Data System data is also available when the unit is tuned into a Radio Data System broadcasting station (p.61).

Input source group	Item
USB SERVER AirPlay	Song (song title), Artist (artist name), Album (album name), DSP Program (sound mode name), Audio Decoder (decoder name) * During simple playback of iPod: Input (input source name), DSP Program (sound mode name), Audio Decoder (decoder name)
NET RADIO	Song (song title), Album (album name), Station (station name), DSP Program (sound mode name), Audio Decoder (decoder name)

Viewing the status information on the TV

1 Press DISPLAY.

The following information is displayed on the TV.

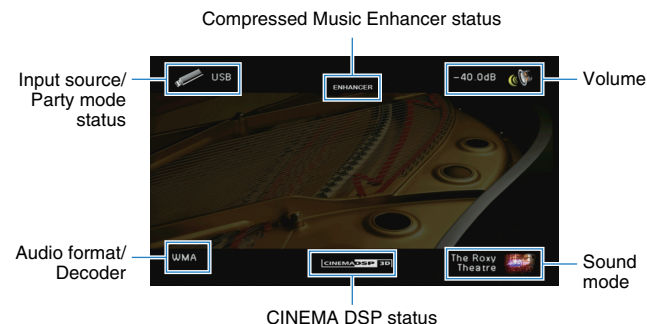

2 To close the information display, press DISPLAY.

Configuring playback settings for different playback sources (Option menu)

You can configure separate playback settings for different playback sources. This menu is available on the front panel (or on the TV screen), allowing you to easily configure settings during playback.

1 Press **OPTION**.



Front display



TV screen

2 Use the cursor keys to select an item and press **ENTER**.



- To return to the previous screen during menu operations, press **RETURN**.

3 Use the cursor keys (</>) to select a setting.

4 To exit from the menu, press **OPTION**.

Option menu items



- Available items vary depending on the selected input source.
- Text in parentheses denotes indicators on the front display.

Item	Function	Page	
Tone Control (Tone Control)	Adjusts the high-frequency range and low-frequency range of sounds.	85	
Adaptive DRC (Adaptive DRC)	Sets whether the dynamic range (from maximum to minimum) is automatically adjusted when the volume is adjusted.	85	
CINEMA DSP 3D Mode (CINEMA DSP 3D)	Enables/disables CINEMA DSP 3D.	85	
Dialogue Adjust (Dialog Adjust)	Dialogue Level (Dialog Lvl)	Adjusts the volume of dialogue sounds.	86
	Dialogue Lift (Dialog Lift)	Adjusts the perceived height of dialogue sounds.	86
Extended Surround (EXTD Surround)	Selects how to play back 5.1- to 7.1-channel sources when surround back speakers are used.	86	
Volume Trim (Volume Trim)	Input Trim (In.Trim)	Corrects volume differences between input sources.	86
	Subwoofer Trim (SW.Trim)	Fine-adjusts the subwoofer volume.	87
Enhancer (Enhancer)	Enables/disables Compressed Music Enhancer.	87	
Video Mode (Video Mode)	Enables/disables the video signal processing settings configured in the "Setup" menu.	87	
Audio Select (Audio Select)	Selects the audio input jack to use when more than one audio connection is made for one input source.	87	
Audio Mode (Audio Mode)	(U.S.A. model only) Switches between stereo and monaural for FM/AM radio reception.	87	
FM Mode (FM Mode)	(Except for U.S.A. model) Switches between stereo and monaural for FM radio reception.	88	

Item	Function	Page
Hold/Unhold (Hold/Unhold)	(U.S.A. model only) Enables/disables the hold function when the unit is tuned into an HD Radio station.	60
Traffic Program (TrafficProgram)	(U.K. and Europe models only) Automatically searches for a traffic information station.	62
Repeat (Repeat)	Configures the repeat setting for the iPod (p.67), USB storage device (p.70), or media server (p.73).	—
Shuffle (Shuffle)	Configures the shuffle setting for the iPod (p.67), USB storage device (p.70), or media server (p.73).	—

■ Tone Control (Tone Control)

Adjusts the high-frequency range (Treble) and low-frequency range (Bass) of sounds.

Choices

Treble (Treble), Bass (Bass)

Setting range

-6.0 dB to Bypass (Bypass) to +6.0 dB, *0.5 dB increments

Default

Bypass (Bypass)



- If you set an extreme value, sounds may not match those from other channels.

Adjusting with the front panel controls

- ① Press TONE/BALANCE repeatedly to select "Treble" or "Bass".
- ② Press PROGRAM to make an adjustment.

■ Adaptive DRC (Adaptive DRC)

Sets whether the dynamic range (from maximum to minimum) is automatically adjusted when the volume level is adjusted. When it is set to "On", it is useful for listening to playback at a low volume at night.

Settings

On (On)	Automatically adjusts the dynamic range.
Off (Off) (default)	The dynamic range is not automatically adjusted.

If "On" is selected, the dynamic range becomes narrow at a low volume and wide at a high volume.

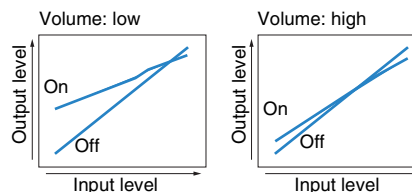

■ CINEMA DSP 3D Mode (CINEMA DSP 3D)

Enables/disables CINEMA DSP 3D (p.54). If this function is set to "On", CINEMA DSP 3D functions with the selected sound programs (except 2ch Stereo and 7ch Stereo).

Settings

On (On) (default)	Enables CINEMA DSP 3D.
Off (Off)	Disables CINEMA DSP 3D.

■ Dialogue Adjust (Dialog Adjust)

Adjusts the volume or perceive height of dialogue sounds.

□ Dialogue Level (Dialog Lvl)

Adjusts the volume of dialogue sounds. If dialogue sounds cannot be heard clearly, you can turn up its volume by increasing this setting.

Setting range

0 to 3

Default

0

□ Dialogue Lift (Dialog Lift)

Adjusts the perceived height of dialogue sounds. If the dialogue sounds as if it is coming from below the TV screen, you can raise its perceived height by increasing this setting.



- This setting is available only when one of the following conditions is met.
 - One of the sound programs (except for 2ch Stereo and 7ch Stereo) is selected when front presence speakers are used.
 - Virtual Presence Speaker (VPS) (p.54) is working.
(You may hear dialogue sounds from the surround speakers depending on the listening position.)

Setting range

0 to 5 (The bigger the value the higher the position)

Default

0

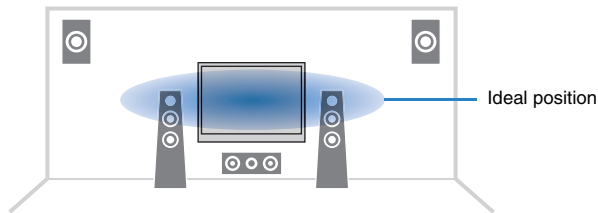

■ Extended Surround (EXTD Surround)

Selects how to play back 5.1- to 7.1-channel sources when surround back speakers are used.

Settings

Auto (Auto) (default)	Automatically selects the most suitable decoder if signals that contain surround back channel signals are input, and reproduces the signals in 6.1- or 7.1-channel. If two surround back speakers are connected, the unit reproduces the 5.1-channel signals in 7.1-channel.
<input checked="" type="checkbox"/> PLIIx Movie (<input checked="" type="checkbox"/> PLIIxMo)	Always reproduces signals in 7.1-channel using the Dolby Pro Logic IIx Movie decoder. This setting is available only when two surround back speakers are connected.
<input checked="" type="checkbox"/> PLIIx Music (<input checked="" type="checkbox"/> PLIIxMu)	Always reproduces signals in 6.1- or 7.1-channel using the Dolby Pro Logic IIx Music decoder. This setting is available only when one or two surround back speakers are connected.
EX/ES (EX/ES)	Automatically selects the Dolby EX or DTS-ES decoder, and reproduces signals in 6.1- or 7.1-channel.
Off (Off)	Always reproduces signals in their original channels. (Even when DTS-ES or Dolby Digital EX signal is input, the unit reproduces the signal in 5.1-channel.)



- Some early Dolby Digital EX or DTS-ES sources do not contain a flag for reproducing surround back channel. We recommend you set "Extended Surround" to " PLIIx Movie" or "EX/ES" when playing back those sources.

■ Volume Trim (Volume Trim)

Fine-adjusts volume difference between input sources or subwoofer volume.

□ Input Trim (In.Trim)

Corrects volume differences between input sources. If you are bothered by volume differences when switching between input sources, use this function to correct it.



- This setting is applied separately to each input source.

Setting range

-6.0 dB to +6.0 dB (0.5 dB increments)

Default

0.0 dB

❑ Subwoofer Trim (SW.Trim)

Fine-adjusts the subwoofer volume.

Setting range

-6.0 dB to +6.0 dB (0.5 dB increments)

Default

0.0 dB

■ Enhancer (Enhancer)

Enables/disables Compressed Music Enhancer (p.56).



- This setting is applied separately to each input source.
- You can also use ENHANCER on the remote control to enable/disable Compressed Music Enhancer (p.56).

Settings

Off (Off)	Disables Compressed Music Enhancer.
On (On)	Enables Compressed Music Enhancer.

Default

TUNER, USB, (network sources): On (On)

Others: Off (Off)



- Compressed Music Enhancer does not work on signals whose sampling rate is over 48 kHz.

■ Video Mode (Video Mode)

Enables/disables the video signal processing (resolution and aspect ratio) settings configured in "Processing" (p.105) in the "Setup" menu.

Settings

Processing (Processing)	Enables the video signal processing.
Direct (Direct) (default)	Disables the video signal processing.

■ Audio Select (Audio Select)

Selects the audio input jack to use when more than one audio connection is made for one input source.



- This setting is applied separately to each input source.

Settings

Auto (Auto) (default)	Automatically selects the audio input jack in the following priority order. 1. HDMI input 2. Digital input (COAXIAL or OPTICAL) 3. Analog input (AUDIO)
HDMI (HDMI)	Always selects HDMI input. No sounds are produced when no signals are input through the HDMI jack.
Coax/Opt (Coax/Opt)	Always selects digital input (COAXIAL or OPTICAL). No sounds are produced when no signals are input through the COAXIAL or OPTICAL jack.
Analog (Analog)	Always selects analog input (AUDIO). No sounds are produced when no signals are input through the AUDIO jacks.

■ Audio Mode (Audio Mode)

(U.S.A. model only)

Switches between stereo and monaural for FM/AM radio reception.



- This setting is applied separately to each band (FM/AM).

Settings

Auto (Auto) (default)	Receives the selected band (FM or AM) in stereo sounds when the signal reception is good and in monaural sounds when it is not good.
Mono (Mono)	Receives the selected band (FM or AM) in monaural sounds.



- HD Radio programs are not available when the unit is in the monaural reception mode.

■ FM Mode (FM Mode)

(Except for U.S.A. model)

Switches between stereo and monaural for FM radio reception.

Settings

Stereo (Stereo) (default)	Receives FM radio in stereo sounds.
Mono (Mono)	Receives FM radio in monaural sounds.

CONFIGURATIONS

Configuring input sources (Input menu)

You can change the input source settings using the TV screen.

- 1 Press ON SCREEN.
- 2 Use the cursor keys to select “Input” and press ENTER.

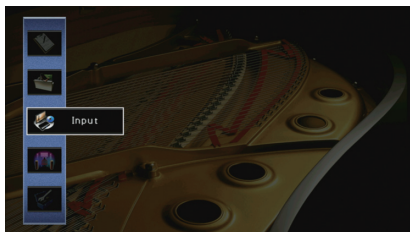

- 3 Use the cursor keys (</>) to select an input source to be configured and press the cursor key (Δ).

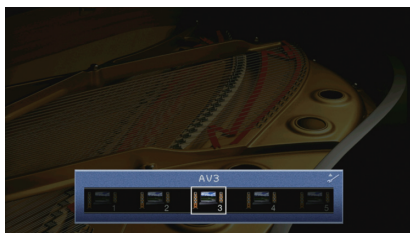

The input source of the unit also changes.



- You can still switch the input source by using cursor keys (</>) after Step 3.

- 4 Use the cursor keys (Δ/▽) to select an item and press ENTER.

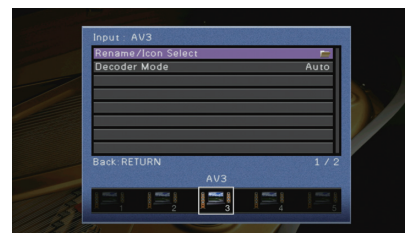

- To return to the previous screen during menu operations, press RETURN.

- 5 Use the cursor keys to select a setting and press ENTER.

- 6 To exit from the menu, press ON SCREEN.

Input menu items



- Available items vary depending on the selected input source.

Item	Function	Page
Rename/Icon Select	Changes the input source name and icon.	90
Decoder Mode	Sets the format of digital audio playback to DTS.	90
Volume Interlock	Enables/disables volume controls from iTunes/iPod via AirPlay.	90
Video Out	Selects a video to be output with the audio input source.	90
DMC Control	Selects whether to allow a DLNA-compatible Digital Media Controller (DMC) to control playback.	91

Rename/Icon Select

Changes the input source name and icon displayed on the front display or TV screen.

Input sources

AV 1–7, V-AUX, AUDIO 1–4, PHONO, USB, MULTI CH

Setup procedure

- 1 Use the cursor keys (</>) to select a template and press the cursor key (▽).



- You cannot change the template or icon for “USB” when an iPod is connected.

- 2 Use the cursor keys (</>) to select an icon and press the cursor key (▽).
- 3 Press ENTER to enter the name edit screen.
- 4 Use the cursor keys and ENTER to rename and select “ENTER” to confirm the entry.

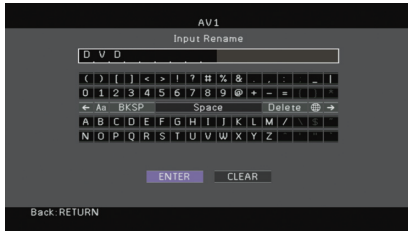

- To clear the entry, select “CLEAR”.

- 5 Use the cursor keys to select “OK” and press ENTER.



- To restore the default setting, select “RESET”.

- 6 To exit from the menu, press ON SCREEN.

Decoder Mode

Sets the format of digital audio playback to “DTS”.

For example, if the unit does not detect DTS audio and outputs noise, set “Decoder Mode” to “DTS”.

Input sources

AV 1–7, V-AUX, AUDIO 1–4 (available only when any audio digital input jack is assigned)

Settings

Auto (default)	Automatically selects an audio format to match the input audio signal.
DTS	Selects DTS only. (Other audio signals are not reproduced.)

Volume Interlock

Enables/disables volume controls from iTunes/iPod via AirPlay.

Input sources

AirPlay

Settings

Off	Disables volume controls from iTunes/iPod.
Limited (default)	Enables volume controls from iTunes/iPod within the limited range (-80 dB to 0 dB and mute).
Full	Enables volume controls from iTunes/iPod in the full range (-80 dB to +16.5 dB and mute).

Video Out

Selects a video to be output with the audio input source.

Input sources

TUNER, (network sources), USB, MULTI CH

Settings

Off	Does not output video.
AV 1–7, V-AUX	Outputs video input through the corresponding video input jacks.

Default

USB: V-AUX

Others: Off

DMC Control

Selects whether to allow DLNA-compatible Digital Media Controller (DMC) to control playback.

Input source

SERVER

Settings

Disable	Does not allow DMCs to control playback.
Enable (default)	Allows DMCs to control playback.



- A Digital Media Controller (DMC) is a device that can control other network devices through the network. When this function is enabled, you can control playback of the unit from DMCs (such as Windows Media Player 12) on the same network.

Configuring the SCENE function (Scene menu)

You can change the settings of the SCENE function (p.49) using the TV screen.

- 1 Press ON SCREEN.
- 2 Use the cursor keys to select “Scene” and press ENTER.

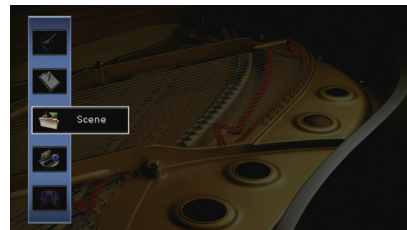

- 3 Use the cursor keys (◀/▶) to select a scene to be configured and press the cursor key (△).

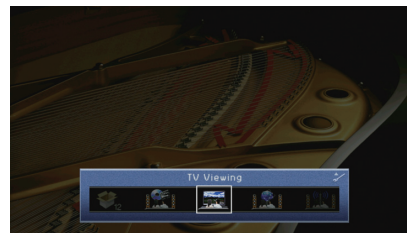

- You can still switch the scene by using cursor keys (◀/▶) after Step 3.

4 Use the cursor keys (Δ/∇) to select an item and press ENTER.



5 Use the cursor keys and ENTER to change the setting.

6 To exit from the menu, press ON SCREEN.

Scene menu items

Item	Function	Page
Save	Registers the current settings in the selected scene.	92
Load	Loads the settings registered for the selected scene. You can also configure the SCENE link playback setting, select items to be included as the scene assignments, or view the settings currently assigned to the selected scene.	92
Rename/Icon Select	Changes the scene name and icon.	93
Reset	Restores the default settings for the selected scene.	93

Save

Registers the unit's current settings (such as input source and sound program) in the selected scene.



- If you have changed the input assignment for a scene, you also need to change the external device assigned to the corresponding SCENE key (p.50).

Load

Loads the settings registered for the selected scene.

Select "DETAIL" to configure the SCENE link playback setting or view the scene assignments.

Device Control

Recalls a selected scene and starts its playback on an external device connected to the unit via HDMI or on a Yamaha product connected to the REMOTE OUT jack. (SCENE link playback)

Settings

Off	Disables the SCENE link playback function.
HDMI Control	Enables SCENE link playback using HDMI Control signals. Select this if an HDMI Control-compatible device (such as a BD/DVD player) is connected to the unit via HDMI. It also turns on the TV if it supports HDMI Control.
IR: Yamaha BD/DVD 1	Enables SCENE link playback using remote control signals. Select this if a Yamaha BD/DVD player is connected to the REMOTE OUT jack.
IR: Yamaha BD/DVD 2	Enables SCENE link playback using remote control signals. Select this if a Yamaha BD/DVD player is connected to the REMOTE OUT jack and "IR: Yamaha BD/DVD 1" does not work properly.
IR: Yamaha CD	Enables SCENE link playback using remote control signals. Select this if a Yamaha CD player is connected to the REMOTE OUT jack.

Default

SCENE1 (BD/DVD), SCENE2 (TV): HDMI Control
SCENE3 (NET), SCENE4 (RADIO), SCENE5-12: Off



- To control playback of an HDMI Control-compatible device by SCENE link playback, you need to set "HDMI Control" in the "Setup" menu to "On" and perform the HDMI Control link setup (p.137).

Detail

Selects items to be included as the scene assignments. You can also view the settings currently assigned to the selected scene.

To include items as the scene assignments, use the cursor keys to select an item and press ENTER to check the box (or uncheck the box to exclude).

For example, if you often adjust the volume while watching TV but listen to radio with low volume at night, exclude “Volume” from the assignments for SCENE2 (TV) and include “Volume” in the assignments for SCENE4 (RADIO).



Choices

Input	Input (p.48), Audio Select (p.87)
HDMI Output	HDMI Output (p.48)
Mode	Sound Program (p.51), Pure Direct Mode (p.104), Enhancer (p.56)
Sound	Tone Control (p.85), Adaptive DRC (p.85)
Surround	CINEMA DSP 3D Mode (p.85), Dialogue Lift (p.86), Dialogue Level (p.86), Subwoofer Trim (p.87), Extended Surround (p.86)
Video	Video Mode (p.105)
Volume	Master Volume (p.48)
Lipsync	Lipsync (p.103), Delay (p.104)
Speaker Setup	Setting Pattern (p.100), PEQ Select (p.102)

Default

Input, HDMI Output, Mode: selected

Sound, Surround, Video, Volume, Lipsync, Speaker Setup: not selected

Rename/Icon Select

Changes the scene name and icon displayed on the front display or TV screen.

Setup procedure

- 1 Use the cursor keys (</>) to select an icon and press the cursor key (▽).



- 2 Press ENTER to enter the name edit screen.

- 3 Use the cursor keys and ENTER to rename and select “ENTER” to confirm the entry.



- To clear the entry, select “CLEAR”.

- 4 Use the cursor keys to select “OK” and press ENTER.



- To restore the default setting, select “RESET”.

- 5 To exit from the menu, press ON SCREEN.

Reset

Restores the default settings (p.49) for the selected scene.

Configuring sound programs/surround decoders (Sound Program menu)

You can change the settings of the sound programs and surround decoders using the TV screen.

- 1 Press ON SCREEN.
- 2 Use the cursor keys to select “Sound Program” and press ENTER.

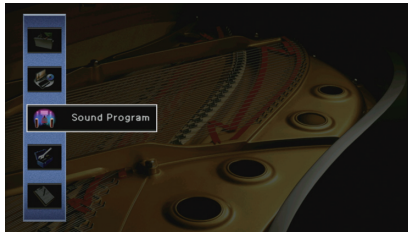

- 3 Use the cursor keys (</>) to select a sound program to be configured and press the cursor key (Δ).

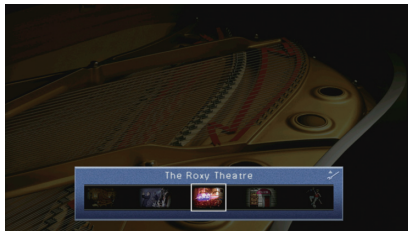

- You can still switch the sound program by using cursor keys (</>) after Step 3.

- 4 Use the cursor keys (Δ/▽) to select an item and press ENTER.

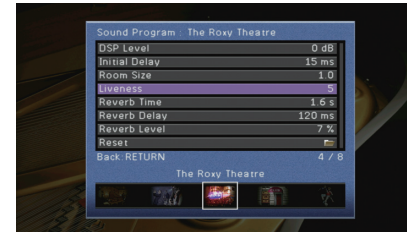

- To return to the previous screen during menu operations, press RETURN.
- To restore the default settings for the selected sound program, select “Reset”.

- 5 Use the cursor keys to select a setting and press ENTER.
- 6 To exit from the menu, press ON SCREEN.

Sound Program menu items



- Available items vary depending on the selected sound program or surround decoder.

Settings for sound programs

Item	Function	Settings
Decode Type	Selects a surround decoder to be used in combination with the selected sound program.	<input type="checkbox"/> PLIIx Movie (<input type="checkbox"/> PLII Movie), Neo:6 Cinema
DSP Level	Adjusts the sound field effect level.	-6 dB to +3 dB (default: 0 dB) Higher to enhance the sound field effect, and lower to reduce it.
Initial Delay	Adjusts the delay between the direct sound and presence sound field generation.	1 ms to 99 ms Higher to enhance the delay effect, and lower to reduce it.
Surround Initial Delay	Adjusts the delay between the direct sound and surround sound field generation.	1 ms to 49 ms Higher to enhance the delay effect, and lower to reduce it.
Surround Back Initial Delay	Adjusts the delay between the direct sound and surround back sound field generation.	
Room Size	Adjusts the broadening effect of the presence sound field.	0.1 to 2.0
Surround Room Size	Adjusts the broadening effect of the surround sound field.	Higher to enhance the broadening effect, and lower to reduce it.
Surround Back Room Size	Adjusts the broadening effect of the surround back sound field.	
Liveness	Adjusts the loss of the presence sound field.	0 to 10
Surround Liveness	Adjusts the loss of the surround sound field.	Higher to enhance the reflectivity, and lower to reduce it.
Surround Back Liveness	Adjusts the loss of the surround back sound field.	
Reverb Time	Adjust the decay time of the rear reverberant sound.	1.0 s to 5.0 s Higher to enrich the reverberant sound and lower to have clear sound.

Item	Function	Settings
Reverb Delay	Adjusts the delay between the direct sound and reverberant sound generation.	0 ms to 250 ms Higher to enhance the delay effect, and lower to reduce it.
Reverb Level	Adjusts the volume of the reverberant sound.	0% to 100% Higher to strengthen the reverberant sound, and lower to weaken it.

The following items are available when you select “2ch Stereo” or “7ch Stereo”.

Sound program	Item	Function	Settings
2ch Stereo	Direct	Selects whether to automatically bypass the DSP circuit when an analog audio source is played back.	Auto (default), Off
	Level	Adjusts the entire volume.	-5 to +5 (default: 0)
	Front / Rear Balance	Adjusts the front and rear volume balance.	-5 to +5 (default: 0) Higher to enhance the front side, and lower to enhance the rear side.
7ch Stereo	Left / Right Balance	Adjusts the right and left volume balance.	-5 to +5 (default: 0) Higher to enhance the right side, and lower to enhance the left side.
	Height Balance	Adjust the height volume balance using the front presence speakers.	0 to 10 (default: 5) Higher to enhance the upside, and lower to enhance the downside. (The front presence speakers do not produce sounds when “Height Balance” is set to “0”.)
	Monaural Mix	Enables/disables monaural sound output.	Off (default), On



- Available items in “7ch Stereo” vary depending on the speaker system being used.

■ Settings for decoders

The following items are available when you set "Decode Type" of "SURROUND DECODER" to "PLIIx Music" (PLII Music) or "Neo:6 Music".

Decode Type	Item	Function	Settings
PLIIx Music (PLII Music)	Panorama	Adjusts the broadening effect of the front sound field.	Off (default), On Select "On" to wrap front right/left channel sounds around the field and generate a spacious sound field in combination with the surround sound field.
	Center Width	Adjusts the broadening effect of the center sound field.	0 to 7 (default: 3) Higher to enhance the broadening effect, and lower to reduce it (closer to center).
	Dimension	Adjusts the difference in level between the front and surround sound fields.	-3 to +3 (default: 0) Higher to strengthen the front sound field and lower to strengthen the surround sound field.
Neo:6 Music	Center Image	Adjusts the center orientation level (broadening effect) of the front sound field.	0.0 to 1.0 (default: 0.3) Higher to strengthen the center orientation level (less broadening effect) and lower to weaken (more broadening effect).

Configuring various functions (Setup menu)

You can configure the unit's various function with the menu displayed on the TV screen.

- 1 Press ON SCREEN.
- 2 Use the cursor keys to select "Setup" and press ENTER.

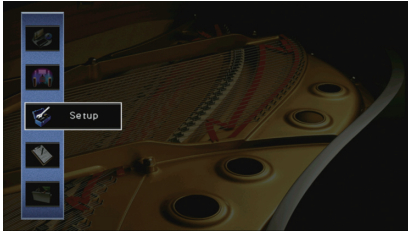

- 3 Use the cursor keys (</>) to select a menu.



- 4 Use the cursor keys (Δ/▽) to select an item and press ENTER.



- To return to the previous screen during menu operations, press RETURN.

- 5 Use the cursor keys to select a setting and press ENTER.
- 6 To exit from the menu, press ON SCREEN.

Setup menu items

Menu	Item	Function	Page		
Speaker	Auto Setup	Automatically optimizes the speaker settings (YPAO).	40		
	Manual Setup	Setting Pattern	Registers two speaker setting patterns and switches between them.	100	
		Setting Data Copy	Copies the "Setting Pattern" parameters in the specified direction.	100	
		Power Amp Assign	Selects a speaker system.	100	
		Configuration	Front	Selects the size of the front speakers.	100
			Center	Selects whether or not a center speaker is connected and its size.	101
			Surround	Selects whether or not surround speakers are connected and their size.	101
			Surround Back	Selects whether or not surround back speakers are connected and their size.	101
			Front Presence	Selects whether or not front presence speakers are connected.	101
			Subwoofer	Selects whether or not a subwoofer is connected and its phase.	101
			Extra Bass	Sets the speakers to produce the front channel low-frequency components.	102
	Bass Cross Over	Sets the lower limit of the low-frequency component that can be output from speakers whose size is set to "Small".	102		
	Distance	Sets the distance between each speaker and listening position.	102		
	Level	Adjusts the volume of each speaker.	102		
	Parametric EQ	Adjusts the tone with an equalizer.	102		
	Test Tone	Enables/disables the test tone output.	103		
	Sound	Lipsync	Delay Enable	Enables/disables the Lipsync adjustment for each input source.	103
			Auto/Manual Select	Selects the method to adjust the delay between video and audio output.	103
Adjustment			Adjusts the delay between video and audio output manually.	104	
Dynamic Range		Selects the dynamic range adjustment method for bitstream audio (Dolby Digital and DTS signals) playback.	104		
Max Volume		Sets the maximum volume to prevent excessive loudness.	104		
Initial Volume		Sets the initial volume for when this receiver is turned on.	104		
Video	Pure Direct Mode	Selects whether to output video signals during the Pure Direct mode.	104		
	Adaptive DSP Level	Selects whether to automatically adjust the CINEMA DSP effect level.	104		
HDMI	Video Mode	Enables/disables the video signal processing (resolution and aspect ratio).	105		
	HDMI Control	Enables/disables HDMI Control. You can also configure the relevant settings (such as ARC and TV audio input).	106		
	Audio Output	Selects a device to output audio.	106		
	Standby Through	Select whether to output videos/audio (input through HDMI jacks) to the TV when the unit is in standby mode.	107		

Menu	Item	Function	Page	
Network	IP Address	Configures the network parameters (such as IP address).	107	
	Network Standby	Selects whether to enable/disable the function that turns on the unit from other network devices.	108	
	MAC Address Filter	Sets the MAC address filter to limit access to the unit from other network devices.	108	
	Network Name	Edits the network name (the unit's name on the network) displayed on other network devices.	108	
Multi Zone	Main Zone Set	Zone Rename	Changes the zone name (for main zone) displayed on the front display or TV screen.	109
		Volume	Enables/disables volume adjustments for Zone2 output.	109
		Max Volume	Sets the Zone2 maximum volume to prevent excessive loudness in the second zone.	109
	Zone2 Set	Initial Volume	Sets the Zone2 initial volume for when the unit is turned on.	109
		Mono	Switches between stereo and monaural for Zone2 output.	110
		Zone Scene Rename	Changes the scene names (for Zone2) displayed on the front display or TV screen.	110
		Zone Rename	Changes the zone name (for Zone2) displayed on the front display or TV screen.	110
		Monitor Out Assign	Select the zone for which the MONITOR OUT/ZONE OUT jacks are used.	110
	Party Mode Set	Enables/disables switching to the party mode.	110	
Function	Input Assignment	Assigns the COMPONENT VIDEO, COAXIAL and OPTICAL jacks to another input source.	111	
	Display Set	Dimmer (Front Display)	Adjusts the brightness of the front display.	111
		Short Message	Selects whether to display short messages on the TV screen when the unit is operated.	111
		Wall Paper	Selects the image to be used as wallpaper on the TV.	111
	Trigger Output1	Trigger Mode	Specifies the condition for the TRIGGER OUT jack to function.	112
	Trigger Output2	Target Zone	Specifies the zone with which the TRIGGER OUT jack functions are synchronized.	112
	Memory Guard	Prevents accidental changes to the settings.	112	
ECO	Auto Power Down	Sets the amount of time for the auto-standby function.	113	
	ECO Mode	Enables/disables the eco mode (power saving mode).	113	
Language		Select an on-screen menu language.	113	

Speaker (Manual Setup)

Configures the speaker settings manually.

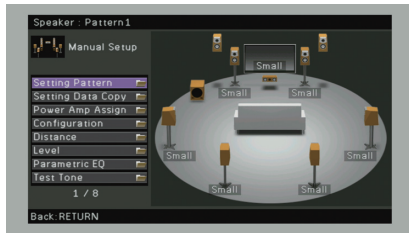

Setting Pattern

Registers two speaker setting patterns and switches between them.

When you configure the following speaker settings, the settings will be memorized in the selected pattern.

- Measurement results (Auto Setup)
- Power Amp Assign
- Configuration
- Distance
- Level
- Parametric EQ

Settings

Pattern1 (default), Pattern2



- The setting pattern currently selected is shown at the top of the "Auto Setup" and "Manual Setup" screens.
- This function is useful when you want to save certain settings according to the varying conditions of your listening environment. For example, if you want to switch the settings when curtains are open or closed, you can save the settings suited for each condition and switch between them.

Setting Data Copy

Copies the "Setting Pattern" parameters in the specified direction.

Choices

Pattern1 > 2	Copies the "Pattern1" parameters to "Pattern2".
Pattern2 > 1	Copies the "Pattern2" parameters to "Pattern1".

Power Amp Assign

Selects a speaker system.

The unit has 7 built-in amplifiers. You can connect 2 to 9 speakers and up to 2 subwoofers (with built-in amplifier) to create the favorite acoustic space in your room. You can also apply bi-amp connections, channel expansion (using an external power amplifier) or multi-zone configurations to enhance your system.

Settings

Basic (default)	Select this option when you use the basic speaker configuration (up to 7-channel plus front presence speakers) (p.15).
7ch +1ZONE	Select this option when you use 7-channel speakers in the main zone and Zone2 speakers (p.21).
5ch BI-AMP	Select this option when you use 5-channel speakers (including bi-amp front speakers) (p.20).
5ch BI-AMP +SB	Select this option when you use 5-channel speakers (including bi-amp front speakers) plus surround back channel expansion using an external amplifier (p.21).

Configuration

Configures the output characteristics of the speakers.



- When you configure the speaker size, select "Large" if the woofer diameter of your speaker is 16 cm (6-1/4") or larger or "Small" if it is smaller than 16 cm (6-1/4").

Front

Selects the size of the front speakers.

Settings

Large	Select this option for large speakers. The front speakers will produce all of the front channel frequency components.
Small (default)	Select this option for small speakers. The subwoofer will produce front channel low-frequency components (configurable in "Bass Cross Over").



- "Front" is automatically set to "Large" when "Subwoofer" is set to "None".

❑ Center

Selects whether or not a center speaker is connected and its size.

Settings

Large	Select this option for large speakers. The center speaker will produce all of the center channel frequency components.
Small (default)	Select this option for small speakers. The subwoofer or front speakers will produce center channel low-frequency components (configurable in "Bass Cross Over").
None	Select this option when no center speaker is connected. The front speakers will produce center channel audio.

❑ Surround

Selects whether or not surround speakers are connected and their sizes.

Settings

Large	Select this option for large speakers. The surround speakers will produce all of the surround channel frequency components.
Small (default)	Select this option for small speakers. The subwoofer or front speakers will produce surround channel low-frequency components (configurable in "Bass Cross Over").
None	Select this option when no surround speakers are connected. The front speakers will produce surround channel audio. Virtual CINEMA DSP works when you select a sound program.

❑ Surround Back

Selects whether or not surround back speakers are connected and their sizes.

Settings

Large x1	Select this option when one large speaker is connected. The surround back speaker will produce all of the surround back channel frequency components.
Large x2	Select this option when two large speakers are connected. The surround back speakers will produce all of the surround back channel frequency components.
Small x1	Select this option when one small speaker is connected. The subwoofer or front speakers will produce surround back channel low-frequency components (configurable in "Bass Cross Over").

Small x2 (default)	Select this option when two small speakers are connected. The subwoofer or front speakers will produce surround back channel low-frequency components (configurable in "Bass Cross Over").
None	Select this option when no surround back speakers are connected. The surround speakers will produce surround back channel audio.



- This setting is not available when "Surround" is set to "None".

❑ Front Presence

Selects whether or not front presence speakers are connected.

Settings

Use (default)	Select this option when front presence speakers are connected.
None	Select this option when no front presence speakers are connected.

❑ Subwoofer

Selects whether or not a subwoofer is connected and its phase.

Settings

Use	Normal (default)	Select this option when a subwoofer is connected (phase not reversed). The subwoofer will produce LFE (low-frequency effect) channel audio and low-frequency components from other channels.
	Reverse	Select this option when a subwoofer is connected (phase reversed). The subwoofer will produce LFE (low-frequency effect) channel audio and low-frequency components from other channels.
None		Select this option when no subwoofer is connected. The front speakers will produce LFE (low-frequency effect) channel audio and low-frequency components from other channels.



- When the bass sound is lacking or unclear, switch the subwoofer phase.

❑ Extra Bass

Sets the speakers to produce the front channel low-frequency components.

Settings

Off (default)	Depending on the size of the front speakers, either the subwoofer or front speakers produce the front channel low-frequency components.
On	Both the front speakers and subwoofer produce the front channel low-frequency components.



- This setting is not available when "Subwoofer" is set to "None", or when "Front" is set to "Small".

❑ Bass Cross Over

Sets the lower limit of the low-frequency components that can be output from a speaker whose size is set to "Small". A frequency sound lower than the specified value will be produced from the subwoofer or front speakers.

Settings

40 Hz, 60 Hz, 80 Hz (default), 90 Hz, 100 Hz, 110 Hz, 120 Hz, 160 Hz, 200 Hz



- If the volume and crossover frequency are adjustable on your subwoofer, set the volume to half and crossover frequency to maximum.

■ Distance

Sets the distance between each speaker and listening position so that sounds from the speakers reach the listening position at the same time. First, select the unit of distance from "Meter" or "Feet".

Choices

Front L, Front R, Center, Surround L, Surround R, Surround Back L, Surround Back R, Front Presence L, Front Presence R, Subwoofer

Setting range

0.30 m to 24.00 m (1.0 ft to 80.0 ft), *0.05 m (0.2 ft) increments

Default

3.00 m (10.0 ft)

■ Level

Adjusts the volume of each speaker.

Choices

Front L, Front R, Center, Surround L, Surround R, Surround Back L, Surround Back R, Front Presence L, Front Presence R, Subwoofer

Setting range

-10.0 dB to +10.0 dB (0.5 dB increments)

Default

0.0 dB

■ Parametric EQ

Adjusts the tone with an equalizer.

Settings

Manual	Select this option when you want to adjust the equalizer manually. For details, see "Manual equalizer adjustment".
YPAO:Flat	Adjusts individual speakers to achieve the same characteristics.
YPAO:Front	Adjusts individual speakers to achieve the same characteristics as the front speakers.
YPAO:Natural	Adjusts all speakers to achieve a natural sound.
Through	Does not use the equalizer.



- "YPAO:Flat", "YPAO:Front", and "YPAO:Natural" are available only when the measurement results of "Auto Setup" have already been saved (p.40). Press ENTER again to view the measurement results.

■ Manual equalizer adjustment

- 1 Set "Parametric EQ" to "Manual" and press ENTER.
- 2 Press ENTER again to enter the edit screen.
- 3 Use the cursor keys to select a speaker and press ENTER.



- To restore the default settings for all speakers, select "PEQ Data Clear" and then "OK".
- To copy the parametric equalizer values acquired with "Auto Setup" (p.40) to the "Manual" fields for fine adjustment, select "PEQ Data Copy" and then an equalizer type.

- 4 Use the cursor keys (</>) to select a preset band and the cursor keys (Δ/▽) to adjust the gain.

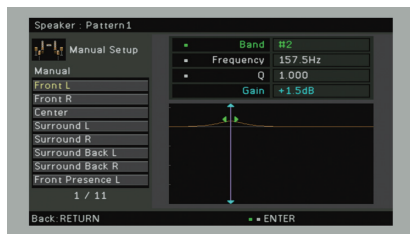

Setting range

Gain: -20.0 dB to +6.0 dB

- 5 To fine-adjust the center frequency or Q factor (bandwidth), press ENTER repeatedly to select an item.

Frequency: Use the cursor keys (</>) to adjust the center frequency of the selected band and the cursor keys (Δ/▽) to adjust the gain.

Q: Use the cursor keys (</>) to adjust the Q factor (bandwidth) of the selected band and the cursor keys (Δ/▽) to adjust the gain.

Setting range

Center frequency: 31.3 Hz to 16.0 kHz

Q factor: 0.500 to 10.08

- 6 To exit from the menu, press ON SCREEN.

Test Tone

Enables/disables the test tone output. Test tone output helps you to adjust the speaker balance or equalizer while confirming its effect.

Settings

Off (default)	Does not output test tones.
On	Outputs test tones automatically when you adjust the speaker balance or equalizer.

Sound

Configures the audio output settings.



Lipsync

Adjusts the delay between video and audio output.

Delay Enable

Enables/disables the Lipsync adjustment for each input source.

Choices

AV 1–7, AUDIO 1–4

Settings

Disable	Disable the Lipsync adjustment for the selected input source.
Enable (default)	Enables the Lipsync adjustment for the selected input source.

Auto/Manual Select

Selects the method to adjust the delay between video and audio output.

Setting range

Auto (default)	Adjusts the delay between video and audio output automatically when a TV that supports an automatic lipsync function is connected to the unit via HDMI. If necessary, you can fine-adjust the audio output timing in "Adjustment".
Manual	Select this option when you want to adjust the delay between video and audio output manually. Adjust the audio output timing in "Adjustment".



- Even if "Auto/Manual Select" is set to "Auto", the automatic adjustment does not work depending on the TV connected to the unit. In this case, adjust the delay manually in "Adjustment".

□ Adjustment

Adjusts the delay between video and audio output manually when “Auto/Manual Select” is set to “Manual”. You can fine-adjust the audio output timing when “Auto/Manual Select” is set to “Auto”.

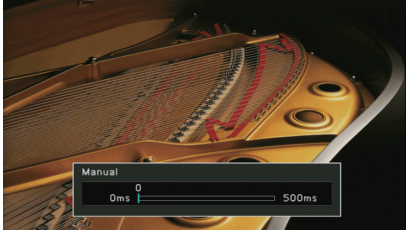

Setting range

0 ms to 500 ms (1 ms increments)

Default

0 ms



- “Offset” shows the difference between automatic adjustment and fine adjustment.

■ Dynamic Range

Selects the dynamic range adjustment method for bitstream audio (Dolby Digital and DTS signals) playback.

Settings

Maximum (default)	Produces audio without adjusting the dynamic range.
Standard	Optimizes the dynamic range for regular home use.
Minimum/Auto	Sets the dynamic range for clear sound even at night or at low volumes. When playing back Dolby TrueHD signals, the dynamic range is automatically adjusted based on the input signal information.

■ Max Volume

Sets the maximum volume to prevent excessive loudness.

Setting range

-30.0 dB to +15.0 dB (5.0 dB increments), +16.5 dB

Default

+16.5 dB

■ Initial Volume

Sets the initial volume when the receiver is turned on.

Settings

Off (default)	Sets the level to the volume level of the unit when it last entered standby mode.
On	Sets at Mute or the specified volume level (-80 dB to +16.5 dB, 0.5 dB increments). (This setting works only when the initial volume is set lower than “Max Volume”.)

■ Pure Direct Mode

Selects whether to output video signals during the Pure Direct mode (p.55).

Settings

Auto (default)	Automatically outputs video signals when any videos are input from the selected input source or an input source that can be operated with the on-screen display is selected. When no video signals are input, the wall paper is displayed.
Video Off	Does not output video signals including the wall paper.

■ Adaptive DSP Level

Selects whether to automatically adjust the CINEMA DSP effect level.

Settings

Off	Does not adjust the effect level automatically.
On (default)	Adjusts the effect level automatically according to the YPAO measurement results and the volume level.

Video

Configures the video output settings.

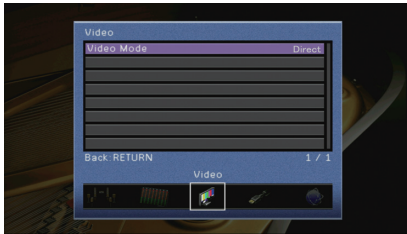

■ Video Mode

Enables/disables the video signal processing (resolution and aspect ratio).

Settings

Direct (default)	Disables the video signal processing.
Processing	Enables the video signal processing. Select a resolution and an aspect ratio in "Resolution" and "Aspect".



- When "Video Mode" is set to "Direct", the unit transmits video signals with the least circuitry in order to reduce video output delay.

□ Resolution

Selects a resolution to output HDMI video signals when "Video Mode" is set to "Processing".

Settings

Through	Does not convert the resolution.
Auto (default)	Selects a resolution automatically in accordance with TV resolution.
480p/576p, 720p, 1080i, 1080p, 4K	Output video signals with a selected resolution. (Only the resolutions supported by your TV are selectable.)



- If you need to select a resolution that is not supported by your TV, set "MONITOR CHECK" (p.117) in the "ADVANCED SETUP" menu to "SKIP" and try again. (Note that the output video may not be displayed on your TV normally.)

□ Aspect

Selects an aspect ratio to output HDMI video signals when "Video Mode" is set to "Processing".

Settings

Through (default)	Does not convert the aspect ratio.
16:9 Normal	Outputs 4:3 video signals to a 16:9 TV with black bands on either side of the screen.



- This setting functions only when 480i/576i or 480p/576p signals are converted into 720p, 1080i, 1080p, or 2160p (4K) signals.

HDMI

Configures the HDMI settings.



HDMI Control

Enables/disables HDMI Control (p.137).

Settings

Off (default)	Disables HDMI Control.
On	Enables HDMI Control. Configure the settings in "TV Audio Input", "ARC" and "Standby Sync".



- To use HDMI control, you need to perform the HDMI Control link setup (p.137) after connecting HDMI Control-compatible devices.

TV Audio Input

Selects an audio input jack of the unit to be used for TV audio input when "HDMI Control" is set to "On". The unit's input source automatically switches to TV audio when the TV input is switched to its built-in tuner.

Settings

AUDIO 1-4

Default

AUDIO 1



- When using ARC to input TV audio to the unit, you cannot use the input jacks selected here for connecting an external device because the input will be used for TV audio input.

ARC

Enables/disables ARC (p.25) when "HDMI Control" is set to "On".

Settings

Off	Disables ARC.
On (default)	Enables ARC.



- You do not need to change this setting normally. In case noises are produced from the speakers connected to the unit because TV audio signals input to the unit via ARC are not supported by the unit, set "ARC" to "Off" and use the TV's speakers.

Standby Sync

Select whether to use HDMI control to link the standby behavior of the TV and the unit when "HDMI Control" is set to "On".

Settings

Off	Does not set the unit to standby mode when the TV is turned off.
On	Sets the unit to standby mode when the TV is turned off.
Auto (default)	Sets the unit to standby mode when the TV is turned off only when the unit is receiving TV audio or HDMI signals.

Audio Output

Selects a device to output audio.



- The "Amp" and "HDMI OUT1" settings are available only when "HDMI Control" is set to "Off".

Amp

Enables/disables the audio output from the speakers and headphones connected to the unit.

Settings

Off	Disables the audio output from the speakers and headphones.
On (default)	Enables the audio output from the speakers and headphones.

❑ HDMI OUT1, HDMI OUT2

Enables/disables the audio output from a TV connected to the HDMI OUT 1 jack or HDMI OUT 2 jack.

Settings

Off (default)	Disables the audio output from the TV.
On	Enables the audio output from the TV.



- The HDMI OUT 1–2 jacks output 2-channel audio signals when the unit is turned on.

■ Standby Through

Select whether to output videos/audio (input through HDMI jacks) to the TV when the unit is in standby mode. If this function is set to “On”, you can use the input selection keys (AV 1–7 and V-AUX) to select an HDMI input even when the unit is in standby mode (the standby indicator on the unit blinks).

Settings

Off (default)	Does not output videos/audio to the TV.
On	Outputs videos/audio to the TV. (The unit consumes more power than when “Off” is selected.)



- This setting is available only when “HDMI Control” is set to “Off”.

Network

Configures the network settings.

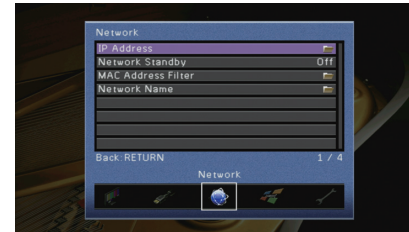

■ IP Address

Configures the network parameters (such as IP address).

❑ DHCP

Select whether to use a DHCP server.

Settings

Off	Does not use a DHCP server. Configure the network parameters manually. For details, see “Manual network settings”.
On (default)	Uses a DHCP server to automatically obtain the unit’s network parameters (such as IP address).

■ Manual network settings

- 1 Set “DHCP” to “Off”.
- 2 Use the cursor keys (Δ/∇) to select a parameter type and press ENTER.

IP Address	Specifies an IP address.
Subnet Mask	Specifies a subnet mask.
Default Gateway	Specifies the IP address of the default gateway.
DNS Server (P)	Specifies the IP address of the primary DNS server.
DNS Server (S)	Specifies the IP address of the secondary DNS server.

- 3 Use the cursor keys (\leftarrow/\rightarrow) to move the edit position and the cursor keys (Δ/∇) to select a value.
- 4 To confirm the setting, press ENTER.
- 5 To configure another network parameter, repeat steps 2 to 4.

6 To save the changes, use the cursor keys to select “OK” and press ENTER.

7 To exit from the menu, press ON SCREEN.

■ Network Standby

Selects whether the unit can be turned on from other network devices (network standby).

Settings

Off (default)	Disables the network standby function.
On	Enables the network standby function. (The unit consumes more power than when “Off” is selected.)

■ MAC Address Filter

Sets the MAC address filter to limit access to the unit from other network devices.

□ Filter

Enables/disables the MAC address filter.

Settings

Off (default)	Disables the MAC address filter.
On	Enables the MAC address filter. In “MAC Address 1–10”, specify the MAC addresses of the network devices that will be permitted access to the unit.

□ MAC Address 1–10

Specifies the MAC addresses (up to 10) of the network devices that will be permitted access to the unit when “Filter” is set to “On”.

■ Procedure

- 1** Use the cursor keys (Δ/∇) to select “MAC Address 1–5” or “MAC Address 6–10” and press ENTER.
- 2** Use the cursor keys (Δ/∇) to select an MAC address number and press ENTER.
- 3** Use the cursor keys (\leftarrow/\rightarrow) to move the edit position and the cursor keys (Δ/∇) to select a value.
- 4** To confirm the setting, press ENTER.
- 5** To save the changes, use the cursor keys to select “OK” and press ENTER.
- 6** To exit from the menu, press ON SCREEN.

■ Network Name

Edits the network name (the unit’s name on the network) displayed on other network devices.

■ Procedure

- 1** Press ENTER to enter the name edit screen.
- 2** Use the cursor keys and ENTER to rename and select “ENTER” to confirm the entry.

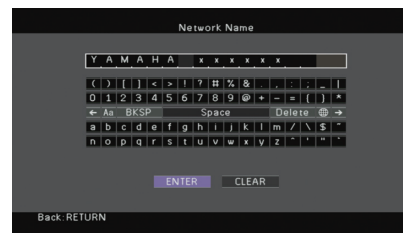

- To clear the entry, select “CLEAR”.

- 3** Use the cursor keys to select “OK” and press ENTER.



- To restore the default setting, select “RESET”.

- 4** To exit from the menu, press ON SCREEN.

Multi Zone

Configures the multi zone settings.



Main Zone Set

Configures the main zone setting.

Zone Rename

Changes the zone name (for main zone) displayed on the front display or TV screen.

Procedure

- 1 Press **ENTER** to enter the name edit screen.
- 2 Use the cursor keys and **ENTER** to rename and select **“ENTER”** to confirm the entry.

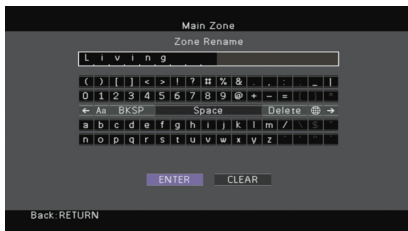

- To clear the entry, select **“CLEAR”**.

- 3 Use the cursor keys to select **“OK”** and press **ENTER**.



- To restore the default setting, select **“RESET”**.

- 4 To exit from the menu, press **ON SCREEN**.

Zone2 Set

Configures the Zone2 settings.

Volume

Enables/disables volume adjustments for Zone2 output.

If you have connected an external amplifier with volume control to the unit, disable volume adjustments for Zone2.

Settings

Fixed	Disables volume adjustments for Zone2 output.
Variable (default)	Enables volume adjustments for Zone2 output.



- This setting is not available when **“Power Amp Assign”** (p.100) is set to **“7ch +1ZONE”**.

Max Volume

Sets the Zone2 maximum volume to prevent excessive loudness.

Setting range

-30.0 dB to +15.0 dB (5.0 dB increments), +16.5 dB

Default

+16.5 dB



- This setting is available only when **“Volume”** is set to **“Variable”**.

Initial Volume

Sets the Zone2 initial volume for when the unit is turned on.

Settings

Off (default)	Sets the level at the volume level of the unit when it last entered standby mode.
On	Sets at Mute or the specified volume level (-80 dB to +16.5 dB, 0.5 dB increments). (This setting works only when the initial volume is set lower than “Max Volume” .)



- This setting is available only when **“Volume”** is set to **“Variable”**.

❑ Mono

Switches between stereo and monaural for Zone2 output.

Settings

Off (default)	Produces stereo sounds in Zone2.
On	Produces monaural sounds in Zone2.

❑ Zone Scene Rename

Changes the scene names (for Zone2) displayed on the front display or TV screen.

■ Procedure

- 1 Use the cursor keys to select a scene to be renamed and press ENTER.
- 2 Press ENTER to enter the name edit screen.
- 3 Use the cursor keys and ENTER to rename and select “ENTER” to confirm the entry.



- To clear the entry, select “CLEAR”.

- 4 Use the cursor keys to select “OK” and press ENTER.



- To restore the default setting, select “RESET”.

- 5 To exit from the menu, press ON SCREEN.

❑ Zone Rename

Changes the zone name (for Zone2) displayed on the front display or TV screen.

You can change the zone name in the same manner as “Zone Rename” in “Main Zone Set” (p.109).

■ Monitor Out Assign

Select the zone for which the MONITOR OUT/ZONE OUT (COMPONENT VIDEO, S VIDEO and VIDEO) jacks are used.

Settings

Main (default), Zone2



- To watch videos played back on a video device on the Zone2 video monitor, you need to connect the video monitor to the unit in the same way as the video device. For example, if you want to watch videos input from the DVD player via a component video cable, connect the video monitor to the COMPONENT VIDEO jacks with a component video cable.

■ Party Mode Set

Enables/disables switching to the party mode (p.82).

Choice

Target: Zone2

Settings

Disable	Disables switching to the party mode.
Enable (default)	Enables switching to the party mode. You can turn on/off the party mode by pressing PARTY on the remote control.

Function

Configures the functions that make the unit easier to use.

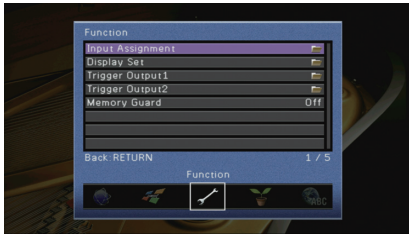

Input Assignment

Assigns the COMPONENT VIDEO, COAXIAL and OPTICAL jacks to another input source.

Procedure

Example: assigning the OPTICAL (5) jack to the input source “AV 2”

- 1 Use the cursor keys to select the cell at the intersection of “AV 2” and “Optical”, and press ENTER.



- 2 Use the cursor keys to select “5” and press ENTER.

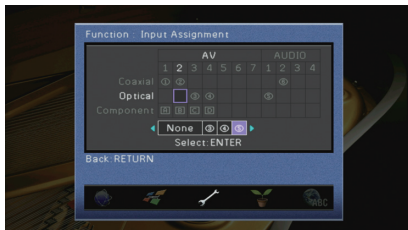

- 3 To exit from the menu, press ON SCREEN.



- You cannot assign both COAXIAL and OPTICAL jacks to the same input source.

Display Set

Configures the settings related to the front display and TV screen display.

Dimmer (Front Display)

Adjusts the brightness of the front display.

Setting range

-4 to 0 (higher to brighten)

Default

0



- The front display may become dark when “ECO Mode” (p.113) is set to “On”.

Short Message

Selects whether to display short messages on the TV screen when the unit is operated (such as input selection and volume adjustment).

Settings

On (default)	Displays short messages on the TV screen.
Off	Does not display short messages on the TV screen.

Wall Paper

Selects the image to be used as wallpaper on the TV.

Settings

Picture 1 (default), Picture 2, Picture 3	Displays the selected image on the TV screen when there is no video signal.
Gray	Displays a gray background on the TV screen when there is no video signal.

■ Trigger Output1, Trigger Output2

Sets the TRIGGER OUT 1–2 jacks to function in sync with the power status of each zone or input switching.

□ Trigger Mode

Specifies the condition for the TRIGGER OUT jack to function.

Settings

Power (default)	The TRIGGER OUT jack functions in sync with the power status of the zone specified with "Target Zone".
Source	The TRIGGER OUT jack functions in sync with the input switching in the zone specified with "Target Zone". An electronic signal is transmitted according to the setting made in "Source."
Manual	Select this to manually switch the output level for electronic signal transmission with "Manual".

Source

Specifies the output level of the electronic signal transmitted with each input, switching when "Trigger Mode" is set to "Source".

Choices

AV 1–7, V-AUX, AUDIO 1–4, PHONO, TUNER, (network sources), USB, MULTI CH

Settings

Low	Stops the electronic signal transmission when you switch to the input source specified in this option.
High (default)	Transmits the electronic signal when you switch to the input source specified in this option.

Manual

Switches the output level for electronic signal transmission manually when "Trigger Mode" is set to "Manual". This setting can also be used to confirm proper function of the external device connected via the TRIGGER OUT jack.

Choices

Low	Stops the electronic signal transmission.
High (default)	Transmits the electronic signal.

□ Target Zone

Specifies the zone with which the TRIGGER OUT jack functions are synchronized.

Settings

Main	When "Trigger Mode" is set to "Power", electronic signal transmission is synchronized with the power status of the main zone. When "Trigger Mode" is set to "Source", electronic signal transmission is synchronized with the input switching in the main zone.
Zone2	When "Trigger Mode" is set to "Power", electronic signal transmission is synchronized with the power status of Zone2. When "Trigger Mode" is set to "Source", electronic signal transmission is synchronized with the input switching in Zone2.
All (default)	When "Trigger Mode" is set to "Power", electronic signal transmission is synchronized with the power status of the main zone or Zone2. When "Trigger Mode" is set to "Source", electronic signal transmission is synchronized with the input switching in the main zone or Zone2.

■ Memory Guard

Prevents accidental changes to the settings.

Settings

Off (default)	Does not protect the settings.
On	Protects the settings until "Off" is selected.



- When "Memory Guard" is set to "On", the lock icon (🔒) is displayed on the menu screen.

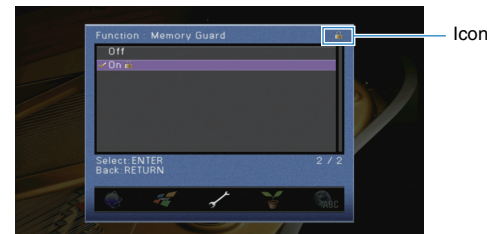

ECO

Configures the power supply settings.

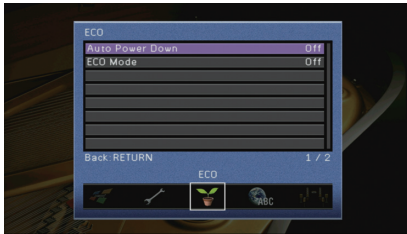

Auto Power Down

Sets the amount of time for the auto-standby function. If you do not operate the unit for the specified time, the unit will automatically go into standby mode.

Settings

Off	Does not set the unit to standby mode automatically.
2 hours, 4 hours, 8 hours, 12 hours	Sets the unit to standby mode when you have not operated the unit for the specified time. For example, when "2 hours" is selected, the unit will switch to standby mode if you do not operate it for 2 hours.

Default

U.K. and Europe models: 8 hours

Other models: Off



- Just before the unit enters standby mode, "AutoPowerDown" appears and then countdown starts in the front display.

ECO Mode

Enables/disables the eco (power saving) mode.

When the eco mode is enabled, you can reduce the unit's power consumption.

Settings

Off (default)	Disables the eco mode.
On	Enables the eco mode.



- The new setting will take effect after the unit is restarted.
- When "ECO Mode" is set to "On", the front panel display may become dark.
- If you want to play audio at high volume, set "ECO Mode" to "Off".

Language

Select an on-screen menu language.

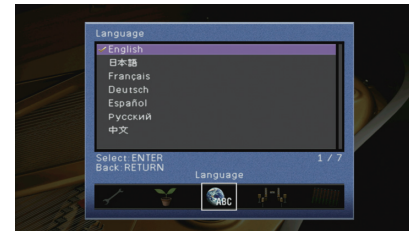

Settings

English (default)	English
日本語	Japanese
Français	French
Deutsch	German
Español	Spanish
Русский	Russian
中文	Chinese



- The information on the front display is provided in English only.

Viewing information about the unit (Information menu)

You can view information about the unit using the TV screen.

- 1 Press **ON SCREEN**.
- 2 Use the cursor keys to select “Information” and press **ENTER**.

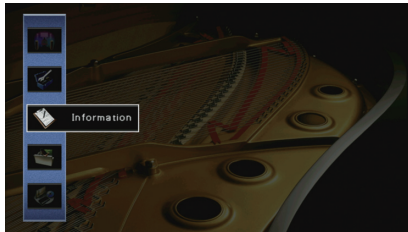

- 3 Use the cursor keys (</>) to select an information type.



- 4 To exit from the menu, press **ON SCREEN**.

Types of information

■ Audio Signal

Displays information about the current audio signal.

Input	Format	Audio format of the input signal
	Channel	The number of source channels in the input signal (front/surround/LFE) For example, “5.1 (3/2/0.1)” means 5.1ch in total (3 front channels, 2 surround channels, and LFE).
	Sampling	The number of samples per second of the input digital signal
	Bitrate	The amount of data per second of the input bitstream signal
	Dialogue	The dialogue normalization level of the input bitstream signal
Output	The speaker terminals from which signals are output	



- Even when the unit is set to output bitstream signals directly, the signal may be converted depending on the specifications and settings of the playback device.

■ Video Signal

Displays information about the current video signal.

HDMI Signal	Presence or absence of HDMI signal input/output
HDMI Resolution	Resolutions of input signal (analog or HDMI) and output signal (HDMI)
Analog Resolution	Resolutions of input signal (analog) and signal output at the MONITOR OUT jacks (analog)

■ HDMI Monitor

Displays information about the TVs connected to the HDMI OUT jacks.

Use the cursor keys (△/▽) to switch between “OUT1” and “OUT2”.

Interface	TV interface
Video Resolution	Resolutions supported by the TV

Network

Displays the network information on the unit.

IP Address	IP address
Subnet Mask	Subnet mask
Default Gateway	The IP address of the default gateway
DNS Server (P)	The IP address of the primary DNS server
DNS Server (S)	The IP address of the secondary DNS server
MAC Address	MAC address
Network Name	Network name (the unit's name on the network) (p.108)
Status	The connection status of the NETWORK jack

System

Displays the system information on the unit.

Remote ID	The unit's remote control ID setting (p.116)
TV Format	The unit's video signal type (p.117)
Speaker Impedance	The speaker impedance setting of the unit (p.116)
Tuner Freq. Step	(Asia and General models only) The FM/AM tuning frequency setting of the unit (p.117)
System ID	System ID number
Firmware Version	The version of firmware installed on the unit



- If the unit detects a newer firmware over the network, "!" (exclamation mark) appears at the upper right of the "Information" and "System" icons, and the corresponding message will be displayed in this screen. You can update the unit's firmware by pressing ENTER in this screen and following the procedure in "Updating the unit's firmware" (p.124).

Zone

Displays information about Zone2.

Input	The input source selected for Zone2
Volume	The volume for Zone2

Configuring the system settings (ADVANCED SETUP menu)

Configure the system settings of the unit while viewing the front display.

- 1 Set the unit to standby mode.
- 2 While holding down STRAIGHT on the front panel, press MAIN ZONE .

MAIN ZONE  STRAIGHT

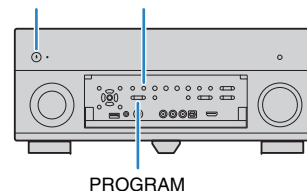

- 3 Press PROGRAM to select an item.
- 4 Press STRAIGHT to select a setting.
- 5 Press MAIN ZONE  to set the unit to standby mode and turn it on again.

The new settings take effect.

ADVANCED SETUP menu items

Item	Function	Page
SPEAKER IMP.	Changes the speaker impedance setting.	116
REMOTE SENSOR	Turns on/off of the remote control sensor on the main unit.	116
REMOTE CON AMP	Selects the unit's remote control ID.	116
TUNER FRQ STEP	(Asia and General models only) Changes the FM/AM tuning frequency setting.	117
TV FORMAT	Switches the video signal type.	117
MONITOR CHECK	Removes the limitation on HDMI video output.	117
RECOV./BACKUP	Creates backup of the settings of the unit, or recovers the settings from the backup.	118
INITIALIZE	Restores the default settings.	118
FIRM UPDATE	Updates the firmware.	118
VERSION	Checks the version of firmware currently installed on the unit.	118

Changing the speaker impedance setting (SPEAKER IMP.)



Change the unit's speaker impedance settings depending on the impedance of the speakers connected.

Settings

6 Ω MIN	Select this option when you connect 6-ohm speakers to the unit. You can also use 4-ohm speakers as the front speakers.
8 Ω MIN (default)	Select this option when you connect 8-ohm or higher speakers to the unit.

Turning on/off the remote control sensor (REMOTE SENSOR)



Turn on/off the remote control sensor on the main unit. While the remote control sensor is turned off, you cannot control the unit from the remote control.

Settings

ON (default)	Turns on the remote control sensor.
OFF	Turns off the remote control sensor.

Selecting the remote control ID (REMOTE CON AMP)



Change the unit's remote control ID so that it matches the remote control's ID (default: ID1). When using multiple Yamaha AV receivers, you can set each remote control with a unique remote control ID for its corresponding receiver.

Settings

ID1 (default), ID2

■ Changing the remote control ID of the remote control

Perform each of the following steps within 1 minute. Otherwise, the setting will be automatically canceled.

- 1 Press **CODE SET** on the remote control.
- 2 Press **RECEIVER**.
- 3 Use the numeric keys to enter “5019” (ID1) or “5020” (ID2).

Once the remote control ID is registered successfully, SOURCE blinks twice.

If it blinks six times, registration failed. Repeat from Step 1.



- The registered remote control codes (p.119) are not cleared even if you change the remote control ID.

Changing the FM/AM tuning frequency setting (TUNER FRQ STEP)

(Asia and General models only)



Change the FM/AM tuning frequency setting of the unit depending on your country or region.

Settings

FM100/AM10	Select this when you want to adjust the FM frequency by 100-kHz steps and AM by 10-kHz steps.
FM50/AM9 (default)	Select this when you want to adjust the FM frequency by 50-kHz steps and AM by 9-kHz steps.

Switching the video signal type (TV FORMAT)



Switch the video signal type of the unit so that it matches to the format of your TV.

Settings

NTSC, PAL

Default

U.S.A., Canada, Korea and General models: NTSC

Other models: PAL

Removing the limitation on HDMI video output (MONITOR CHECK)



The unit automatically detects resolutions supported by a TV connected to the HDMI OUT jack.

Disable the monitor check function if you want to specify a resolution in "Resolution" (p.105) when the unit cannot detect the TV's resolution or when you want to specify a different resolution than the detected resolution.

Settings

YES (default)	Enables the monitor check function. (Outputs video signals with a resolution supported by the TV only.)
SKIP	Disables the monitor check function. (Outputs video signals with a specified resolution regardless of compatibility with the TV.)



- Reset to "YES" if the unit becomes inoperable because video from the unit cannot be displayed on the TV after "MONITOR CHECK" has been set to "SKIP".

Backing up/recovering the settings (RECOV./BACKUP)



Creates backup of the settings of the unit, or recovers the settings from the backup.

Backup/recovery procedure

- 1 Press **STRAIGHT** repeatedly to select “**BACKUP**” or “**RECOVERY**” and press **INFO** to start the process.

Choices

BACKUP	Creates backup of the settings of the unit in the internal memory.
RECOVERY	Recovers the settings of the unit from the backup (available only when backup has been created).

Note

- Do not turn off the unit during the recovery process. Otherwise, the settings may not be restored correctly.
- The backup does not contain user information (such as user accounts and passwords).

Restoring the default settings (INITIALIZE)



Restores the default settings for the unit.

Choices

VIDEO	Restores the default settings for video configurations.
ALL	Restores the default settings for the unit.
CANCEL	Does not perform an initialization.

Updating the firmware (FIRM UPDATE)



New firmware that provides additional features or product improvements will be released as needed. Updates can be downloaded from our website. If the unit is connected to the Internet, you can download the firmware via the network. For details, refer to the information supplied with updates.

Firmware update procedure

Do not perform this procedure unless firmware update is necessary. Also, make sure you read the information supplied with updates before updating the firmware.

- 1 Press **STRAIGHT** repeatedly to select “**USB**” or “**NETWORK**” and press **INFO** to start firmware update.

Choices

USB	Update the firmware using a USB memory device.
NETWORK	Update the firmware via the network.



- If the unit detects newer firmware over the network, the corresponding message will be displayed after **ON SCREEN** is pressed. In this case, you can also update the unit's firmware by following the procedure in “Updating the unit's firmware” (p.124).

Checking the firmware version (VERSION)



Check the version of firmware currently installed on the unit.



- You can also check the firmware version in “System” (p.115) in the “Information” menu.
- It may take a while until the firmware version is displayed.

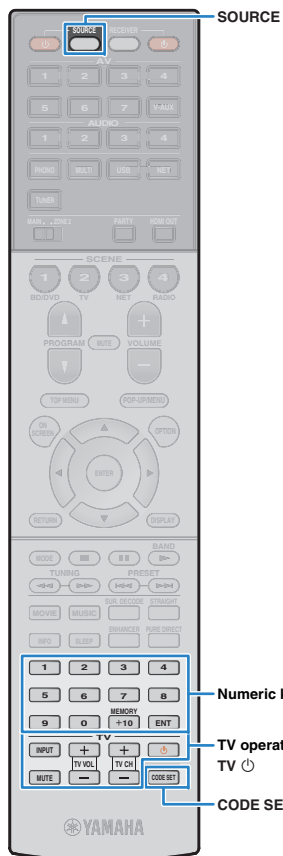

Controlling external devices with the remote control

You can use the unit's remote control to operate external devices (such as BD/DVD players) if you have registered the remote control code of the external device.



- You cannot control an external device that does not have a remote control sensor.
- Ensure that the remote control ID of the external device is set to "ID1". If any other ID is selected, the remote control operations may not work properly.
- If the unit's remote control is without batteries for more than 2 minutes, the registered codes may be cleared. If this happens, insert new batteries and register the codes again.



- Under the unit's default settings, the amplifier code (Yamaha: 5098) is set for all the input selection keys. With this setting, you can control HDMI Control-compatible devices connected to the unit with the remote control. (This function may not work depending on the specification of the external device.)

Registering the remote control code for a TV

You can use the unit's remote control to operate a TV if you have registered its remote control code.



- You can also register your TV's remote control code to the unit's input selection keys (p.120). This would allow you to use the cursor keys or numeric keys to operate the TV (this function may not be available on some TV models).
- (China, Korea, U.K. and Europe models only)
You can also assign a function to each key using the learning function (p.121).

1 Use "Remote Control Code Search" in the CD-ROM to find your TV's remote control code.



- If there are multiple remote control codes, register the first code in the list. If that does not work, try the other codes.

2 Press CODE SET.

SOURCE blinks twice.

Perform each of the following steps within 1 minute. Otherwise, the setting will be canceled. If this happens, repeat from Step 2.

3 Press TV .

4 Use the numeric keys to enter the 4-digit remote control code.

Once the remote control code is successfully registered, SOURCE blinks twice.

If it blinks six times, registration has failed. Repeat from Step 2.

TV operations

Once you have registered the remote control code for your TV, you can control it using the TV operation keys, regardless of the input source selected on the unit.

	INPUT	Switches the video inputs of the TV.
	MUTE	Mutes the audio output of the TV.
TV operation keys	TV VOL	Adjust the volume of the TV.
	TV CH	Switch the channels of the TV.
	TV 	Turns on/off the TV.

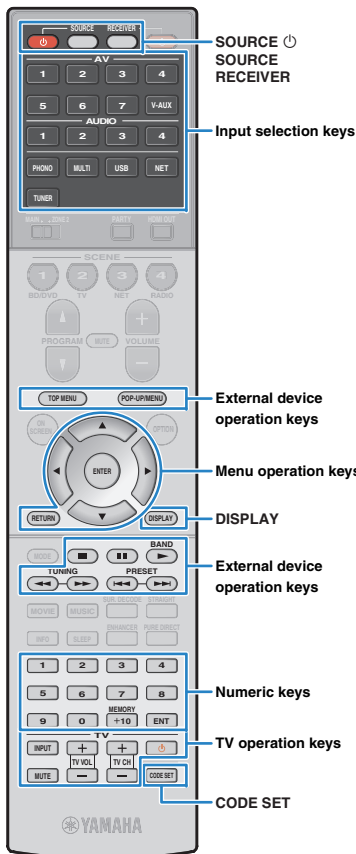

Registering the remote control codes for playback devices

You can use the unit's remote control to operate playback devices if you have registered their remote control codes. You can also use the input selection keys to change the playback devices that are controlled by the remote control, because their remote control codes are assigned to the input selection keys.



- (China, Korea, U.K. and Europe models only)
You can also assign a function to each key using the learning function (p.121).

1 Use “Remote Control Code Search” in the CD-ROM to find the remote control code for your playback device.



- If there are multiple remote control codes, register the first code in the list. If that does not work, try the other codes.

2 Press CODE SET.

SOURCE blinks twice.

Perform each of the following steps within 1 minute. Otherwise, the setting will be canceled. If this happens, repeat from Step 2.

3 Press the input selection key.

For example, press AV 1 to set the remote control code for the playback device connected to the AV 1 jack.

4 Use the numeric keys to enter the 4-digit remote control code.

Once the remote control code is registered successfully, SOURCE blinks twice.

If it blinks six times, registration has failed. Repeat from Step 2.



- For details on how to register a remote control code to a SCENE key, refer to “Configuring scene assignments” (p.50).

Playback device operations

Once you have registered the remote control code for your playback device, you can control it using the following keys after selecting the input source or scene.



- By pressing SOURCE or RECEIVER, you can switch the devices (the unit or external device) that are operated by the menu operation keys, DISPLAY and numeric keys. You can operate the unit after pressing RECEIVER (lights up in orange), and an external device after pressing SOURCE (lights up in green). For example, if you register the remote control code of your external device on TUNER, you can operate the unit's built-in FM/AM radio after pressing RECEIVER and the external device after pressing SOURCE.

SOURCE		Turns on/off the playback device.
Menu operation keys	Cursor keys	Select an item.
	ENTER	Confirms a selected item.
	RETURN	Returns to the previous screen.
DISPLAY		Switches information on the display.
	TOP MENU	Displays the top menu.
	POP-UP/MENU	Displays the pop-up menu.
		Stops playback.
		Stops playback temporarily.
External device operation keys		Starts playback of the selected song/video.
		Searches forward/backward (by holding down).
		Searches forward/backward (by holding down).
		Skips forward/backward.
		Skips forward/backward.
Numeric keys		Enter numerical values.
TV operation keys		Control the TV (p.119).



- These keys work only if the corresponding function is available on your playback device and if the device can be operated with an infrared remote control.

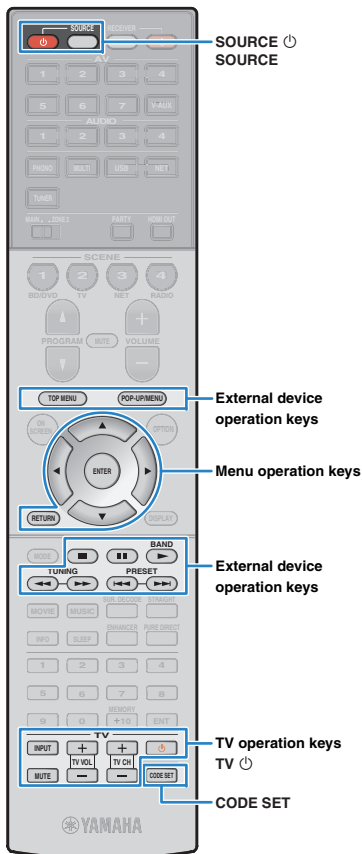

Programming from other remote controls (learning)

(China, Korea, U.K. and Europe models only)

The remote control of the unit can receive remote control signals from other infrared remote controls and learn the remote control operation. If you cannot find a remote control code for your playback device or if any key on the remote control does not work after you register the remote control code, use the learning function to assign a function to each key.

1 Press CODE SET.

SOURCE blinks twice.

Perform each of the following steps within 1 minute. Otherwise, the setting will be canceled. If this happens, repeat from Step 1.

2 Press one of the following keys depending on the type of your device.

For playback device: press the input selection key (corresponding to the input jacks where the device is connected).

For TV: press TV $\text{\textcircled{TV}}$.

3 Use the numeric keys to enter "9990".

4 Aim the infrared transmitters of the remote controls at each other.

5 Perform the following steps within 10 seconds.

- ① On the unit, press one of the following keys to which you want to assign a function.

For playback device: SOURCE $\text{\textcircled{S}}$, menu operations keys, external device operation keys

For TV: TV operation keys

- ② On the external device, press the key from which the operation is learned.

Once the operation is learned successfully, SOURCE blinks twice.

If it blinks six times, learning has failed. Repeat Step 5.

6 Repeat step 5 until all desired operations are learned.

7 Press CODE SET.

SOURCE blinks once.

Note

- If you press RECEIVER in step 2, you can assign functions of an external receiver to the menu operation keys, external device operation keys or numeric keys. However, it makes these keys to control the unit impossible. If you need to restore the remote control code for the unit, perform the following steps.

- ① Press CODE SET.
- ② Press RECEIVER.
- ③ Use the numeric keys to enter "9992".

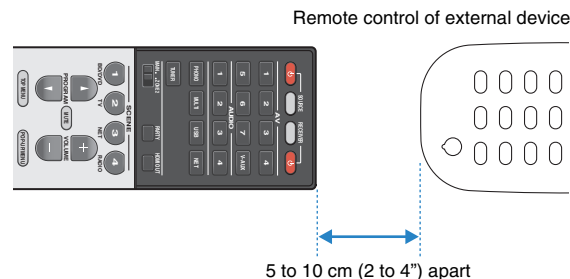

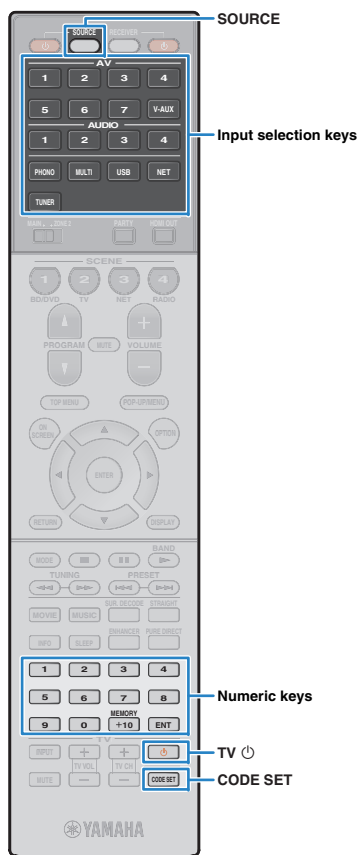

Clearing functions learned from other remote controls

(China, Korea, U.K. and Europe models only)

■ Clearing the assignment for each key

1 Press CODE SET.

SOURCE blinks twice.

Perform each of the following steps within 1 minute. Otherwise, the setting will be canceled. If this happens, repeat from Step 1.

2 Press one of the following keys to select the device for which key assignments will be cleared.

For playback device: press the input selection key.

For TV: press TV \odot .

3 Use the numeric keys to enter “9991”.

4 Press the key that you want to reset.

Once the key assignment is cleared successfully, SOURCE blinks twice.

If it blinks six times, clearing failed. Repeat from Step 2.

5 Repeat step 4 until all desired key assignments are cleared.

6 Press CODE SET.

SOURCE blinks once.

■ Clearing the assignments for each input source

1 Press CODE SET.

SOURCE blinks twice.

Perform each of the following steps within 1 minute. Otherwise, the setting will be canceled. If this happens, repeat from Step 1.

2 Press one of the following keys to select the device for which key assignments will be cleared.

For playback device: press the input selection key.

For TV: press TV \odot .

3 Use the numeric keys to enter “9992”.

Once the key assignment is cleared successfully, SOURCE blinks twice.

If it blinks six times, clearing failed. Repeat from Step 1.

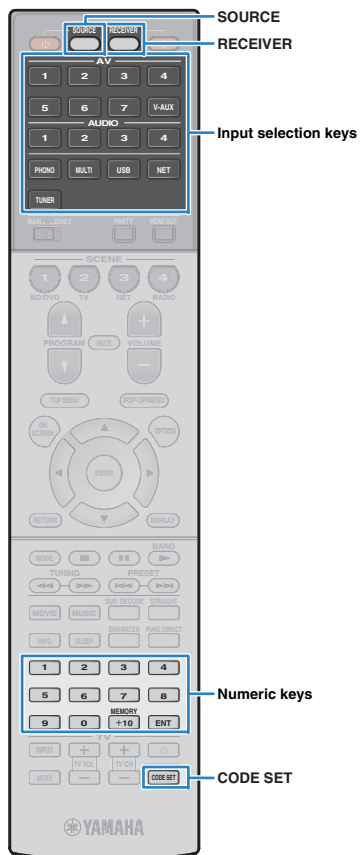

Resetting remote control codes

You can reset a remote control code registered to each input selection key.

1 Press CODE SET.

SOURCE blinks twice.

Perform each of the following steps within 1 minute. Otherwise, the setting will be canceled. If this happens, repeat from Step 1.

2 Press the input selection key.

3 Use the numeric keys to enter “5098”.

Once the remote control code is reset successfully, SOURCE blinks twice.

If it blinks six times, resetting has failed. Repeat from Step 1.

To reset the remote control to factory default settings

- ① Press CODE SET.
- ② Press RECEIVER.
- ③ Use the numeric keys to enter “9981”.



Cursor keys
ENTER

Updating the unit's firmware

New firmware that provides additional features or product improvements will be released as needed. If the unit is connected to the Internet, you can download the firmware via the network and update it.

Note

- Do not operate the unit or disconnect the power cable or network cable during firmware update. Firmware update takes about 20 minutes or more (depending on your Internet connection speed).



- You can also update the firmware using the USB memory device from the "ADVANCED SETUP" menu (p.118).

A firmware update is available if the following message is displayed after ON SCREEN is pressed.

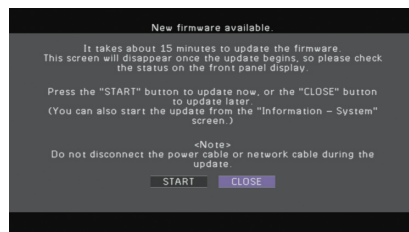

- Read the on-screen description.
- To start the firmware update, use the cursor keys to select "START" and press ENTER.
The on-screen display turns off.
- If "UPDATE SUCCESS PLEASE POWER OFF!" appears on the front display, press MAIN ZONE on the front panel.

The firmware update is complete.



- If you want to update the firmware later, select "CLOSE" in Step 2. "!" (exclamation mark) appears at the upper right of the "Information" and "System" icons, and a message will be displayed in the "System" screen (p.115). You can update the unit's firmware by pressing ENTER in the "System" screen.

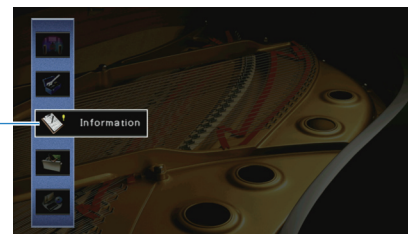

Information icon

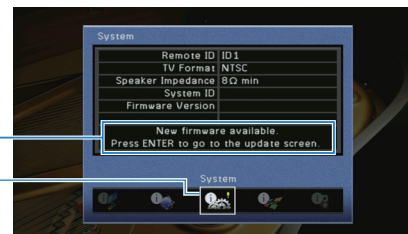

Message

System Icon

APPENDIX

Frequently asked questions

The new speaker system does not provide an ideal sound balance...

If you have changed speakers or have a new speaker system, use “Auto Setup” to optimize the speaker settings again (p.40). If you want to adjust the speaker settings manually, use “Manual Setup” in the “Setup” menu (p.100).

Since we have small children, we want to set limitations on the volume control...

If a small child accidentally operates the controls on the main unit or remote control, the volume may suddenly increase. This may also cause injury or damage the unit or speakers. We recommend using “Max Volume” in the “Setup” menu to set the maximum volume level for the unit in advance (p.104). You can also set the maximum volume for Zone2 (p.109).

I am occasionally startled by a sudden loud sound when turning on the unit...

By default, the volume level when the unit last entered standby mode is automatically applied. If you want to fix the volume, use “Initial Volume” in the “Setup” menu to set the volume to be applied when the receiver is turned on (p.104). You can also set the initial volume for Zone2 (p.109).

I made HDMI connections but HDMI Control does not work at all...

To use HDMI Control, you need to perform the HDMI Control link setup (p.137). After connecting HDMI Control-compatible devices (such as BD/DVD players) to the unit, enable HDMI Control on each device and perform the HDMI Control link setup. This setup is required every time you add a new HDMI Control-compatible device to your system. For information on how HDMI Control works between your TV and playback devices, refer to the instruction manuals for each device.

I want to turn off the on-screen messages displayed during operations...

By default, short messages are displayed on the TV screen when the unit is operated (such as input selection and volume adjustment). If the short messages bother you when you are watching movies or sports, configure “Short Message” (p.111) in the “Setup” menu to turn off the short messages.

I want to prevent accidental changes to the settings...

You can protect the settings configured on the unit (such as speaker settings) by utilizing “Memory Guard” in the “Setup” menu (p.112).

The unit’s remote control is simultaneously controlling another Yamaha product as well as the unit...

When using multiple Yamaha products, the remote control may work on another Yamaha product or another remote control may work on the unit. If this happens, register different remote control IDs for the devices that you want to control with each remote control (p.116).

Troubleshooting



Refer to the table below when the unit does not function properly.

If the problem you are experiencing is not listed below or if the instructions below do not help, turn off the unit, disconnect the power cable, and contact the nearest authorized Yamaha dealer or service center.

First, check the following:

- ① **The power cables of the unit, TV and playback devices (such as BD/DVD players) are connected to AC wall outlets securely.**
- ② **The unit, subwoofer, TV and playback devices (such as BD/DVD players) are turned on.**
- ③ **The connectors of each cable are securely inserted in to jacks on each device.**

Power and system

Problem	Cause	Remedy
The power does not turn on.	The protection circuitry has been activated three times consecutively. When the unit is in this condition, the standby indicator on the unit blinks if you try to turn on the power.	As a safety precaution, capability to turn on the power is disabled. Contact your nearest Yamaha dealer or service center to request repair.
The power does not turn off.	The internal microcomputer has frozen, due to an external electric shock (such as lightning or excessive static electricity) or to a drop in the power supply voltage.	Hold down MAIN ZONE  on the front panel for more than 10 seconds to initialize and reboot the unit. (If the problem persists, disconnect the power cable from the AC wall outlet and plug it again.)
The power turns off (standby mode) immediately.	The unit was turned on while a speaker cable was shorted.	Twist the bare wires of each speaker cable firmly and reconnect to the unit and speakers (p.18).
The unit enters standby mode automatically.	The sleep timer worked.	Turn on the unit and start playback again.
	The auto-standby function kicked in because the unit was not used for the specified time.	To disable the auto-standby function, set "Auto Power Down" in the "Setup" menu to "Off" (p.113).
	The speaker impedance setting is incorrect.	Set the speaker impedance to match your speakers (p.116).
	The protection circuitry has been activated because of a short circuit.	Twist the bare wires of each speaker cable firmly and reconnect to the unit and speakers (p.18).
The unit is not reacting.	The protection circuitry has been activated because the volume of the unit is too high.	Turn down the volume. If "ECO Mode" in the "Setup" menu is set to "On", set it to "Off" (p.113).
	The internal microcomputer is frozen, due to an external electric shock (such as lightning or excessive static electricity) or to a drop in the power supply voltage.	Hold down MAIN ZONE  on the front panel for more than 10 seconds to initialize and reboot the unit. (If the problem persists, disconnect the power cable from the AC wall outlet and plug it again.)

Audio

Problem	Cause	Remedy
No sound.	Another input source is selected.	Select an appropriate input source with the input selection keys.
	Signals that the unit cannot reproduce are being input.	Some digital audio formats cannot be played back on the unit. To check the audio format of the input signal, use "Audio Signal" in the "Information" menu (p.114).
	The cable connecting the unit and playback device is defective.	If there is no problem with the connection, replace with another cable.
The volume cannot be increased.	The maximum volume is set.	Use "Max Volume" in the "Setup" menu to adjust the maximum volume (p.104).
	A device connected to the output jacks of the unit is not turned on.	Turn on all devices connected to the output jacks of the unit.
No sound is coming from a specific speaker.	The playback source does not contain a signal for the channel.	To check it, use "Audio Signal" in the "Information" menu (p.114).
	The currently selected sound program/decoder does not use the speaker.	To check it, use "Test Tone" in the "Setup" menu (p.103).
	Audio output of the speaker is disabled.	Perform "Auto Setup" (p.40) or use "Configuration" in the "Setup" menu to change the speaker settings (p.100).
	The volume of the speaker is set too low.	Perform "Auto Setup" (p.40) or use "Level" in the "Setup" menu to adjust the speaker volume (p.102).
	The speaker cable connecting the unit and the speaker is defective.	If there is no problem with the connection, replace with another speaker cable.
	The speaker is malfunctioning.	To check it, replace with another speaker. If the problem persists, the unit may be malfunctioning.
No sound is coming from the surround back speaker.	The extended surround is disabled.	Use "Extended Surround" in the "Option" menu to select a decoder to be used (p.86).
No sound is coming from the subwoofer.	The playback source does not contain LFE or low-frequency signals.	To check it, set "Extra Bass" in the "Setup" menu to "On", in order to output the front channel low-frequency components from the subwoofer (p.102).
	Subwoofer output is disabled.	Perform "Auto Setup" (p.40) or set "Subwoofer" in the "Setup" menu to "Use" (p.101).
	The volume of the subwoofer is too low.	Adjust the volume on the subwoofer.
	The subwoofer has been turned off by its auto-standby function.	Disable the auto-standby function of the subwoofer or adjust its sensitivity level.
No sound from the playback device (connected to the unit with HDMI).	The TV does not support HDCP (High-bandwidth Digital Content Protection).	Refer to the instruction manuals for the TV and check the TV's specifications.
	The unit is set not to output audio input through HDMI jacks from the SPEAKERS terminals.	In "Audio Output" in the "Setup" menu, set "Amp" to "On" (p.106).
	The number of devices connected to the HDMI OUT jack exceeds the limit.	Disconnect some of the HDMI devices.

Problem	Cause	Remedy
No sound from the TV (when HDMI Control is used).	The TV is set to output audio from the TV speakers.	Change the audio output setting on your TV so that the TV audio is output from the speakers connected to the unit.
	(If the TV is connected to the unit with an audio cable) The TV audio input setting does not match the actual connection.	Use "TV Audio Input" in the "Setup" menu to select the correct audio input jack (p.106).
	(If you are trying to use ARC) ARC is disabled on the unit or TV.	Set "ARC" in the "Setup" menu to "On" (p.106). Also, enable ARC on the TV.
Only the front speakers work on multichannel audio.	The playback device is set to output 2-channel audio (such as PCM) only.	To check it, use "Audio Signal" in the "Information" menu (p.114). If necessary, change the digital audio output setting on the playback device.
Noise/hum is heard.	The unit is too close to another digital or radio frequency device.	Move the unit further away from the device.
	The cable connecting the unit and playback device is defective.	If there is no problem with the connection, replace with another cable.
The sound is distorted.	The volume of the unit is too high.	Turn down the volume. If "ECO Mode" in the "Setup" menu is set to "On", set it to "Off" (p.113).
	A device connected to the unit's output jacks is not turned on.	Turn on all devices connected to the unit's output jacks.

Video

Problem	Cause	Remedy
No video.	Another input source is selected on the unit.	Select an appropriate input source with the input selection keys.
	Another input source is selected on the TV.	Switch the TV input to display the video from the unit.
	The video signal output from the unit is not supported by the TV.	Set "MONITOR CHECK" in the "ADVANCED SETUP" menu to "YES" (p.117).
	The cable connecting the unit and TV (or playback device) is defective.	If there is no problem with the connection, replace with another cable.
No video from the playback device (connected to the unit with HDMI).	The input video signal (resolution) is not supported by the unit.	To check the information about the current video signal (resolution), use "Video Signal" in the "Information" menu (p.114). For information about video signals supported by the unit, see "HDMI signal compatibility" (p.138).
	The TV does not support HDCP (High-bandwidth Digital Content Protection).	Refer to the instruction manuals for the TV and check the TV's specifications.
	The number of devices connected to the HDMI OUT jack is over the limit.	Disconnect some of the HDMI devices.
The menu of the unit is not displayed on the TV.	The TV is not connected to the unit via HDMI.	You can display the menu of the unit on the TV only when they are connected with an HDMI cable. If necessary, use an HDMI cable to connect them (p.25 to 28).
	Another input source is selected on the TV.	Switch the TV input to display the video from the unit (HDMI OUT jack).

FM/AM radio

Problem	Cause	Remedy
FM radio reception is weak or noisy.	There is multi-path interference.	Adjust the FM antenna height or orientation, or place it in a different location.
	Your area is too far from the FM station transmitter.	(U.S.A. model only) Set "Audio Mode" in the "Option" menu to "Mono" to select monaural FM radio reception (p.87).
		(Except for U.S.A. model) Set "FM Mode" in the "Option" menu to "Mono" to select monaural FM radio reception (p.88).
		Use an outdoor FM antenna. We recommend using a sensitive multi-element antenna.
AM radio reception is weak or noisy.	The noises may be caused by fluorescent lamps, motors, thermostats, or other electrical equipment.	It is difficult to completely eliminate noise. It may be reduced by using an outdoor AM antenna.
Radio stations cannot be selected automatically.	Your area is too far from the FM station transmitter.	Select the station manually (p.57).
		Use an outdoor antenna. We recommend using a sensitive multi-element antenna.
	The AM radio signal is weak.	Adjust the AM antenna orientation.
		Select the station manually (p.57).
		Use an outdoor AM antenna. Connect it to the ANTENNA (AM) jack together with the supplied AM antenna.
AM radio stations cannot be registered as presets.	Auto Preset has been used.	Auto Preset is for registering FM radio stations and HD Radio station (U.S.A. model only) only. Register AM radio stations manually (p.58).
The unit does not receive HD Radio signals. (U.S.A. model only)	The unit is in the monaural reception mode.	Set "Audio Mode" in the "Option" menu to "Auto" (p.87).

USB and network

Problem	Cause	Remedy
The unit does not detect the USB device.	The USB device is not connected to the USB jack securely.	Turn off the unit, reconnect your USB device, and turn the unit on again.
	The file system of the USB device is not FAT16 or FAT32.	Use a USB device with FAT16 or FAT32 format.
Folders and files in the USB device cannot be viewed.	The data in the USB device is protected by the encryption.	Use a USB device without an encryption function.
The files in the USB device cannot be played back continuously.	Files not supported by the unit exist in the selected folder.	If the unit detects a series of unsupported files (such as images and hidden files) during playback, playback stops automatically. Do not store the unsupported files in the playback folder.
The network feature does not function.	The network parameters (IP address) have not been obtained properly.	Enable the DHCP server function on your router and set "DHCP" in the "Setup" menu to "On" on the unit (p.107). If you want to configure the network parameters manually, check that you are using an IP address which is not used by other network devices in your network (p.107).
The unit does not detect the PC.	The media sharing setting is not correct.	Configure the sharing setting and select the unit as a device to which music contents are shared (p.71).
	Some security software installed on your PC is blocking the access of the unit to your PC.	Check the settings of security software installed on your PC.
	The unit and PC are not in the same network.	Check the network connections and your router settings, and then connect the unit and the PC to the same network.
The files in the PC cannot be viewed or played back.	The files are not supported by the unit or the media server.	Use the file format supported by both the unit and the media server. For information about the file formats supported by the unit, see "Playing back music stored on media servers (PCs/NAS)" (p.71).
The files in the PC cannot be played back continuously.	Files not supported by the unit exist in the selected folder.	If the unit detects a series of unsupported files (such as images and hidden files) during playback, playback stops automatically. Do not store the unsupported files in the playback folder.
The Internet radio cannot be played.	The selected Internet radio station is currently not available.	There may be a network problem at the radio station, or the service may have been stopped. Try the station later or select another station.
	The selected Internet radio station is currently broadcasting silence.	Some Internet radio stations broadcast silence at certain of times of the day. Try the station later or select another station.
	Access to the network is restricted by the firewall settings of your network devices (such as the router).	Check the firewall settings of your network devices. The Internet radio can be played only when it passes through the port designated by each radio station. The port number varies depending on the radio station.

Remote control

Problem	Cause	Remedy
The unit cannot be controlled using the remote control.	The unit is out of the operating range.	Use the remote control within the operating range (p.5).
	The batteries are weak.	Replace with new batteries.
	The unit's remote control sensor is exposed to direct sunlight or strong lighting.	Adjust the lighting angle, or reposition the unit.
	The remote control is set to control external devices.	Press RECEIVER to set the remote control to control the unit (the key lights up in orange).
	The remote control IDs of the unit and the remote control are not identical.	Change the remote control ID of the unit or the remote control (p.116).
External devices cannot be controlled using the remote control.	The remote control is set to control the unit.	Press SOURCE to set the remote control to control external devices (the key lights up in green).
	The corresponding remote control code is not set properly.	Set the remote control code again (p.119). Even if the remote control code is registered properly, some products may not respond to the remote control.
The remote control does not learn new functions. (China, Korea, U.K. and Europe models only)	The batteries of the remote control of the unit and/or the external device are weak.	Replace with new batteries.
	The distance between the two remote controls is not appropriate.	Place the remote controls at a proper distance (p.121).
	The signal coding or modulation of the other remote control is not compatible with the remote control.	Learning is impossible in this case.
	Memory capacity is full.	Clear unnecessary assignments to free some memory space for new functions (p.122).

Error indications on the front display

Message	Cause	Remedy
Access denied	Access to the PC is denied.	Configure the sharing settings and select the unit as a device to which music contents are shared (p.71).
Access error	The unit cannot access the USB device.	Turn off the unit and reconnect your USB device. If the problem persists, try another USB device.
	The unit cannot access the iPod.	Turn off the iPod and turn it on again.
	The connected iPod is not supported by the unit.	Use an iPod supported by the unit (p.64).
	There is a problem with the signal path from the network to the unit.	Make sure your router and modem are turned on. Check the connection between the unit and your router (or hub) (p.35).
Check SP Wires	The speaker cables short circuit.	Twist the bare wires of the cables firmly and connect to the unit and speakers properly.
Internal Error	An internal error has occurred.	Contact the nearest authorized Yamaha dealer or service center.
No content	There are no playable files in the selected folder.	Select a folder that contains files supported by the unit.
No device	The unit cannot detect the USB device.	Turn off the unit and reconnect your USB device. If the problem persists, try another USB device.
	The unit cannot detect the iPod.	Turn off the iPod and then turn it on again.
Please wait	The unit is preparing for connecting to the network.	Wait until the message disappears. If the message stays more than 3 minutes, turn off the unit and turn it on again.
RemID Mismatch	The remote control IDs of the unit and the remote control are not identical.	Change the remote control ID of the unit or the remote control (p.116).
Remote Off	The unit cannot be operated from remote control because the remote control sensor on the main unit is turned off.	Use the controls on the front panel. To use the remote control, set "REMOTE SENSOR" in the "ADVANCED SETUP" menu to "ON" (p.116).
Unable to play	The unit cannot play back the songs stored on the USB device for some reasons.	Check the song data. If it cannot be played on another device, the song data may be defective.
	The unit cannot play back the songs stored on the iPod for some reason.	Check the song data. If it cannot be played on the iPod itself, the song data or storage area may be defective.
	The unit cannot play back the songs stored on the PC for some reason.	Check if the format of files you are trying to play is supported by the unit. For information about the formats supported by the unit, see "Playing back music stored on media servers (PCs/NAS)" (p.71). If the unit supports the file format, but still cannot play back any files, the network may be overloaded with heavy traffic.
USB Overloaded	An overcurrent is flowing through the USB device.	Turn off the unit and reconnect your USB device. If the problem persists, try another USB device.

Audio information

■ Audio decoding format

Dolby Digital

Dolby Digital is a compressed digital audio format developed by Dolby Laboratories, Inc. that supports 5.1-channel audio. This technology is used for audio on most DVD discs.

Dolby Digital EX

Dolby Digital EX creates total 6.1-channel audio from 5.1-channel sources that are recorded with Dolby Digital Surround EX. This decoder adds a surround back sound to the original 5.1-channel sound.

Dolby Digital Plus

Dolby Digital Plus is a compressed digital audio format developed by Dolby Laboratories, Inc. that supports 7.1-channel audio. Dolby Digital Plus remains fully compatible with the existing multichannel audio systems that support Dolby Digital. This technology is used for audio on BD (Blu-ray discs).

Dolby Pro Logic II

Dolby Pro Logic II enables 5-channel playback from 2-channel sources. There are three modes available: "Music mode" for music sources, "Movie mode" for movie sources, and "Game mode" for game sources.

Dolby Pro Logic IIx

Dolby Pro Logic IIx enables 7-channel playback from 2-channel or multichannel sources. There are three modes available: "Music mode" for music sources, "Movie mode" for movie sources and "Game mode" for game sources (for 2-channel sources only).

Dolby TrueHD

Dolby TrueHD is an advanced lossless audio format developed by Dolby Laboratories, Inc. to offer a high-definition home theater experience with the quality of the studio master. Dolby TrueHD can carry up to eight channels of 96 kHz/24-bit audio (up to six channels of 192 kHz/24-bit audio) simultaneously. This technology is used for audio on BD (Blu-ray discs).

DTS 96/24

DTS 96/24 is a compressed digital audio format that supports 5.1-channel and 96 kHz/24-bit audio. This format remains fully compatible with the existing multichannel audio systems that support DTS Digital Surround. This technology is used for music DVDs, etc.

DTS Digital Surround

DTS Digital Surround is a compressed digital audio format developed by DTS, Inc. that supports 5.1-channel audio. This technology is used for audio on most DVD discs.

DTS-ES

DTS-ES creates total 6.1-channel audio from 5.1-channel sources that are recorded with DTS-ES. This decoder adds a surround back sound to the original 5.1-channel sound. In the DTS-ES Matrix 6.1 format, a surround back sound is recorded in the surround channels, and in the DTS-ES Discrete 6.1 format, a discrete surround back channel is recorded.

DTS Express

DTS Express is a compressed digital audio format that supports 5.1-channel audio and allows a higher compression rate than the DTS Digital Surround format developed by DTS, Inc. This technology is developed for audio streaming services on the Internet and secondary audio on BD (Blu-ray discs).

DTS-HD High Resolution Audio

DTS-HD High Resolution Audio is a compressed digital audio format developed by DTS, Inc. that supports 7.1-channel and 96 kHz/24-bit audio. DTS-HD High Resolution Audio remains fully compatible with the existing multichannel audio systems that support DTS Digital Surround. This technology is used for audio on BD (Blu-ray discs).

DTS-HD Master Audio

DTS-HD Master Audio is an advanced lossless audio format developed to offer a high-definition home theater experience with the quality of the studio master by DTS, Inc. DTS-HD Master Audio can carry up to eight channels of 96 kHz/24-bit audio (up to six channels of 192 kHz/24-bit audio) simultaneously. This technology is used for audio on BD (Blu-ray discs).

DTS Neo:6

DTS Neo:6 enables 6-channel playback from 2-channel sources. There are two modes available: "Music mode" for music sources and "Cinema mode" for movie sources. This technology provides discrete full-bandwidth matrix channels of surround sound.

DSD (Direct Stream Digital)

DSD (Direct Stream Digital) technology stores audio signals on digital storage media, such as SACD (Super Audio CDs). The signals are stored at a high-frequency sampling rate of 2.8224 MHz. The highest frequency response is equal to or higher than 100 kHz, with a dynamic range of 120 dB. This technology offers better audio quality than that used for CDs.

FLAC

FLAC is a file format for lossless audio data compression. FLAC is inferior to lossy compressed audio formats in compression rate but provides higher audio quality.

MP3

One of the compressed digital audio format used by MPEG. With psychoacoustic technologies, this compression method achieves a high compression rate. Reportedly, it is capable of compressing data quantity by about 1/10 maintaining a certain level of audio quality.

MPEG-4 AAC

An MPEG-4 audio standard. It is used for mobile telephones, portable audio players, and audio streaming services on Internet because it allows a high compression rate of data while maintaining better audio quality than MP3.

PCM (Pulse Code Modulation)

PCM is a signal format under which an analog audio signal is digitized, recorded, and transmitted. This technology is the basis of all other audio format. This technology is used as a lossless audio format called Linear PCM for audio on a variety of media, including CDs and BD (Blu-ray discs).

Sampling frequency/Quantization bit

Sampling frequency and quantization bits indicate the quantity of information when an analog audio signal is digitized. These values are noted as in the following example: "48 kHz/24-bit".

- **Sampling frequency**
Sampling frequency (the number of times the signal is sampled per second) is called the sampling rate. When the sampling frequency is higher, the range of frequencies that can be played back are wider.
- **Quantization bit**
The number of quantization bits indicate the degree of accuracy when converting the sound level into a numeric value. When the number of quantized bits is higher, the expression of the sound level is more accurate.

WAV

Windows standard audio file format, which defines the method of recording the digital data obtained by converting audio signals. By default, the PCM method (no compression) is used, but you can also use other compression methods.

WMA (Windows Media Audio)

One of the compressed digital audio formats developed by Microsoft Corporation. With psychoacoustic technologies, this compression method achieves a high compression rate. Reportedly, it is capable of compressing data quantity by about 1/20 maintaining a certain level of audio quality.

Others

Bi-amplification connection (Bi-amp)

A bi-amplification connection uses two amplifiers for a speaker. When you use the bi-amplification connection, the unit drives the tweeter and woofer in a speaker with the discrete amplifiers. As a consequence, the tweeter and woofer provide clear audio signal without the interference.

LFE (Low Frequency Effects) 0.1 channel

This channel reproduces low-frequency bass signals and has a frequency range from 20 Hz to 120 Hz. This channel is added to the channels for all bands with Dolby Digital or DTS to enhance low frequency audio effects. This channel is labeled 0.1 because it is limited to only low frequency audio.

Lip sync

Video output sometimes lags behind audio output due to the complexity of signal processing caused by an increase in video signal capacity. Lip sync is a technique for automatically correcting the timing lag between audio and video output.

HDMI and video information

Component video signal

With the component video signal system, the video signal is separated into the Y signal for luminance and the Pb and Pr signals for chrominance. Color can be reproduced more faithfully with this system because each of these signals is independent.

Composite video signal

With the composite video signal system, color, brightness, and synchronization data signals are combined and transmitted with a single cable.

Deep Color

Deep Color is a technology that HDMI specification supports. Deep Color increases the number of available colors within the boundaries defined by the RGB or YCbCr color space. Conventional color systems process the color using 8 bits. Deep Color processes the color with 10, 12, or 16 bits. This technology allows HDTVs and other displays to increase from millions of colors to billions of colors and eliminate on-screen color banding for smooth tonal transitions and subtle gradations between colors.

HDMI

HDMI (High-Definition Multimedia Interface) is the world-wide standard interface for digital audio/video signal transmission. This interface transmits both digital audio and digital video signals using a single cable without any loss. HDMI complies with HDCP (High-bandwidth Digital Content Protection) and provides a secure audio/video interface. For further information on HDMI, visit the HDMI website at "<http://www.hdmi.org/>".

S-video signal

With the S-video signal system, the video signal is separated into the Y signal for the luminance and the C signal for the chrominance through the S-video cable. This technology achieves more accurate color reproduction than the composite video signal system.

x.v.Color

"x.v.Color" is a technology that the HDMI specification supports. It is a more extensive color space than sRGB and allows the expression of colors that were not hitherto possible. While remaining compatible with the color gamut of sRGB standards, "x.v.Color" expands the color space, and thus can produce more vivid, natural images.

Yamaha technologies

CINEMA DSP (Digital Sound Field Processor)

Since the Dolby Surround and DTS systems were originally designed for use in movie theaters, their effect is best experienced in a theater that has many speakers designed for acoustic effects. Since home conditions (such as room size, wall material, and number of speakers) can differ so widely, it is inevitable that there are differences in the sound that you hear. Based on a wealth of actually measured data, CINEMA DSP, Yamaha's original DSP technology provides the audiovisual experience of a movie theater in your own home.

CINEMA DSP 3D

The actually measured sound field data contain the information of the height of the sound images. CINEMA DSP 3D mode achieves the reproduction of the accurate height of the sound images so that it creates the accurate and intensive 3D sound fields in a listening room.

Compressed Music Enhancer

The Compressed Music Enhancer feature compensates for missing harmonics in compression music formats (such as MP3). As a result, this technology provides improved performance for the overall sound system.

SILENT CINEMA

Yamaha has developed a natural, realistic sound effect DSP algorithm for headphones. Parameters for headphones have been set for each sound program, so that accurate representations of all the sound programs can be enjoyed on headphones.

Virtual CINEMA DSP

Virtual CINEMA DSP allows the system to virtually reproduce the sound field of the surround speakers with front left and right speakers. Even if the surround speakers are not connected, the unit creates the realistic sound field in a listening room.

Video signal flow

Video signals input from a video device to the unit are output to a TV as shown below.

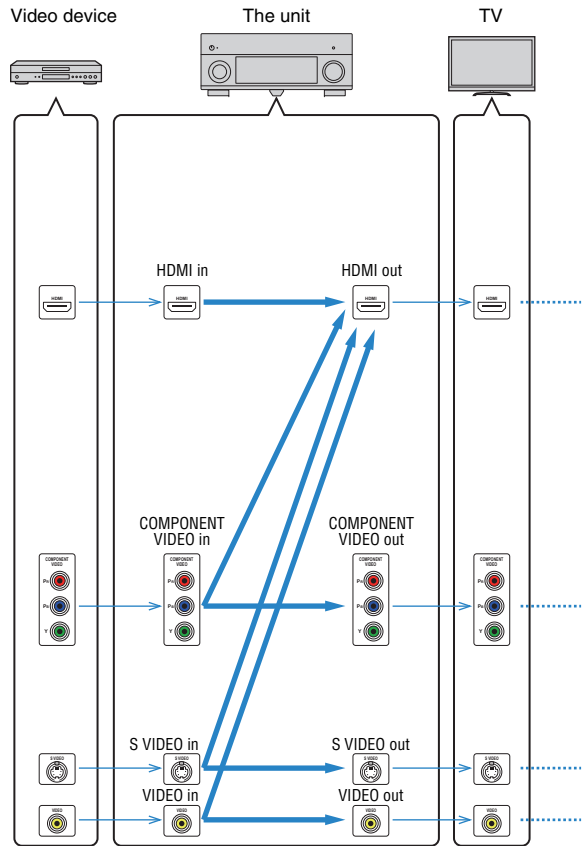

Video conversion table



- You can select the resolution and the aspect ratio applied to HDMI-output video processing in "Video Mode" (p.105) in the "Setup" menu.
- The unit does not convert 480-line and 576-line video signals interchangeably.

	Resolution	HDMI out					COMPONENT VIDEO out					S VIDEO out	VIDEO out	
		480i/576i	480p/576p	720p	1080i	1080p	4K	480i/576i	480p/576p	720p	1080i	1080p	480i/576i	480i/576i
HDMI in	480i/576i	→	→	→	→	→								
	480p/576p		→	→	→	→								
	720p			→	→	→	→							
	1080i			→	→	→	→							
	1080p/50, 60 Hz			→	→	→	→							
	1080p/24 Hz					→	→							
	4K						→							
COMPONENT VIDEO in	480i/576i	→	→	→	→	→	→							
	480p/576p		→	→	→	→		→						
	720p			→	→	→	→		→					
	1080i			→	→	→	→			→				
	1080p										→			
S VIDEO in	480i/576i	→	→	→	→	→						→		
VIDEO in	480i/576i	→	→	→	→	→							→	

→ : Available

Information on HDMI

HDMI Control

HDMI Control allows you to operate external devices via HDMI. If you connect a TV that supports HDMI Control to the unit with an HDMI cable, you can control the unit (such as power and volume) with TV remote control operations. You can also control playback devices (such as HDMI Control-compatible BD/DVD players) connected to the unit with an HDMI cable.

For details on connections, see “Connecting a TV” (p.25) and “Connecting video devices (such as BD/DVD players)” (p.31).

Operations available from the TV's remote control

- Standby synchronization
- Volume control including mute
- Switching to input audio from the TV when the TV input is switched to its built-in tuner
- Switching to input video/audio from the selected playback device
- Switching between audio output devices (the unit or TV speaker)

(Example)

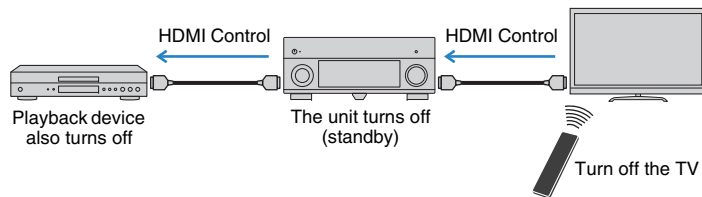

Operations available from the unit's remote control

- Starting playback on the playback device and turning on the TV with a scene selection (p.49)
- Switching the TV input to display the on-screen menu (when ON SCREEN is pressed)
- Controlling the playback device (playback and menu operations) without registering remote control codes (p.120)

(Example)

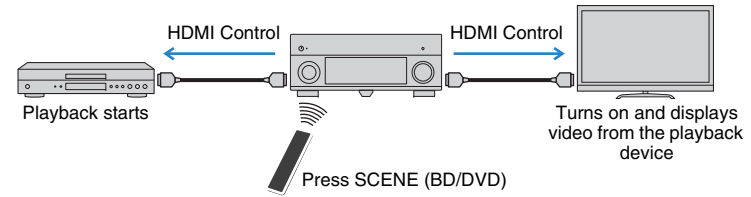

To use HDMI Control, you need to perform the following HDMI Control link setup after connecting the TV and playback devices.



- This setup is required every time you add a new HDMI Control-compatible device to your system.

- 1 Turn on the unit, TV, and playback devices.**
- 2 Enable HDMI Control on the unit, TV, and playback devices (such as HDMI Control-compatible BD/DVD players).**

To enable HDMI Control on the unit, set “HDMI Control” (p.106) in the “Setup” menu to “On” and configure the related items (“TV Audio Input”, “ARC”, and “Standby Sync”).
- 3 Turn off the main power of the TV and then turn off the unit and playback devices.**
- 4 Turn on the unit and playback devices and then turn on the TV.**
- 5 Switch the TV input to display the video from the unit.**
- 6 Check the followings.**

On the unit: The input to which the playback device is connected is selected. If not, select the input source manually.

On the TV: The video from the playback device is displayed.

7 Check that the unit is properly synchronized with the TV by turning off the TV or adjusting the TV volume with the TV remote control.



- If HDMI Control does not work properly, try unplugging the TV in Step 3 and plugging in the TV again in Step 4. It may solve the problem. Also, HDMI Control may not work if the number of connected devices exceeds the limit. In this case, disable HDMI Control on the devices not in use.
- If the unit is not synchronized to the TV's power operations, check the priority of the audio output setting on the TV.
- We recommend using TV and playback devices from the same manufacturer so that HDMI Control works more effectively.

HDMI signal compatibility

Audio signals

Audio signal type	Audio signal format	Compatible media (example)
2ch Linear PCM	2ch, 32 to 192 kHz, 16/20/24 bit	CD, DVD-Video, DVD-Audio
Multichannel Linear PCM	8ch, 32 to 192 kHz, 16/20/24 bit	DVD-Audio, BD (Blu-ray disc), HD DVD
DSD	2 to 5.1ch, 2.8224 MHz, 1 bit	SACD
Bitstream	Dolby Digital, DTS	DVD-Video
Bitstream (High definition audio)	Dolby TrueHD, Dolby Digital Plus, DTS-HD Master Audio, DTS-HD High Resolution Audio, DTS Express	BD (Blu-ray disc), HD DVD

Video signals

The unit is compatible with the video signals of the following resolutions:

- VGA
- 480i/60 Hz
- 576i/50 Hz
- 480p/60 Hz
- 576p/50 Hz
- 720p/60 Hz, 50 Hz
- 1080i/60 Hz, 50 Hz
- 1080p/60 Hz, 50 Hz, 24 Hz
- 3840 x 2160p/30 Hz, 25 Hz, 24 Hz (4K signals)
- 4096 x 2160p/24 Hz (4K signals)



- When CPPM copy-protected DVD-Audio is played back, video/audio signals may not be output, depending on the type of the DVD player.
- The unit is not compatible with HDCP-incompatible HDMI or DVI devices. For details, refer to the instruction manual for each device.
- To decode audio bitstream signals on the unit, set the input source device appropriately so that the device outputs the bitstream audio signals directly (does not decode the bitstream signals on the playback device). For details, refer to the instruction manual for the playback device.

Reference diagram (rear panel)

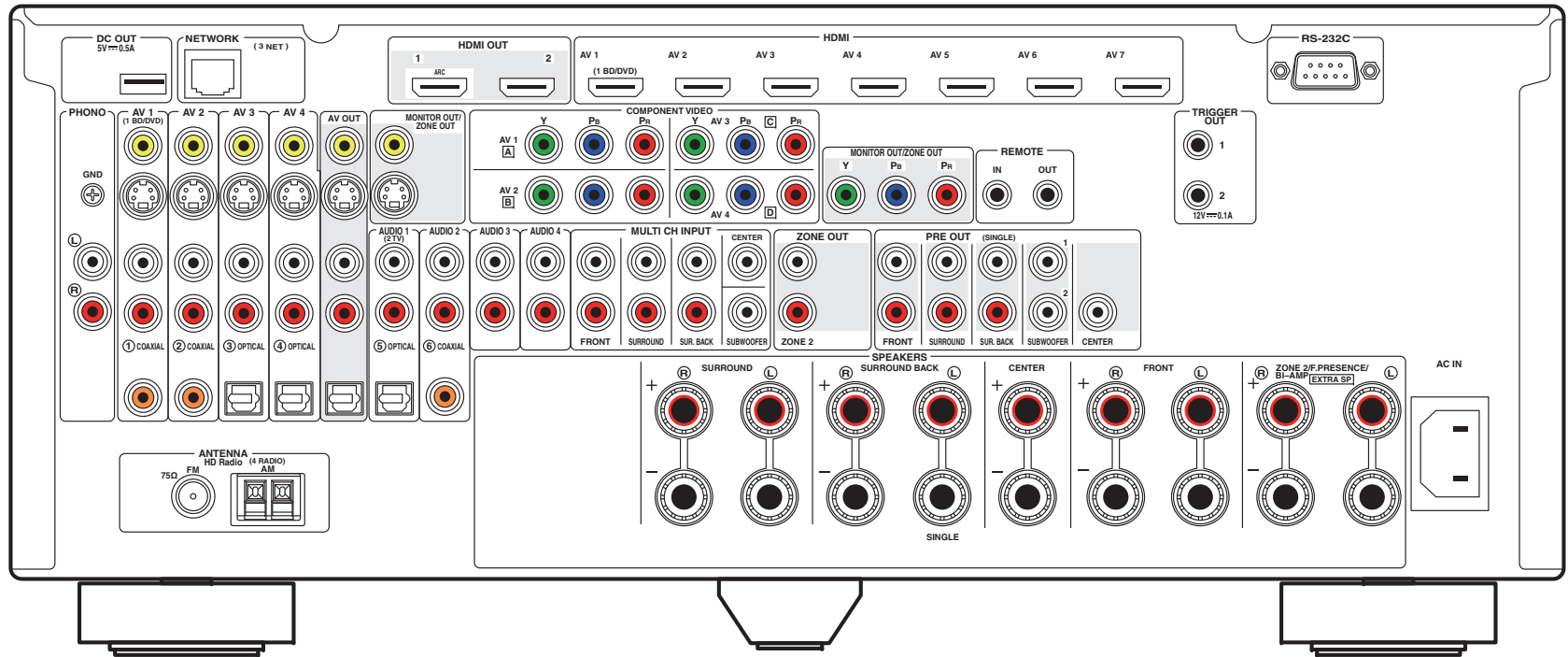

(U.S.A. model)



- The area around the video/audio output jacks is marked in white on the actual product to prevent improper connections.

Trademarks



Manufactured under license from Dolby Laboratories. Dolby, Pro Logic and the double-D symbol are trademarks of Dolby Laboratories.



Manufactured under license under U.S. Patent Nos: 5,956,674; 5,974,380; 6,226,616; 6,487,535; 7,212,872; 7,333,929; 7,392,195; 7,272,567 & other U.S. and worldwide patents issued & pending. DTS-HD, the Symbol, & DTS-HD and the Symbol together are registered trademarks & DTS-HD Master Audio is a trademark of DTS, Inc.

Product includes software. © DTS, Inc. All Rights Reserved.



"Made for iPod," "Made for iPhone," and "Made for iPad" mean that an electronic accessory has been designed to connect specifically to iPod, iPhone, or iPad, respectively, and has been certified by the developer to meet Apple performance standards.

Apple is not responsible for the operation of this device or its compliance with safety and regulatory standards.

Please note that the use of this accessory with iPod, iPhone, or iPad may affect wireless performance.

AirPlay, the AirPlay logo, iPad, iPhone, iPod, iPod nano, and iPod touch are trademarks of Apple Inc., registered in the U.S. and other countries.



Fraunhofer Institut
Integrierte Schaltungen

MPEG Layer-3 audio coding technology licensed from Fraunhofer IIS and Thomson.



This receiver supports network connections.



HD Radio Technology manufactured under license from iBiquity Digital Corporation. U.S. and Foreign Patents. HD Radio™ and the HD, HD Radio, and "Arc" logos are proprietary trademarks of iBiquity Digital Corp.



"HDMI," the "HDMI" logo and "High-Definition Multimedia Interface" are trademarks, or registered trademarks of HDMI Licensing LLC.



"x.v.Color" is a trademark of Sony Corporation.



"SILENT CINEMA" is a trademark of Yamaha Corporation.



DLNA™ and DLNA CERTIFIED™ are trademarks or registered trademarks of Digital Living Network Alliance. All rights reserved. Unauthorized use is strictly prohibited.



Windows is a registered trademark of Microsoft Corporation in the United States and other countries.

Windows XP, Windows Vista, Windows 7, Windows Media Audio and Windows Media Player are either registered trademarks or trademarks of Microsoft Corporation in the United States and/or other countries.

Specifications

Input jacks

- Analog Audio
 - Audio x 10 (AV 1–4, AUDIO 1–4, PHONO, V-AUX)
 - MULTI CH INPUT x 1 (8 ch)
(FRONT L/R, CENTER, SURROUND L/R, SURROUND BACK L/R, SUBWOOFER)
- Digital Audio (Supported frequencies: 32 kHz to 96 kHz)
 - Optical x 4 (AV 3–4, AUDIO 1, V-AUX)
 - Coaxial x 3 (AV 1–2, AUDIO 2)
- Video
 - Composite x 5 (AV 1–4, V-AUX)
 - S-video x 4 (AV 1–4)
 - Component x 4 (AV 1–4)
- HDMI Input
 - HDMI x 8 (AV 1–7, V-AUX)
- Other
 - USB x 1 (USB2.0)
 - NETWORK x 1 (100Base-TX/10Base-T)

Output jacks

- Analog Audio
 - Speaker Out x 9 (7 ch) (FRONT L/R, CENTER, SURROUND L/R, SURROUND BACK L/R, EXTRA SP L/R^{*1})
*1 Note: Assignment is possible [ZONE2, F.PRESENCE, BI-AMP (FRONT L/R)]
 - Pre Out x 7 (FRONT L/R, CENTER, SURROUND L/R, SURROUND BACK L/R)
 - Subwoofer Out x 2 (SUBWOOFER 1–2, mono)
 - Audio x 1 (AV OUT)
 - ZONE OUT x 1 (ZONE 2)
- Digital Audio
 - Optical x 1 (AV OUT)

- Video
 - MONITOR OUT/ZONE OUT
 - Composite x 1
 - S-video x 1
 - Component x 1
 - AV OUT
 - Composite x 1
 - S-video x 1
- HDMI Output
 - HDMI OUT x 2 (HDMI OUT 1–2)

Other jacks

- REMOTE IN x 1
- REMOTE OUT x 1
- TRIGGER OUT x 2
- RS-232C x 1
- DC OUT x 1

HDMI

- HDMI Specification: Deep Color, "x.v.Color," Auto Lip Sync, ARC (Audio Return Channel), 3D, 4K
- Video Format (Repeater Mode)
 - VGA
 - 480i/60 Hz
 - 576i/50 Hz
 - 480p/60 Hz
 - 576p/50 Hz
 - 720p/60 Hz, 50 Hz
 - 1080i/60 Hz, 50 Hz
 - 1080p/60 Hz, 50 Hz, 24 Hz
 - 3840 x 2160p/30 Hz, 25 Hz, 24 Hz
 - 4096 x 2160p/24 Hz

- Audio Format
 - Dolby TrueHD
 - Dolby Digital Plus
 - Dolby Digital
 - DTS-HD Master Audio
 - DTS-HD High Resolution Audio
 - DTS Express
 - DTS
 - DSD 6-ch
 - PCM 2-ch to 8-ch (Max. 192 kHz/24-bit)
- Content Protection: HDCP compatible
- Link Function: CEC supported

TUNER

- Analog Tuner
 - [U.K. and Europe models]
FM/AM with Radio Data System x 1 (TUNER)
 - [Other models]
FM/AM x 1 (TUNER)
- HD Radio tuner [U.S.A. model] x 1 (TUNER)

USB

- Capable of iPod, Mass Storage Class USB Memory
- Current Supply Capacity: 2.1 A

Network

- PC Client Function
- Compatible with DLNA ver. 1.5
- AirPlay supported
- Internet Radio

Compatible Decoding Formats

- Decoding Format
 - Dolby TrueHD, Dolby Digital Plus
 - Dolby Digital, Dolby Digital EX
 - DTS-HD Master Audio, DTS-HD High Resolution Audio, DTS Express
 - DTS, DTS 96/24, DTS-ES Matrix 6.1, DTS-ES Discrete 6.1
 - DTS Digital Surround
- Post Decoding Format
 - Dolby Pro Logic
 - Dolby Pro Logic II Music, Dolby Pro Logic II Movie, Dolby Pro Logic II Game
 - Dolby Pro Logic IIx Music, Dolby Pro Logic IIx Movie, Dolby Pro Logic IIx Game
 - DTS Neo:6 Music, DTS Neo:6 Cinema

Audio Section

- Rated Output Power (2-channel driven)
(20 Hz to 20 kHz, 0.06% THD, 8 Ω)

Front L/R	110 W+110 W
Center	110 W
Surround L/R.....	110 W+110 W
Surround Back L/R	110 W+110 W
(1 kHz, 0.9% THD, 8 Ω)	
Front L/R	120 W+120 W
Center	120 W
Surround L/R.....	120 W+120 W
Surround Back L/R	120 W+120 W
- Rated Output Power (1-channel driven)
(1 kHz, 0.9% THD, 8 Ω)

Front L/R	135 W/ch
Center	135 W/ch
Surround L/R.....	135 W/ch
Surround Back L/R	135 W/ch
(1 kHz, 0.9% THD, 4 Ω)	
Front L/R [U.K. and Europe models]	170 W/ch

- Maximum Effective Output Power (1-channel driven)
(JEITA, 1 kHz, 10% THD, 8 Ω)
[China, Korea, Asia and General models]

Front L/R	165 W/ch
Center.....	165 W/ch
Surround L/R	165 W/ch
Surround Back L/R	165 W/ch
- Dynamic Power (IHF)

Front L/R (8/6/4/2 Ω)	135/165/210/280 W
-----------------------------	-------------------
- Damping Factor

Front L/R, 1 kHz, 8 Ω.....	150 or more
----------------------------	-------------
- Input Sensitivity / Input Impedance

PHONO (1 kHz, 100 W/8 Ω)	3.5 mV/47 kΩ
AUDIO 2 etc. (1 kHz, 100 W/8 Ω).....	200 mV/47 kΩ
- Maximum Input Signal

PHONO (1 kHz, 0.5% THD)	60 mV or more
AUDIO 2 etc. (1 kHz, 0.5% THD).....	2.4 V or more
- Output Level / Output Impedance

AV OUT.....	200 mV/1.2 kΩ
HEADPHONE OUT.....	150 mV/100 Ω
PRE OUT	
SUBWOOFER (50 Hz)	1.0 V/1.2 kΩ
Except SUBWOOFER (1 kHz).....	1.0 V/1.2 kΩ
ZONE OUT	1.0 V/1.2 kΩ
- Frequency Response

AUDIO 2 etc. (10 Hz to 100 kHz)	+0/-3 dB
---------------------------------------	----------
- RIAA Equalization Deviation

PHONO (20 Hz to 20 kHz)	0±0.5 dB
-------------------------------	----------
- Total Harmonic Distortion

PHONO to AV OUT.....	0.02% or less
MULTI CH INPUT to Speaker Out (Pure Direct, 70 W, 8 Ω)	
.....	0.04% or less

- Signal to Noise Ratio (IHF-A Network)
PHONO to AV OUT (Input Shorted 5 mV)
[U.S.A., Canada, China and General models]... 86 dB or more
[Other models]..... 81 dB or more
AUDIO 2 etc. to Speaker Out (Pure Direct, Input Shorted 250 mV)
..... 100 dB or more
 - Residual Noise (IHF-A Network)
Front L/R (Speaker Out)..... 150 μV or less
 - Channel Separation
PHONO (Input Shorted, 1 kHz/10 kHz) ...60 dB/55 dB or more
AUDIO 2 etc. (Input 5.1 kΩ Shorted, 1 kHz/10 kHz)
.....60 dB/45 dB or more
 - Volume Control
Main Zone MUTE, -80 dB to +16.5 dB (0.5 dB Step)
Zone2 MUTE, -80 dB to +16.5 dB (0.5 dB Step)
 - Tone Control Characteristics
Main Zone
 Bass Boost/Cut ±6.0 dB/50 Hz (0.5 dB Step)
 Bass Turnover350 Hz
 Treble Boost/Cut.....±6.0 dB/20 kHz (0.5 dB Step)
 Treble Turnover3.5 kHz
Zone2
 Bass Boost/Cut ±10 dB/50 Hz (2 dB Step)
 Bass Turnover350 Hz
 Treble Boost/Cut..... ±10 dB/50 Hz (2 dB Step)
 Treble Turnover3.5 kHz
 - Filter Characteristics
(fc=40/60/80/90/100/110/120/160/200 Hz)
H.P.F. (Front, Center, Surround, Surround Back: Small)
.....12 dB/oct.
L.P.F. (Subwoofer)24 dB/oct.
- ## Video Section
- Video Signal Type
[U.S.A., Canada, Korea and General models]NTSC
[Other models].....PAL
 - Video Signal Type (Video Conversion)..... NTSC/PAL

- Video Signal Level
 - Composite 1 Vp-p/75 Ω
 - S-video
 - Y..... 1 Vp-p/75 Ω
 - C (NTSC) [U.S.A., Canada, Korea and General models] 0.286 Vp-p/75 Ω
 - C (PAL) [Other models] 0.3 Vp-p/75 Ω
 - Component
 - Y..... 1 Vp-p/75 Ω
 - Pb/Pr..... 0.7 Vp-p/75 Ω
- Video Maximum Input Level (Video Conversion Off) 1.5 Vp-p or more
- Signal to Noise Ratio (Video Conversion Off).....60 dB or more
- Monitor Out Frequency Response (Video Conversion Off)
 - Component (MONITOR OUT/ZONE OUT) 5 Hz to 100 MHz, \pm 3 dB

FM Section

- Tuning Range
 - [U.S.A. and Canada models]87.5 MHz to 107.9 MHz
 - [Asia and General models]87.5/87.50 MHz to 108.0/108.00 MHz
 - [Other models].....87.50 MHz to 108.00 MHz
- 50 dB Quiet Sensitivity (IHF, 1 kHz, 100% MOD.)
 - Mono..... 3 μ V (20.8 dBf)
- Signal to Noise Ratio (IHF)
 - Mono/Stereo [except U.S.A. model]..... 72 dB/70 dB
 - HD [U.S.A. model] 80 dB
- Harmonic Distortion (IHF, 1 kHz)
 - Mono/Stereo [except U.S.A. model]..... 0.3%/0.5%
 - HD [U.S.A. model] 0.03%
- Antenna Input 75 Ω unbalanced

AM section

- Tuning Range
 - [U.S.A. and Canada models] 530 kHz to 1710 kHz
 - [Asia and General models]..... 530/531 kHz to 1710/1611 kHz
 - [Other models]..... 531 kHz to 1611 kHz

General

- Power Supply
 - [U.S.A. and Canada models]AC 120 V, 60 Hz
 - [General model]AC 110 to 120/220 to 240 V, 50/60 Hz
 - [China model].....AC 220 V, 50 Hz
 - [Korea model]AC 220 V, 60 Hz
 - [Australia model]AC 240 V, 50 Hz
 - [U.K. and Europe models]AC 230 V, 50 Hz
 - [Asia model]AC 220 to 240 V, 50/60 Hz
- Power Consumption
 - [U.S.A. model]..... 490 W/620 VA
 - [Canada model] 400 W/510 VA
 - [Korea model]390 W
 - [Other models]490 W
- Standby Power Consumption
 - HDMI Control Off, Standby Through Off0.3 W (Typical)
 - HDMI Control On, Standby Through On 4.5 W (Typical)
 - HDMI Control Off, Standby Through On (AV 1, No Signals) 4.5 W (Typical)
 - Network Standby On2.2 W (Typical)
- Maximum Power Consumption
 - [Asia and General models] 1190 W
- Dimensions (W x H x D)435 x 182 x 432 mm (17-1/8" x 7-1/8" x 17")
- Weight 15.1 kg (33.3 lbs)

* Specifications are subject to change without notice.

Index

Symbols

ⓧPLII Game (surround decoder)	55
ⓧPLII Movie (surround decoder)	55
ⓧPLII Music (surround decoder)	55
ⓧPLIIX Game (surround decoder)	55
ⓧPLIIX Movie (Extended Surround)	86
ⓧPLIIX Movie (surround decoder)	55
ⓧPLIIX Music (Extended Surround)	86
ⓧPLIIX Music (surround decoder)	55
ⓧPLIIXMo (Extended Surround)	86
ⓧPLIIXMu (Extended Surround)	86
ⓧPro Logic (surround decoder)	55
Lock icon (🔒)	112

Numerics

2.1-channel system (speaker configuration)	16
2ch Stereo (sound program)	53
4K signal (video signal resolution)	138
5.1-channel system (speaker configuration)	16
5ch BI-AMP (Power Amp Assign, Setup menu)	100
5ch BI-AMP (speaker configuration)	20
5ch BI-AMP +SB (Power Amp Assign, Setup menu)	100
5ch BI-AMP +SB (speaker configuration)	21
7.1+2-channel system (speaker configuration)	15
7.1-channel system (speaker configuration)	15
7ch +1ZONE (Power Amp Assign, Setup menu)	100

7ch +1ZONE (speaker configuration)	21
7ch Stereo (sound program)	53

A

Access control (network device)	108
Action Game (sound program)	52
Adaptive DRC (Option menu)	85
Adaptive DSP Level (Sound, Setup menu)	104
Adjustment (Lipsync, Setup menu)	104
ADVANCED SETUP menu	115
ADVANCED SETUP menu items	116
Adventure (sound program)	52
AirPlay	76
AM antenna	34
Amp (Audio Output, Setup menu)	106
Apple Composite AV Cable	64
ARC (Audio Return Channel)	25
ARC (HDMI Control, Setup menu)	106
Aspect (Video Mode, Setup menu)	105
Audio Decoder (front display information)	83
Audio device connection	33
Audio file format (PC/NAS)	71
Audio file format (USB storage device)	68
AUDIO jack	24
Audio Mode (Option menu)	87
Audio Output (HDMI, Setup menu)	106
Audio program (HD Radio)	59
Audio Return Channel (ARC)	25
Audio Select (Option menu)	87
Audio Signal (Information menu)	114
Auto Power Down (ECO, Setup menu)	113

Auto/Manual Select (Lipsync, Setup menu)	103
Automatic station preset (FM radio)	63
Automatic station preset (HD Radio)	61
AV OUT jacks	36

B

Backup/recovery of the settings (ADVANCED SETUP menu)	118
Banana plug	18
Bass Cross Over (Configuration, Setup menu)	102
Battery	5
Bitrate (Audio Signal, Information menu)	114
Bitstream	138

C

Cartridge	33
Cellar Club (sound program)	53
Center (Configuration, Setup menu)	101
Center Image (Sound Program menu)	96
Center Width (Sound Program menu)	96
Chamber (sound program)	53
Channel (Audio Signal, Information menu)	114
CINEMA DSP	52
CINEMA DSP 3D	54
CINEMA DSP 3D Mode (Option menu)	85
CLASSICAL (sound program subcategory)	53
Clearing (remote control)	122
Clock Time (Radio Data System)	61
COAXIAL jack	24
Component video cable	24

COMPONENT VIDEO jack	24	DNS Server		Extra Bass	
Compressed Music Enhancer	56	(Network, Information menu)	115	(Configuration, Setup menu)	102
Configuration (Speaker, Setup menu)	100	Dolby Digital EX (Extended Surround)	86	F	
Crossover frequency setting		Dolby Pro Logic (surround decoder)	55	Filter	
(subwoofer)	40	Dolby Pro Logic II (surround decoder)	55	(MAC Address Filter, Setup menu)	108
D		Dolby Pro Logic IIx		FIRM UPDATE	
DC OUT jack	11	(surround decoder)	55	(ADVANCED SETUP menu)	118
Decode Type (Sound Program menu)	95	Dolby Pro Logic IIx Movie		Firmware Update	124
Decoder Mode (Input menu)	90	(Extended Surround)	86	Firmware update	
Default Gateway	107	Dolby Pro Logic IIx Music		(ADVANCED SETUP menu)	118
Default Gateway		(Extended Surround)	86	Firmware Version	
(Network, Information menu)	115	Drama (sound program)	52	(System, Information menu)	115
Delay Enable (Lipsync, Setup menu)	103	DSD (Direct Stream Digital)	133	Firmware version check	
Detail (Scene menu)	93	DSP Level (Sound Program menu)	95	(ADVANCED SETUP menu)	118
Device Control (Scene menu)	92	DSP Program		FM antenna	34
DHCP (IP Address, Setup menu)	107	(front display information)	83	FM Mode (Option menu)	88
Dialogue		DTS Neo:6 (surround decoder)	55	FM/AM antenna connection	34
(Audio Signal, Information menu)	114	DTS-ES (Extended Surround)	86	Format	
Dialogue Adjust (Option menu)	86	Dynamic Range		(Audio Signal, Information menu)	114
Dialogue Level (Option menu)	86	(Sound, Setup menu)	104	Frequency step setting	
Dialogue Lift (Option menu)	86	E		(ADVANCED SETUP menu)	57
Dialogue normalization level	114	ECO (Setup menu)	113	Front (Configuration, Setup menu)	100
Digital coaxial cable	24	ECO Mode (ECO, Setup menu)	113	Front display	
Digital Media Controller (DMC)	91	Enhancer (Option menu)	87	(part names and functions)	10
Digital optical cable	24	ENHANCER (sound mode)	56	Front display information	83
Dimension (Sound Program menu)	96	ENTERTAINMENT		Front panel (part names and functions)	8
Dimmer (Front Display)		(sound program subcategory)	52	Front panel door (front panel)	8
(Display Set, Setup menu)	111	Error message (YPAO)	46	Front Presence	
Direct (Sound Program menu)	95	EX/ES (Extended Surround)	86	(Configuration, Setup menu)	101
Direct Stream Digital (DSD)	133	Extended Surround (Option menu)	86	Front/Rear Balance	
DISPLAY key	83	External device control		(Sound Program menu)	95
Display Set (Function, Setup menu)	111	(remote control)	119	Function (Setup menu)	111
Distance (Speaker, Setup menu)	102	External device operation keys		G	
DMC (Digital Media Controller)	91	(remote control)	12	GND terminal (turntable connection)	33
DMC Control (Input menu)	91	External power amplifier connection	23	Ground lead (turntable connection)	33
DNS Server	107				

H		
Hall in Munich (sound program)	53	
Hall in Vienna (sound program)	53	
HD Radio audio program selection	59	
HD Radio information	59	
HDMI (Setup menu)	106	
HDMI cable	24	
HDMI Control	137	
HDMI Control (HDMI, Setup menu)	106	
HDMI jack	24	
HDMI Monitor (Information menu)	114	
HDMI OUT1		
(Audio Output, Setup menu)	107	
HDMI OUT2		
(Audio Output, Setup menu)	107	
HDMI output selection	48	
Height Balance (Sound Program menu) ...	95	
High definition audio	138	
High speed HDMI cable	24	
Hold (HD Radio information)	60	
Hold/Unhold (Option menu)	60	
I		
INFO key	83	
Information display (front display)	10	
Information menu	114	
Initial Delay (Sound Program menu)	95	
Initial setting restoration		
(ADVANCED SETUP menu)	118	
Initial Volume (Sound, Setup menu)	104	
Initial Volume		
(Zone2 Set, Setup menu)	109	
INITIALIZE		
(ADVANCED SETUP menu)	118	
Input Assignment		
(Function, Setup menu)	111	
Input jack assignment	111	
Input menu	89	
Input menu items	89	
Input selection keys (remote control)	12	
Input Trim (Option menu)	86	
Internet radio	74	
IP Address	107	
IP Address		
(Network, Information menu)	115	
IP Address (Network, Setup menu)	107	
iPad	64	
iPhone	64	
iPod	64	
iPod connection	64	
iTunes	76	
L		
Language (Setup menu)	113	
Learning (remote control)	121	
Left/Right Balance		
(Sound Program menu)	95	
Level (Sound Program menu)	95	
Level (Speaker, Setup menu)	102	
LFE (Low Frequency Effects)	134	
Lipsync	134	
Lipsync (Sound, Setup menu)	103	
LIVE/CLUB		
(sound program subcategory)	53	
Liveness (Sound Program menu)	95	
Load (Scene menu)	92	
Low Frequency Effects (LFE)	134	
M		
MAC Address		
(MAC Address Filter, Setup menu)	108	
MAC Address		
(Network, Information menu)	115	
MAC Address Filter		
(Network, Setup menu)	108	
Main Zone Set		
(Multi Zone, Setup menu)	109	
Manual Setup (Speaker, Setup menu) ...	100	
Manual station preset (FM/AM radio)	58	
Mass storage class device	68	
Max Volume (Sound, Setup menu)	104	
Max Volume		
(Zone2 Set, Setup menu)	109	
Measurement result (YPAO)	44	
Media sharing setup	71	
Memory Guard		
(Function, Setup menu)	112	
Menu language selection	39	
Menu operation keys (front panel)	9	
Menu operation keys (remote control)	12	
Monaural Mix (Sound Program menu)	95	
Monaural reception mode (FM radio)	57	
MONITOR CHECK		
(ADVANCED SETUP menu)	117	
Monitor check		
(ADVANCED SETUP menu)	117	
Monitor Out Assign		
(Multi Zone, Setup menu)	110	
Mono (Zone2 Set, Setup menu)	110	
Mono Movie (sound program)	52	
MOVIE (sound program category)	52	
MOVIE THEATER		
(sound program subcategory)	52	
MULTI CH INPUT jacks	36	
Multi measure (YPAO)	43	
Multi Zone (Setup menu)	109	
Multi-zone	78	
MUSIC (sound program category)	53	
Music Video (sound program)	52	

MUTE key	12	Playback (iPod)	65	Remote control sensor setting (ADVANCED SETUP menu)	116
Muting	48	Playback (NAS)	71	Remote control signal transmitter (remote control)	12
N		Playback (PC)	71	Remote ID (System, Information menu)	115
NAS (Network Attached Storage)	35	Playback (USB storage device)	68	REMOTE IN jack	80
NAS connection	35	Power Amp Assign (Speaker, Setup menu)	100	REMOTE OUT jack	37
Neo:6 Cinema (surround decoder)	55	Power cable connection	38	REMOTE SENSOR (ADVANCED SETUP menu)	116
Neo:6 Music (surround decoder)	55	PRE OUT jacks	23	Rename (input source name)	90
Network (Information menu)	115	Program Service (Radio Data System)	61	Rename (network name)	108
Network (Setup menu)	107	Program Type (Radio Data System)	61	Rename (scene name)	93
Network Attached Storage (NAS)	35	Pure Direct	55	Rename/Icon Select (Input menu)	90
Network connection	35	PURE DIRECT (sound mode)	55	Rename/Icon Select (Scene menu)	93
Network Name (Network, Information menu)	115	Pure Direct Mode (Sound, Setup menu)	104	Repeat (iPod, Option menu)	67
Network Name (Network, Setup menu)	108	R		Repeat (PC/NAS, Option menu)	73
Network Standby (Network, Setup menu)	108	Radio Data System (FM radio)	61	Repeat (USB storage device, Option menu)	70
Numeric keys (remote control)	12	Radio Data System information	61	Reset (remote control)	123
O		Radio Text (Radio Data System)	61	Reset (Scene menu)	93
ON SCREEN key	12	Rear panel (part names and functions) ...	11	Resolution (Video Mode, Setup menu)	105
On-screen menu	12	Recording device connection	36	Reverb Delay (Sound Program menu)	95
OPTICAL jack	24	RECOV./BACKUP (ADVANCED SETUP menu)	118	Reverb Level (Sound Program menu)	95
OPTION key	84	REMOTE CON AMP (ADVANCED SETUP menu)	116	Reverb Time (Sound Program menu)	95
Option menu	84	Remote connection	37	Roleplaying Game (sound program)	52
Option menu items	84	Remote control (part names and functions)	12	Room Size (Sound Program menu)	95
P		Remote control code registration (playback device)	120	Router connection	35
Panorama (Sound Program menu)	96	Remote control code registration (TV) ...	119	S	
Parametric EQ (Speaker, Setup menu) ...	102	Remote control ID setting (ADVANCED SETUP menu)	116	S VIDEO jack	24
PARTY key	82	Remote control ID setting (remote control)	116	Sampling (Audio Signal, Information menu)	114
Party mode	82	Remote control sensor	5	Save (Scene menu)	92
Party Mode Set (Multi Zone, Setup menu)	110			Scene configuration	50
PC connection	35			SCENE function	49
PHONES jack	9				
PHONO jack (turntable connection)	33				

SCENE key	49	Speaker Impedance (System, Information menu)	115	Surround Back Room Size (Sound Program menu)	95
SCENE link playback	37	Speaker impedance setting (ADVANCED SETUP menu)	16	Surround decoder	55
Scene menu	91	Speaker indicator (front display)	10	Surround Initial Delay (Sound Program menu)	95
Scene menu items	92	Spectacle (sound program)	52	Surround Liveness (Sound Program menu)	95
Sci-Fi (sound program)	52	Sports (sound program)	52	Surround Room Size (Sound Program menu)	95
Setting Data Copy (Speaker, Setup menu)	100	Standard (sound program)	52	S-video cable	24
Setting Pattern (Speaker, Setup menu)	100	Standby indicator (front panel)	8	System (Information menu)	115
Setup menu	97	Standby Sync (HDMI Control, Setup menu)	106	System ID (System, Information menu)	115
Setup menu items	98	Standby Through (HDMI, Setup menu)	107		
Short Message (Display Set, Setup menu)	111	STEREO (sound program subcategory)	53	T	
Shuffle (iPod, Option menu)	67	Stereo pin cable	24	Target Zone (Trigger Output, Setup menu)	112
Shuffle (PC/NAS, Option menu)	73	Stereo reception mode (FM radio)	57	Test Tone (Speaker, Setup menu)	103
Shuffle (USB storage device, Option menu)	70	STP network cable	35	The Bottom Line (sound program)	53
SILENT CINEMA	56	STRAIGHT (sound mode)	54	The Roxy Theatre (sound program)	53
Simple play (iPod)	66	Straight decode	54	Tone Control (Option menu)	85
Single measure (YPAO)	42	Subnet Mask	107	Traffic information	62
SLEEP key	12	Subnet Mask (Network, Information menu)	115	Traffic Program (Option menu)	62
Sleep timer	12	Subwoofer (Configuration, Setup menu)	101	Trigger function	37
Sound (Setup menu)	103	Subwoofer connection	18	Trigger Mode (Trigger Output, Setup menu)	112
Sound field effect	52	Subwoofer Trim (Option menu)	87	TRIGGER OUT jacks	37
Sound mode selection	51	SUR.DECODE (sound mode)	55	Trigger Output1 (Function, Setup menu)	112
Sound program	52	Surround (Configuration, Setup menu)	101	Trigger Output2 (Function, Setup menu)	112
Sound program category	52	Surround Back (Configuration, Setup menu)	101	TUNER FRQ STEP (ADVANCED SETUP menu)	117
Sound Program menu	94	Surround Back Initial Delay (Sound Program menu)	95	Tuner Frq. Step (System, Information menu)	115
Sound Program menu items	95	Surround Back Liveness (Sound Program menu)	95	Tuning (FM/AM radio)	57
Speaker (Setup menu)	100			Tuning (HD Radio)	59
Speaker connection	17				
Speaker connection (bi-amp)	22				
Speaker connection (Zone2)	22				
SPEAKER IMP. (ADVANCED SETUP menu)	116				

Turntable	33
TV Audio Input	
(HDMI Control, Setup menu)	106
TV connection	25
TV FORMAT	
(ADVANCED SETUP menu)	117
TV Format (System, Information menu) ...	115
TV operation keys (remote control)	12

U

USB jack	9
USB storage device connection	68

V

VERSION (ADVANCED SETUP menu)	118
Video (Setup menu)	105
VIDEO AUX jacks	34
Video device connection	31
VIDEO jack	24
Video Mode (Option menu)	87
Video Mode (Video, Setup menu)	105
Video Out (Input menu)	90
Video pin cable	24
Video Signal (Information menu)	114
Video signal type setting	
(ADVANCED SETUP menu)	117
Virtual CINEMA DSP	54
Virtual Presence Speaker (VPS)	54
VOLTAGE SELECTOR	38
Volume (Zone2 Set, Setup menu)	109
Volume Interlock (Input menu)	90
Volume Trim (Option menu)	86
VPS (Virtual Presence Speaker)	54

W

Wall Paper (Display Set, Setup menu)	111
Warning message (YPAO)	47
Windows Media Player	71

Y

Yamaha Parametric room	
Acoustic Optimizer (YPAO)	40
YPAO (Yamaha Parametric room	
Acoustic Optimizer)	40
YPAO MIC jack	40
YPAO microphone	40

Z

Zone (Information menu)	115
Zone Rename	
(Main Zone Set, Setup menu)	109
Zone Rename	
(Zone2 Set, Setup menu)	110
Zone Scene Rename	
(Zone2 Set, Setup menu)	110
Zone2	78
Zone2 Set (Multi Zone, Setup menu)	109



FCC INFORMATION (for US customers)

1 IMPORTANT NOTICE: DO NOT MODIFY THIS UNIT!

This product, when installed as indicated in the instructions contained in this manual, meets FCC requirements. Modifications not expressly approved by Yamaha may void your authority, granted by the FCC, to use the product.

2 IMPORTANT: When connecting this product to accessories and/or another product use only high quality shielded cables. Cable/s supplied with this product MUST be used. Follow all installation instructions. Failure to follow instructions could void your FCC authorization to use this product in the USA.

3 NOTE: This product has been tested and found to comply with the requirements listed in FCC Regulations, Part 15 for Class "B" digital devices. Compliance with these requirements provides a reasonable level of assurance that your use of this product in a residential environment will not result in harmful interference with other electronic devices.

This equipment generates/uses radio frequencies and, if not installed and used according to the instructions found in the users manual, may cause interference harmful to the operation of other electronic devices.

Compliance with FCC regulations does not guarantee that interference will not occur in all installations. If this product is found to be the source of interference, which can be determined by turning the unit "OFF" and "ON", please try to eliminate the problem by using one of the following measures:

Relocate either this product or the device that is being affected by the interference.

Utilize power outlets that are on different branch (circuit breaker or fuse) circuits or install AC line filter/s.

In the case of radio or TV interference, relocate/reorient the antenna. If the antenna lead-in is 300 ohm ribbon lead, change the lead-in to coaxial type cable.

If these corrective measures do not produce satisfactory results, please contact the local retailer authorized to distribute this type of product. If you can not locate the appropriate retailer, please contact Yamaha Corporation of America A/V Division, USA, 6660 Orangethorpe Ave., Buena Park, CA 90620.

The above statements apply ONLY to those products distributed by Yamaha Corporation of America or its subsidiaries.

COMPLIANCE INFORMATION STATEMENT (DECLARATION OF CONFORMITY PROCEDURE)

Responsible Party: Yamaha Corporation of America A/V Division

Address: 6660 Orangethorpe Avenue Buena Park, CA 90620

Telephone: 714-522-9011

Type of Equipment: AV Receiver

Model Name: RX-A3020/RX-A2020/RX-A1020/RX-A820/RX-A720/
RX-V3073/RX-V2073/RX-V1073/RX-V773/RX-V673/RX-V573/RX-V473/
HTR-7065/HTR-6065/HTR-5065/HTR-4065

- This device complies with Part 15 of the FCC Rules.
- Operation is subject to the following conditions:
 - This device may not cause harmful interference.
 - This device must accept any interference received including interference that may cause undesired operation.

See the Troubleshooting section at the end of the Owner's Manual on the supplied CD-ROM if interference to radio reception is suspected.

INFORMATION DE LA FCC (pour les clients résidant aux États-Unis)

1 AVIS IMPORTANT : NE PAS APPORTER DE MODIFICATIONS À CET APPAREIL !

Cet appareil est conforme aux exigences de la FCC s'il est installé selon les instructions du mode d'emploi. Toute modification non approuvée expressément par Yamaha peut invalider l'autorisation de la FCC d'utiliser cet appareil.

2 IMPORTANT : N'utiliser que des câbles blindés de haute qualité pour le raccordement de cet appareil à des accessoires et/ou à un autre appareil. Seuls le ou les câbles fournis avec le produit DOIVENT être utilisés. Suivre les instructions concernant l'installation. Le non respect des instructions peut invalider l'autorisation, accordée par la FCC, d'utiliser ce produit aux États-Unis.

3 REMARQUE : Cet appareil a été testé et déclaré conforme aux normes relatives aux appareils numériques de Classe « B », telles que fixées dans l'Article 15 de la Réglementation FCC. Ces normes sont destinées à assurer une protection suffisante contre les interférences nuisibles avec d'autres appareils électroniques dans une installation résidentielle. Cet équipement génère et utilise des fréquences radio qui, en cas d'installation et d'utilisation non conformes aux instructions du mode d'emploi, peuvent être à l'origine d'interférences empêchant d'autres appareils de fonctionner.

Cependant, la conformité à la Réglementation FCC ne garantit pas l'absence d'interférences dans une installation particulière. Si cet appareil devait produire des interférences, ce qui peut être déterminé en « ÉTEIGNANT », puis en « RALLUMANT » l'appareil, l'utilisateur est invité à essayer de corriger le problème d'une des manières suivantes :

Réorienter cet appareil ou le dispositif affecté par les interférences.

Utiliser des prises d'alimentation branchées sur différents circuits (avec interrupteur de circuit ou fusible) ou installer un ou des filtres pour ligne secteur.

Dans le cas d'interférences radio ou TV, changer de place l'antenne et la réorienter. Si l'antenne est un conducteur plat de 300 ohms, remplacer ce câble par un câble de type coaxial.

Si ces mesures ne donnent pas les résultats escomptés, prière de contacter le détaillant local autorisé à commercialiser ce type d'appareil. Si ce n'est pas possible, prière de contacter Yamaha Corporation of America A/V Division, États-Unis, 6660 Orangethorpe Ave., Buena Park, CA 90620.

Les déclarations précédentes concernent EXCLUSIVEMENT les appareils commercialisés par Yamaha Corporation of America ou ses filiales.

DÉCLARATION SUR LES INFORMATIONS DE CONFORMITÉ (PROCÉDURE DE DÉCLARATION DE CONFORMITÉ)

Partie responsable: Yamaha Corporation of America A/V Division

Adresse: 6660 Orangethorpe Avenue Buena Park, CA 90620

Téléphone: 714-522-9011

Type d'équipement: Ampli-tuner audio-vidéo

Nom de modèle: RX-A3020/RX-A2020/RX-A1020/RX-A820/RX-A720/
RX-V3073/RX-V2073/RX-V1073/RX-V773/RX-V673/RX-V573/
RX-V473/
HTR-7065/HTR-6065/HTR-5065/HTR-4065

- Cet appareil est conforme à l'article 15 de la réglementation FCC.
 - Le fonctionnement est soumis aux conditions suivantes:
 - Cet appareil ne peut pas causer d'interférences nuisibles.
 - Cet appareil doit recevoir toutes les interférences, y compris celles pouvant entraîner des problèmes de fonctionnement.
- Voyez la section Guide de dépannage à la fin de ce mode d'emploi si vous pensez que le problème de réception radio est dû à des interférences.

AV Receiver

Safety Brochure

⏻ (Power key)

Turns on the power of this unit or sets it to the standby mode.

For more detailed information, refer to the Owner's Manual on the CD-ROM. To view the Owner's Manual, click on "English" in the screen displayed automatically when you insert the CD-ROM into your PC, or click on the model name if the screen to select models is displayed, and then click on "English" in the next screen. Then, follow the onscreen instructions.

If the screen is not displayed automatically, open the "index.html" in the CD-ROM.

Caution: Do not attempt to play this CD-ROM in an audio player.

The Owner's Manual contained in the CD-ROM can be downloaded from the following website.
<http://download.yamaha.com/>

IMPORTANT SAFETY INSTRUCTIONS

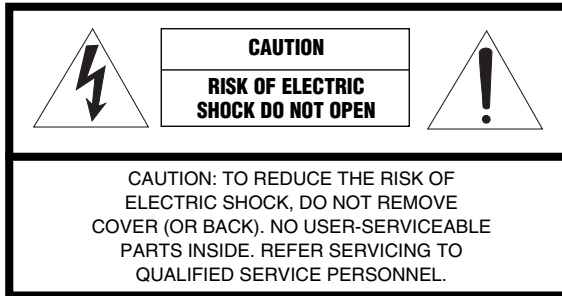
**• Explanation of Graphical Symbols**

The lightning flash with arrowhead symbol, within an equilateral triangle, is intended to alert you to the presence of uninsulated "dangerous voltage" within the product's enclosure that may be of sufficient magnitude to constitute a risk of electric shock to persons.



The exclamation point within an equilateral triangle is intended to alert you to the presence of important operating and maintenance (servicing) instructions in the literature accompanying the appliance.

- 1 Read these instructions.
- 2 Keep these instructions.
- 3 Heed all warnings.
- 4 Follow all instructions.
- 5 Do not use this apparatus near water.
- 6 Clean only with dry cloth.

- 7 Do not block any ventilation openings. Install in accordance with the manufacturer's instructions.
- 8 Do not install near any heat sources such as radiators, heat registers, stoves, or other apparatus (including amplifiers) that produce heat.
- 9 Do not defeat the safety purpose of the polarized or grounding-type plug. A polarized plug has two blades with one wider than the other. A grounding type plug has two blades and a third grounding prong. The wide blade or the third prong are provided for your safety. If the provided plug does not fit into your outlet, consult an electrician for replacement of the obsolete outlet.
- 10 Protect the power cord from being walked on or pinched particularly at plugs, convenience receptacles, and the point where they exit from the apparatus.
- 11 Only use attachments/accessories specified by the manufacturer.
- 12 Use only with the cart, stand, tripod, bracket, or table specified by the manufacturer, or sold with the apparatus. When a cart is used, use caution when moving the cart/apparatus combination to avoid injury from tip-over.
- 13 Unplug this apparatus during lightning storms or when unused for long periods of time.
- 14 Refer all servicing to qualified service personnel. Servicing is required when the apparatus has been damaged in any way, such as power-supply cord or plug is damaged, liquid has been spilled or objects have fallen into the apparatus, the apparatus has been exposed to rain or moisture, does not operate normally, or has been dropped.



We Want You Listening For A Lifetime



Yamaha and the Electronic Industries Association's Consumer Electronics Group want you to get the most out of your equipment by playing it at a safe level. One that lets the sound come through loud and clear without annoying blaring or distortion – and, most importantly, without affecting your sensitive hearing. Since hearing damage from loud sounds is often undetectable until it is too late, Yamaha and the Electronic Industries Association's Consumer Electronics Group recommend you to avoid prolonged exposure from excessive volume levels.

FOR CANADIAN CUSTOMERS

To prevent electric shock, match wide blade of plug to wide slot and fully insert.
This Class B digital apparatus complies with Canadian ICES-003.

POUR LES CONSOMMATEURS CANADIENS

Pour éviter les chocs électriques, introduire la lame la plus large de la fiche dans la borne correspondante de la prise et pousser jusqu'au fond. Cet appareil numérique de la classe B est conforme à la norme NMB-003 du Canada.

■ For U.K. customers

If the socket outlets in the home are not suitable for the plug supplied with this appliance, it should be cut off and an appropriate 3 pin plug fitted. For details, refer to the instructions described below.

Note

The plug severed from the mains lead must be destroyed, as a plug with bared flexible cord is hazardous if engaged in a live socket outlet.

■ Special Instructions for U.K. Model**IMPORTANT**

THE WIRES IN MAINS LEAD ARE COLOURED IN ACCORDANCE WITH THE FOLLOWING CODE:

Blue: NEUTRAL

Brown: LIVE

As the colours of the wires in the mains lead of this apparatus may not correspond with the coloured markings identifying the terminals in your plug, proceed as follows:

The wire which is coloured BLUE must be connected to the terminal which is marked with the letter N or coloured BLACK. The wire which is coloured BROWN must be connected to the terminal which is marked with the letter L or coloured RED.

Making sure that neither core is connected to the earth terminal of the three pin plug.

CAUTION: READ THIS BEFORE OPERATING YOUR UNIT.

- 1 To assure the finest performance, please read this manual carefully. Keep it in a safe place for future reference.
- 2 Install this sound system in a well ventilated, cool, dry, clean place - away from direct sunlight, heat sources, vibration, dust, moisture, and/or cold. For proper ventilation, allow the following minimum clearances.
Top: 30 cm, Rear: 20 cm, Sides: 20 cm
- 3 Locate this unit away from other electrical appliances, motors, or transformers to avoid humming sounds.
- 4 Do not expose this unit to sudden temperature changes from cold to hot, and do not locate this unit in an environment with high humidity (i.e. a room with a humidifier) to prevent condensation inside this unit, which may cause an electrical shock, fire, damage to this unit, and/or personal injury.
- 5 Avoid installing this unit where foreign object may fall onto this unit and/or this unit may be exposed to liquid dripping or splashing. On the top of this unit, do not place:
 - Other components, as they may cause damage and/or discoloration on the surface of this unit.
 - Burning objects (i.e. candles), as they may cause fire, damage to this unit, and/or personal injury.
 - Containers with liquid in them, as they may fall and liquid may cause electrical shock to the user and/or damage to this unit.
- 6 Do not cover this unit with a newspaper, tablecloth, curtain, etc. in order not to obstruct heat radiation. If the temperature inside this unit rises, it may cause fire, damage to this unit, and/or personal injury.
- 7 Do not plug in this unit to a wall outlet until all connections are complete.
- 8 Do not operate this unit upside-down. It may overheat, possibly causing damage.
- 9 Do not use force on switches, knobs and/or cords.
- 10 When disconnecting the power cable from the wall outlet, grasp the plug; do not pull the cable.
- 11 Do not clean this unit with chemical solvents; this might damage the finish. Use a clean, dry cloth.
- 12 Only voltage specified on this unit must be used. Using this unit with a higher voltage than specified is dangerous and may cause fire, damage to this unit, and/or personal injury. Yamaha will not be held responsible for any damage resulting from use of this unit with a voltage other than specified.
- 13 To prevent damage by lightning, keep the power cable and outdoor antennas disconnected from a wall outlet or this unit during a lightning storm.
- 14 Do not attempt to modify or fix this unit. Contact qualified Yamaha service personnel when any service is needed. The cabinet should never be opened for any reasons.
- 15 When not planning to use this unit for long periods of time (i.e. vacation), disconnect the AC power plug from the wall outlet.
- 16 Be sure to refer to the “Troubleshooting” section of the Owner’s Manual on the CD-ROM for common operating errors before concluding that this unit is faulty.
- 17 Before moving this unit, press \odot to set it to standby mode and disconnect the AC power plug from the wall outlet.
- 18 **VOLTAGE SELECTOR (General model)**
The VOLTAGE SELECTOR on the rear panel of this unit must be set for your local main voltage BEFORE plugging into the AC wall outlet. Voltages are:
.....AC 110-120/220-240V, 50/60Hz
- 19 Condensation will form when the surrounding temperature changes suddenly. Disconnect the power cable from the outlet, then leave this unit alone.
- 20 When using this unit for a long time, this unit may become warm. Turn the power off, then leave this unit alone for cooling.
- 21 Install this unit near the AC outlet and where the AC power plug can be reached easily.
- 22 The batteries shall not be exposed to excessive heat such as sunshine, fire or the like. When you dispose of batteries, follow your regional regulations.

- 23 Excessive sound pressure from earphones and headphones can cause hearing loss.
- 24 When replacing the batteries, be sure to use batteries of the same type. Danger of explosion may happen if batteries are incorrectly replaced.

This unit is not disconnected from the AC power source as long as it is connected to the wall outlet, even if this unit itself is turned off by \odot . This state is called the standby mode. In this state, this unit is designed to consume a very small quantity of power.

WARNING

TO REDUCE THE RISK OF FIRE OR ELECTRIC SHOCK, DO NOT EXPOSE THIS UNIT TO RAIN OR MOISTURE.

■ Notes on remote controls and batteries

- Do not spill water or other liquids on the remote control.
- Do not drop the remote control.
- Do not leave or store the remote control in the following conditions:
 - places of high humidity, such as near a bath
 - places of high temperatures, such as near a heater or stove
 - places of extremely low temperatures
 - dusty places
- Insert the battery according to the polarity markings (+ and -).
- Change all batteries if you notice the following conditions:
 - the operation range of the remote control narrows
 - the transmit indicator does not flash or is dim
- If the batteries run out, immediately remove them from the remote control to prevent an explosion or acid leak.
- If you find leaking batteries, discard the batteries immediately, taking care not to touch the leaked material. If the leaked material comes into contact with your skin or gets into your eyes or mouth, rinse it away immediately and consult a doctor. Clean the battery compartment thoroughly before installing new batteries.
- Do not use old batteries together with new ones. This may shorten the life of the new batteries or cause old batteries to leak.
- Do not use different types of batteries (such as alkaline and manganese batteries) together. Specification of batteries may be different even though they look the same.
- Before inserting new batteries, wipe the compartment clean.
- If the remote control is without batteries for more than 2 minutes, or if exhausted batteries remain in the remote control, the contents of the memory may be cleared. In such a case, install new batteries and set the remote control code.
- Dispose of batteries according to your regional regulations.
- Keep batteries away from children. If a battery is accidentally swallowed, contact your doctor immediately.
- When not planning to use the remote control for long periods of time, remove the batteries from the remote control.
- Do not charge or disassemble the supplied batteries.



This label is required to be attached to a product of which the temperature of the top cover may hot during operation.

Information for Users on Collection and Disposal of Old Equipment and Used Batteries



These symbols on the products, packaging, and/or accompanying documents mean that used electrical and electronic products and batteries should not be mixed with general household waste.

For proper treatment, recovery and recycling of old products and used batteries, please take them to applicable collection points, in accordance with your national legislation and the Directives 2002/96/EC and 2006/66/EC.



By disposing of these products and batteries correctly, you will help to save valuable resources and prevent any potential negative effects on human health and the environment which could otherwise arise from inappropriate waste handling.



For more information about collection and recycling of old products and batteries, please contact your local municipality, your waste disposal service or the point of sale where you purchased the items.

Pb

[Information on Disposal in other Countries outside the European Union]

These symbols are only valid in the European Union. If you wish to discard these items, please contact your local authorities or dealer and ask for the correct method of disposal.

Note for the battery symbol (bottom two symbol examples):

This symbol might be used in combination with a chemical symbol. In this case it complies with the requirement set by the Directive for the chemical involved.

Important Notice: Guarantee Information for customers in EEA* and Switzerland

English

For detailed guarantee information about this Yamaha product, and Pan-EEA* and Switzerland warranty service, please either visit the website address below (Printable file is available at our website) or contact the Yamaha representative office for your country. *EEA: European Economic Area

<http://europe.yamaha.com/warranty/>

IMPORTANT

Please record the serial number of this unit in the space below.

MODEL:

Serial No.:

The serial number is located on the rear of the unit. Retain this Owner's Manual in a safe place for future reference.

Controlling the unit from a web browser (web control)

You can control the unit with the web control screen displayed in a web browser.

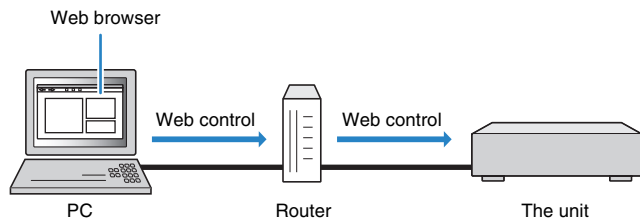

- To use this function, the unit and your PC must be connected to the network properly.
- Some security software installed on your PC may block the access of the unit to your PC. In these cases, configure the security software appropriately.
- To display the web control screen or turn on the unit from the web control when the unit is in standby mode, set "Network Standby" (p.3) to "On".
- We recommend using one of the following web browsers.
 - Internet Explorer 7.x, 8.x or 9.x
 - Safari 5.x

1 Start the web browser.

2 Enter the IP address of the unit in the address bar of the web browser.

(Example)

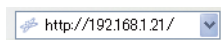

- You can check the IP address of the unit in "Network" in the "Information" menu.
- You can bookmark the unit's IP address in the browser or create a shortcut link (p.3) to access the web control screen quickly in the future.

Note

- If you are using a DHCP server, the IP address of the unit may change each time the unit is turned on.
- If you have enabled the MAC address filter, you need to specify the MAC address of your PC to allow the PC to access the unit. For information on how to check the MAC address of your PC, refer to its instruction manual.

- Items available on the web control screen vary depending on the model.

■ Top menu screen

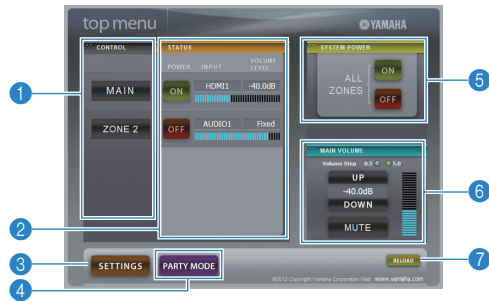

- 1 **CONTROL**
Moves to the control screen for the selected zone.
- 2 **STATUS**
Turns on/off the power for each zone or displays the input source and volume set for each zone.
- 3 **SETTINGS**
Moves to the settings screen.
- 4 **PARTY MODE**
(Not available on some models)
Turns on/off the party mode.
- 5 **SYSTEM POWER**
Turns on/off the power for all zones.
- 6 **MAIN VOLUME**
Adjusts the volume or mutes the audio output for the main zone. You can also select the increments used for volume adjustment.
- 7 **RELOAD**
Reloads the current status of the unit.

■ Control screen



- 1 **PLAY INFO**
Selects an input source or controls playback for the selected zone.
 - 2 **TOP MENU**
Moves to the top menu screen.
 - 3 **SCENE**
Selects a scene for the selected zone (only for the main zone on some models).
 - 4 **POWER**
Turns on/off the power for the selected zone.
 - 5 **VOLUME**
Adjusts the volume or mutes the audio output for the selected zone. You can also select the increments used for volume adjustment.
 - 6 **RELOAD**
Reloads the current status of the unit.
- !**
- Multi-zone volume adjustment is not available when an external amplifier is used.

Settings screen

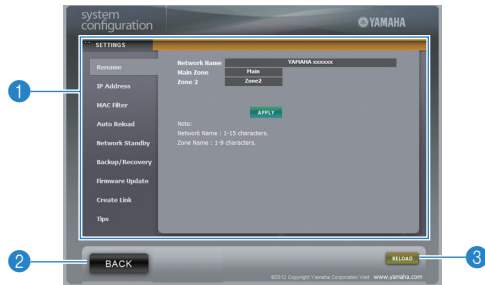

Note

- Do not operate the unit during the recovery process, as this may result in the incorrect recovery of the settings. When the recovery finishes, click "OK" to set the unit to standby mode.
- The backup does not contain user information (such as user account and password) or unit-specific information (such as MAC address and IP address).

1 Rename

Edits the network name (the unit's name on the network) or the name of each zone. Click "APPLY" to apply the changes to the unit.

IP Address

Configures the network parameters (such as IP address). Click "APPLY" to apply the changes to the unit.

MAC Filter

Sets the MAC address filter to limit access to the unit from the network devices. Click "APPLY" to apply the changes to the unit.

Auto Reload

Enables/disables automatic reloading. When "Auto Reload" is "On" (enabled), the web control screen reloads the status of the unit every 5 seconds.

Network Standby

Enables/disables the network standby function.

Backup/Recovery

Creates a backup of the unit's settings on the PC or restores the settings from the backup.

Firmware Update

Updates the firmware of the unit by using the firmware you have downloaded on the PC. Follow the on-screen instructions to start the firmware update.

Create Link

Creates a shortcut link to the desired control screen.

Tips

Displays tips for use of the web control.

2 BACK

Moves to the top menu screen.

3 RELOAD

Reloads the current status of the unit.

Information about software

This product uses the following free software.

For information (copyright, etc) about each software, read the original sentences stated below.

■ About ASN.1 object dumping code

ASN.1 object dumping code, copyright Peter Gutmann <pgut001@cs.auckland.ac.nz>, based on ASN.1 dump program by David Kemp <dpkemp@missi.ncsc.mil>, with contributions from various people including Matthew Hamrick <hamrick@rsa.com>, Bruno Couillard <bcouillard@chrysalis-its.com>, Hallvard Furusest <h.b.furusest@usit.uio.no>, Geoff Thorpe <geoff@raas.co.nz>, David Boyce <d.boyce@isode.com>, John Hughes <john.hughes@entegrity.com>, Life is hard, and then you die <ronald@trustpoint.com>, Hans-Olof Hermansson <hans-olof.hermansson@postnet.se>, Tor Rustad <Tor.Rustad@bbs.no>, Kjetil Barvik <kjetil.barvik@bbs.no>, James Sweeny <jsweeny@us.ibm.com>, and several other people whose names I've misplaced.

This code grew slowly over time without much design or planning, with features being tacked on as required.

It's not representative of my normal coding style.

■ About FLAC codec Library

Copyright ©
2000,2001,2002,2003,2004,2005,2006,2007,2008,2009
Josh Coalson

Redistribution and use in source and binary forms, with or without modification, are permitted provided that the following conditions are met:

Redistributions of source code must retain the above copyright notice, this list of conditions and the following disclaimer.

Redistributions in binary form must reproduce the above copyright notice, this list of conditions and the following disclaimer in the documentation and/or other materials provided with the distribution.

Neither the name of the Xiph.org Foundation nor the names of its contributors may be used to endorse or promote products derived from this software without specific prior written permission.

THIS SOFTWARE IS PROVIDED BY THE COPYRIGHT HOLDERS AND CONTRIBUTORS "AS IS" AND ANY EXPRESS OR IMPLIED WARRANTIES, INCLUDING, BUT NOT LIMITED TO, THE IMPLIED WARRANTIES OF MERCHANTABILITY AND FITNESS FOR A PARTICULAR PURPOSE ARE DISCLAIMED. IN NO EVENT SHALL THE FOUNDATION OR CONTRIBUTORS BE LIABLE FOR ANY DIRECT, INDIRECT, INCIDENTAL, SPECIAL, EXEMPLARY, OR CONSEQUENTIAL DAMAGES (INCLUDING, BUT NOT LIMITED TO, PROCUREMENT OF SUBSTITUTE GOODS OR SERVICES; LOSS OF USE, DATA, OR PROFITS; OR BUSINESS INTERRUPTION) HOWEVER CAUSED AND ON ANY THEORY OF LIABILITY, WHETHER IN CONTRACT, STRICT LIABILITY, OR TORT (INCLUDING NEGLIGENCE OR OTHERWISE) ARISING IN ANY WAY OUT OF THE USE OF THIS SOFTWARE, EVEN IF ADVISED OF THE POSSIBILITY OF SUCH DAMAGE.

■ About libexpat

Copyright © 1998, 1999, 2000 Thai Open Source Software Center Ltd and Clark Cooper

Copyright © 2001, 2002, 2003, 2004, 2005, 2006 Expat maintainers.

Permission is hereby granted, free of charge, to any person obtaining a copy of this software and associated documentation files (the "Software"), to deal in the Software without restriction, including without limitation the rights to use, copy, modify, merge, publish, distribute, sublicense, and/or sell copies of the Software, and to permit persons to whom the Software is furnished to do so, subject to the following conditions:

The above copyright notice and this permission notice shall be included in all copies or substantial portions of the Software.

THE SOFTWARE IS PROVIDED "AS IS", WITHOUT WARRANTY OF ANY KIND, EXPRESS OR IMPLIED, INCLUDING BUT NOT LIMITED TO THE WARRANTIES OF MERCHANTABILITY, FITNESS FOR A PARTICULAR PURPOSE AND NONINFRINGEMENT. IN NO EVENT SHALL THE AUTHORS OR COPYRIGHT HOLDERS BE LIABLE FOR ANY CLAIM, DAMAGES OR OTHER LIABILITY, WHETHER IN AN ACTION OF CONTRACT, TORT OR OTHERWISE, ARISING FROM, OUT OF OR IN CONNECTION WITH THE SOFTWARE OR THE USE OR OTHER DEALINGS IN THE SOFTWARE.

■ About The Independent JPEG Group's JPEG software

The Independent JPEG Group's JPEG software

Copyright © 1991-2010, Thomas G. Lane, Guido Vollbeding.

All Rights Reserved except as specified below.

The authors make NO WARRANTY or representation, either express or implied, with respect to this software, its quality, accuracy, merchantability, or fitness for a particular purpose. This software is provided "AS IS", and you, its user, assume the entire risk as to its quality and accuracy.

Permission is hereby granted to use, copy, modify, and distribute this software (or portions thereof) for any purpose, without fee, subject to these conditions:

- (1) If any part of the source code for this software is distributed, then this README file must be included, with this copyright and no-warranty notice unaltered; and any additions, deletions, or changes to the original files must be clearly indicated in accompanying documentation.
- (2) If only executable code is distributed, then the accompanying documentation must state that "this software is based in part on the work of the Independent JPEG Group".
- (3) Permission for use of this software is granted only if the user accepts full responsibility for any undesirable consequences; the authors accept NO LIABILITY for damages of any kind.

These conditions apply to any software derived from or based on the IJG code, not just to the unmodified library. If you use our work, you ought to acknowledge us.

Permission is NOT granted for the use of any IJG author's name or company name in advertising or publicity relating to this software or products derived from it. This software may be referred to only as "the Independent JPEG Group's software".

We specifically permit and encourage the use of this software as the basis of commercial products, provided that all warranty or liability claims are assumed by the product vendor.

■ About JsonCpp

Copyright © 2007-2010 Baptiste Lepilleur

Permission is hereby granted, free of charge, to any person obtaining a copy of this software and associated documentation files (the "Software"), to deal in the Software without restriction, including without limitation the rights to use, copy, modify, merge, publish, distribute, sublicense, and/or sell copies of the Software, and to permit persons to whom the Software is furnished to do so, subject to the following conditions:

The above copyright notice and this permission notice shall be included in all copies or substantial portions of the Software.

THE SOFTWARE IS PROVIDED "AS IS", WITHOUT WARRANTY OF ANY KIND, EXPRESS OR IMPLIED, INCLUDING BUT NOT LIMITED TO THE WARRANTIES OF MERCHANTABILITY, FITNESS FOR A PARTICULAR PURPOSE AND NONINFRINGEMENT. IN NO EVENT SHALL THE AUTHORS OR COPYRIGHT HOLDERS BE LIABLE FOR ANY CLAIM, DAMAGES OR OTHER LIABILITY, WHETHER IN AN ACTION OF CONTRACT, TORT OR OTHERWISE, ARISING FROM, OUT OF OR IN CONNECTION WITH THE SOFTWARE OR THE USE OR OTHER DEALINGS IN THE SOFTWARE.

■ About Ogg/Vorbis

Copyright © 2002-2008 Xiph.org Foundation

Redistribution and use in source and binary forms, with or without modification, are permitted provided that the following conditions are met:

- Redistributions of source code must retain the above copyright notice, this list of conditions and the following disclaimer.
- Redistributions in binary form must reproduce the above copyright notice, this list of conditions and the following disclaimer in the documentation and/or other materials provided with the distribution.
- Neither the name of the Xiph.org Foundation nor the names of its contributors may be used to endorse or promote products derived from this software without specific prior written permission.

THIS SOFTWARE IS PROVIDED BY THE COPYRIGHT HOLDERS AND CONTRIBUTORS "AS IS" AND ANY EXPRESS OR IMPLIED WARRANTIES, INCLUDING, BUT NOT LIMITED TO, THE IMPLIED WARRANTIES OF MERCHANTABILITY AND FITNESS FOR A PARTICULAR PURPOSE ARE DISCLAIMED. IN NO EVENT SHALL THE FOUNDATION OR CONTRIBUTORS BE LIABLE FOR ANY DIRECT, INDIRECT, INCIDENTAL, SPECIAL, EXEMPLARY, OR CONSEQUENTIAL DAMAGES (INCLUDING, BUT NOT LIMITED TO, PROCUREMENT OF SUBSTITUTE GOODS OR SERVICES; LOSS OF USE, DATA, OR PROFITS; OR BUSINESS INTERRUPTION) HOWEVER CAUSED AND ON ANY THEORY OF LIABILITY, WHETHER IN CONTRACT, STRICT LIABILITY, OR TORT (INCLUDING NEGLIGENCE OR OTHERWISE) ARISING IN ANY WAY OUT OF THE USE OF THIS SOFTWARE, EVEN IF ADVISED OF THE POSSIBILITY OF SUCH DAMAGE.

■ About RC4 Algorithm

Copyright Mocana Corp 2003-2005. All Rights Reserved.

Proprietary and Confidential Material.

■ About zlib Library

Copyright notice:

© 1995-2010 Jean-loup Gailly and Mark Adler

This software is provided 'as-is', without any express or implied warranty. In no event will the authors be held liable for any damages arising from the use of this software.

Permission is granted to anyone to use this software for any purpose, including commercial applications, and to alter it and redistribute it freely, subject to the following restrictions:

1. The origin of this software must not be misrepresented; you must not claim that you wrote the original software. If you use this software in a product, an acknowledgment in the product documentation would be appreciated but is not required.
2. Altered source versions must be plainly marked as such, and must not be misrepresented as being the original software.
3. This notice may not be removed or altered from any source distribution.

Do not disassemble, decompile, or reverse engineer the software included in Yamaha AV products.

List of remote control codes
Liste des codes de commande
Liste der Fernbedienungs-codes
Lista över fjärrstyrningskoder
Elenco dei codici di telecomando
Lista de códigos de mando a distancia

TV	
A.R. Systems	0320
Acme	0342
Acura	0323, 0343
ADC	0337
Admiral	0054, 0178, 0336, 0337, 0339, 0346, 0347
Advent	0158
Adventura	0057
Adyson	0277, 0282, 0342
Agashi	0277, 0282
Agazi	0337
Aiko	0277, 0282, 0320, 0323, 0342, 0343
Aim	0320
Aiwa	0078, 0379
Akai	0050, 0055, 0109, 0159, 0181, 0277, 0282, 0320, 0323, 0340, 0343, 0349, 0350
Akiba	0320, 0340
Akura	0320, 0323, 0337, 0340
Alaron	0277
Alba	0161, 0277, 0320, 0323, 0340, 0342, 0343, 0344, 0349, 0351, 0372, 0382
Albatron	0140
Alcyon	0171
Alleron	0059
Allorgan	0282
Allstar	0320, 0350
America Action	0179
AMOi	0276
Amplivision	0161, 0282, 0321, 0342
Amstrad	0320, 0323, 0337, 0340, 0343
Amtron	0058
Anam	0179, 0343
Anam National	0052, 0058
Anglo	0323, 0343
Anitech	0171, 0320, 0323, 0337, 0343
Ansonic	0161, 0168, 0320, 0323, 0341, 0343
AOC	0008, 0026, 0050, 0053
Apex	0039, 0111, 0217
Arcam	0277, 0282
Arcam Delta	0342
Aristona	0320, 0349, 0350
Arthur Martin	0321
ASA	0339, 0347
Asberg	0171, 0320, 0350
Astra	0343
Asuka	0277, 0282, 0337, 0340, 0342
Atlantic	0277, 0320, 0342, 0349, 0350
Atori	0323, 0343
Auchan	0321
Audiosonic	0161, 0282, 0320, 0340, 0342, 0343, 0349, 0350
AudioTon	0161, 0282, 0342
Audiovox	0058, 0179, 0194
Ausind	0171
Autovox	0171, 0282, 0337, 0339, 0342
Aventura	0051
Awa	0277, 0282
Axion	0156
Baird	0282
Bang & Olufsen	0180, 0339
Basic Line	0282, 0320, 0323, 0340, 0343, 0350
Bastide	0282, 0342
Baur	0320, 0349

Lijst met afstandsbedieningscodes
Liste over fjernbetjeningskoder
Liste over fjernkontrollkoder
Список кодов дистанционного управления
遥控器代码列表
리모콘코드목록

Bazin	0282
Beko	0161, 0269, 0294, 0302, 0311, 0320, 0328, 0351
Belcor	0008
Bell & Howell	0019, 0054
Benq	0097, 0242, 0361
Beon	0320, 0349, 0350
Best	0161
Bestar	0161, 0320, 0350
Binatone	0282, 0342
Blue Sky	0320, 0340
Blue Star	0348
Boots	0282, 0342
BPL	0320, 0348
Bradford	0058, 0179
Brandt	0322, 0345
Brilliant	0182
Brinkmann	0320
Brionvega	0320, 0339, 0349, 0350
Britannia	0277, 0282, 0342
Brockwood	0008
Broksonic	0109, 0179
Bruns	0339
BTC	0340
Bush	0269, 0282, 0283, 0304, 0320, 0323, 0328, 0332, 0340, 0343, 0344, 0346, 0348, 0349, 0350, 0372, 0382, 0463, 0470, 0472
byd:sign	0093
Candle	0008, 0026, 0050, 0057
Capsonic	0337
Carena	0320
Carnivale	0050
Carrefour	0344
Carver	0010
Cascade	0320, 0323, 0343
Casio	0367
Cathay	0320, 0349, 0350
CCE	0183, 0282
Celebrity	0055, 0107
Celera	0039
Centurion	0320, 0349, 0350
Century	0339
CGE	0161, 0171
Changhong	0039
Chimei	0273
Cimline	0323, 0343
Citizen	0007, 0008, 0026, 0050, 0058
City	0323, 0343
Clarion	0179
Clarivox	0349
Clatronic	0161, 0171, 0282, 0320, 0323, 0337, 0340, 0342, 0343, 0350, 0351
CMS	0277
CMS Hightec	0282
Coby	0197
Colortyme	0008, 0026
Commercial Solutions	0021
Concerto	0008, 0026
Concorde	0323, 0343
Condor	0161, 0277, 0320, 0323, 0342, 0350, 0351
Contec	0179, 0277, 0323, 0342, 0343, 0344
Contec/Cony	0012, 0058
Continental Edison	0345
Cosmel	0323, 0343
Craig	0058, 0179
Crosley	0010, 0037, 0171, 0339

Crown	0058, 0161, 0171, 0179, 0320, 0323, 0343, 0349, 0350, 0351	Elcit	0339	Frontech	0282, 0323, 0337, 0343, 0346, 0347	Grunpy	0058, 0059, 0179
CS Electronics	0277, 0340, 0342	Electa	0348	Fujitsu	0059, 0069, 0074, 0075, 0282	Haier	0157, 0233
CTC Clatronic	0341	ELECTRO TECH	0343	Fujitsu General	0282	Halifax	0277, 0282, 0337, 0342
CTX	0205	Electroband	0055, 0107	Fujitsu Siemens	0504, 0505, 0507, 0510, 0511	Hallmark	0008, 0026, 0031
Curtis Mathes	0007, 0008, 0010, 0019, 0021, 0026, 0049, 0050, 0178	Electrograph	0176	Funai	0051, 0058, 0059, 0112, 0113, 0115, 0118, 0119, 0179, 0337, 0488, 0489	Hampton	0277, 0282, 0342
CXC	0058, 0179	Electrohomet	0008, 0026, 0052, 0055	Futurtech	0058, 0179	Hanseatic	0161, 0168, 0282, 0320, 0323, 0342, 0343, 0344, 0349, 0350
Cybertron	0340	Element	0230	Galaxi	0320, 0351	Hantarex	0320, 0323, 0343
Cytron	0152	Elin	0277, 0320, 0323, 0342, 0349, 0350	Galaxis	0161, 0320	Hantor	0320
Daewoo	0007, 0008, 0026, 0037, 0053, 0167, 0266, 0275, 0277, 0282, 0315, 0320, 0323, 0331, 0335, 0342, 0343, 0350, 0381, 0465	Elite	0320, 0340, 0350	Gateway	0176, 0177, 0241	Harman/Kardon	0010
Dainichi	0277, 0340	Elman	0341	GBC	0323, 0343, 0344	Harvard	0058, 0179
Dansai	0277, 0282, 0320, 0337, 0349, 0350	Elta	0277, 0323, 0343	GE	0008, 0021, 0023, 0026, 0027, 0031, 0034, 0049, 0052, 0056, 0209	Harwood	0320, 0323
Dantax	0161, 0349	Emerson	0000, 0007, 0008, 0012, 0013, 0019, 0026, 0031, 0037, 0051, 0058, 0059, 0161, 0179, 0320, 0339	GEC	0282, 0320, 0342, 0347, 0349, 0350	Havermy	0178
Dawa	0320	Emprex	0154	Geloso	0323, 0343, 0346	HCM	0282, 0320, 0323, 0337, 0342, 0343, 0348
Daytron	0007, 0008, 0026, 0323, 0343	Envision	0008, 0026, 0050	General Technic	0323, 0343	Hema	0282, 0323
De Graaf	0346	Epson	0155, 0206, 0359	Genaxxa	0320, 0340, 0347, 0350	Hewlett Packard	0192
Decca	0282, 0320, 0342, 0349, 0350	Erres	0320, 0349, 0350	GFM	0128, 0227	Higashi	0277
Dell	0145, 0245	ESA	0051	Giant	0282	HiLine	0320
Denver	0358, 0362	ESC	0282	Gibraltar	0008, 0030, 0050, 0062	Hinari	0320, 0323, 0340, 0343, 0344, 0349, 0350
Desmet	0320, 0349, 0350	Etron	0343	GoldHand	0277	Hisawa	0321, 0340, 0348
Diamant	0320	Eurofeel	0282	Goldline	0320	Hisense	0247
Diamond	0277	Euro-Feel	0337	GoldStar	0007, 0008, 0012, 0026, 0031, 0050, 0053, 0161, 0277, 0282, 0320, 0323, 0342, 0343, 0346, 0349, 0350	Hitachi	0008, 0012, 0026, 0066, 0084, 0092, 0093, 0120, 0172, 0173, 0255, 0270, 0271, 0282, 0320, 0335, 0338, 0342, 0344, 0346, 0347, 0365, 0382, 0448, 0456, 0467, 0482, 0484, 0487
DiamondVision	0135, 0143	Euromann	0320, 0337, 0342, 0350	Goodmans	0246, 0272, 0282, 0320, 0323, 0337, 0343, 0344, 0349, 0350, 0462, 0473, 0477	Hornophon	0320, 0350
Dimensia	0049	Europhon	0277, 0282, 0320, 0341, 0342, 0350	Gorenje	0161, 0351	Hoshai	0340
Disney	0219	Expert	0321	GPM	0340	Huanyu	0277, 0342
Dixi	0282, 0320, 0323, 0343, 0349, 0350	Exquisit	0320	GPX	0129	Hygashi	0277, 0282, 0342
Dream Vision	0461, 0498	Fenner	0323, 0343	Gradiente	0240	Hyper	0277, 0282, 0323, 0342, 0343
DTS	0323, 0343	Ferguson	0322, 0345, 0349	Graetz	0347	Hypson	0282, 0320, 0321, 0337, 0342, 0348, 0349, 0350
Dual	0282, 0320, 0342	Fidelity	0277, 0320, 0342, 0346	Granada	0171, 0282, 0320, 0321, 0342, 0344, 0346, 0349, 0350	Hyundai	0141
Dual-Tec	0342, 0343	Filsai	0282	Grandin	0340, 0343, 0348, 0349	Iberia	0320
Dumont	0008, 0030, 0062, 0282, 0339, 0341, 0342	Finlandia	0346	Gronic	0282	ICE	0277, 0282, 0320, 0323, 0337, 0340, 0342, 0343, 0350
Durabrand	0031, 0051, 0179, 0215	Finlux	0171, 0282, 0320, 0339, 0341, 0342, 0349, 0350	Grundig	0160, 0161, 0171, 0310, 0320	ICeS	0277
Dux	0349	FIRST LINE	0342, 0343, 0350			Ilo	0148, 0153
Dwin	0178	Firstline	0277, 0282, 0320, 0323			IMA	0058
Dynatron	0320, 0349, 0350	Fisher	0019, 0161, 0282, 0339, 0342, 0344, 0351			Imperial	0161, 0171, 0320, 0347, 0350, 0351
Dynex	0228, 0231	Flint	0320, 0350				
EIZO	0509	Formenti	0171, 0277, 0336, 0339, 0342, 0349				
Elbe	0161, 0168, 0282, 0320	Formenti/Phoenix	0277				
		Fortress	0336, 0339				
		Fraba	0161, 0320				
		Friac	0161				

Indiana	0320, 0349, 0350	Kingsley	0277, 0342	Magnavox	0008, 0009, 0010, 0013,	Motion	0171
Infinity	0010	KLH	0039		0026, 0032, 0033, 0048,	Motorola	0052, 0178
InFocus	0250, 0327, 0363, 0479,	Kloss Novabeam	0057, 0058		0050, 0128, 0211, 0212,	MTC	0008, 0026, 0050, 0053,
	0508	Kneissel	0161, 0168, 0320		0224, 0226, 0239		0161, 0277
Ingelen	0347	Kolster	0320, 0350	Magnum	0337, 0343	Multi System	0349
Ingersol	0323, 0343	Konka	0340	Majestic	0054	Multitech	0058, 0161, 0179, 0183,
Initial	0153	Korpel	0320, 0349, 0350	Mandor	0337		0277, 0282, 0320, 0323,
Inno Hit	0171, 0282, 0320, 0323,	Korting	0161, 0339	Manesth	0282, 0320, 0337, 0342,		0341, 0342, 0343, 0344,
	0340, 0342, 0343, 0349,	Kosmos	0320		0349, 0350		0346, 0349
	0350	Koyoda	0343	Marantz	0008, 0010, 0026, 0050,	Murphy	0277, 0342
Innovation	0337, 0343	KTV	0007, 0050, 0058, 0179,		0204, 0320, 0349, 0350	NAD	0026, 0031, 0111
Insighia	0131, 0228, 0236, 0238		0183, 0282, 0342	Marelli	0339	Naonis	0346
Inteq	0030	Kyoto	0277, 0282	Mark	0277, 0282, 0320, 0323,	NEC	0008, 0026, 0050, 0052,
Interactive	0161	Lasat	0161		0349, 0350		0053, 0072, 0103, 0282,
Interbuy	0323, 0343	Lenco	0323, 0343	Masuda	0282		0344
Interfunk	0161, 0320, 0339, 0347,	Lenoir	0323, 0342, 0343	Matsui	0282, 0320, 0323, 0342,	Neckermann	0161, 0282, 0320, 0339,
	0349, 0350	Leyco	0320, 0337, 0349, 0350		0343, 0344, 0346, 0349,		0342, 0346, 0349, 0350,
International	0277	LG	0031, 0053, 0066, 0116,		0350, 0455		0351
Intervision	0161, 0282, 0320, 0337,		0117, 0140, 0161, 0164,	Matsushita	0017	NEI	0320, 0349, 0350
	0341, 0342		0175, 0195, 0269, 0277,	Maxent	0147, 0176	Net-TV	0176
Irradio	0171, 0320, 0323, 0340,		0282, 0300, 0309, 0317,	Mediator	0320, 0349, 0350	Neufunk	0320, 0323
	0343, 0349, 0350		0320, 0323, 0328, 0342,	Medion	0320, 0337, 0343	New Tech	0343, 0350
Isukai	0320, 0340		0343, 0346, 0349, 0350,	Megapower	0140	New World	0340
ITC	0282, 0342		0366, 0368, 0377, 0466,	Megatron	0026, 0031	NewTech	0282, 0320, 0323
ITS	0277, 0320, 0340, 0348,		0471, 0478	MElectronic	0277, 0282, 0320, 0323	Nicamagic	0277, 0342
	0350	LG/GoldStar	0164	Melvox	0321	Nikkai	0277, 0282, 0320, 0323,
ITT	0343, 0347	Liesenk	0349	Memorex	0019, 0026, 0031, 0053,		0337, 0340, 0342, 0349,
ITV	0320, 0343, 0349	Liesenkotter	0320		0054, 0137, 0215, 0323,		0350
Janeil	0057	Life	0337, 0343		0343	Nikko	0026, 0031, 0050
JBL	0010	Lifetec	0320, 0323, 0337, 0343	Memphis	0323, 0343	Noblisko	0171, 0277, 0341, 0342
JC Penney	0007, 0008, 0026, 0027,	Lloyds	0323	Mercury	0320, 0323	Nokia	0347
	0049, 0053, 0056	Loewe	0161, 0168, 0265, 0320,	Metz	0339	Norcent	0201
JCB	0055, 0107		0330, 0352	MGA	0008, 0026, 0031, 0050,	Nordic	0282
Jensen	0008, 0026	Loewe Opta	0339, 0349, 0350		0053	Nordmende	0339, 0345, 0347, 0350
JVC	0012, 0014, 0015, 0056,	Logik	0054	Micromaxx	0337, 0343	Nordvision	0349
	0064, 0065, 0067, 0169,	Luma	0320, 0323, 0346, 0349	Microstar	0337, 0343	Novatronic	0320
	0174, 0297, 0314, 0344,	Lumatron	0282, 0320, 0346, 0349,	Midland	0007, 0021, 0023, 0027,	Oceanic	0321, 0347
	0350, 0375		0350		0030, 0056, 0062	Okano	0161, 0320, 0351
Kaisui	0277, 0282, 0320, 0323,	Lux May	0350	Minerva	0171	Olevia	0102, 0199, 0200, 0207,
	0340, 0342, 0343, 0348	Luxman	0008, 0026	Minoka	0320, 0350		0222
Kamosonic	0342	Luxor	0282, 0342, 0346	Mintek	0153	ONCEAS	0342
Kamp	0277, 0342	LXI	0010, 0019, 0021, 0026,	Mitsubishi	0008, 0026, 0031, 0053,	Onwa	0058, 0179
Kapsch	0347		0027, 0031, 0049, 0111		0066, 0084, 0093, 0098,	Opera	0320
Karcher	0161, 0320, 0342, 0343,	M Electronic	0342, 0343, 0345, 0347,		0150, 0178, 0289, 0320,	Oppo	0130
	0349		0349, 0350		0339, 0344, 0350, 0376	Optimus	0017, 0019
Kawasho	0008, 0026, 0055, 0277	MAG	0096	Mivar	0161, 0168, 0171, 0277,	Optoma	0144
KEC	0179	Magnadyne	0339, 0341, 0349		0282, 0342	Optonica	0178
Kendo	0161, 0320, 0341, 0346	Magnafon	0171, 0277, 0341, 0342	Monivision	0140	Orbit	0320, 0350
Kenwood	0008, 0026, 0050			Montgomery Ward			
KIC	0282				0054		

Orion	0043, 0146, 0283, 0320, 0323, 0328, 0343, 0349, 0350	Phonola	0277, 0320, 0339, 0349, 0350	RCA	0008, 0021, 0024, 0025, 0026, 0027, 0042, 0049, 0052, 0053, 0063, 0136, 0225	Schneider	0282, 0316, 0318, 0320, 0333, 0340, 0342, 0349, 0350, 0382
Orline	0320	Pilot	0007, 0008, 0050	Realistic	0019, 0031, 0050, 0179	Scotch	0026, 0031
Osaki	0282, 0320, 0337, 0340, 0342	Pioneer	0008, 0026, 0094, 0095, 0161, 0320, 0345, 0347, 0349, 0350, 0458, 0480	Recor	0320	Scott	0008, 0012, 0026, 0031, 0058, 0059, 0149, 0179
Oso	0340	Plantron	0320, 0323, 0337, 0350	Redstar	0320	Sears	0008, 0010, 0019, 0021, 0026, 0027, 0031, 0049, 0051, 0059, 0111
Otto Versand	0282, 0320, 0336, 0342, 0344, 0348, 0349, 0350	Playsonic	0282	Reflex	0320	SEG	0277, 0282, 0320, 0323, 0337, 0341, 0342, 0344, 0349, 0382
Pael	0277, 0342	Polaroid	0039, 0142, 0202, 0234	Revox	0161, 0320, 0349, 0350	SEI	0320
Palladium	0161, 0282, 0320, 0342, 0351	Poppy	0323, 0343	Rex	0337, 0346, 0347	SEI-Sinudyne	0339, 0341, 0347
Palsonic	0282	Portland	0007, 0008, 0026, 0053	RFT	0161, 0168, 0339	Seleco	0344, 0346, 0347
Panama	0277, 0282, 0320, 0323, 0337, 0342, 0343	Prandoni-Prince	0171, 0346	Rhapsody	0277	Sencora	0323, 0343
Panasonic	0016, 0017, 0020, 0022, 0023, 0035, 0052, 0056, 0084, 0085, 0133, 0163, 0193, 0284, 0286, 0290, 0292, 0320, 0325, 0347, 0356, 0483, 0485, 0490	Precision	0282, 0342	R-Line	0320, 0349, 0350	Sentra	0323
Panavision	0320	Prima	0157, 0243, 0323, 0343, 0347	Roadstar	0323, 0337, 0340, 0343	Serino	0277
Pathe Cinema	0161, 0168, 0277, 0321, 0342	Princeton	0140	Robotron	0339	Sharp	0000, 0001, 0002, 0003, 0007, 0008, 0012, 0026, 0060, 0088, 0089, 0091, 0138, 0165, 0170, 0178, 0198, 0229, 0262, 0278, 0279, 0291, 0308, 0312, 0336, 0344, 0354, 0370, 0449, 0450, 0451, 0464, 0474, 0476, 0481
Pausa	0323, 0343	Prism	0023, 0056	Rowa	0277, 0282	Sheng Chia	0178
Penney	0021, 0023, 0031, 0050, 0111	Profex	0323, 0343	Royal Lux	0161	Shogun	0008
Perdio	0277, 0320	Profi-Tronic	0320, 0350	RTF	0339	Siarem	0320, 0339, 0341
Perfekt	0320	Proline	0320, 0350	Runco	0030, 0050, 0062	Sierra	0320, 0350
Philco	0008, 0009, 0010, 0012, 0026, 0050, 0052, 0053, 0161, 0171, 0320, 0339	Proscan	0021, 0027, 0049	Saba	0298, 0322, 0339, 0345, 0347	Siesta	0161
Philharmonic	0282, 0342	Prosonic	0161, 0277, 0282, 0320, 0342, 0349	Saisho	0282, 0323, 0337, 0342, 0343	Signature	0054
Philips	0008, 0009, 0010, 0011, 0012, 0032, 0048, 0049, 0052, 0122, 0128, 0134, 0186, 0187, 0213, 0221, 0224, 0226, 0239, 0256, 0257, 0259, 0261, 0263, 0267, 0280, 0281, 0287, 0296, 0299, 0301, 0303, 0305, 0313, 0319, 0320, 0324, 0333, 0339, 0342, 0349, 0350, 0353, 0357, 0360, 0380, 0383, 0452, 0459, 0460	Protech	0282, 0337, 0341, 0342, 0343, 0349, 0350	Salora	0346, 0347	Silver	0344
Philips Magnavox	0011, 0032, 0033	Proton	0008, 0012, 0026, 0031	Sambers	0171, 0341	Singer	0321, 0339, 0341
Phoenix	0161, 0277, 0320, 0339, 0349, 0350	Protron	0196	Sampo	0007, 0008, 0026, 0050, 0176	Sinudyne	0320, 0339, 0341, 0349
		PROVIEW	0096, 0246	Samsung	0004, 0005, 0006, 0007, 0008, 0012, 0026, 0031, 0036, 0050, 0053, 0076, 0077, 0079, 0114, 0124, 0125, 0126, 0127, 0139, 0161, 0183, 0185, 0190, 0191, 0258, 0264, 0277, 0282, 0320, 0323, 0334, 0337, 0342, 0343, 0349, 0350, 0351, 0373, 0453, 0468	Skantic	0347
		Provision	0320, 0349	Sandra	0277, 0282, 0342	Solavox	0347
		Pulsar	0008, 0030, 0062	Sansui	0043, 0109, 0320, 0350	Sonitron	0161, 0282
		Pye	0256, 0320, 0349, 0350, 0378	Sanyo	0008, 0019, 0068, 0070, 0071, 0099, 0161, 0168, 0223, 0237, 0277, 0282, 0288, 0295, 0323, 0342, 0344, 0369, 0469	Sonoko	0282, 0320, 0323, 0337, 0342, 0343, 0349, 0350
		Pymi	0323, 0343			Sonolor	0321, 0347
		Quandra Vision	0321			Sontec	0161, 0320, 0349, 0350
		Quasar	0017, 0023, 0052, 0056				
		Quelle	0282, 0320, 0337, 0342, 0349, 0350				
		Questa	0344				
		Radialva	0320				
		RadioShack	0019, 0021, 0031, 0050, 0179, 0320				
		RadioShack/Realistic	0007, 0008, 0012, 0026, 0049, 0058				
		Radiola	0282, 0320, 0349, 0350				
		Radiomarelli	0320, 0339				
		Radiotone	0161, 0320, 0323, 0350	SBR	0320, 0349		
		Rank	0344	Sceptre	0235, 0244		
				Schaub Lorenz	0347		

Sony	0038, 0044, 0045, 0047, 0055, 0090, 0104, 0105, 0107, 0110, 0123, 0184, 0220, 0248, 0249, 0251, 0252, 0254, 0326, 0343, 0344, 0371, 0374, 0457, 0475, 0486	Teac	0282, 0320	Uher	0161, 0171, 0320, 0347, 0350	Yamishi	0282, 0320
Sound & Vision	0340, 0341	Tec	0282, 0323, 0342, 0343	Ultravox	0277, 0320, 0339, 0341, 0342	Yokan	0320
Soundesign	0008, 0026, 0031, 0058, 0059, 0179	Technics	0017, 0023, 0056	Unic Line	0320	Yoko	0161, 0277, 0282, 0320, 0323, 0337, 0340, 0342, 0343, 0349, 0350
Soundwave	0320, 0349, 0350	TechniSat	0274, 0496, 0497, 0499	United	0349	Yorx	0340
Squareview	0051	Techwood	0008, 0023, 0026, 0056	Universum	0161, 0171, 0282, 0320, 0337, 0349, 0350, 0351	Zanussi	0282, 0346
SSS	0008, 0058, 0179	TEDELEX	0282	Univox	0320	Zenith	0008, 0028, 0029, 0030, 0031, 0054, 0061, 0062
Standard	0282, 0320, 0323, 0340, 0342, 0343, 0350	Teknika	0007, 0008, 0010, 0012, 0026, 0053, 0054, 0058, 0059, 0179	Vector Research	0050		
Starlite	0058, 0179, 0320, 0323, 0349	Teleavia	0345	Vestel	0282, 0320, 0346, 0347, 0349, 0350, 0351		
Stenway	0348	Telecor	0282, 0320	Vexa	0320, 0323, 0343, 0349	VCR	
Stern	0346, 0347	Telefunken	0320, 0322, 0345, 0350	Victor	0015, 0344, 0350	ABS	1016
Strato	0320, 0323	Telegazi	0320	VIDEOLÓGIC	0277	Adventura	1069
Stylandia	0282	Telemeister	0320	Videologique	0277, 0282, 0340, 0342	Adyson	1008
Sunkai	0343	Telesonic	0320	VideoSystem	0320, 0350	Aiwa	1024, 1026, 1027, 1069
Sunstar	0320, 0323	Telestari	0320	Videotechnic	0277, 0282	Akai	1021, 1027
Sunwood	0320, 0323, 0343, 0350	Teletech	0320, 0323, 0343, 0349	Vidikron	0010	Akiba	1008, 1029
Superla	0277, 0282, 0342	Teleton	0282, 0342	Vidtech	0008, 0026, 0031, 0053	Akura	1008, 1027, 1029
Superscan	0013, 0178	Televideo	0277	Viewsonic	0176, 0203, 0232, 0364	Alba	1008, 1009, 1024, 1025, 1029, 1030
SuperTech	0277, 0320, 0323	Televiso	0321	Viking	0057	Alienware	1016
Supra	0323, 0343	Tensai	0282, 0320, 0323, 0340, 0343, 0350	Viore	0148	Ambassador	1030
Supre-Macy	0057	Tesmet	0350	Visiola	0277, 0342	American High	1068
Supreme	0055, 0107	Tevion	0337, 0343	Vision	0282, 0320, 0350	Amstrad	1008, 1009, 1026
Susumu	0340	Texet	0277, 0282, 0323, 0342	Vizio	0008, 0177, 0218, 0242, 0500, 0501, 0502, 0503, 0506	Anitech	1008, 1029
Sutron	0323, 0343	Thomson	0162, 0188, 0189, 0285, 0320, 0322, 0342, 0345, 0350	Vortec	0320, 0349, 0350	Apex	1088
SVA	0151	Thorn	0320, 0349	Voxson	0171, 0320, 0339, 0346, 0347, 0350	ASA	1028, 1031
Sydney	0277, 0282, 0342	TMK	0008, 0026, 0031	Waltham	0282, 0320, 0342	Asha	1070
Sylvania	0008, 0009, 0010, 0011, 0013, 0026, 0048, 0050, 0051, 0128, 0227, 0253	TNCi	0030	Wards	0282, 0320, 0342	Asuka	1008, 1026, 1028, 1029, 1031
Symphonic	0051, 0058, 0062, 0128, 0179, 0215	Tokai	0282, 0320, 0350	Watson	0008, 0009, 0010, 0026, 0031, 0048, 0049, 0050, 0053, 0054, 0059	Audio Dynamics	1064
Syntax	0199	Tokyo	0277, 0342	Watt Radio	0320, 0349, 0350	Audiosonic	1009
Syntax-Brilliant	0199	Tomashi	0348	Waycon	0277, 0341, 0342	Audiovox	1071
Sysline	0349	Toshiba	0018, 0019, 0040, 0041, 0046, 0073, 0100, 0103, 0108, 0109, 0111, 0121, 0132, 0166, 0208, 0210, 0214, 0217, 0260, 0268, 0282, 0283, 0293, 0304, 0306, 0307, 0329, 0344, 0355, 0454, 0491	Wega	0320, 0339, 0344	Baird	1009, 1025, 1026, 1027
Sytong	0277	Totevision	0007	Wegavox	0323	Bang & Olufsen	1017
Tandy	0178, 0282, 0336, 0340, 0342, 0347	Towada	0282, 0347	Weltblick	0282, 0320, 0349, 0350	Basic Line	1008, 1009, 1024, 1025, 1029, 1030
Tashiko	0277, 0282, 0342, 0344, 0346	Trakton	0282	Westinghouse	0107, 0216, 0220	Baur	1028
Tatung	0052, 0177, 0282, 0320, 0342, 0349, 0350	Trans Continen	0282, 0320	White Westinghouse	0037, 0090, 0277, 0320, 0341, 0342, 0349	Beaumarck	1070
TCM	0337, 0343	Transtec	0277	Wincom	0101, 0106	Bell & Howell	1065
		Trident	0282	Xrypton	0320	Bestar	1009, 1025, 1030
		Triumph	0320	Yamaha	0008, 0026, 0050, 0053, 0080, 0081, 0082, 0083, 0086, 0087	Black Panther Line	1009, 1025
						Blaupunkt	1028
						Bondstec	1008, 1030
						Broksonic	1100

Bush	1008, 1009, 1024, 1025, 1029, 1049, 1051, 1063, 1217	ESC	1009, 1025	HTS	1018	Magnavox	1020, 1068, 1114, 1126
Calix	1071	Etzuko	1008, 1029	Hughes	1111, 1113, 1122	Magnin	1071
Candle	1070, 1071	Expressvu	1018	Hughes Network Systems	1110, 1116	Manesth	1008, 1029
Canon	1068	Ferguson	1027	Humax	1012, 1110, 1113	Marantz	1028, 1064, 1065, 1068
Cathay	1009	Fidelity	1008, 1026	Hush	1016	Mark	1009
Catron	1030	Finlandia	1028	Hypson	1008, 1009, 1024, 1029	Marta	1071
CGE	1026, 1027	Finlux	1026, 1027, 1028	iBUYPOWER	1016	Matsui	1024, 1031
Cimline	1008, 1024, 1029	Firstline	1008, 1024, 1029, 1031	Impego	1030	Matsushita	1068
CineVision	1104	Fisher	1065	Imperial	1026	Media Center PC	1016
Citizen	1070, 1071	Flint	1024	Inno Hit	1008, 1009, 1025, 1028, 1029, 1030	Mediator	1028
Clatronic	1008, 1030	Formenti/Phoenix	1028	Innovation	1024	Medion	1024
Colortyme	1064	Frontech	1030	Instant Replay	1068	MEI	1068
Condor	1009, 1025, 1030	Fuji	1068	Interbuy	1008, 1031	Memorex	1023, 1026, 1031, 1065, 1068, 1069, 1070, 1071, 1098, 1114
Craig	1070, 1071	Fujitsu	1026	Interfunk	1028	Memphis	1008, 1029
Crown	1008, 1009, 1025, 1029, 1030	Funai	1026, 1069	Intervision	1009, 1026	MGN Technology	1070
Curtis Mathes	1064, 1068, 1070	Garrard	1069	Irradio	1008, 1029, 1031	Micromaxx	1024
Cybernex	1070	Gateway	1016	ITT	1027	Microsoft	1016
CyberPower	1016	GBC	1029, 1030	ITV	1009, 1025, 1031	Microstar	1024
Daewoo	1009, 1025, 1030, 1038, 1069, 1223	GE	1068, 1070	JC Penney	1064, 1065, 1068, 1070, 1071	Migros	1026
Dansai	1008, 1009, 1029	GEC	1028	JCL	1068	Mind	1016
Dantax	1024	Geloso	1029	JVC	1007, 1018, 1027, 1039, 1064, 1065, 1066, 1067, 1078, 1089, 1092, 1093, 1094, 1095, 1113, 1208, 1209, 1212, 1213, 1215, 1218	Mitsubishi	1026, 1028, 1079
Daytron	1009, 1025	General	1030	Kaisui	1008, 1029	Motorola	1068
DBX	1064	General Technic	1024	Karcher	1028	MTC	1070
De Graaf	1028	GOI	1018	Kendo	1008, 1024, 1025, 1030	Multitech	1008, 1026, 1028, 1029, 1030, 1069, 1070
Decca	1026, 1027, 1028	GoldHand	1008, 1029	Kenwood	1027, 1064, 1065	Murphy	1026
Dell	1016	Goldstar	1026, 1031, 1064, 1071	Kodak	1068, 1071	NEC	1027, 1064, 1065
Denko	1008	Goodmans	1008, 1009, 1025, 1026, 1029, 1030, 1031	Korpel	1008, 1029	Neckermann	1027, 1028
DiamondVision	1096	Gradiente	1069	Kyoto	1008	NEI	1028
DigiFusion	1014	Graetz	1027	Lenco	1025	Nesco	1008, 1029
DIRECTV	1019, 1105, 1110, 1111, 1113, 1116, 1122	Granada	1028	Leyco	1008, 1029	Nikkai	1008, 1009, 1030
Dish Network	1018	Grandin	1008, 1009, 1025, 1026, 1029, 1030, 1031	LG	1010, 1026, 1031, 1047, 1054, 1056, 1071, 1103, 1221	Nikko	1071
Dishpro	1018	Grundig	1028, 1029	Lifetec	1024	Niveus Media	1016
Dual	1009, 1027, 1028	Hanseatic	1009, 1028, 1031	Linksys	1016	Noblex	1070
Dumont	1026, 1028	Harley Davidson	1069	Lloyd's	1069	Nokia	1009, 1027
Durabrand	1114	Harman/Kardon	1064	Loewe Opta	1028, 1031	Nordmende	1027
Dynatech	1069	Harwood	1008	Logik	1008, 1029	Northgate	1016
Echostar	1018	HCM	1008, 1029	Lumatron	1009, 1025	Oceanic	1026, 1027
Elbe	1009	Headquarter	1065	Luxor	1008	Okano	1008, 1009, 1024
Elcatech	1008	Hewlett Packard	1016	LXI	1071	Olympus	1068
Electrohome	1071	Hinari	1008, 1009, 1024, 1029	M Electronic	1026	Optimus	1071
Electrohome	1071	Hisawa	1024			Orion	1023, 1024, 1051, 1115, 1217
Elsay	1008	Hitachi	1011, 1026, 1027, 1028, 1046, 1062			Orson	1026
Elta	1008, 1009, 1029	HNS	1110			Osaki	1008, 1026, 1029, 1031
Emerson	1008, 1020, 1068, 1069, 1071	Howard Computers	1016			Otto Versand	1028
		HP	1016			Palladium	1008, 1027, 1029, 1031

Brandt	2148, 2188	DVX	2355	Irradio	2053	Memorex	2028, 2145, 2234
Broksonic	2145, 2146	Easy Home	2359	iSymphony	2246	MiCO	2354, 2382
Bush	2064, 2110, 2170, 2268, 2290, 2346, 2358, 2367, 2383	Eclipse	2354	JBL	2135	Micromaxx	2182
California Audio Labs		E-Dem	2364	JVC	2020, 2096, 2097, 2099, 2100, 2101, 2102, 2103, 2106, 2107, 2160, 2257, 2260, 2262, 2263, 2321, 2324, 2326, 2327, 2343, 2464, 2465, 2468, 2469, 2471	Microsoft	2156
Cambridge Audio	2151	Electrohome	2362			Microstar	2182
CAT	2354	Elin	2362			Minoka	2362
CAVS	2352, 2353	Elta	2341, 2361, 2362			Minowa	2367
CAVS	2192	Emerson	2129, 2137, 2150			Mintek	2131, 2245
Centrum	2353	Enterprise	2129			Mitsubishi	2003
CGV	2354, 2362	Enzer	2380	Jwin	2198	Mizuda	2358, 2359
Changhong	2140	Epson	2247	Kansai	2360	Monyka	2380
Cinetec	2363	ESA	2137	Kawasaki	2149	Mustek	2186
CineVision	2133, 2237	Finlux	2354, 2362, 2367	Kenex	2362	Mx Onda	2354
Clatronic	2358, 2367	Fintec	2377	Kenwood	2041, 2151, 2348	Mystral	2366
Coby	2031, 2046, 2360	Fisher	2134	KeyPlug	2362	Naiko	2362
Conia	2383	Funai	2137	Kiuro	2362	Nesa	2131
Continental Edison		Gateway	2051	Kingavon	2358	Neufunk	2380
	2363	GE	2029, 2131, 2156	Kiss	2380	Nevir	2362
Crown	2362	Gericom	2351	KLH	2131, 2149	Next Base	2143
C-Tech	2355	GFM	2226	Koda	2358	Nexxtech	2243
Curtis Mathes	2139	Giec	2382	Koss	2013, 2148, 2158	NU-TEC	2383
CVG	2377	Global Solutions	2355	KXD	2359	Onkyo	2159, 2368
CyberHome	2022, 2098, 2138, 2187, 2336	Global Sphere	2355	Landel	2143	Oopla	2051
		Go Video	2133, 2213	Lasonic	2132	Oppo	2196, 2255
Cytron	2244	Goodmans	2165, 2280, 2291, 2358, 2371, 2376, 2382	Lawson	2355	Optim	2381
Daenyx	2363	GPX	2227	Lecson	2381	Optimus	2180
Daewoo	2001, 2133, 2276, 2298, 2330, 2362, 2363, 2377	Gradiente	2151	Lenco	2358, 2362, 2367	Orava	2358
Daewoo International		Graetz	2380	Lenoxx	2136, 2153	Orbit	2363
	2363	Greenhill	2131	LG	2002, 2033, 2038, 2057, 2129, 2133, 2189, 2191, 2223, 2238, 2270, 2288, 2335, 2373, 2375	Orion	2073, 2110
Dalton	2357	Grundig	2349			Oritron	2148, 2158
Dansai	2362, 2381	Grunkel	2362, 2366	Life	2182	P&B	2358
Daytek	2184, 2195, 2363	GVG	2377	Lifetec	2182	Pacific	2355
Dayton	2363	H&B	2358	Limit	2355	Panasonic	2011, 2024, 2034, 2042, 2058, 2062, 2066, 2067, 2093, 2116, 2117, 2118, 2119, 2120, 2121, 2122, 2123, 2151, 2159, 2164, 2166, 2167, 2172, 2173, 2175, 2209, 2214, 2275, 2277, 2278, 2281, 2282, 2283, 2301, 2374, 2470
DEC	2358	Haaz	2354, 2355	Liquid Video	2158		2197
Decca	2362	Haier	2254	Liteon	2043, 2051, 2142	Parasound	2197
Denon	2059, 2151, 2193, 2332	Harman/Kardon	2047, 2135	Loewe	2320	peekTON	2364
Denver	2356, 2358, 2360, 2370	HiMAX	2359	LogicLab	2355		
Denzel	2380	Hitachi	2062, 2090, 2115, 2274, 2316, 2359, 2380	Magnavox	2025, 2050, 2137, 2150, 2159, 2224, 2230, 2358		
Desay	2205	Hiteker	2130				
Diamond	2354, 2355	Home Tech Industries		Magnex	2367		
DiamondVision	2225, 2232		2364	Majestic	2360		
Disney	2010, 2028	Hyundai	2366	Marantz	2328		
DK Digital	2339	Ilo	2245	Marquant	2362		
Dmtech	2176	Initial	2131, 2245	Matsui	2148, 2378		
Dual	2380	Innovation	2182	McIntosh	2199		
DUNE	2473	Insighia	2002, 2137, 2253	Mecotek	2362		
Durabrand	2136	Integra	2157	Medion	2182		

Philips	2008, 2012, 2025, 2044, 2050, 2051, 2053, 2060, 2072, 2108, 2111, 2147, 2159, 2163, 2169, 2174, 2181, 2185, 2230, 2261, 2266, 2267, 2286, 2287, 2289, 2295, 2300, 2302, 2317, 2328, 2338, 2342, 2350, 2467	Samsung	2000, 2045, 2077, 2112, 2113, 2114, 2115, 2151, 2200, 2216, 2219, 2228, 2264, 2265, 2271, 2279, 2294, 2303, 2329, 2365	Symphonic	2108, 2230	Yukai	2186
Phonotrend	2367	Sansui	2073, 2145, 2354, 2355, 2362	Synn	2355	Zenith	2002, 2129, 2133, 2159, 2223
Pioneer	2016, 2017, 2018, 2019, 2035, 2092, 2094, 2095, 2109, 2157, 2180, 2190, 2212, 2269, 2272, 2299, 2304, 2305, 2306, 2307, 2308, 2309, 2310, 2311, 2344, 2345, 2347, 2379	Sanyo	2134, 2145, 2217, 2292	T.D.E. Systems	2366	<hr/>	
Pointer	2362	ScanMagic	2186	Tatung	2001, 2362	Blu-ray Disc	
Polaroid	2125, 2215, 2235	Schaub Lorenz	2362	TCM	2182, 2297	Denon	2452, 2500, 2501
Portland	2362	Schneider	2176	Teac	2149, 2333, 2355, 2383	Hitachi	2460, 2461, 2463
Powerpoint	2363	Scientific Labs	2355	Tec	2356	JVC	2472, 2473, 2475, 2478, 2496, 2499, 2511
Prima	2252	Scott	2161, 2357	Technics	2151	LG	2033, 2456, 2457
Proceed	2130	Seeltech	2364	Technika	2362, 2367	Marantz (US)	2454, 2455
Proscan	2156	SEG	2161, 2355, 2363, 2380	Telefunken	2353	Mitsubishi	2450, 2451
Prosonic	2360, 2377	Sharp	2006, 2040, 2088, 2091, 2182, 2194, 2220, 2221, 2231, 2236, 2293, 2340	Tensai	2362	Onkyo	2504
Protron	2202	Shinsonic	2245	Tevion	2182, 2355, 2357	Panasonic	2011, 2209, 2214, 2476, 2477, 2479
Provision	2358	Sigmatek	2359, 2364	Theta Digital	2157	Philips	2510
Pye	2144	Silva	2356	Thomson	2183, 2188, 2334, 2372	Pioneer	2212, 2506
Qwestar	2148	Singer	2354, 2355	Tokai	2356, 2380	Samsung	2045, 2113, 2498
Raite	2380	Skymaster	2325, 2355	Top Suxess	23647	Sharp	2194, 2220, 2221, 2497, 2502, 2503
RCA	2021, 2029, 2104, 2105, 2131, 2149, 2156, 2157, 2229	Skyworth	2356	Toshiba	2032, 2036, 2037, 2039, 2048, 2049, 2054, 2055, 2072, 2073, 2076, 2078, 2079, 2086, 2145, 2159, 2218, 2233, 2256, 2259, 2296, 2369, 2472	Sony	2075, 2453, 2458, 2459, 2507
RedStar	2356, 2360, 2362	SLM Art	2362	TRANScontinents	2363, 2367	Toshiba	2462
Regent	2153	SM Electronic	2355	Transonic	2367	Yamaha	2064, 2448, 2449, 2474, 2505
Reoc	2355	Sonic Blue	2133	Trio	2362	<hr/>	
Rimax	2361	Sontech	2366	Trutech	2242	DVR	
Rio	2133	Sony	2004, 2005, 2007, 2009, 2014, 2015, 2023, 2026, 2027, 2052, 2068, 2069, 2070, 2071, 2074, 2075, 2084, 2085, 2087, 2168, 2171, 2208, 2210, 2211, 2258, 2273, 2284, 2285, 2312, 2313, 2314, 2315, 2318, 2319, 2466	TruVision	2359	Bush	2110
Roadstar	2331, 2358	Soundmaster	2355	TSM	2364	Hitachi	2090
Ronin	2363	Soundmax	2355	Umax	2361	Panasonic	2066, 2067, 2093, 2116, 2117, 2119, 2120, 2122, 2123
Rotel	2203	Spectra	2363	United	2367	Philips	2108, 2111
Rowa	2154, 2383	Spectroniq	2201	Urban Concepts	2159	Pioneer	2016, 2017, 2018, 2019, 2092, 2094, 2095, 2109
Rowsonic	2353	Standard	2355	US Logic	2245	RCA	2105
Saba	2148, 2188	Star Cluster	2355	Venturer	2149	Samsung	2113, 2219
Sabaki	2355	Starmedia	2358, 2364	Viewmaster	2364	Sharp	2088, 2091
Saivod	2362	Sungale	2204	Vocopro	2206	Sony	2084, 2085, 2087
Sampo	2141	Sunkai	2362	VocoStar	2207	Toshiba	2086, 2218
		Superscan	2150	Waitec	2364	Victor	2475
		Supervision	2355	Welltech	2382	Yamaha	2089, 2118
		Sylvania	2012, 2137, 2150, 2178, 2230, 2239	Westinghouse	2063, 2250		
				Wharfedale	2354, 2355		
				Woxter	2361, 2364		
				Xbox	2156, 2183		
				Xlogic	2355, 2362		
				XMS	2362		
				Xoro	2382		
				Yamada	2051, 2361, 2363		
				Yamaha	2056, 2064, 2065, 2080, 2081, 2082, 2083, 2089, 2118, 2151, 2323		
				Yamakawa	2363, 2380		

DVD Recorder

Aspire	2222
Astar	2240
Broksonic	2146
Go Video	2213
Hitachi	2062
Insignia	2002
Irradio	2053
JVC	2100, 2101, 2106, 2107
LG	2033, 2057, 2223, 2238
Liteon	2043
Panasonic	2011, 2034, 2058, 2062, 2116, 2117, 2119, 2120, 2121, 2123
Philips	2008, 2044, 2050, 2051, 2147
Pioneer	2017, 2035
Pye	2144
Samsung	2000, 2112, 2216
Sansui	2073
Sanyo	2217
Sony	2004, 2005, 2007, 2052, 2068, 2069, 2074, 2208, 2210, 2211
Sylvania	2239
Toshiba	2032, 2036, 2037, 2039, 2049, 2054, 2055, 2076
Yamaha	2056

Cable

ABC	3002, 3003, 3017, 3066, 3067, 3086, 3093, 3119, 3122
ADB	3020
Adelphia	3081
Alcatel	3016
Americast	3124
Amstrad	3022, 3098
Antronix	3065, 3070
Archer	3070
Arcon	3098
AT&T	3095
Axis	3098
Bell South	3124
Cable Vision	3092
Cabletenna	3065
Cabletime	3104

Cableview	3087
Clearmaster	3127
ClearMax	3127
Clyde Cablevision	3105
Colour Voice	3068
Comcast	3084, 3088, 3117
Comcrypt	3107
Comtronics	3069
Contec	3074
Coolmax	3127
COX	3084
Cryptovision	3110
Director	3084
Eastern	3075
Everquest	3123
Fidelity	3098
Filmnet	3107
Filmnet Cablecrypt	3111
Filmnet Comcrypt	3111
Finlux	3097
FIOS	3004
Focus	3126
Foxtel	3022
France Telecom	3100, 3101
Freebox	3023
GC Electronics	3070
GE	3066, 3093
GEC	3105
Gemini	3072, 3123
General Instrument	3017, 3025, 3066, 3084, 3090, 3096, 3117
Goldstar	3120
Gooding	3099
Grundig	3098, 3099
Hamlin	3073, 3078
Hirschmann	3097
Hitachi	3066
HomeChoice	3106
Humax	3021, 3080, 3083
ITT Nokia	3097
Jasco	3123
Jerrold	3017, 3018, 3025, 3066, 3072, 3084, 3090, 3096, 3119, 3123
JVC	3099
Kabel Deutschland	3024, 3027, 3121

Macab	3101
Magnavox	3079
Maspro	3099
Matsui	3099
MegaCable	3117
Memorex	3076, 3122
Minerva	3099
Mnet	3107
Motorola	3025, 3026, 3084, 3088, 3090, 3095, 3117
Movie Time	3077, 3109
Mr Zapp	3101
Multichoice	3107
Multitech	3127
NEC	3064
NET Brazil	3085
Nokia	3097
Noos	3101
NSC	3077
Oak	3074
Pace	3006, 3089, 3121
Palladium	3099
Panasonic	3112, 3118, 3122
Paragon	3122
Philips	3068, 3071, 3079, 3099, 3100, 3101, 3103
Pioneer	3001, 3006, 3094, 3098, 3114, 3116, 3120
Popular Mechanics	3126
Proscan	3066, 3093
Pulsar	3122
PVP Stereo Visual Matrix	3018
Quasar	3122
RadioShack	3123, 3127
RCA	3030, 3031, 3087, 3118
Realistic	3070
Recoton	3126
Regal	3078
Regency	3075
Rembrandt	3066
Runco	3122
Sagem	3101
Samsung	3069, 3089, 3114, 3120
SAT	3098
Scientific Atlanta	3000, 3001, 3002, 3003, 3006, 3028, 3029, 3081, 3086, 3089, 3094, 3095, 3108

Signal	3072, 3123
Signature	3066
Sony	3092, 3125
Sprucer	3118
Standard Component	3115
Starcom	3017, 3072, 3119, 3123
Stargate	3072, 3123
Starquest	3072, 3123
Supercable	3090
Supermax	3127
Tele+1	3107, 3111
TELENET	3007
Telepiu	3107
Thomson	3082, 3091
TIME WARNER	3084
Tocom	3067
Torx	3017
Toshiba	3122
Tristar	3127
Tudi	3102
Tusa	3072, 3123
TV86	3077
Unika	3065, 3070
United Cable	3018, 3119
Universal	3065, 3070
Universum	3097, 3099
V2	3127
Videoway	3019
View Star	3074, 3077, 3079
Viewmaster	3127
Vision	3127
Visiopass	3097, 3100, 3101
Vortex View	3127
Wittenberg	3098
Zenith	3113, 3122, 3124
Zentek	3126

Satellite

AB Sat	4216, 4217
AccessHD	4104
ADB	4220
AGS	4216
Akai	4053, 4055
Alba	4001, 4004, 4006, 4007, 4062, 4217
Aldes	4005, 4007, 4010
Allsat	4048, 4053, 4055

Allsonic	4005, 4008, 4024	Comag	4080, 4081, 4082, 4083, 4086	Emanon	4001	Hirschmann	4015, 4024, 4210, 4216, 4218, 4219
Alltech	4217	Commlink	4005	Emme Esse	4008, 4024	Hisawa	4013
Alpha	4053	Comtech	4050	Engel	4217	Hisense	4016
Alpha Digital	4104	Condor	4008, 4024, 4219	Ep Sat	4006	Hitachi	4006, 4114, 4199, 4203
Alphastar	4077	Connexions	4014, 4024	EURIEULT	4031	Homecast	4084, 4085, 4087
Amitronica	4217	Conrad	4024, 4215, 4218, 4219	Eurodec	4052	Houston	4048
Amstrad	4011, 4035, 4217, 4218	Conrad Electronic	4217, 4219	Europa	4053, 4218, 4219	HTS	4117
Anglo	4217	Contec	4050	Europhon	4219	Hughes	4064, 4068, 4192, 4194, 4196, 4202
Ankaro	4005, 4008, 4024, 4217	Coolsat	4096	Eurosat	4011	Hughes Network Systems	4071
Anttron	4001, 4004	Cosat	4048	Eurosky	4008, 4011, 4215, 4218, 4219, 4024	Humax	4025, 4030, 4060, 4097
Apollo	4001	Coship	4109	Eurostar	4011, 4215, 4219	Huth	4005, 4011, 4012, 4013, 4048, 4050, 4219, 4223
Armstrong	4011, 4053	Crown	4011	Eutelsat	4217	Hypson	4031
Artec	4100	Daeryung	4014	Exator	4001, 4004	Ilo	4016
Asat	4053, 4055	Daewoo	4057, 4217	Expressvuu	4117	Imex	4031
ASLF	4217	DDC	4007	Fenner	4024, 4212, 4217	Innovation	4008
Astacom	4216	Delega	4007	Ferguson	4006, 4052, 4214	Insignia	4107
Astra	4009, 4011, 4054, 4217, 4219	Dew	4050	Fidelity	4218	Intertronic	4011
Astro	4004, 4008, 4010, 4015, 4024, 4213, 4218, 4219	Diamond	4051	Finlandia	4006	Intervision	4048, 4219
AudioTon	4004, 4048	Digiality	4219	Finlux	4006	ITT Nokia	4006
Aurora	4222	Digital Stream	4105	FinnSat	4050, 4052	Jerrold	4019
Austar	4222	DIRECTV	4056, 4064, 4067, 4068, 4070, 4071, 4074, 4107, 4116, 4119, 4121, 4122, 4123, 4127, 4192, 4193, 4194, 4195, 4196, 4197, 4198, 4199, 4200, 4201, 4202, 4203, 4206, 4207, 4221	Flair Mate	4217	Johansson	4013
Axiel	4216	Discoverer	4212	Foxtel	4222	JOK	4216
Axis	4008, 4009, 4024, 4050	Discovery	4216	Freecom	4001, 4049, 4218	JSR	4048
BBK	4205	Diseqc	4216	FTEmaximal	4024, 4217	JVC	4029, 4065, 4089, 4117
Best	4008, 4024	Dish Network	4018, 4065, 4089, 4092, 4094, 4095, 4117	Fuba	4001, 4008, 4014, 4015, 4024, 4055, 4215	Kamm	4217
Blaupunkt	4015	Dishpro	4018, 4117	Galaxis	4005, 4008, 4009, 4024, 4048, 4050, 4215, 4222	Kathrein	4015, 4034, 4042, 4053, 4055, 4063, 4215, 4216, 4217
Blue Sky	4217	Distrisat	4053	GE	4066, 4093, 4111, 4197	Kathrein Eurostar	4215
Boca	4011, 4054, 4059, 4217	Ditristrad	4048	General Instrument	4019, 4073	Klap	4216
Boston	4216	DNT	4014, 4053, 4055	GMI	4011	Konig	4219
Brain Wave	4013	Drake	4072	GOI	4117	Kosmos	4049
Broadcast	4012	DStv	4222	Goldbox	4213	KR	4004
Broco	4217	Dune	4024, 4240, 4242	GoldStar	4049	Kreiselmeier	4015
BSkyB	4035, 4041	Echostar	4014, 4018, 4065, 4089, 4117, 4217	Goodmans	4002, 4006, 4029	K-SAT	4217
BT	4216	Einhell	4001, 4005, 4011, 4217, 4218	Goodmind	4111	Kyostar	4001
Bubu Sat	4217	Elap	4216, 4217	Grandin	4031	L&S Electronic	4024
Bush	4006, 4045	Elekta	4010	Grandig	4001, 4049	Lasat	4008, 4010, 4024, 4054, 4212, 4215, 4219
Cambridge	4218	Elsat	4217	Hänsel & Gretel	4219	Lasonic	4108
Canal Satellite	4213	Elta	4001, 4008, 4024, 4048, 4053, 4055	Hantor	4001, 4013	Lenco	4001, 4024, 4049, 4215, 4217, 4219
Canal+	4213			Hanuri	4010	Leng	4013
CaptiveWorks	4099			Hauppauge	4044	Lennox	4048
Channel Master	4007, 4110			Heliocom	4219	Lenson	4218
Chaparral	4075			Helium	4219	Lexus	4053
CHEROKEE	4216			Hinari	4007		
Chess	4212, 4217						
CityCom	4006, 4215, 4219						
Clatronic	4013						
CNT	4010						

LG	4049, 4103, 4107	Nokia	4006, 4040	Quelle	4015, 4215, 4219	SkySat	4212, 4217, 4218, 4219
Lifesat	4008, 4024, 4212, 4217	Nordmende	4001, 4006, 4007, 4010, 4052	Quiero	4052	Skyvision	4048
Lifetec	4008			RadioShack	4019	SM Electronic	4212, 4217
Lorenzen	4219	Nova	4222	Radiola	4053, 4055	Smart	4215, 4217
Lorraine	4049	Novis	4013	Radix	4014, 4037	Sony	4067, 4070, 4213
Lupus	4008, 4024	Oceanic	4051	Rainbow	4004	SR	4011, 4054
Luxor	4218	Octagon	4001, 4004, 4050	RCA	4066, 4093, 4112, 4113, 4116, 4118, 4119, 4197, 4122, 4207	Star Choice	4019
Lyonnaise	4052	Okano	4011			Starland	4217
Macab	4052	Optex	4048			Starring	4013
Magnavox	4127, 4101	Optus	4213, 4222, 4223	Realistic	4078	Start Trak	4001
Manata	4031, 4216, 4217	Orbitech	4001, 4212, 4213, 4218	Redpoint	4009	Strong	4001, 4004, 4008, 4024, 4049, 4222
Manhattan	4006, 4010, 4048, 4216	OSat	4004	Redstar	4008, 4024		
Marantz	4055	Otto Versand	4015	RFT	4005, 4053, 4055	STS	4115
Mascom	4010	Pace	4006, 4015, 4035, 4043, 4047, 4204, 4216, 4243	Roadstar	4217	STVI	4031
Maspro	4006, 4217			Roch	4031	Sumida	4011
Matsui	4216	Pacific	4051	Rover	4024, 4217	Sunny Sound	4024
Max	4219	Packsat	4216	Saba	4010, 4215, 4216, 4219	Sunsat	4217
Mediabox	4213	Palcom	4007	Sabre	4006	Sunstar	4011, 4024, 4054
Mediamarkt	4011	Palladium	4011, 4218	Sagem	4023, 4052	Supermax	4223
Mediasat	4009, 4213, 4218	Palsat	4212, 4218	Sakura	4050	Tandberg	4052
Medion	4008, 4024, 4217	Panasat	4222	Samsung	4000, 4001, 4003, 4032, 4064, 4069, 4071, 4120, 4123, 4196, 4200	Tandy	4004
Medison	4217	Panasonic	4006, 4035, 4036, 4121, 4124, 4126, 4198, 4221			Tantec	4006
Mega	4053, 4055					TCM	4008
Memorex	4127	Panda	4006, 4219	SAT	4007, 4218	Techniland	4012
Metronic	4001, 4004, 4005, 4010, 4028, 4031, 4217	Pansat	4125	Sat Cruiser	4223	TechniSat	4014, 4021, 4026, 4027, 4038, 4039, 4053, 4212, 4213, 4218
Metz	4015	Patriot	4216	Sat Partner	4001, 4004, 4010, 4013, 4049, 4218		
Micro electronic	4217, 4218, 4219	Paysat	4127			Technology	4222
Micro Technology	4217	PCT	4110	Sat Team	4217	Technosat	4223
MicroGem	4106	Philco	4101	Satcom	4012, 4219	Technowelt	4219
Micromaxx	4008, 4024	Philips	4006, 4033, 4053, 4055, 4061, 4068, 4071, 4127, 4196, 4201, 4202, 4203, 4206, 4213, 4216	Satec	4217	Teco	4011, 4054
Microstar	4008			Satelco	4024	Telanor	4007
Microtec	4217	Phoenix	4050	Satford	4012	Telasat	4215, 4219
Minerva	4015	Phonotrend	4006, 4005, 4048	Satmaster	4012	Telecom	4217
Mitsubishi	4006, 4015, 4202	Pioneer	4046, 4213	Satplus	4212	Telefunken	4001, 4017, 4216
Mitsumi	4054	Polsat	4052	Schneider	4008, 4212, 4216	Teleka	4004, 4011, 4014, 4218, 4219
Morgan's	4011, 4053, 4054, 4055, 4217	Predki	4013	Schwaiger	4051, 4212, 4219		
Motorola	4019, 4088, 4090, 4091	Premiere	4048, 4213	SCS	4215	Telemaster	4010
Multichoice	4222	Priesner	4011	Seemann	4009, 4011, 4014	TELENET	4241
Multitec	4212	Primestar	4076	SEG	4001, 4008, 4013, 4024	Telesat	4219
Muratto	4049	Profile	4216	Seleo	4048	Telestar	4212, 4213, 4218
Mysat	4217	Promax	4006	Servi Sat	4031, 4217	Televés	4006, 4218
Navex	4013	Prosat	4005, 4007	Siemens	4015	Telewire	4048
Neuhaus	4009, 4048, 4217, 4218, 4219	Proscan	4066, 4093, 4122, 4197	Silva	4049	Tempo	4223
Neusat	4217	Protek	4051	Skantin	4217	Tevion	4008, 4217
Next Level	4019	Proton	4016	Skardin	4009	Thomson	4006, 4020, 4052, 4058, 4208, 4213, 4215, 4216, 4217, 4219
NextWave	4223	Provision	4010	Skintat	4218		
Nikko	4011, 4217	Quadral	4005, 4007, 4008, 4216, 4024	SKR	4217	Thorens	4051
				Skymaster	4005, 4017, 4022, 4212, 4217	Thorn	4006
				Skymax	4053, 4055		

Tivax 4104
Tivo 4196
Tokai 4053
Tonna 4006, 4012, 4048, 4217,
4218
Toshiba 4194, 4202, 4203
Triad 4049
Triasat 4218
Triax 4015, 4215, 4217, 4218
Turnsat 4217
Tvonics 4214
Twiner 4031, 4217
UEC 4222
Uher 4212
UltimateTV 4070
Uniden 4079, 4127
Unisat 4011, 4050, 4053
Unitor 4013
Universum 4015, 4215, 4219
US Digital 4016

Variosat 4015
Vega 4024
Ventana 4053, 4055
Viewsat 4098
Visiosat 4013, 4048, 4216, 4217
Voom 4019
Vortec 4001
Welltech 4212
WeTeKom 4212, 4218
Wevasat 4006
Wewa 4006
Winersat 4013
Wisi 4006, 4014, 4015, 4218,
4219
Woorisat 4010
Worldsat 4216
Xrypton 4024
XSat 4217
Zehnder 4008, 4209, 4010, 4215,
4024
Zenith 4102, 4107, 4195
Zodiac 4004

CD

Yamaha 5082, 5095

CD Recorder

Yamaha 5083

MD

Yamaha 5080, 5081, 5086

Tape

Yamaha 5084, 5087

Tuner

Yamaha 5066, 5085, 5088, 5090,
5092

LD

Yamaha 2080

Amplifier

Yamaha 5019, 5020, 5098

Apple TV

Apple 2241

“Apple TV” is a trademark or registered mark of Apple Inc.