



RX-V1700

AV Receiver

OWNER'S MANUAL

IMPORTANT SAFETY INSTRUCTIONS

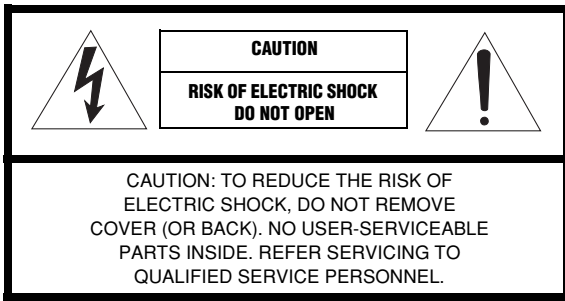

• Explanation of Graphical Symbols

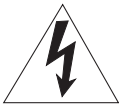

The lightning flash with arrowhead symbol, within an equilateral triangle, is intended to alert you to the presence of uninsulated “dangerous voltage” within the product’s enclosure that may be of sufficient magnitude to constitute a risk of electric shock to persons.



The exclamation point within an equilateral triangle is intended to alert you to the presence of important operating and maintenance (servicing) instructions in the literature accompanying the appliance.

- 1 Read Instructions – All the safety and operating instructions should be read before the product is operated.
- 2 Retain Instructions – The safety and operating instructions should be retained for future reference.
- 3 Heed Warnings – All warnings on the product and in the operating instructions should be adhered to.
- 4 Follow Instructions – All operating and use instructions should be followed.
- 5 Cleaning – Unplug this product from the wall outlet before cleaning. Do not use liquid cleaners or aerosol cleaners.
- 6 Attachments – Do not use attachments not recommended by the product manufacturer as they may cause hazards.
- 7 Water and Moisture – Do not use this product near water – for example, near a bath tub, wash bowl, kitchen sink, or laundry tub; in a wet basement; or near a swimming pool; and the like.
- 8 Accessories – Do not place this product on an unstable cart, stand, tripod, bracket, or table. The product may fall, causing serious injury to a child or adult, and serious damage to the product. Use only with a cart, stand, tripod, bracket, or table recommended by the manufacturer, or sold with the product. Any mounting of the product should follow the manufacturer’s instructions, and should use a mounting accessory recommended by the manufacturer.
- 9 A product and cart combination should be moved with care. Quick stops, excessive force, and uneven surfaces may cause the product and cart combination to overturn.



- 10 Ventilation – Slots and openings in the cabinet are provided for ventilation and to ensure reliable operation of the product and to protect it from overheating, and these openings must not be blocked or covered. The openings should never be blocked by placing the product on a bed, sofa, rug, or other similar surface. This product should not be placed in a built-in installation such as a bookcase or rack unless proper ventilation is provided or the manufacturer’s instructions have been adhered to.
- 11 Power Sources – This product should be operated only from the type of power source indicated on the marking label. If you are not sure of the type of power supply to your home, consult your product dealer or local power company. For products intended to operate from battery power, or other sources, refer to the operating instructions.
- 12 Grounding or Polarization – This product may be equipped with a polarized alternating current line plug (a plug having one blade wider than the other). This plug will fit into the power outlet only one way. This is a safety feature. If you are unable to insert the plug fully into the outlet, try reversing the plug. If the plug should still fail to fit, contact your electrician to replace your obsolete outlet. Do not defeat the safety purpose of the polarized plug.
- 13 Power-Cord Protection – Power-supply cords should be routed so that they are not likely to be walked on or pinched by items placed upon or against them, paying particular attention to cords at plugs, convenience receptacles, and the point where they exit from the product.
- 14 Lightning – For added protection for this product during a lightning storm, or when it is left unattended and unused for long periods of time, unplug it from the wall outlet and disconnect the antenna or cable system. This will prevent damage to the product due to lightning and power-line surges.
- 15 Power Lines – An outside antenna system should not be located in the vicinity of overhead power lines or other electric light or power circuits, or where it can fall into such power lines or circuits. When installing an outside antenna system, extreme care should be taken to keep from touching such power lines or circuits as contact with them might be fatal.
- 16 Overloading – Do not overload wall outlets, extension cords, or integral convenience receptacles as this can result in a risk of fire or electric shock.
- 17 Object and Liquid Entry – Never push objects of any kind into this product through openings as they may touch dangerous voltage points or short-out parts that could result in a fire or electric shock. Never spill liquid of any kind on the product.
- 18 Servicing – Do not attempt to service this product yourself as opening or removing covers may expose you to dangerous voltage or other hazards. Refer all servicing to qualified service personnel.
- 19 Damage Requiring Service – Unplug this product from the wall outlet and refer servicing to qualified service personnel under the following conditions:
 - a) When the power-supply cord or plug is damaged,
 - b) If liquid has been spilled, or objects have fallen into the product,
 - c) If the product has been exposed to rain or water,

- d) If the product does not operate normally by following the operating instructions. Adjust only those controls that are covered by the operating instructions as an improper adjustment of other controls may result in damage and will often require extensive work by a qualified technician to restore the product to its normal operation,
 - e) If the product has been dropped or damaged in any way, and
 - f) When the product exhibits a distinct change in performance - this indicates a need for service.
- 20 Replacement Parts** – When replacement parts are required, be sure the service technician has used replacement parts specified by the manufacturer or have the same characteristics as the original part. Unauthorized substitutions may result in fire, electric shock, or other hazards.
- 21 Safety Check** – Upon completion of any service or repairs to this product, ask the service technician to perform safety checks to determine that the product is in proper operating condition.
- 22 Wall or Ceiling Mounting** – The unit should be mounted to a wall or ceiling only as recommended by the manufacturer.
- 23 Heat** – The product should be situated away from heat sources such as radiators, heat registers, stoves, or other products (including amplifiers) that produce heat.

- 24 Outdoor Antenna Grounding** – If an outside antenna or cable system is connected to the product, be sure the antenna or cable system is grounded so as to provide some protection against voltage surges and built-up static charges. Article 810 of the National Electrical Code, ANSI/NFPA 70, provides information with regard to proper grounding of the mast and supporting structure, grounding of the lead-in wire to an antenna discharge unit, size of grounding conductors, location of antenna discharge unit, connection to grounding electrodes, and requirements for the grounding electrode.

EXAMPLE OF ANTENNA GROUNDING

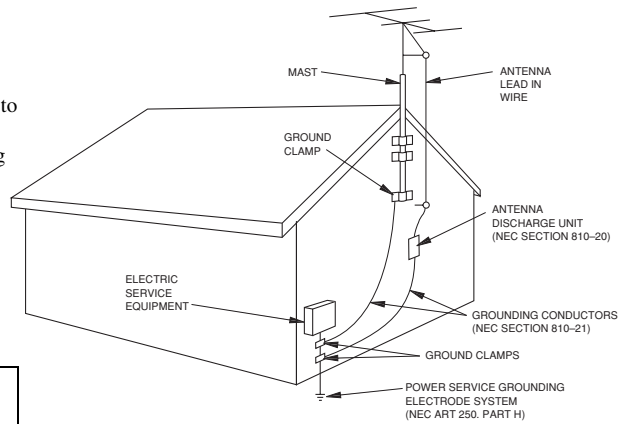

NEC – NATIONAL ELECTRICAL CODE

Note to CATV system installer:

This reminder is provided to call the CATV system installer’s attention to Article 820-40 of the NEC that provides guidelines for proper grounding and, in particular, specifies that the cable ground shall be connected to the grounding system of the building, as close to the point of cable entry as practical.

FCC INFORMATION (for US customers)

1 IMPORTANT NOTICE: DO NOT MODIFY THIS UNIT!

This product, when installed as indicated in the instructions contained in this manual, meets FCC requirements. Modifications not expressly approved by Yamaha may void your authority, granted by the FCC, to use the product.

- 2 IMPORTANT:** When connecting this product to accessories and/or another product use only high quality shielded cables. Cable/s supplied with this product **MUST** be used. Follow all installation instructions. Failure to follow instructions could void your FCC authorization to use this product in the USA.

- 3 NOTE:** This product has been tested and found to comply with the requirements listed in FCC Regulations, Part 15 for Class “B” digital devices. Compliance with these requirements provides a reasonable level of assurance that your use of this product in a residential environment will not result in harmful interference with other electronic devices.

This equipment generates/uses radio frequencies and, if not installed and used according to the instructions found in the users manual, may cause interference harmful to the operation of other electronic devices.

Compliance with FCC regulations does not guarantee that interference will not occur in all installations. If this product is found to be the source of interference, which can be determined by turning the unit “OFF” and “ON”, please try to eliminate the problem by using one of the following measures:

Relocate either this product or the device that is being affected by the interference.

Utilize power outlets that are on different branch (circuit breaker or fuse) circuits or install AC line filter/s.

In the case of radio or TV interference, relocate/reorient the antenna. If the antenna lead-in is 300 ohm ribbon lead, change the lead-in to coaxial type cable.

If these corrective measures do not produce satisfactory results, please contact the local retailer authorized to distribute this type of product. If you can not locate the appropriate retailer, please contact Yamaha Electronics Corp., U.S.A. 6660 Orangethorpe Ave, Buena Park, CA 90620.

The above statements apply **ONLY** to those products distributed by Yamaha Corporation of America or its subsidiaries.

CAUTION: READ THIS BEFORE OPERATING YOUR UNIT.

- 1 To assure the finest performance, please read this manual carefully. Keep it in a safe place for future reference.
- 2 Install this sound system in a well ventilated, cool, dry, clean place – away from direct sunlight, heat sources, vibration, dust, moisture, and/or cold. Allow ventilation space of at least 30 cm on the top, 20 cm on the left and right, and 20 cm on the back of this unit.
- 3 Locate this unit away from other electrical appliances, motors, or transformers to avoid humming sounds.
- 4 Do not expose this unit to sudden temperature changes from cold to hot, and do not locate this unit in an environment with high humidity (i.e. a room with a humidifier) to prevent condensation inside this unit, which may cause an electrical shock, fire, damage to this unit, and/or personal injury.
- 5 Avoid installing this unit where foreign objects may fall onto this unit and/or this unit may be exposed to liquid dripping or splashing. On the top of this unit, do not place:
 - Other components, as they may cause damage and/or discoloration on the surface of this unit.
 - Burning objects (i.e. candles), as they may cause fire, damage to this unit, and/or personal injury.
 - Containers with liquid in them, as they may fall and liquid may cause electrical shock to the user and/or damage to this unit.
- 6 Do not cover this unit with a newspaper, tablecloth, curtain, etc. in order not to obstruct heat radiation. If the temperature inside this unit rises, it may cause fire, damage to this unit, and/or personal injury.
- 7 Do not plug in this unit to a wall outlet until all connections are complete.
- 8 Do not operate this unit upside-down. It may overheat, possibly causing damage.
- 9 Do not use force on switches, knobs and/or cords.
- 10 When disconnecting the power cable from the wall outlet, grasp the plug; do not pull the cable.
- 11 Do not clean this unit with chemical solvents; this might damage the finish. Use a clean, dry cloth.
- 12 Only voltage specified on this unit must be used. Using this unit with a higher voltage than specified is dangerous and may cause fire, damage to this unit, and/or personal injury. YAMAHA will not be held responsible for any damage resulting from use of this unit with a voltage other than specified.
- 13 To prevent damage by lightning, keep the power cord and outdoor antennas disconnected from a wall outlet or the unit during a lightning storm.
- 14 Do not attempt to modify or fix this unit. Contact qualified YAMAHA service personnel when any service is needed. The cabinet should never be opened for any reasons.
- 15 When not planning to use this unit for long periods of time (i.e. vacation), disconnect the AC power plug from the wall outlet.
- 16 Install this unit near the AC outlet and where the AC power plug can be reached easily.
- 17 Be sure to read the “TROUBLESHOOTING” section on common operating errors before concluding that this unit is faulty.
- 18 Before moving this unit, press MASTER ON/OFF to release it outward to the OFF position to turn off this unit, the main room, Zone 2 and Zone 3 and then disconnect the AC power plug from the AC wall outlet.
- 19 **VOLTAGE SELECTOR** (Asia and General models only)
The **VOLTAGE SELECTOR** on the rear panel of this unit must be set for your local main voltage **BEFORE** plugging into the AC wall outlet. Voltages are:
 - Asia model 220/230–240 V AC, 50/60 Hz
 - General model 110/120/220/230–240 V AC, 50/60 Hz

WARNING

TO REDUCE THE RISK OF FIRE OR ELECTRIC SHOCK, DO NOT EXPOSE THIS UNIT TO RAIN OR MOISTURE.

As long as this unit is connected to the AC wall outlet, it is not disconnected from the AC power source even if you turn off this unit by MASTER ON/OFF. In this state, this unit is designed to consume a very small quantity of power.

FOR CANADIAN CUSTOMERS

To prevent electric shock, match wide blade of plug to wide slot and fully insert.
This Class B digital apparatus complies with Canadian ICES-003.

POUR LES CONSOMMATEURS CANADIENS

Pour éviter les chocs électriques, introduire la lame la plus large de la fiche dans la borne correspondante de la prise et pousser jusqu'au fond.
Cet appareil numérique de la classe B est conforme à la norme NMB-003 du Canada.

IMPORTANT

Please record the serial number of this unit in the space below.
MODEL:
Serial No.:
The serial number is located on the rear of the unit.
Retain this Owner's Manual in a safe place for future reference.

CONTENTS

INTRODUCTION

FEATURES	2
GETTING STARTED	3
Supplied accessories	3
CONTROLS AND FUNCTIONS	4
Front panel.....	4
Remote control.....	6
Zone 2/Zone 3 remote control	8
Preparing the remote control	9
Front panel display	10
Rear panel	12

PREPARATION

CONNECTIONS	13
Placing speakers.....	13
Connecting speakers	14
Using bi-amplification connections	17
Information on jacks and cable plugs	18
Information on HDMI.....	19
Audio and video signal flow.....	20
Connecting a TV monitor or projector	21
Connecting other components	22
Connecting a multi-format player or an external decoder	26
Connecting a YAMAHA iPod universal dock	27
Using the VIDEO AUX jacks on the front panel	27
Connecting the FM and AM antennas	28
Connecting the power cable.....	29
Setting the speaker impedance.....	30
Turning on and off the power	31
AUTO SETUP	32
Using AUTO SETUP	32

BASIC OPERATION

PLAYBACK	38
Basic procedure	38
Selecting audio input jacks (AUDIO SELECT).....	40
Selecting the MULTI CH INPUT component.....	41
Using your headphones.....	41
Muting the audio output.....	41
Displaying the input source information	42
Playing video sources in the background of an audio source.....	43
Using the sleep timer	43
SOUND FIELD PROGRAMS	44
Selecting sound field programs	44
Sound field program descriptions	45
Enjoying unprocessed input sources.....	49
USING AUDIO FEATURES	50
Enjoying pure hi-fi sound	50
Adjusting the tonal quality.....	50
Adjusting the speaker level.....	51
Enjoying multi-channel sources in 2-channel stereo.....	51
Selecting the Compressed Music Enhancer mode	52
Selecting the night listening mode.....	53

FM/AM TUNING	54
FM/AM controls and functions	54
Automatic tuning	55
Manual tuning.....	56
Automatic preset tuning.....	57
Manual preset tuning	58
Selecting preset stations.....	59
Exchanging preset stations	60
XM SATELLITE RADIO TUNING	61
Connecting the XM Passport System	61
XM Satellite Radio controls and functions.....	62
Activating XM Satellite Radio	63
Basic XM Satellite Radio operations.....	65
Setting the XM Satellite Radio preset channels	70
Displaying the XM Satellite Radio information	71
USING iPod	73
Controlling iPod	73
RECORDING	75

ADVANCED OPERATION

ADVANCED SOUND CONFIGURATIONS	76
Changing sound field parameter settings.....	76
Selecting decoders	80
CUSTOMIZING THIS UNIT (MANUAL SETUP)	84
Using SET MENU	86
1 BASIC MENU	87
2 SOUND MENU	91
3 INPUT MENU	94
4 OPTION MENU	97
REMOTE CONTROL FEATURES	101
Controlling this unit, a TV, or other components	101
Setting remote control codes	103
Programming codes from other remote controls ..	105
Changing source names in the display window.....	106
Macro programming features	107
Clearing configurations	110
USING MULTI-ZONE CONFIGURATION	113
Connecting the Zone 2 and Zone 3 components ..	113
Controlling Zone 2 or Zone 3	114
ADVANCED SETUP	117
Using ADVANCED SETUP	117
Setting remote control ID	119

ADDITIONAL INFORMATION

TROUBLESHOOTING	122
RESETTING THE SYSTEM	130
GLOSSARY	131
SOUND FIELD PROGRAM INFORMATION	134
PARAMETRIC EQUALIZER INFORMATION	135
SPECIFICATIONS	136

APPENDIX (at the end of this manual)

- SOUND OUTPUT IN EACH SOUND FIELD PROGRAM
- LIST OF REMOTE CONTROL CODES

INTRODUCTION

PREPARATION

BASIC OPERATION

ADVANCED OPERATION

ADDITIONAL INFORMATION

FEATURES

Built-in 7-channel power amplifier

- ◆ Minimum RMS output power (20 Hz to 20 kHz, 0.04% THD, 8 Ω)
Front: 130 W + 130 W
Center: 130 W
Surround: 130 W + 130 W
Surround back: 130 W + 130 W

Sound field programs

- ◆ Proprietary YAMAHA technology for the creation of sound fields
- ◆ Dolby Digital/Dolby Digital EX decoder
- ◆ DTS/DTS-ES Matrix 6.1, Discrete 6.1, DTS Neo:6, DTS 96/24 decoder
- ◆ Dolby Pro Logic/Dolby Pro Logic II/Dolby Pro Logic IIX decoder
- ◆ Neural Surround decoder (U.S.A. and Canada models only)
- ◆ Virtual CINEMA DSP
- ◆ SILENT CINEMA

Sophisticated AM/FM tuner

- ◆ 40-station random and direct preset tuning
- ◆ Automatic preset tuning
- ◆ Preset station shifting capability (preset editing)

XM Satellite Radio

(U.S.A. and Canada models only)

- ◆ XM Satellite Radio tuning capability (using the “XM Passport System” sold separately)
- ◆ Neural Surround decoder to play back the surround sound content of XM Satellite Radio broadcasts in multi-channels, resulting in a full surround sound experience

HDMI (High-Definition Multimedia Interface)

- ◆ HDMI interface for standard, enhanced or high-definition video (includes 1080p video signal transmission) as well as multi-channel digital audio based on HDMI version 1.2a
- ◆ Analog video to HDMI digital video up-conversion (composite video ↔ S-video ↔ component video → HDMI digital video) capability for monitor out



Manufactured under license from Dolby Laboratories. “Dolby”, “Pro Logic”, and the double-D symbol are trademarks of Dolby Laboratories.



Manufactured under license from Digital Theater Systems, Inc. “DTS”, “DTS-ES”, “NEO:6”, and “DTS 96/24” are trademarks of Digital Theater Systems, Inc. Copyright 1996, 2003 Digital Theater Systems, Inc. All right reserved.

iPod®

“iPod” is a trademark of Apple Computer, Inc., registered in the U.S. and other countries.

iPod controlling capability

- ◆ DOCK terminal to connect a YAMAHA iPod universal dock (such as the YDS-10, sold separately), which supports iPod (Click and Wheel), iPod nano, and iPod mini

Other features

- ◆ YPAO (YAMAHA Parametric Room Acoustic Optimizer) for automatic speaker setup
- ◆ 192-kHz/24-bit D/A converter
- ◆ OSD (on-screen display) menus that allow you to optimize this unit to suit your individual audiovisual system
- ◆ 6 or 8-channel additional input jacks for discrete multi-channel input
- ◆ Analog video interlace/progressive conversion from 480i (NTSC)/576i (PAL) to 480p/576p
- ◆ S-video signal input/output capability
- ◆ Component video input/output capability includes (3 COMPONENT VIDEO INs and 1 MONITOR OUT)
- ◆ Optical and coaxial digital audio signal jacks
- ◆ Pure Direct mode for pure hi-fi sound for all sources
- ◆ Cinema and music night listening modes
- ◆ Compressed Music Enhancer mode to improve the sound quality of compression artifacts (such as the MP3 format) to that of a high-quality stereo
- ◆ Remote control with preset remote control codes, learning and macro capability
- ◆ ZONE 2/ZONE 3 custom installation facility
- ◆ Zone switching capability between the main zone and ZONE 2/ZONE 3 using ZONE CONTROLS
- ◆ Sleep timer



“HDMI”, the “HDMI” logo and “High-Definition Multimedia Interface” are trademarks or registered trademarks of HDMI Licensing LLC.

SILENT™
CINEMA

“SILENT CINEMA” is a trademark of YAMAHA CORPORATION.



The XM name and related logos are registered trademarks of XM Satellite Radio Inc.



Neural Surround™ name and related logos are trademarks owned by Neural Audio Corporation.

GETTING STARTED

Supplied accessories

Check that you received all of the following parts.

Remote control

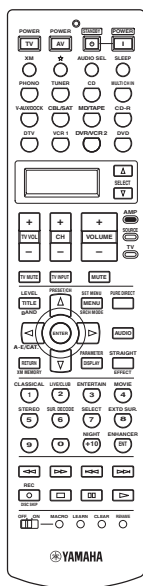

Zone 2/Zone 3 remote control (except Europe model)

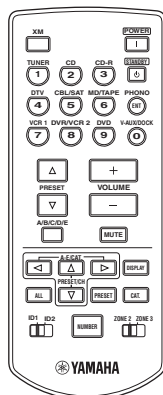

Batteries (6) (AAA, R03, UM-4)

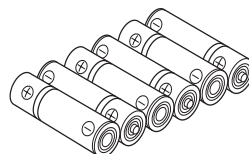

Speaker terminal wrench

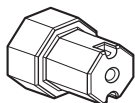

Power cable

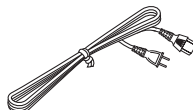

Optimizer microphone

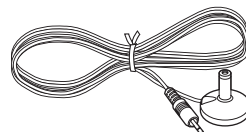

Indoor FM antenna (U.S.A., Canada, China, Asia, General, and Korea models)

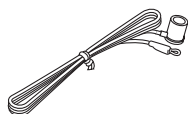

Indoor FM antenna (Europe, U.K. and Australia models)

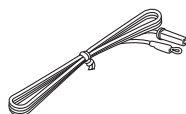

AM loop antenna

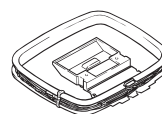

About this manual

- ☼ indicates a tip for your operation.
- Some operations can be performed by using either the buttons on the front panel or the ones on the remote control. In case the button names differ between the front panel and the remote control, the button name on the remote control is given in parentheses.
- This manual is printed prior to production. Design and specifications are subject to change in part as a result of improvements, etc. In case of differences between the manual and product, the product has priority.

CONTROLS AND FUNCTIONS

Front panel

This section describes only the amplifier controls and functions of this unit. See the following pages for details about other control and functions.

- AM/FM tuning see page 54
- XM satellite radio tuning see page 62

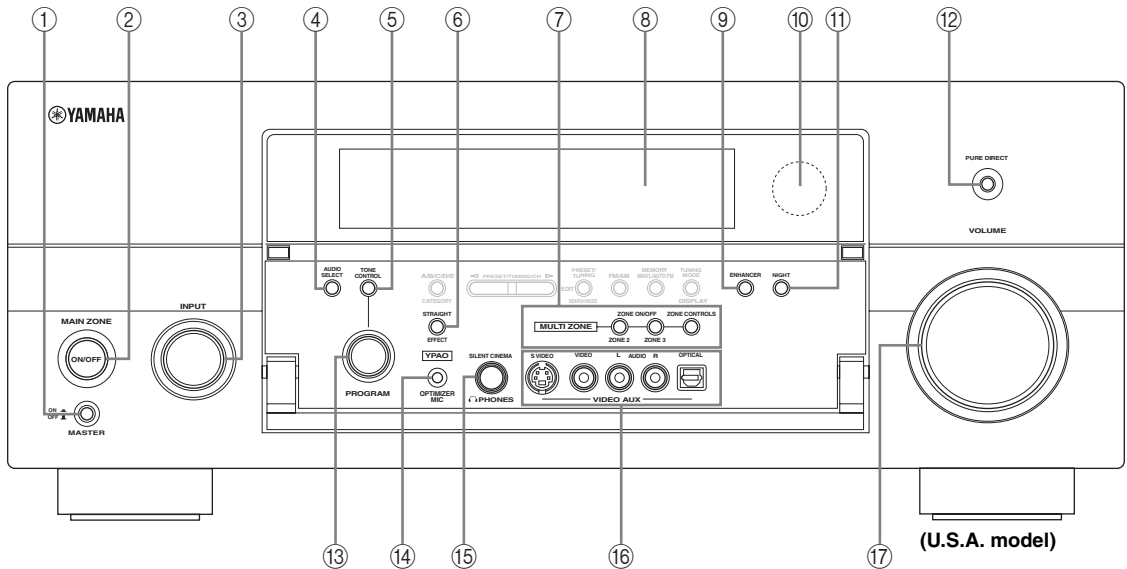

① MASTER ON/OFF

Turns this unit on or off (see page 31).

② MAIN ZONE ON/OFF

Turns on the main zone or sets it to the standby mode (see page 31).

Notes

- In the standby mode, this unit consumes a small amount of power in order to receive infrared signals from the remote control.
- When you turn on this unit, there will be a 4 to 5-second delay before this unit can reproduce sound.
- This button is operational only when MASTER ON/OFF is pressed inward to the ON position.

③ INPUT selector

Selects the desired input source (see page 38).

④ AUDIO SELECT

Toggles the priority for the type of audio input jack between “AUTO”, “HDMI”, “COAX/OPT” and “ANALOG” when one component is connected to two or more input jacks (see page 40).

⑤ TONE CONTROL

Adjusts the bass/treble balance of the front left, front right and center channels in conjunction with the PROGRAM selector (see page 50).

⑥ STRAIGHT

Turns the sound field programs off or on. When the “STRAIGHT” mode is selected, 2-channel or multi-channel input signals are output directly from their respective speakers without effect processing (see page 49).

⑦ MULTI ZONE buttons

ZONE 2 ON/OFF

Turns on Zone 2 only or sets it to the standby mode. See page 114 for details.

ZONE 3 ON/OFF

Turns on Zone 3 only or sets it to the standby mode. See page 114 for details.

Note

These buttons are operational only when MASTER ON/OFF is pressed inward to the ON position.

ZONE CONTROLS

Switches the zone you want to control between the main zone, Zone 2 and Zone 3. See page 114 for details.



After you press ZONE CONTROLS, the indicator for the currently selected zone flashes in the front panel display for approximately 5 seconds. While the indicator is flashing, perform the desired operation.

⑧ Front panel display

Shows information about the operational status of this unit (see page 10).

⑨ ENHANCER

Turns on or off the Compressed Music Enhancer mode (see page 52).

⑩ Remote control sensor

Receives signals from the remote control (see page 9).

⑪ NIGHT

Turns on or off the night listening modes (see page 53).

⑫ PURE DIRECT

Turns on or off the Pure Direct mode (see page 50).

⑬ PROGRAM selector

- Selects sound field programs (see page 44).
- Adjusts the bass/treble balance in conjunction with TONE CONTROL (see page 50).

⑭ OPTIMIZER MIC jack

Use to connect and input audio signals from the supplied optimizer microphone in the “AUTO SETUP” procedure (see page 32).

⑮ PHONES jack

Outputs audio signals for private listening with headphones (see page 41).

⑯ VIDEO AUX jacks

Input audio and video signals from a portable external source such as a game console or a video camera (see page 27).



To reproduce the source signals input at these jacks, select “V-AUX” as the input source.

Note

The audio signals input at the DOCK terminal on the rear panel take priority over the ones input at the VIDEO AUX jacks.

⑰ VOLUME

Controls the output level of all audio channels.



This does not affect the AUDIO OUT (REC) level.

■ Opening and closing the front panel door

When you want to use the controls behind the front panel door, open the door by gently pressing on the lower part of the panel. Keep the door closed when not using these controls.

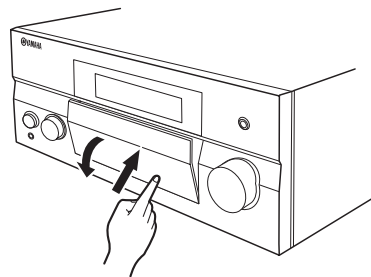

To open, press gently on the lower part of the panel.

Remote control

Remote control controls and functions

This section describes only the amplifier controls and functions of this unit. See the following pages for details about other control and functions.

- AM/FM tuning see page 54
- XM satellite radio tuning see page 62
- Controlling a TV see page 101
- Controlling other components see page 102
- Controlling option components see page 103

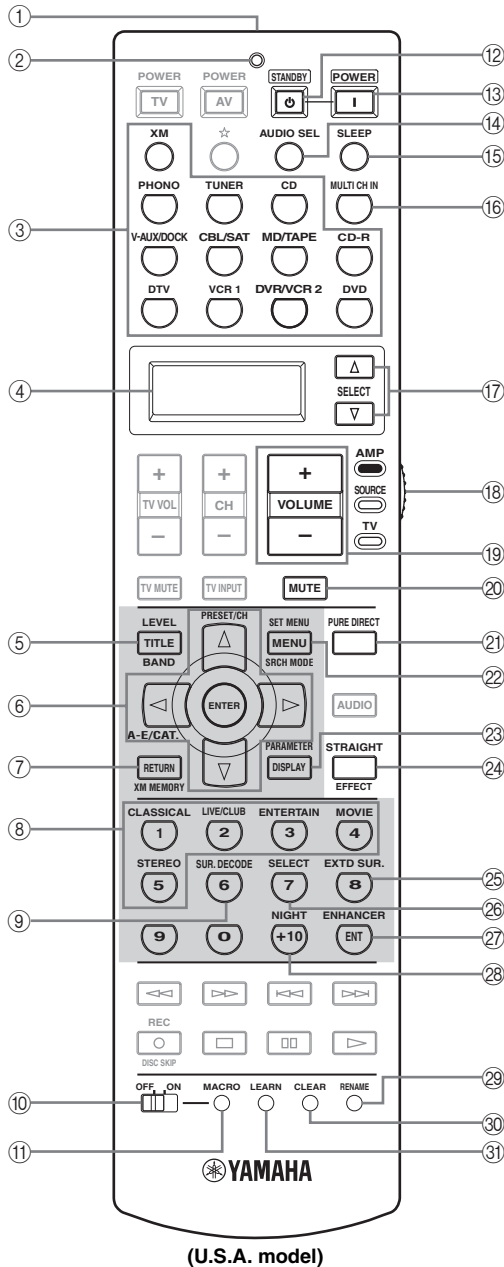

Note

The operation mode of the remote control buttons in the shaded area below depends on the operation mode selector position. Set the operation mode selector to AMP to control this unit.

① Infrared window

Outputs infrared control signals. Aim this window at the component you want to operate (see page 9).

② TRANSMIT indicator

Flashes while the remote control is sending infrared signals.

③ Input selector buttons

Select the input source you want to control.



The selected input source name appears in the display window on the remote control showing which source is currently operational.

④ Display window

Shows the name of the selected input source that you can control.

⑤ LEVEL

Selects the speaker channel to be adjusted and sets the output level (see page 51).

⑥ Cursor buttons Δ / ∇ / \triangleleft / \triangleright , ENTER

Select and adjust the sound field program parameters or the "SET MENU" parameters.

⑦ RETURN

Returns to the previous menu level when adjusting the "SET MENU" parameters.

⑧ Sound field program selector buttons

Select sound field programs (see page 44).

⑨ SUR. DECODE

Activates decoders to play back 2-channel sources in surround (see page 80).

⑩ MACRO ON/OFF

Turns on or off the macro function (see page 107).

⑪ MACRO

Programs a series of operations to be controlled with a single button (see page 107).

⑫ STANDBY

Sets the main zone to the standby mode (see page 31).

Note

This button is operational only when MASTER ON/OFF on the front panel is pressed inward to the ON position.

⑬ POWER

Turns on the main zone (see page 31).

Note

This button is operational only when MASTER ON/OFF on the front panel is pressed inward to the ON position.

⑭ AUDIO SEL

Toggles the priority for the type of audio input jack between “AUTO”, “HDMI”, “COAX/OPT” and “ANALOG” when one component is connected to two or more input jacks (see page 40).

⑮ SLEEP

Sets the sleep timer (see page 43).

⑯ MULTI CH IN

Selects the component connected to the MULTI CH INPUT jacks as the input source when using an external decoder, etc. (see page 41).

⑰ SELECT Δ / ∇

Selects another input source that you can control independently of the input source selected with the input selector buttons.

⑱ Operation mode selector

Selects the operation mode of the remote control buttons in the shaded area.

AMP

Operates the amplifier function of this unit.

SOURCE

Operates the component selected with an input selector button (see page 102).

TV

Operates the TV assigned to either DTV/CBL or PHONO (see page 101).

Notes

- To set the remote control codes for other components, see page 103.
- When you set the remote control codes for both DTV/CBL and PHONO (see page 103), priority is given to the one set for DTV/CBL.

⑲ VOLUME +/-

Increases or decreases the volume level.

⑳ MUTE

Mutes the audio output. Press again to restore the audio output to the previous volume level (see page 41).

㉑ PURE DIRECT

Turns on or off the pure direct mode (see page 50).

㉒ SET MENU

Enters “SET MENU” (see page 86).

㉓ PARAMETER

Displays sound field parameter settings in the on-screen display (OSD) (see page 76).

㉔ STRAIGHT

Turns the sound field programs off or on. When the “STRAIGHT” mode is selected, 2-channel or multi-channel input signals are output directly from their respective speakers without effect processing (see page 49).

㉕ EXT D SUR.

Switches between 5.1 and 6.1/7.1-channel playback of multi-channel sources (see page 80).

㉖ SELECT

Selects decoders for 2-channel sources (see pages 80 and 82).

㉗ ENHANCER

Turns on or off the Compressed Music Enhancer mode (see page 52).

㉘ NIGHT

Turns on or off the night listening modes (see page 53).

㉙ RENAME

Changes the name of the input source in the display window (see page 106).

㉚ CLEAR

Clears remote control functions acquired from the learn, macro and/or rename features (see page 110).

㉛ LEARN

Programs remote control codes of functions from other remote controls (see page 105).

Zone 2/Zone 3 remote control

This section describes the function of each control on the Zone 2/Zone 3 remote control used to control the amplifier functions of Zone 2 or Zone 3.

See the following pages for details about other controls and functions.

- AM/FM tuning see page 54
- XM Satellite Radio tuning see page 62

Note

Zone 2/Zone 3 remote control is supplied with U.S.A., Canada, Australia, U.K., China, Asia and General models only.

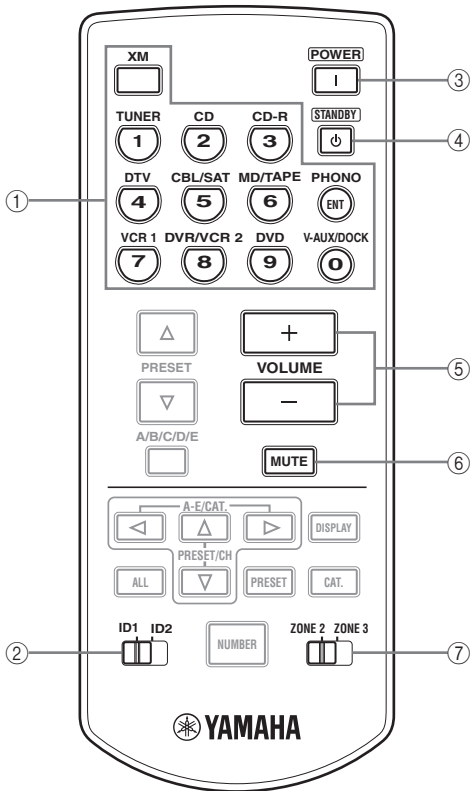

(U.S.A. model)

1 Input selector buttons

Select the desired input source of Zone 2 or Zone 3.

2 ID1/ID2 switch

Switches the remote control ID between ID1 and ID2 (see page 104).

3 POWER

Turns on Zone 2 or Zone 3.

Note

This button is operational only when MASTER ON/OFF on the front panel is pressed inward to the ON position.

4 STANDBY

Sets Zone 2 or Zone 3 to the standby mode.

Note

This button is operational only when MASTER ON/OFF on the front panel is pressed inward to the ON position.

5 VOLUME +/-

Increases or decreases the volume level of Zone 2 or Zone 3.

6 MUTE

Mutes the sound of Zone 2 or Zone 3. Press again to restore the audio output to the previous volume level.

7 ZONE 2/ZONE 3 switch

Switches between the operation mode of Zone 2 and that of Zone 3.

Preparing the remote control

■ Installing batteries in the remote control

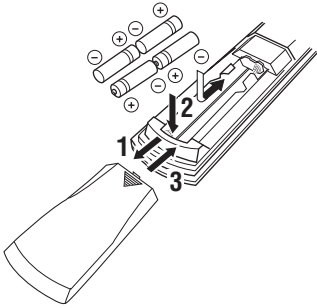

- 1 Press the ▼ part and slide the battery compartment cover off.
- 2 Insert the four supplied batteries (AAA, R03, UM-4) according to the polarity markings (+ and -) on the inside of the battery compartment.
- 3 Slide the cover back until it snaps into place.

■ Installing batteries in the Zone 2/Zone 3 remote control (Except Europe model)

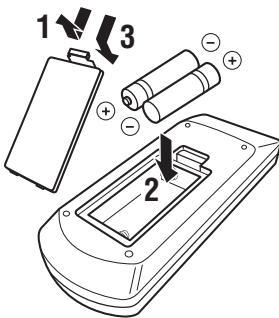

- 1 Take off the battery compartment cover.
- 2 Insert the two supplied batteries (AAA, R03, UM-4) according to the polarity markings (+ and -) on the inside of the battery compartment.
- 3 Snap the battery compartment cover back into place.

Notes

- Change all of the batteries if you notice the following conditions:
 - the operation range of the remote control decreases.
 - the TRANSMIT indicator does not flash or its light becomes dim.
- Do not use old batteries together with new ones.
- Do not use different types of batteries (such as alkaline and manganese batteries) together. Read the packaging carefully as these different types of batteries may have the same shape and color.
- If the batteries have leaked, dispose of them immediately. Avoid touching the leaked material or letting it come into contact with clothing, etc. Clean the battery compartment thoroughly before installing new batteries.
- Do not throw away batteries with general house waste; dispose of them correctly in accordance with your local regulations.
- If the remote control is without batteries for more than 2 minutes, or if exhausted batteries remain in the remote control, the contents of the memory may be cleared. When the memory is cleared, insert new batteries, set up the remote control code and program any acquired functions that may have been cleared.

■ Using the remote control

The remote control transmits a directional infrared ray. Be sure to aim the remote control directly at the remote control sensor on this unit during operation.

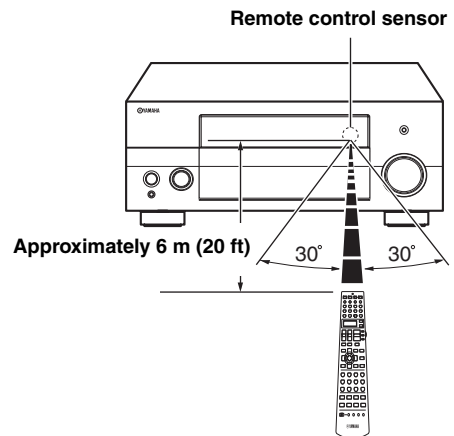

Notes

- Do not spill water or other liquids on the remote control.
- Do not drop the remote control.
- Do not leave or store the remote control in the following types of conditions:
 - places of high humidity, such as near a bath
 - places of high temperatures, such as near a heater or stove
 - places of extremely low temperatures
 - dusty places

Front panel display

Note

The XM indicator is only applicable to the U.S.A. and Canada models and the cursor on the left of the XM indicator lights up only when “XM” is selected as the input source. For details, see “Basic XM Satellite Radio operations” on page 65.

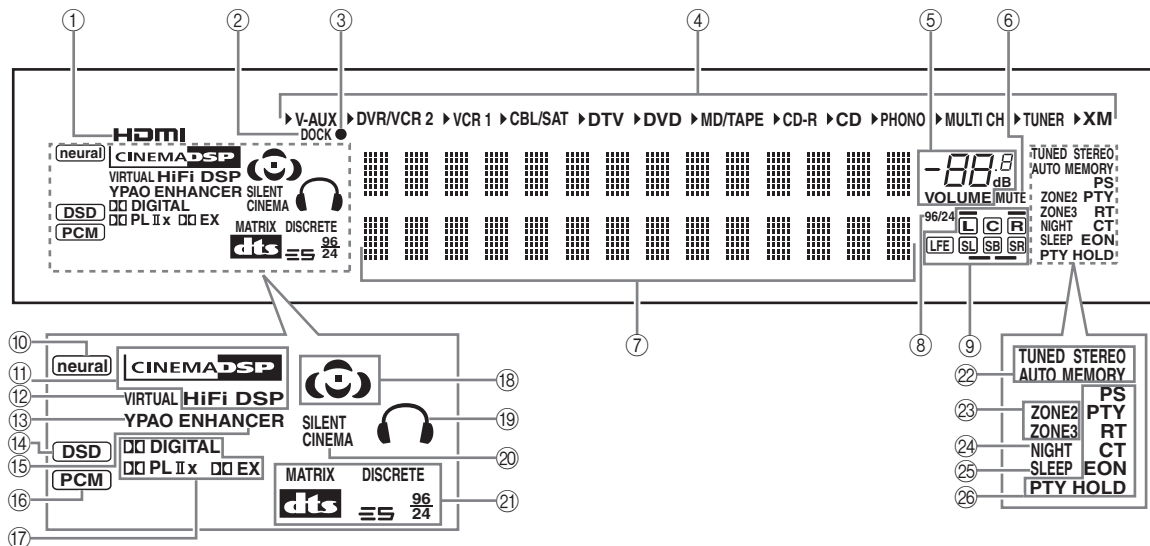

- ⑩ U.S.A. and Canada models only
- ⑲ U.K. and Europe models only

① HDMI indicator

Lights up when the signal of the selected input source is input at HDMI IN 1 or HDMI IN 2 jacks (see page 19).

② DOCK indicator

Lights up when you station your iPod in a YAMAHA iPod universal dock (such as the YDS-10, sold separately) connected to the DOCK terminal of this unit (see page 27).

③ Battery charge indicator

Lights up when this unit charges the battery of the stationed iPod in the standby mode of this unit. (see page 73).

④ Input source indicators

The corresponding cursor lights up to show the currently selected input source.

⑤ VOLUME level indicator

Indicates the current volume level.

⑥ MUTE indicator

Flashes while the MUTE function is on (see page 41).

⑦ Multi-information display

Shows the name of the current sound field program and other information when adjusting or changing settings.

⑧ 96/24 indicator

Lights up when a DTS 96/24 signal is input to this unit.

⑨ Input channel and speaker indicators

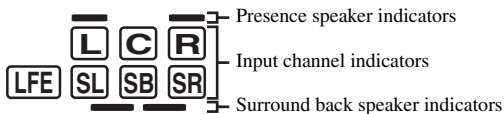

Input channel indicators

Indicate the channel components of the current digital input signal.

Presence and surround back speaker indicators

Light up according to the number of presence and surround back speakers set for “PRESENCE SP” (see page 89) and “SB L/R SP” (see page 89) in “SOUND MENU” when “TEST” in “SOUND MENU” is set to “ON” (see page 92).



You can make settings for the presence and surround back speakers automatically by running “AUTO SETUP” (see page 32) or manually by adjusting settings for “PRESENCE SP” (see page 89) and “SB L/R SP” (see page 89) in “SOUND MENU”.

⑩ neural indicator**(U.S.A. and Canada models only)**

Lights up when the Neural Surround decoder is activated (see page 81).

⑪ DSP indicators

The respective indicator lights up when any of the DSP sound field programs are selected.

CINEMA DSP indicator

Lights up when you select a CINEMA DSP sound field program (see page 45).

HiFi DSP indicator

Lights up when you select a HiFi DSP sound field program (see page 45).

⑫ VIRTUAL indicator

Lights up when Virtual CINEMA DSP is active (see page 49).

⑬ YPAO indicator

Lights up when you run "AUTO SETUP" and when the speaker settings set in "AUTO SETUP" are used without any modifications (see page 32).

⑭ DSD indicator

Lights up when this unit is producing DSD (Direct Stream Digital) digital audio signals.

⑮ ENHANCER indicator

Lights up when the Compressed Music Enhancer mode is turned on (see page 52).

⑯ PCM indicator

Lights up when this unit is reproducing PCM (Pulse Code Modulation) digital audio signals.

⑰ Dolby decoder indicators

The respective indicator lights up when any of the Dolby decoders of this unit function.

⑱ Sound field indicators

Light up to indicate the active DSP sound fields.

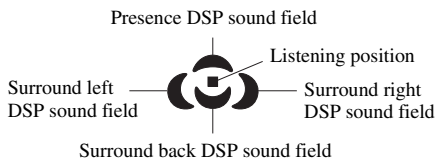
**⑲ Headphones indicator**

Lights up when headphones are connected (see page 41).

⑳ SILENT CINEMA indicator

Lights up when headphones are connected and a sound field program is selected (see page 49).

㉑ DTS decoder indicators

The respective indicator lights up when any of the DTS decoders of this unit function.

㉒ Tuner indicators

Lights up when this unit is in the FM, AM or XM Satellite Radio tuning mode.

TUNED indicator

Lights up when this unit is tuned into a station (see page 54).

STEREO indicator

Lights up when this unit is receiving a strong signal for an FM stereo broadcast while the AUTO indicator is lit (see page 54).

AUTO indicator

Lights up when this unit is in the automatic tuning mode (see page 54).

MEMORY indicator

Flashes to show that a station can be stored (see page 57).

㉓ ZONE2/ZONE3 indicators

Lights up when Zone 2 or Zone 3 is turned on (see page 114).

㉔ NIGHT indicator

Lights up when you select a night listening mode (see page 53).

㉕ SLEEP indicator

Lights up while the sleep timer is on (see page 43).

㉖ Radio Data System indicators (U.K. and Europe models only)**PS, PTY, RT and CT**

Light up according to the selected Radio Data System display mode.

EON

Lights up when the EON data service is being received.

PTY HOLD

Lights up while searching for the Radio Data System stations in the PTY SEEK mode.

Rear panel

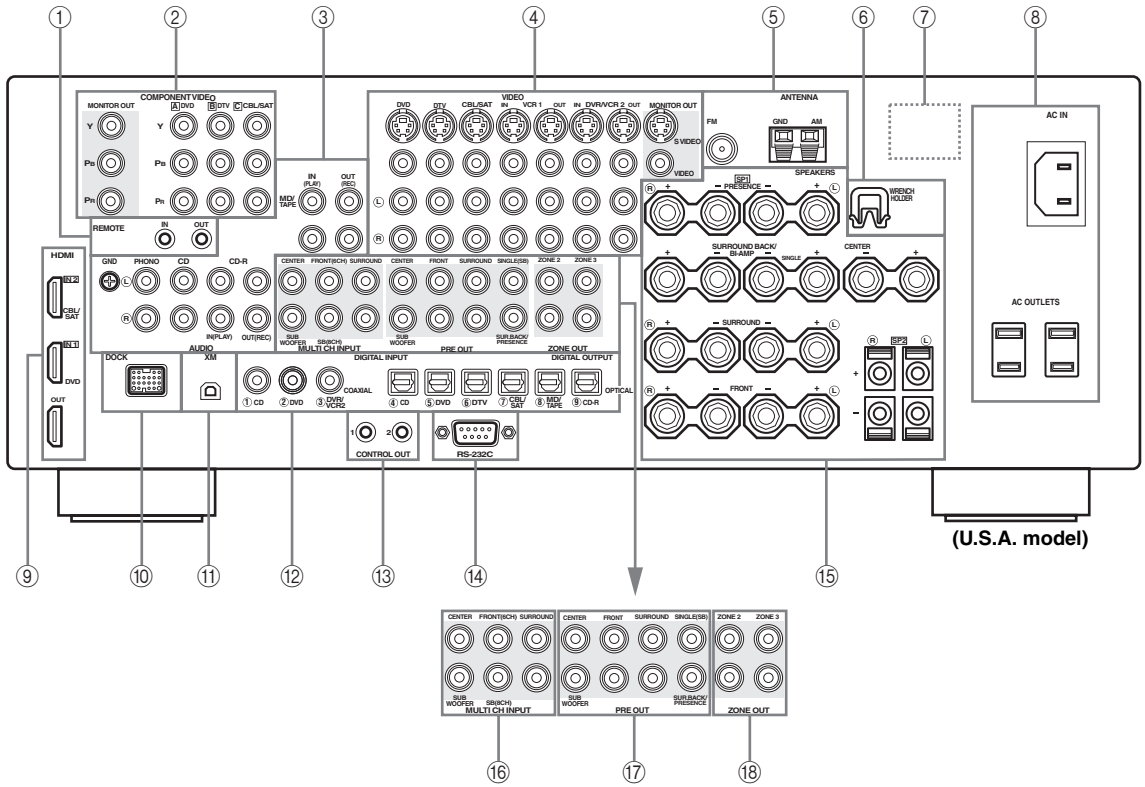

① REMOTE jacks

See page 113 for details.

② COMPONENT VIDEO jacks

See pages 21 and 22 for connection information.

③ Audio component jacks

See page 24 for connection information.

④ Video component jacks

See pages 21 and 22 for connection information.

⑤ ANTENNA terminals

See page 28 for connection information.

⑥ WRENCH HOLDER

Use to hook the supplied speaker terminal wrench when not in use (see page 15).

**⑦ VOLTAGE SELECTOR
(Asia and General models only)**

See page 29 for details.

⑧ AC IN/OUTLET(S)

See page 29 for connection information.

⑨ HDMI connectors

See page 19 for connection information.

⑩ DOCK terminal

See page 27 for connection information.

⑪ XM jack (U.S.A. and Canada models only)

See page 61 for connection information.

⑫ DIGITAL INPUT/OUTPUT jacks

See page 22 for connection information.

⑬ CONTROL OUT jack

This is a control expansion terminal for custom installation.

⑭ RS-232C terminal

This is a control expansion terminal for factory use only. Consult your dealer for details.

⑮ Speaker terminals

See page 14 for connection information.

⑯ MULTI CH INPUT jacks

See page 26 for connection information.

⑰ PRE OUT jacks

See page 25 for connection information.

⑱ ZONE OUT jacks

See page 113 for connection information.

CONNECTIONS

Placing speakers

The speaker layout below shows the speaker setting we recommend. You can use it to enjoy CINEMA DSP and multi-channel audio sources.

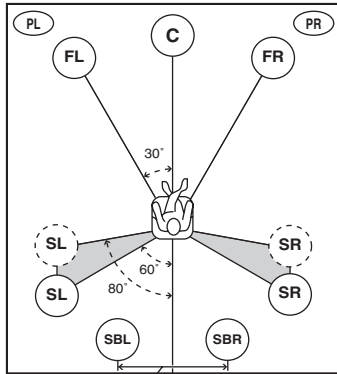

30 cm (12 in) or more

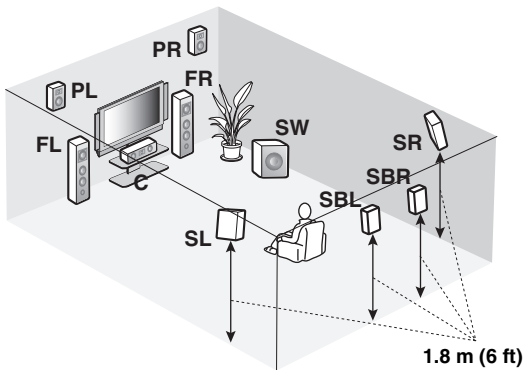

1.8 m (6 ft)

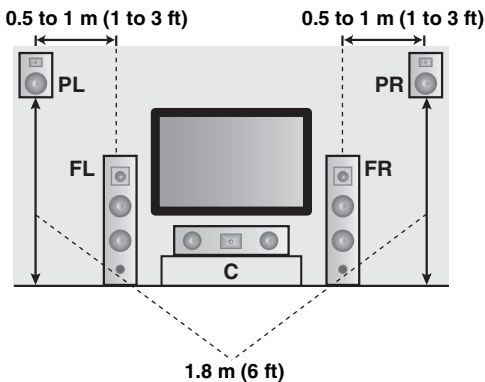

1.8 m (6 ft)

Front left and right speakers (FL and FR)

The front speakers are used for the main source sound plus effect sounds. Place these speakers at an equal distance from the ideal listening position. The distance of each speaker from each side of the video monitor should be the same.

Center speaker (C)

The center speaker is for the center channel sounds (dialog, vocals, etc.). If for some reason it is not practical to use a center speaker, you can do without it. Best results, however, are obtained with the full system. Place the center speaker centrally between the front speakers and as close to the monitor as possible, such as directly over or under it.

Surround left and right speakers (SL and SR)

The surround speakers are used for effect and surround sounds. Place these speakers behind your listening position, facing slightly inwards, about 1.8 m (6 ft) above the floor.

Surround back left and right speakers (SBL and SBR)

The surround back speakers supplement the surround speakers and provide more realistic front-to-back transitions. Place these speakers directly behind the listening position and at the same height as the surround speakers. They should be positioned at least 30 cm (12 in) apart. Ideally, they should be positioned at the same width as that of the front speakers.

Presence left and right speakers (PL and PR)

The presence speakers supplement the sound from the front speakers with extra ambient effects produced by CINEMA DSP (see page 134). These effects include sounds that filmmakers intend to locate a little farther back behind the screen in order to create more theater-like ambience. Place these speakers at the front of the room about 0.5 to 1 m (1 to 3 ft) outside the front speakers, facing slightly inward, and about 1.8 m (6 ft) above the floor.

Subwoofer (SW)

The use of a subwoofer with a built-in amplifier, such as the YAMAHA Active Servo Processing Subwoofer System, is effective not only for reinforcing bass frequencies from any or all channels, but also for high fidelity sound reproduction of the LFE (low-frequency effect) channel included in Dolby Digital and DTS sources. The position of the subwoofer is not so critical, because low bass sounds are not highly directional. But it is better to place the subwoofer near the front speakers. Turn it slightly toward the center of the room to reduce wall reflections.

Connecting speakers

Be sure to connect the left channel (L), right channel (R), “+” (red) and “-” (black) properly. If the connections are faulty, no sound will be heard from the speakers, and if the polarity of the speaker connections is incorrect, the sound will be unnatural and lack bass.

CAUTION

- Before connecting the speakers, make sure that this unit is turned off (see page 31).
- Do not let the bare speaker wires touch each other or do not let them touch any metal part of this unit. This could damage this unit and/or speakers.
- Use magnetically shielded speakers. If this type of speaker still creates interference with the monitor, place the speakers away from the monitor.
- If you are to use 6 ohm speakers, be sure to set “SP IMP.” to “6ΩMIN” before using this unit (see page 30). 4 ohm speakers can be also used as the front speakers (see page 118).

Notes

- A speaker cord is actually a pair of insulated cables running side by side. Cables are colored or shaped differently, perhaps with a stripe, groove or ridge. Connect the striped (grooved, etc.) cable to the “+” (red) terminals of this unit and your speaker. Connect the plain cable to the “-” (black) terminals.
- The low-frequency signals of other speakers set to “SML” (or “SMALL”) or to “NONE” in “SPEAKER SET” (see pages 87 and 89) are directed to the speakers selected in “LFE/BASS OUT” (see page 87).
- You can connect both surround back and presence speakers to this unit, however they do not output sound simultaneously. You can set to prioritize either set of speakers using the “PRIORITY” parameter in “MANUAL SETUP” (see page 89).
- You can use the PRESENCE terminals to connect the Zone 2 or Zone 3 speakers as well as the presence speakers (see page 113).

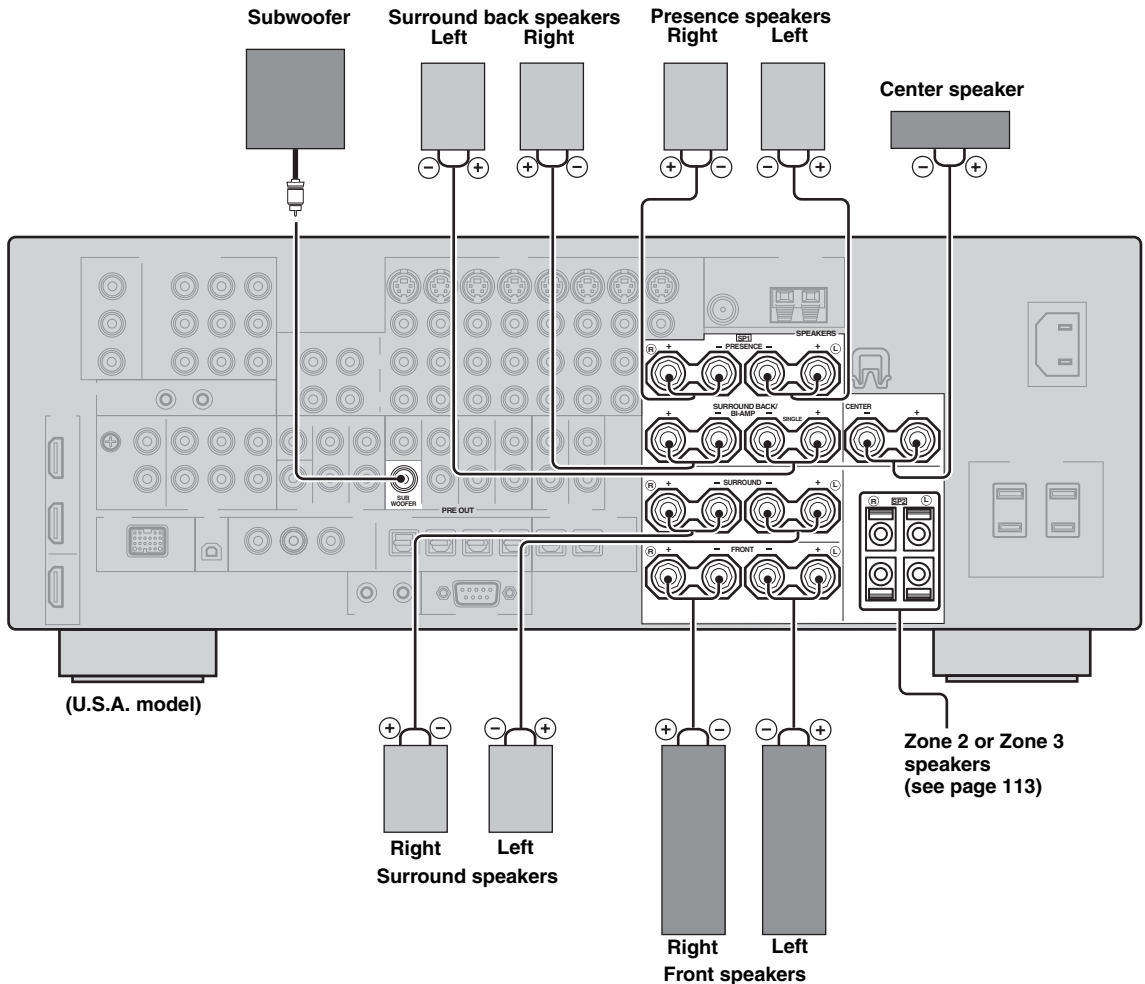

FRONT terminals

Connect front left and right speakers to these terminals.

CENTER terminals

Connect a center speaker to these terminals.

SURROUND terminals

Connect surround left and right speakers to these terminals.

SURROUND BACK terminals

Connect surround back left and right speakers to these terminals.

Note

When you use a surround back speaker, connect the speaker to the left SURROUND BACK terminal (SINGLE).

PRESENCE terminals

Connect presence left and right speakers to these terminals.

SUBWOOFER jack

Connect a subwoofer with a built-in amplifier (such as the YAMAHA Active Servo Processing Subwoofer System) to this jack.

■ **Connecting the speaker cable**

- 1 Remove approximately 10 mm (0.4 in) of insulation from the end of each speaker cable and then twist the exposed wires of the cable together to prevent short circuits.

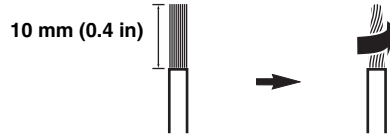

- 2 Loosen the knob using the supplied speaker terminal wrench.

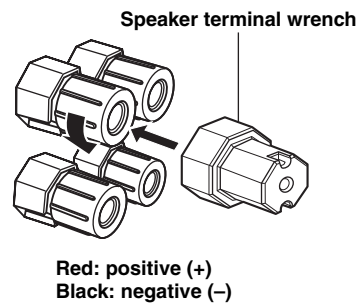

- 3 Insert one bare wire into the hole on the side of each terminal.

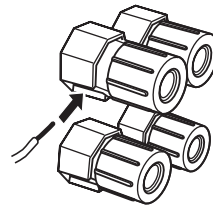

- 4 Tighten the knob to secure the wire using the supplied speaker terminal wrench.

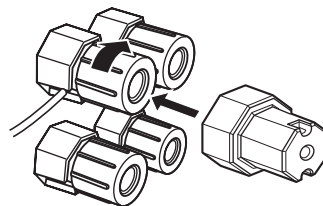

- 5** Hook the speaker terminal wrench onto the **WRENCH HOLDER** on the rear panel of this unit when not in use.

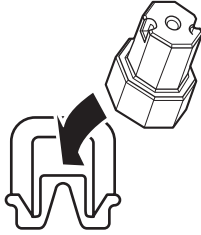

■ **Connecting to the SP2 speaker terminals**

Connect Zone 2 or Zone 3 speakers to these terminals (see page 113).

- 1** Open the tab.

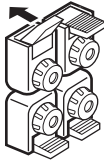

Red: positive (+)
Black: negative (-)

- 2** Insert one bare wire into the hole on the terminal.

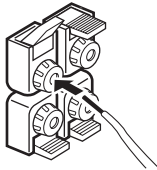

- 3** Close the tab to secure the wire.

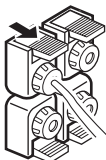

■ **Connecting the banana plug (except U.K., Europe, Asia and Korea models)**

The banana plug is a single-pole electrical connector widely used to terminate speaker cables.

Banana plug

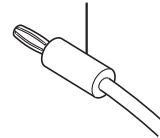

- 1** Tighten the knob using the supplied speaker terminal wrench.

Speaker terminal wrench

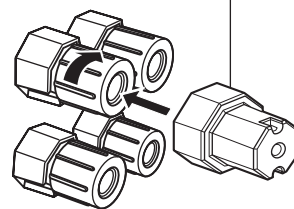

Red: positive (+)
Black: negative (-)

- 2** Insert the banana plug connector into the end of the corresponding terminal.

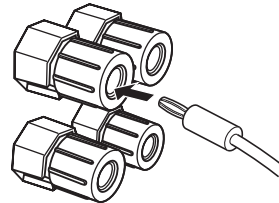

You can also use the banana plug with the SP2 speaker terminals. Open the tab and then insert one banana plug into the hole on the terminal. Do not close the tab after connecting the banana plug.

Using bi-amplification connections

Some of the speakers have speaker wire connections that allow bi-amplification to enhance the performance of the speaker system. This unit allows you to make bi-amplification connection to one speaker system. Check if your speakers support bi-amplification. As these speakers are shipped to you, you will note shorting bars or bridges, one connecting the two red input terminals and the other connecting the two black input terminals. Remove these shorting bars or bridges only if you plan to bi-amplify your speakers.

Conventional connection

If you want to connect your speakers as traditional loudspeakers using the conventional connection method, connect your speakers using the regular left and right speaker wire connections and ignore the second set of terminals.

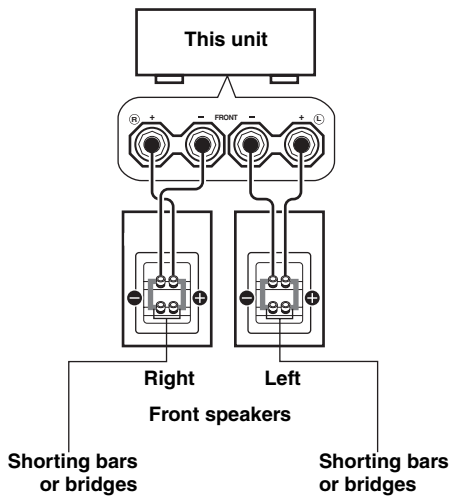

Bi-amplification connection

To make the bi-amplification connections, use the FRONT and SURROUND BACK terminals as shown below. To activate the bi-amplification connections, set "BI-AMP" to "ON" in "ADVANCED SETUP" (see page 119).

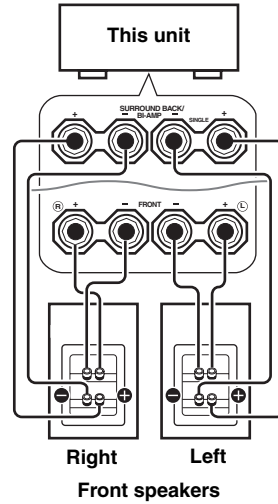

Note

Remove the shorting bars or bridges to separate the LPF (low pass filter) and HPF (high pass filter) crossovers.

Information on jacks and cable plugs

Audio jacks and cable plugs

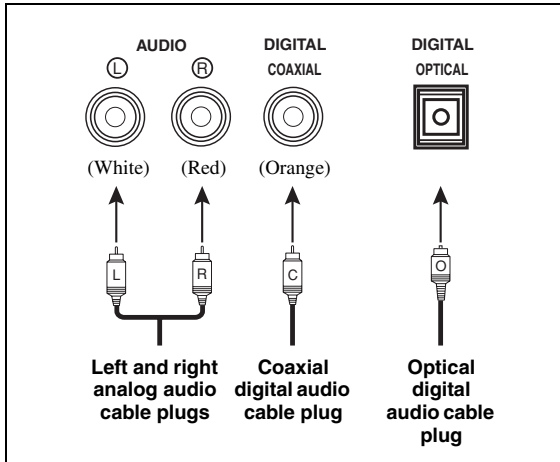

Video jacks and cable plugs

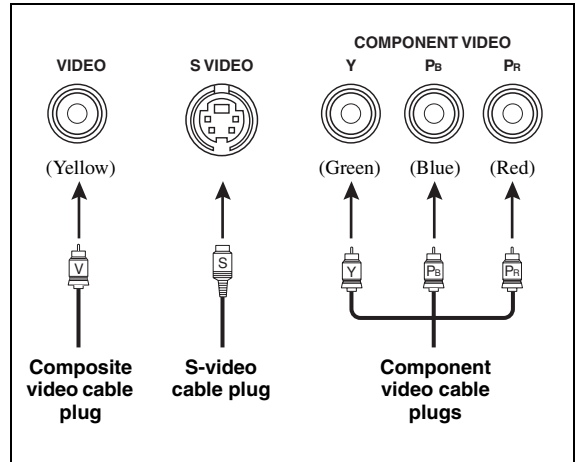

■ Audio jacks

This unit has three types of audio jacks. Connection depends on the availability of audio jacks on your other components.

AUDIO jacks

For conventional analog audio signals transmitted via left and right analog audio cables. Connect red plugs to the right jacks and white plugs to the left jacks.

DIGITAL COAXIAL jacks

For digital audio signals transmitted via coaxial digital audio cables.

DIGITAL OPTICAL jacks

For digital audio signals transmitted via optical digital audio cables.

Note

You can use the digital jacks to input PCM, Dolby Digital and DTS bitstreams. When you connect components to both the COAXIAL and OPTICAL jacks, priority is given to the signals input at the COAXIAL jack. All digital input jacks are compatible with 96-kHz sampling digital signals.

■ Video jacks

This unit has three types of video jacks. Connection depends on the availability of input jacks on your video monitor.

VIDEO jacks

For conventional composite video signals transmitted via composite video cables.

S VIDEO jacks

For S-video signals, separated into the luminance (Y) and chrominance (C) video signals transmitted on separate wires of S-video cables.

COMPONENT VIDEO jacks

For component video signals, separated into the luminance (Y) and chrominance (P_B, P_R) video signals transmitted on separate wires of component video cables.



This unit equips the video connection function. See pages 20 and 97 for details.

Information on HDMI

This unit has the HDMI IN 1, HDMI IN 2 and HDMI OUT jacks for digital audio and video signal input/output. Connect the HDMI IN 1 or HDMI IN 2 jack of this unit to the HDMI output jack of other HDMI components (such as a DVD player). Connect the HDMI OUT jack of this unit to the HDMI IN jack of other HDMI components (such as a TV and a projector).

The video or audio signals input at the HDMI IN 1 or HDMI IN 2 jack of the selected input source are output at the HDMI OUT jack of this unit.

Note

You can check the potential problem about the HDMI connection (see page 42).

HDMI compatibility with this unit

Audio signal types	Audio signal formats	Compatible HDMI components
2ch Linear PCM	2ch, 32-192 kHz, 16/20/24 bit	CD, DVD-Video, DVD-Audio, etc.
Multi-ch Linear PCM	8ch, 32-192 kHz, 16/20/24 bit	DVD-Audio, etc.
DSD	2/5.1ch, 2.8224 MHz, 1 bit	SACD, etc.
Bitstream	Dolby Digital, DTS	DVD-Video, etc.

This unit's HDMI interface is based on the following standards:

- HDMI Version 1.2a (High-Definition Multimedia Interface Specification Version 1.2a) licensed by HDMI Licensing, LLC.
- HDCP Revision 1.1 (High-bandwidth Digital Content Protection System Revision 1.1) licensed by Digital Content Protection, LLC.

Notes

- When CPPM copy-protected DVD audio is played back, video and audio signals may not be output depending on the type of the DVD player.
- This unit is not compatible with HDCP-incompatible HDMI or DVI components.

HDMI jack and cable plug

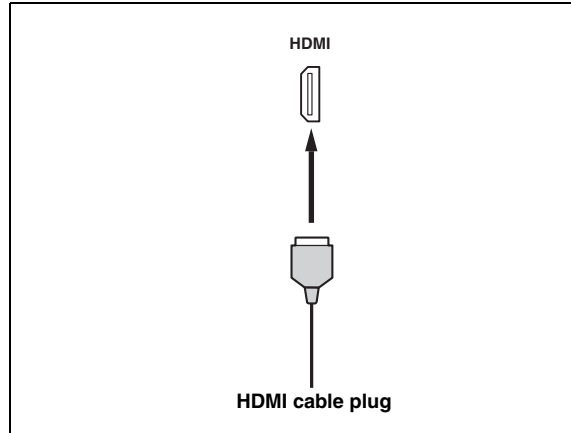

- We recommend using an HDMI cable shorter than 5 meters (16 feet) with the HDMI logo printed on it.
- Use a conversion cable (HDMI jack ↔ DVI-D jack) to connect this unit to other DVI components.

Notes

- Do not disconnect or connect the cable or turn off the power of the HDMI components connected to the HDMI OUT jack of this unit while data is being transferred. Doing so may disrupt playback or cause noise.
- Audio signals input at input jacks other than the HDMI IN 1 or HDMI IN 2 of this unit cannot be digitally output at the HDMI OUT jack.
- If you turn off the power of the video monitor connected to the HDMI OUT jack via a DVI connection, this unit may fail to establish the connection to the component.
- The analog video signals input at the composite video, S-video and component video jacks can be digitally up-converted to be output at the HDMI OUT jack. Set "V CONV." to "ON" in "MANUAL SETUP" (see page 98) to activate this feature.

Audio and video signal flow

Audio signal flow

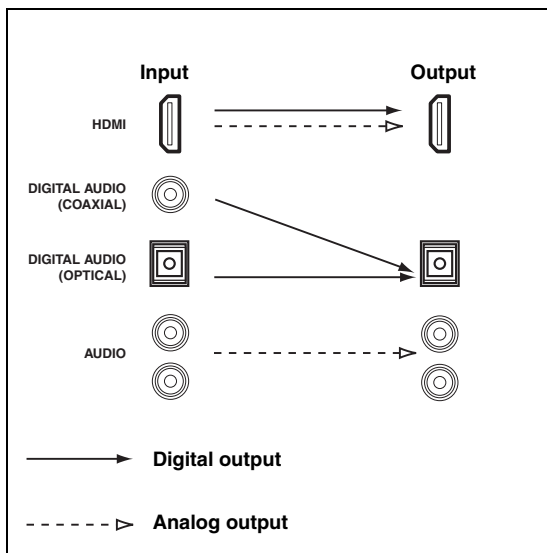

Notes

- 2-channel as well as multi-channel PCM, Dolby Digital and DTS signals input at the HDMI IN 1 or HDMI IN 2 jack can be output at the HDMI OUT jack only when "SUPPORT AUDIO" is set to "OTHER" (see page 93).
- Audio signals input at the HDMI IN jacks are not output at the analog AUDIO OUT and DIGITAL OUTPUT jacks.

Video signal flow

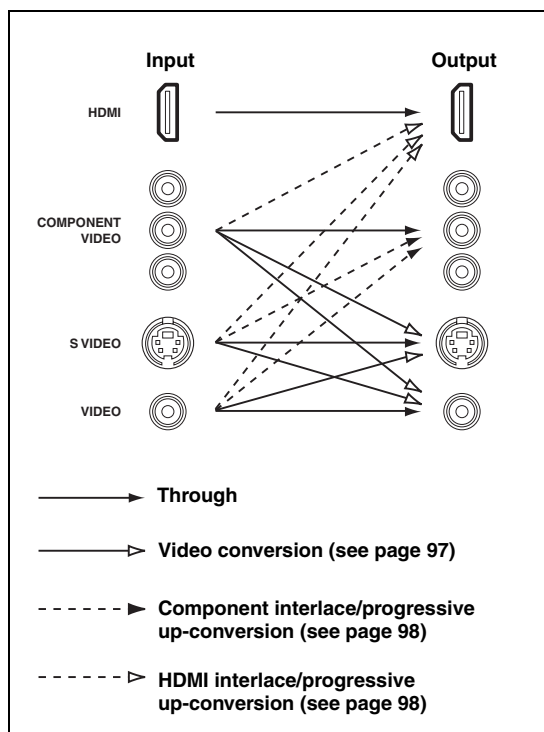

Notes

- When the analog video signals are input at the COMPONENT VIDEO, S VIDEO and VIDEO jacks, the priority order of the input signals is as follows:
 1. COMPONENT VIDEO
 2. S VIDEO
 3. VIDEO
- The analog video signals output at the COMPONENT VIDEO jacks can be deinterlaced from 480i (NTSC)/576i (PAL) to 480p/576p. Set CMPNT I/P to ON in MANUAL SETUP to activate this feature (see page 98).
- Digital video signals input at the HDMI IN 1 or HDMI IN 2 jack cannot be output from analog video output jacks.
- The analog component video signals with 480i (NTSC)/576i (PAL) of resolution are converted to the s-video or composite video signals and output at the S VIDEO MONITOR OUT and VIDEO MONITOR OUT jacks.
- Component interlace/progressive conversion (see page 98) and HDMI interlace/progressive up-conversion (see page 98) are available only when "V CONV." is set to "ON" (see page 97).
- Use the "HDMI I/P" parameter in "OPTION MENU" to deinterlace the analog video signals output at the HDMI OUT jack (see page 98). When the analog video signals with 1080i or 720p of resolution are up-converted to HDMI and output at the HDMI OUT jack, the picture quality may worsen.
- The OSD signal is not output at the VCR 1 OUT and DVR/VCR 2 OUT jacks and is not recorded.
- The color of the letters and images in the OSD may differ depending on the input signals and your video monitor.

Connecting a TV monitor or projector

Connect your TV (or projector) to the HDMI OUT jack, the COMPONENT VIDEO MONITOR OUT jacks, the S VIDEO MONITOR OUT jack or the VIDEO MONITOR OUT jack of this unit.

CAUTION

Do not connect this unit or other components to the AC power supply until all connections between components are complete.

 You can select to play back HDMI audio signals on this unit or on another HDMI component connected to the HDMI OUT jack on the rear panel of this unit. Use the "SUPPORT AUDIO" parameter in "SOUND MENU" to select the component to play back HDMI audio signals (see page 93).

Notes

- Some video monitors connected to this unit via a DVI connection fail to recognize the HDMI audio/video signals being input if they are in the standby mode. In this case, the HDMI indicator flashes irregularly.
- Set "V CONV." in "OPTION MENU" to "ON" (see page 97) to display the short message display and parameter displays.
- Set "GRAY BACK" in "OPTION MENU" to "ON" (see page 97) to display the parameter displays.
- The SET MENU and parameter displays appear with the gray background depending on the input video signal format and the setting of the parameters in "DISPLAY SET" (see page 97).

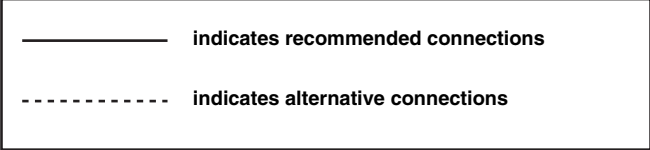
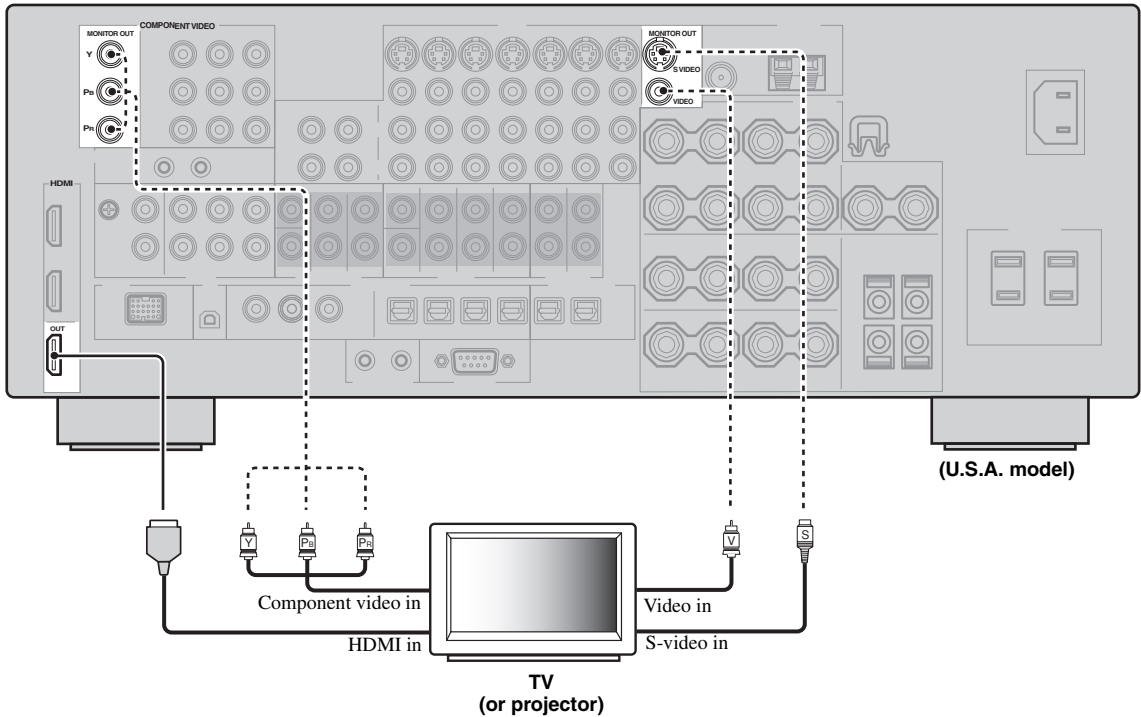

Connecting other components

CAUTION

Do not connect this unit or other components to the AC power supply until all connections between components are complete.

Notes

- When “V CONV.” is set to “OFF” (see page 97), be sure to make the same type of video connections as those made for your TV (see page 21). For example, if you connected your TV to the VIDEO MONITOR OUT jack of this unit, connect your other components to the VIDEO jacks.
- When “V CONV.” is set to “ON” (see page 97), the converted video signals are output only at the MONITOR OUT jacks. When recording a source, you must make the same type of video connections between each component.
- To make a digital connection to a component other than the default component assigned to each DIGITAL INPUT or DIGITAL OUTPUT jack, select the corresponding setting for “OPTICAL OUT”, “OPTICAL IN”, or “COAXIAL IN” in “I/O ASSIGNMENT” (see page 94).
- If you connect your DVD player to both the DIGITAL INPUT (OPTICAL) and the DIGITAL INPUT (COAXIAL) jacks, priority is given to the signals input at the DIGITAL INPUT (COAXIAL) jack.
- The parameter displays do not appear when the component video signals with 720p, 1080i or 1080p are input.
- The parameter and short message displays do not appear when the component video signals with 480p/576p, 720p, 1080i or 1080p resolutions are input and output at the VIDEO or S VIDEO MONITOR OUT jack.

■ Connecting a DVD player

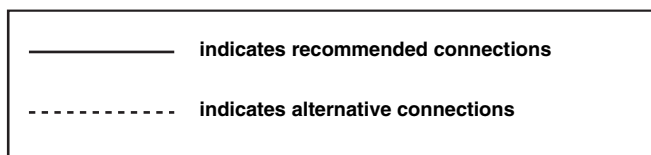
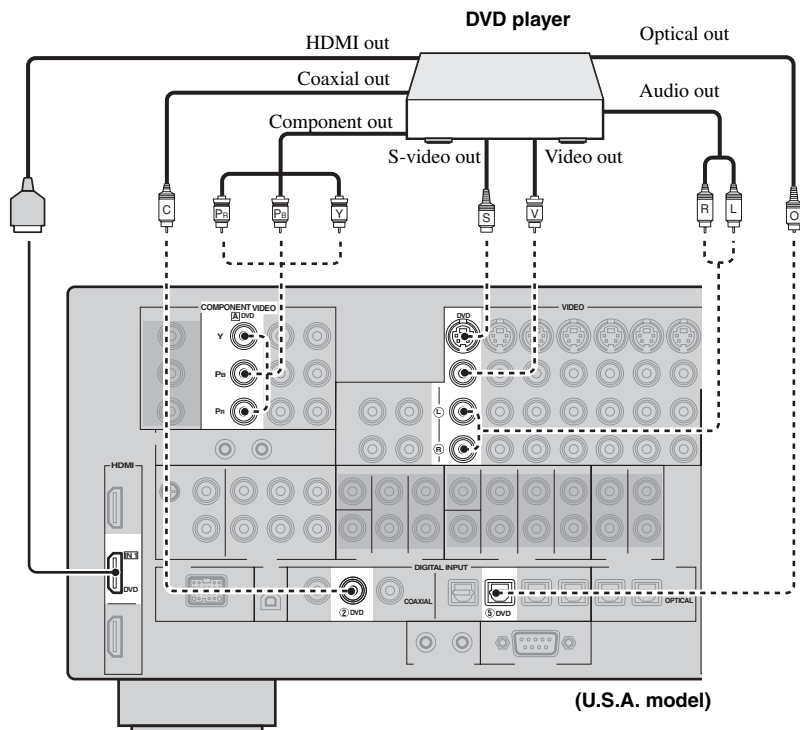

■ Connecting a DVD recorder, PVR or VCR

Note

*1 When you connect another VCR to this unit, connect it to the VCR 1 terminals (S VIDEO IN, VIDEO IN, AUDIO IN, S VIDEO OUT, VIDEO OUT and AUDIO OUT jacks) same as DVR/VCR 2 terminals except the DIGITAL INPUT (COAXIAL) jack.

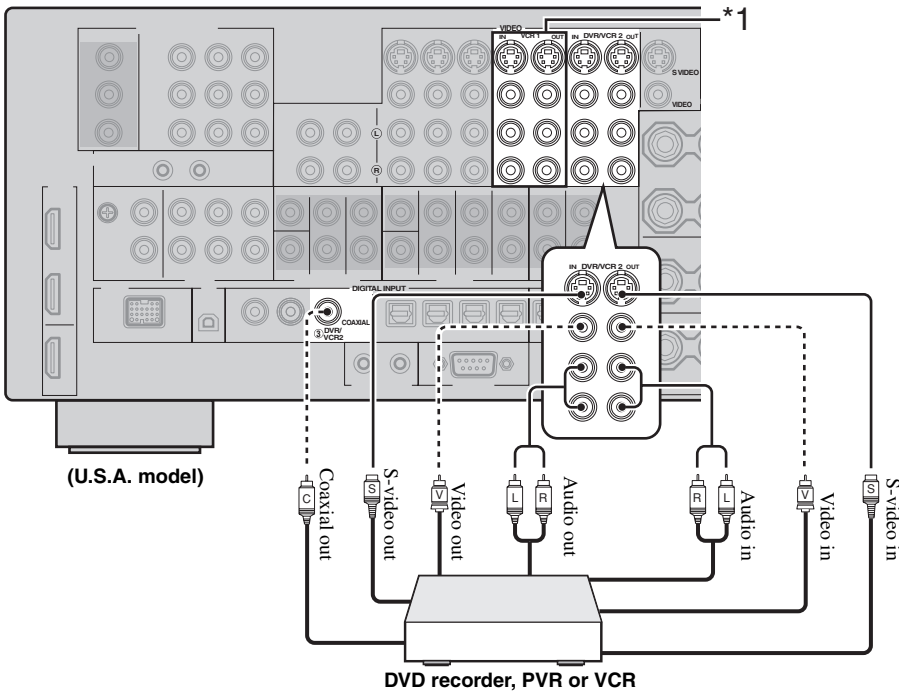

■ Connecting set-top boxes

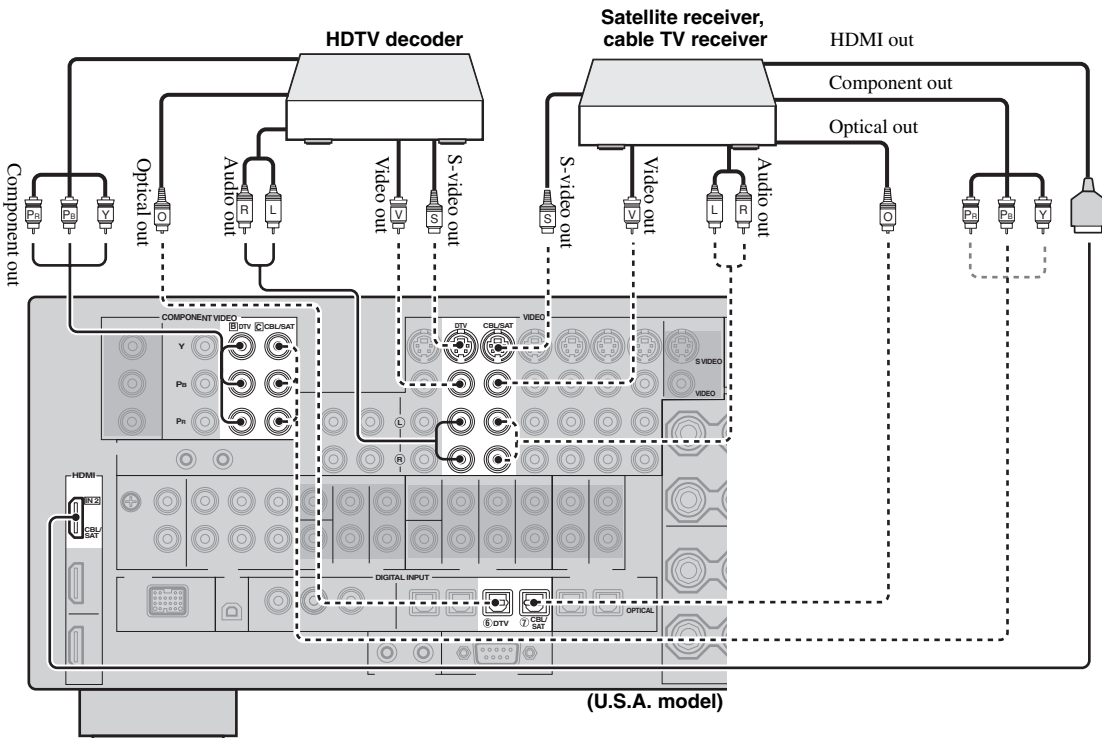

■ Connecting audio components

Notes

- To make a digital connection to a component other than the default component assigned to each the DIGITAL INPUT jack or the DIGITAL OUTPUT jack, select the corresponding setting for “OPTICAL OUT”, “OPTICAL IN”, or “COAXIAL IN” in “I/O ASSIGNMENT” (see page 94).
- Connect your turntable to the GND terminal of this unit to reduce noise in the signal. However, you may hear less noise without the connection to the GND terminal for some turntables.
- The PHONO jacks are only compatible with a turntable with an MM or a high-output MC cartridge. To connect a turntable with a low-output MC cartridge to the PHONO jacks, use an in-line boosting transformer or an MC-head amplifier.
- When you connect both the DIGITAL INPUT (OPTICAL) jack and the DIGITAL INPUT (COAXIAL) jack to an audio component, the priority is given to the DIGITAL INPUT (COAXIAL) jack.

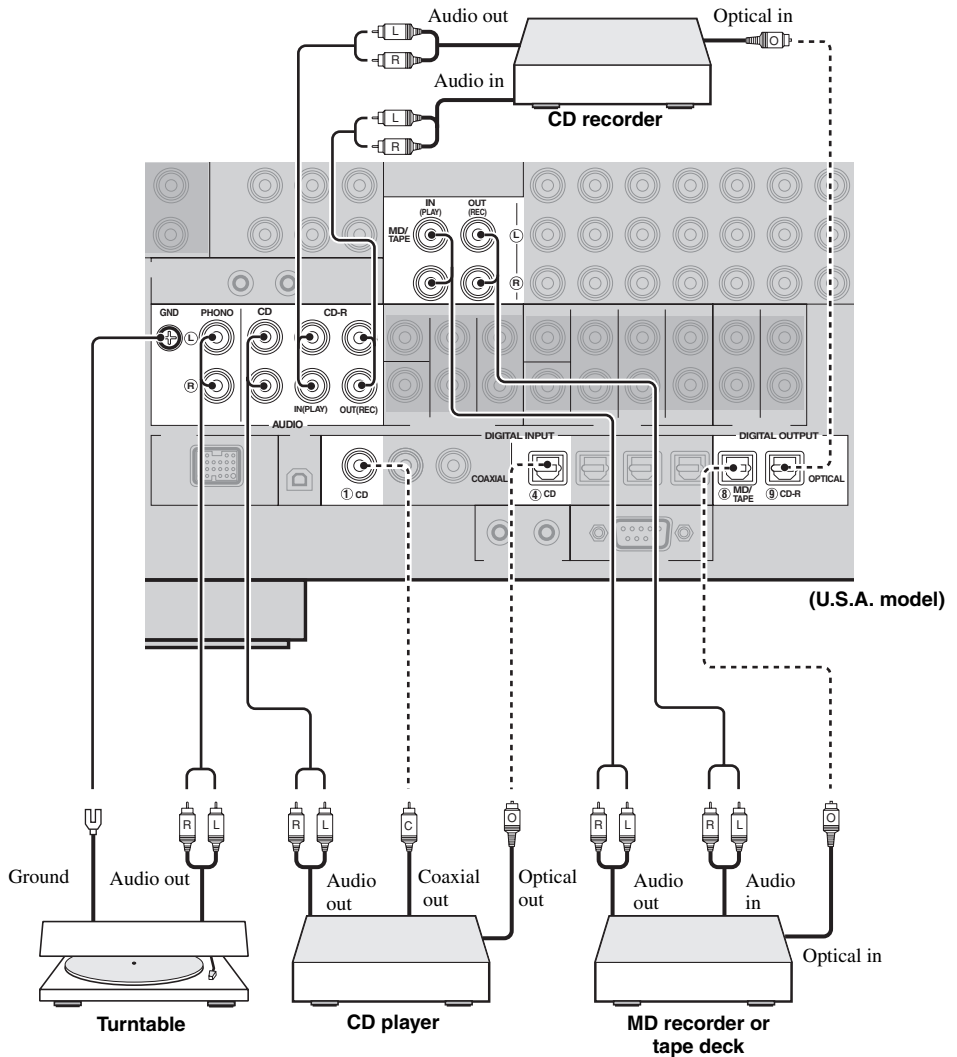

■ Connecting an external amplifier

This unit has more than enough power for any home use. However, if you want to add more power to the speaker output or if you want to use another amplifier, connect an external amplifier to the PRE OUT jacks.

Notes

- When you make connections to the PRE OUT jacks, do not make connections to the SPEAKERS terminals.
- The signals output at the FRONT PRE OUT and CENTER PRE OUT jacks are affected by the TONE CONTROL settings (see page 50).
- Each PRE OUT jack outputs the same channel signals as the corresponding SPEAKERS terminals.
- Adjust the volume level of the subwoofer with the control on the subwoofer (see page 51).
- Some signals may not be output at the SUBWOOFER PRE OUT jack depending on the settings for “SPEAKER SET” (see page 87) and “LFE/BASS OUT” (see page 87).

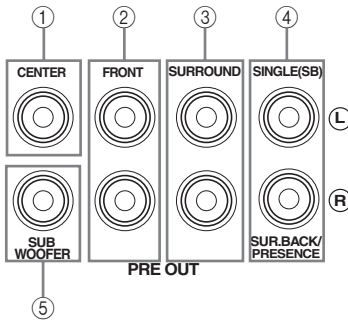

① CENTER PRE OUT jack

Center channel output jack.

② FRONT PRE OUT jacks

Front channel output jacks.

③ SURROUND PRE OUT jacks

Surround channel output jacks.

④ SURROUND BACK/PRESENCE PRE OUT jacks

Surround back or presence channel output jacks. When you only connect one external amplifier for the surround back channel, connect it to the SINGLE (SB) jack.



- Set the “SB L/R SP” to “LRGx2”, “LRGx1”, “SMLx2” or “SMLx1” and “PRESENCE SP” to “NONE” (see page 89) to output the surround back channel signals at SURROUND BACK/PRESENCE PRE OUT jacks.
- Set the “PRESENCE SP” to “YES” and “SB L/R SP” to “NONE” (see page 89) to output the presence channel signals at SURROUND BACK/PRESENCE PRE OUT jacks.

⑤ SUBWOOFER PRE OUT jack

Connect a subwoofer with a built-in amplifier.

Connecting a multi-format player or an external decoder

This unit is equipped with 6 additional input jacks (left and right FRONT, CENTER, left and right SURROUND and SUBWOOFER) for discrete multi-channel input from a multi-format player, external decoder, sound processor or pre-amplifier.

If you set "INPUT CH" to "8ch" in "MULTI CH SET" (see page 96), you can use the input jacks assigned as "FRONT" in MULTI CH SET (see page 96) together with the MULTI CH INPUT jacks to input 8-channel signals.

Connect the output jacks on your multi-format player or external decoder to the MULTI CH INPUT jacks. Be sure to match the left and right outputs to the left and right input jacks for the front and surround channels.

Notes

- When you select the component connected to the MULTI CH INPUT jacks as the input source (see page 41), this unit automatically turns off the digital sound field processor, and you cannot select sound field programs.
- This unit does not redirect signals input at the MULTI CH INPUT jacks to accommodate for missing speakers. We recommend that you connect at least a 5.1-channel speaker system before using this feature.

For 6-channel input

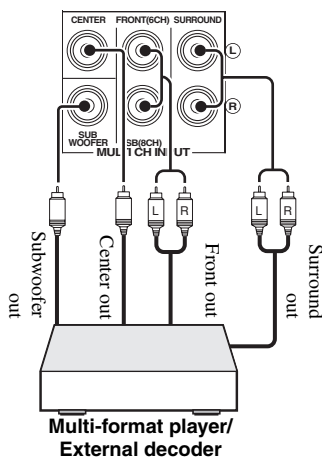

For 8-channel input

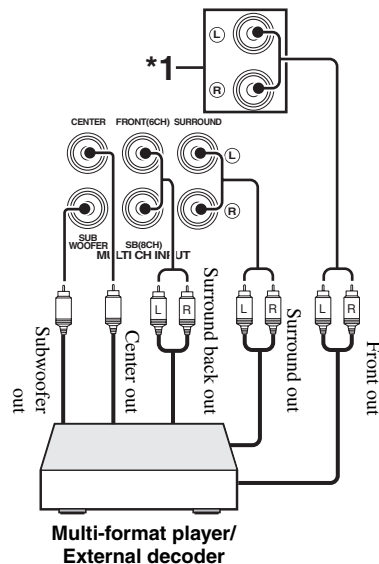

Note

*1 The analog audio input jacks assigned as "FRONT" in "MULTI CH SET" (see page 96).

Connecting a YAMAHA iPod universal dock

This unit is equipped with the DOCK terminal on the rear panel that allows you to connect a YAMAHA iPod universal dock (such as the YDS-10, sold separately) where you can station your iPod and control playback of your iPod using the supplied remote control. Connect a YAMAHA iPod universal dock (such as the YDS-10, sold separately) to the DOCK terminal on the rear panel of this unit using its dedicated cable.

CAUTION

Do not connect this unit to the AC power supply until all connections between components are complete.

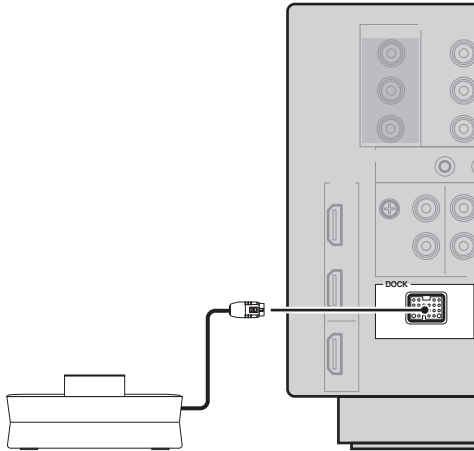

YAMAHA iPod universal dock (such as the YDS-10, sold separately)

Using the VIDEO AUX jacks on the front panel

Use the VIDEO AUX jacks on the front panel to connect a game console or a video camera to this unit.

CAUTION

Be sure to turn off the volume of this unit and other components before making connections.

Note

The audio signals input at the DOCK terminal on the rear panel take priority over the ones input at the VIDEO AUX jacks.

(U.S.A. model)

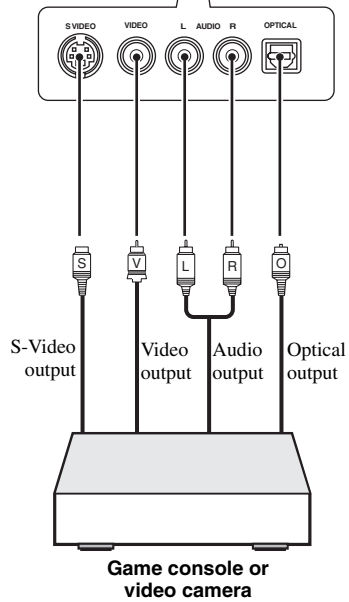
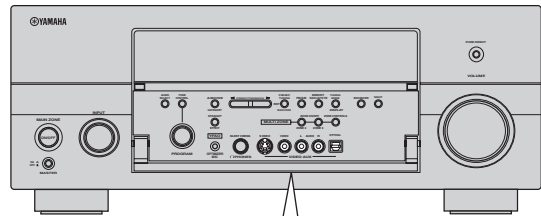

PREPARATION

Connecting the FM and AM antennas

Both FM and AM indoor antennas are supplied with this unit. Connect each antenna correctly to the designated terminals. In general, these antennas should provide sufficient signal strength.

Notes

- Be sure to set the tuner frequency step (Asia and General models only) according to the frequency spacing in your area (see page 119).
- The AM loop antenna should be placed away from this unit.
- The AM loop antenna should always be connected, even if an outdoor AM antenna is connected to this unit.
- A properly installed outdoor antenna provides clearer reception than an indoor one. If you experience poor reception quality, install an outdoor antenna. Consult the nearest authorized YAMAHA dealer or service center about outdoor antennas.

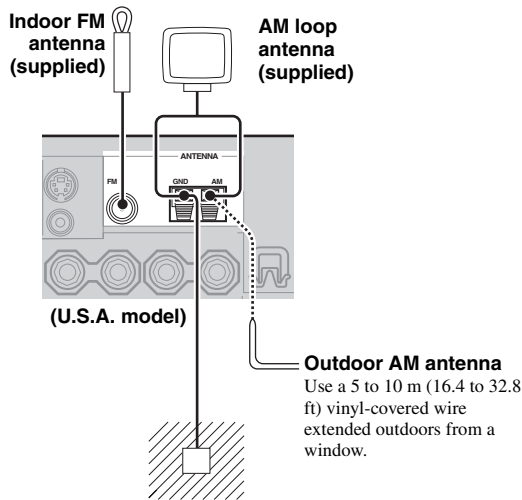

Ground (GND terminal)

For maximum safety and minimum interference, connect the antenna GND terminal to a good earth ground. A good earth ground is a metal stake driven into moist earth.

■ Connecting the AM loop antenna

1 Set up the AM loop antenna.

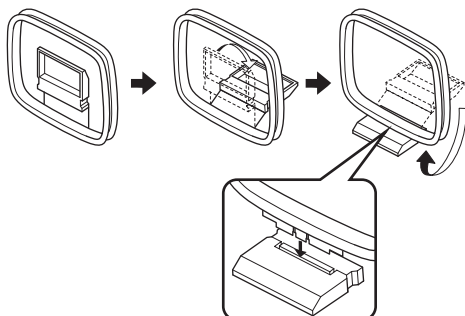

2 Press and hold the tab of the AM ANT terminal.



3 Insert one of the AM loop antenna lead wires into the AM ANT terminal.

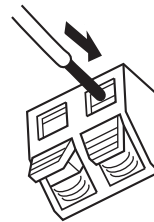

4 Release the tab of the AM ANT terminal.



5 Repeat steps 2 through 4 to connect the other lead wire to the GND terminal.



Once you have properly connected the AM loop antenna to this unit, orient the AM loop antenna for the best reception when you tune into AM stations (see page 54).

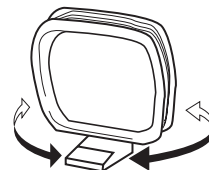

Connecting the power cable

■ Connecting the AC power cable

CAUTION

Use the supplied AC cable. Do not use other AC power cables as doing so may result in fire or electrical shock.

Plug the supplied AC power cable into the AC inlet after all other connections are complete, then plug the AC power cable into an AC wall outlet.

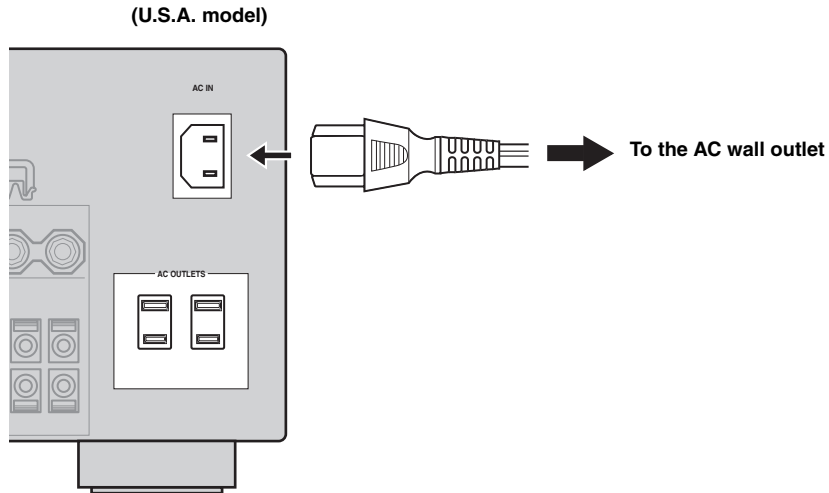

■ VOLTAGE SELECTOR (Asia and General models only)

CAUTION

The **VOLTAGE SELECTOR** on the rear panel of this unit must be set for your local voltage **BEFORE** plugging the power cable into the AC wall outlet. Improper setting of the **VOLTAGE SELECTOR** may cause damage to this unit and create a potential fire hazard.

Rotate the **VOLTAGE SELECTOR** clockwise or counterclockwise to the correct position using a straight slot screwdriver.

Voltages are as follows:

Asia model220/230–240 V AC, 50/60 Hz
 General model110/120/220/230–240 V AC, 50/60 Hz

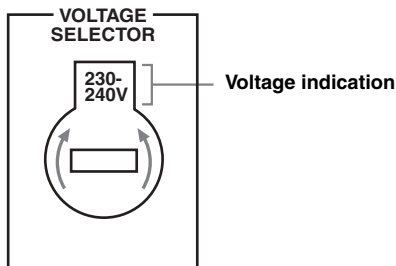

■ AC OUTLET(S) (SWITCHED)

U.K. and Australia models 1 outlet
 Korea model None
 Other models 2 outlets

Use these outlet(s) to supply power to any connected components. Connect the power cable of your other components to these outlet(s). Power to these outlet(s) is supplied when this unit is turned on. However, power to these outlet(s) is cut off when this unit is turned off. For information on the maximum power or the total power consumption of the components that can be connected to these outlet(s), see “SPECIFICATIONS” on page 136.

Memory back-up

The memory back-up circuit prevents the stored data from being lost even if this unit is in the standby mode. However, the stored data will be lost in case the power cable is disconnected from the AC wall outlet or if the power supply is cut off for more than one week.

Setting the speaker impedance

CAUTION

If you are to use 6 ohm speakers, set “SPEAKER IMP.” to “6ΩMIN” as follows BEFORE using this unit. 4 ohm speakers can be also used as the front speakers.

(U.S.A. model)

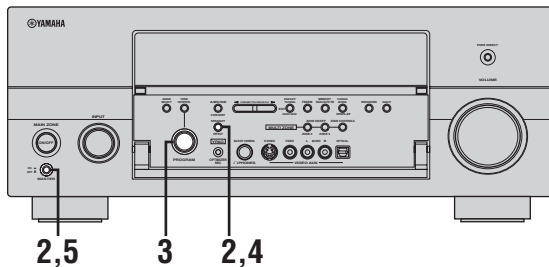

1 Make sure this unit is turned off.
See page 31 for details about turning on or off this unit.

2 Press and hold STRAIGHT on the front panel and then press MASTER ON/OFF inward to the ON position to turn on this unit.
This unit turns on, and the advanced setup menu appears in the front panel display.



3 Rotate the PROGRAM selector on the front panel to select “SPEAKER IMP.”
The following display appears in the front panel display.

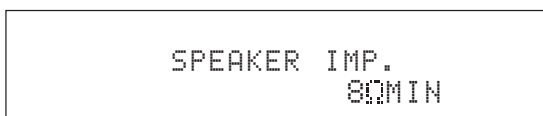

4 Press STRAIGHT on the front panel repeatedly to select “6ΩMIN”.
The following display appears in the front panel display.

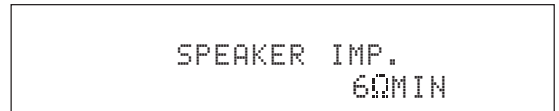

5 Press MASTER ON/OFF on the front panel to release it outward to the OFF position to save the new setting and turn off this unit.



Note

The setting you made is reflected next time you turn on this unit.

Turning on and off the power

When all connections are complete, turn on this unit.

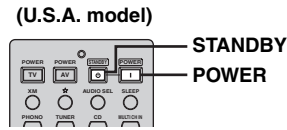
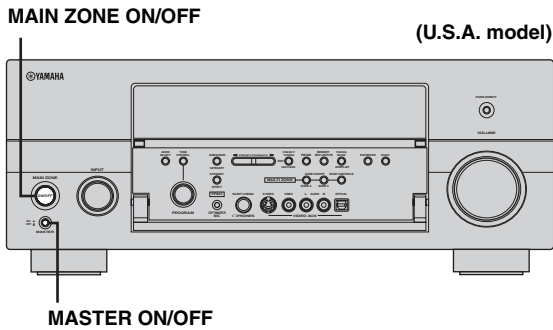

Turning on this unit

Press **MASTER ON/OFF** on the front panel inward to the **ON** position to turn on this unit.

When you turn on this unit by pressing **MASTER ON/OFF**, the main zone is turned on.



Turning on the main zone from the standby mode

Press **MAIN ZONE ON/OFF** on the front panel (or **POWER** on the remote control) to turn on the main zone.

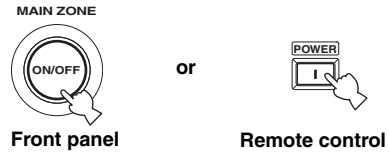

Turning off this unit

Press **MASTER ON/OFF** on the front panel again to release it outward to the **OFF** position to turn off this unit.



Set the main zone to the standby mode

Press **MAIN ZONE ON/OFF** on the front panel (or **STANDBY** on the remote control) to set the main zone to the standby mode.

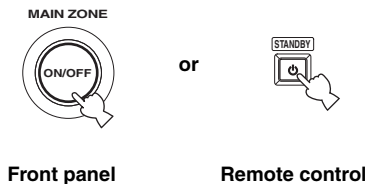

Notes

- MAIN ZONE ON/OFF on the front panel as well as POWER and STANDBY on the remote control are operational only when MASTER ON/OFF is pressed inward to the ON position.
- As usual, we recommend using the standby mode to turn off this unit.

AUTO SETUP

This unit employs the YPAO (YAMAHA Parametric Room Acoustic Optimizer) technology which lets you avoid troublesome listening-based speaker setup and achieves highly accurate sound adjustments automatically. The supplied optimizer microphone collects and this unit analyzes the sound your speakers produce in your actual listening environment.

Using AUTO SETUP

Once you have connected the supplied optimizer microphone to the OPTIMIZER MIC jack on the front panel and have placed it in a suitable location in your listening room, run “AUTO SETUP” in the OSD or in the front panel display.

Notes

- Be advised that it is normal for loud test tones to be output during the “AUTO SETUP” procedure.
- To achieve the best results, make sure the room is as quiet as possible while the “AUTO SETUP” procedure is in progress. If there is too much ambient noise, the results may not be satisfactory.



- You can run “AUTO SETUP” using the system menu that appears in the OSD or in the front panel display. This manual uses the OSD illustrations to explain the “AUTO SETUP” procedure.
- If an error occurs during the “AUTO SETUP” procedure and an error or warning message appears in the OSD or in the front panel display, see the “AUTO SETUP” section in “TROUBLESHOOTING” on pages 128 and 129 for a complete list of error and warning messages and proper remedies.
- The initial setting for each parameter is indicated in bold.
- If the volume level and the crossover frequency of your subwoofer can be adjusted, set the volume level to about half way (or slightly less) and set the crossover frequency to the maximum.

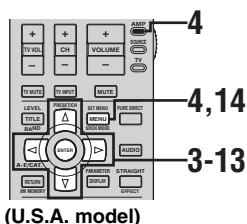

- 1 Connect the supplied optimizer microphone to the OPTIMIZER MIC jack on the front panel.

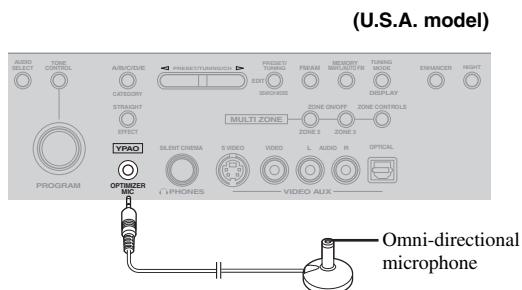

- 2 Place the optimizer microphone at your normal listening position on a flat level surface with the omni-directional microphone heading upward.

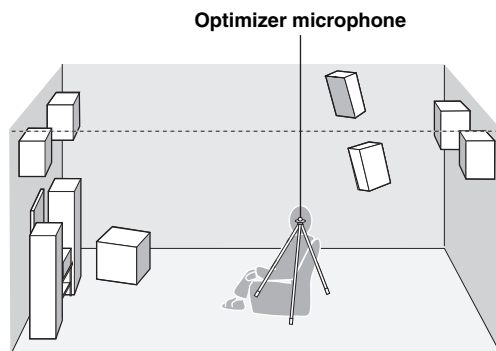

It is recommended that you use a tripod (etc.) to affix the optimizer microphone at the same height as your ears would be when you are seated in your listening position. You can use a 6 mm diameter screw to fix the optimizer microphone to a tripod (etc.).

3 Make sure of the following check points before starting the AUTO SETUP operations.

- Speakers are connected appropriately.
- Supplied optimizer microphone is connected to this unit and placed appropriately.
- Headphones are disconnected from this unit.
- The room is sufficiently quiet.
- The video monitor connected to this unit is turned on.

4 Set the operation mode selector to AMP and then press SET MENU to enter "SET MENU".
The top "SET MENU" display appears in the OSD.

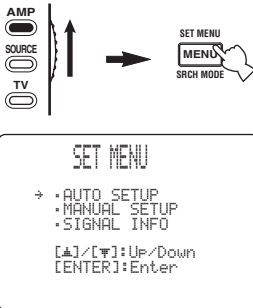

5 Press ENTER to enter "AUTO SETUP".
The "AUTO:MENU" display appears in the OSD.

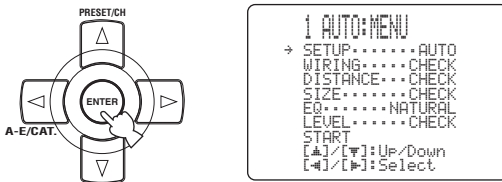

6 Press </> to select "SETUP".

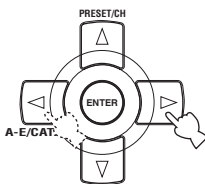

Choices: **AUTO**, RELOAD

- Select "AUTO" to automatically run the entire "AUTO SETUP" procedure.
- Select "RELOAD" to reload the last "AUTO SETUP" settings and override the previous settings. When you select "RELOAD", the previous auto setup result appears in the OSD. See step 7 on page 34 and carry out the operations.

Note

"RELOAD" is available only when you have previously run "AUTO SETUP" and confirmed the results.

7 Press ▲/▼ repeatedly to select "WIRING", "DISTANCE", "SIZE", "EQ", or "LEVEL".

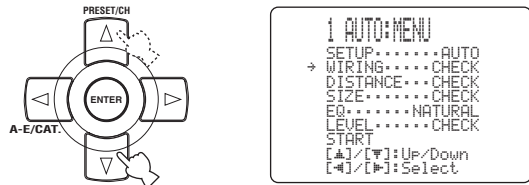

This unit performs the following checks:

Speaker wiring WIRING

Checks which speakers are connected and the polarity of each speaker.

Speaker distance DISTANCE

Checks the distance of each speaker from the listening position and adjusts the timing of each channel.

Speaker size SIZE

Checks the frequency response of each speaker and sets the appropriate low-frequency crossover for each channel.

Choices: **CHECK**, SKIP

- Select "CHECK" to automatically check and adjust the item.
- Select "SKIP" to skip the item and perform no adjustments.

Parametric equalizer level EQ

Adjusts the frequency and the parametric equalizer level of each channel to reduce coloration across the channels and create a cohesive sound field. This is particularly important if you use different brands or sizes of speakers for some channels or have a room with unique sonic characteristics. In addition, the frequency response of each channel is adjusted in accordance with the sound output from your front speakers.

Choices: **NATURAL**, FLAT, FRONT, SKIP

- Select "NATURAL" to average out the frequency response of all speakers with higher frequencies being less emphasized. Recommended if the FLAT setting sounds a little harsh.
- Select "FLAT" to average the frequency response of all speakers. Recommended if all of your speakers are of similar quality.
- Select "FRONT" to adjust the frequency response of each speaker in accordance with the sound of your front speakers. Recommended if your front speakers are of much higher quality than your other speakers.
- Select "SKIP" to skip the selected item and perform no adjustments.

Volume level LEVEL

Checks and adjusts the volume level of each speaker.

Choices: **CHECK, SKIP**

- Select “CHECK” to automatically check and adjust this item.
- Select “SKIP” to skip this item and perform no adjustments.

8 Press ▾ to select “START” and then press ENTER to start the setup procedure.

This unit starts the auto setup procedure. Loud test tones are output from each speaker during the auto setup procedure. Once all items are set, the “RESULT:EXIT” display appears in the OSD.

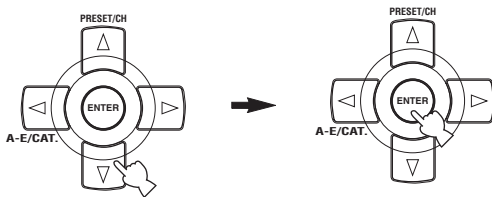

Notes

- During the auto setup procedure, do not perform any operation on this unit.
- We recommend getting out of the room while this unit is in the auto setup procedure. It takes approximately 3 minutes for this unit to complete the auto setup procedure.

The display changes as follows.

```

1 AUTO:MENU
  SETUP.....AUTO
  WIRING.....CHECK
  DISTANCE...CHECK
  SIZE.....CHECK
  EQ.....NATURAL
  LEVEL.....CHECK
  → START
  [▲]/[▼]: Up/Down
  [←]/[→]: Adjust
    
```



```

2 AUTO:CHECK
  → INITIALIZING
  → PRE CHECK
  → MAIN CHECK
  → EQUALIZING
  → LEVEL
  → CHECK CH=CENTER
  [▲]: Exit
    
```



```

RESULT:EXIT
  → RESULT
  SP : 5/4/0.1
  DIST: 14.0/ 17.0ft
  LUL : -9.0/ +6.5dB
  →SET CANCEL
  [▲]/[▼]: Up/Down
  [ENTER]: Enter
    
```

The results displayed under “RESULT” are as follows.

Number of speakers SP

Displays the number of speakers connected to this unit in the following order:
Front/Back/Subwoofer

Speaker distance DIST

Displays the speaker distance from the listening position in the following order:
Closest speaker distance/Farthest speaker distance

Speaker level LUL

Displays the speaker output level in the following order:
Lowest speaker output level/Highest speaker output level

Notes

- If “E-10:INTERNAL ERROR” appears during the testing procedure, restart from step 4.
- If you selected “RELOAD” in step 4, no test tones are output.
- If an error occurs during the “AUTO:CHECK” procedure, the setup procedure is canceled and an error screen appears. For details, see “If an error screen appears” on page 36.
- When this unit detects potential problems during the “AUTO SETUP” procedure, “WARNING” and the number of warning messages appears in the above of “RESULT” (see page 37).
- Depending on the listening environment, “SWFR PHASE:REV” appears during the “AUTO:CHECK” procedure and “SUBWOOFER PHASE” in “SOUND MENU” (see page 89) is automatically set to “REVERSE”.

9 Press ENTER to display the setup results in detail.

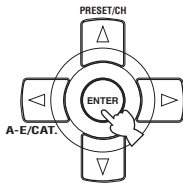

```

RESULT:EXIT
→ RESULT
  SP : 5/4/0.1
  DIST: 14.0/ 17.0ft
  LVL : -9.0/ +6.5dB
▶SET CANCEL
[▲]/[▼]:Up/Down
[ENTER]:Enter
    
```



```

RESULT:WIRING
FRONT L.....OK
[▲]/[▼]:Select
[ENTER]:Return
    
```

10 Press ◀/▶ repeatedly to toggle between the setup result displays.

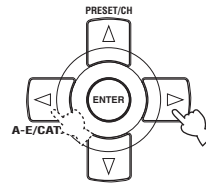

```

RESULT:WIRING
FRONT L.....OK
[▲]/[▼]:Select
[ENTER]:Return
    
```

Results of the speaker connection and wiring

```

RESULT:DISTANCE1
FRONT L..14.0ft
CENTER..17.0ft
FRONT R..15.0ft
PRNS L..17.0ft
PRNS R..17.0ft
[▲]/[▼]:Select
[ENTER]:Return
    
```

Results of the speaker distance from the listening position

```

RESULT:SIZE
FRONT L.....LRG
[▲]/[▼]:Select
[ENTER]:Return
    
```

Results of the frequency response of each speaker

```

RESULT:EQ
CENTER 1:100Hz...+2.5dB
4:300Hz...-0.5dB
4:1.0kHz...+0.5dB
4:1.0kHz...+2.0dB
5:1.0kHz...-3.5dB
6:2.0kHz...+2.5dB
7:10kHz...+2.5dB
[▲]/[▼]:Select
[ENTER]:Return
    
```

Results of the parametric equalizer of each speaker

```

RESULT:LEVEL1
FRONT L...+1.0dB
CENTER...-1.5dB
FRONT R...+6.5dB
PRNS L...-9.0dB
PRNS R...+1.0dB
[▲]/[▼]:Select
[ENTER]:Return
    
```

Results of the speaker output level



If you are not satisfied with the results or want to manually adjust each parameter, run “MANUAL SETUP” (see page 84).

Notes

- If you change speakers, speaker positions, or the layout of your listening environment, run “AUTO SETUP” again to recalibrate your system.
- The distances displayed in the “DISTANCE” results may be longer than the actual distance depending on the characteristics of your subwoofer.
- In the “EQ” results, different values may be set for the same band to provide finer adjustments.

11 Press ENTER to return to the top “RESULT:EXIT” display.

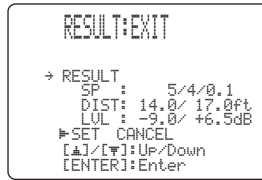
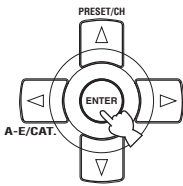

12 Make sure the pointer is pointing at “SET” and “CANCEL” and then press </> to select “SET” or “CANCEL”.

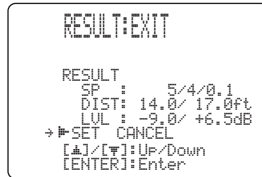
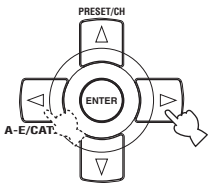

Choices: **SET**, CANCEL

- Select “SET” to confirm the “AUTO SETUP” results.
- Select “CANCEL” to cancel the “AUTO SETUP” results.

13 Press ENTER to confirm your selection.

The top “SET MENU” display appears in the OSD.

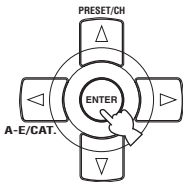

14 Press SET MENU to exit from “SET MENU”.



Notes

- After you have completed the “AUTO SETUP” procedure, be sure to disconnect the optimizer microphone.
- The optimizer microphone is sensitive to heat. Keep it away from direct sunlight and do not place it on top of this unit.

■ If an error screen appears

Press $\Delta/\nabla/\leftarrow/\rightarrow$ to select “RETRY” or “EXIT” and then press ENTER.

The following display is an example where “E-9:USER CANCEL” appears in the OSD.

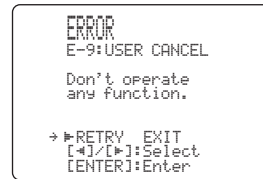

Choices: **RETRY**, EXIT

- Select “RETRY” to retry the “AUTO SETUP” procedure.
- Select “EXIT” to exit from the “AUTO SETUP” procedure.

■ If “WARNING” appears

When this unit detects potential problems during the “AUTO SETUP” procedure, “WARNING” appears in the “RESULT:EXIT” display. Check the warning messages to correct your speaker settings.

Note

Warnings differ from errors in that warnings do not cancel the “AUTO SETUP” procedure.

1 Make sure the pointer is pointing at “WARNING” and then press ENTER to display the detailed information about the warning.

The number on the right of “WARNING” indicates the number of warning messages.

```

RESULT:EXIT
→ WARNING (3)
RESULT
SP : 5/4/0.1
DIST: 14.0/ 17.0ft
LVL : -9.0/ +6.5dB
→SET CANCEL
[▲]/[▼]:Up/Down
[ENTER]:Enter
    
```

2 Press </> repeatedly to toggle between the warning displays.

```

WARNING: W-1
< OUT OF PHASE >
Reverse Channel
FL ---
CENTER
PL PR
SL CR
SBL CBR
[▲]/[▼] : Select
[ENTER] : Enter
    
```



- For details about each warning message, see the “AUTO SETUP” section in “TROUBLESHOOTING” on page 128.
- When the corresponding warning message is not applicable to a speaker, “--” is displayed instead.

3 Press ENTER to return to the top “RESULT:EXIT” display.

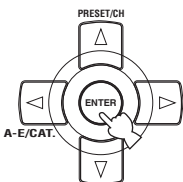

```

RESULT:EXIT
WARNING (3)
RESULT
SP : 5/4/0.1
DIST: 14.0/ 17.0ft
LVL : -9.0/ +6.5dB
→SET CANCEL
[▲]/[▼]:Up/Down
[ENTER]:Enter
    
```

PLAYBACK

CAUTION

Extreme caution should be exercised when you play back CDs encoded in DTS. If you play back a CD encoded in DTS on a DTS-incompatible CD player, you will only hear some unwanted noise that may damage your speakers. Check whether your CD player supports CDs encoded in DTS. Also, check the sound output level of your CD player before you play back a CD encoded in DTS.



To play DTS-encoded CDs when using a digital audio connection, set "DECODER MODE" in "INPUT MENU" to "DTS" before the playback (see page 96).

Basic procedure

(U.S.A. model)

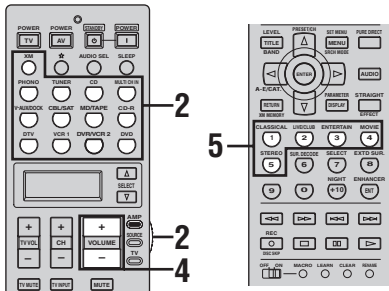
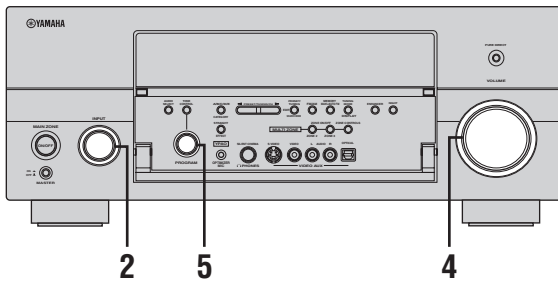

(U.S.A. model)

- 2 Rotate the INPUT selector on the front panel (or set the operation mode selector to AMP and then press one of the input selector buttons on the remote control) to select the desired input source.

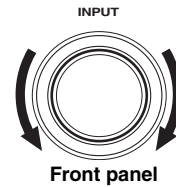

or

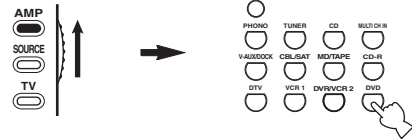

Remote control

The name of the currently selected input source appears in the front panel display and in the OSD for a few seconds.

Available input sources

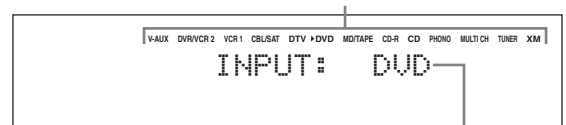

Currently selected input source

- 1 Turn on the video monitor connected to this unit.



- See page 42 to display the input source information.
- You can display a gray background in the OSD when there is no video signal being input by setting "GRAY BACK" in "OPTION MENU" to "AUTO" (see page 97).
- You can change the display settings by using "SHORT MESSAGE" parameter in "DISPLAY SET". See pages 98 for details.

Note

For details about controlling XM Satellite Radio when "XM" is selected as the input source, see page 65.

3 Start playback on the selected source component or select a broadcast station.

- Refer to the operating instructions for the source component.
- See page 54 for details about tuning instructions.
- See page 65 for details about XM Satellite Radio tuning instructions.

4 Rotate VOLUME on the front panel (or press VOLUME +/- on the remote control) to adjust the volume to the desired output level.

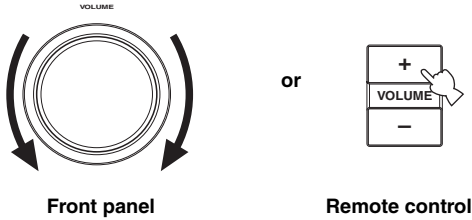

See page 51 to adjust the level of each speaker.

5 Rotate the PROGRAM selector on the front panel (or press one of the sound field program selector buttons on the remote control repeatedly) to select the desired sound field program.

The name of the selected sound field program appears in the front panel display and in the OSD. See page 45 for details about sound field programs.

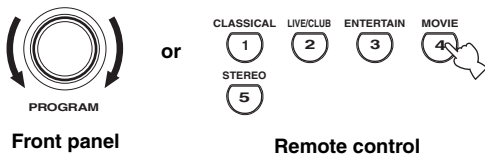

Currently selected sound field program category

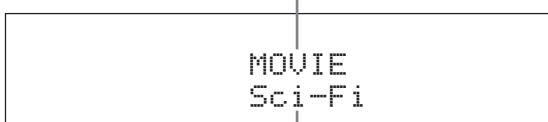

Currently selected sound field program

Note

Sound field programs and the Compressed Music Enhancer mode cannot be selected when the component connected to the MULTI CH INPUT jacks is selected as the input source (see page 41) and Audio input jack select is set to "ANALOG" (see page 40).



- Choose a sound field program based on your listening preference, not merely on the name of the program.
- When you select an input source, this unit automatically selects the last sound field program used with the corresponding input source.
- To display information about the currently selected input source in the OSD, see page 76 for details.

■ Guide to contents

When you want to...	See page
Enjoy pure hi-fi stereo sound	50
Adjust the tonal quality of the front speakers	50
Enjoy the compressed music sources in enhanced sound	52
Edit parameters of sound field programs	76
Enjoy the sources which have wide dynamic range at night	53
Use headphones	41
Enjoy multi-channel sources in 2-channel stereo	51
Select a decoder to play back sources with	80
Set this unit to the standby mode automatically	43

Selecting audio input jacks (AUDIO SELECT)

This unit comes with a variety of input jacks. Use this feature (Audio input jack select) to switch the input jack assigned to an input source when more than one jacks are assigned to an input source.



- We recommend setting Audio input jack select to “AUTO” in most cases.
- You can adjust the default Audio input jack select of this unit by using “AUDIO SELECT” in “OPTION MENU” (see page 99).

- 1 Rotate the **INPUT** selector on the front panel (or press one of the input selector buttons on the remote control) to select the desired input source.

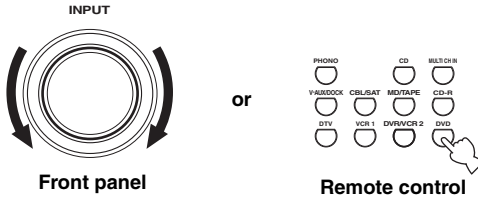

- 2 Press **AUDIO SELECT** on the front panel (or **AUDIO SEL** on the remote control) repeatedly to select the desired Audio input jack select setting.

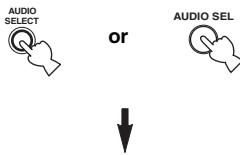

Available input sources

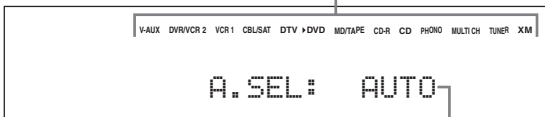

Currently selected
Audio input jack
select setting

AUTO	Automatically selects input signals in the following order: (1) HDMI (2) Digital signals (3) Analog signals
HDMI	Selects only HDMI signals. When HDMI signals are not input, no sound is output.
COAX/OPT	Automatically selects input signals in the following order: (1) Digital signals input at the COAXIAL jack. (2) Digital signals input at the OPTICAL jack. When no signals are input, no sound is output.
ANALOG	Selects only analog signals. If no analog signals are input, no sound is output.

Note

This feature is not available when no digital input jack (OPTICAL, COAXIAL and HDMI) are assigned. In addition, HDMI is not available as an Audio input jack select setting when the HDMI IN 1 and HDMI IN 2 jacks are not used. Use “I/O ASSIGNMENT” in “INPUT MENU” to reassign the respective input jack (see page 94).

Selecting the MULTI CH INPUT component

Use this feature to select the component connected to the MULTI CH INPUT jacks (see page 26) as the input source.

Rotate the input selector on the front panel to select MULTI CH INPUT (or MULTI CH IN on the remote control).

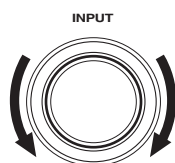

Front panel

or



Remote control



Use “MULTI CH SET” menu in “INPUT MENU” to set the parameters for MULTI CH INPUT (see page 96).

Note

Sound field programs and the Compressed Music Enhancer mode cannot be selected when the component connected to the MULTI CH INPUT jacks is selected as the input source and Audio input jack select is set to “ANALOG” (see page 40).

Using your headphones

Connect a pair of headphones with a stereo analog audio cable plug to the PHONES jack on the front panel.

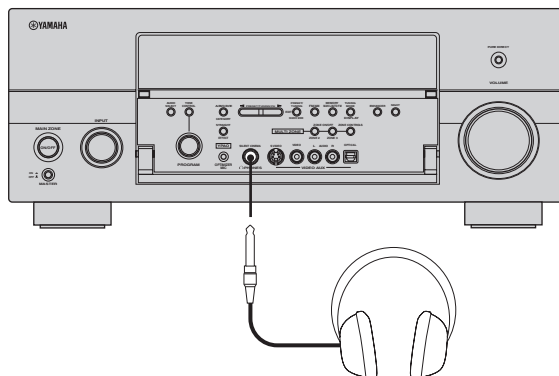

When you select a sound field program, SILENT CINEMA mode activates automatically (see page 49)

Notes

- When you connect headphones, no signals are output at the speaker terminals.
- When the component connected to the MULTI CH INPUT jacks of this unit is selected as the input source and Audio input jack select is set to “ANALOG” (see page 40), only the signals input at FRONT jacks are output from the connected headphones.
- All Dolby Digital and DTS audio signals are mixed down to the left and right headphone channels.

Muting the audio output

Press MUTE on the remote control to mute the audio output. Press MUTE again to resume the audio output.



- You can also rotate VOLUME on the front panel or press VOLUME +/- on the remote control to resume the audio output.
- You can adjust the muting level by using the “MUTE TYPE” parameter in “SOUND MENU” (see page 93).
- The MUTE indicator flashes in the front panel display when the audio output is muted and disappears from the front panel display when the audio output is resumed.

Displaying the input source information

You can display the format, sampling frequency, channel, bit rate and flag data of the current input signal.

1 Set the operation mode selector to AMP and then press SET MENU on the remote control.

The top "SET MENU" display appears in the OSD.

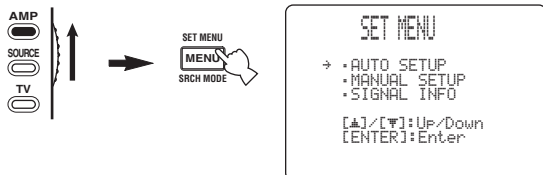

2 Press ▽ repeatedly to select "SIGNAL INFO" and then press ENTER.

The audio information about the input source appears in the OSD.

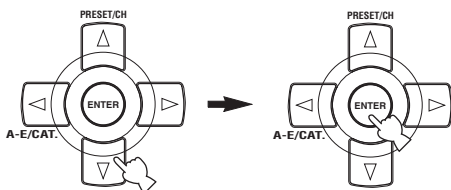

3 Press ▲ / ▽ repeatedly to navigate the cursor in the OSD and press ◀ / ▶ to toggle between the audio and video information displays.

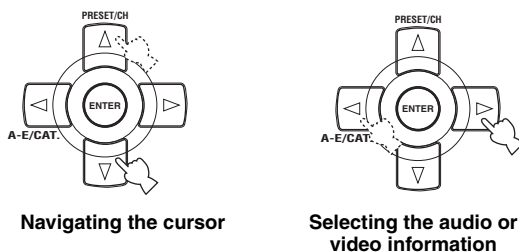

4 Press SET MENU on the remote control again to exit from "SET MENU".



Audio information

Signal format FORMAT

Signal format. When this unit cannot detect a digital signal, it automatically switches to analog input.

Note

"---" appears when this unit cannot detect any signals.

Sampling frequency SAMPLING

The number of samples per second taken from a continuous signal to make a discrete signal.

Note

"---" appears when this unit cannot detect the sampling frequency.

Channel CHANNEL

The number of source channels in the input signal (front/surround/LFE). For example, a multi-channel soundtrack with 3 front channels, 2 surround channels and LFE, is displayed as "3/2/0.1".

Note

"---" appears when there is no source channel available.

Bit rate BITRATE

The number of bits passing a given point per second.

Note

"---" appears when this unit cannot detect the bit rate.

Dialogue normalization level DIALOG

The dialogue normalization level preset to the current input Dolby Digital and DTS signal.

Flag FLAG

Flag data encoded in DTS, Dolby Digital, or PCM signals that cue this unit to automatically switch decoders.

Video information

HDMI Signal Type HDMI SIGNAL

Type of the HDMI signals input or output at the HDMI IN/OUT jacks of this unit.

HDMI Resolution HDMI RES.

Resolution of the HDMI signals input or output at the HDMI IN/OUT jacks of this unit.

Analog Resolution ANALOG RES.

Resolution of the analog signals input or output at the video jacks of this unit.

HDMI Error HDMI ERROR

Error message for HDMI sources or connected HDMI devices. See page 127 for details.

Playing video sources in the background of an audio source

You can combine a video image from a video source with sound from an audio source. For example, you can enjoy listening to classical music while viewing beautiful scenery from the video source on the video monitor.

Press the input selector buttons on the remote control to select a video source and then an audio source.

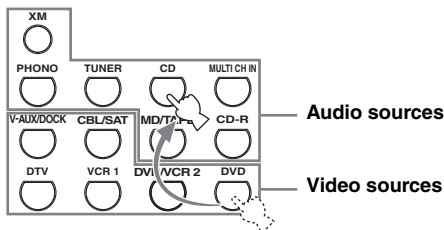

Set the "BGV" parameter in the "MULTI CH SET" menu to the desired setting to select the default background video input source of the MULTI CH INPUT sources (see page 96).

Using the sleep timer

Use this feature to automatically set the main zone to the standby mode after a certain amount of time. The sleep timer is useful when you are going to sleep while this unit is playing or recording a source. The sleep timer also automatically turns off any external components connected to the AC OUTLET(S) (see page 29).

1 Press one of the input selector buttons on the remote control to select the desired input source.

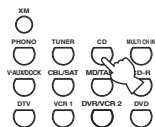

2 Start playback on the selected source component or select a broadcast station.

Refer to the operating instructions for the source component.

See page 54 for details about tuning instructions.

3 Press SLEEP on the remote control repeatedly to set the amount of time.

Each time you press SLEEP, the front panel display changes as shown below.

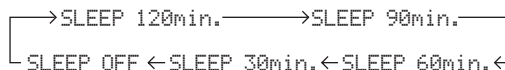

The SLEEP indicator flashes while you are switching the amount of time for the sleep timer. Once the sleep timer is set, the SLEEP indicator lights up in the front panel display, and the display returns to the selected sound field program.

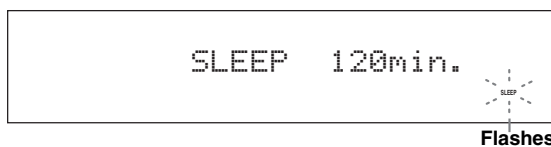

Flashes

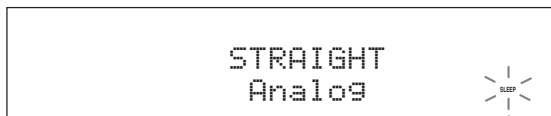

Lights up

Canceling the sleep timer

Press SLEEP on the remote control repeatedly until "SLEEP OFF" appears in the front panel display.

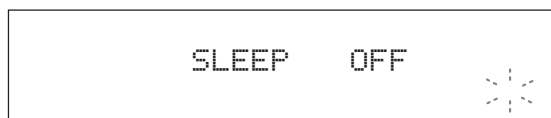

Disappears

The SLEEP indicator turns off, and "SLEEP OFF" disappears from the front panel display after a few seconds.



The sleep timer setting can also be canceled by pressing STANDBY on the remote control (or MAIN ZONE ON/OFF on the front panel) to set the main zone to the standby mode.

SOUND FIELD PROGRAMS

This unit is equipped with a variety of precise digital decoders that allow you to enjoy multi-channel playback from almost any stereo or multi-channel sound source. This unit is also equipped with a YAMAHA digital sound field processing (DSP) chip containing several sound field programs which you can use to enhance your playback experience.



- When you set the “DECODER MODE” parameter in “INPUT MENU” to “AUTO”, this unit selects the appropriate digital decoder according to the input signal.
- The YAMAHA CINEMA DSP modes are compatible with all Dolby Digital, DTS, and Dolby Surround sources.
- The YAMAHA HiFi DSP sound field programs recreate real-world acoustic environments made from precise measurements taken in actual concert halls, music venues, movie theaters, etc. Thus, you may notice variations in the strength of the reflections coming from the front, back, left and right.
- You can change sound field parameters. See page 76 for details.

Selecting sound field programs

Notes

- When you select an input source, this unit automatically selects the last sound field program used with the corresponding input source.
- Sound field programs cannot be selected when the component connected to the MULTI CH INPUT jacks is selected as the input source (see page 41) and Audio input jack select is set to “ANALOG” (see page 40).
- When you play back DSD sources with any sound field program, this unit converts the DSD signals to PCM signals and then applies the selected program.
- When you play back DTS 96/24 sources with any sound field program, this unit applies the selected program without activating the DTS 96/24 decoder.
- Sampling frequencies higher than 48 kHz are sampled down to 48 kHz or lower and then sound field programs are applied.

■ Front panel operations

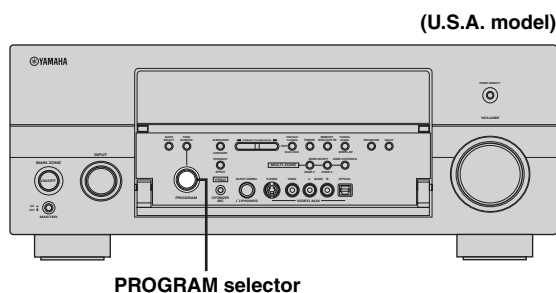

Rotate the PROGRAM selector on the front panel.

The name of the selected sound field program appears in the front panel display and in the OSD.

■ Remote control operations

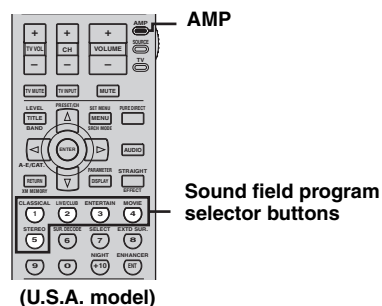

Set the operation mode selector to AMP and then press one of the sound field program selector buttons on the remote control repeatedly.

The name of the selected sound field program appears in the front panel display and in the OSD.

Sound field program descriptions



Select a sound field program based on your listening preference, not merely on the name of the program, etc.

Remote control button	Category of the program	Name of the program	Created sound fields (see page 11)	CINEMA DSP or HiFi DSP
	MOVIE	Sci-Fi		
This program clearly reproduces dialog and sound effects in the latest sound form for science fiction films, thus creating a broad and expansive cinematic space amid silence. You can enjoy science fiction films in a virtual-space sound field that includes Dolby Surround, Dolby Digital and DTS-encoded software employing the most advanced techniques.				
DSP LEVEL P.INIT. DLY	P.ROOM SIZE S.INIT. DLY	S. ROOM SIZE SB INI. DLY	SB ROOM SIZE DIALG. LIFT	

Available sound field parameters (see page 77) Program description

■ For music audio sources





For audio music sources, we also recommend using the Pure Direct mode (see page 50), the “STRAIGHT” mode (see page 49) or surround decode mode (see page 80).

	CLASSICAL	Hall in Munich		HiFi DSP
This is a large fan-shaped concert hall which has approximately 2500 seats. Almost the whole interior is made of wood. There is relatively little reflection from the walls, and sound spreads finely and beautifully.				
DSP LEVEL INIT. DLY	ROOM SIZE LIVENESS	DIALG.LIFT		
	CLASSICAL	Hall in Vienna		HiFi DSP
A classic shoe-box type concert hall with approximately 1700 seats. Pillars and ornate carvings create extremely complex reflections which produce a very full, rich sound.				
DSP LEVEL INIT. DLY	ROOM SIZE LIVENESS	DIALG.LIFT		
	CLASSICAL	Hall in Amsterdam		HiFi DSP
This is a large 2200 seat shoe-box type concert hall in Amsterdam. It has a circular stage with seats located behind the stage.				
DSP LEVEL INIT. DLY	ROOM SIZE LIVENESS	DIALG.LIFT		
	CLASSICAL	Church in Freiburg		HiFi DSP
This program creates the acoustic environment of a big church located in south Germany. The reverberation delay is very long while the early reflections are smaller than with other sound field programs.				
DSP LEVEL INIT. DLY	LIVENESS REV.TIME	REV.DELAY REV. LEVEL	DIALG.LIFT	

SOUND FIELD PROGRAMS

CLASSICAL 1	CLASSICAL	Chamber		HiFi DSP
This program creates a relatively wide space with a high ceiling like an audience hall in a palace. It offers pleasant reverberations that are suitable for courtly music and chamber music.				
DSP LEVEL INIT. DLY	LIVENESS REV.TIME	REV.DELAY REV. LEVEL	DIALG.LIFT	

LIVE/CLUB 2	LIVE/CLUB	Village Vanguard		HiFi DSP
A traditional jazz club in New York, located on 7th Avenue. This room has a low ceiling, and the “stage” is located at the corner of the room. This program creates an intimate “close-to-the music” feel.				
DSP LEVEL INIT. DLY	ROOM SIZE LIVENESS	DIALG.LIFT		

LIVE/CLUB 2	LIVE/CLUB	Warehouse Loft		HiFi DSP
This program simulates a space enclosed by concrete. An energetic sound field is created with relatively clear reflections from the walls.				
DSP LEVEL INIT. DLY	ROOM SIZE LIVENESS	REV.TIME REV.DELAY	REV. LEVEL DIALG.LIFT	

LIVE/CLUB 2	LIVE/CLUB	Cellar Club		HiFi DSP
This program simulates a live house with a low ceiling and homey atmosphere. A realistic, live sound field features powerful sound as if the listener is in a row in front of a small stage.				
DSP LEVEL INIT. DLY	ROOM SIZE LIVENESS	DIALG.LIFT		



LIVE/CLUB 2	LIVE/CLUB	The Roxy Theatre		HiFi DSP
The ideal program for lively, dynamic rock music. The data for this program was recorded at LA’s hottest rock club. The listener’s virtual seat is at the center-left of the hall.				
DSP LEVEL INIT. DLY	ROOM SIZE LIVENESS	REV.TIME REV.DELAY	REV. LEVEL DIALG.LIFT	



LIVE/CLUB 2	LIVE/CLUB	The Bottom Line		HiFi DSP
This is the sound field at stage front in The Bottom Line, a famous New York jazz club. The floor can seat 300 people to the left and right in a sound field offering real and vibrant sound.				
DSP LEVEL INIT. DLY	ROOM SIZE LIVENESS	DIALG.LIFT		

■ For various sources
Note

The available sound field parameters and the created sound fields differ depending on the input sources and the settings of this unit.

ENTERTAIN 3	ENTERTAINMENT	Sports		CINEMA DSP
This program allows the listeners to enjoy stereo sport broadcasts and studio variety programs with enriched live feeling. In sports broadcasts, the voices of the commentator and sportscaster are positioned clearly on the center while the atmosphere of the stadium expands in an optimum space to offer the listeners with a feeling of presence in the stadium.				
DSP LEVEL P. INIT. DLY	P. ROOM SIZE S. INIT. DLY	S. ROOM SIZE SB INI. DLY	SB ROOM SIZE DIALG.LIFT	



	ENTERTAINMENT	Action Game		
This sound field has been optimized for action games such as car racing and FPS games. It uses the reflection data that limits the effects range per channel in order to offer a powerful playing environment with a being-there feeling by enhancing various effects tones while maintaining a clear sense of directions.				
DSP LEVEL P. INIT. DLY	P. ROOM SIZE S. INIT. DLY	S. ROOM SIZE SB INI. DLY	SB ROOM SIZE DIALG.LIFT	



	ENTERTAINMENT	Roleplaying Game		
This sound field has been optimized for role-playing and adventure games. It combines the sound field effects for movies and the sound field design used with "Action Game" to represent the depth and 3D feeling of the field during play, while offering movie-like surround effects in the movie scenes in the game.				
DSP LEVEL P. INIT. DLY	P. ROOM SIZE S. INIT. DLY	S. ROOM SIZE SB INI. DLY	SB ROOM SIZE DIALG.LIFT	

■ For visual sources of music

Note

The available sound field parameters and the created sound fields differ depending on the input sources and the settings of this unit.

	ENTERTAINMENT	Music Video		
This sound field offers an image of a concert hall for live performance of pop, rock and jazz music. The listener can indulge oneself in a hot live space thanks to the presence sound field that emphasizes the vividness of vocals and solo play and the beat of rhythm instruments, and to the surround sound field that reproduces the space of a big live hall.				
DSP LEVEL P. INIT. DLY	P. ROOM SIZE S. INIT. DLY	S. ROOM SIZE SB INI. DLY	SB ROOM SIZE DIALG.LIFT	

	ENTERTAINMENT	Recital/Opera		
This program controls the amount of reverberations at an optimum level and emphasizes the depth and clarity of human voices. "Opera" offers the reverberations of an orchestra box in front of the listener at the same time as providing the acoustic positioning and feeling of presence on the stage. The surround sound field is relatively moderate, but the data for concert hall effects are used to represent the inherent beauty of music. The listener will not be fatigued even after long hours of opera entertainment.				
DSP LEVEL P. INIT. DLY	P. ROOM SIZE S. INIT. DLY	S. ROOM SIZE SB INI. DLY	SB ROOM SIZE DIALG.LIFT	



■ For movie sources





You can select the desired decoder used with following sound field program (except "Mono Movie"). See page 82 for details.



Note



The available sound field parameters and the created sound fields differ depending on the input sources and the settings of this unit.



	MOVIE	Standard		
This program create a sound field emphasizing the surrounding feeling without disturbing the original acoustic positioning of multi-channel audio such as Dolby Digital and DTS. It has been designed with the concept of "an ideal movie theater", in which the audience is surrounded by beautiful reverberations from the left, right and rear.				
DSP LEVEL S. INIT. DLY	S. ROOM SIZE S. LIVENESS	SB INI. DLY SB ROOM SIZE	SB LIVENESS DIALG.LIFT	



SOUND FIELD PROGRAMS

	MOVIE	Spectacle		
<p>This program creates the extremely wide sound field of a 70-mm movie theater. It precisely reproduces the source sound in detail, making both the video and the sound field incredibly real. This is ideal for any kind of video source encoded with Dolby Surround, Dolby Digital or DTS (especially large-scale movie productions).</p>				
DSP LEVEL P. INIT. DLY	P. ROOM SIZE S. INIT. DLY	S. ROOM SIZE SB INI. DLY	SB ROOM SIZE DIALG.LIFT	

	MOVIE	Sci-Fi		
<p>This program clearly reproduces dialog and sound effects in the latest sound form for science fiction films, thus creating a broad and expansive cinematic space amid silence. You can enjoy science fiction films in a virtual-space sound field that includes Dolby Surround, Dolby Digital and DTS-encoded software employing the most advanced techniques.</p>				
DSP LEVEL P. INIT. DLY	P. ROOM SIZE S. INIT. DLY	S. ROOM SIZE SB INI. DLY	SB ROOM SIZE DIALG.LIFT	

	MOVIE	Adventure		
<p>This program is ideal for precisely reproducing the sound design of the newest 70-mm and multichannel soundtrack films. The sound field is made to be similar to that of the newest movie theaters, so the reverberations of the sound field itself are restrained as much as possible.</p>				
DSP LEVEL P. INIT. DLY	P. ROOM SIZE S. INIT. DLY	S. ROOM SIZE SB INI. DLY	SB ROOM SIZE DIALG.LIFT	

	MOVIE	Drama		
<p>This sound field features stable reverberations that match a wide range of movie genres from serious dramas to musicals and comedies. The reverberations are modest but offer an optimum 3D feeling, reproducing effects tones and background music softly but cubically around clear words and center positioning in a way that does not fatigue the listener even after long hours of viewing.</p>				
DSP LEVEL P. INIT. DLY	P. ROOM SIZE S. INIT. DLY	S. ROOM SIZE SB INI. DLY	SB ROOM SIZE DIALG.LIFT	

	MOVIE	Mono Movie		
<p>This program is provided for reproducing monaural video sources (such as old movies). The program produces the optimum reverberation to create sound depth using only the presence sound field.</p>				
DSP LEVEL INIT. DLY	ROOM SIZE LIVENESS	REV.TIME REV. LEVEL	REV.DELAY DIALG.LIFT	

■ **Stereo playback**

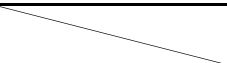
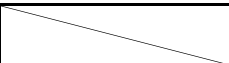
	STEREO	2ch STEREO		
<p>Use this program to mix down multi-channel sources to 2 channels. See page 51 for details.</p>				
DIRECT				

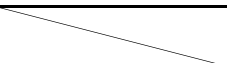
	STEREO	7ch STEREO		HiFi DSP
<p>Use this program to output sound from all speakers. When you play back multi-channel sources, this unit downmixes the source to 2 channels, and then output the sound from all speakers. This program creates a larger sound field and is ideal for background music at parties, etc.</p>				
CT LEVEL SL LEVEL	SR LEVEL SB LEVEL	PL LEVEL PR LEVEL		

■ Using sound field programs without surround speakers (Virtual CINEMA DSP)

Virtual CINEMA DSP allows you to enjoy the CINEMA DSP programs without surround speakers. It creates virtual speakers to reproduce the natural sound field. When you set “SUR. L/R SP” to “NONE” (see page 88), Virtual CINEMA DSP activates automatically whenever you select a CINEMA DSP sound field program (see page 45).

Note

Virtual CINEMA DSP will not activate even when “SUR. L/R SP” is set to “NONE” (see page 88) in the following cases:

- when the component connected to the MULTI CH INPUT jacks is selected as the input source (see page 41).
- when headphones are connected to the PHONES jack.
- when the Pure Direct (see page 50) or “2ch Stereo” mode (see page 51) is selected, or when this unit is in the “STRAIGHT” mode (see page 49).

■ Enjoying multi-channel sources and sound field programs with headphones (SILENT CINEMA)

SILENT CINEMA allows you to enjoy multi-channel music or movie sound, including Dolby Digital and DTS sources, through ordinary headphones. SILENT CINEMA activates automatically whenever you connect headphones to the PHONES jack while listening to CINEMA DSP or HiFi DSP sound field programs (see page 45). When activated, the SILENT CINEMA indicator lights up in the front panel display.

Notes

- SILENT CINEMA does not activate when the component connected to the MULTI CH INPUT jacks is selected as the input source (see page 41).
- SILENT CINEMA is not effective when the Pure Direct (see page 50) or “2ch Stereo” mode (see page 51) is selected, or when this unit is in the “STRAIGHT” mode (see page 49).

Enjoying unprocessed input sources

When this unit is in the “STRAIGHT” mode, 2-channel stereo sources are output from only the front left and right speakers. Multi-channel sources are decoded straight into the appropriate channels without any additional effect processing.

Press **STRAIGHT** on the front panel (or on the remote control) to select “STRAIGHT”.

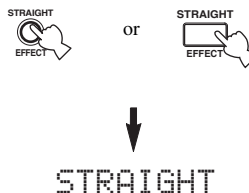

Format	Description
Dolby Digital	Standard processing for Dolby Digital sources.
DTS	Standard processing for DTS sources. When the input source is DTS ES Discrete or DTS ES Matrix format, the respective indicator appears in the front panel display.
DSD	Plays back DSD (Direct Stream Digital) sources.
PCM	Plays back PCM (Pulse Code Modulation) sources.
MPCM	Plays back multi-channel PCM (Pulse Code Modulation) sources.
Analog	Plays back analog sources.

■ Deactivating the “STRAIGHT” mode

Press **STRAIGHT** on the remote control so that “STRAIGHT” disappears from the front panel display.

The sound effect is turned back on.

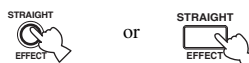

USING AUDIO FEATURES

Enjoying pure hi-fi sound

Use the Pure Direct mode to enjoy the pure fidelity sound of the selected source. When the Pure Direct mode is activated, this unit plays back the selected source with the least circuitry.

Press PURE DIRECT on the front panel (or on the remote control) to turn on or off the Pure Direct mode.

The PURE DIRECT button on the front panel lights up while this unit is in the Pure Direct mode. The front panel display automatically dims.

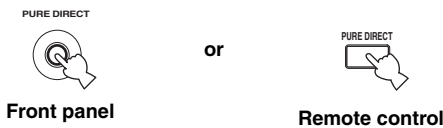

Notes

- When you play back the multi-channel PCM sources (less than 192 kHz), this unit downmixes the multi-channel signals according to the “SPEAKER SET” in “BASIC MENU” (see page 87).
- When the component connected to the HDMI IN jacks is selected as the input source and Audio input jack select is set to “AUTO” or “HDMI”, this unit does not turn off the video circuitry in the Pure Direct mode.
- When you set Audio input jack select to “AUTO”, “HDMI” or “COAX/OPT” (see page 40) and play back the Dolby Digital, DTS or multi channel PCM sources, this unit activates the corresponding decoder.
- The following operations are not possible when this unit is in the Pure Direct mode:
 - switching the sound field program
 - displaying the OSD
 - adjusting the “SET MENU” parameters (except for speaker level settings)
 - operating video functions (video conversion, etc.)
- The Pure Direct mode is automatically canceled whenever this unit is turned off.



The front panel display turns on momentarily when an operation is performed.

Adjusting the tonal quality

Use this feature to adjust the balance of bass and treble for the front L/R, center, presence L/R speaker channels and the subwoofer channel.

- 1 Press TONE CONTROL on the front panel repeatedly to select the high-frequency response (TREBLE) or the low-frequency response (BASS)**



- 2 Rotate the PROGRAM selector to adjust the high-frequency response (TREBLE) or the low-frequency response (BASS).**



■ Bypassing the tone control circuitry

Press TONE CONTROL repeatedly to select BYPASS and cancel the tone control.



Notes

- If you increase or decrease the high-frequency or the low-frequency sound to an extreme level, the tonal quality of the surround speakers may not match that of the front L/R, center, presence L/R speakers and the subwoofer.
- TONE CONTROL is not effective when PURE DIRECT is selected, or when MULTI CH INPUT is selected as the input source.

Adjusting the speaker level

You can adjust the output level of each speaker while listening to a music source. This is also possible when playing sources input at the MULTI CH INPUT jacks.

Note

This operation will override the level adjustments made in "AUTO SETUP" (see page 32) and "SP LEVEL" (see page 90).

- 1 Set the operation mode selector to AMP and then press LEVEL on the remote control repeatedly to select the speaker you want to adjust.



Display	Adjusted speaker
FRONT L	Front left speaker
CENTER	Center speaker
FRONT R	Front right speaker
SUR. R	Surround right speaker
SB L	Surround back right speaker
SB R	Surround back left speaker
SUR. L	Surround left speaker
SWFR	Subwoofer
PRNS L	Presence left speaker
PRNS R	Presence right speaker



- Once you press LEVEL on the remote control, you can also select the speaker by pressing Δ / ∇ .
- Instead of "SB R" and "SB L", "SB" is displayed if "SUR. B L/R SP" is set to either "SMLx1" or "LRGx1" (see page 89).

- 2 Press \triangleleft / \triangleright on the remote control to adjust the speaker output level.

- Press \triangleright to increase the value.
- Press \triangleleft to decrease the value.

Control range: -10 dB to +10 dB

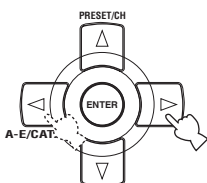

Enjoying multi-channel sources in 2-channel stereo

You can mix down multi-channel sources to 2 channels and enjoy playback in 2-channel stereo.

- 1 Set the operation mode to AMP and then press STEREO on the remote control repeatedly to select "2ch Stereo".

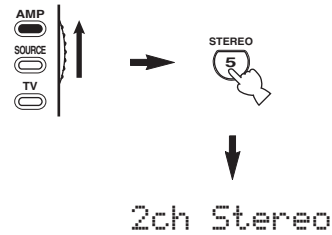

- You can use a subwoofer with this program when "LFE/BASS OUT" is set to "SWFR" or "BOTH" (see page 87).
- You can also select the "2ch Stereo" mode by rotating the PROGRAM selector on the front panel.

- 2 Press PARAMETER and then \triangleleft / \triangleright to set the "DIRECT" parameter.

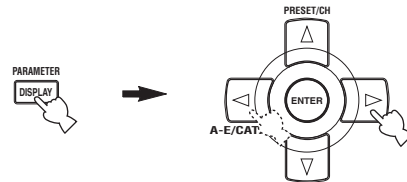

Choices: **AUTO**, OFF

- Select "AUTO" to bypass the decoders, DSP processors and the tone control circuitry only when "BASS" and "TREBLE" are set to 0 dB (see page 50).
- Select "OFF" not to bypass the decoders, DSP processors and the tone control circuitry when "BASS" and "TREBLE" are set to 0 dB.



- When multi-channel signals (Dolby Digital and DTS) are input, they are downmixed to 2 channels and output from the front left and right speakers.
- The low-frequency signals input from the front left and right speakers are redirected to the subwoofer in the following cases:
 - "LFE/BASS OUT" is set to "BOTH" (see page 87).
 - "FRONT SP" is set to "SMALL" (see page 88) and "LFE/BASS OUT" is set to "SWFR" (see page 87).
- Press PARAMETER again to exit from the parameter setting mode.

Selecting the Compressed Music Enhancer mode

Compression artifacts (such as the MP3 format) are created by a lossy compression scheme where the audio is resampled to lower the bit rate and to remove sounds that are indistinguishable to typical human hearing. The Compressed Music Enhancer feature of this unit enhances your listening experience by regenerating the missing harmonics in a compression artifact. As a result, flattened complexity due to the loss of high-frequency fidelity as well as lack of bass due to the loss of low-frequency bass is compensated, providing improved performance of the overall sound system.

Notes

- When you play back DSD sources or PCM sources whose sampling frequencies are higher than 48 kHz, this unit samples them down to 48 kHz or lower and applies the Compressed Music Enhancer mode.
- The Compressed Music Enhancer mode is not effective with any of the sound field programs.

Press ENHANCER on the front panel (or set the operation mode selector to AMP and then press ENHANCER on the remote control) repeatedly to select the desired Compressed Music Enhancer mode.

The following display is shown in the OSD and the ENHANCER indicator lights up in the front panel display.

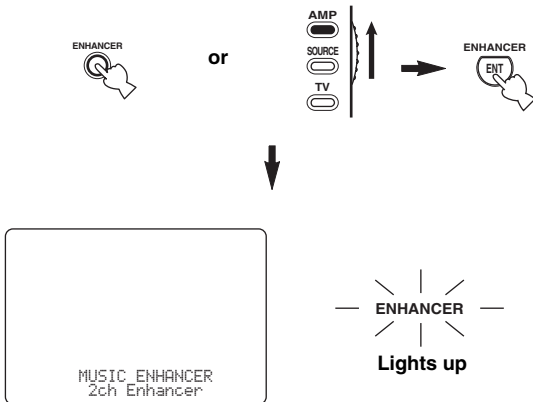

Choices: **2ch Enhancer**, 7ch Enhancer, Off

- Select “2ch Enhancer” to play back compression artifacts in 2-channel stereo.
- Select “7ch Enhancer” to play back compression artifacts in 7-channel stereo.
- Select “Off” to turn off the Compressed Music Enhancer mode.

Note

When you select “Off”, this unit returns to the previously selected sound field program.

Changing the parameter of the Compressed Music Enhancer mode

Press PARAMETER and then </> on the remote control to select the desired effect level. The following display is shown in the OSD.

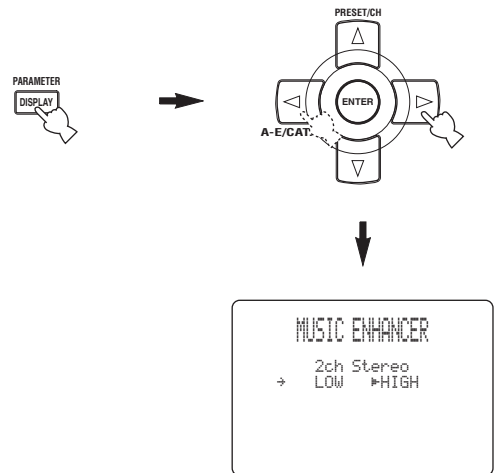

Choices: **HIGH**, LOW

- Select “HIGH” for a high effect level.
- Select “LOW” for a low effect level.



Press PARAMETER to turn off the Compressed Music Enhancer mode parameter display.

Note

Set the effect level to “HIGH” or “LOW” according to the characteristics of a source. The high-frequency signals of some sources may be emphasized too much. In this case, set the effect level to “LOW”.

Selecting the night listening mode

The night listening modes are designed to improve listenability at lower volumes or at night. Choose either “NIGHT:CINEMA” or “NIGHT:MUSIC” depending on the type of material you are playing.

- 1 Press **NIGHT** on the front panel (or set the operation mode selector to **AMP** and then press **NIGHT** on the remote control) repeatedly to select “NIGHT:CINEMA” or “NIGHT:MUSIC”.

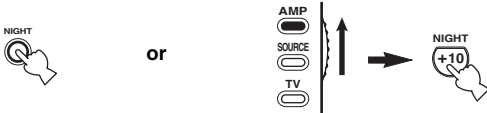

Choices: NIGHT:CINEMA, NIGHT:MUSIC, OFF

- Select “NIGHT:CINEMA” when watching films to reduce the dynamic range of film soundtracks and make dialog easier to hear at lower volumes.
- Select “NIGHT:MUSIC” when listening to music sources to preserve ease-of-listening for all sounds.
- Select “OFF” if you do not want to use this feature.



When a night listening mode is selected, the NIGHT indicator lights up in the front panel display.

- 2 Press **</>** on the remote control to adjust the effect level while “NIGHT:CINEMA” or “NIGHT:MUSIC” is displayed in the front panel display.

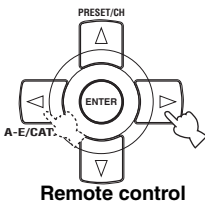

Remote control



Effect.Lvl: MID

Choices: MIN, **MID**, MAX

- Select “MIN” for minimum compression.
- Select “MID” for standard compression.
- Select “MAX” for maximum compression.



“NIGHT:CINEMA” and “NIGHT:MUSIC” adjustments are stored independently.

Notes

- You cannot use the night listening modes in the following cases:
 - when the Pure Direct mode (see page 50) is selected.
 - when the component connected to the MULTI CH INPUT jacks is selected as the input source (see page 41).
 - when headphones are connected to the PHONES jack.
- The night listening modes may vary in effectiveness depending on the input source and surround sound settings you use.

FM/AM TUNING

There are 2 tuning methods: automatic and manual. Automatic tuning is effective when station signals are strong and there is no interference. If the signal from the station you want to select is weak, tune into it manually. You can also use the automatic and manual preset tuning features to store up to 40 stations (A1 to E8: 8 preset station numbers in each of the 5 preset station groups). Furthermore, you can recall any preset stations and exchange the assignment of two preset stations with each other.

Note

Orient the connected FM and AM antennas for the best reception.

FM/AM controls and functions

■ Front panel functions

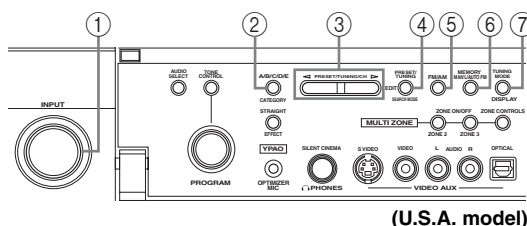

(U.S.A. model)

① INPUT selector

Selects “TUNER” as the input source.

② A/B/C/D/E

Selects one of the 5 preset station groups (A to E) (see page 57).

③ PRESET/TUNING/CH </>

- Selects one of the 8 preset station numbers (1 to 8) when the colon (:) is displayed in the front panel display (see page 57).
- Selects the tuning frequency when the colon (:) is not displayed in the front panel display (see page 56).

④ PRESET/TUNING, EDIT

- Switches the function of PRESET/TUNING/CH </> between selecting preset station numbers and selecting the tuning frequency.
- Edits the assignments of preset stations (see page 58).

⑤ FM/AM

Switches the reception band between FM and AM (see page 55).

⑥ MEMORY

Stores a preset station in the memory. Hold down this button for more than 3 seconds to start automatic preset tuning (see page 57).

⑦ TUNING MODE

Switches between automatic tuning (the AUTO indicator is turned on) and manual tuning (the AUTO indicator is turned off) (see page 55).

■ Remote control functions

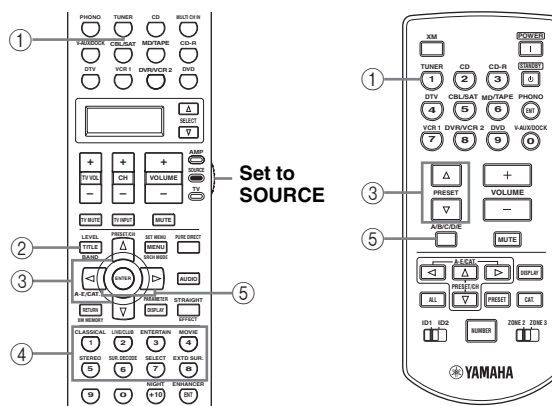

(U.S.A. model)

① TUNER

Selects “TUNER” as the input source. This unit is turned into the last selected station.

② BAND

Switches the reception band between FM and AM (see page 55). This unit is turned into the last selected AM or FM station.

③ PRESET/CH Δ / ∇

Selects one of the 8 preset station numbers (1 to 8) when the colon (:) is displayed in the front panel display (on page 58).

④ Numeric buttons

Use numbers 1 through 8 to select preset stations (see page 59).

⑤ A-E/CAT. </>, A/B/C/D/E

Selects one of the preset station groups (A to E) (see page 57).

Automatic tuning

Automatic tuning is effective when station signals are strong and there is no interference.

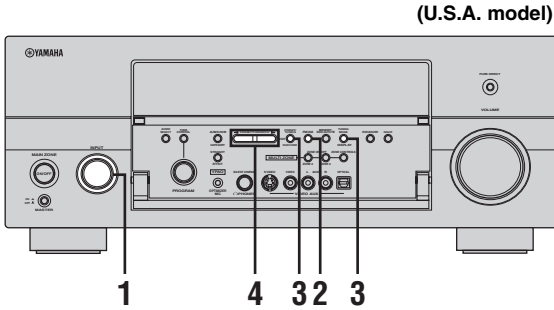

1 Rotate the INPUT selector to select "TUNER" as the input source.

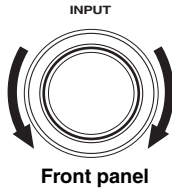

2 Press FM/AM to select the reception band. "FM" or "AM" appears in the front panel display.



3 Press TUNING MODE so that the AUTO indicator lights up in the front panel display.

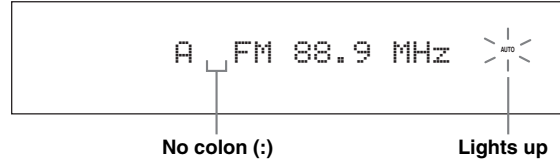

If a colon (:) appears in the front panel display, tuning is not possible. Press PRESET/TUNING to turn the colon (:) off.



4 Press PRESET/TUNING/CH </> once to begin automatic tuning.

When this unit is tuned into a station, the TUNED indicator lights up and the frequency of the received station is shown in the front panel display.

- Press > to tune into a higher frequency.
- Press < to tune into a lower frequency.

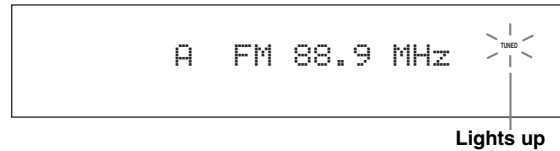

Manual tuning

If the signal received from the station you want to select is weak, tune into it manually.

Note

Manually tuning into an FM station automatically switches the tuner to monaural reception to increase the signal quality.

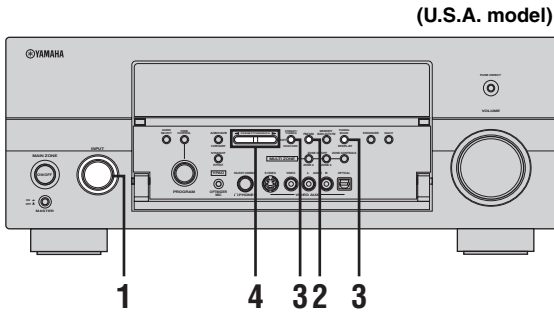

- 1 Rotate the INPUT selector to select “TUNER” as the input source.

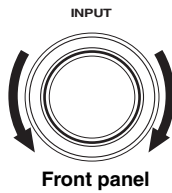

- 2 Press FM/AM to select the reception band. “FM” or “AM” appears in the front panel display.



- 3 Press TUNING MODE so that the AUTO indicator disappears from the front panel display.



No colon (:)

If a colon (:) appears in the front panel display, tuning is not possible. Press PRESET/TUNING (EDIT) to turn the colon (:) off.



- 4 Press PRESET/TUNING/CH </> to tune into the desired station manually.

Hold down the button to continue searching.



Automatic preset tuning

You can use the automatic preset tuning feature to store up to 40 FM stations with strong signals (A1 to E8: 8 preset station numbers in each of the 5 preset station groups) in order. You can then recall any preset station easily by selecting the preset station number.

(U.S.A. model)

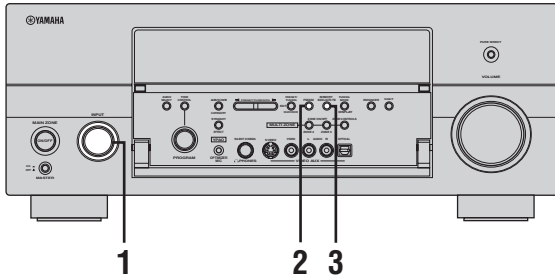

- 1 Rotate the INPUT selector to select “TUNER” as the input source.

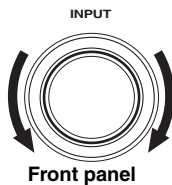

- 2 Press FM/AM to select “FM” as the reception band.

“FM” appears in the front panel display.



- 3 Press and hold MEMORY for more than 3 seconds.

The preset station number as well as the MEMORY and AUTO indicators flashes. After approximately 5 seconds, automatic presetting starts from the current frequency and proceeds toward higher frequencies.

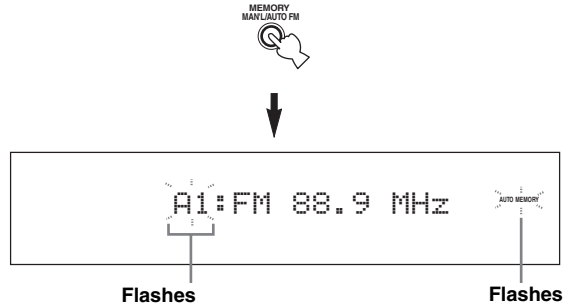

When automatic preset tuning is completed, the front panel display shows the frequency of the last preset station.



- You can specify the preset number from which this unit stores FM stations. Press A/B/C/D/E and then PRESET/TUNING/CH </> repeatedly after you perform step 3 to select the preset station number under which the first station will be stored.
- You can begin tuning toward lower frequencies to store FM stations automatically. Press PRESET/TUNING so that the colon (:) disappears from the front panel display and then press PRESET/TUNING/CH </> after pressing and holding MEMORY for more than 3 seconds.

Notes

- Any stored station data existing under a preset station number is cleared when you store a new station under the same preset station number.
- If the number of received stations does not reach 40 (E8), automatic preset tuning automatically stops after searching for all the available stations.
- Only FM stations with sufficient signal strength are stored automatically by automatic preset tuning. If the station you want to store is weak in signal strength, tune into it manually and store it as described in “Manual preset tuning” on page 58.

Manual preset tuning

You can also store up to 40 stations (A1 to E8: 8 preset station numbers in each of the 5 preset station groups) manually.

(U.S.A. model)

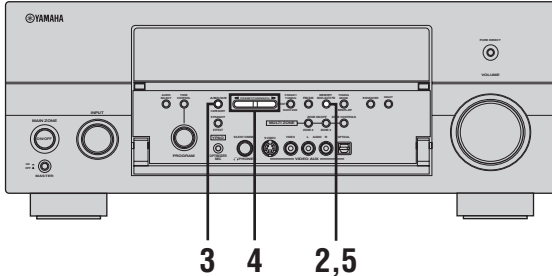

1 Tune into a station automatically or manually.
See pages 55 and 56 for tuning instructions.

2 Press MEMORY.
The MEMORY indicator flashes in the front panel display for approximately 5 seconds.



3 Press A/B/C/D/E repeatedly to select a preset station group (A to E) while the MEMORY indicator is flashing.

The selected preset station group letter appears. Check that the colon (:) appears in the front panel display.

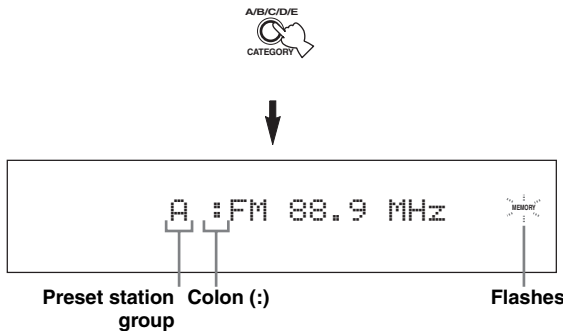

4 Press PRESET/TUNING/CH </> to select a preset station number (1 to 8) while the MEMORY indicator is flashing.

- Press > to select a higher preset station number.
- Press < to select a lower preset station number.

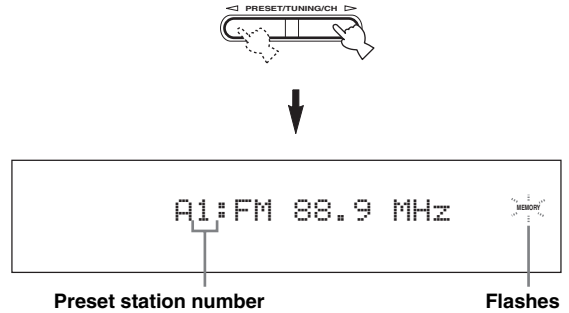

5 Press MEMORY while the MEMORY indicator is flashing.

The station band and frequency appear in the front panel display with the preset station group and number you have selected. The MEMORY indicator disappears from the front panel display.

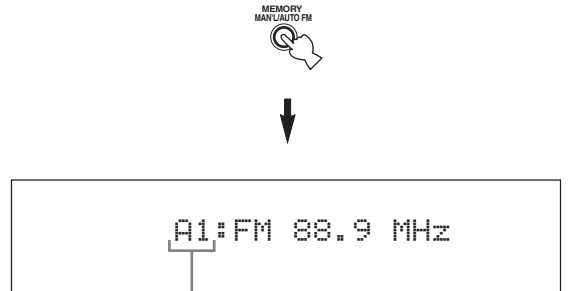

The displayed station has been stored as A1.

Notes

- Any stored station data existing under a preset station number is cleared when you store a new station under the same preset station number.
- The reception mode (stereo or monaural) is stored along with the station frequency.

Selecting preset stations

You can tune into any desired station simply by selecting the preset station group and number under which it was stored.

(U.S.A. model)

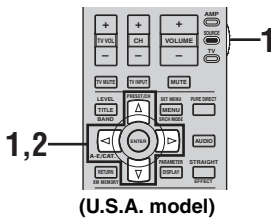
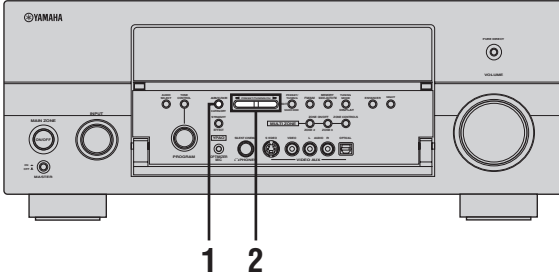

- Press PRESET/TUNING/CH ◀/▶ on the front panel (or PRESET/CH ▲/▼ on the remote control) to select the desired preset station number (1 to 8).

The preset station group and number appear in the front panel display along with the station band and frequency.

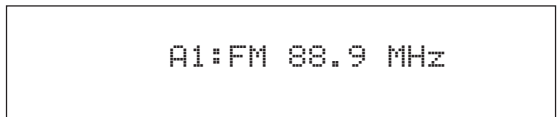
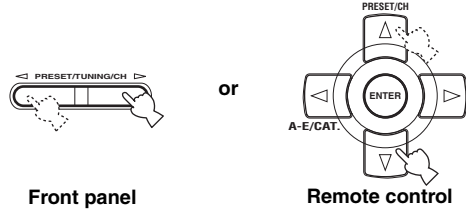

When performing this operation with the remote control, set the operation mode selector to SOURCE and then press TUNER to select "TUNER" as the input source.

- Press A/B/C/D/E on the front panel (or set the operation mode selector to SOURCE and then press A-E/CAT. ◀/▶ on the remote control) to select the desired preset station group (A to E).

The preset station group letter appears in the front panel display and changes each time you press the button.



or

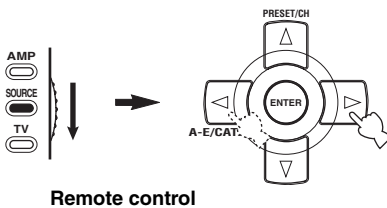

Exchanging preset stations

You can exchange the assignments of two preset stations with each other. The example below describes the procedure to exchange preset station “E1” with “A5”.

(U.S.A. model)

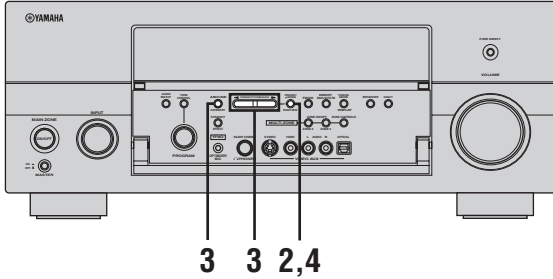

- 1 Select preset station “E1” using A/B/C/D/E and PRESET/TUNING/CH ◀/▶.

See “Selecting preset stations” on page 59.

- 2 Press and hold EDIT for more than 3 seconds.

“E1” and the MEMORY indicator flash in the front panel display.

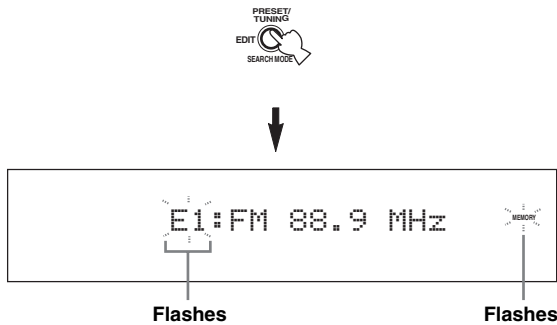

- 3 Select preset station “A5” using A/B/C/D/E and PRESET/TUNING/CH ◀/▶.

“A5” and the MEMORY indicator flash in the front panel display.

See “Selecting preset stations” on page 59.

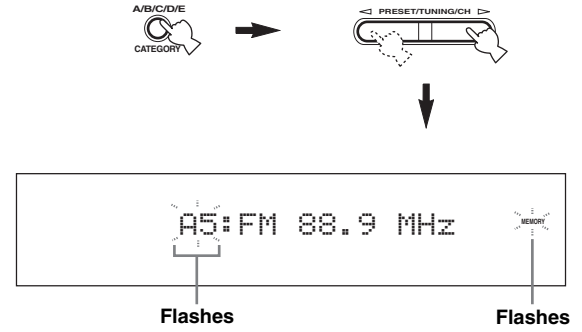

- 4 Press EDIT again.

“EDIT E1–A5” appears in the front panel display and the assignments of the two preset stations are exchanged.



XM SATELLITE RADIO TUNING

XM Satellite Radio is a satellite radio service with millions of listeners across the United States and Canada, broadcasting live daily. The XM Satellite Radio channel lineup includes over 160 digital channels of choice from coast to coast: 67 commercial-free music channels, featuring hip hop to opera, classical to country, bluegrass to blues; 33 channels of premier sports, talk, comedy, children's and entertainment programming; and more than 20 channels of the traffic and weather information for major metropolitan areas nationwide.

Because XM Satellite Radio is a subscription service, you will need to set up an account and activate service with XM using your XM Satellite Radio ID number. To check your ID number, follow "Activating XM Satellite Radio" on page 63. For further information on XM Satellite Radio services, visit the XM Satellite Radio website at "<http://www.xmradio.com/>" (for residents in the United States) or "<http://www.xmradio.ca/>" (for residents in Canada).

This unit is equipped with the Neural Surround decoder (U.S.A. and Canada models only) that plays back the surround sound content of the XM Satellite Radio broadcasts in multi-channels, resulting in a full surround sound experience.

Notes

- The XM Satellite Radio service is only available in the 48 contiguous United States (not available in Alaska and Hawaii) and Canada.
- XM Passport System and monthly subscription are sold separately. For details, visit the XM Satellite Radio website at "<http://www.xmradio.com/>" (for residents in the United States) or "<http://www.xmradio.ca/>" (for residents in Canada).
- For information on obtaining the XM Passport System, visit the XM Satellite Radio website at "<http://www.xmradio.com/>" (for residents in the United States) or "<http://www.xmradio.ca/>" (for residents in Canada), or consult your local retailer that sells XM Ready products.
- To ensure optimal reception of the XM Satellite Radio signals, the XM Passport System must be placed at or near a southerly facing window with no obstacles in the path to the sky. You can mount it indoors or outdoors.

Information from XM Satellite Radio Inc.

XM monthly service subscription sold separately. XM Passport and XM Passport Home Dock required to receive XM service (sold separately). Installation costs and other fees and taxes, including a one-time activation fee may apply. Subscription fee is consumer only. All fees and programming subject to change. Channels with frequent explicit language are indicated with an "XL". Channel blocking is available for XM radio receivers by calling "1-800-XM-RADIO (1-800-967-2346)" (for residents in the United States) or "1-877-GET-XMSR (1-877-438-9677)" (for residents in Canada). Subscriptions subject to Customer Agreement available at "<http://www.xmradio.com/>" (for residents in the United States) or "<http://www.xmradio.ca/>" (for residents in Canada). XM service only available in the 48 continuous United States and Canada. "XM Ready" is a trademark of XM Satellite Radio Inc. © 2006 XM Satellite Radio Inc. All rights reserved.

Connecting the XM Passport System

Connect XM Passport and XM Passport Home Dock (sold separately) to the XM jack on the rear panel of this unit. For details, see the operating instructions provided with XM Passport System.

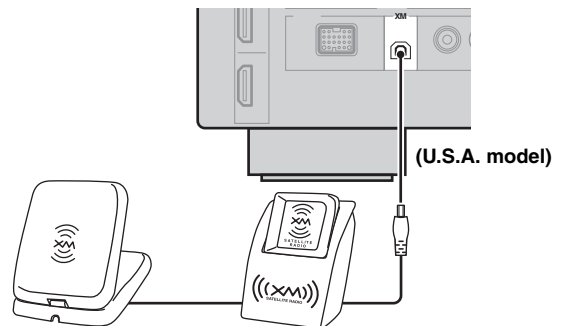

XM Passport and XM Passport Home Dock (sold separately)

XM Satellite Radio controls and functions

Note

The following controls are available only when “XM” is selected as the input source. Rotate the INPUT selector on the front panel (or set the operation mode selector to SOURCE and then press XM on the remote control) to select “XM” as the input source.

■ Front panel functions

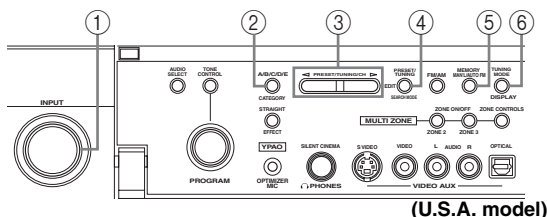

① **INPUT selector**

Selects “XM” as the input source.

② **CATEGORY**

(All Channel Search mode)

Changes the channel category while staying in the All Channel Search mode.

(Category Search mode)

Changes the channel category.

(Preset Search mode)

Changes the preset channel group (A to E).

③ **PRESET/TUNING/CH </>**

(All Channel Search mode)

Searches for a channel within all channels. Press and hold for quick search.

(Category Search mode)

Searches for a channel within the selected category. Press and hold for quick search.

(Preset Search mode)

Changes the preset channel number (1 to 8).

④ **SEARCH MODE**

Changes the search mode between the All Channel Search, Category Search, and Preset Search modes (see page 66).

⑤ **MEMORY (MAN'L/AUTO FM)**

Stores a preset channel in the memory (see page 70).

⑥ **DISPLAY**

Displays the XM Satellite Radio information such as channel number, channel name, category, artist name, or song title displayed in the front panel display or in the OSD (see page 71).

■ Remote control functions

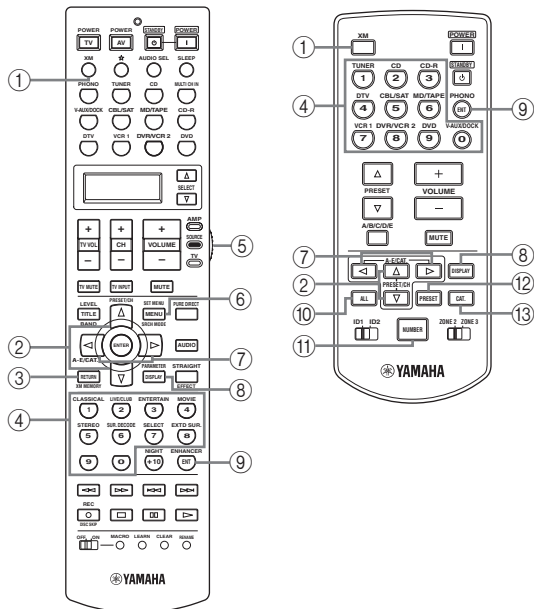

① **XM**

Selects “XM” as the input source.

② **PRESET/CH Δ / ∇**

(All Channel Search mode)

Searches for a channel within all channels. Press and hold for quick search.

(Category Search mode)

Searches for a channel within the selected category. Press and hold for quick search.

(Preset Search mode)

Changes the preset channel number (1 to 8).

③ **XM MEMORY**

Stores a preset channel in the memory (see page 70).

④ **Numeric buttons**

(All Channel Search or Category Search mode)

Use 1 to 9 and 0 to enter a channel number directly.

(Preset Search mode)

Use 1 to 8 to enter a preset channel number directly.

⑤ **Operation mode selector**

Set to SOURCE when you operate the XM Satellite Radio tuning function.

⑥ SRCH MODE

Changes the search mode between the All Channel Search, Category Search, and Preset Search modes (see page 66).

⑦ A-E/CAT. </>**(All Channel Search mode)**

Changes the channel category.

(Category Search mode)

Changes the channel category.

(Preset Search mode)

Changes the preset channel group (A to E).

⑧ DISPLAY

Displays the XM Satellite Radio information such as channel number, channel name, category, artist name, or song title displayed in the front panel display or in the OSD (see page 71).

⑨ ENT

Confirms an entered channel number in the Direct Number Access mode (see page 69).

⑩ ALL

Selects the All Channel Search mode (see page 66).

⑪ NUMBER

Press and hold before you press the input selector or numeric buttons to switch the function to entering numbers.

⑫ PRESET

Selects the Preset Search Mode (see page 68).

⑬ CAT.

Selects the Category Search mode (see page 67).

Activating XM Satellite Radio

To sign up for an account with the XM Satellite Radio service, an XM Satellite Radio ID number is required. Follow the procedure below to check your ID number, and then visit the website or call toll-free with a major credit card handy for signing up.

For residents in the United States

URL: <http://activate.xmradio.com/>

Toll-free: 1-800-XM-RADIO (1-800-967-2346)

For residents in Canada

URL: <https://activate.xmradio.ca/on-line-activation/activation.jsp>

Toll-free: 1-877-GET-XMSR (1-877-438-9677)

(U.S.A. model)

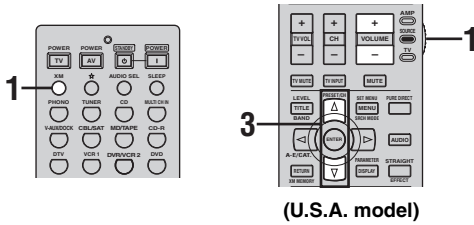
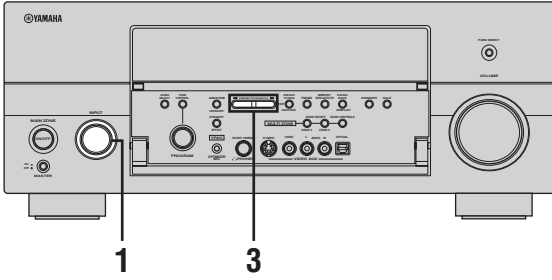

- 1** Rotate the INPUT selector on the front panel (or set the operation mode selector to SOURCE and then press XM on the remote control) to select “XM” as the input source. The cursor on the left of the XM indicator lights up in the front panel display.

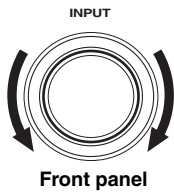

or

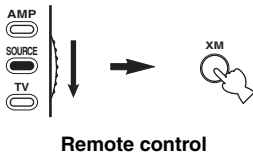

Lights up

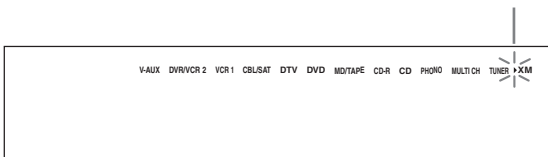

- 2** Check the XM Satellite Radio reception level and adjust the orientation of XM Passport System for a better percentage of the reception level.



You can display the XM Satellite Radio reception level by using the “XM ANTENNA” parameter in “OPTION MENU” (see page 100).

Notes

- If “CHECK ANTENNA” appears in the front panel display, XM Passport System may not be connected to the XM jack on the rear panel of this unit properly. See “Connecting the XM Passport System” on page 61 and check the connection.
- The “XM ANTENNA” parameter in “OPTION MENU” (see page 100) cannot be adjusted by using the remote control. Instead, you need to adjust the orientation of XM Passport System connected to the XM jack of this unit for a better percentage of the reception level.

- 3** Press PRESET/TUNING/CH </> on the front panel (or PRESET/CH Δ / ▽ on the remote control) to select channel “0”.

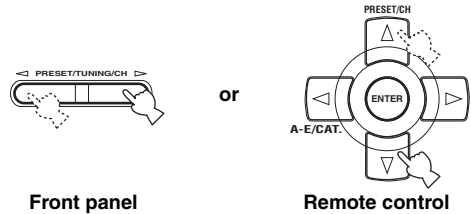

Note

You cannot select channel “0” if the All Channel Search mode (see page 66) is not selected.

- 4** Check the XM Satellite Radio ID number displayed in the front panel display and write it down.

ID: _____

Basic XM Satellite Radio operations

(U.S.A. model)

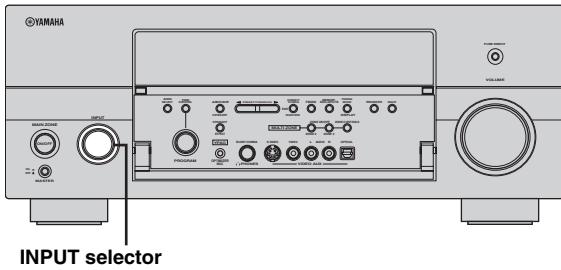

INPUT selector

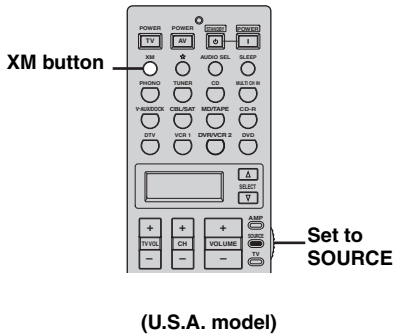

(U.S.A. model)

- 1 Rotate the INPUT selector on the front panel (or set the operation mode selector to SOURCE and then press XM on the remote control) to select “XM” as the input source.

The cursor on the left of the XM indicator lights up in the front panel display and the XM Satellite Radio information (such as channel number, channel name, category, artist name, or song title) for the currently selected channel appears in the front panel display.

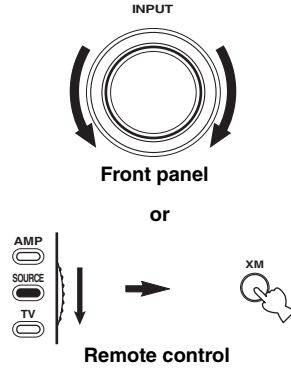

Lights up

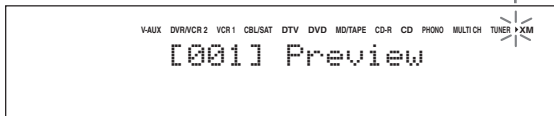

When you select “XM” as the input source, this unit automatically recalls the previously selected channel.

Note

The XM Satellite Radio signals cannot be output at the AUDIO OUT (REC) jacks.

- 2 Search for a channel by using one of the XM Satellite Radio search modes.

- To select a channel from the all channel list, see “All Channel Search mode” on page 66.
- To select a channel by category, see “Category Search mode” on page 67.
- To select a channel from the preset channels, see “Preset Search mode” on page 68.
- To select the desired channel directly by entering the channel number, see “Direct Number Access mode” on page 69.



- You can use the Neural Surround decoder to enjoy the surround sound content of XM Satellite Radio broadcasts in multi-channels (see page 80).
- You can set the XM Satellite Radio preset channels (see page 70).
- You can display the XM Satellite Radio information in the front panel display or in the OSD (see page 71).

■ All Channel Search mode

(U.S.A. model)

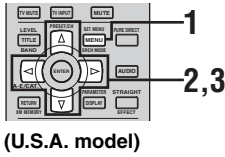
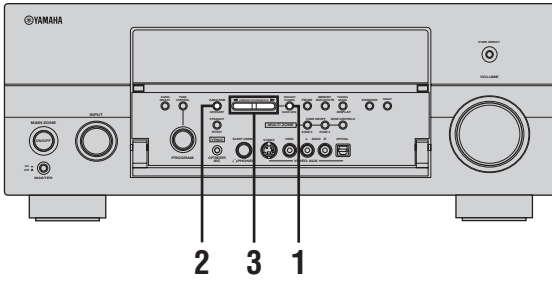

- 1** Press **SEARCH MODE** on the front panel (or **SRCH MODE** on the remote control) repeatedly to select “ALL CH SEARCH”.

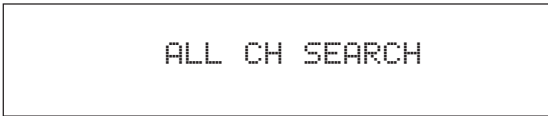
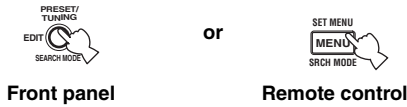

- 2** Press **CATEGORY** on the front panel (or **A-E/CAT.** \triangle/∇ on the remote control) repeatedly to change the channel category.

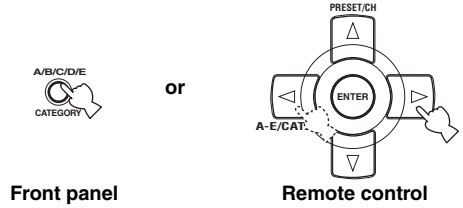

- 3** Press **PRESET/TUNING/CH** \triangle/∇ on the front panel (or **PRESET/CH** \triangle/∇ on the remote control) repeatedly to search for a channel within all channels.

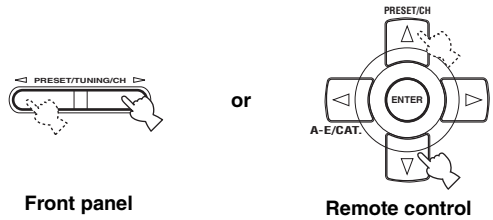

You can search for a channel quickly by pressing and holding **PRESET/TUNING/CH** \triangle/∇ on the front panel (or **PRESET/CH** \triangle/∇ on the remote control).

■ Category Search mode

(U.S.A. model)

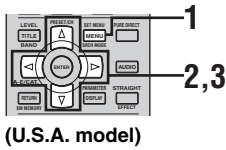
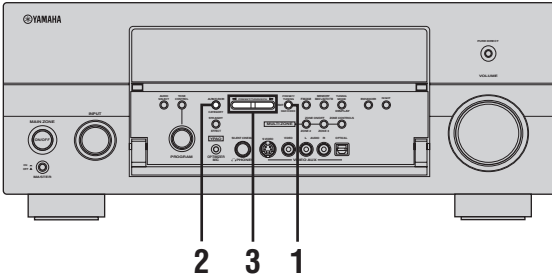

1 Press SEARCH MODE on the front panel (or SRCH MODE on the remote control) repeatedly to select “CAT SEARCH”.

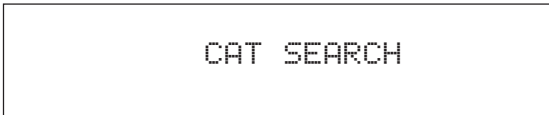
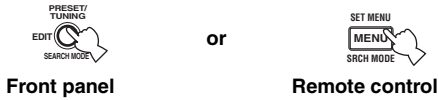

2 Press CATEGORY on the front panel (or A-E/CAT. </> on the remote control) repeatedly to change the channel category.

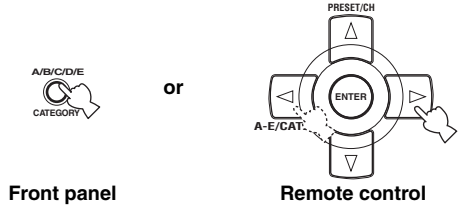

3 Press PRESET/TUNING/CH </> on the front panel (or PRESET/CH Δ / ▽ on the remote control) repeatedly to search for a channel within the selected channel category.

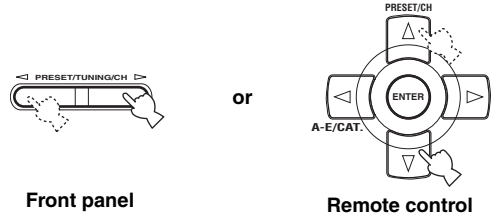

You can search for a channel quickly by pressing and holding PRESET/TUNING/CH </> on the front panel (or PRESET/CH Δ / ▽ on the remote control).

■ Preset Search mode

Prior to selecting a preset channel in the Preset Search mode, you must preset XM Satellite Radio channels. For details, see “Setting the XM Satellite Radio preset channels” on page 70.



The initial factory setting of all preset channels (A1 to E8) is “[001] Preview”.

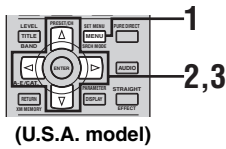
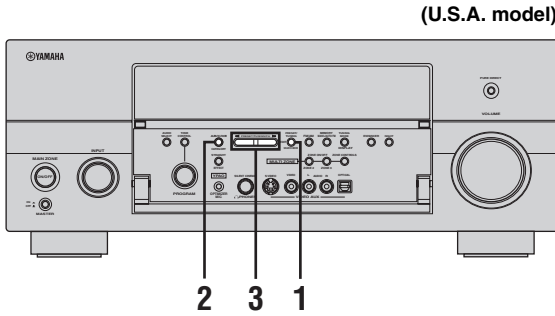

- 1 Press SEARCH MODE on the front panel (or SRCH MODE on the remote control) repeatedly to select “PRESET SEARCH”.**

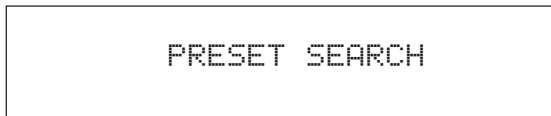
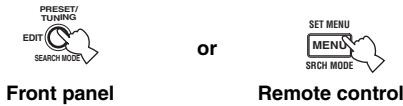

- 2 Press CATEGORY on the front panel (or A-E/CAT. </> on the remote control) repeatedly to change the preset channel group (A to E).**

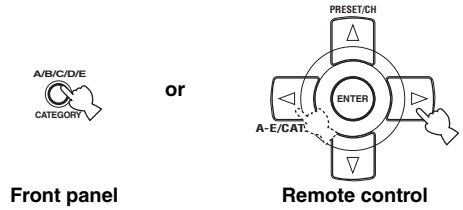

- 3 Press PRESET/TUNING/CH </> on the front panel (or PRESET/CH Δ / ▽ on the remote control) repeatedly to change the preset channel number (1 to 8).**

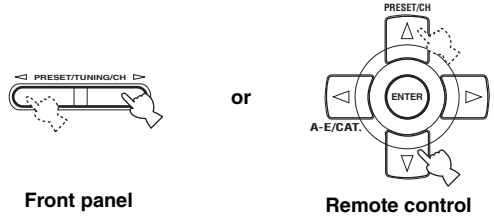

You can also select the preset channel number directly by pressing the numeric buttons (1 to 8) on the remote control.

■ Direct Number Access mode

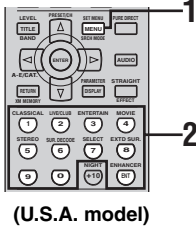

1 Press SRCH MODE on the remote control repeatedly to select “ALL CH SEARCH” or “CAT SEARCH”.



Remote control

ALL CH SEARCH

or

CAT SEARCH

2 Press the numeric buttons on the remote control to enter the desired three-digit channel number.

For example, to enter the number 123, press the numeric buttons as shown below.



The display changes as follows.

<XM> --1

<XM> -12

<XM>123



- To enter a one-digit or two-digit channel number, press the numeric buttons on the remote control and then press ENT to confirm the input number.
- Instead of pressing ENT to tune into the channel immediately, you can wait a few seconds until this unit confirms the entered channel number.
- If no button is pressed within a few seconds after you enter a one-digit or two-digit number, this unit automatically confirms the entered channel number.
- Pressing a button other than the numeric buttons or ENT cancels the Direct Number Access mode procedure.

Setting the XM Satellite Radio preset channels

You can use this feature to store up to 40 XM Satellite Radio channels (A1 to E8: 8 preset channel numbers in each of the 5 preset channel groups). You can then recall any preset channel easily by selecting the preset channel group and number as described in “Preset Search mode” on page 68.

(U.S.A. model)

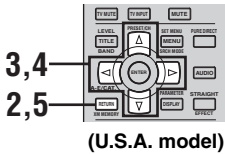
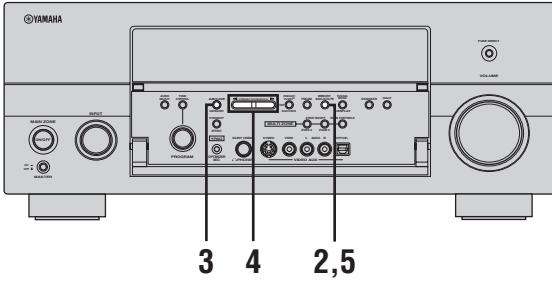

1 Search for a channel you want to set as a preset channel by using one of the XM Satellite Radio search modes.

See “Basic XM Satellite Radio operations” on page 65 for details.

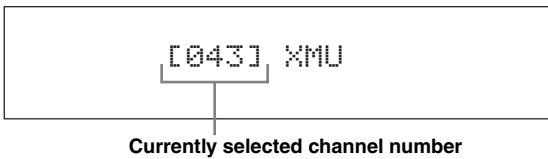

2 Press MEMORY on the front panel (or XM MEMORY on the remote control).

The MEMORY indicator flashes in the front panel display for approximately 5 seconds.

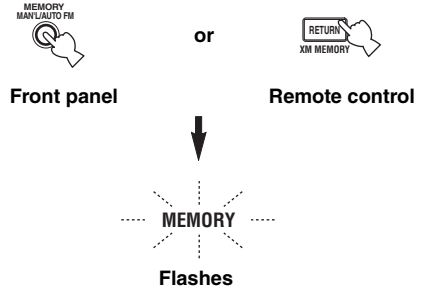

Note

You must proceed to and carry out steps 3 through 5 while the MEMORY indicator is flashing in the front panel display.

3 Press CATEGORY on the front panel (or A-E/CAT. </> on the remote control) repeatedly to select a preset channel group (A to E) while the MEMORY indicator is flashing.

The preset channel group letter appears in the front panel display.

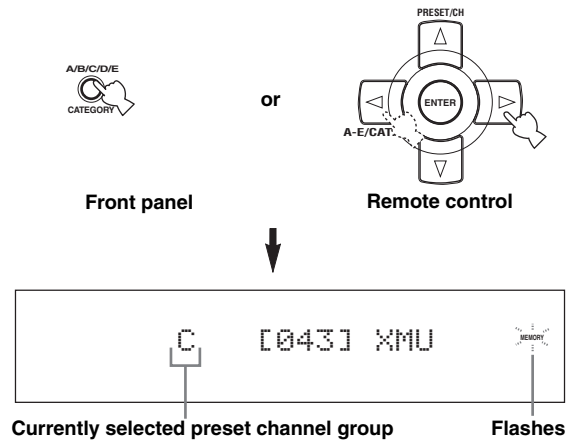

- 4 Press PRESET/TUNING/CH ◀/▶ on the front panel (or PRESET/CH ▲/▼ on the remote control) repeatedly to select a preset channel number (1 to 8) while the MEMORY indicator is flashing.**

The preset channel number appears in the front panel display.

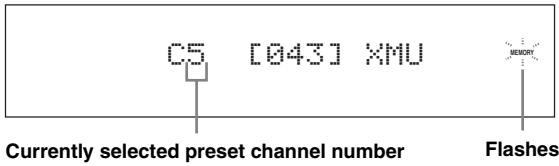
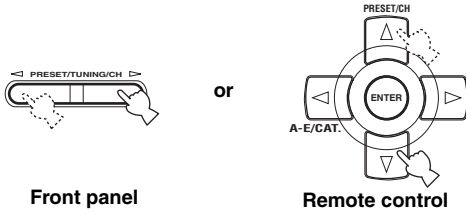

- 5 Press MEMORY on the front panel (or XM MEMORY on the remote control) to set the selected XM Satellite Radio channel as a preset channel while the MEMORY indicator is flashing.**

A colon (:) appears next to the preset channel number for confirmation, and the MEMORY indicator turns off in the front panel display.

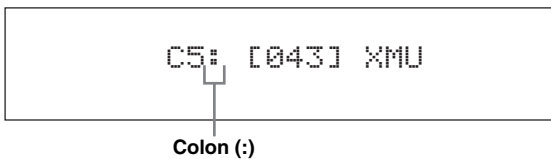
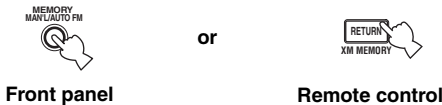

Note

Once you set a new preset channel, the one previously stored in the same preset channel group and number is cleared.

Displaying the XM Satellite Radio information

You can display the XM Satellite Radio information (such as channel number, channel name, category, artist name, or song title) for the currently selected channel in the front panel display or in the OSD.

(U.S.A. model)

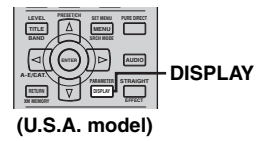
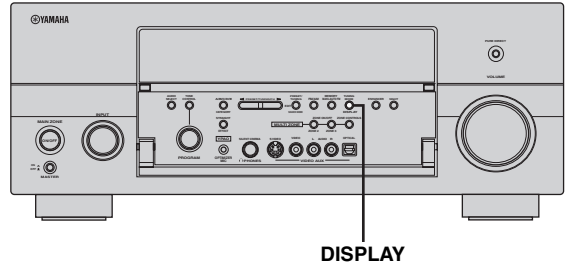

Note

If a status message or an error message appears in the front panel display or in the OSD, see the “XM Satellite Radio (U.S.A. and Canada models only)” section in “TROUBLESHOOTING” on page 122 for appropriate remedies.

■ Displaying the XM Satellite Radio information in the front panel display

Press DISPLAY on the front panel or on the remote control repeatedly to toggle between the following XM Satellite Radio information display modes.

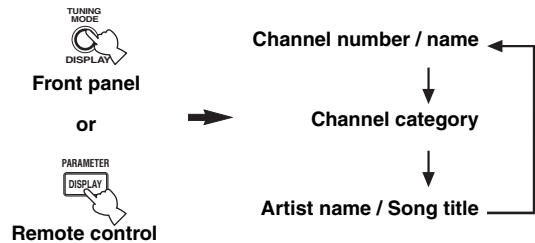

When the channel number / name is displayed:

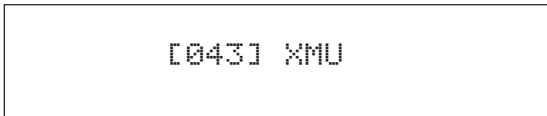

When the channel category is displayed:



When the artist name / song title is displayed:

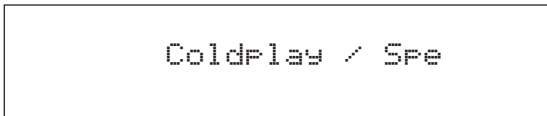

- The front panel display can indicate up to 14 alphanumeric characters at once. You can set whether to display the XM Satellite Radio information in the front panel display in a continuous manner or by 14 alphanumeric characters at once by using the “FL SCROLL” parameter in “OPTION MENU” (see page 98).
- If the XM Satellite Radio information contains a character that cannot be recognized by this unit, the character will be displayed with a space.

Note

If you press DISPLAY while the XM Satellite Radio information display is scrolling from right to left in the front panel display, the XM Satellite Radio information display mode toggles as described above.

■ Displaying the XM Satellite Radio information in the OSD

Press DISPLAY on the remote control.

The following screen is displayed in the OSD.

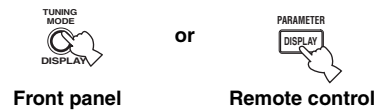

- To turn off the OSD, press DISPLAY on the front panel (or on the remote control).
- You can select the amount of time the XM Satellite Radio information is displayed in the OSD by using the “ON SCREEN” parameter in “OPTION MENU” (see page 98).
- To hold the XM Satellite Radio information screen, press ENTER on the remote control while it is being displayed in the OSD.
- The XM Satellite Radio information screen on hold is released if you press ENTER on the remote control again or if you change the XM Satellite Radio channel.
- This unit can save up to two XM Satellite Radio information screens for future reference. To view the previous two XM Satellite Radio information screens, press TITLE on the remote control repeatedly while the current XM Satellite Radio information screen is being hold.

USING iPod

Once you have stationed your iPod in a YAMAHA iPod universal dock (such as the YDS-10, sold separately) connected to the DOCK terminal of this unit (see page 27), you can enjoy playback of your iPod using the supplied remote control. You can also use the Compressed Music Enhancer mode of this unit to improve the sound quality of the compression artifacts (such as the MP3 format) stored on your iPod (see page 52).

Notes

- Only iPod (Click and Wheel), iPod nano, and iPod mini are supported.
- Some features may not be compatible depending on the model or the software version of your iPod.



- For a complete list of the remote control functions used to control your iPod, see the “iPod” column in “Controlling other components” on page 102.
- For a complete list of status messages that appear in the front panel display and in the OSD, see the “iPod” section in “TROUBLESHOOTING” on page 128.
- Once your iPod is stationed in a YAMAHA iPod universal dock (such as the YDS-10, sold separately) connected to the DOCK terminal of this unit, this unit begins signal transmission with your iPod.
- Once the connection between your iPod and this unit is complete, “iPod connected” appears in the front panel display and the DOCK indicator lights up in the front panel display.
- Only the analog audio and video signals of your iPod are input at the DOCK terminal, and the analog audio signals can be output at the analog AUDIO OUT (REC) jacks for recording.
- Your iPod battery is automatically charged when your iPod is stationed in a YAMAHA iPod universal dock (such as the YDS-10, sold separately) connected to the DOCK terminal of this unit as long as this unit is turned on. You can also select whether this unit charges the battery of the stationed iPod or not when this unit is in the standby mode by selecting the “STANDBY CHRGE” parameter in “OPTION MENU” (on page 100).
- While the stationed iPod is being charged in the standby mode of this unit, the battery charge indicator (see page 10) appears in the front panel display. Once the charge is complete (or after 4 hours from the start of the charge), the indicator disappears.

Controlling iPod

You can control your iPod when “V-AUX” is selected as the input source. The operations of your iPod can be done with the aid of the OSD of this unit (menu browse mode) or without it (simple remote mode).

■ Controlling iPod in the simple remote mode

You can perform the basic operations of your iPod (play, stop, skip, etc.) using the supplied remote control without the aid of the OSD of this unit.



- You can view the photos or video clips stored on your iPod.
- Operations can be also done with the controls on your iPod.

■ Controlling iPod in the menu browse mode

You can perform the advanced operations of your iPod using the supplied remote control with the aid of the OSD of this unit. The name of the song being played appears in the front panel display according to the “FL SCROLL” parameter in “OPTION MENU” (see page 98). You can also browse the songs stored on your iPod in the OSD. Further, you can change or adjust settings for your iPod to suit your personal preferences.

Notes

- Operations cannot be done with the controls on your iPod.
- The YAMAHA logo appears in the display window of your iPod.
- There are some characters that cannot be displayed in the front panel display or in the OSD of this unit. Those characters are replaced with underscores “_”.
- The “Settings” parameters can be changed or adjusted only in the OSD. Press ENTER on the remote control to toggle between the “Settings” parameter settings.
- You cannot browse the photos or video clips stored on your iPod in the OSD. Instead, you must use the controls on your iPod to select the desired photos or video clips.

1 Set the operation mode selector to SOURCE and then press DISPLAY on the remote control.

The following display appears in the OSD.

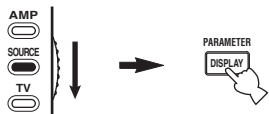

2 Press Δ / ▽ / ◀ / ▶ on the remote control to navigate the iPod menu and then press ENTER to begin playback of the selected song.

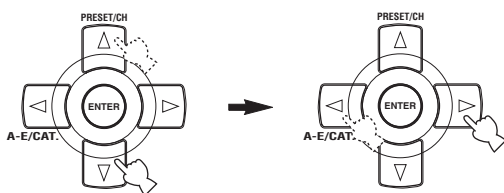

Choices: Playlists (playlists), Artists (artists), Albums (albums), Songs (songs), Genres (genres), Composers (composers), Settings (settings)

- Playlists > Songs
- Artists > Albums > Songs
- Albums > Songs
- Songs
- Genres > Artists > Albums > Songs
- Composers > Albums > Songs
- Settings > Shuffle, Repeat

Shuffle Shuffle

Use this feature to set this unit to play songs or albums in random order.

Choices: **Off**, Songs, Albums

- Select “Off” to deactivate this feature.
- Select “Songs” to set this unit to play songs in random order.
- Select “Albums” to set this unit to play albums in random order.

Note

When “Shuffle” is set to a setting other than “Off”, “” appears in the top right corner while songs or albums are being shuffled.



Repeat Repeat

Use this feature to set this unit to repeat one song or a sequence of songs.

Choices: **Off**, One, All

- Select “Off” to deactivate this feature.
- Select “One” to set this unit to repeat one song.
- Select “All” to set this unit to repeat a sequence of songs.

Note

When “Repeat” is set to a setting other than “Off”, “” or “” appears in the top right corner while one song or a sequence of songs are being repeated.

RECORDING

Recording adjustments and other operations are performed from the recording components. Refer to the operating instructions for those components.

CAUTION

The DTS signal is a digital bitstream. Attempting to digitally record the DTS bitstream will result in noise being recorded. Therefore, if you want to use this unit to record sources encoded in DTS, the following considerations and adjustments need to be made. To play DTS-encoded DVDs and CDs (when using a digital audio connection) on your DTS-compatible player, follow its operating instructions to make a setting so that the analog signal will be output from the player.

Notes

- When this unit is set to the standby mode, you cannot record between other components connected to this unit.
- The settings of TONE CONTROL (see page 50), VOLUME, the speaker level (see page 90) and the sound field programs (see page 45) do not affect recorded material.
- The source connected to the MULTI CH INPUT jacks of this unit cannot be recorded.
- The XM Satellite Radio signals (U.S.A. and Canada models only) cannot be output at the AUDIO OUT (REC) jacks.
- Digital signals input at the DIGITAL INPUT jacks are not output at the analog AUDIO OUT (REC) jacks for recording. Likewise, analog signals input at the AUDIO IN jacks are not output at the DIGITAL OUTPUT jack. Therefore, if your source component is connected to provide only digital or analog signals, you can only record digital or analog signals.
- A given input source is not output on the same OUT (REC) channel.
- S-video and composite video signals pass independently through the video circuits of this unit. Therefore, when recording or dubbing video signals input from a video source component that provides only an S-video or a composite video signal, you can record only an S-video or a composite video signal on your VCR.
- The analog audio signals input at the DOCK terminal can be output at the analog AUDIO OUT (REC) jacks for recording.
- Check the copyright laws in your country to record from CDs, radio, etc. Recording of copyrighted material may infringe copyright laws.



Do a test recording before you start an actual recording.

If you play back a video source that uses scrambled or encoded signals to prevent it from being dubbed, the picture itself may be disturbed due to those signals.

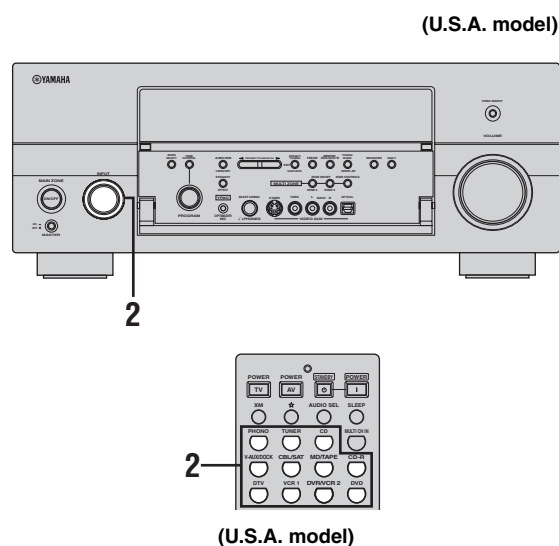

- 2 Rotate the INPUT selector on the front panel (or press one of the input selector buttons on the remote control) to select the source component you want to record from.

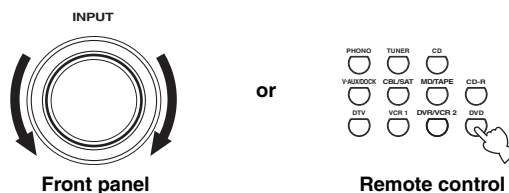

- 3 Start playback on the selected source component or select a broadcast station.
- 4 Start recording on the recording component.

- 1 Turn on all the connected components.

ADVANCED SOUND CONFIGURATIONS

Changing sound field parameter settings

You can enjoy good quality sound with the initial factory settings. Although you do not have to change the initial factory settings, you can change some of the parameters to better suit the input source or your listening room.

Note

You cannot change the sound field parameter values when "MEMORY GUARD" in "OPTION MENU" is set to "ON" (see page 98). If you want to change the sound field parameter values, set "MEMORY GUARD" to "OFF".

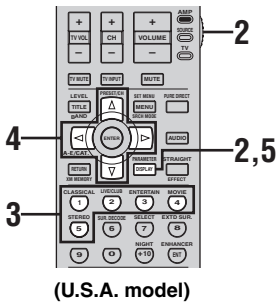

1 Turn on the video monitor connected to this unit.

2 Set the operation mode selector to AMP and then press PARAMETER on the remote control.

The following display is shown in the OSD.

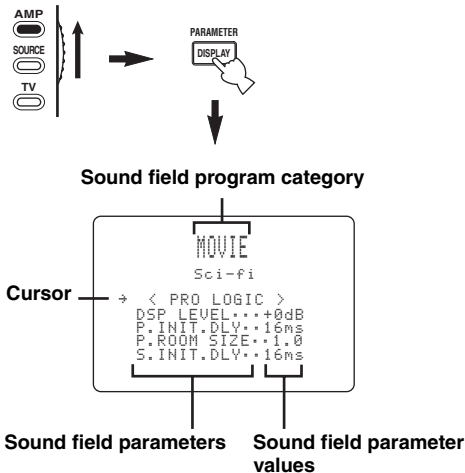

3 Press one of the sound field program selector buttons repeatedly to select the desired sound field program you want to adjust.



4 Press Δ / ∇ to select the desired sound field parameter and then \triangleleft / \triangleright to change the selected sound field parameter value.

- Press \triangleright to increase the value.
- Press \triangleleft to decrease the value.

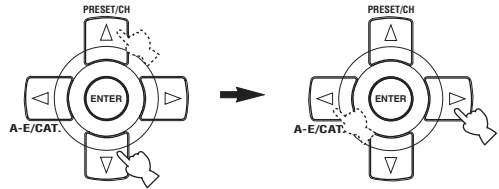

- For details about the function and control range of each sound field parameter, see page 77.
- When you set a sound field parameter to a value other than the initial factory settings, an asterisk mark (*) appears by the sound field parameter name in the OSD.
- Repeat steps 3 and 4 as necessary to change other sound field program parameter settings.
- The available sound field parameters for some of the sound field programs may be displayed on more than one page in the OSD. In this case, press Δ / ∇ to scroll through pages.
- If you press and hold \triangleleft / \triangleright to change the sound field parameter value, the initial factory settings are shown momentarily in the front panel display.
- Use the "PARAM. INI" feature in "OPTION MENU" to initialize the parameters of each sound field program within a sound field program group (see page 99).
- To initialize the parameters of the selected sound field program, press ∇ repeatedly to select "PARAM. INIT" and then press \triangleright repeatedly.

5 Press PARAMETER to turn off the sound field parameter display.



■ Sound field parameter descriptions

You can adjust the values of certain digital sound field parameters so that the sound fields are recreated accurately in your listening room. Not all of the following parameters are found in every program.



To change sound field parameter settings to suit your listening environment, see page 76 for details.

Sound field parameter	Features
DSP LEVEL	DSP level. Adjusts the level of all the DSP effect sounds within a narrow range. Depending on the acoustics of your listening room, you may want to increase or decrease the DSP effect level relative to the level of the direct sound. Control range: -6 dB to +3 dB
INIT.DLY P. INIT.DLY S. INIT.DLY SB INI.DLY	Initial delay. Presence, surround, and surround back initial delay. Changes the apparent distance from the source sound by adjusting the delay between the direct sound and the first reflection heard by the listener. The smaller the value, the closer the sound source seems to the listener. The larger the value, the farther it seems. For a small room, set to a small value. For a large room, set to a large value. Control range: 1 to 99 ms (INIT.DLY and P.INIT.DLY) 1 to 49 ms (S.INIT.DLY and SB INI.DLY)

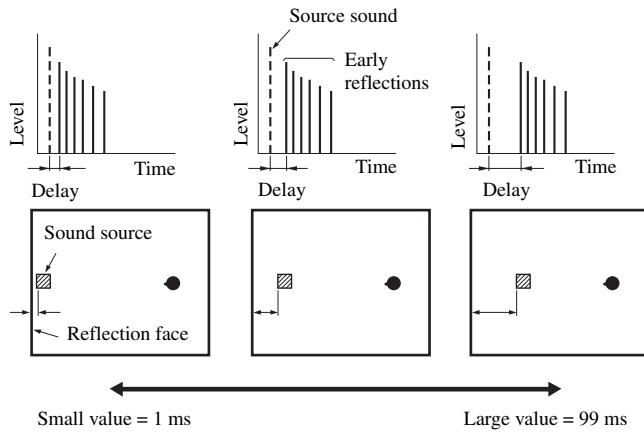

Sound field parameter	Features
-----------------------	----------

ROOM SIZE
 P. ROOM SIZE
 S. ROOM SIZE
 SB ROOM SIZE

Room size. Presence, surround, and surround back room size. Adjusts the apparent size of the surround sound field. The larger the value, the larger the surround sound field becomes. As the sound is repeatedly reflected around a room, the larger the hall is, the longer the time between the original reflected sound and the subsequent reflections. By controlling the time between the reflected sounds, you can change the apparent size of the virtual venue. Changing this parameter from one to two doubles the apparent length of the room.

Control range: 0.1 to 2.0

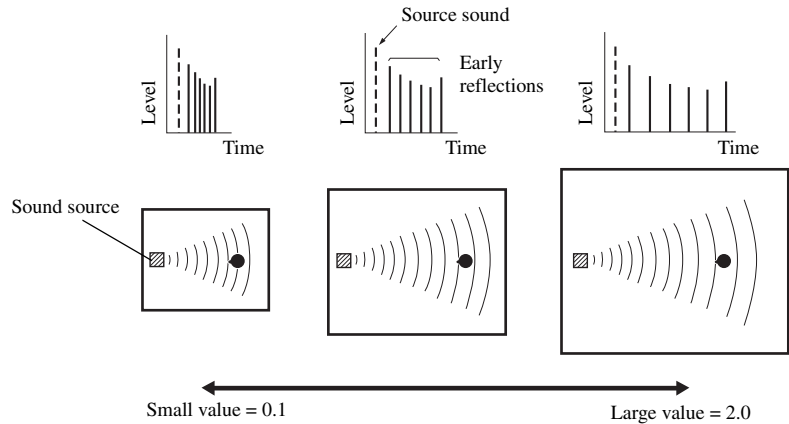

LIVENESS
 S. LIVENESS
 SB LIVENESS

Liveness. Surround and surround back liveness. Adjusts the reflectivity of the virtual walls in the hall by changing the rate at which the early reflections decay. The early reflections of a sound source decay much faster in a room with acoustically absorbent wall surfaces than in one which has highly reflective surfaces. A room with acoustically absorbent surfaces is referred to as “dead”, while a room with highly reflective surfaces is referred to as “live”. This parameter lets you adjust the early reflection decay rate and thus the “liveness” of the room.

Control range: 0 to 10

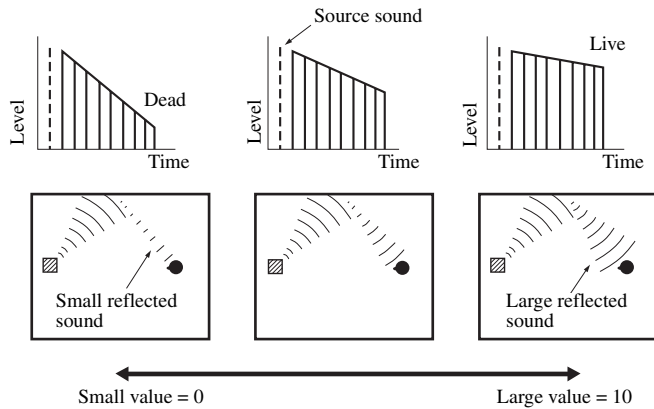

Sound field parameter	Features
-----------------------	----------

REV.TIME

Reverberation time. Adjusts the amount of time taken for the dense, subsequent reverberation sound to decay by 60 dB at 1 kHz. This changes the apparent size of the acoustic environment over an extremely wide range. Set a longer reverberation time for “dead” sources and listening room environments, and a shorter time for “live” sources and listening room environments.

Control range: 1.0 to 5.0 s

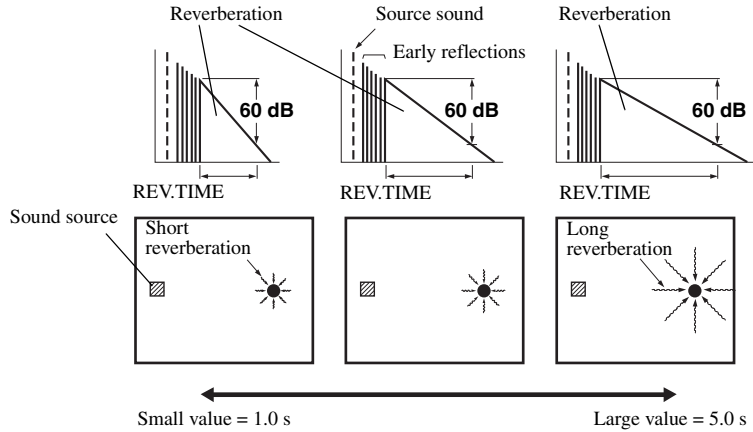

REV.DELAY

Reverberation delay. Adjusts the time difference between the beginning of the direct sound and the beginning of the reverberation sound. The larger the value, the later the reverberation sound begins. A later reverberation sound makes you feel as if you are in a larger acoustic environment.

Control range: 0 to 250 ms

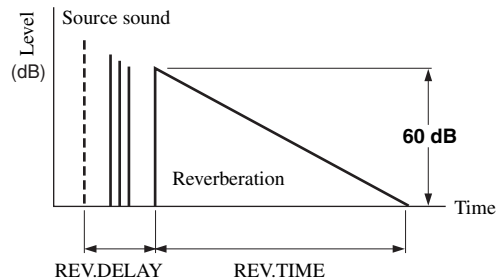

REV.LEVEL

Reverberation level. Adjusts the volume of the reverberation sound. The larger the value, the stronger the reverberation becomes.

Control range: 0 to 100%

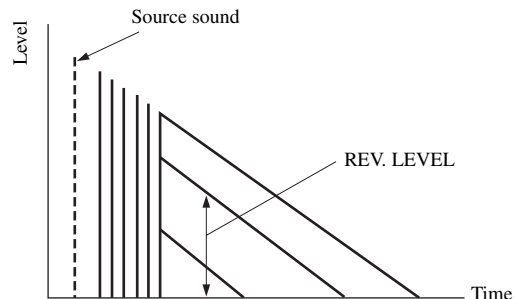

ADVANCED OPERATION

Sound field parameter	Features
DIALG.LIFT	<p>Dialog lift. Adjusts the height of the front and center channel sounds by assigning some of the front and center channel elements to the presence speakers. The larger the parameter, the higher the position of the front and center channel sound.</p> <hr/> <p>Choices: 0, 1, 2, 3, 4, 5</p>
2ch Stereo DIRECT	<p>2-channel stereo direct. Bypasses the decoders and DSP processors of this unit for pure hi-fi stereo sound when playing 2-channel analog sources.</p> <hr/> <p>Choices: AUTO, OFF</p> <hr/> <p></p> <ul style="list-style-type: none"> • Select “AUTO” to bypass the decoders, DSP processors and the tone control circuitry only when “BASS” and “TREBLE” are set to 0 dB (see page 50). • Select “OFF” not to bypass the decoders, DSP processors and the tone control circuitry when “BASS” and “TREBLE” are set to 0 dB. • When multi-channel signals (Dolby Digital and DTS) are input, they are downmixed to 2 channels and output from the front left and right speakers. • The low-frequency signals input from the front left and right speakers are redirected to the subwoofer in the following cases: <ul style="list-style-type: none"> – “LFE/BASS OUT” is set to “BOTH” (see page 87). – “FRONT SP” is set to “SMALL” (see page 88) and “LFE/BASS OUT” is set to “SWFR” (see page 87).
7ch Stereo CT LEVEL SL LEVEL SR LEVEL SB LEVEL PL LEVEL PR LEVEL	<p>7-channel stereo center, surround left, surround right, surround back, presence left and presence right levels. Adjusts the volume level of each channel in the 7-channel stereo mode.</p> <hr/> <p>Control range: 0 to 100%</p>

Selecting decoders

■ Selecting decoders for 2-channel sources (surround decode mode)

Use this feature to play back sources with selected decoders. You can play back 2-channel sources on multi-channels.

- 1 Set the operation mode selector to AMP and then press SUR. DECODE on the remote control to select the surround decode mode.



- 2 Press SELECT on the remote control repeatedly to select the desired decoder.

You can select from the following modes depending on the type of source you are playing and your personal preference.



- You can select the desired decoder by pressing SELECT and then press ◀/▶ repeatedly on the remote control.
- You can change the decoder parameter settings. Press PARAMETER and then ▲/▼ repeatedly on the remote control to select the desired decoder parameter. You can change the value of the selected parameter by pressing ◀/▶ repeatedly on the remote control.

■ Decoder descriptions

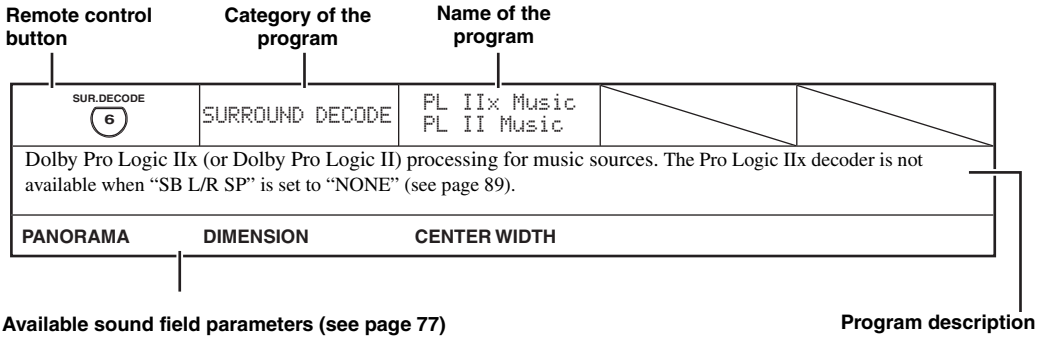

SUR.DECODE 6	SURROUND DECODE	PRO LOGIC		
Dolby Pro Logic processing for any sources.				

SUR.DECODE 6	SURROUND DECODE	PLIIX Movie PL II Movie		
Dolby Pro Logic IIX (or Dolby Pro Logic II) processing for movie sources. The Pro Logic IIX decoder is not available when "SB L/R SP" is set to "NONE" (see page 89).				

SUR.DECODE 6	SURROUND DECODE	PLIIX Music PL II Music		
Dolby Pro Logic IIX (or Dolby Pro Logic II) processing for music sources. The Pro Logic IIX decoder is not available when "SB L/R SP" is set to "NONE" (see page 89).				
PANORAMA	DIMENSION	CENTER WIDTH		

SUR.DECODE 6	SURROUND DECODE	PLIIX Game PL II Game		
Dolby Pro Logic IIX (or Dolby Pro Logic II) processing for game sources. The Pro Logic IIX decoder is not available when "SB L/R SP" is set to "NONE" (see page 89).				

SUR.DECODE 6	SURROUND DECODE	Neo: 6 Cinema		
DTS processing for movie sources.				

SUR.DECODE 6	SURROUND DECODE	Neo:6 Music		
DTS processing for music sources.				

C. IMAGE

SUR.DECODE 6	SURROUND DECODE	neural sur. (U.S.A. and Canada models only)		
Neural Surround processing for any sources. The Neural Surround decoder is compatible with PCM signals (32 kHz, 44.1 kHz, 48 kHz, 64 kHz, 88.2 kHz and 96 kHz) and analog 2-channel input sources. When Neural Surround-incompatible signals are being input while the Neural Surround decoder is selected, multi-channel sources are decoded straight into the appropriate channels without any additional effect processing and the Neural Surround-incompatible PCM signals are played back in stereo. The Neural Surround decoder is especially suitable for the XM HD Surround program of XM Satellite Radio.				

☀️
When you select the surround decode mode for Dolby Digital, DTS or DTS 96/24 sources, this unit automatically selects "SURROUND DECODE Dolby Digital", "SURROUND DECODE DTS" or "SURROUND DECODE DTS 96/24" program.

Decoder parameter descriptions

Decoder parameter	Features
PRO LOGIC IIx Music PRO LOGIC II Music PANORAMA	Pro Logic IIx Music and Pro Logic II Music panorama. Sends stereo signals to the surround speakers as well as the front speakers for a wraparound effect. Choices: OFF , ON
PRO LOGIC IIx Music PRO LOGIC II Music DIMENSION	Pro Logic IIx Music and Pro Logic II Music dimension. Adjusts the sound field either towards the front or towards the rear. Control range: -3 (towards the rear) to +3 (towards the front) Initial setting: STD (standard)
PRO LOGIC IIx Music PRO LOGIC II Music CENTER WIDTH	Pro Logic IIx Music and Pro Logic II Music center width. Moves the center channel output completely towards the center speaker or towards the front left and right speakers. A larger value moves the center channel output towards the front left and right speakers. Control range: 0 (center channel sound is output only from the center speaker) to 7 (center channel sound is output only from the front left and right speakers) Initial setting: 3
DTS Neo:6 Music C. IMAGE	DTS Neo:6 Music center image. Adjusts the front left and right channel output relative to the center channel to make the center channel more or less dominant as necessary. Control range: 0.0 to 1.0 Initial setting: 0.3

■ Selecting decoders used with sound field programs

Use this feature to select the desired decoder used with MOVIE sound field programs (except “Mono Movie”). See page 47 for details about MOVIE sound field program.

- 1 Set the operation mode selector to AMP and then press MOVIE on the remote control repeatedly to select the desired MOVIE sound field programs.

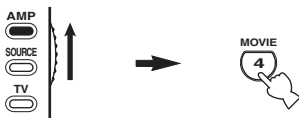

- 2 Press SELECT repeatedly to select the desired decoder used with the selected sound field program.

You can select from the following decoders depending on the type of source you are playing and your personal preference.



You can select the desired decoder by pressing SELECT and then press </> repeatedly on the remote control.

Available decoders

Decoder	Functions
PRO LOGIC	Dolby Pro Logic processing for any sources
PLIIx Movie PLII Movie	Dolby Pro Logic IIx (or Dolby Pro Logic II) processing for movie sources. The Pro Logic IIx decoder is not available when “SB L/R SP” is set to “NONE” (see page 89).
Neo:6 Cinema	DTS processing for movie sources

■ Selecting decoders for multi-channel sources

If you connected surround back speakers, use this feature to enjoy 6.1/7.1-channel playback for multi-channel sources using the Dolby Pro Logic IIx, Dolby Digital EX or DTS-ES decoders.

- 1 Set the operation mode selector to AMP and then press EXT D SUR. on the remote control repeatedly to switch between 5.1 and 6.1/7.1-channel playback.



- 2 Press </> repeatedly to select a decoder while the name of the decoder is displayed.

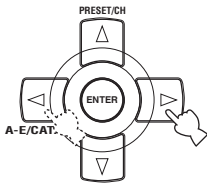

Auto AUTO

When a signal flag that can be recognized by this unit is input, this unit selects the optimum decoder to play back the signal in 6.1/7.1 channels.

If this unit cannot recognize the flag or no flag is present in the input signal, it cannot automatically be played in 6.1/7.1 channels.

Decoders

You can select from the following decoders depending on the format of the source you are playing.

Decoder	Functions
PLIIxMovie D+PLIIx Movie DTS+PLIIx Movie MPCM+PLIIx Movie DSD+PLIIx Movie	Plays back multi-channel sources in 7.1 channels using the Pro Logic IIx movie decoder.
PLIIxMusic D+PLIIx Music DTS+PLIIx Music MPCM+PLIIx Music DSD+PLIIx Music	Plays back multi-channel sources in 6.1/7.1 channels using the Pro Logic IIx music decoder.
DTS ES DTS 96/24 ES	Plays back DTS signals in 6.1/7.1 channels using the DTS-ES decoder.
DOLBY D EX DTS+DOLBY EX MPCM+DOLBY EX DSD+DOLBY EX	Plays back multi-channel sources in 6.1/7.1 channels using the Dolby Digital EX decoder.

Off OFF

Decoders are not used to create 6.1/7.1 channels.

Notes

- “PLIIx Movie” is available only when “SB L/R SP” (see page 89) is set to “SMLx2” or “LRGx2”.
- Some 6.1/7.1-channel compatible discs do not have a signal flag that can be automatically detected by this unit. When playing these kinds of discs in 6.1/7.1 channels, select a decoder manually from “PLIIx Music”, “EX/ES” or “EX”.
- 6.1/7.1-channel playback is not possible even if you press EXT D SUR. in the following cases:
 - when “SUR. L/R SP” (see page 88) or “SB L/R SP” (see page 89) is set to “NONE”.
 - when the component connected to the MULTI CH INPUT jacks is being played.
 - when the source being played does not contain surround left and right channel signals.
 - when a Dolby Digital KARAOKE source is being played.
 - when the “2ch Stereo” (see page 51) or Pure Direct (see page 50) mode is selected.
- When this unit is turned off, this setting will be reset to “AUTO”.
- The Pro Logic IIx decoder is not available when “SUR. B L/R SP” is set to “NONE” (see page 89).

CUSTOMIZING THIS UNIT (MANUAL SETUP)

You can use the following parameters in “SET MENU” to adjust a variety of system settings and customize the way this unit operates. Change the initial settings (indicated in bold under each parameter) to reflect the needs of your listening environment.

■ Auto setup **AUTO SETUP**

Use this feature to automatically adjust speaker and system parameters (see page 32).

■ Manual setup **MANUAL SETUP**

Use this feature to manually adjust speaker and system parameters.

Basic menu 1 BASIC MENU

Use this menu to manually adjust basic system parameters.

Parameter	Features	Page
A)SPEAKER SET	Selects the size of each speaker, the speakers for low-frequency signal output, and the crossover frequency.	87
B)SP LEVEL	Adjusts the output level of each speaker.	90
C)SP DISTANCE	Adjusts the delay time of each speaker.	90
D)TEST TONE	Turns the test tone output on or off for the SPEAKER SET, SPEAKER LEVEL and SP DISTANCE setting.	91

Sound menu 2 SOUND MENU

Use this menu to manually adjust any speaker settings, alter the quality and tone of the sound output by the system or compensate for video signal processing delays when using LCD monitors or projectors.

Parameter	Features	Page
A)EQUALIZER	Adjusts the tonal quality of the center speaker.	91
B)LFE LEVEL	Adjusts the output level of the LFE channel for Dolby Digital or DTS signals.	92
C)DYNAMIC RANGE	Adjusts the dynamic range of Dolby Digital or DTS signals.	92
D)AUDIO SET	Adjusts the muting level, audio delay and tone bypass settings.	93
E)HDMI SET	Selects the component to play back HDMI audio signals.	93

Input menu 3 INPUT MENU

Use this menu to manually reassign the input/output jacks, select the input mode or rename the input source.

Parameter	Features	Page
A) I/O ASSIGNMENT	Assigns the input/output jacks of this unit according to the component to be used.	94
B) INPUT RENAME	Changes the name of the input source.	95
C) VOLUME TRIM	Adjusts the output volume of each jack.	96
D) DECODER MODE	Selects the input mode for the sources connected to the DIGITAL INPUT jacks on the rear panel of this unit.	96
E) MULTI CH SET	Adjusts the direction of the signals input into the center, subwoofer, and surround channels when a source component is connected to the MULTI CH INPUT jacks.	96

Option menu 4 OPTION MENU

Use this menu to manually adjust the optional system parameters.

Parameter	Features	Page
A) DISPLAY SET	Adjusts the brightness of the display and converts video signals.	97
B) MEMORY GUARD	Locks sound field program parameters and other "SET MENU" settings.	98
C) AUDIO SELECT	Initializes the parameters of a group of sound field programs.	99
D) DECODER MODE	Selects whether to initialize the settings or to recall the previous settings for the input mode selected in INPUT MENU.	99
E) PARAM. INI	Initializes the parameters of a group of sound field programs.	99
F) ZONE SET	Adjusts the Zone 2 and Zone 3 parameters.	99
G) XM RADIO SET	Displays the current reception level of XM Passport System.	100
H) DOCK SET	Selects whether this unit charges the battery of the connected iPod or not when this unit is in the standby mode.	100

Note

The "XM RADIO SET" parameter is only applicable to the U.S.A. and Canada models.

■ Signal information SIGNAL INFO

Use this feature to check audio signal information (see page 42).

Using SET MENU

Use the remote control to access and adjust each parameter.

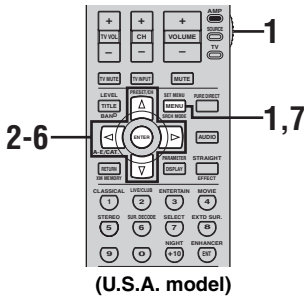

- You can change the “SET MENU” parameters while this unit is reproducing sound.
- If you press PARAMETER during the “SET MENU” operation, the “SET MENU” operation is canceled.
- Repeat the following procedure to select and adjust each parameter setting.
- Press RETURN or < to return to the previous menu level.

Note

You cannot change some “SET MENU” parameters when “NIGHT:CINEMA” or “NIGHT:MUSIC” is selected as the night listening mode (see page 53).

- 1 Set the operation mode selector to AMP and then press SET MENU to enter “SET MENU”.**
The top “SET MENU” display appears in the OSD.

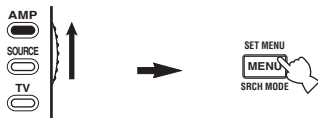

- 2 Press Δ / ∇ to select “MANUAL SETUP”.**

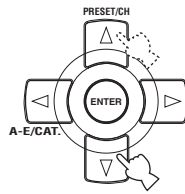

- 3 Press ENTER to enter “MANUAL SETUP”.**
The “MANUAL SETUP” display appears in the OSD.

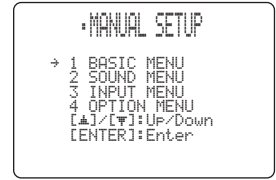
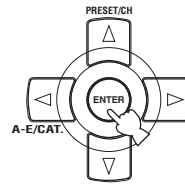

You can also press \triangleright to enter the selected menu item.

- 4 Press Δ / ∇ repeatedly and then press ENTER to select and enter the desired menu.**
The following displays are examples where “SOUND MENU” is selected.

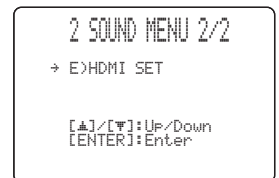
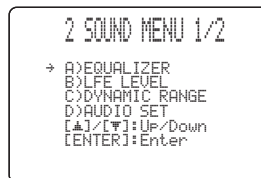
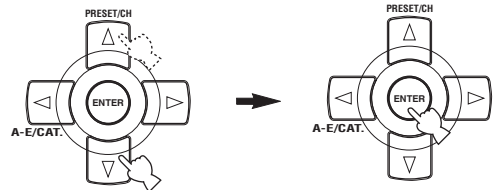

5 Press Δ / ∇ repeatedly and then press ENTER to select and enter the desired submenu.

The following display is an example where “LFE LEVEL” is selected.

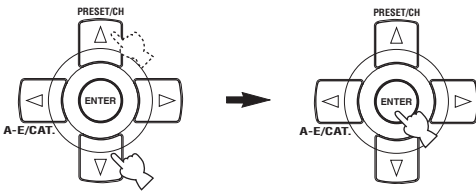

6 Press Δ / ∇ to select the desired parameter and then \triangleleft / \triangleright to change the parameter settings.

- Press \triangleright to increase the value.
- Press \triangleleft to decrease the value.

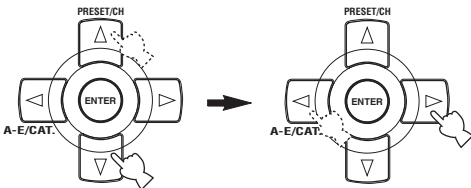

7 Press SET MENU to exit from “SET MENU”.



1 BASIC MENU

Use this menu to manually adjust any speaker settings.



Speaker settings A) SPEAKER SET

Use this feature to manually adjust any speaker settings.



- If you are not satisfied with the bass sounds from your speakers, you can change these settings according to your preference.
- When the diameter of the woofer section of the speaker unit is larger than 16 cm (6.5 in), set the correspondent speaker setting parameter to “LARGE” (or “LRG”).

LFE/Bass out LFE/BASS OUT

Use this feature to select the speakers that output the LFE (low-frequency effect) and the low-frequency signals.

Choices: SWFR, FRONT, **BOTH**

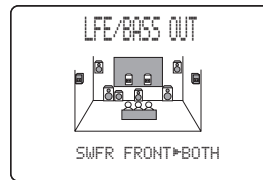

- Select “SWFR” (subwoofer) if you connected a subwoofer. The LFE signals as well as the low-frequency signals of other speakers set to “SML” (or “SMALL”) are directed to the subwoofer.
- Select “FRONT” (front) if you did not connect a subwoofer. The LFE signals, the low-frequency signals of the front left and right channels, and the low-frequency signals of other speakers set to “SML” (or “SMALL”) are all directed to the front left and right speakers regardless of the “FRONT SP” setting (see page 87).
- Select “BOTH” (both) if you connected a subwoofer. The low-frequency signals of any source are output from the subwoofer. The LFE signals as well as the low-frequency signals of other speakers set to “SML” (or “SMALL”) are directed to the subwoofer. The low-frequency signals of the front left and right channels are directed to the front left and right speakers and the subwoofer regardless of the “FRONT SP” setting (see page 87).

Front speakers FRONT SP

Choices: SMALL, **LARGE**

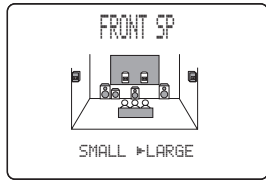

- Select “SMALL” (small) if you have small front speakers that do not reproduce low-frequency signals effectively. The low-frequency signals of the front left and right channels are directed to the speakers selected in “LFE/BASS OUT” (see page 87).
- Select “LARGE” (large) if you have large front speakers that reproduce low-frequency signals effectively. All the front left and right channel signals are directed to the front left and right speakers.

Notes

- When “LFE/BASS OUT” is set to “FRONT” (see page 87), the LFE signals found in Dolby Digital or DTS sources, the low-frequency signals of the front left and right channels, and the low-frequency signals of other speakers set to “SML” (or “SMALL”) are all directed to the front left and right speakers regardless of the “FRONT SP” setting.
- When “LFE/BASS OUT” is set to “FRONT” (see page 87), you can select only “LARGE” in “FRONT SP”. If the value of “FRONT SP” is set to other than “LARGE” in advance, this unit change the value to “LARGE” automatically.

Center speaker CENTER SP

Choices: NONE, **SML**, LRG

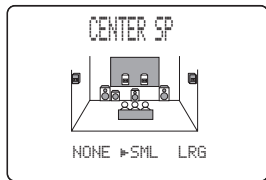

- Select “NONE” (none) if you did not connect a center speaker. The center channel signals are directed to the front left and right speakers.
- Select “SML” (small) if you have a small center speaker that does not reproduce low-frequency signals effectively. The low-frequency signals of the center channel are directed to the speakers selected in “LFE/BASS OUT”.
- Select “LRG” (large) if you have a large center speaker that reproduces low-frequency signals effectively. All the center channel signals are directed to the center speaker.

Surround left/right speakers SUR. L/R SP

Choices: NONE, **SML**, LRG

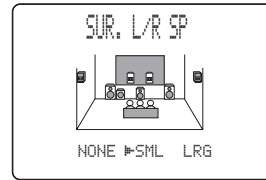

- Select “NONE” (none) if you did not connect surround speakers. This unit is set to the Virtual CINEMA DSP mode (see page 49) and “SUR. B L/R SP” is automatically set to “NONE”.
- Select “SML” (small) if you have small surround left and right speakers that do not reproduce low-frequency signals effectively. The low-frequency signals of the surround left and right channels are directed to the speakers selected in “LFE/BASS OUT”.
- Select “LRG” (large) if you have large surround left and right speakers that reproduce low-frequency signals effectively. All the surround channel signals are directed to the surround left and right speakers.

Surround back speakers SB L/R SP

Choices: NONE, SMLx1, **SMLx2**, LRGx1, LRGx2

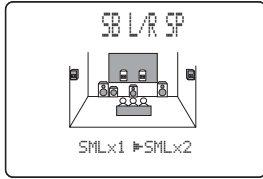

- Select “NONE” (none) if you did not connect surround back speakers. The surround back channel signals are directed to the surround left and right speakers.
- Select “SMLx1” (small x 1) if you have a small surround back speaker that does not reproduce low-frequency signals effectively. The low-frequency signals of the surround back left and right channels are directed to the speakers selected in “LFE/BASS OUT” and the rest of the signals are directed to the surround back left speaker.
- Select “SMLx2” (small x 2) if you have two small surround back speakers that do not reproduce low-frequency signals effectively. The low-frequency signals of the surround back left and right channels are directed to the speakers selected in “LFE/BASS OUT”.
- Select “LRGx1” (large x 1) if you have a large surround back speaker that reproduces low-frequency signals effectively. All the surround back left and right channel signals are directed to the surround back left speaker.
- Select “LRGx2” (large x 2) if you have two large surround back speakers that reproduce low-frequency signals effectively. All the surround back left and right channel signals are directed to the surround back left and right speakers.

Presence speakers PRESENCE SP

Use this feature if you want to use the presence speakers connected to this unit.

Choices: **NONE**, YES



- Select “NONE” (none) if you did not connect presence speakers.
- Select “YES” (yes) if you connected presence speakers and want to use them.

Bass cross over CROSS OVER

Use this feature to select the crossover frequency of all the speakers set to “SML” (or “SMALL”) or to “NONE” in “SPEAKER SET” (see pages 87 and 89). All frequencies below the selected frequency will be sent to the subwoofer or to the speakers set to “LRG” (or “LARGE”) in “SPEAKER SET” (see pages 87 and 89).

Choices: 40Hz, 60Hz, **80Hz**, 90Hz, 100Hz, 110Hz, 120Hz, 160Hz, 200Hz

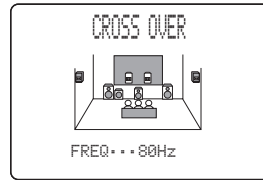

Subwoofer phase SUBWOOFER PHASE

Use this feature to switch the phase of your subwoofer if bass sounds are lacking or unclear.

Choices: **NORMAL**, REVERSE

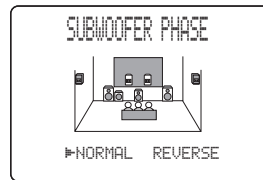

- Select “NORMAL” if you do not want to reverse the phase of your subwoofer.
- Select “REVERSE” to reverse the phase of your subwoofer.

Presence/Surround back channel priority PRIORITY

Use this feature to prioritize either the presence or the surround back speakers when playing sources that contain surround back channel signals using the CINEMA DSP sound field programs.

Choices: PRNS, **SB**

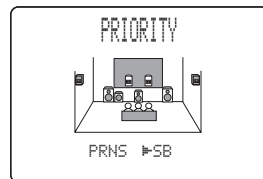

- Select “PRNS” to use the presence speakers even when surround back channel signals are input. The signals for the surround back channel will be output from the surround speakers.
- Select “SB” to use the surround back speakers when surround back channel signals are detected in a CINEMA DSP program. The presence channel signals are output from the front speakers.

■ Speaker level B)SP LEVEL

Use this feature to manually balance the speaker levels between the front left or surround left speakers and each speaker selected in "SPEAKER SET" (see page 87).

Control range: -10.0 to +10.0 dB

Control step: 0.5 dB

Initial setting:

FR. L/FR. R/SWFR/PR. L/PR. R: 0 dB

CENT./SUR. L/SUR. R/SB L/SB R: -1.0 dB

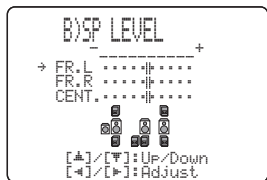

- Select "FR. L" to adjust the balance of the front left speaker.
- Select "FR. R" to adjust the balance of the front right speaker.
- Select "CENT." to adjust the balance of the center speaker.
- Select "SUR. L" to adjust the balance of the surround left speaker.
- Select "SUR. R" to adjust the balance of the surround right speaker.
- Select "SB L" to adjust the balance of the surround back left speaker.
- Select "SB R" to adjust the balance of the surround back right speaker.
- Select "SWFR" to adjust the balance of the subwoofer.
- Select "PR. L" to adjust the balance of the presence left speaker.
- Select "PR. R" to adjust the balance of the presence right speaker.

Notes

- "CENT.", "SUR. L", "SUR. R", "SB L", "SB R", "SWFR", "PR. L" and "PR. R" cannot be adjusted if "CENTER SP" (see page 88), "SUR. L/R SP" (see page 88), "SB.L/R SP" (see page 89), "LFE/BASS OUT" (see page 87) and "PRESENCE SP" (see page 89) are set to "NONE" respectively.
- Instead of "SB L" and "SB R", "SB" is displayed if "SB.L/R SP" is set to either "SMLx1" or "LRGx1" (see page 89).

■ Speaker distance C)SP DISTANCE

Use this feature to manually adjust the distance of each speaker and the delay applied to the respective channel. Ideally, each speaker should be the same distance from the main listening position. However, this is not possible in most home situations. Thus, a certain amount of delay must be applied to the sound from each speaker so that all sounds will arrive at the listening position at the same time.

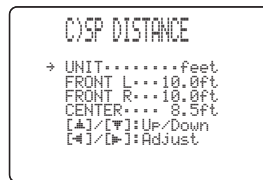

Unit UNIT

Choices: meters (m), feet (ft)

Initial setting:

[U.S.A. and Canada models]: feet (ft)

[Other models]: meters (m)

- Select "meters" to adjust speaker distances in meters.
- Select "feet" to adjust speaker distances in feet.

Speaker distances

Control range: 0.30 to 24.00 m (1.0 to 80.0 ft)

Control step: 0.10 m (0.5 ft)

Initial setting:

FRONT L/FRONT R/SWFR/PRNS L/

PRNS R: 3.00m (10.0ft)

CENTER: 2.60m (8.5ft)

SUR. L/SUR. R/SB L/SB R: 2.40m (8.0ft)

- Select "FRONT L" to adjust the distance of the front left speaker.
- Select "FRONT R" to adjust the distance of the front right speaker.
- Select "CENTER" to adjust the distance of the center speaker.
- Select "SUR. L" to adjust the distance of the surround left speaker.
- Select "SUR. R" to adjust the distance of the surround right speaker.
- Select "SB L" to adjust the distance of the surround back left speaker.
- Select "SB R" to adjust the distance of the surround back right speaker.
- Select "SWFR" to adjust the distance of the subwoofer.
- Select "PRNS L" to adjust the distance of the presence left speaker.
- Select "PRNS R" to adjust the distance of the presence right speaker.

Notes

- “CENTER”, “SUR. L”, “SUR. R”, “SB L”, “SB R”, “SWFR”, “PRNS L” and “PRNS R” cannot be adjusted if “CENTER SP” (see page 88), “SUR. L/R SP” (see page 88), “SUR. B L/R SP” (see page 89), “LFE/BASS OUT” (see page 87) and “PRESENCE SP” (see page 89) are set to “NONE” respectively.
- Instead of “SB L” and “SB R”, “SB” is displayed if “SUR. B L/R SP” is set to either “SMLx1” or “LRGx1” (see page 89).

■ **Test tone** D)TEST TONE

Turns the test tone output on or off for the SPEAKER SET, SP LEVEL and SP DISTANCE settings.

Choices: ON, **OFF**



If you use a handheld sound pressure level meter, hold at arm's length and point upwards so that the meter is in the listening position. With the meter set to the 70 dB scale and to C SLOW, calibrate each speaker to 75 dB.

Notes

- This function is automatically turned off if you exit “BASIC MENU”.
- If you select “ON” and enter the “SPEAKER SET”, “SP LEVEL” or “SP DISTANCE” menu, the test tone is output from the selected speakers.

2 SOUND MENU

Use to manually adjust speaker settings or compensate for video signal processing delays when using LCD monitors or projectors. Most of the SOUND MENU parameters are set automatically when you run AUTO SETUP (see page 32).

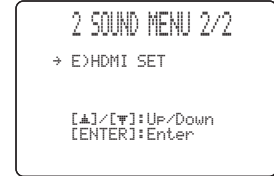
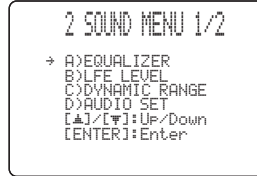

■ **Equalizer** A)EQUALIZER

Use this feature to select the parametric equalizer or the graphic equalizer.

Equalizer select SELECT

Use this feature to select the type of equalizer.

Choices: AUTO PEQ, **GEQ**, EQ OFF

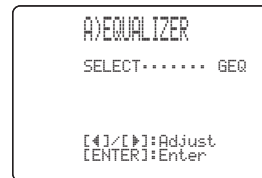

- Select “AUTO PEQ” to use the parametric equalizer adjusted in “AUTO SETUP” (see page 32).
- Select “GEQ” to adjust the built-in 7-frequency band graphic equalizer so that the tonal quality of the speaker matches. Press ENTER to display the graphic equalizer screen.
- Select “EQ OFF” to deactivate the equalizing feature.

Note

You can select “AUTO PEQ” only when you carry out “AUTO SETUP” in advance (see page 32). In this case, “AUTO PEQ” is automatically selected as the default setting.

Graphic equalizer GEQ

Use to match the tonal quality of the center, surround L/R and surround back L/R, surround back, presence L/R speakers and the subwoofer with that of the front L/R speakers. You can adjust 7 frequency bands (63Hz, 160Hz, 400Hz, 1kHz, 2.5kHz, 6.3kHz, 16kHz).
 Choices: -6.0 to +6.0 dB
 Control step: 0.5 dB

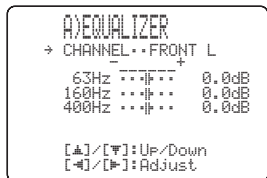

Press ▲ / ▼ to select a frequency band and ◀ / ▶ to adjust the selected frequency band.

Note

The “GEQ” parameter can be adjusted only when “GEQ” is selected in “SELECT”.

Test tone TEST TONE

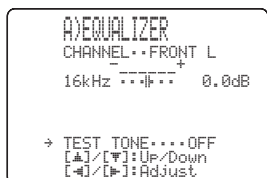

Use this feature to make adjustments of “GEQ” while listening to a test tone. To select “TEST TONE”, press ▼ repeatedly in the graphic equalizer screen.

Choices: **OFF**, **ON**

- Select “OFF” to stop test tones and output the currently selected source component.
- Select “ON” to output test tones from the selected speakers.

■ **Low-frequency effect level**

B)LFE LEVEL

Use this feature to adjust the output level of the LFE (low-frequency effect) channel according to the capacity of your subwoofer or headphones. The LFE channel carries low-frequency special effects which are only added to certain scenes. This setting is effective only when this unit decodes Dolby Digital or DTS signals.

Control range: -20 to 0 dB

Control step: 1 dB



Speaker SPEAKER

Adjusts the speaker LFE level.

Headphone HEADPHONE

Adjusts the headphone LFE level.

Note

Depending on the settings of “LFE/BASS OUT” (see page 87), some signals may not be output at the SUBWOOFER OUTPUT jack.

■ **Dynamic range** C)DYNAMIC RANGE

Use this feature to select the amount of dynamic range compression to be applied to your speakers or headphones. This setting is effective only when this unit is decoding Dolby Digital and DTS signals.

Choices: **MIN**, **STD**, **MAX**

- Select “MIN” (minimum) if you regularly listen at low volume levels.
- Select “STD” (standard) for general use.
- Select “MAX” (maximum) to preserve the greatest amount of dynamic range.

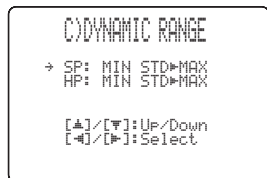

Speaker SP

Adjusts the speaker compression.

Headphone HP

Adjusts the headphone compression.

■ Audio settings D>AUDIO SET

Use this feature to adjust the overall audio settings of this unit.

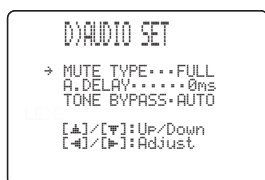

Muting type MUTING TYPE

Use this feature to adjust how much the mute function reduces the output volume (see page 41).

Choices: **FULL**, -20dB

- Select “FULL” to completely mute all the audio output.
- Select “-20dB” to reduce the current volume by 20 dB.

Audio delay AUDIO DELAY

Use this feature to delay the sound output and synchronize it with the video image. This may be necessary when using certain LCD monitors or projectors.

Control range: **0** to 240 ms

Control step: 1 ms

Tone bypass TONE BYPASS

Use this feature to select whether the audio output bypasses the tone control circuitry when “TREBLE” and “BASS” are set to 0 dB (see page 50).

Choices: **AUTO**, OFF

- Select “AUTO” if you want the signals to bypass the tone control circuitry to provide the purest signal possible.
- Select “OFF” if you do not want the signals to bypass the tone control circuitry.

■ HDMI set E>HDMI SET

Use this feature to select the component to play back HDMI audio signals.



Support audio SUPPORT AUDIO

Use to select whether to play back HDMI audio signals on this unit or on another HDMI component connected to the HDMI OUT jack on the rear panel of this unit.

Choices: **RX-V1700**, OTHER

- Select “RX-V1700” to play back HDMI audio signals on this unit. The HDMI audio signals input at the HDMI IN jacks of this unit are not output to the HDMI component connected to the HDMI OUT jack on the rear panel of this unit.
- Select “OTHER” to play back HDMI audio signals on another HDMI component connected to the HDMI OUT jack.

Note

The HDMI video signals input at the HDMI IN 1 or HDMI IN 2 jack of this unit are always output at the HDMI OUT jack of this unit.

3 INPUT MENU

Use this menu to reassign the input/output jacks, select the input mode or rename the input source.

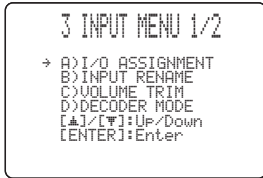

■ Input/output assignment

A) I/O ASSIGNMENT

Use this feature to assign the input/output jacks according to the component to be used if the initial settings of this unit do not correspond to your needs. Change the following parameters to reassign the respective jacks and effectively connect more components.

Once the input/output jacks are reassigned, you can select the corresponding component by using the INPUT selector on the front panel (or the input selector buttons on the remote control).



The input source name in parentheses indicates the default assigned input source.

For COMPONENT VIDEO jacks A, B and C

COMPNT-V IN

- Choices: [A] **DVD**, DTV, CBL/SAT, VCR 1, DVR/VCR 2, V-AUX
 [B] DVD, **DTV**, CBL/SAT, VCR 1, DVR/VCR 2, V-AUX
 [C] DVD, DTV, **CBL/SAT**, VCR 1, DVR/VCR 2, V-AUX

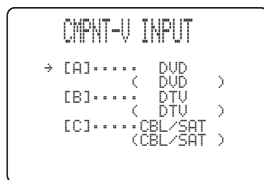

For COAXIAL INPUT jacks 1, 2 and 3

COAXIAL IN

- Choices: (1) MD/TAPE, CD-R, **CD**, PHONO, DVD, DTV, CBL/SAT, VCR 1, DVR/VCR 2, V-AUX, MULTI CH
 (2) MD/TAPE, CD-R, CD, PHONO, **DVD**, DTV, CBL/SAT, VCR 1, DVR/VCR 2, V-AUX, MULTI CH
 (3) MD/TAPE, CD-R, CD, PHONO, DVD, DTV, CBL/SAT, VCR 1, **DVR/VCR 2**, V-AUX, MULTI CH

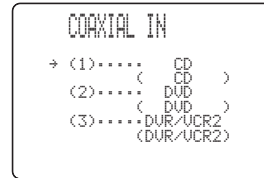

For OPTICAL INPUT jacks 4, 5, 6 and 7

OPTICAL IN

- Choices: (4) MD/TAPE, CD-R, **CD**, PHONO, DVD, DTV, CBL/SAT, VCR 1, DVR/VCR 2, MULTI CH
 (5) MD/TAPE, CD-R, CD, PHONO, **DVD**, DTV, CBL/SAT, VCR 1, DVR/VCR 2, MULTI CH
 (6) MD/TAPE, CD-R, CD, PHONO, DVD, **DTV**, CBL/SAT, VCR 1, DVR/VCR 2, MULTI CH
 (7) MD/TAPE, CD-R, CD, PHONO, DVD, DTV, **CBL/SAT**, VCR 1, DVR/VCR 2, MULTI CH

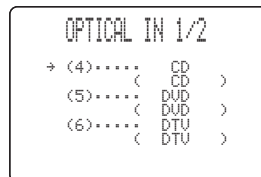

For OPTICAL OUTPUT jacks 8 and 9

OPTICAL OUT

- Choices: (8) **MD/TAPE**, CD-R, CD, PHONO, DVD, DTV, CBL/SAT, VCR 1, DVR/VCR 2, V-AUX
 (9) MD/TAPE, **CD-R**, CD, PHONO, DVD, DTV, CBL/SAT, VCR 1, DVR/VCR 2, V-AUX

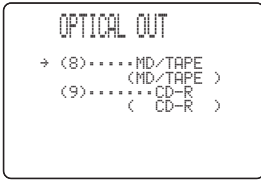

Notes

- You cannot select a specific item more than once for the same type of jack.
- When you connect a component to both the DIGITAL INPUT (COAXIAL) and DIGITAL INPUT (OPTICAL) jacks, priority is given to the signals input at the DIGITAL INPUT (COAXIAL) jack.

For HDMI IN jacks 1 and 2 HDMI IN

- Choices: [IN1] **DVD**, DTV, CBL/SAT, VCR 1, DVR/VCR 2, V-AUX
 [IN2] DVD, DTV, **CBL/SAT**, VCR 1, DVR/VCR 2, V-AUX

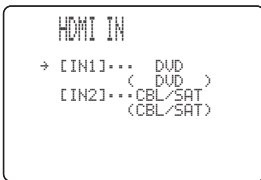

Input rename B) INPUT RENAME

Use this feature to change the name of the input source that appears in the OSD and in the front panel display.

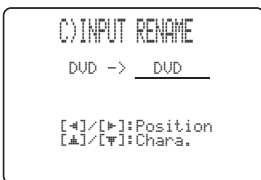

- This feature is useful when you change the input or output assignment for digital jacks and component video input jacks.
- You can also change the name of the input source that appears in the display window on the remote control. Refer to “Changing source names in the display window” on page 106”.

- 1 Press one of the input selector buttons on the remote control to select the input source you want to change the name of.

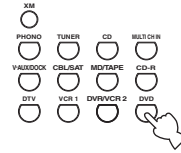

- 2 Press ◀/▶ on the remote control to place the “_” (underscore) under the space or the character you want to edit.

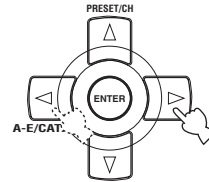

- 3 Press ▲/▼ to select the character you want to use and then press ◀/▶ to move to the next space.

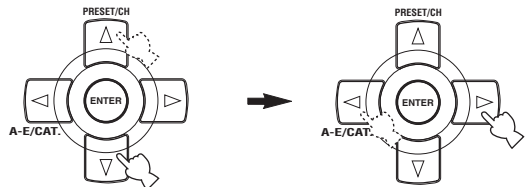

Notes

- You can use up to 8 characters for each input.
- Press ▼ to change the character in the following order, or press ▲ to go in the reverse order:
 A to Z, 0 to 9, a to z, symbols (#, *, -, +, etc.), space.

- 4 Repeat steps 1 through 3 to rename each input source.

- 5 Press SET MENU on the remote control to exit from “INPUT RENAME”.



■ **Volume Trim** C>VOLUME TRIM

Use this feature to adjust the level of the signal input at each jack. This is useful if you want to balance the level of each input source to avoid sudden changes in volume when switching between input sources.

Choices: XM, TUNER, PHONO, CD, CD-R, MD/TAPE, DVD, DTV, CBL/SAT, VCR 1, DVR/VCR 2, V-AUX, DOCK, MULTI CH

Control range: -6.0 to +6.0 dB

Control step: 0.5 dB

Initial setting: 0.0 dB

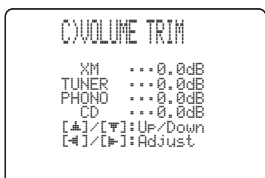

This parameter also affects the signals output at ZONE OUT jacks.

■ **Decoder mode** D>DECODER MODE

Use to switch the input mode. You can designate the reassigned digital input jacks for specific audio signals (DTS, etc.).

Choices: **AUTO**, DTS

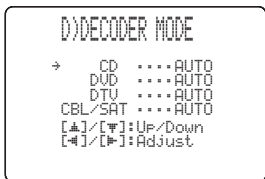

- Select "AUTO" if you want this unit to automatically detect input signal types and select the appropriate input mode.
- Select "DTS" if you want this unit to select DTS as the input mode.

■ **Multi channel input Setup**

E>MULTI CH SET

Use to set the direction of the signals input into the center, subwoofer and surround channels when a source component is connected to the MULTI CH INPUT jacks. If you input 8-channel signals from an external decoder, use this feature to select jacks for the additional front signals.

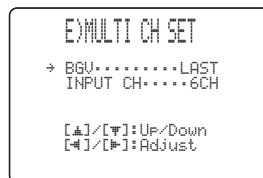

BGV BGV

Use this feature to select the video source played in the background of the sources input from the MULTI CH INPUT jacks.

Choices: DVD, DTV, CBL/SAT, VCR, DVR/VCR 2, V-AUX, **LAST**, OFF

- Select "LAST" to set this unit to automatically select the last selected video source as the background video source.
- Select "OFF" to set this unit not to play the video source in the background.

Input channels INPUT CH

Use this setting to select the number of channels input from an external decoder.

Choices: **6CH**, 8CH

- Select "6CH" if you input 6-channel signals.
- Select "8CH" if you input 8-channel signals.

Note

If "ZONE2 AMP" is set to "[SP1]", "[SP2]" or "BOTH" (see page 100), no sound is output from the surround back speakers even if you select "8CH". In this case, select "6CH" and set the output setting of the external component to 6 channels.

Front input FRONT

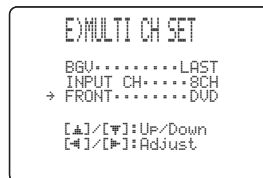

If you selected 8ch in "INPUT CH", you can select the analog jacks at which the front signals from an external decoder will be input.

Choices: MD/TAPE, CD-R, CD, **DVD**, DTV, CBL/SAT, VCR1, DVR/VCR2, V-AUX

Note

"FRONT" parameter appears only when you set "INPUT CH" to "8CH".

4 OPTION MENU

Use this menu to adjust the optional system parameters.

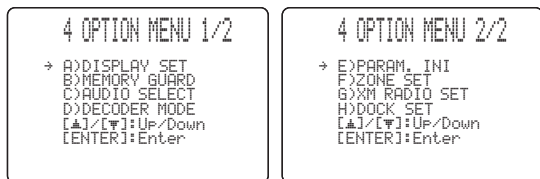

■ Display settings A)DISPLAY SET

Note

Use the “V-RESET” in “ADVANCED SETUP” to set the parameters in “DISPLAY SET” (except “DIMMER”, “SHORT MESSAGE”, “ON SCREEN” and “FL SCROLL”) to the factory presets (see page 119).

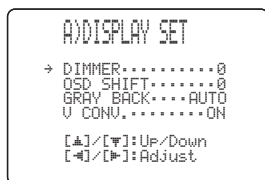

Dimmer DIMMER

Use this feature to adjust the brightness of the front panel display.

Control range: -4 to 0

Control step: 1

- Press ◀ to make the front panel display dimmer.
- Press ▶ to make the front panel display brighter.

OSD shift OSD SHIFT

Use this feature to adjust the vertical position of the OSD.

Control range: -5 (upward) to +5 (downward)

Control step: 1

Initial setting: 0

- Press ◀ to raise the position of the OSD.
- Press ▶ to lower the position of the OSD.

Gray back GRAY BACK

Use this feature to display a gray background in your video monitor when there is no video signal being input.

Choices: **AUTO**, **OFF**

- Select “AUTO” to display a gray background in your video monitor when there is no video signal being input.
- Select “OFF” not to display a gray background in your video monitor.

Notes

- Depending on the video signals being input or the system setting of your video monitor (NTSC or PAL), the OSD may be displayed abnormally. In such cases, set “GRAY BACK” to “OFF”.
- Even when “GRAY BACK” is set to “OFF”, the OSD may not be displayed correctly depending on the conditions of the picture.

Video conversion V CONV.

Use this feature to set whether to convert the video signals input at the VIDEO, S VIDEO and COMPONENT VIDEO jacks.

Choices: **ON**, **OFF**

- Select “ON” to convert composite, S-video and component video signals interchangeably and up-convert composite and S-video and component video signals to HDMI video signals.
- Select “OFF” not to convert any signals.

Notes

- This unit does not convert 480 line video signals and 576 line video signals interchangeably.
- The analog component video signals with 480i (NTSC)/576i (PAL) of resolution are converted to the s-video or composite video signals and output at the S VIDEO MONITOR OUT and VIDEO MONITOR OUT jacks.
- The converted video signals are only output at the MONITOR OUT jacks. When recording a video source, you must make the same type of video connections between each component.
- When composite video or S-video signals from a VCR are converted to component video signals, the picture quality may suffer depending on your VCR.
- Set “V CONV.” to “ON” to display the sound field parameter display and short message display.
- Unconventional signals input at the composite video or S-video jacks cannot be converted or may be output abnormally. In such cases, set “V CONV.” to “OFF”.
- When non-standard video signals (such as video signals from a game console) are input, this unit may not convert the signals even if you set “V CONV.” to “ON”.

Component interlace/progressive up-conversion

CMPNT I/P

Use this feature to activate or deactivate the analog interlace/progressive conversion of the analog video signals input at the composite video, S-video and component video jacks so that the analog video signals deinterlaced from 480i (NTSC)/576i (PAL) to 480p/576p are output at the COMPONENT MONITOR OUT jacks.

Choices: **ON**, **OFF**

- Select “ON” to activate the analog interlace/progressive up-conversion of the analog video signals.
- Select “OFF” to deactivate the analog interlace/progressive up-conversion of the analog video signals.

Notes

- This menu item is not available and hence not visible in the OSD if “V CONV.” is set to “OFF”.
- If your video monitor does not support analog video signals with 480p/576p of resolution, the SET MENU items may not be displayed on your video monitor when “CMPNT I/P” is set to “ON”. Use “V-RESET” in “ADVANCED SETUP” to set the “CMPNT I/P” parameter to the factory preset setting (see page 119).

HDMI interlace/progressive up-conversion

HDMI I/P

Use this feature to activate or deactivate the HDMI interlace/progressive up-conversion of the analog video signals input at the composite video, S-video and component video jacks so that the analog video signals deinterlaced from 480i (NTSC)/576i (PAL) to 480p/576p are output at the HDMI OUT jack.

Choices: **ON**, **OFF**

- Select “ON” to activate the HDMI interlace/progressive up-conversion of the analog video signals.
- Select “OFF” to deactivate the HDMI interlace/progressive up-conversion of the analog video signals.

Notes

- This menu item is not available and hence not visible in the OSD if “V CONV.” is set to “OFF”.
- When analog video signals with 1080i or 720p of resolution are up-converted to HDMI and output at the HDMI OUT jack, the picture quality may worsen.

Short message display

SHORT MESSAGE

Use this feature to activate or deactivate the short message display function.

Choices: **ON**, **OFF**

- Select “ON” to activate the short message display function. The contents of the front panel display appear at the bottom of the screen each time you operate this unit.
- Select “OFF” to deactivate the short message display function.

Note

The short message display does not appear in the following cases:

- when the component video signals with 480p/576p, 720p, 1080i or 1080p resolutions are input
- When HDMI video signals are input

On-screen display time ON SCREEN

Use this feature to set the amount of time to display the XM Satellite Radio information or iPod menu in the OSD after you perform a certain operation.

Choices: **ALWAYS**, **10SEC**, **30SEC**

- Select “ALWAYS” to display the OSD unceasingly during an operation.
- Select “10SEC” to turn off the OSD 10 seconds after you perform a certain operation.
- Select “30SEC” to turn off the OSD 30 seconds after you perform a certain operation.

Front panel display scroll FL SCROLL

Use this feature to set whether to display the information (such as song title or channel name) in the front panel display in a continuous manner or by the first 14 alphanumeric characters after scrolling all characters once when “XM” or “DOCK” is selected as the input source.

Choices: **CONT**, **ONCE**

- Select “CONT” to display the operation status in the front panel display in a continuous manner.
- Select “ONCE” to display the operation status in the front panel display by the first 14 alphanumeric characters after scrolling all characters once.

Memory guard B)MEMORY GUARD

Use this feature to prevent accidental changes to DSP program parameter values and other system settings.

Choices: **OFF**, **ON**



- Select “OFF” to turn off the “MEMORY GUARD” feature.
- Select “ON” to protect:
 - DSP sound field program parameters
 - all “SET MENU” items
 - all speaker levels

Note

When “MEMORY GUARD” is set to “ON”, you cannot select and adjust any other “SET MENU” items.

■ **Audio select** C)AUDIO SELECT

Use this feature to designate the default input mode for the input sources connected to the DIGITAL INPUT jacks when you turn on the power of this unit.

Choices: **AUTO**, **LAST**



- Select “AUTO” if you want this unit to automatically detect the type of input signals and select the appropriate input mode.
- Select “LAST” if you want this unit to automatically select the last input mode used for the connected input source.

Note

Selecting “LAST” does not recall the last setting for the EXT.D SUR. button on the remote control.

■ **Decoder mode** D)DECODER MODE

Use this feature to designate the default decoder mode for the input sources connected to the DIGITAL INPUT jacks when you turn on the power of this unit.

Choices: **AUTO**, **LAST**



- Select “AUTO” to if you want this unit to automatically detect the type of input signals and select the appropriate decoder mode.
- Select “LAST” to if you want this unit to automatically select the last decoder mode used the connected input source.

Note

Selecting “LAST” does not recall the last setting for the EXT.D SUR. button on the remote control.

■ **Parameter initialization** E)PARAM. INI

Use this feature to initialize the parameters of each sound field program within a sound field program group. When you initialize a sound field program group, all of the parameter values within that group revert to their initial factory settings.

Press the corresponding sound field program selector buttons on the remote control to select the sound field program that you want to initialize.

An asterisk (*) appears to the left of the sound field program names that have been changed from their initial factory settings.

Choices: **CLASSICAL**, **LIVE/CLUB**, **ENTERTAINMENT**, **MOVIE**, **STEREO**, **SURROUND DECODE**



Notes

- You cannot automatically revert to the previous parameter settings once you initialize a sound field program group.
- You cannot separately initialize individual sound field programs.
- You cannot initialize any sound field program groups when “MEMORY GUARD” is set to “ON” (see page 98).

■ **Zone set** F)ZONE SET

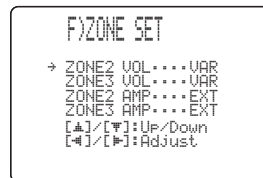

Zone 2 volume ZONE2 VOL

Zone 3 volume ZONE3 VOL

Use to select how the volume control will operate with regard to the ZONE 2 OUTPUT or ZONE 3 OUTPUT jacks.

Choices: **VAR**, **FIX**

- Select “VAR” to adjust the ZONE 2 OUTPUT or ZONE 3 OUTPUT volume simultaneously with VOLUME +/- on the remote control.
- Select “FIX” to fix the ZONE 2 OUTPUT or ZONE 3 OUTPUT volume level to a standard line level.

Zone 2 amplifier ZONE2 AMP

Zone 3 amplifier ZONE3 AMP

Use to select how the ZONE 2 and/or ZONE 3 speakers are amplified.

Choices: **EXT**, [SP1], [SP2], BOTH

- Select “EXT” if you want to connect your Zone 2 or Zone 3 speakers through an external amplifier connected to the ZONE 2 OUTPUT or ZONE 3 OUTPUT jacks on the rear panel of this unit.
- Select “[SP1]” to use the internal surround back amplifier of this unit when you want to connect your Zone 2 or Zone 3 speakers directly to the SP1 speaker terminals on the rear panel of this unit.
- Select “[SP2]” to use the internal surround amplifier of this unit when you want to connect your Zone 2 or Zone 3 speakers directly to the SP2 speaker terminals on the rear panel of this unit.
- Select “BOTH” to use the internal surround and surround back amplifiers of this unit when you want to connect your Zone 2 or Zone 3 speakers directly to both the SP1 and the SP2 speaker terminals on the rear panel of this unit.

Notes

- When “BI-AMP” is set to “ON” in the “ADVANCED SETUP” menu, “[SP1]”, “[SP2]” and “BOTH” cannot be selected.
- When “BOTH” is selected for “ZONE2 AMP”, only “EXT” can be selected for “ZONE3 AMP”.
- When “BOTH” is selected for “ZONE3 AMP”, only “EXT” can be selected for “ZONE2 AMP”.
- When you set “ZONE2 AMP” or “ZONE3 AMP” to “[SP1]” or “[SP2]” and the corresponding zone is turned on, no sound is output from the surround back speakers.
- When you set “ZONE2 AMP” or “ZONE3 AMP” to “BOTH” and the corresponding zone is turned on, no sound is output from both the surround speakers and the surround back speakers in the main zone.
- When both “ZONE2 AMP” and “ZONE3 AMP” are set to “[SP1]” or “[SP2]” and Zone 2 and Zone 3 are turned on, no sound is output from both the surround speakers and the surround back speakers in the main zone.
- When you use internal amplifiers for Zone 2 or Zone 3, some surround field programs may not work in the same way as when you do not use the internal amplifiers for Zone 2 or Zone 3.

■ **XM Radio setting** G>XM RADIO SET
(U.S.A. and Canada models only)



XM Radio antenna XM ANTENNA

Use this feature to check the current reception level of the XM Passport System connected to the XM jack of this unit (see page 61). For the best reception, orient the XM Passport System so that a value of 60% or more is displayed here.

Display status: NONE, 0 to 100%

Notes

- “NONE” is displayed if the XM Passport System is not connected to this unit. In this case, check the antenna connections (see page 61).
- The “XM ANTENNA” parameter cannot be adjusted by using the remote control. Instead, you need to adjust the orientation of the XM Passport System connected to the XM jack of this unit for a better percentage of the reception level.

■ **Dock set** H>DOCK SET

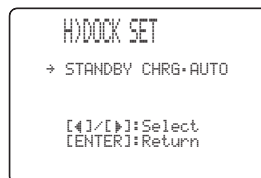

Charge on standby STANDBY CHRG

Use this feature to select whether this unit charges the battery of the stationed iPod or not when this unit is in the standby mode (see page 73).

Choices: **AUTO**, OFF

- Select “AUTO” to charge the battery of the stationed iPod when this unit is turned on and in the standby mode.
- Select “OFF” to charge the battery of the stationed iPod only when this unit is turned on.

REMOTE CONTROL FEATURES

In addition to controlling this unit, the remote control can also operate other audiovisual components made by YAMAHA and other manufacturers. To control your TV or other components, you must set up the appropriate remote control code for each input source (see page 103).

Controlling this unit, a TV, or other components

■ Controlling this unit

Set the operation mode selector to AMP to control this unit (see page 6).

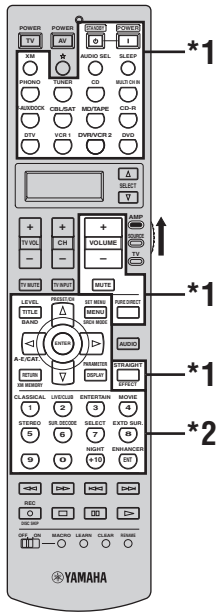

(U.S.A. model)

Notes

- *1 These buttons always control this unit regardless of the operation mode selector position.
- *2 These buttons control this unit only when the component operation mode selector is set to AMP.

■ Controlling a TV

Set the operation mode selector to TV to control your TV. To control your TV, you must set the appropriate remote control code for DTV or PHONO (see page 103). When you set the remote control codes for both DTV and PHONO, priority is given to the one set for DTV.

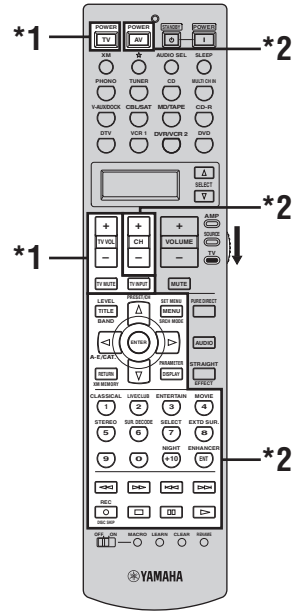

(U.S.A. model)

Notes

- *1 These buttons always control your TV regardless of the operation mode selector position.

Remote control	Digital TV/Cable TV
TV POWER	Turns on or off the power.
TV VOL +/-	Increases or decreases the volume level.
TV MUTE	Mutes the audio output.
TV INPUT	Changes the input source.

- *2 These buttons control your TV only when the operation mode selector is set to TV. For details, see the "TV" column on page 102.

Controlling other components

Set the operation mode selector to SOURCE to control other components selected with the input selector buttons or ☆. You must set the appropriate remote control code for each input source in advance (see page 103). The following table shows the function of each control button used to control other components assigned to each input selector button or ☆. Be advised that some buttons may not correctly operate the selected component.



The remote control has 14 modes (input areas) to control components so that the remote control can operate up to 14 different components.

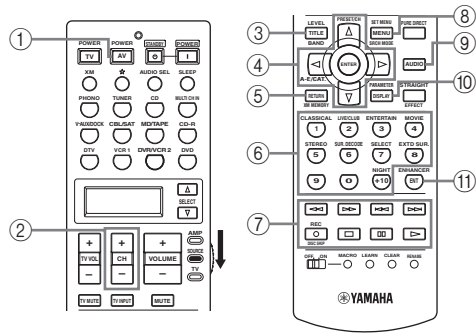

(U.S.A. model)

	DVD player/ DVD recorder	VCR	Cable TV/ Satellite tuner	TV	LD player	CD player	MD recorder/ CD recorder	Tape deck	Tuner	iPod
① AV POWER	Power *1	Power *1	Power *1	VCR power *2	Power *1	Power *1	Power *1	Power *1	Power *1	
② CH +	TV channel up*3	Channel up	Channel up	Channel up	TV channel up*3	TV channel up*3	TV channel up*3	TV channel up*3	TV channel up*3	TV channel up*3
CH -	TV channel down*3	Channel down	Channel down	Channel down	TV channel down*3	TV channel down*3	TV channel down*3	TV channel down*3	TV channel down*3	TV channel down*3
③ TITLE	Title	Title	Title	Title					Band	
④ ENTER	Menu enter		Menu select	Menu select						Subsequent menu
PRESET/CH Δ	Menu up		Menu up	Menu up					Preset up (1 to 8)	Up
PRESET/CH ∇	Menu down		Menu down	Menu down					Preset down (1 to 8)	Down
A-E/CAT. ◀	Menu left		Menu left	Menu left					Preset down (A to E)	Previous menu
A-E/CAT. ▶	Menu right		Menu right	Menu right				Direction A/B	Preset up (A to E)	Subsequent menu
⑤ RETURN	Return	Return	Return	Return						
⑥ 1-9, 0, +10	Numeric buttons	Numeric buttons	Numeric buttons	Numeric buttons	Numeric buttons	Numeric buttons	Numeric buttons			
⑦ ◀◀	Search backward	Search backward	VCR search backward *2	VCR search backward *2	Search backward	Search backward	Search backward	Search backward		Search backward*4
▶▶	Search forward	Search forward	VCR search forward *2	VCR search forward *2	Search forward	Search forward	Search forward	Search forward		Search forward*4
◀◀	Skip backward				Chapter/Skip backward	Skip backward	Skip backward	Direction back		Skip backward
▶▶	Skip forward				Chapter/Skip forward	Skip forward	Skip forward	Direction forward		Skip forward
REC/ DISC SKIP	Disc skip (player) Rec (recorder)	Rec	VCR rec *2	VCR rec *2		Disc skip	Rec	Rec		
□	Stop	Stop	VCR stop *2	VCR stop *2	Stop	Stop	Stop	Stop		Stop
⏸	Pause	Pause	VCR pause *2	VCR pause *2	Pause	Pause	Pause	Pause		Pause (Play/Pause)*5
▶	Play	Play	VCR play *2	VCR play *2	Play	Play	Play	Play		Play (Play/Pause)*5
⑧ MENU	Menu		Menu	Menu						Previous menu
⑨ AUDIO	Audio				Audio					
⑩ DISPLAY	Display		Display	Display	Display	Display	Display			Display
⑪ ENT		Enter	Enter/recall	Enter						

Notes

- *1 This button is operational only when the original remote control supplied with the component has a POWER button.
- *2 These buttons operate your VCR only when you set the appropriate remote control code for VCR 1 (see page 103).
- *3 These buttons control your TV only when the operation mode selector is set to TV. For details, see the “TV” column on page 102.
- *4 Press and hold to search backward or forward.
- *5 Simple remote mode (see page 73)

■ Selecting a component to be controlled

You can select a component to be controlled independently of the input source selected with the input selector buttons.

Press **SELECT** Δ / ∇ repeatedly to select the desired component.

The name of the component to be controlled appears in the display window on the remote control.



■ Controlling optional components (Option mode)

“OPTN” is an optional component control area that can be programmed with remote control functions independently from any input source. This area is useful for programming commands that are to be used only as a part of a macro function or for components that do not have a valid remote control code.

To select the option mode, press **SELECT** ∇ repeatedly until “OPTN” appears in the display window on the remote control.



Note

You cannot set a remote control code for the optional area. See page 105 to program buttons operated within this component control area.

Setting remote control codes

You can control other components by setting the appropriate remote control codes. Codes can be set up for each input area. For a complete list of available remote control codes, refer to “LIST OF REMOTE CONTROL CODES” at the end of this manual.

The following table shows the default component (Library: component category) and the remote control code for each input area.

Remote control code default settings

Input area	Library (component category)	Manufacturer	Default code
XM	TUNER	YAMAHA	2604
☆	TUNER	YAMAHA	2607
PHONO	TV	-	-
TUNER	TUNER	YAMAHA	2602
CD	CD	YAMAHA	2300
MULTI CH INPUT	DVD	YAMAHA	2100
V-AUX/DOCK	TUNER	YAMAHA	2606
CBL/SAT	CABLE	-	-
MD/TAPE	MD	YAMAHA	2500
CD-R	CD-R	YAMAHA	2400
DTV	TV	-	-
VCR 1	VCR	-	-
DVR/VCR2	DVR	YAMAHA	2807
DVD	DVD	YAMAHA	2100

Note

You may not be able to operate your YAMAHA component even if a YAMAHA remote control code is preset as listed above. In this case, try setting another YAMAHA remote control code.

- 1 Set the operation mode selector to **SOURCE** and then press an input selector button or ☆ to select the input area you want to set up.

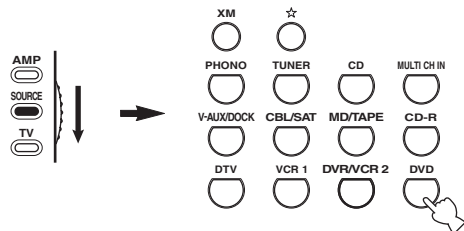

2 Press and hold LEARN for about 3 seconds using a ballpoint pen or similar object.

The library name (ex. L;DVD) and the name of the selected input area (ex. DVD) appear alternately in the display window on the remote control.

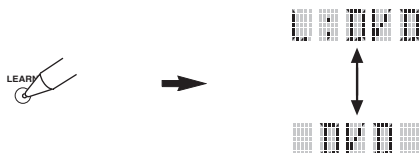

- You can set a remote control code of a different type of component to an input area. Press <Left>/<Right> repeatedly to change the library (component category).

Library choices: L;DVD, L;DVR, L;LD, L;CD, L;CDR, L;MD, L;TAP (tape), L;TUN (tuner), L;AMP, L;TV, L;CAB (cable), L;SAT (satellite), L;VCR

- If you want to setup for another input area, press the input selector button or ☆, or press SELECT Δ/∇ repeatedly to select the input area.

Notes

- Be sure to press and hold LEARN for at least 3 seconds, otherwise the learning process will start.
- If you do not complete each of the following steps within 30 seconds, the setting mode will be automatically canceled. In this case, start over from step 2.

3 Press ENTER.

The four-digit code set for the selected component appears in the display window.

Note

0000 appears in the display window if no code has been set.

4 Press the numeric buttons to enter the four-digit remote control code for the component you want to use.

For a complete list of available remote control codes, refer to “LIST OF REMOTE CONTROL CODES” at the end of this manual.

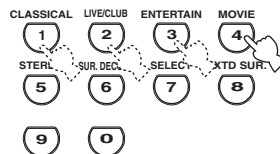

5 Press ENTER to set the number.

“OK” appears in the display window on the remote control if setting was successful.

“NG” appears in the display window on the remote control if the setting was unsuccessful. In this case, start over from step 3.



If you continuously want to set up another code for another component, press the input selector button or ☆, or SELECT Δ/∇ repeatedly to select the component, then repeat steps 2 through 5.

6 Press LEARN again to exit from the setup mode.



7 Press <Right> or AV POWER to confirm whether you can control your component using the remote control.

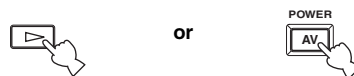

If operation is not possible and the manufacturer of your component has more than one code, try each of them until you find the correct one.

Notes

- “ERROR” appears in the display window on the remote control if you press a button not indicated in the respective step, or when you press more than one button simultaneously.
- The supplied remote control does not contain all possible codes for commercially available audio and video components (including YAMAHA components). If operation is not possible with any of the remote control codes, program the new remote control function using the learn feature (see “Programming codes from other remote controls”) or use the remote control supplied with the component.
- Functions programmed using the learn feature take priority over remote control code functions.

Programming codes from other remote controls

You can program remote control codes from other remote controls. Use the learn feature if you want to program functions not included in the basic operations covered by the remote control codes, or an appropriate remote control code is not available. You can program the function of other remote control to the buttons in the highlighted areas in the following illustration. The buttons can be programmed independently for each input area.

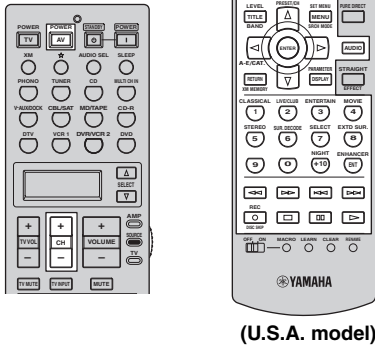

Note

The remote control transmits infrared rays. If the other remote control also uses infrared rays, this remote control can learn most of its functions. However, you may not be able to program some special signals or extremely long transmissions. Refer to the operating instructions for the other remote control.

- 1 Set the operation mode selector to SOURCE and then press an input selector button or ☆ to select an input area.**

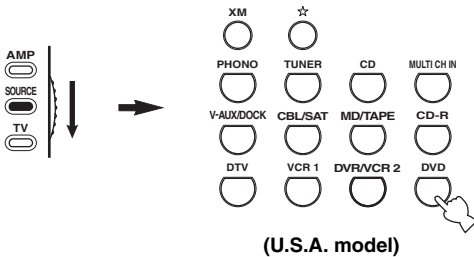

Note

Make sure that the operation mode selector is set to SOURCE. When you set the operation mode selector to AMP and program a remote control codes from other remote controls, the programmed key cannot operate the amplifier function of this unit.

- 2 Place this remote control about 5 to 10 cm (2 to 4 in) apart from the other remote control on a flat surface so that their infrared transmitters are aimed at each other.**

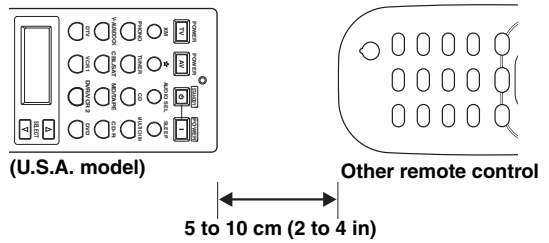

- 3 Press LEARN using a ballpoint pen or similar object.**

“LEARN” and the name of the selected input area (ex. “DVD”) appear alternately in the display window on the remote control.

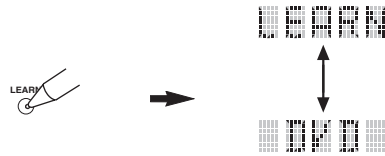

Notes

- Do not press and hold LEARN. If you hold it down for more than 3 seconds, the remote enters the remote control code setting mode.
- If you do not complete each of the following steps within 30 seconds, the learning mode will be automatically canceled. In this case, start over from step 3.

- 4 Press the button for which you want to program the new function.**
“LEARN” appears in the display window on the remote control.

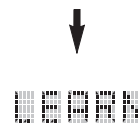
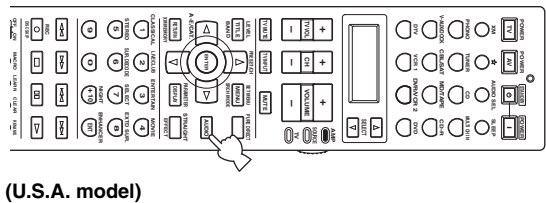

5 Press and hold the button you want to program on the other remote control until “OK” appears in the display window on the remote control.

“NG” appears in the display window on the remote control if learning was unsuccessful. In this case, start over from step 4.

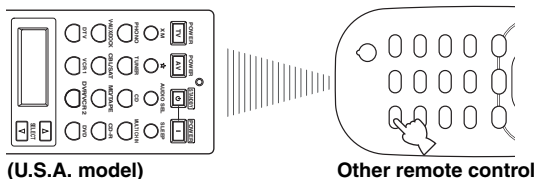

- If you want to program another function, repeat steps 4 and 5.
- If you continuously want to program another function for another component, press SELECT Δ / ∇ to select the component, and then repeat steps 4 and 5.

6 Press LEARN again to exit the learning mode.



Notes

- “ERROR” appears in the display window on the remote control if you press a button not indicated in the respective step, or when you press more than one button simultaneously.
- This remote control can learn approximately 200 functions. However, depending on the signals learned, “FULL” may appear in the display before you program 200 functions. In this case, clear unnecessary programmed functions to make room for further learning.
- Learning may not be possible in the following cases:
 - when the batteries in the remote control for this unit or other components are weak.
 - when the distance between the two remote controls is too great or too small.
 - when the remote control infrared windows are not facing each other at the appropriate angle.
 - when the remote control is exposed to direct sunlight.
 - when the function to be programmed is continuous or uncommon.

Changing source names in the display window

You can change the name of the input source that appears in the display window on the remote control if you want to use a different name than the factory preset. This feature is useful when you have set an input area to control a different component.

1 Set the operation mode selector to AMP or SOURCE and then press an input selector button or ☆ to select the input area you want to rename.

The name of the selected input area appears in the display window.

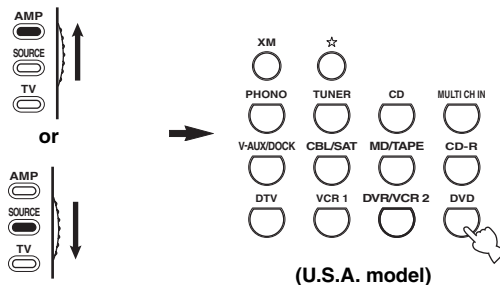

(U.S.A. model)

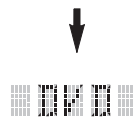

2 Press RENAME using a ballpoint pen or similar object.



Note

If you do not complete each of the following steps within 30 seconds, the renaming mode will be automatically canceled. In this case, start over from 2.

3 Press Δ / ∇ to select and enter a character.

Pressing ∇ changes the character as follows:
 A to Z, 1 to 9, 0, + (plus), - (hyphen), ; (semicolon), / (slash), and space.
 Pressing Δ changes the characters in reverse order.

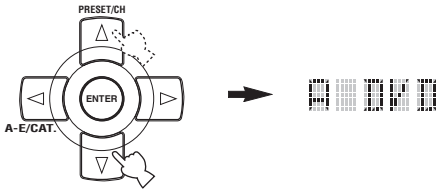

4 Press \triangleright to move the cursor to the next position.

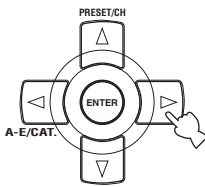

 Press \triangleleft to move the cursor to the previous position.

5 Press ENTER to set the new name.
 “OK” appears in the display window on the remote control if renaming was successful.
 “NG” appears in the display window on the remote control if renaming was unsuccessful. In this case, start over from step 3.

 If you continuously want to rename another input area, press the input selector button or \star , or press SELECT Δ / ∇ repeatedly to select the component, then repeat steps 3 through 5.

6 Press RENAME again to exit the renaming mode.



Note

“ERROR” appears in the display window on the remote control if you press a button not indicated in the respective step, or when you press more than one button simultaneously.

 This feature is useful when you change the input or output assignment for digital jacks and component video input jacks. Refer to “INPUT RENAME” on page 95.

Macro programming features

The macro programming feature makes it possible to perform a series of operations with the press of a single button. For example, when you want to play a CD, normally you would turn on the components, select the CD input, and press the play button to start playback. The macro programming feature lets you perform all of these operations simply by pressing the CD macro button. The buttons listed as macro buttons below are factory set with macro programs. You can also program your own macros (see page 109).

MACRO operations

Macro buttons

(U.S.A. model)

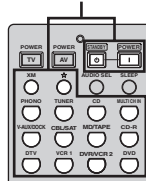

MACRO ON/OFF

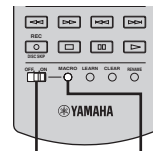

MACRO

1 Set the MACRO ON/OFF selector to ON.

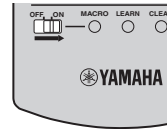

2 Press the desired macro button.

3 Set the MACRO ON/OFF selector to OFF when you finish to using the macro programming operation.

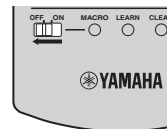

Notes

- While the remote control is running a macro program, it does not accept any other operation until it has completed running the program (the transmission indicator stops flashing).
- Continue to aim the remote control at the component the macro is operating until the macro operation is complete.

ADVANCED OPERATION

■ Default macro functions

Pressing macro button	To automatically transmit these signals in order		
	First	Second	Third
		—	—
	(*1)	(*2)	—
			—
			—
	(*1)		—
		(*3)	—
			(CD area) (*4)
			—
			—
			—
			(MD/TAPE area) (*4)
			(CD-R area) (*4)
			—
			(VCR 1 area) (*4)
		(DVR/VCR 2 area) (*4)	
		(DVD area) (*4)	

*1 You can turn on some components (including YAMAHA components) connected to this unit by connecting them to the AC OUTLETS on the rear panel of this unit. Power control may not be synchronized with this unit depending on the component. For details, refer to the operating instructions for the connected component.

*2 When the remote control code for your TV is set up for either DTV or PHONO (see page 103), you can turn on the power of your TV without selecting an input source. The remote control code set up for DTV takes priority over the one for PHONO.

*3 When TUNER is selected as the input source, this unit plays the last station received before the unit was set in the standby mode.

*4 Playback can be started for any YAMAHA remote control-compatible MD recorder, CD player, CD recorder, DVD player, or DVD recorder. When using macros to operate other components, you will need to program the play button on the input area of that component (see page 105) or set a remote control code (see page 103).

■ Programming macro operations

You can program your own macro and use the macro programming feature to transmit several remote control commands in sequence at the press of a button. Be sure to set up remote control codes or perform learning operations before programming the macro.

Notes

- The default macro is not cleared when a new macro is programmed for a button. The default macro can be used again when the programmed macro is cleared.
- It is not possible to add a new signal (macro step) to the default macro. Programming a macro changes all macro contents.
- We do not recommend programming continuous operations such as volume control in a macro.

1 Set the operation mode selector to AMP or SOURCE and then press MACRO using a ballpoint pen or similar object.

“MCR ?” appears in the display window on the remote control.

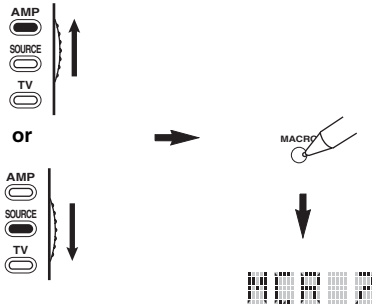

Note

If you do not complete each of the following steps within 30 seconds, the macro programming mode will be automatically canceled. In this case, start over from step 1.

2 Press the macro button you want to use to operate the macro.

The macro button name (ex. “M;DVD”) and the selected component name (ex. “DVD”) appear alternately in the display window on the remote control.

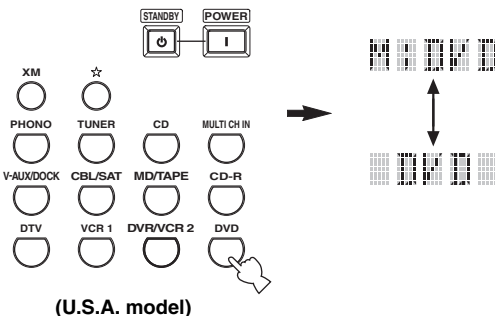

(U.S.A. model)

Note

“AGAIN” appears in the display window if you press a button other than a macro button.

3 Press the buttons for the functions you want to include in the macro operation in sequence.

You can set up to 10 steps (10 functions). After you have set 10 steps, “FULL” appears and the remote control automatically exits the macro mode. The following example is for programming the following procedure:

Step 1 (“MCR 1”): Press DVD.

Step 2 (“MCR 2”): Press AV POWER.

Step 3 (“MCR 3”): Press SLEEP.

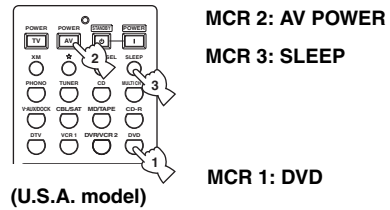

(U.S.A. model)

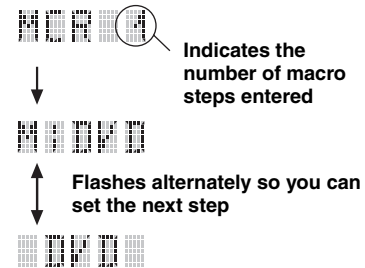

Note

To change the selected input area, press SELECT Δ / ∇ .

Pressing the input selector buttons will program a macro step, whereas SELECT Δ / ∇ only changes the selected input area.

4 Press MACRO again using a ballpoint pen or similar object when the operation sequence you want to program is complete.

Note

“ERROR” appears in the display window if you press more than one button simultaneously.

Cleaning configurations

You can clear all changes made in each function set, such as learned functions, macros, renamed input area names and setup remote control ID.

■ Clearing function sets

- 1 Set the operation mode selector to AMP or SOURCE and then press CLEAR by using a ballpoint pen or similar object.

“CLEAR” appears in the display window.

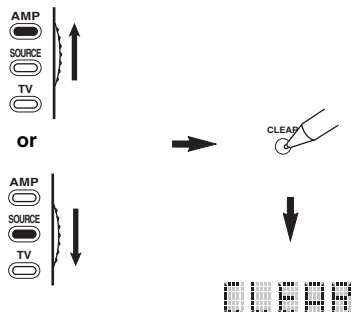

Note

If you do not complete each of the following steps within 30 seconds, the clearing mode will be automatically canceled. In this case, start over from step 1.

- 2 Press Δ / ∇ to select the clear mode.

- L;CD (etc.) (L; Name of an input area)
Clears all learned functions in the respective input area. The name of a component is shown after a semicolon (;). Press an input selector button to select the input area.
- L;AMP
Clears all learned functions for controlling the amplifier functions of this unit.
- L;ALL
Clears all learned functions.
- M;ALL
Clears all programmed macros.
- RNAME
Clears all renamed source names.
- FCTRY
Clears all remote functions and returns the remote to the factory settings.

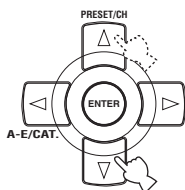

- 3 Press and hold CLEAR again for about 3 seconds.

“WAIT” appears in the display window. If clearing was successful, “C;OK” appears in the display window on the remote control.



Once you have cleared a learned function for a button, the button reverts to the factory setting (or to the manufacturer setting, if you have set remote control codes).

Notes

- “L;ALL” and “FCTRY” may take about 30 seconds to complete.
- “C;NG” appears in the display window if clearing was unsuccessful. In this case start over from step 2.
- “ERROR” appears in the display window if you press a button not indicated in the respective step, or if you press more than one button simultaneously.

■ Clearing a learned function

You can clear the function learned for a certain button in each control area.

- 1 Set the operation mode selector to AMP or SOURCE and then press an input selector button or ☆ to select the input area containing the function you want to clear.**

The selected component name appears in the display window.

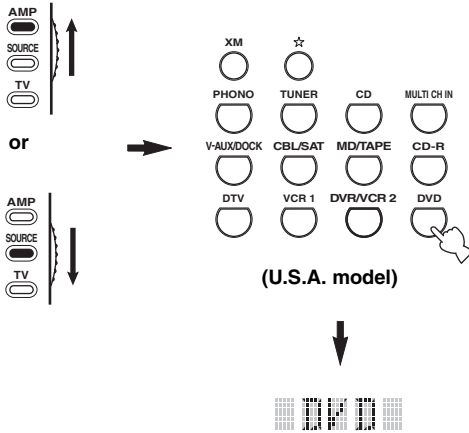

- 2 Press LEARN using a ballpoint pen or similar object.**

“LEARN” and the selected component name (ex. “DVD”) appear alternately in the display window.

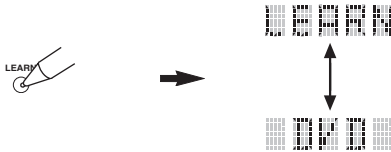

Notes

- Do not press and hold LEARN. If you hold it down for more than 3 seconds, the remote control enters the remote control code setting mode.
- If you do not complete each of the following steps within 30 seconds, the learning mode will be automatically canceled. In this case, start over from step 2.

- 3 Press and hold CLEAR using a ballpoint pen or similar object and then press the button you want to clear for about 3 seconds.**

“C;OK” appears in the display window if clearing was successful. Once “C;OK” appears in the display window on the remote control, release the ballpoint pen or similar object used to press CLEAR to exit the clearing mode. The remote control returns to the learning mode.

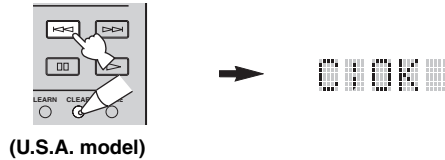

- If you continuously want to clear another function, repeat step 4.
- If you continuously want to clear another function for another component, press SELECT Δ / ▽ to select the input area, then repeat step 4.
- Once you clear a learned function, the button reverts to the factory setting (or to the manufacturer setting if you have set remote control codes).

- 4 Press LEARN again to exit.**

Notes

- “C;NG” appears in the display window on the remote control if clearing was unsuccessful. In this case, start over from step 2.
- “ERROR” appears in the display window if you press more than one button simultaneously.

■ Clearing a macro function

You can clear the function programmed for a certain macro button.

- 1 Set the operation mode selector to AMP or SOURCE and then press MACRO using a ballpoint pen or similar object.

“MCR ?” appears in the display window on the remote control.

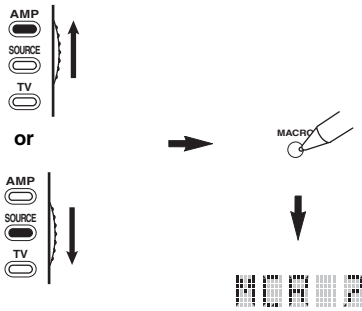

Note

If you do not complete each of the following steps within 30 seconds, the macro programming mode will be automatically canceled. In this case, start over from step 1.

- 2 Press and hold CLEAR using a ballpoint pen or similar object, then press the macro button you want to clear for about 3 seconds. “C;OK” appears in the display window on the remote control if clearing was successful.

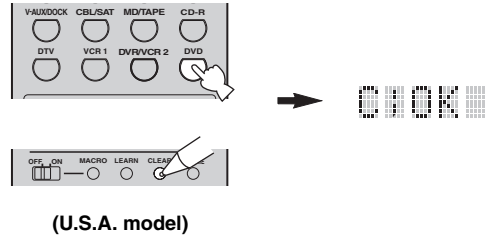

- If you continuously want to clear another function, repeat step 2.
- Once you clear a programmed function, the button reverts to the factory setting (or to the manufacturer setting if you have set remote control codes).

- 3 Press MACRO again to exit the macro programming mode.

Notes

- “C;NG” appears in the display window on the remote control if clearing was unsuccessful. In this case, start over from step 2.
- “ERROR” appears in the display window on the remote control if you press more than one button simultaneously.

USING MULTI-ZONE CONFIGURATION

This unit allows you to configure a multi-room audio system. The multi-zone configuration feature enables you to set this unit to reproduce separate input sources in the main room, second room (Zone 2) and third room (Zone 3). You can control this unit from the second or third room using the supplied remote control.

Only analog signals are sent to the second and third rooms. Any source you want to listen to in the second or third room must be connected using the analog (AUDIO L/R) input jacks on this unit.

Connecting the Zone 2 and Zone 3 components

You need the following additional equipment to use the multi-room functions of this unit:

- An infrared signal receiver in the second and/or third room.
- An infrared emitter in the main room. This emitter transmits the infrared signals from the remote control in the second and/or third room to the main room (to a CD player or DVD player, for example).
- An amplifier and speakers for the second and/or third room.

- ☀️ You do not need an extra amplifier and speakers for the second and/or third room if you want to use the internal amplifiers of this unit.
- Since there are many possible ways to connect and use this unit in a multi-room configuration, we recommend that you consult with your nearest authorized YAMAHA dealer or service center for the Zone 2 and Zone 3 connections that best meet your requirements.

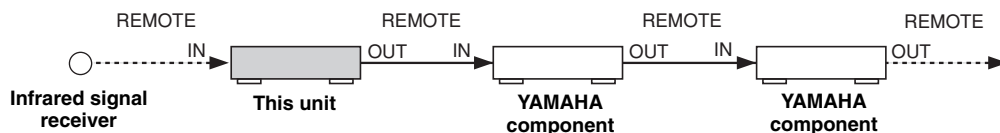

Using external amplifiers

To use an external amplifier in Zone 2 or Zone 3, connect the external amplifier to ZONE OUT terminals and select "EXT" in "ZONE2 AMP" or "ZONE3 AMP" (see page 100).

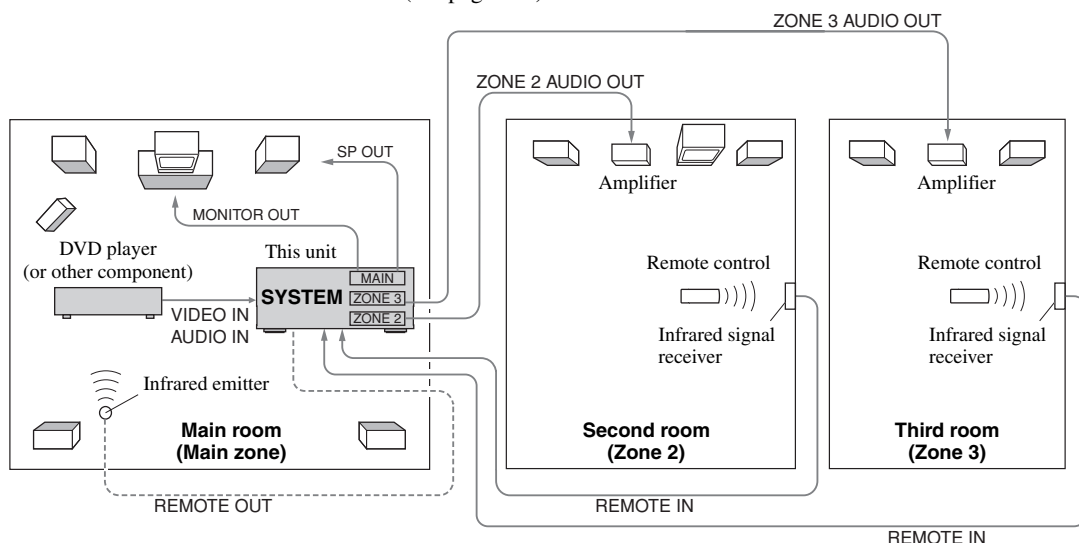

Notes

- Adjust the Zone 2/Zone 3 volume by using the amplifier in the second/third room when "ZONE2 VOL" or "ZONE3 VOL" are set to "FIX" (see page 99).
- To avoid unexpected noise, DO NOT use the Zone 2/Zone 3 feature with CDs encoded in DTS.

■ Using the internal amplifiers of this unit

IMPORTANT SAFETY NOTICE

The SP1 or SP2 speaker terminals of this Receiver should not be connected to a Passive Loudspeaker Selector Box or more than one loudspeaker per channel. Connection to a Passive Loudspeaker Selector Box or multiple speakers per channel could create an abnormally low impedance load resulting in amplifier damage. See this owner’s manual for correct usage. Compliance with minimum speaker impedance information for all channels must be maintained at all times. This information is found on the back panel of your Receiver.

If you want to use one internal amplifier (SP1 or SP2) of this unit

Connect the Zone 2 or Zone 3 speakers directly to the SP1 or SP2 speaker terminals and select either “[SP1]” or “[SP2]” for “ZONE2 AMP” or “ZONE3 AMP” (see page 100).

If you want to use two internal amplifiers (both SP1 and SP2) of this unit

Connect the Zone 2 or Zone 3 speakers directly to the SP1 and SP2 speaker terminals and select “BOTH” for “ZONE2 AMP” or “ZONE3 AMP” (see page 100).

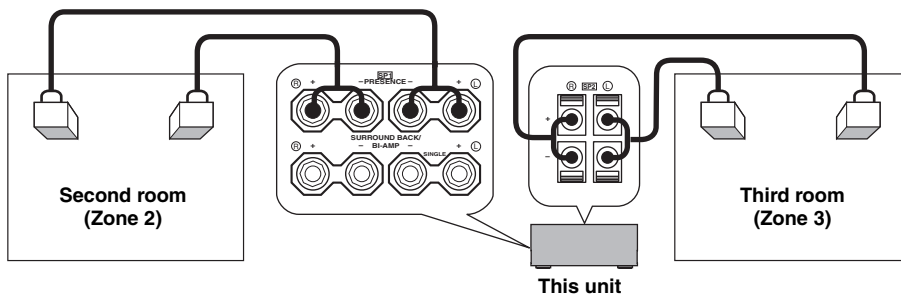

Controlling Zone 2 or Zone 3

You can select the zone you want to control by using the control buttons on the front panel or on the remote control.

■ Selecting Zone 2 or Zone 3

Front panel operations

- 1 Press ZONE 2 ON/OFF or ZONE 3 ON/OFF on the front panel to individually turn on or off Zone 2 or Zone 3.



- 2 Press ZONE CONTROLS on the front panel repeatedly to select the zone you want to control.



Each time you press ZONE CONTROLS, the front panel display changes as shown below, and the indicator for the currently selected zone flashes for approximately 5 seconds. However, no indicator flashes when the main zone is selected.

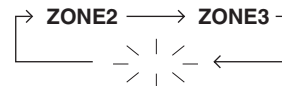

No indicator flashes when the main zone is selected.

ZONE2

Controls the Zone 2 amplifier or tuner functions.

ZONE3

Controls the Zone 3 amplifier or tuner functions.



- You must complete this step within 5 seconds while the selected zone flashes in the front panel display. Otherwise, the currently selected zone mode is automatically canceled. In this case, press ZONE CONTROLS again.
- The initial setting is ZONE2 when both Zone 2 and Zone 3 are turned on.

3 Refer to “Selecting the input source of Zone 2 or Zone 3”, “Adjusting the volume level of Zone 2 or Zone 3”, “Adjusting the balance of the speaker level in Zone 2 or Zone 3” or “Adjusting the tonal quality of Zone 2 or Zone 3” on page 116 to perform further operations.

Remote control operations

1 Set the operation mode selector to AMP and then press SELECT Δ repeatedly to select the zone you want to control.

“ZONE 2” or “ZONE 3” is displayed in the display window on the remote control.

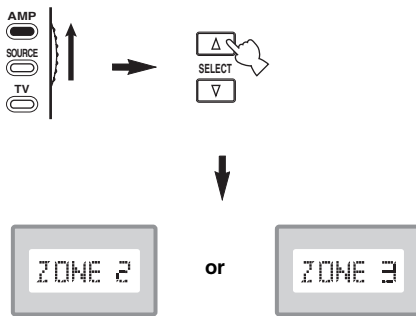

2 Refer to “Selecting the input source of Zone 2 or Zone 3”, “Adjusting the volume level of Zone 2 or Zone 3”, “Adjusting the balance of the speaker level in Zone 2 or Zone 3” or “Adjusting the tonal quality of Zone 2 or Zone 3” on page 116 to perform further operations.

3 Press SELECT Δ / ∇ to exit from the Zone 2/Zone 3 mode.

Note

The input source of Zone 2 and the source available for recording are always the same.

Turning on or off Zone 2 and/or Zone 3 using the remote control

POWER and STANDBY on the remote control work differently depending on the selected zone that appears in the display window on the remote control.

- When the main zone, Zone 2 or Zone 3 mode is selected, you can turn on the main zone, Zone 2 or Zone 3 or set them to the standby mode individually.
- When the all mode is selected, pressing POWER turns on the main zone, Zone 2 and Zone 3 simultaneously and pressing STANDBY sets them to the standby mode simultaneously.

Control mode	Display window	POWER and STANDBY
Main zone mode	Name of the selected input area	Turns on the main zone only or sets it to the standby mode.
Zone 2 mode	“ZONE 2” or “2;name of the selected input area”	Turns on Zone 2 or sets it to the standby mode.
Zone 3 mode	“ZONE 3” or “3;name of the selected input area”	Turns on Zone 3 or sets it to the standby mode.
All mode	“ALL”	POWER: turns on the main zone, Zone 2 and Zone 3. STANDBY: sets the main zone, Zone 2 and Zone 3 to the standby mode.

Notes

- When the remote control is in the main zone mode, “MAIN” appears for a few seconds when POWER or STANDBY is pressed.
- “ALL” appears in the display window on the remote control only when SELECT ∇ is pressed.

Selecting the input source of Zone 2 or Zone 3

Rotate the INPUT selector on the front panel (or set the operation mode selector to AMP and then press one of the input selector buttons on the remote control) to select the input source of the selected zone.

If the remote control is used to select the input source, “2: name of the selected input source” or “3: name of the selected input source” is displayed in the display window on the remote control when Zone 2 or Zone 3 is selected respectively.

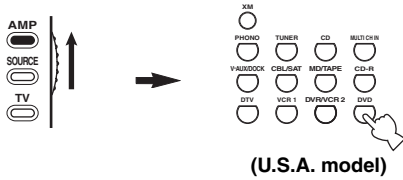
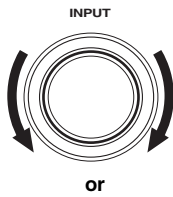

- Select TUNER as the input source to use the TUNER features in the selected zone. For details about the TUNER operations, see “FM/AM TUNING” on page 54.
- Select XM as the input source to use the XM Satellite Radio features in the selected zone. For details about the XM Satellite Radio operations, see “XM SATELLITE RADIO TUNING” on page 61.

Note

The selected input source is shared across all zones.



You must complete this step within 5 seconds while the selected zone flashes in the front panel display. Otherwise, the currently selected zone mode is automatically canceled. In this case, press ZONE CONTROLS on the front panel again.

■ **Adjusting the volume level of Zone 2 or Zone 3**

Rotate VOLUME on the front panel (or press VOLUME +/- on the remote control) to adjust the volume level of the selected zone.

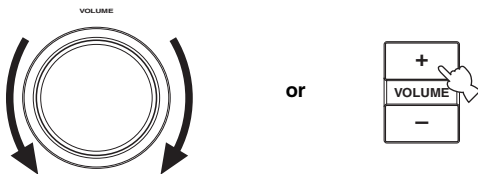

Press MUTE on the remote control to mute the sound output to the selected zone.

Note

When you use the external amplifiers in Zone 2 or Zone 3, VOLUME +/- can be used only when ZONE2 VOL” or “ZONE3 VOL” is set to “VAR” in “ZONE SET” (see page 99).

■ **Adjusting the balance of the speaker level in Zone 2 or Zone 3**

Press TONE CONTROL repeatedly to select “BALANCE” and then rotate PROGRAM on the front panel to adjust the balance of the front left and right speaker level of the selected zone.

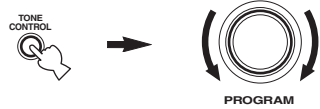

■ **Adjusting the tonal quality of Zone 2 or Zone 3**

Set the operation mode selector to AMP and then press CH +/- on the remote control to adjust the high-frequency response (TREBLE) or TV VOL +/- to adjust the low-frequency response (BASS) respectively.

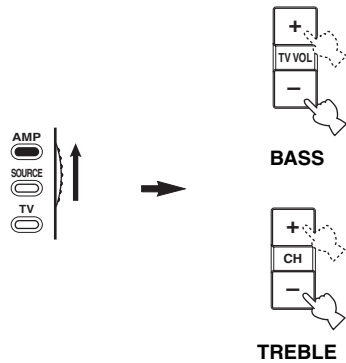

You can also adjust the tonal quality of Zone 2 or Zone 3 by using TONE CONTROL on the front panel. For details, see “Adjusting the tonal quality” on page 50.

Note

Check that “ZONE 2” or “ZONE 3” is displayed in the display window of the remote control before you adjust the tonal quality of the corresponding zone (see page 115).

ADVANCED SETUP

This unit has additional menus that are displayed in the front panel display. The advanced setup menu offers additional operations to adjust and customize the way this unit operates. Change the initial settings (indicated in bold under each parameter) to reflect the needs of your listening environment.

Notes

- The settings you make are reflected next time you press MASTER ON/OFF inward to the ON position to turn on this unit (see page 31).
- Only MASTER ON/OFF, STRAIGHT and the PROGRAM selector are effective while you are using the advanced setup menu.
- All the other operations cannot be made while you are using the advanced setup menu.
- The advanced setup menu is only available in the front panel display.

Using ADVANCED SETUP

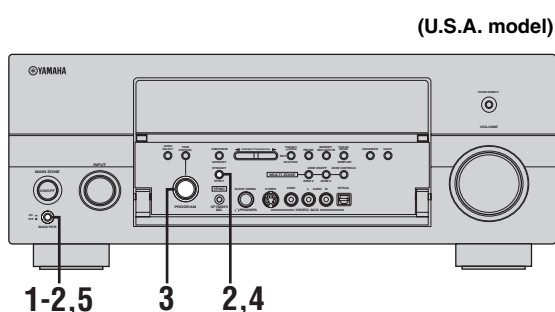

- 1 Press MASTER ON/OFF on the front panel to release it outward to the OFF position to turn off this unit.**



- 2 Press and hold STRAIGHT on the front panel and then press MASTER ON/OFF inward to the ON position to turn on this unit.**

This unit turns on, and the advanced setup menu appears in the front panel display.



- 3 Rotate the PROGRAM selector on the front panel to select the parameter you want to adjust.**

The name of the selected parameter appears in the front panel display.

See page 118 for a complete list of available parameters.



Currently selected parameter

Currently selected parameter setting

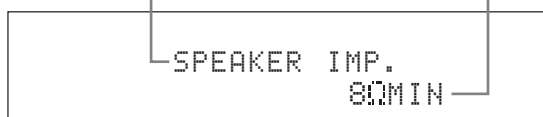

- 4 Press STRAIGHT on the front panel repeatedly to change the selected parameter setting.**



- 5 Press MASTER ON/OFF on the front panel to release it outward to the OFF position to save the new setting and turn off this unit.**



The settings you made are reflected next time you turn on this unit.

■ **Speaker impedance** SPEAKER IMP.

Use this feature to set the speaker impedance of this unit so that it matches that of your speakers.

Choices: **8ΩMIN**, **6ΩMIN**

- Select “8ΩMIN” to set the speaker impedance to 8 Ω .
- Select “6ΩMIN” to set the speaker impedance to 6 Ω .

SPEAKER IMP.	Speaker	Impedance level
8ΩMIN	Front	The impedance of each speaker must be 8 Ω or higher.
	Center	The impedance of each speaker must be 8 Ω or higher.
	Surround	
	Surround back	
6ΩMIN	Front	The impedance of each speaker must be 4 Ω or higher.
	Center	The impedance of each speaker must be 6 Ω or higher.
	Surround	
	Surround back	

■ **User presets** USER PRESET

Use this feature to reset all the parameters of this unit to the initial factory settings (see page 130).

Choices: **CANCEL**, **RESET**

- Select “CANCEL” not to reset any parameters of this unit.
- Select “RESET” to reset the parameters of this unit.

Notes

- This setting completely resets all the parameters of this unit including the “SET MENU” parameters. However, the advanced setup menu parameters will not be initialized.
- The initial factory settings are activated next time you turn on this unit.

■ **Remote sensor** REMOTE SENSOR

Use this feature to activate or deactivate the signal-receiving capability of the remote control sensor on the front panel of this unit.

Choices: **ON**, **OFF**

- Select “ON” if you want to activate the signal-receiving capability of the remote control sensor.
- Select “OFF” if you want to deactivate the signal-receiving capability of the remote control sensor.

Note

We recommend setting the parameter to “ON” in most cases.

■ **Wake on RS-232C access**

WAKE ON RS232C

Use this feature to set this unit to transmit data via the RS-232C interface when this unit is in the standby mode.

Choices: **YES**, **NO**

Initial setting:

[U.S.A. and Canada models]: **YES**

[Other models]: **NO**

- Select “YES” to set this unit to transmit data via the RS-232C interface.
- Select “NO” to set this unit not to transmit data via the RS-232C interface.

■ **Remote control AMP ID**

RC AMP ID

Use this feature to set the AMP ID of this unit for remote control recognition (see page 104).

Choices: **ID1**, **ID2**

- Select “ID1” when the remote control AMP ID library code is set to “2001”.
- Select “ID2” when the remote control AMP ID library code is set to “2002”.

Note

You need to set the corresponding remote control AMP library code for the remote control (see page 104).

■ **Remote control TUNER ID**

RC TUNER ID

Use this feature to set the TUNER ID of this unit for remote control recognition (see page 121).

Choices: **ID1**, **ID2**

- Select “ID1” when the remote control TUNER ID library code is set to “2602”.
- Select “ID2” when the remote control TUNER ID library code is set to “2603”.

Note

You need to set the corresponding remote control TUNER library code for the remote control (see page 121).

■ **Remote control XM ID** RC XM ID
(U.S.A. and Canada models only)

Use this feature to set the XM ID of this unit for remote control recognition (see page 121).

Choices: **ID1**, **ID2**

- Select “ID1” when the remote control XM ID library code is set to “2604”.
- Select “ID2” when the remote control XM ID library code is set to “2605”.

Note

You need to set the corresponding remote control XM library code for the remote control (see page 121).

Tuner frequency step TUNER FRQ STEP (Asia and General models only)

Use this feature to set the tuner frequency step according to the frequency spacing in your area.

Choices: **AM10/FM100**, AM9/FM50

- Select “AM10/FM100” for North, Central and South America.
- Select “AM9/FM50” for all other areas.

Bi-AMP BI-AMP

Use to activate or deactivate the bi-AMP function.

Choices: ON, **OFF**

- Select “ON” if you want to activate the bi-AMP function.
- Select “OFF” if you want to deactivate the bi-AMP function.

Note

When BI-AMP is set to ON, the SURROUND BACK terminals cannot be used to connect surround back speakers in that the SURROUND BACK terminals are already used for the bi-AMP connection (see page 17).

Video reset VIDEO RESET

Use to initialize the parameter settings for “DISPLAY SET” in “OPTION MENU” (see page 97).

Choices: YES, **CANCEL**

Note

The parameter setting for “DIMMER”, “SHORT MESSAGE”, “ON SCREEN” and “FL SCROLL” is not initialized (see page 97).

Setting remote control ID

When using multiple YAMAHA receivers/amplifiers, you may be able to operate the other components simultaneously with the default code setting. In this case, set one of the alternative codes to operate this unit separately.

Setting remote control AMP ID

1 Set the operation mode selector to AMP or SOURCE.

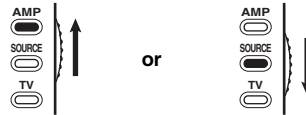

2 Press and hold LEARN for about 3 seconds using a ballpoint pen or similar object and then press </> repeatedly until “L;AMP” appears in the display window on the remote control.

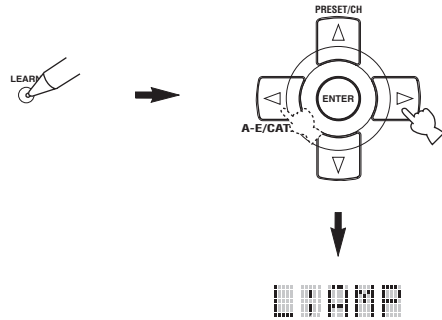

Notes

- Be sure to press and hold LEARN for at least 3 seconds, otherwise the learning process will start.
- If you do not complete each of the following steps within 30 seconds, the setting mode will be automatically canceled. In this case, start over from step 1.

3 Press ENTER.

The four-digit code set for the selected input area appears in the display window on the remote control.

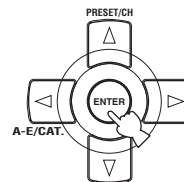

- 4 Press the numeric buttons to enter the four-digit remote control code for the input area you want to use.**

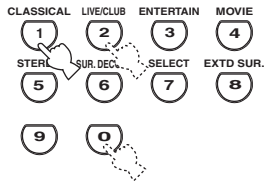

Remote control AMP codes

Select one of the following codes to set the remote control AMP code for the input area you want to use.

AMP library code (remote control setting)	Function	Remote control AMP ID
2001 (initial setting)	To operate this unit using the default code.	ID1 (initial setting)
2002	To operate this unit using an alternative code.	ID2

Note

You need to set the corresponding remote control AMP ID (see page 118).

- 5 Press ENTER to set the number.**

“OK” appears in the display window if setting was successful.

“NG” appears in the display window if the setting was unsuccessful. In this case, start over from step 1.

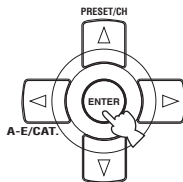

- 6 Press LEARN again to exit from the setup mode.**



Setting remote control tuner ID or XM ID

- 1 Set the operation mode selector to AMP or SOURCE and then press TUNER or XM on the remote control to select the tuner or XM to change the remote control ID.**

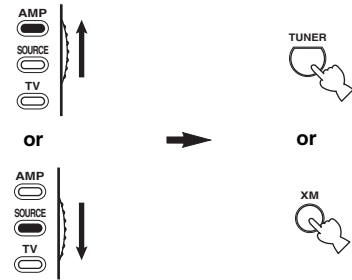

- 2 Press and hold LEARN for about 3 seconds using a ballpoint pen or similar object and then press </> repeatedly until “L;TUN” and “TUNER”, or “L;TUN” and “XM” alternately appear in the display window on the remote control.**

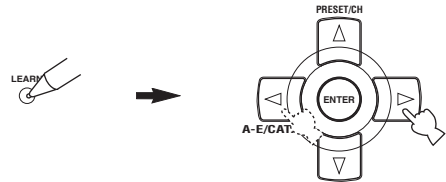

Notes

- Be sure to press and hold LEARN for at least 3 seconds, otherwise the learning process will start.
- If you do not complete each of the following steps within 30 seconds, the setting mode will be automatically canceled. In this case, start over from step 1.

- 3 Press ENTER.**

The four-digit code set for the selected input area appears in the display window on the remote control.

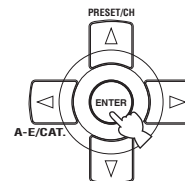

- 4 Press the numeric buttons to enter the four-digit remote control code for the input area you want to use.**

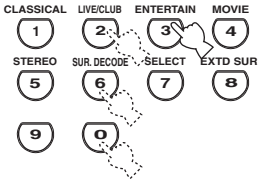

Remote control tuner codes

Select one of the following codes to set the remote control tuner code for the input area you want to use.

Tuner library code (remote control setting)	Function	Remote control tuner ID
2602 (initial setting)	To operate this unit using the default code.	ID1 (initial setting)
2603	To operate this unit using an alternative code.	ID2

Remote control XM codes

Select one of the following codes to set the remote control XM code for the input area you want to use.

XM library code (remote control setting)	Function	Remote control XM ID
2604 (initial setting)	To operate this unit using the default code.	ID1 (initial setting)
2605	To operate this unit using an alternative code.	ID2

Note

You need to set the corresponding remote control tuner ID or XM ID (see page 118).

- 5 Press ENTER to set the number.**

“OK” appears in the display window if setting was successful.

“NG” appears in the display window if the setting was unsuccessful. In this case, start over from step 1.

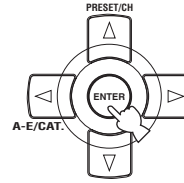

- 6 Press LEARN again to exit from the setup mode.**



TROUBLESHOOTING

Refer to the table below when this unit does not function properly. If the problem you are experiencing is not listed below or if the instruction below does not help, turn off this unit, disconnect the power cable, and contact the nearest authorized YAMAHA dealer or service center.

■ General

Problem	Cause	Remedy	See page
This unit fails to turn on or enters the standby mode soon after the power is turned on.	The power cable is not connected or the plug is not completely inserted.	Connect the power cable firmly.	—
	The speaker impedance setting is incorrect.	Set the speaker impedance to match your speakers.	30
	The protection circuitry has been activated.	Make sure that all speaker wire connections on this unit and on all speakers are secure and that the wire for each connection does not touch anything other than its respective connection.	14
	This unit has been exposed to a strong external electric shock (such as lightning or strong static electricity).	Set this unit to the standby mode, disconnect the power cable, plug it back in after 30 seconds and then use it normally.	—
No sound	Incorrect input or output cable connections.	Connect the cables properly. If the problem persists, the cables may be defective.	21-27
	The optimizer microphone is connected.	Disconnect the optimizer microphone.	36
	Audio input jack select is set to “HDMI”, “COAX/OPT” or “ANALOG”.	Set Audio input jack select to “AUTO”.	40
	Audio input jack select is set to “ANALOG” while playing a source encoded in Dolby Digital or DTS.	Set Audio input jack select to “AUTO” or “COAX/OPT”.	40
	No appropriate input source has been selected.	Select an appropriate input source with the INPUT selector on the front panel (or the input selector buttons on the remote control).	38, 41
	Speaker connections are not secure.	Secure the connections.	14
	The volume is turned down.	Turn up the volume.	—
	The sound is muted.	Press MUTE or VOLUME +/- on the remote control to resume audio output and then adjust the volume.	41
	Signals this unit cannot reproduce are being input from a source component, such as a CD-ROM.	Play a source whose signals can be reproduced by this unit.	—
	The HDMI components connected to this unit do not support the HDCP copy protection standards.	Connect HDMI components that support the HDCP copy protection standards.	19
“SUPPORT AUDIO” is set to “OTHER” and “HDMI” audio signals are not being played back on this unit.	Set “SUPPORT AUDIO” to “RX-V1700” in “MANUAL SETUP”.	93	

Problem	Cause	Remedy	See page
No picture	The output and input for the picture are connected to different types of video jacks.	Set "V CONV." to "ON" or connect your source components in the same way as you connect your video monitor to this unit.	97
	Non-standard video signals are input.		
Short message displays do not appear in the video monitor	"SHORT MESSAGE" is set to "OFF".	Set "SHORT MESSAGE" to "ON".	98
	"GRAY BACK" is set to "OFF".	Set "GRAY BACK" to "AUTO".	97
	"V CONV." is set to "OFF".	Set "V CONV." to "ON".	97
	The signals input at the HDMI IN1 or HDMI IN2 jack are being output at the HDMI OUT jack.		
	Video signals in the progressive format or HDTV video signals are being input.		
The sound suddenly goes off.	The protection circuitry has been activated because of a short circuit, etc.	Check that the speaker impedance setting is correct.	30, 118
		Check that the speaker wires are not touching each other and then turn this unit back on.	—
	The sleep timer has turned off this unit.	Turn on this unit, and play the source again.	—
	The sound is muted.	Press MUTE or VOLUME +/- on the remote control to resume audio output.	41
Sound is heard from the speaker on one side only.	Incorrect cable connections.	Connect the cables properly. If the problem persists, the cables may be defective.	14
	Incorrect settings in "SP LEVEL".	Adjust the "SP LEVEL" settings.	90
Only the center speaker outputs substantial sound.	When playing a monaural source with a CINEMA DSP program, the source signal is directed to the center channel, and the front and surround speakers output effect sounds.		
No sound is heard from the center speaker.	"CENTER SP" in "SET MENU" is set to "NONE".	Set "CENTER SP" to "SML" or "LRG".	88
	One of the HiFi DSP programs (except for "7ch Stereo") has been selected.	Try another sound field program.	45
No sound from the presence speakers	The sound field programs are turned off.	Press STRAIGHT to turn them on.	49
	You are using a source or program combination that does not output sound from all channels.	Try another sound field program.	38
No sound is heard from the surround speakers.	"SUR. L/R SP" in "SET MENU" is set to "NONE".	Set "SUR. L/R SP" to "SML" or "LRG".	88
	This unit is in the "STRAIGHT" mode and a monaural source is being played back.	Press STRAIGHT on the front panel so that "STRAIGHT" disappears from the front panel display.	49
No sound is heard from the subwoofer.	"LFE/BASS OUT" in "SET MENU" is set to "FRONT" when a Dolby Digital or DTS signal is being played.	Set "LFE/BASS OUT" to "SWFR" or "BOTH".	87
	"LFE/BASS OUT" in "SET MENU" is set to "SWFR" or "FRONT" when a 2-channel source is being played.	Set "LFE/BASS OUT" to "BOTH".	87
	The source does not contain low-frequency signals.		

Problem	Cause	Remedy	See page
No sound is heard from the surround back speakers.	“SUR. L/R SP” in “SET MENU” is set to “NONE” and “SB L/R SP” is automatically set to “NONE”.	Set “SUR. L/R SP” and “SB L/R SP” to a setting other than “NONE”.	88
	“SB L/R SP” in “SET MENU” is set to “NONE”.	Set “SB L/R SP” to a setting other than “NONE”.	89
Dolby Digital or DTS sources cannot be played. (Dolby Digital or DTS indicator in the front panel display does not light up.)	The connected component is not set to output Dolby Digital or DTS digital signals.	Make an appropriate setting following the operating instructions for your component.	—
	Audio input jack select is set to “ANALOG”.	Set Audio input jack select to “AUTO”.	40
A humming sound is heard.	Incorrect cable connections.	Connect the audio cables firmly. If the problem persists, the cables may be defective.	—
	No connection from the turntable to the GND terminal.	Connect the grounding cable of your turntable to the GND terminal of this unit.	24
The volume level is low while a record is being played.	The record is being played on a turntable with an MC cartridge.	Connect your turntable to this unit through an MC-head amplifier.	24
The volume level cannot be increased, or the sound is distorted.	The component connected to the AUDIO OUT (REC) jacks of this unit is turned off.	Turn on the power of the component.	—
The sound effect cannot be recorded.	It is not possible to record the sound effect with a recording component.		
A source cannot be recorded by a digital recording component connected to the DIGITAL OUTPUT jack.	The source component is not connected to the DIGITAL INPUT jacks of this unit.	Connect the source component to the DIGITAL INPUT jacks.	22, 24
	Some components cannot record Dolby Digital or DTS sources.		
A source cannot be recorded by an analog component connected to the AUDIO OUT (REC) jacks.	The source component is not connected to the analog AUDIO IN jacks of this unit.	Connect the source component to the analog AUDIO IN jacks.	24
The sound field parameters and some other settings of this unit cannot be changed.	“MEMORY GUARD” in “SET MENU” is set to “ON”.	Set “MEMORY GUARD” to “OFF”.	98

Problem	Cause	Remedy	See page
This unit does not operate properly.	The internal microcomputer has been frozen by an external electric shock (such as lightning or excessive static electricity) or by a power supply with low voltage.	Disconnect the power cable from the AC wall outlet and then plug it in again after about 30 seconds.	—
“CHECK SP WIRES” appears in the front panel display.	Speaker cables are short-circuited.	Make sure all speaker cables are connected correctly.	14
There is noise interference from digital or radio frequency equipment.	This unit is too close to the digital or high-frequency equipment.	Move this unit further away from such equipment.	—
The picture is disturbed.	The video source uses scrambled or encoded signals to prevent dubbing.		
This unit suddenly enters the standby mode.	The internal temperature becomes too high and the overheat protection circuitry has been activated.	Wait about 1 hour for this unit to cool down and then turn it back on.	—

■ Tuner

	Problem	Cause	Remedy	See page
FM	FM stereo reception is noisy.	The characteristics of FM stereo broadcasts may cause this problem when the transmitter is too far away or the antenna input is poor.	Check the antenna connections.	28
			Try using a high-quality directional FM antenna.	—
			Use the manual tuning method.	56
	There is distortion, and clear reception cannot be obtained even with a good FM antenna.	There is multi-path interference.	Adjust the antenna position to eliminate multi-path interference.	—
	The desired station cannot be tuned into with the automatic tuning method.	The signal is too weak.	Use a high-quality directional FM antenna.	—
			Use the manual tuning method.	56
	Previously preset stations can no longer be tuned into.	This unit has been disconnected for a long period.	Preset the stations again.	57, 58
AM	The desired station cannot be tuned into with the automatic tuning method.	The signal is weak or the antenna connections are loose.	Tighten the AM loop antenna connections and orient it for the best reception.	—
			Use the manual tuning method.	56
	There are continuous crackling and hissing noises.	Noises can result from lightning, fluorescent lamps, motors, thermostats and other electrical equipment.	Use an outdoor antenna and a ground wire. This will help somewhat, but it is difficult to eliminate all noise.	—
	There are buzzing and whining noises.	A TV set is being used nearby.	Move this unit away from the TV set.	—

■ XM Satellite Radio (U.S.A. and Canada models only)

If an operation takes longer than usual or an error occurs, one of the following messages may appear in the front panel display. In this case, read the cause and follow the corresponding remedies.

Status message	Cause	Remedy	See page
CHECK ANTENNA	The XM Passport and XM Passport Home Dock are not connected to the XM jack of this unit or do not work properly.	Check XM Passport and XM Passport Home Dock connections and orient for the best reception level.	61
UPDATING	The XM user encryption code is being updated.	Wait until the encryption code is updated.	—
NO SIGNAL	The signal is too weak.	Adjust the orientation of the XM Passport System for the best reception level.	61
LOADING	It takes longer than four seconds for audio or text data to be decoded.	Wait until the decoding process has finished.	—
OFF AIR	The XM Satellite Radio channel you selected is not currently broadcasting any signals.	Check the channel number again or select another XM Satellite Radio channel.	—
<XM> - - -	The Channel Station ID (SID) is no longer available.		
- - - / - - -	No artist name or song title is available.		
<CAT> - - -	No channels are available for the selected category.	Select another channel category by pressing CATEGORY on the front panel (or A-E/CAT, </> on the remote control) repeatedly.	67

■ Remote control

Problem	Cause	Remedy	See page
The remote control does not work or function properly.	Wrong distance or angle.	The remote control will function within a maximum range of 6 m (20 ft) and no more than 30 degrees off-axis from the front panel.	9
	Direct sunlight or lighting (from an inverter type of fluorescent lamp, etc.) is striking the remote control sensor of this unit.	Reposition this unit.	—
	The batteries are weak.	Replace all batteries.	9
	The operation mode selector is set incorrectly.	Set the operation mode selector correctly. When operating this unit, set it to the AMP position. When operating the component selected by the input selector button, set it to the SOURCE position. When operating the TV set in the DTV or PHONO area, set it to the TV position.	—
	The remote control code was not correctly set.	Set the remote control code correctly using “LIST OF REMOTE CONTROL CODES” at the end of this manual.	103
		Try setting another code of the same manufacturer using “LIST OF REMOTE CONTROL CODES” at the end of this manual.	103
The library code of the remote control and the remote control ID of this unit do not match.	Match the remote control ID of this unit with the corresponding remote control library code.	104, 118	
Even if the remote control code is correctly set, there are some models that do not respond to the remote control.	Program the necessary functions independently into the programmable buttons using the Learn feature.	105	
The remote control does not learn new functions.	The batteries of this remote control and/or the other remote control are too weak.	Replace the batteries.	9
	The distance between the two remote controls is too much or too little.	Place the remote controls at the proper distance.	105
	The signal coding or modulation of the other remote control is not compatible with this remote control.	Learning is not possible.	—
	Memory capacity is full.	Delete other unnecessary functions to make room for the new functions.	110

■ HDMI

Error message	Cause	Remedy	See page
DEVICE OVER	The number of the connected HDMI components is over the limit.	Reduce the number of the connected HDMI components.	—
HDCP ERROR	HDCP authentication failed.	Check that the connected HDMI components support the HDCP copy protection standards.	—

■ iPod

Note

In case of a transmission error without a status message appearing in the front panel and in the OSD, check the connection to your iPod (see page 27).

Status message	Cause	Remedy	See page
Loadin9...	This unit is in the middle of recognizing the connection with your iPod. This unit is in the middle of acquiring song lists from your iPod.		
Connect error	There is a problem with the signal path from your iPod to this unit.	Turn off this unit and reconnect the YAMAHA iPod universal dock to the DOCK terminal of this unit. Try resetting your iPod.	27 —
Unknown type	The iPod being used is not supported by this unit.	Only iPod (Click and Wheel), iPod nano, and iPod mini are supported.	—
iPod connected	Your iPod is properly stationed in a YAMAHA iPod universal dock (such as the YDS-10, sold separately) connected to the DOCK terminal of this unit, and the connection between your iPod and this unit is complete.		
Disconnected	Your iPod was removed from a YAMAHA iPod universal dock (such as YDS-10 sold separately) connected to the DOCK terminal of this unit.	Station your iPod back in a YAMAHA iPod universal dock (such as YDS-10 sold separately) connected to the DOCK terminal of this unit.	27
Unable to play	This unit cannot play back the songs currently stored on your iPod.	Check that the songs currently stored on your iPod are playable. Store some other playable music files on your iPod.	— —

■ AUTO SETUP

Before AUTO SETUP

Error message	Cause	Remedy	See page
Connect MIC!	Optimizer microphone is not connected.	Connect the supplied optimizer microphone to the OPTIMIZER MIC jack on the front panel.	32
Unplug HP!	Headphones are connected.	Unplug the headphones.	—

During AUTO SETUP

Error message	Cause	Remedy	See page
E-1:NO FRONT SP	Front L/R channel signals are not detected.	Check the front L/R speaker connections.	14
E-2:NO SURR.SP	A surround channel signal is not detected.	Check the surround speaker connections.	14
E-3:NO PRNS.SP	A presence channel signal is not detected.	Check the presence speaker connections.	14
E-4:SBR->SBL	Only right surround back channel signal is detected.	Connect the surround back speaker to the LEFT SURROUND BACK SPEAKERS terminal if you only have one surround back speaker.	14
E-5:NOISY	Background noise is too loud.	Try running "AUTO SETUP" in a quiet environment.	—
		Turn off noisy electric equipment like air conditioners or move them away from the optimizer microphone.	—
E-6:CHECK SUR.	Surround back speakers are connected, though surround L/R speakers are not.	Connect surround speakers when you use surround back speakers.	14
E-7:NO MIC	The optimizer microphone was unplugged during the "AUTO SETUP" procedure.	Connect the supplied optimizer microphone to the OPTIMIZER MIC jack on the front panel.	32
E-8:NO SIGNAL	The optimizer microphone does not detect test tones.	Check the microphone setting.	32
		Check the speaker connections and placement.	14
E-9:USER CANCEL	The "AUTO SETUP" procedure was cancelled due to user activity.	Run "AUTO SETUP" again.	32
E-10:INTERNAL ERROR	An internal error occurred.	Run "AUTO SETUP" again.	32

After AUTO SETUP

Warning message	Cause	Remedy	See page
W-1:OUT OF PHASE	Speaker polarity is not correct. This message may appear depending on the speakers even when the speakers are connected correctly.	Check the speaker connections for proper polarity (+ or -).	14
W-2:OVER 24m (80ft)	The distance between the speaker and the listening position is over 24 m (80 ft).	Bring the speaker closer to the listening position.	—
W-3:LEVEL ERROR	The difference of volume level among speakers is excessive.	Readjust the speaker installation so that all speakers are set in locations with similar conditions.	—
		Check the speaker connections.	14
		Use speakers of similar quality.	—
		Adjust the output volume of the subwoofer.	32

Notes

- If the "ERROR" or "WARNING" screens appears, check the cause of the problem, then run "AUTO SETUP" again.
- If warning "W-1" appears, corrections are made, but they may not be optimal.
- If warning "W-2" or "W-3" appears, no corrections are made.
- If error "E-10" occurs repeatedly, please contact a qualified YAMAHA service center.

RESETTING THE SYSTEM

Use this feature to reset all the parameters of this unit to the initial factory settings.

Notes

- This procedure completely resets all the parameters of this unit including the “SET MENU” parameters. However, the advanced setup menu parameters will not be initialized.
- The initial factory settings are activated next time you turn on this unit.



To cancel the initialization procedure at any time without making any changes, press MASTER ON/OFF on the front panel to release it outward to the OFF position.

(U.S.A. model)

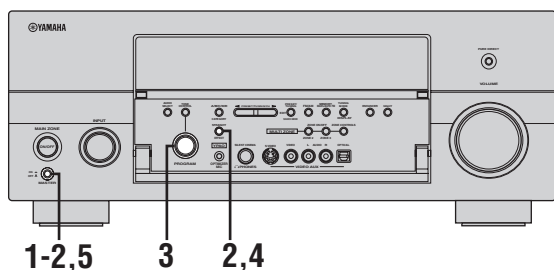

- 1 Press MASTER ON/OFF on the front panel to release it outward to the OFF position to turn off this unit.**



- 2 Press and hold STRAIGHT on the front panel and then press MASTER ON/OFF inward to the ON position to turn on this unit.**

This unit turns on, and the advanced setup menu appears in the front panel display.



- 3 Rotate the PROGRAM selector on the front panel to select “PRESET”.**



USER PRESET
CANCEL

- 4 Press STRAIGHT on the front panel repeatedly to select “RESET”.**



USER PRESET
RESET



Select “CANCEL” to cancel the initialization procedure without making any changes.

- 5 Press MASTER ON/OFF on the front panel to release it outward to the OFF position to confirm your selection and turn off this unit.**



GLOSSARY

■ Bi-amplification connection

A bi-amplification connection uses two amplifiers for a speaker. One amplifier is connected to the woofer section of a loudspeaker while the other is connected to the combined mid and tweeter section. With this arrangement each amplifier operates over a restricted frequency range. This restricted range presents each amplifier with a much simpler job and each amplifier is less likely to influence the sound in some way. The internal crossover of the speaker consists of a LPF (low pass filter) and a HPF (high pass filter). As its name implies, the LPF passes frequencies below a cutoff and rejects frequencies above the cutoff frequency. Likewise, the HPF passes frequencies above its cutoff.

■ Component video signal

With the component video signal system, the video signal is separated into the Y signal for the luminance and the Pb and Pr signals for the chrominance. Color can be reproduced more faithfully with this system because each of these signals is independent. The component signal is also called the “color difference signal” because the luminance signal is subtracted from the color signal. A monitor with component input jacks is required in order to output component signals.

■ Composite video signal

With the composite video signal system, the video signal is composed of three basic elements of a video picture: color, brightness and synchronization data. A composite video jack on a video component transmits these three elements combined.

■ Dialogue normalization

Dialogue Normalization is a feature of Dolby Digital or DTS, which is used to keep the programs at the same average listening level so the user does not have to change the volume control between Dolby Digital or DTS programs.

■ Dolby Digital

Dolby Digital is a digital surround sound system that gives you completely independent multi-channel audio. With 3 front channels (front L/R and center), and 2 surround stereo channels, Dolby Digital provides 5 full-range audio channels. With an additional channel especially for bass effects, called LFE (Low Frequency Effect), the system has a total of 5.1-channels (LFE is counted as 0.1 channel). By using 2-channel stereo for the surround speakers, more accurate moving sound effects and surround sound environment are possible than with Dolby Surround. The wide dynamic range from maximum to minimum volume reproduced by the 5 full-range channels and the precise sound orientation generated using digital sound processing provide listeners with unprecedented excitement and realism. With this unit, any sound environment from monaural up to a 5.1-channel configuration can be freely selected for your enjoyment.

■ Dolby Digital EX

Dolby Digital EX creates 6 full-bandwidth output channels from 5.1-channel sources. This is done using a matrix decoder that derives 3 surround channels from the 2 in the original recording. For the best results, Dolby Digital EX should be used with movie sound tracks recorded with Dolby Digital Surround EX. With this additional channel, you can experience more dynamic and realistic moving sound especially with scenes with “fly-over” and “fly-around” effects.

■ Dolby Pro Logic II

Dolby Pro Logic II is an improved technique used to decode vast numbers of existing Dolby Surround sources. This new technology enables a discrete 5-channel playback with 2 front left and right channels, 1 center channel, and 2 surround left and right channels instead of only 1 surround channel for conventional Pro Logic technology. There are three modes available: “Music mode” for music sources, “Movie mode” for movie sources and “Game mode” for game sources.

■ Dolby Pro Logic IIx

Dolby Pro Logic IIx is a new technology enabling discrete multi-channel playback from 2-channel or multi-channel sources. There are three modes available: “Music mode” for music sources, “Movie mode” for movie sources (for 2-channel sources only) and “Game mode” for game sources.

■ Dolby Surround

Dolby Surround uses a 4-channel analog recording system to reproduce realistic and dynamic sound effects: 2 front left and right channels (stereo), a center channel for dialog (monaural), and a surround channel for special sound effects (monaural). The surround channel reproduces sound within a narrow frequency range. Dolby Surround is widely used with nearly all video tapes and laser discs, and in many TV and cable broadcasts as well. The Dolby Pro Logic decoder built into this unit employs a digital signal processing system that automatically stabilizes the volume on each channel to enhance moving sound effects and directionality.

■ DSD

Direct Stream Digital (DSD) technology stores audio signals on digital storage media, such as Super Audio CDs. Using DSD, signals are stored as single bit values at a high-frequency sampling rate of 2.8224 MHz, while noise shaping and oversampling are used to reduce distortion, a common occurrence with very high quantization of audio signals. Due to the high sampling rate, better audio quality can be achieved than that offered by the PCM format used for normal audio CDs.

■ DTS 96/24

DTS 96/24 offers an unprecedented level of audio quality for multi-channel sound on DVD video, and is fully backward-compatible with all DTS decoders. “96” refers to a 96 kHz sampling rate compared to the typical 48 kHz sampling rate. “24” refers to 24-bit word length.

DTS 96/24 offers sound quality transparent to the original 96/24 master, and 96/24 5.1-channel sound with full-quality full-motion video for music programs and motion picture soundtracks on DVD video.

■ DTS (Digital Theater Systems) Digital Surround

DTS digital surround was developed to replace the analog soundtracks of movies with a 6.1-channel digital sound track, and is now rapidly gaining popularity in movie theaters around the world. Digital Theater Systems Inc. has developed a home theater system so that you can enjoy the depth of sound and natural spatial representation of DTS digital surround in your home. This system produces practically distortion-free 6.1-channel sound (technically, front left and right, center, surround left and right, and LFE 0.1 (subwoofer) channels for a total of 5.1 channels). This unit incorporates a DTS-ES decoder that enables 6.1-channel reproduction by adding the surround back channel to the existing 5.1-channel format.

■ HDMI

HDMI (High-Definition Multimedia Interface) is the first industry-supported, uncompressed, all-digital audio/video interface. Providing an interface between any source (such as a set-top box or AV receiver) and an audio/video monitor (such as a digital television), HDMI supports standard, enhanced or high-definition video as well as multi-channel digital audio using a single cable. HDMI transmits all ATSC HDTV standards and supports 8-channel digital audio, with bandwidth to spare to accommodate future enhancements and requirements. When used in combination with HDCP (High-bandwidth Digital Content Protection), HDMI provides a secure audio/video interface that meets the security requirements of content providers and system operators. For further information on HDMI, visit the HDMI website at “<http://www.hdmi.org/>”.

■ LFE 0.1 channel

This channel reproduces low-frequency signals. The frequency range of this channel is from 20 Hz to 120 Hz. This channel is counted as 0.1 because it only enforces a low-frequency range compared to the full-range reproduced by the other 5/6 channels in Dolby Digital or DTS 5.1/6.1-channel systems.

■ Neo:6

Neo:6 decodes the conventional 2-channel sources for 6-channel playback by the specific decoder. It enables playback with the full-range channels with higher separation just like digital discrete signal playback. There are two modes available: “Music mode” for music sources and “Cinema mode” for movie sources.

■ Neural Surround

Neural Surround™ represents the latest advancement in surround technology and has been adopted by XM Satellite Radio for digital radio broadcast of surround recordings and live events in surround sound. Neural Surround™ employs psychoacoustic frequency domain processing which allows delivery of a more detailed sound stage with superior channel separation and localization of audio elements. System playback is scalable from 5.1 to 7.1 multi-channel surround playback.

■ PCM (Linear PCM)

Linear PCM is a signal format under which an analog audio signal is digitized, recorded and transmitted without using any compression. This is used as a method of recording CDs and DVD audio. The PCM system uses a technique for sampling the size of the analog signal per very small unit of time. Standing for “Pulse Code Modulation”, the analog signal is encoded as pulses and then modulated for recording.

■ Sampling frequency and number of quantized bits

When digitizing an analog audio signal, the number of times the signal is sampled per second is called the sampling frequency, while the degree of fineness when converting the sound level into a numeric value is called the number of quantized bits. The range of rates that can be played back is determined based on the sampling rate, while the dynamic range representing the sound level difference is determined by the number of quantized bits. In principle, the higher the sampling frequency, the wider the range of frequencies that can be played back, and the higher the number of quantized bits, the more finely the sound level can be reproduced.

■ S-video signal

With the S-video signal system, the video signal normally transmitted using a pin cable is separated and transmitted as the Y signal for the luminance and the C signal for the chrominance through the S-video cable. Using the S VIDEO jack eliminates video signal transmission loss and allows recording and playback of even more beautiful images.

SOUND FIELD PROGRAM INFORMATION

■ Elements of a sound field

What really creates the rich, full tones of a live instrument are the multiple reflections from the walls of the room. In addition to making the sound live, these reflections enable us to tell where the player is situated as well as the size and shape of the room in which we are sitting.

There are two distinct types of sound reflections that combine to make up the sound field in addition to the direct sound coming straight to our ears from the player's instrument.

Early reflections

Reflected sounds reach our ears extremely rapidly (50 ms to 100 ms after the direct sound), after reflecting from one surface only (for example, from a wall or the ceiling).

Early reflections actually add clarity to the direct sound.

Reverberations

These are caused by reflections from more than one surface (for example, from the walls, and the ceiling) so numerous that they merge together to form a continuous sonic afterglow. They are non-directional and lessen the clarity of the direct sound.

Direct sound, early reflections and subsequent reverberations taken together help us to determine the subjective size and shape of the room, and it is this information that the digital sound field processor reproduces in order to create sound fields.

If you could create the appropriate early reflections and subsequent reverberations in your listening room, you would be able to create your own listening environment. The acoustics in your room could be changed to those of a concert hall, a dance floor, or a room with virtually any size at all. This ability to create sound fields at will is exactly what YAMAHA has done with the digital sound field processor.

■ CINEMA DSP

Since the Dolby Surround and DTS systems were originally designed for use in movie theaters, their effect is best felt in a theater having many speakers designed for acoustic effects. Since home conditions, such as room size, wall material, number of speakers, and so on, can differ so widely, it is inevitable that there are differences in the sound heard. Based on a wealth of actually measured data, YAMAHA CINEMA DSP uses YAMAHA original sound field technology to combine Dolby Pro Logic, Dolby Digital and DTS systems to provide the audiovisual experience of a movie theater in the listening room of your own home.

■ SILENT CINEMA

YAMAHA has developed a natural, realistic sound effect DSP algorithm for headphones. Parameters for headphones have been set for each sound field so that accurate representations of all the sound field programs can be enjoyed on headphones.

■ Virtual CINEMA DSP

YAMAHA has developed a Virtual CINEMA DSP algorithm that allows you to enjoy DSP sound field surround effects even without any surround speakers by using virtual surround speakers. It is even possible to enjoy Virtual CINEMA DSP using a minimal two-speaker system that does not include a center speaker.

■ Sound output from each speaker

Sound output from each speaker depends on the type of audio signals being input. Refer to the diagrams in the table below to understand the speaker layout for each sound field program. For details about the sound output from each speaker in sound field programs, refer to "SOUND OUTPUT IN EACH SOUND FIELD PROGRAM" in "APPENDIX" at the end of this manual.

Note

Be advised that there may be no or not enough sound output from speakers depending on the type of input source being played back. Furthermore, there may be some channels that can only be used partially when they are adjusted to specific aspects of movies, such as special sound effects, etc.



Except for "2ch Stereo", "7ch Stereo", and "STRAIGHT", you can select a decoder to output sound from the surround back speakers (see page 45).

PARAMETRIC EQUALIZER INFORMATION

This unit employs YAMAHA Parametric Room Acoustic Optimizer (YPAO) technology, together with the Parametric EQ settings (see page 91), to optimize the frequency characteristics of its parametric equalizer to match your listening environment. YPAO uses a combination of the following three parameters (Frequency, Gain and Q factor) to provide highly precise adjustment of the frequency characteristics.

■ Frequency

This parameter is adjustable in one-third octave increments between 32 Hz and 16 kHz.

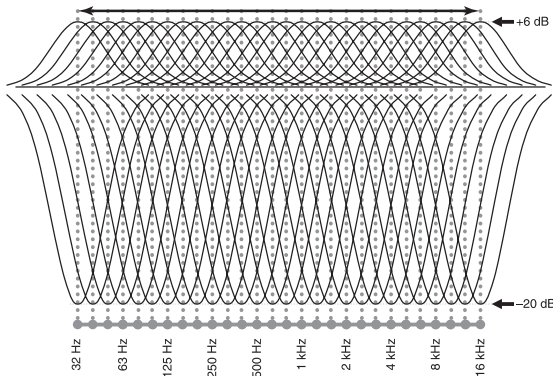

■ Gain

This parameter is adjustable in increments of 0.5 dB between -20 and +6 dB.

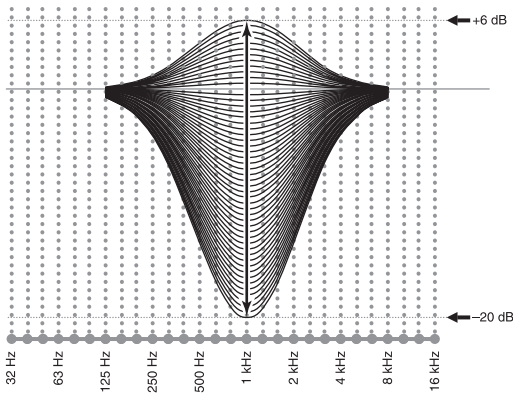

■ Q factor

The width of the specified frequency band is referred to as the Q factor. This parameter is adjustable between the values 0.5 and 10.

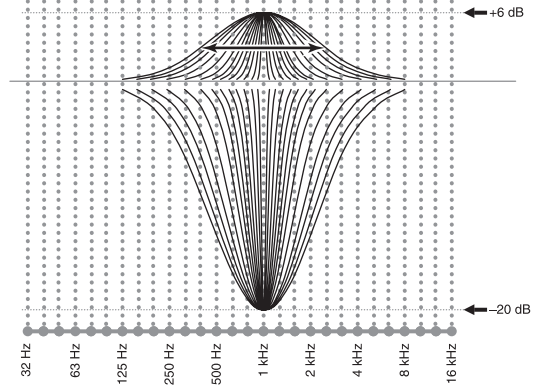

YPAO adjusts frequency characteristics to suit your listening requirements using a combination of the above three parameters (Frequency, Gain and Q factor) for each equalizer band in this unit's parametric equalizer. This unit has 7 equalizer bands for each channel.

The use of multiple equalizer bands enables more precise adjustments of frequency characteristics (as in Figure 2). This is not possible using only a single equalizer band (as in Figure 1).

Figure 1

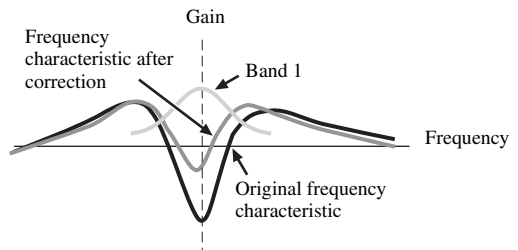
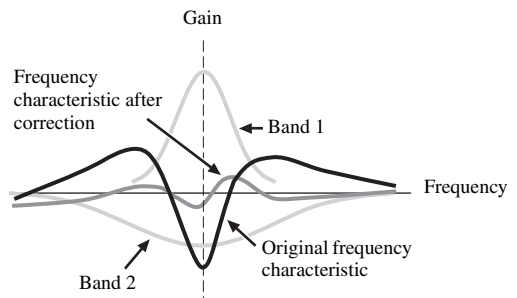

Figure 2



SPECIFICATIONS

AUDIO SECTION

- Minimum RMS Output Power for Front, Center, Surround, Surround back
20 Hz to 20 kHz, 0.04% THD, 8 Ω 130 W
- Dynamic Power (IHF)
8/6/4/2 Ω 160/195/255/335 W
- Maximum Useful Output Power (JEITA)
[Asia, General, China and Korea models]
1 kHz, 10% THD, 8 Ω 175 W
- Maximum Output Power [U.K. and Europe models]
1 kHz, 0.7% THD, 4 Ω 180 W
- Dynamic Headroom
8 Ω 0.9 dB
- IEC Output Power [U.K. and Europe models]
1 kHz, 0.04% THD, 8 Ω 130 W
- Damping Factor (IHF)
20 Hz to 20 kHz, 8 Ω 150 or more
- Input Sensitivity/Input Impedance
PHONO 3.5 mV/47 kΩ
CD, etc. 200 mV/47 kΩ
MULTI CH INPUT 200 mV/47 kΩ
- Maximum Input Voltage
PHONO (1 kHz, 0.1% THD) 60 mV or more
CD, etc. (1 kHz, 0.5% THD) 2.4 V or more
- Rated Output Voltage/Output Impedance
OUT (REC) 200 mV/900 Ω
PRE OUT 1.0 V/1.2 kΩ
SUBWOOFER 2.0 V/1.2 kΩ
ZONE 2/ZONE 3 OUT 1.0 V/1.4 kΩ
- Headphone Jack Rated Output/Impedance
CD, etc. (1 kHz, 40 mV, 8 Ω) 150 mV/100 Ω
- Frequency Response
CD to Front L/R, Pure Direct 10 Hz to 100 kHz, +0/-3 dB
- RIAA Equalization Deviation
PHONO (20 Hz to 20 kHz) 0 ± 0.5 dB
- Total Harmonic Distortion
PHONO to OUT (REC)
(20 Hz to 20 kHz, 1 V) 0.02% or less
CD, etc. to Front L/R
(20 Hz to 20 kHz, 65 W, 8 Ω) 0.04% or less
- Signal to Noise Ratio (IHF-A Network)
PHONO (5 mV) to Front L/R
[Australia, U.K. and Europe models] 81 dB or more
[Other models] 86 dB or more
CD, etc. (250 mV) to Front L/R 100 dB or more
- Residual Noise (IHF-A Network)
Front L/R 150 μV or less
- Channel Separation (1 kHz/10 kHz)
PHONO (shortened) to Front L/R 60 dB/55 dB or more
CD, etc.
(5.1 kΩ shortened) to Front L/R 60 dB/45 dB or more

- Tone Control (Front L/R)
BASS Boost/Cut ±6 dB/50 Hz
BASS Turnover Frequency 350 Hz
TREBLE Boost/Cut ±6 dB/20 kHz
TREBLE Turnover Frequency 3.5 kHz
- Zone 2/Zone 3 Tone Control (Front L/R)
BASS Boost/Cut ±10 dB/100 Hz
BASS Turnover Frequency 450 Hz
TREBLE Boost/Cut ±10 dB/10 kHz
TREBLE Turnover Frequency 2.0 kHz
- Filter Characteristics (fc=40/60/80/90/100/110/120/160/200 Hz)
H.P.F. (Front, Center, Surround, Surround back) 12 dB/oct.
L.P.F. (Subwoofer) 24 dB/oct.

VIDEO SECTION

- Video Format (Gray Back)
[U.S.A., Canada, General and Korea models] NTSC
[U.K., Europe, Australia, Asia and China models] PAL
- Video Format (Video Conversion) NTSC/PAL
- Signal Level
Composite 1 Vp-p/75 Ω
S-video 1 Vp-p/75 Ω (Y), 0.286 Vp-p/75 Ω (C)
Component 1 Vp-p/75 Ω (Y), 0.7 Vp-p/75 Ω (Pb/PbR)
- Maximum Input Level (Video Conversion Off) 1.5 Vp-p or more
- Signal to Noise Ratio (Video Conversion Off) 60 dB or more
- Frequency Response (MONITOR OUT)
Component (Video Conversion Off) 5 Hz to 100 MHz, ±3 dB

FM SECTION

- Tuning Range
[U.S.A. and Canada models] 87.5 to 107.9 MHz
[Asia and General models] 87.5/87.50 to 108.0/108.00 MHz
[Other models] 87.50 to 108.00 MHz
- 50 dB Quieting Sensitivity (IHF)
Mono/Stereo 2.0/25 μV (17.3/39.2 dBf)
- Usable Sensitivity (IHF) 1.0 μV (11.2 dBf)
- Selectivity (400 kHz) 70 dB
- Signal to Noise Ratio (IHF)
Mono/Stereo 76 dB/70 dB
- Harmonic Distortion (1 kHz)
Mono/Stereo 0.2/0.3%
- Stereo Separation (1 kHz)
Stereo 42 dB
- Frequency Response
Stereo 20 Hz to 15 kHz, +0.5, -2 dB
- Antenna Input (unbalanced) 75 Ω

AM SECTION

- Tuning Range
[U.S.A. and Canada models] 530 to 1710 kHz
[Asia and General models] 530/531 to 1710/1611 kHz
[Other models] 531 to 1611 kHz
- Usable Sensitivity 300 μV/m

GENERAL

- Power Supply
 - [U.S.A. and Canada models] AC 120 V, 60 Hz
 - [General and Asia model]
 - AC 110/120/220/230–240 V, 50/60 Hz
 - [China model] AC 220 V, 50 Hz
 - [Korea model] AC 220 V, 60 Hz
 - [Australia model] AC 240 V, 50 Hz
 - [U.K. and Europe models] AC 230 V, 50 Hz
- Power Consumption
 - [U.S.A. and Canada models] 500 W/630 VA
 - [Other models] 500 W
- Standby Power Consumption
 - [U.S.A. and Canada models] 0.1 W or less
 - [General model] (AC 240 V, 50 Hz) 0.33 W or less
 - [Other models] 0.1 W or less
- Maximum Power Consumption [General model only]
 - 6ch, 10% THD 1100 W
- AC Outlets
 - [U.S.A. and Canada models] 2 (Total 100 W/0.8 A maximum)
 - [Asia, General and China models] 2 (Total 50 W maximum)
 - [Australia and U.K. models] 1 (Total 100 W/0.4 A maximum)
 - [Europe model] 2 (Total 100 W/0.4 A maximum)
- Dimensions (W x H x D) 435 x 171 x 438.5 mm
(17.1 x 6.7 x 17.3 in)
- Weight 17.0 kg (38.8 lbs)

* Specifications are subject to change without notice.

We Want You Listening For A Lifetime

YAMAHA and the Electronic Industries Association's Consumer Electronics Group want you to get the most out of your equipment by playing it at a safe level. One that lets the sound come through loud and clear without annoying blaring or distortion – and, most importantly,

without affecting your sensitive hearing. Since hearing damage from loud sounds is often undetectable until it is too late, YAMAHA and the Electronic Industries Association's Consumer Electronics Group recommend you to avoid prolonged exposure from excessive volume levels.

SOUND OUTPUT IN EACH SOUND FIELD PROGRAM

- L Front left speaker
- SL Surround left speaker
- SBR Surround back right speaker
- C Center speaker
- SR Surround right speaker
- PL Presence left speaker
- R Front right speaker
- SBL Surround back left speaker
- PR Presence right speaker
- Speaker from which sound is being output
- Speaker from which no sound is being output

*1 EX / PL II x / DTS = OFF

*2 EX / PL II x / DTS = ON, PRIORITY: PRNS

*3 EX / PL II x / DTS = ON, PRIORITY: SB

Program	Input source				
	2-channel audio (monaural)	2-channel audio (stereo)	5.1/6.1-channel audio *1	5.1/6.1-channel audio *2	5.1/6.1-channel audio *3
CLASSICAL Hall in Munich Hall in Vienna Hall in Amsterdam Church in Freiburg Chamber LIVE/CLUB Village Vanguard Warehouse Loft Cellar Club The Roxy Theatre The Bottom Line					
ENTERTAINMENT Sports Action Game Roleplaying Game Music Video Recital/Opera					
MOVIE STANDARD (PRO LOGIC)					
			(Dolby Digital) / (DTS)	(Dolby Digital) / (DTS)	(Dolby Digital) / (DTS)

Program	Input source				
	2-channel audio (monaural)	2-channel audio (stereo)	5.1/6.1-channel audio *1	5.1/6.1-channel audio *2	5.1/6.1-channel audio *3

MOVIE
STANDARD
 (PLII Movie)
 (PLIix Movie)
 (Neo:6 Cinema)

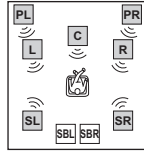
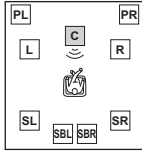

PRIORITY: PRNS

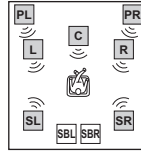

(Dolby Digital)
/ (DTS)

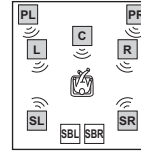

(Dolby Digital)
/ (DTS)

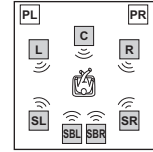

(Dolby Digital)
/ (DTS)

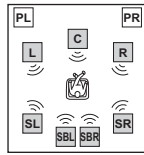

PRIORITY: SB

MOVIE
 Spectacle
 Sci-Fi
 Adventure
 Drama
 Mono Movie

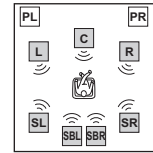
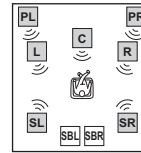
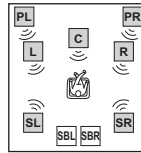
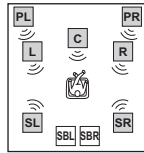
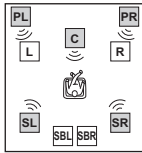

STEREO
 2ch Stereo

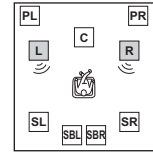
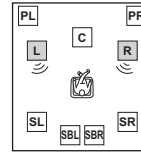
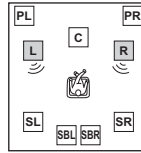
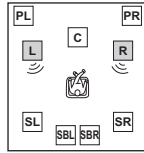
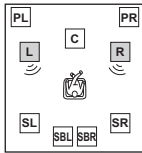

Monaural playback

STEREO
 7ch Stereo

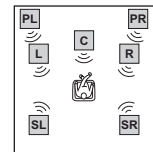
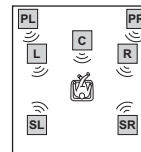
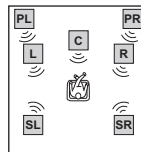
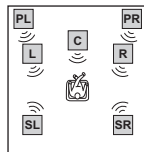
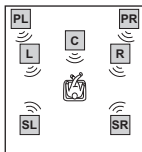
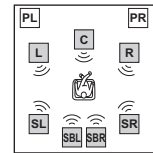
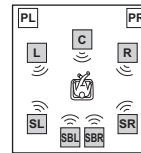
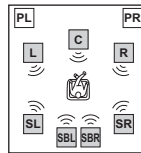
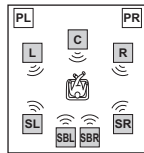
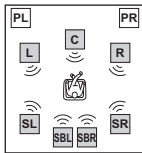

Program	Input source				
	2-channel audio (monaural)	2-channel audio (stereo)	5.1/6.1-channel audio *1	5.1/6.1-channel audio *2	5.1/6.1-channel audio *3

SURROUND DECODE PRO LOGIC

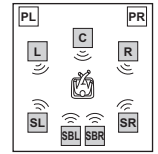
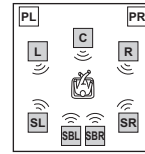
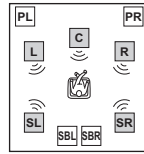
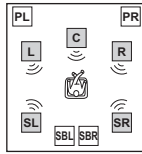
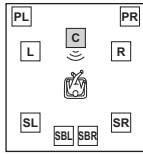

PRO LOGIC

Dolby Digital / DTS

Dolby Digital / DTS

Dolby Digital / DTS

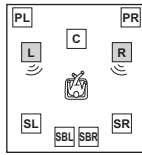

Dolby Digital / DTS

**SURROUND DECODE PLII Movie
PLII Music
PLII Game**

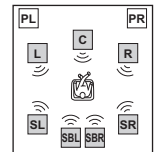
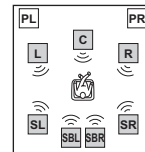
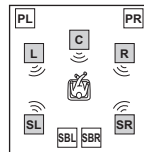
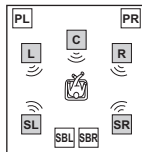
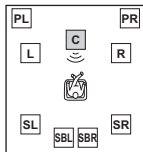

Movie/Game

Movie/Music/Game

Dolby Digital / DTS

Dolby Digital / DTS

Dolby Digital / DTS

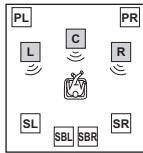

Music

**SURROUND DECODE PLIIX Movie
PLIIX Music
PLIIX Game**

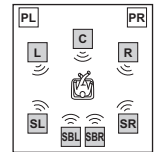
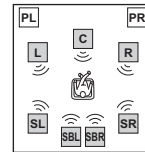
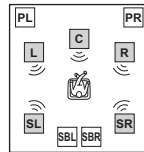
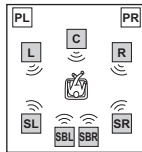
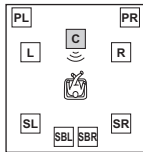

Movie/Game

Movie/Music/Game

Dolby Digital / DTS

Dolby Digital / DTS

Dolby Digital / DTS

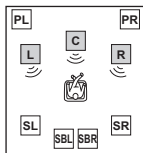

Music

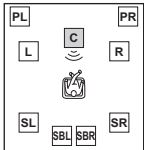
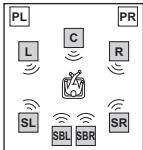
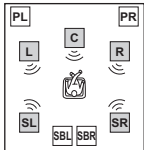
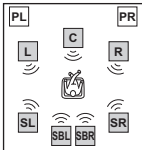
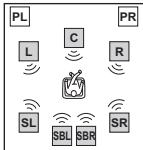
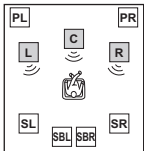
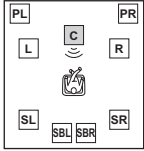
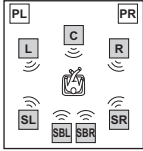
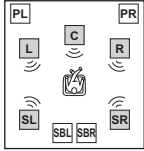
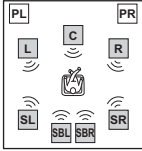
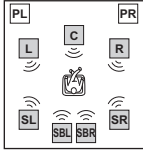
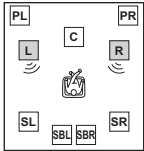
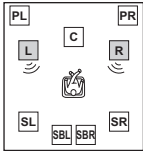
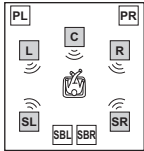
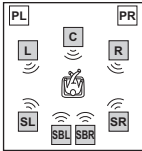
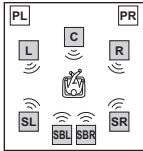
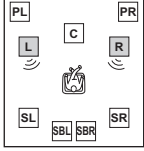
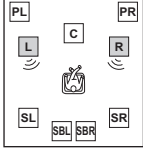
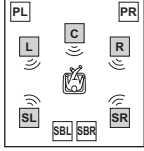
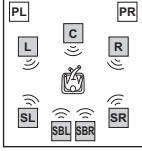
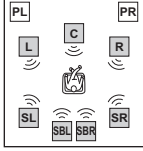
Program	Input source				
	2-channel audio (monaural)	2-channel audio (stereo)	5.1/6.1-channel audio *1	5.1/6.1-channel audio *2	5.1/6.1-channel audio *3
SURROUND DECODE Neo:6 Cinema Neo:6 Music					
	Cinema	Cinema/Music	Dolby Digital / DTS	Dolby Digital / DTS	Dolby Digital / DTS
		Music			
SURROUND DECODE neural sur.					
			Dolby Digital / DTS	Dolby Digital / DTS	Dolby Digital / DTS
STRAIGHT					
	Monaural playback				
PURE DIRECT					
	Monaural playback				

LIST OF REMOTE CONTROL CODES

CABLE

ABC 0030, 0035
 AMERICAST 0926
 BELL SOUTH 0926
 BIRMINGHAM CABLE COMMUNICATIONS 0303
 BRITISH TELECOM 0030
 CABLE & WIRELESS 1095
 DAERYUNG 0035, 0504, 0904, 1904
 DIRECTOR 0503
 FILMNET 0470
 GENERAL INSTRUMENT 0030, 0303, 0503, 0837,
 GOLDSTAR 0171
 HAMLIN 0036, 0300
 JERROLD 0030, 0303, 0503, 0837
 LG 0171
 MNET 0470
 MEMOREX 0027
 MOTOROLA 0303, 0503, 0837, 1133
 NTL 1095
 NOOS 0844
 ONO 1095
 PVP STEREO VISUAL MATRIX 0030
 PACE 0264, 1087, 1095
 PANASONIC 0027, 0035, 0134
 PARAGON 0027
 PHILIPS 0332, 0344
 PIONEER 0171, 0560, 0904, 1904
 PULSAR 0027
 QUASAR 0027
 REGAL 0300, 0306
 RUNCO 0027
 SAGEM 0844
 SAMSUNG 0027, 0171
 SCIENTIFIC ATLANTA 0035, 0504, 0904, 1904
 SONY 1033
 STARCOM 0030
 SUPERCABLE 0303
 TS 0030
 TELE+1 0470
 TELEWEST 1095
 TORX 0030
 TOSHIBA 0027
 TRANS PX 0303
 UNITED CABLE 0030
 ZENITH 0027, 0552, 0926

CD PLAYER

AIWA 0184
 ARCAM 0184
 AUDIO RESEARCH 0184
 AUDIO TON 0184
 AUDIOLAB 0184
 AUDIOMECA 0184
 CAIRN 0184

CALIFORNIA AUDIO LABS

0056
 CARVER 0184, 0206
 CYRUS 0184
 DKK 0027
 DMX ELECTRONICS 0184
 DENON 0900
 DYNAMIC BASS 0206
 EMERSON 0332
 FISHER 0206
 GENEXXA 0059, 0332
 GOODMANS 0332
 GRUNDIG 0184
 HARMAN/KARDON 0184, 0200
 HITACHI 0059
 JVC 0099
 KENWOOD 0055, 0064
 KRELL 0184
 LXI 0332
 LINN 0184
 MCS 0056
 MAGNAVOX 0184, 0332
 MARANTZ 0056, 0184
 MATSUI 0184
 MEMOREX 0332
 MERIDIAN 0184
 MICROMEGA 0184
 MIRO 0027
 MISSION 0184
 MYRYAD 0184
 NAD 0027
 NSM 0184
 NAIM 0184
 OPTIMUS 0027, 0059, 0064, 0206, 0332
 PANASONIC 0056
 PHILIPS 0184
 PIONEER 0059, 0332
 POLK AUDIO 0184
 PROTON 0184
 QED 0184
 QUAD 0184
 QUASAR 0056
 RCA 0059, 0206, 0332
 REALISTIC 0206
 REVOX 0184
 ROTEL 0184
 SAE 0184
 SANSUI 0184, 0332
 SANYO 0206
 SCOTT 0332
 SEARS 0332
 SHARP 0064
 SIMAUDIO 0184
 SONIC FRONTIERS 0184
 SONY 0027
 SYMPHONIC 0332
 TAG MCLAREN 0184
 TANDY 0059
 TECHNICS 0056
 THORENS 0184
 THULE 0184
 UNIVERSUM 0184
 VICTOR 0099
 WARDS 0184
 YAMAHA 2300, 2301

CD RECORDER

KENWOOD 0653
 MARANTZ 0653
 PHILIPS 0653
 YAMAHA 2400

DVD PLAYER

ACOUSTIC SOLUTIONS 0757
 ALBA 0744
 AMSTRAD 0740
 APEX DIGITAL 0699, 0744, 0782, 0821, 0823, 0857, 1127
 BLAUPINKT 0744
 BLUE PARADE 0598
 BUSH 0740
 CENTREX 0699
 CLATRONIC 0815
 CYBERHOME 0741
 DVD2000 0548
 DAEWOO 0811, 0797
 DANSAI 0797
 DECCA 0797
 DENON 0517
 DIAMOND 0795
 DIGITREX 0699
 EMERSON 0618
 ENTERPRISE 0618
 FISHER 0697
 GE 0549, 0744
 GO VIDEO 0742
 GOLDSTAR 0768
 GRADIENTE 0678
 GREENHILL 0744
 GRUNDIG 0566
 HITACHI 0600, 0691
 HITEKER 0699
 JVC 0585, 0650
 KLH 0744
 KENWOOD 0517, 0561
 KOSS 0678
 LG 0768
 LIMIT 0795
 MAGNAVOX 0530, 0702
 MARANTZ 0566
 MEMOREX 0858
 MICO 0750
 MICROSOFT 0549
 MINTEK 0744
 MITSUBISHI 0548
 MUSTEK 0757
 NESA 0744
 ONKYO 0530
 ORITRON 0678
 PALSONIC 0699
 PANASONIC 0517, 0659, 1389
 PHILIPS 0530, 0566, 0673, 0881
 PIONEER 0552, 0598, 0658, 0659
 POLK AUDIO 0566
 PROSCAN 0549
 QWESTAR 0678
 RCA 0549, 0598, 0744
 ROTEL 0650

SM ELECTRONIC 0757
 SAMSUNG 0600
 SANYO 0697
 SHARP 0657
 SHERWOOD 0797
 SHINSONIC 0560
 SLIM ART 0811
 SONY 0560, 0891
 SYLVANIA 0702
 TATUNG 0797
 TEAC 0598, 0744
 TECHNICS 0517
 THETA DIGITAL 0598
 THOMSON 0549
 TOSHIBA 0530
 URBAN CONCEPTS 0530
 XBOX 0549
 YAMAHA 0517, 0566, 0572, 2100
 ZENITH 0530, 0618, 0768
 ZEUS 0811

DVD RECORDER

HITACHI 2815
 PANASONIC 2800, 2801, 2802
 PHILIPS 2808
 PIONEER 2804, 2805, 2806
 SHARP 2812, 2813
 SONY 2809, 2810, 2811
 TOSHIBA 2803
 VICTOR 2814
 YAMAHA 2807

LD PLAYER

CARVER 0091
 DENON 0086
 MARANTZ 0091
 MITSUBISHI 0086
 NAD 0086
 NAGSMI 0086
 OPTIMUS 0086
 PHILIPS 0091
 PIONEER 0086
 SALORA 0091
 SONY 0228
 TELEFUNKEN 0086
 YAMAHA 2200

MD RECORDER

KENWOOD 0708
 ONKYO 0895
 SHARP 0888
 SONY 0517
 YAMAHA 2500, 2501, 2502

RECEIVER (TUNER)

ADC 0558
 AIWA 0185, 1116, 1415, 1432, 1668
 ALCO 1417
 ANAM 1636
 APEX DIGITAL 1284
 AUDIOLAB 1216
 AUDIOTRONIC 1216
 AUDIOVOX 1417
 BOSE 1256

CAMBRIDGE SOUNDWORKS 1397
 CAPETRONIC 0558
 CARVER 1116, 1216
 CENTREX 1284
 DENON 1387
 FERGUSON 0558
 FINE ARTS 1216
 GRUNDIG 1216
 HARMAN/KARDON 0137, 1331
 INTEGRA 0162, 1325
 JBL 0137, 1333
 JVC 0101, 0558, 1401, 1522
 KLH 1417, 1439
 KENWOOD 1054, 1340
 MCS 0066
 MAGNAVOX 0558, 1116, 1216, 1296,
 MARANTZ 0066, 1116, 1216, 1316
 MICROMEGA 1216
 MUSICMAGIC 1116
 MYRYAD 1216
 NAD 0347
 NORCENT 1416
 ONKYO 0162, 0869, 1325
 OPTIMUS 0558, 1050
 PANASONIC 0066, 1315, 1545, 1790
 PHILIPS 1116, 1216, 1293, 1295, 1296, 1310, 1316
 PIONEER 0041, 0558, 1050, 1411
 POLK AUDIO 1316
 PROSCAN 1281
 QUASAR 0066
 RCA 0558, 1050, 1281, 1417, 1636,
 SABA 0558
 SANSUI 1116
 SCHNEIDER 0558
 SONY 0185, 1085, 1185, 1685, 1785
 STEREOPHONICS 1050
 SUNFIRE 1340
 TEAC 1417
 TECHNICS 0066, 1335, 1336, 1545
 TELEFUNKEN 0558
 THOMSON 1281
 THORENS 1216
 UHER 0558
 VENTURER 1417
 VICTOR 0101
 WARDS 0041, 0185
 YAMAHA 0203, 1203, 1358, 2601
 (TUNER ID1) 2602
 (TUNER ID2) 2603
 (XM ID1) 2604
 (XM ID2) 2605
 (iPod) 2606

SATELLITE TUNER

@SAT 1327
 ABSAT 0150
 ALBA 0482
 ALPHASTAR 0799
 AMSTRAD 0874
 ASTON 0169, 1156
 ASTRO 0200

ATSAT 1327
 AVALON 0423
 BLAUPUNKT 0200
 BRITISH SKY BROADCASTING 0874, 1202
 CANAL DIGITAL 0880
 CANAL SATELLITE 0880
 CANAL+ 0880
 CHAPARRAL 0243
 CITYCOM 1203
 CONNEXIONS 0423
 CROSSDIGITAL 1136
 CYRUS 0227
 D-BOX 0750, 1154
 DMT 1102
 DNT 0227, 0423
 DAERYUNG 0423
 DAEWOO 1323
 DIGENIUS 0326
 DIRECTV 0274, 0419, 0593, 0666, 0751, 0776, 0846, 1103, 1136, 1169, 1776, 1883
 DISH NETWORK SYSTEM 0802, 1032
 DISHPRO 0802, 1032
 DISTRATEL 0111
 DREAM MULTIMEDIA 1264
 ECHOSTAR 0194, 0423, 0637, 0802, 0880, 0898, 1032, 1113
 ENGEL 1044
 EXPRESSVU 0802
 FTE 0890
 FINLUX 0482
 FRACARRO 0898
 FUBA 0423
 GE 0593
 GOI 0802
 GALAXIS 0890, 1138
 GENERAL INSTRUMENT 0896
 GOLD BOX 0880
 GRUNDIG 0200, 0874
 HTS 0802
 HIRSCHMANN 0200, 0423
 HITACHI 0482, 0846
 HUGHES NETWORK SYSTEM 0776, 1169, 1776
 HUMAX 0890, 1203
 INVIDEO 0898
 JVC 0802
 KATHREIN 0150, 0200, 0227, 0276, 0685, 1248
 KREISELMEYER 0200
 LABGEAR 1323
 LOGIX 1044
 LORENZEN 0326
 MAGNAVOX 0749, 0751
 MANHATTAN 0482, 1044, 1110
 MARANTZ 0227
 MEDIASAT 0880
 MEMOREX 0751
 METRONIC 0111
 MITSUBISHI 0776
 MOTOROLA 0896
 MYRYAD 0227
 NEXT LEVEL 0896
 NOKIA 0482, 0750, 0778, 1154, 1250, 1750
 OCTALTV 1032

ORBITECH 1127
 PACE 0482, 0874, 1202, 1350
 PANASONIC 0274, 0728, 0874, 1347
 PANDA 0482
 PAYSAT 0751
 PHILIPS 0160, 0227, 0482, 0749, 0751, 0776, 0880, 1103, 1169, 1776
 PIONEER 0880
 PROMAX 0482
 PROSCAN 0419, 0593
 RCA 0170, 0419, 0593, 0882
 RFT 0227
 RADIOSHACK 0896
 RADIOLA 0227
 RADIX 0423
 SKY 0874, 0883, 1202
 SM ELECTRONIC 1227
 SABRE 0482
 SAGEM 0847, 1141, 1280
 SAMSUNG 1044, 1136, 1303, 1319
 SAT CONTROL 1327
 SATSTATION 1110
 SCHWAIGER 1138
 SEEMANN 0423
 SIEMENS 0200
 SONY 0666, 0874, 1666
 STAR CHOICE 0896
 STRONG 1327
 TPS 0847, 1280
 TANTEC 0482
 TECHNISAT 1126, 1127
 TELESTAR 1127
 THOMSON 0482, 0880, 1073, 1318
 TOPFIELD 1233
 TOSHIBA 0776, 0817, 1776
 ULTIMATETV 0419, 0666
 UNIDEN 0749, 0751
 UNIVERSUM 0200
 VENTANA 0227
 WISI 0200, 0423, 0482
 XSAT 0150
 ZEHNDER 1102
 ZENITH 0883, 1883

TAPE DECK

AIWA 0056
 CARVER 0056
 GRUNDIG 0056
 HARMAN/KARDON 0056
 MAGNAVOX 0056
 MARANTZ 0056
 MYRYAD 0056
 OPTIMUS 0054
 PHILIPS 0056
 PIONEER 0054
 POLK AUDIO 0056
 RCA 0054
 REVOK 0056
 SANSUI 0056
 SONY 0270
 THORENS 0056
 WARDS 0054
 YAMAHA 2700, 2701

TV

AGB 0543
 AOC 0036, 0057, 0087, 0119, 0120, 0135, 0205, 0207, 0478
 0131
 ASA 0036
 AWA 0036
 ACURA 0036
 ADDISON 0119, 0135, 0680
 ADMIRAL 0120, 0190, 0490
 ADVENT 0788
 AIKO 0119
 AKAI 0036, 0057, 0235, 0388, 0543, 0729, 0839
 AKURA 0291
 ALBA 0036, 0064, 0398, 0695
 AMERICA ACTION 0207
 AMPRO 0778
 AMSTRAD 0036, 0064, 0198, 0398, 0439, 0460, 0543
 ANAM 0036, 0207, 0277
 ANAM NATIONAL 0277, 0677
 ANITECH 0036
 APEX DIGITAL 0775, 0792, 0794
 AUDIOSONIC 0064, 0136
 BANG & OLUFSEN 0592
 BASIC 0036
 BAUR 0064, 0388, 0539
 BAYSONIC 0207
 BEAUMARK 0205
 BEKO 0397, 0513, 0741, 0742
 BELL & HOWELL 0181
 BEON 0064
 BLAUPUNKT 0222
 BLUE SKY 0695, 1064
 BONDSTEC 0274
 BRADFORD 0207
 BRANDT 0136, 0362
 BROKSONIC 0263, 0490
 BUSH 0036, 0064, 0398, 0401, 0695, 1064
 CCE 0064
 CGE 0274
 CTC 0274
 CXC 0207
 CANDLE 0057
 CARNIVALE 0057
 CARVER 0081, 0197
 CASCADE 0036
 CATHAY 0064
 CELEBRITY 0027
 CELERA 0792
 CENTURION 0064
 CHANGHONG 0792
 CHING TAI 0036, 0119
 CHUN YUN 0027, 0036, 0119, 0207
 CHUNG HSIN 0080, 0135, 0207
 CIMLINE 0036
 CINAL 0119, 0478
 CITIZEN 0057, 0087, 0119
 CLARION 0207
 CLARIVOX 0064
 CLATRONIC 0274, 0397
 CONDOR 0347, 0397
 CONRAC 0835

CONTEC	0036, 0207	GRANADA	0064, 0235, 0366, 0543	MAGNADYNE	0274, 0543	PHILIPS	0027, 0057, 0064, 0078, 0081, 0119, 0135, 0205, 0401, 0583, 0717, 1481
CRAIG	0207	GRANDIN	0637	MAGNAFON	0543		
CROSLLEY	0081	GRUNDIG	0064, 0222, 0514, 0583, 0614	MAGNAVOX	0057, 0081, 1281, 1481	PHONOLA	0064
CROWN	0036, 0064, 0207, 0397, 0445	GRUNPY	0207	MANESTH	0291, 0347	PILOT	0057
CURTIS MATHES	0057, 0074, 0081, 0087, 0120, 0172, 0181, 0193, 0478, 0729, 1174, 1374	HCM	0036, 0439	MARANTZ	0057, 0064, 0081, 0583	PIONEER	0136, 0190, 0193, 0314, 0706, 0787, 0893
DAEWOO	0036, 0057, 0064, 0119, 0135, 0181, 0197, 0205, 0207, 0401, 0478, 0650, 0661, 1688	HALLMARK	0205	MARK	0064	PORTLAND	0119
DANSAI	0064	HANKOOK	0057, 0205, 0207	MATSUI	0036, 0064, 0235, 0398, 0514, 0543	PRANDONI-PRINCE	0543
DAYTON	0036	HANSEATIC	0064, 0347, 0388, 0455, 0583	MATSUSHITA	0277, 0677	PRIMA	0788
DE GRAAF	0235, 0575	HANTAREX	0543	MEDIATOR	0064	PRISM	0078
DECCA	0064, 0543	HARMAN/KARDON	0081	MEDION	0695, 0835, 1064	PROFEX	0036, 0388
DENON	0172	HARVARD	0207	MEGATRON	0172, 0205	PROSCAN	0074
DIGATRON	0064	HAVERMY	0120	MEMOREX	0036, 0177, 0181, 0205, 0277, 0490, 1064	PROTECH	0036, 0064, 0274, 0291, 0445, 0695
DIXI	0036, 0064	HELLO KITTY	0478	METZ	0474	PROTON	0036, 0057, 0205
DUMONT	0044	HINARI	0036, 0064	MICROMAXX	0835	PULSAR	0044
DWIN	0747, 0801	HISAWA	0482	MICROSTAR	0835	QUASAR	0078, 0277, 0677
ECE	0064	HITACHI	0036, 0057, 0119, 0132, 0136, 0172, 0190, 0205, 0252, 0383, 0508, 0575, 0605, 1172, 1283	MIDLAND	0044, 0074, 0078	QUELLE	0064, 0131, 0388, 0539
ELBE	0286	HUA TUN	0036	MINERVA	0514	R-LINE	0064
ELECTROBAND	0027	HUANYU	0401	MINOKA	0439	RCA	0027, 0057, 0074, 0117, 0119, 0205, 0706, 1074, 1174, 1274, 1374, 1474, 1481, 1574
ELIN	0064, 0575	HYPSON	0064, 0291	MITSUBISHI	0057, 0120, 0135, 0177, 0181, 0205, 0207, 0263, 0277, 0539, 0863, 1277	RFT	0455
ELITE	0347	ICE	0291, 0398	MIVAR	0318, 0319, 0543, 0636	RADIOSHACK	0057, 0074, 0181, 0205, 0207
ELTA	0036	ITS	0398	MOTOROLA	0120	RADIOLA	0064
EMERSON	0181, 0205, 0207, 0263, 0388, 0490, 0650	ITT	0190, 0388, 0575	MULTITECH	0036, 0207	RADIOMARELLI	0543
ENVISION	0057, 0840	IMPERIAL	0274, 0397, 0445	MYRYAD	0583	REALISTIC	0057, 0181, 0205, 0207
EPSON	0860	INDIANA	0064	NAD	0183, 0205, 0388, 0893	REDIFFUSION	0388
ERRES	0064	INFINITY	0081	NEC	0036, 0057, 0078, 0181, 0183, 0197, 0205, 0482, 0524, 1731	REOC	0741
ETHER	0036, 0057	INGELEN	0190	NEI	0064	REVOX	0064
ETRON	0036	INNO HIT	0543	NETC	0119	REX	0190, 0286, 0291
EUROPHON	0543	INNOVA	0064	NECKERMANN	0064, 0583	ROADSTAR	0036, 0291, 0445
FERGUSON	0064, 0100, 0136, 0265, 0314, 0362, 0587	INTEQ	0044	NETSAT	0064	RUNCO	0044, 0057, 0524, 0630
FIDELITY	0388	INTERFUNK	0064, 0190, 0274, 0388, 0539	NEWAVE	0036, 0119, 0120, 0205	SBR	0064
FINLANDIA	0235, 0373	INTERVISION	0064, 0291, 0404	NIKKAI	0064, 0291	SEG	0291, 0695
FINLUX	0064, 0131, 0132, 0373, 0543	JBL	0081	NIKKO	0057, 0119, 0205	SEI	0543
FIRSTAR	0036, 0263	JCB	0027	NIKIA	0388, 0500, 0507, 0575, 0658	SKY	0064
FIRSTLINE	0036, 0274, 0695	JVC	0080, 0398, 0490, 0680, 0710	NORCENT	0775, 0851	SSS	0207
FISHER	0131, 0181, 0235, 0397	JEAN	0036, 0078, 0119, 0183, 0263	NORDMENDE	0136, 0314, 0587	SABA	0136, 0190, 0314, 0362
FLINT	0482	JENSEN	0788	OCEANIC	0190, 0388	SACCS	0265
FORMENTI	0064, 0347	KEC	0207	ONWA	0207, 0460	SAGEM	0637
FORTRESS	0120	KTV	0057, 0207	OPTIMUS	0181, 0193, 0277, 0677	SAISHO	0036, 0291, 0543
FRONTECH	0190, 0274, 0291	KAISUI	0036	OPTONICA	0120	SALORA	0190, 0380, 0388, 0575
FUJITSU	0710, 0836	KAPSCH	0190	ORION	0064, 0263, 0347, 0490, 0543	SAMBERS	0543
FUNAI	0207, 0198, 0291	KARCHER	0637	OSAKI	0291, 0439	SAMPO	0036, 0057, 0119, 0120, 0181, 0198, 0205, 0677, 1782
FUTURETECH	0207	KATHREIN	0583	OTTO VERSAND	0064, 0347, 0539, 0583	SAMSUNG	0036, 0057, 0064, 0087, 0117, 0119, 0181, 0205, 0291, 0397, 0583, 0614, 0645, 0729, 0793, 0839, 0841
GE	0057, 0074, 0078, 0119, 0205, 0207, 0478, 0587, 1174, 1374, 1481	KENDO	0064	PALLADIUM	0397, 0445	SANSEI	0478
GEC	0064, 0543	KENWOOD	0057	PANAMA	0291	SANSUI	0490
GATEWAY	1782, 1783	KNEISSEL	0286, 0462	PANASONIC	0064, 0078, 0081, 0190, 0277, 0677, 1437	SANYO	0131, 0181, 0207, 0235, 0366, 0826
GELOSO	0036	KOLIN	0080, 0135, 0207	OPTIMUS	0181, 0193, 0277, 0677	SCHAUB LORENZ	0388
GENEXXA	0190	KORPEL	0064	ORION	0064, 0263, 0347, 0490, 0543	SCHNEIDER	0064, 0274, 0398, 0695
GIBRALTER	0044, 0057	KOYODA	0036	OSAKI	0291, 0439	SCOTCH	0205
GOLDSTAR	0057, 0064, 0136, 0181, 0205, 0404	L&S ELECTRONIC	0835	OTTO VERSAND	0064, 0347, 0539, 0583	SCOTT	0205, 0207, 0263
GOODMANS	0064, 0398, 0401, 0661	LG	0057, 0064, 0087, 0135, 0205, 0741	PANASONIC	0064, 0078, 0081, 0190, 0277, 0677, 1437		
GOREMJE	0397	LXI	0074, 0081, 0181, 0183, 0205	PATHE CINEMA	0265, 0347		
GRADIENTE	0080, 0197	LEYCO	0064, 0291	PAUSA	0036		
GRAETZ	0190, 0388	LIESENK & TTER	0064	PENNEY	0057, 0074, 0078, 0087, 0183, 0205, 1374		
		LOEWE	0539	PERDIO	0347		
		LUXOR	0383, 0388	PHILCO	0057, 0064, 0081, 0172, 0205, 0207, 0274, 0490, 1688		
		M ELECTRONIC	0036, 0064, 0131, 0132, 0136, 0190, 0314, 0373, 0401, 0507				
		MGA	0057, 0177, 0205				
		MTC	0057, 0087, 0539				

SEARS	0074, 0081, 0181, 0183, 0198, 0205	UHER	0347	COMBITECH	0379	KAISUI	0099
SELECO	0190, 0286	UNIVERSUM	0064, 0131, 0132, 0291, 0373, 0397, 0519	CRAIG	0064, 0074, 0099, 0267	KENWOOD	0068, 0094
SEMIVOX	0207			CROWN	0099, 0305	KODAK	0062, 0064
SEMP	0183	VECTOR RESEARCH	0057	CURTIS MATHES	0062, 0068, 0087, 1062	KOLIN	0068, 0070
SHARP	0057, 0120, 0677			CYBERNEX	0267	KORPEL	0099
SHEN YING	0036, 0119	VESTEL	0064	CYRUS	0108	LG	0064, 0069, 0072, 0507
SHENG CHIA	0036, 0120, 0263	VICTOR	0080, 0277, 0677, 0680	DAEWOO	0072, 0131, 0305, 0669, 1305	LXI	0064
SIAREM	0543			DANSAI	0099	LENCO	0305
SIEMENS	0064, 0222	VIDEOSAT	0274	DE GRAAF	0069	LEYCO	0099
SINUDYNE	0543	VIDIKRON	0081	DECCA	0027, 0108	LLOYD'S	0027
SKANTIC	0383	VIDTECH	0205	DENON	0069	LOEWE	0064, 0108, 1589
SKYGIANT	0207	VIEWSONIC	1782	DUAL	0068	LOGIK	0099, 0267
SKYWORTH	0064	VISION	0347	DUMONT	0027, 0108, 0131	LUXOR	0070, 0075, 0131
SOLAVOX	0190	VOXSON	0190	DYNATECH	0027	M ELECTRONIC	0027
SONITRON	0235	WALTHAM	0383	ESC	0267, 0305	MEI	0062
SONOKO	0036, 0064	WARDS	0057, 0081, 0205, 0893	ELCATECH	0099	MGA	0070, 0267
SONOLOR	0190, 0235	WATSON	0064, 0347	ELECTROHOME	0064	MGN TECHNOLOGY	0267
SONTEC	0064	WAYCON	0183	ELECTROPHONIC	0064	MTC	0027, 0267
SONY	0027, 0677, 0861, 1127, 1532, 1678	WHITE WESTINGHOUSE	0064, 0347, 0490, 0650	EMEREX	0059	MAGNASONIC	1305
SOUNDESIGN	0205, 0207			EMERSON	0027, 0062, 0064, 0070, 0072, 0211, 0267, 0305, 1305, 1506	MAGNAVOX	0027, 0062, 0066, 0108, 1808
SOUNDWAVE	0064, 0445	YAMAHA	0057, 0172, 0677, 0796, 0860, 2900 (projector), 2901 (projector), 2903, 2904 (projector)	FERGUSON	0068, 0347	MAGNIN	0267
SOWA	0078, 0087, 0119, 0183, 0205			FIDELITY	0027	MANESTH	0072, 0099
SQUAREVIEW	0198	YAPSHE	0277	FINLANDIA	0108, 0131	MARANTZ	0062, 0108
STANDARD	0036	YOKO	0064, 0291	FINLUX	0027, 0069, 0108, 0131	MARTA	0064
STARLITE	0207	ZENITH	0044, 0119, 0205, 0490	FIRSTLINE	0064, 0070, 0072, 0099	MATSUI	0375, 0379
STERN	0190, 0286			FISHER	0074, 0131	MATSUSHITA	0062
SUPREME	0027			FUJI	0060, 0062	MEDION	0375
SYLVANIA	0057, 0081, 0198			FUJITSU	0027, 0072	MEMOREX	0027, 0062, 0064, 0066, 0074, 0075, 0131, 0267, 0334, 0375, 1264
SYMPHONIC	0198, 0207			FUNAI	0027	MEMPHIS	0099
SYNCO	0027, 0087, 0119, 0120, 0205, 0478			GE	0062, 0087, 0267, 0834, 1062, 1087	METZ	0064, 0374, 1589
SYSLINE	0064			GEC	0108	MINOLTA	0069
T + A	0474			GARRARD	0027	MITSUBISHI	0068, 0070, 0094, 0108, 0834
TCM	0835			GENERAL	0072	MOTOROLA	0062, 0075
TMK	0205			GO VIDEO	0459	MULTITECH	0027, 0099
TNCI	0044			GOLDHAND	0099	MURPHY	0027
TVS	0490			GOLDSTAR	0064, 0252, 0507, 1264	MYRYAD	0108
TACICO	0036, 0119, 0205			GOODMANS	0027, 0064, 0099, 0305	NAD	0131
TAI YI	0036			GRADIENTE	0027	NEC	0062, 0064, 0068, 0075, 0094, 0131
TANDY	0120, 0190			GRANADA	0068, 0131, 0267	NATIONAL	0253
TASHIKO	0119, 0677			GRANDIN	0027, 0064, 0099	NECKERMANN	0108
TATUNG	0036, 0064, 0078, 0081, 0087, 0181, 0183, 0543			GRUNDIG	0099, 0108, 0253, 0374	NESCO	0099
TEAC	0036, 0064, 0291, 0439, 0445, 0482, 0695, 1064			HCM	0099	NEWAVE	0064
TEC	0274			HI-Q	0074	NIKKO	0064
TECHNEMA	0347			HANSEATIC	0064	NOBLEX	0267
TECHNICS	0078, 0277, 0677			HARLEY DAVIDSON	0027	NOKIA	0068, 0131, 0267
TECHWOOD	0078			HARMAN/KARDON	0108	NORDMENDE	0068, 0347
TECO	0036, 0078, 0119, 0120, 0205, 0291, 0680			HARWOOD	0099	OCEANIC	0027, 0068
TEKNIKA	0081, 0087, 0119, 0177, 0207			HINARI	0099, 0267, 0379	OKANO	0342, 0375
TELEFUNKEN	0136, 0289, 0362, 0652, 0729			HITACHI	0027, 0064, 0068, 0069, 0267	OLYMPUS	0062, 0253
TELEMEISTER	0347			HUGHES NETWORK SYSTEMS	0069	OPTIMUS	0064, 0075, 0131, 0459
TELETECH	0036			HYPSON	0099	ORION	0211, 0375, 0379, 1506
TENSAI	0347			ITT	0068, 0131, 0267	OSAKI	0027, 0064, 0099
TERA	0057			ITV	0064, 0305	OTTO VERSAND	0108
THOMSON	0136, 0314, 0587, 0652, 1474			IMPERIAL	0027	PALLADIUM	0064, 0068, 0099
THORN	0064, 0131, 0388, 0539			INTERFUNK	0108	PANASONIC	0062, 0252, 0253, 0643, 1062, 1589
TOSHIBA	0087, 0181, 0183, 0535, 0645, 0677, 0859, 1283, 1383, 1683, 1731			JVC	0068, 0072, 0094	PATHE MARCONI	0068
TRIUMPH	0543			JENSEN	0068	PENNEY	0062, 0064, 0069, 0267, 1062, 1264
TUNTEX	0036, 0057, 0119			KEC	0064, 0305	PENTAX	0069
				KLH	0099	PERDIO	0027
						PHILCO	0062
						PHILIPS	0062, 0108, 0645, 1108, 1208
						PHONOLA	0108

VCR

ASA	0064, 0108
ADMIRAL	0075
ADVENTURA	0027
AIKO	0305
AIWA	0027, 0064, 0334, 0375, 0379
AKAI	0068, 0342
AKIBA	0099
ALBA	0099, 0305, 0342, 0379
AMERICA ACTION	0305
AMERICAN HIGH	0062
AMSTRAD	0027
ANAM	0064, 0253, 0267, 0305, 0507
ANAM NATIONAL	0253, 1589
ANITECH	0099
ASHA	0267
ASUKA	0064
AUDIOVOX	0064, 0305
BAIRD	0027, 0068, 0131
BASIC LINE	0099, 0305
BEAUMARK	0267
BELL & HOWELL	0131
BLAUPUNKT	0253
BRANDT	0347
BRANDT ELECTRONIC	0068
BROKSONIC	0211, 0375, 1506
BUSH	0099, 0305, 0379
CCE	0099, 0305
CGE	0027
CALIX	0064
CANON	0062
CARVER	0108
CIMLINE	0099
CINERAL	0305
CITIZEN	0064, 0305, 1305
COLT	0099

PILOT	0064	TELEAVIA	0068
PIONEER	0069, 0094, 0108	TELEFUNKEN	0068, 0347
POLK AUDIO	0108	TENOSAL	0099
PROFITRONIC	0267	TENSAI	0027
PROLINE	0027	THOMAS	0027
PROSCAN	0087, 1087	THOMSON	0068, 0087, 0094,
PROTEC	0099		0347
PULSAR	0066	THORN	0068, 0131
PYE	0108	TIVO	0645, 0663
QUASAR	0062, 1062	TOSHIBA	0068, 0070, 0072,
QUELLE	0108		0094, 0108, 0872
RCA	0062, 0069, 0087,	TOTEVISION	0064, 0267
	0267, 0834, 1062,	UHER	0267
	1087	UNITECH	0267
RADIOSHACK	0027	UNIVERSUM	0027, 0064, 0108,
RADIOLA	0108		0267
RADIX	0064	VECTOR	0072
RANDEX	0064	VICTOR	0068, 0094
REALISTIC	0027, 0062, 0064,	VIDEO CONCEPTS	0072
	0074, 0075, 0131	VIDEOMAGIC	0064
REOC	0375	VIDEOSONIC	0267
REPLAYTV	0641, 0643	VILLAIN	0027
REX	0068	WARDS	0027, 0062, 0069,
ROADSTAR	0064, 0099, 0267,		0074, 0075, 0087,
	0305		0099, 0108, 0267
RUNCO	0066	WHITE WESTINGHOUSE	
SBR	0108		0099
SEG	0267	XR-1000	0027, 0062, 0099
SEI	0108	YAMAHA	0068
STS	0069	YAMISHI	0099
SABA	0068, 0347	YOKAN	0099
SALORA	0070	YOKO	0267
SAMPO	0064, 0075	ZENITH	0027, 0060, 0066,
SAMSUNG	0072, 0267, 0459		1506
SANKY	0066, 0075		
SANSUI	0027, 0068, 0094,		
	1506		
SANYO	0074, 0131, 0267		
SAVILLE	0379		
SCHAUB LORENZ	0027, 0068,		
	0131		
SCHNEIDER	0027, 0099, 0108		
SCOTT	0070, 0072, 0211		
SEARS	0027, 0062, 0064,		
	0069, 0074, 0131,		
	1264		
SELECO	0068		
SEMP	0072		
SHARP	0075, 0834		
SHINTOM	0099, 0131		
SIEMENS	0064, 0108, 0131		
SILVA	0064		
SINGER	0072, 0099		
SINUDYNE	0108		
SONIC BLUE	0641, 0643		
SONTEC	0064		
SONY	0027, 0059, 0060,		
	0062, 0663, 1259		
SUNKAI	0375		
SUNSTAR	0027		
SUNTRONIC	0027		
SYLVANIA	0027, 0062, 0108,		
	0070, 1808		
SYMPHONIC	0027		
TMK	0267		
TANDY	0027, 0131		
TASHIKO	0027, 0064		
TATUNG	0027, 0068, 0072,		
	0094, 0108		
TEAC	0027, 0068, 0305,		
	0334, 0669		
TECHNICS	0062, 0253		
TECO	0062, 0064, 0068,		
	0075		
TEKNIKA	0027, 0062, 0064		

APPENDIX-ix



© 2006 YAMAHA CORPORATION All rights reserved.

YAMAHA ELECTRONICS CORPORATION, USA 6660 ORANGETHORPE AVE., BUENA PARK, CALIF. 90620, U.S.A.
YAMAHA CANADA MUSIC LTD. 135 MILNER AVE., SCARBOROUGH, ONTARIO M1S 3R1, CANADA
YAMAHA ELECTRONIK EUROPA G.m.b.H. SIEMENSSTR. 22-34, 25462 RELINGEN BEI HAMBURG, GERMANY
YAMAHA ELECTRONIQUE FRANCE S.A. RUE AMBROISE CROIZAT BP70 CROISSY-BEAUBOURG 77312 MARNE-LA-VALLEE CEDEX02, FRANCE
YAMAHA ELECTRONICS (UK) LTD. YAMAHA HOUSE, 200 RICKMANSWORTH ROAD WATFORD, HERTS WD18 7GQ, ENGLAND
YAMAHA SCANDINAVIA A.B. J A WETTERGRENS GATA 1, BOX 30053, 400 43 VÄSTRA FRÖLUNDA, SWEDEN
YAMAHA MUSIC AUSTRALIA PTY, LTD. 17-33 MARKET ST., SOUTH MELBOURNE, 3205 VIC., AUSTRALIA

YAMAHA CORPORATION
Printed in Malaysia ◀ WH63550