



RX-V1900

AV Receiver

OWNER'S MANUAL

IMPORTANT SAFETY INSTRUCTIONS

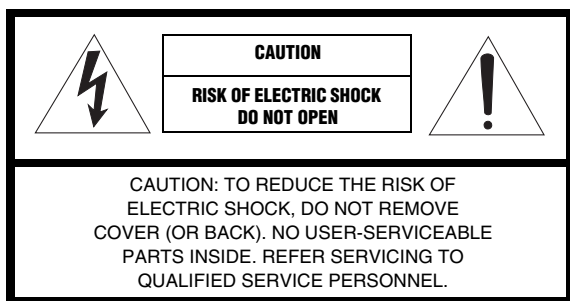

• Explanation of Graphical Symbols



The lightning flash with arrowhead symbol, within an equilateral triangle, is intended to alert you to the presence of uninsulated “dangerous voltage” within the product’s enclosure that may be of sufficient magnitude to constitute a risk of electric shock to persons.



The exclamation point within an equilateral triangle is intended to alert you to the presence of important operating and maintenance (servicing) instructions in the literature accompanying the appliance.

- 1 Read Instructions – All the safety and operating instructions should be read before the product is operated.
 - 2 Retain Instructions – The safety and operating instructions should be retained for future reference.
 - 3 Heed Warnings – All warnings on the product and in the operating instructions should be adhered to.
 - 4 Follow Instructions – All operating and use instructions should be followed.
 - 5 Cleaning – Unplug this product from the wall outlet before cleaning. Do not use liquid cleaners or aerosol cleaners.
 - 6 Attachments – Do not use attachments not recommended by the product manufacturer as they may cause hazards.
 - 7 Water and Moisture – Do not use this product near water – for example, near a bath tub, wash bowl, kitchen sink, or laundry tub; in a wet basement; or near a swimming pool; and the like.
 - 8 Accessories – Do not place this product on an unstable cart, stand, tripod, bracket, or table. The product may fall, causing serious injury to a child or adult, and serious damage to the product. Use only with a cart, stand, tripod, bracket, or table recommended by the manufacturer, or sold with the product. Any mounting of the product should follow the manufacturer’s instructions, and should use a mounting accessory recommended by the manufacturer.
 - 9 A product and cart combination should be moved with care. Quick stops, excessive force, and uneven surfaces may cause the product and cart combination to overturn.
- 
- 10 Ventilation – Slots and openings in the cabinet are provided for ventilation and to ensure reliable operation of the product and to protect it from overheating, and these openings must not be blocked or covered. The openings should never be blocked by placing the product on a bed, sofa, rug, or other similar surface. This product should not be placed in a built-in installation such as a bookcase or rack unless proper ventilation is provided or the manufacturer’s instructions have been adhered to.
 - 11 Power Sources – This product should be operated only from the type of power source indicated on the marking label. If you are not sure of the type of power supply to your home, consult your product dealer or local power company. For products intended to operate from battery power, or other sources, refer to the operating instructions.
 - 12 Grounding or Polarization – This product may be equipped with a polarized alternating current line plug (a plug having one blade wider than the other). This plug will fit into the power outlet only one way. This is a safety feature. If you are unable to insert the plug fully into the outlet, try reversing the plug. If the plug should still fail to fit, contact your electrician to replace your obsolete outlet. Do not defeat the safety purpose of the polarized plug.
 - 13 Power-Cord Protection – Power-supply cords should be routed so that they are not likely to be walked on or pinched by items placed upon or against them, paying particular attention to cords at plugs, convenience receptacles, and the point where they exit from the product.
 - 14 Lightning – For added protection for this product during a lightning storm, or when it is left unattended and unused for long periods of time, unplug it from the wall outlet and disconnect the antenna or cable system. This will prevent damage to the product due to lightning and power-line surges.
 - 15 Power Lines – An outside antenna system should not be located in the vicinity of overhead power lines or other electric light or power circuits, or where it can fall into such power lines or circuits. When installing an outside antenna system, extreme care should be taken to keep from touching such power lines or circuits as contact with them might be fatal.
 - 16 Overloading – Do not overload wall outlets, extension cords, or integral convenience receptacles as this can result in a risk of fire or electric shock.
 - 17 Object and Liquid Entry – Never push objects of any kind into this product through openings as they may touch dangerous voltage points or short-out parts that could result in a fire or electric shock. Never spill liquid of any kind on the product.
 - 18 Servicing – Do not attempt to service this product yourself as opening or removing covers may expose you to dangerous voltage or other hazards. Refer all servicing to qualified service personnel.
 - 19 Damage Requiring Service – Unplug this product from the wall outlet and refer servicing to qualified service personnel under the following conditions:
 - a) When the power-supply cord or plug is damaged,
 - b) If liquid has been spilled, or objects have fallen into the product,
 - c) If the product has been exposed to rain or water,

- d) If the product does not operate normally by following the operating instructions. Adjust only those controls that are covered by the operating instructions as an improper adjustment of other controls may result in damage and will often require extensive work by a qualified technician to restore the product to its normal operation,
 - e) If the product has been dropped or damaged in any way, and
 - f) When the product exhibits a distinct change in performance - this indicates a need for service.
- 20 Replacement Parts** – When replacement parts are required, be sure the service technician has used replacement parts specified by the manufacturer or have the same characteristics as the original part. Unauthorized substitutions may result in fire, electric shock, or other hazards.
- 21 Safety Check** – Upon completion of any service or repairs to this product, ask the service technician to perform safety checks to determine that the product is in proper operating condition.
- 22 Wall or Ceiling Mounting** – The unit should be mounted to a wall or ceiling only as recommended by the manufacturer.
- 23 Heat** – The product should be situated away from heat sources such as radiators, heat registers, stoves, or other products (including amplifiers) that produce heat.

- 24 Outdoor Antenna Grounding** – If an outside antenna or cable system is connected to the product, be sure the antenna or cable system is grounded so as to provide some protection against voltage surges and built-up static charges. Article 810 of the National Electrical Code, ANSI/NFPA 70, provides information with regard to proper grounding of the mast and supporting structure, grounding of the lead-in wire to an antenna discharge unit, size of grounding conductors, location of antenna discharge unit, connection to grounding electrodes, and requirements for the grounding electrode.

EXAMPLE OF ANTENNA GROUNDING

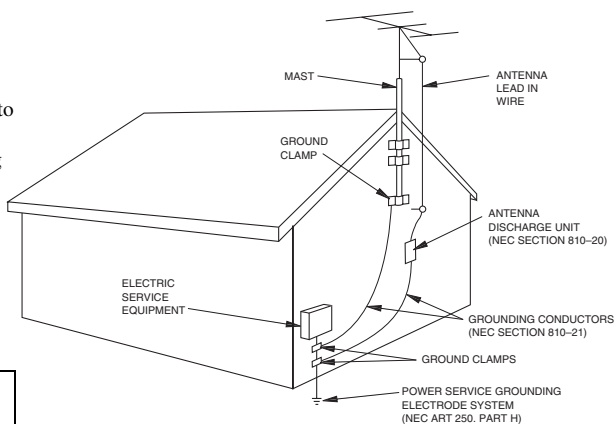

NEC – NATIONAL ELECTRICAL CODE

Note to CATV system installer:

This reminder is provided to call the CATV system installer's attention to Article 820-40 of the NEC that provides guidelines for proper grounding and, in particular, specifies that the cable ground shall be connected to the grounding system of the building, as close to the point of cable entry as practical.

FCC INFORMATION (for US customers)

1 IMPORTANT NOTICE: DO NOT MODIFY THIS UNIT!

This product, when installed as indicated in the instructions contained in this manual, meets FCC requirements. Modifications not expressly approved by Yamaha may void your authority, granted by the FCC, to use the product.

2 IMPORTANT: When connecting this product to accessories and/or another product use only high quality shielded cables. Cable/s supplied with this product **MUST** be used. Follow all installation instructions. Failure to follow instructions could void your FCC authorization to use this product in the USA.

3 NOTE: This product has been tested and found to comply with the requirements listed in FCC Regulations, Part 15 for Class "B" digital devices. Compliance with these requirements provides a reasonable level of assurance that your use of this product in a residential environment will not result in harmful interference with other electronic devices.

This equipment generates/uses radio frequencies and, if not installed and used according to the instructions found in the users manual, may cause interference harmful to the operation of other electronic devices.

Compliance with FCC regulations does not guarantee that interference will not occur in all installations. If this product is found to be the source of interference, which can be determined by turning the unit "OFF" and "ON", please try to eliminate the problem by using one of the following measures:

Relocate either this product or the device that is being affected by the interference.

Utilize power outlets that are on different branch (circuit breaker or fuse) circuits or install AC line filter/s.

In the case of radio or TV interference, relocate/reorient the antenna. If the antenna lead-in is 300 ohm ribbon lead, change the lead-in to coaxial type cable.

If these corrective measures do not produce satisfactory results, please contact the local retailer authorized to distribute this type of product. If you can not locate the appropriate retailer, please contact Yamaha Electronics Corp., U.S.A. 6660 Orangethorpe Ave, Buena Park, CA 90620.

The above statements apply **ONLY** to those products distributed by Yamaha Corporation of America or its subsidiaries.

Caution: Read this before operating your unit.

- 1 To assure the finest performance, please read this manual carefully. Keep it in a safe place for future reference.
- 2 Install this sound system in a well ventilated, cool, dry, clean place – away from direct sunlight, heat sources, vibration, dust, moisture, and/or cold. Allow ventilation space of at least 30 cm on the top, 20 cm on the left and right, and 20 cm on the back of this unit.
- 3 Locate this unit away from other electrical appliances, motors, or transformers to avoid humming sounds.
- 4 Do not expose this unit to sudden temperature changes from cold to hot, and do not locate this unit in an environment with high humidity (i.e. a room with a humidifier) to prevent condensation inside this unit, which may cause an electrical shock, fire, damage to this unit, and/or personal injury.
- 5 Avoid installing this unit where foreign objects may fall onto this unit and/or this unit may be exposed to liquid dripping or splashing. On the top of this unit, do not place:
 - Other components, as they may cause damage and/or discoloration on the surface of this unit.
 - Burning objects (i.e. candles), as they may cause fire, damage to this unit, and/or personal injury.
 - Containers with liquid in them, as they may fall and liquid may cause electrical shock to the user and/or damage to this unit.
- 6 Do not cover this unit with a newspaper, tablecloth, curtain, etc. in order not to obstruct heat radiation. If the temperature inside this unit rises, it may cause fire, damage to this unit, and/or personal injury.
- 7 Do not plug in this unit to a wall outlet until all connections are complete.
- 8 Do not operate this unit upside-down. It may overheat, possibly causing damage.
- 9 Do not use force on switches, knobs and/or cords.
- 10 When disconnecting the power cable from the wall outlet, grasp the plug; do not pull the cable.
- 11 Do not clean this unit with chemical solvents; this might damage the finish. Use a clean, dry cloth.
- 12 Only voltage specified on this unit must be used. Using this unit with a higher voltage than specified is dangerous and may cause fire, damage to this unit, and/or personal injury. Yamaha will not be held responsible for any damage resulting from use of this unit with a voltage other than specified.
- 13 To prevent damage by lightning, keep the power cord and outdoor antennas disconnected from a wall outlet or the unit during a lightning storm.
- 14 Do not attempt to modify or fix this unit. Contact qualified Yamaha service personnel when any service is needed. The cabinet should never be opened for any reasons.
- 15 When not planning to use this unit for long periods of time (i.e. vacation), disconnect the AC power plug from the wall outlet.
- 16 Install this unit near the AC outlet and where the AC power plug can be reached easily.
- 17 Be sure to read the “Troubleshooting” section on common operating errors before concluding that this unit is faulty.
- 18 Before moving this unit, press **Ⓜ MASTER ON/OFF** to release it outward to the OFF position to turn off this unit, the main room, Zone 2 and Zone 3 and then disconnect the AC power plug from the AC wall outlet.
- 19 **VOLTAGE SELECTOR** (Asia and General models only)
The **VOLTAGE SELECTOR** on the rear panel of this unit must be set for your local main voltage BEFORE plugging into the AC wall outlet. Voltages are:
.....AC 110/120/220/230–240 V, 50/60 Hz
- 20 The batteries shall not be exposed to excessive heat such as sunshine, fire or like.
- 21 Excessive sound pressure from earphones and headphones can cause hearing loss.
- 22 When replacing the batteries, be sure to use batteries of the same type. Danger of explosion may happen if batteries are incorrectly replaced.

WARNING

TO REDUCE THE RISK OF FIRE OR ELECTRIC SHOCK, DO NOT EXPOSE THIS UNIT TO RAIN OR MOISTURE.

As long as this unit is connected to the AC wall outlet, it is not disconnected from the AC power source even if you turn off this unit by **Ⓜ MASTER ON/OFF**. In this state, this unit is designed to consume a very small quantity of power.

FOR CANADIAN CUSTOMERS

To prevent electric shock, match wide blade of plug to wide slot and fully insert.

This Class B digital apparatus complies with Canadian ICES-003.

POUR LES CONSOMMATEURS CANADIENS

Pour éviter les chocs électriques, introduire la lame la plus large de la fiche dans la borne correspondante de la prise et pousser jusqu'au fond.

Cet appareil numérique de la classe B est conforme à la norme NMB-003 du Canada.

IMPORTANT

Please record the serial number of this unit in the space below.

MODEL:

Serial No.:

The serial number is located on the rear of the unit.

Retain this Owner's Manual in a safe place for future reference.

Contents

INTRODUCTION

Features	3
Supplied accessories	3
Notice	4
Getting started	5
Quick start guide	6

PREPARATION

Connections	10
Optimizing the speaker setting for your listening room	30
Before starting the automatic setup	30
Basic automatic setup	30
Advanced automatic setup.....	33
Reloading the automatic setup parameters	34

BASIC OPERATION

Playback	35
Basic procedure	35
Selecting audio input jacks (AUDIO SELECT).....	36
Selecting the multi-channel input component	36
Using your headphones.....	36
Muting the audio output.....	37
Displaying the input source information (SIGNAL INFO)	37
Using the sleep timer	38
Sound field programs	39
Selecting sound field programs	39
Using CINEMA DSP 3D mode.....	45
Enjoying unprocessed input sources.....	45
Using audio features	46
Enjoying pure hi-fi sound	46
Adjusting the tonal quality.....	46
Adjusting the speaker level.....	46
FM/AM tuning	47
Overview.....	47
FM/AM tuning operations	47
Preset FM/AM stations	48
Using HD Radio™ features (U.S.A. model only)	50
Selecting HD Radio™ audio programs	50
Displaying HD Radio™ information.....	51
XM® Satellite Radio tuning	52
Connecting XM Mini-Tuner Home Dock	52
Activating XM Satellite Radio	53
XM Satellite Radio operations.....	53
Setting the XM Satellite Radio preset channels	55
Displaying the XM Satellite Radio information.....	56
SIRIUS Satellite Radio™ tuning	57
Connecting the SiriusConnect™ tuner	57
Activating SIRIUS Satellite Radio™ subscription..	58
SIRIUS Satellite Radio™ operations	58
Setting the SIRIUS Satellite Radio™ preset channels	60
Setting the Parental Lock.....	61
Displaying the SIRIUS Satellite Radio™ information	62
Using iPod™	63
Controlling iPod™.....	63

Using Bluetooth™ components	65
Pairing the Bluetooth™ receiver and your Bluetooth component	65
Playback of the Bluetooth™ component.....	65

ADVANCED OPERATION

Advanced sound configurations	66
Selecting decoders	66
Changing sound field parameter settings.....	67
Customizing this unit (MANUAL SETUP)	74
Operating the MANUAL SETUP menu.....	74
1 SPEAKER MENU	75
2 VOLUME MENU	77
3 SOUND MENU	78
4 VIDEO MENU	80
5 INPUT MENU	81
6 OPTION MENU	83
Saving and recalling the system settings (SYSTEM MEMORY)	86
Saving the system settings	86
Loading the system settings.....	87
Using examples.....	88
Remote control features	89
Controlling this unit, a TV, or other components....	89
Setting remote control codes	91
Programming codes from other remote controls	93
Changing source names in the display window.....	94
Macro programming features	95
Clearing configurations	97
Simplified remote control.....	98
Using multi-zone configuration	99
Connecting the Zone 2 and Zone 3 components	99
Controlling Zone 2 or Zone 3	100
Advanced setup	102
Using the advanced setup menu	102

ADDITIONAL INFORMATION

Troubleshooting	104
Resetting the system	115
Glossary	116
Sound field program information	119
Parametric equalizer information	120
Specifications	121
SET MENU tree	123
Index	125

APPENDIX

(at the end of this manual)

Front panel	i
Remote control	ii
Sound output in each sound field program	iii
List of remote control codes	v

“**Ⓐ**MASTER ON/OFF” or “**ⓐ**DVD” (example) indicates the name of the parts on the front panel or the remote control. Refer to the attached sheet or the pages at the end of this manual for the information about each position of the parts.

What you can do with MANUAL SETUP

By configuring the parameters in “MANUAL SETUP”, you can adjust a variety of system settings suited for your listening environment. The following is a brief description of some of the useful menus you can configure in “MANUAL SETUP”. For more detailed information, see “Customizing this unit (MANUAL SETUP)” (page 74) and “SET MENU tree” (page 123).

Fine adjusting the speaker settings

In case speaker settings configured by automatic setup does not match your listening environment, you can configure them manually.

SPEAKER MENU → CONFIG (page 75)

SPEAKER MENU → LEVEL (page 76)

SPEAKER MENU → DISTANCE (page 76)

Specifying the muting type

In case you do not want to fully mute audio when you receive a call while watching your favorite TV program, you can use this menu to specify the muting level.

VOLUME MENU → MUTING TYPE (page 78)

Specifying the initial volume level

By adjusting this parameter, you can automatically control the initial volume level regardless of the recording level of the audio source.

VOLUME MENU → INIT. VOL. (page 78)

Adjusting the dynamic range

The dynamic range is the difference between the minimum and maximum amplitude. The higher the dynamic range, the more accurate the sound reproduction for bitstream signals. You can adjust the dynamic range for speakers and headphones individually.

SOUND MENU → DYNAMIC RANGE (page 79)

Adjusting the audio and video synchronization

Sometimes, depending on your video source component, video is delayed relative to audio due to processing problems. In this case, you need to manually adjust the audio delay to keep it synchronized with the video. If you connect the video source component to this unit using an HDMI connection and your component supports the LIPSYNC feature, you can adjust the audio/video synchronization automatically.

SOUND MENU → LIPSYNC (page 79)

Changing input/output assignment

In case the initial input/output assignments do not correspond to your needs, you can rearrange them according to your component to be connected to this unit. You can also edit the input name to be displayed in the front panel or in the OSD as necessary.

INPUT MENU → (input source) → I/O ASSIGNMENT (page 82)

INPUT MENU → (input source) INPUT RENAME (page 82)

Fixing the volume difference between input sources

The sound output level may vary depending on the audio source components connected to this unit. In this case, you can reduce or increase the output level of each input source using this feature.

INPUT MENU → (input source) → VOL. TRIM (page 82)

Setting the background video for audio sources

If you want to enjoy video images in combination with music playback or radio, configure this setting to specify the video input source. For example, to view DVD video images while listening to the FM radio, set this setting under “TUNER” to “DVD”.

INPUT MENU → (input source) → BGV (page 82)

Adjusting the brightness of the front panel display

You can make the front panel display darker or brighter by configuring this setting.

OPTION MENU → DISPLAY SET → DIMMER (page 83)

Turning on or off the short message display

Each time you operate this unit using controls on the front panel or remote control keys, this unit displays short messages on the OSD. If you want to turn off the short message display, select “OFF” in this setting (Initial factory setting is “ON”).

OPTION MENU → DISPLAY SET → SHORT MESSAGE (page 84)

Setting the amount of time to display OSD information

You can set the amount of time to display HD Radio (U.S.A. model only), XM Satellite Radio, or SIRIUS Satellite Radio information or iPod menu in the OSD after you perform a certain operation.

OPTION MENU → DISPLAY SET → ON SCREEN (page 84)

Protecting the setup values

After you have configured the sound field program parameters and other system settings, you can use this feature to prevent accidental changes to those setup values.

OPTION MENU → MEMORY GUARD (page 84)

Features

Built-in 7-channel power amplifier

- ◆ Minimum RMS output power (20 Hz to 20 kHz, 0.04% THD, 8 Ω)
Front: 130 W + 130 W
Center: 130 W
Surround: 130 W + 130 W
Surround back: 130 W + 130 W

Various input/output connectors

- ◆ HDMI (IN x 4, OUT x 1), Component video (IN x 3, OUT x 1), S-video (IN x 6, OUT x 3), Composite video (IN x 6, OUT x 3), Coaxial digital audio (IN x 3), Optical digital audio (IN x 5, OUT x 2), Analog audio (IN x 10, OUT x 3)
- ◆ Speaker out (7-channel), Pre out (7-channel), Subwoofer out, Presence out, Zone 2/Zone 3 out
- ◆ Discrete multi-channel input (6 or 8-channel)

Sound field programs

- ◆ Proprietary Yamaha technology for the creation of sound fields
- ◆ CINEMA DSP 3D
- ◆ Compressed Music Enhancer mode
- ◆ Virtual CINEMA DSP
- ◆ SILENT CINEMA

Digital audio decoders

- ◆ Dolby TrueHD, Dolby Digital Plus decoder
- ◆ DTS-HD Master Audio, DTS-HD High Resolution Audio decoder
- ◆ Dolby Digital/Dolby Digital EX decoder
- ◆ DTS/DTS-ES Matrix 6.1, Discrete 6.1, DTS 96/24 decoder
- ◆ Dolby Pro Logic/Dolby Pro Logic II/Dolby Pro Logic IIX decoder
- ◆ DTS NEO:6 decoder
- ◆ Neural-THX Surround decoder (U.S.A. and Canada models only)
- ◆ SRS Circle Surround II decoder (U.S.A. model only)

Sophisticated FM/AM tuner

- ◆ 40-station random and direct preset tuning
- ◆ Automatic preset tuning

Radio tuners

- ◆ FM/AM tuning capability
- ◆ HD Radio™ digital broadcast reception capability (U.S.A. model only)
- ◆ XM Satellite Radio tuning capability (using XM Mini-Tuner and Home Dock, sold separately)
- ◆ SIRIUS Satellite Radio™ tuning capability (using SiriusConnect tuner, sold separately)

HDMI™ (High-Definition Multimedia Interface)

- ◆ HDMI interface for standard, enhanced or high-definition video as well as multi-channel digital audio based on HDMI version 1.3a (HDMI is licensed by HDMI Licensing, LLC.)
 - Automatic audio and video synchronization (lip sync) information capability
 - Deep Color video signal (30/36 bit) transmission capability
 - “x.v.Color” video signal transmission capability
 - High refresh rate and high resolution video signals capability
 - High definition digital audio format signals capability
- ◆ HDCP (High-bandwidth Digital Content Protection System) licensed by Digital Content Protection, LLC.
- ◆ Analog video to HDMI digital video up-conversion (composite video ↔ S-video ↔ component video → HDMI digital video) capability for monitor out
- ◆ Analog video up-scaling from 480i (NTSC)/576i (PAL) or 480p/576p to 720p, 1080i or 1080p

DOCK terminal

- ◆ DOCK terminal to connect a Yamaha iPod universal dock (such as YDS-11, sold separately) or Bluetooth wireless audio receiver (such as YBA-10, sold separately)

Automatic speaker setup features

- ◆ Advanced YPAO (Yamaha Parametric room Acoustic Optimizer) for automatic speaker setup
- ◆ Multi-point measurement feature for multiple listening positions
- ◆ Parametric equalizer select feature

Other features

- ◆ 192-kHz/24-bit D/A converter
- ◆ OSD (on-screen display) menus that allow you to optimize this unit to suit your individual audiovisual system
- ◆ Analog video interlace/progressive conversion from 480i (NTSC)/576i (PAL) to 480p/576p
- ◆ Pure Direct mode for pure hi-fi sound for all sources
- ◆ Adaptive dynamic range controlling capability
- ◆ Adaptive DSP effect level controlling capability
- ◆ Remote control with preset remote control codes, learning and macro capability
- ◆ ZONE 2/ZONE 3 custom installation facility
- ◆ Zone switching capability between the main zone and ZONE 2/ZONE 3 using ZONE CONTROLS
- ◆ SYSTEM MEMORY capability for saving and recalling multiple system parameter settings
- ◆ Sleep timer for each zone



Supplied accessories

Check that you received all of the following parts.

- Remote control
- Simplified remote control (except Europe model)
- Batteries (4) (AAA, R03, UM-4)
- Power cable (Two for Asia model)
- Optimizer microphone
- AM loop antenna
- Indoor FM antenna
- Speaker terminal wrench

Notice

About this manual

-  indicates a tip for your operation.
- Some operations can be performed by using either the buttons on the front panel or the ones on the remote control. In case the button names differ between the front panel and the remote control, the button name on the remote control is given in parentheses.
- This manual is printed prior to production. Design and specifications are subject to change in part as a result of improvements, etc. In case of differences between the manual and product, the product has priority.
- “ MASTER ON/OFF” or “ DVD” (example) indicates the name of the parts on the front panel or the remote control. Refer to the attached sheet or the pages at the end of this manual for the information about each position of the parts.

x.v.Color™

“x.v.Color” is a trademark of Sony Corporation.

SILENT™ CINEMA

“SILENT CINEMA” is a trademark of Yamaha Corporation.



The XM name and related logos are registered trademarks of XM Satellite Radio Inc.



This product is manufactured under license from Neural Audio Corporation and THX Ltd. YAMAHA CORPORATION hereby grants the user a non-exclusive, non-transferable, limited right of use to this product under U.S.A. and foreign patent, patent pending and other technology or trademarks owned by Neural Audio Corporation and THX Ltd. “Neural Surround”, “Neural Audio”, “Neural” and “NRL” are trademarks and logos owned by Neural Audio Corporation. THX is a trademark of THX Ltd., which may be registered in some jurisdictions. All rights reserved.



Manufactured under license from Dolby Laboratories. Dolby and the double-D symbol are registered trademarks of Dolby Laboratories.



Manufactured under license under U.S. Patent No's: 5,451,942;5,956,674;5,974,380;5,978,762;6,226,616;6,487,535 & other U.S. and worldwide patents issued & pending. DTS is a registered trademark and the DTS logos, Symbol, DTS-HD and DTS-HD Master Audio are trademark of DTS, Inc. © 1996-2007 DTS, Inc. All Rights Reserved.

iPod™

“iPod” is a trademark of Apple Inc., registered in the U.S. and other countries.



“HDMI”, the “HDMI” logo and “High-Definition Multimedia Interface” are trademarks, or registered trademarks of HDMI Licensing LLC.



©2006 SIRIUS Satellite Radio Inc. “SIRIUS”, “SiriusConnect”, the SIRIUS dog logo, channel names and logos are trademarks of SIRIUS Satellite Radio Inc.



HD Radio™ Technology Manufactured Under License From iBiquity Digital Corp. U.S. and Foreign Patents. HD Radio™ and the HD Radio logo are proprietary trademarks of iBiquity Digital Corp.



Circle Surround II, Dialog Clarity, TruBass, SRS and the  symbol are trademarks of SRS Labs, Inc.

Circle Surround II, Dialog Clarity and TruBass technologies are incorporated under license from SRS Labs, Inc.

Getting started

■ Installing batteries in the remote control

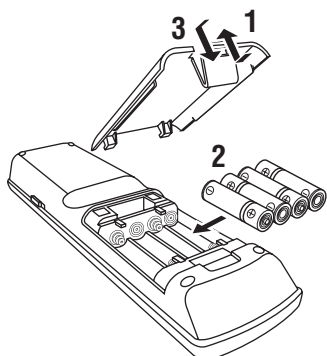

1 Take off the battery compartment cover.

2 Insert the four supplied batteries (AAA, R03, UM-4) according to the polarity markings (+ and -) on the inside of the battery compartment.

3 Snap the battery compartment cover back into place.

Notes

- Change all of the batteries if you notice the following conditions:
 - the operation range of the remote control decreases.
 - the transmit indicator does not flash or its light becomes dim.
- Do not use old batteries together with new ones.
- Do not use different types of batteries (such as alkaline and manganese batteries) together. Read the packaging carefully as these different types of batteries may have the same shape and color.
- If the batteries have leaked, dispose of them immediately. Avoid touching the leaked material or letting it come into contact with clothing, etc. Clean the battery compartment thoroughly before installing new batteries.
- Do not throw away batteries with general house waste; dispose of them correctly in accordance with your local regulations.
- If the remote control is without batteries for more than 2 minutes, or if exhausted batteries remain in the remote control, the contents of the memory may be cleared. When the memory is cleared, insert new batteries, set up the remote control code and program any acquired functions that may have been cleared.

■ VOLTAGE SELECTOR (Asia and General models only)

Caution

The VOLTAGE SELECTOR on the rear panel of this unit must be set for your local voltage BEFORE plugging the power cable into the AC wall outlet. Improper setting of the VOLTAGE SELECTOR may cause damage to this unit and create a potential fire hazard.

Rotate the VOLTAGE SELECTOR clockwise or counterclockwise to the correct position using a straight slot screwdriver.

Voltages are as follows:

.....AC 110/120/220/230–240 V, 50/60 Hz

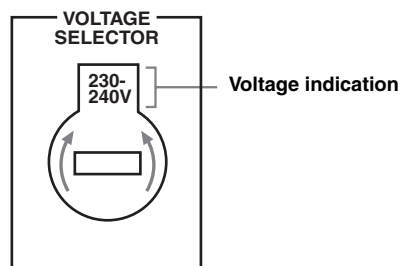

Quick start guide

The following steps describe the easiest way to enjoy DVD movie playback in your home theater.

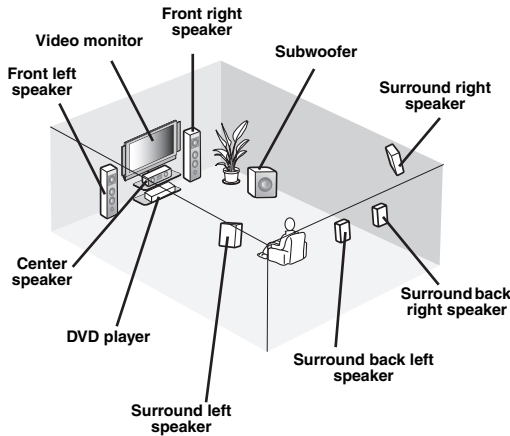

Step 1: Set up your speakers

P. 7

Step 2: Connect your DVD player and other components

P. 8

Step 3: Turn on the power and start playback

P. 9

Enjoy DVD playback!

Preparation: Check the items

In these steps, you need the following supplied accessories.

- Power cable**

The following items are not included in the package of this unit.

- Speakers**
 - Front speaker** x 2
 - Center speaker** x 1
 - Surround speaker** x 4

Select magnetically shielded speakers. The minimum required speakers are two front speakers. The priority of the requirement of other speakers is as follows:

1. Two surround speakers
2. One center speaker
3. One (or two) surround back speaker(s)

- Active subwoofer** x 1
Select an active subwoofer equipped with an RCA input jack.
- Speaker cable** x 7
- Subwoofer cable** x 1
Select a monaural RCA cable.
- DVD player** x 1
Select DVD player equipped with coaxial digital audio output jack and composite video output jack.
- Video monitor** x 1
Select a TV monitor, video monitor or projector equipped with a composite video input jack.
- Video cable** x 2
Select RCA composite video cables.
- Digital coaxial audio cable** x 1

Step 1: Set up your speakers

Place your speakers in the room and connect them to this unit.

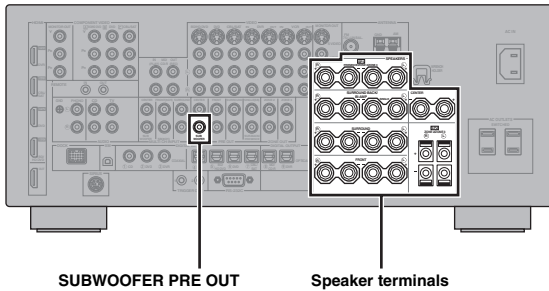

1 Place your speakers and subwoofer in the room.

2 Connect speaker cables to each speaker.

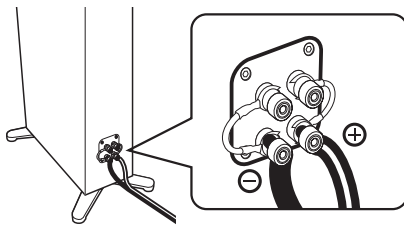

3 Connect each speaker cable to the corresponding speaker terminal of this unit.

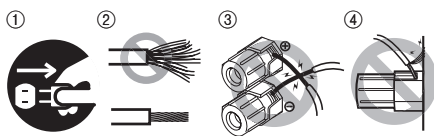

- 1 Make sure that this unit and the subwoofer are unplugged from the AC wall outlets.
- 2 Twist the exposed wires of the speaker cables together to prevent short circuits.
- 3 Do not let the bare speaker wires touch each other.
- 4 Do not let the bare speaker wires touch any metal part of this unit.

Be sure to connect the left channel (L), right channel (R), “+” (red) and “-” (black) properly.

Front speakers and center speaker

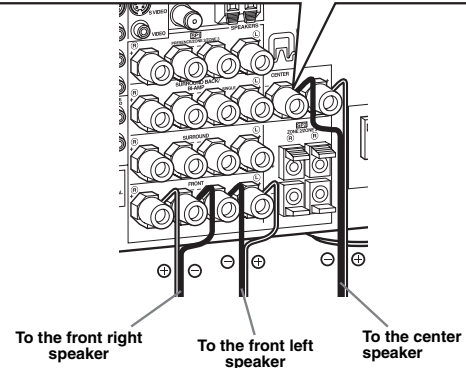
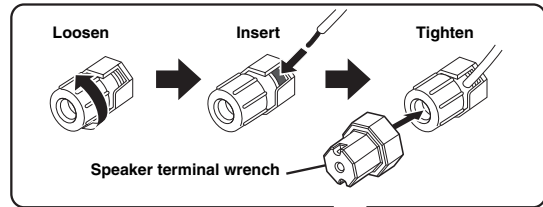

Surround and surround back speakers

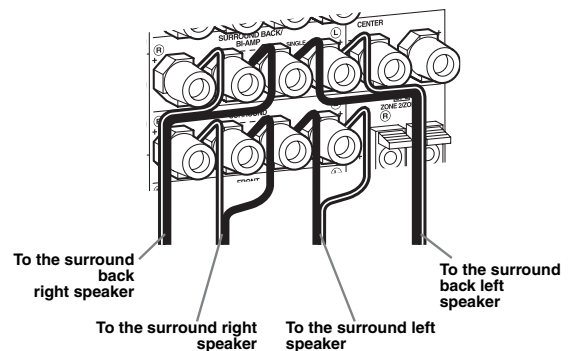

4 Connect the subwoofer cable to the SUBWOOFER PRE OUT jack of this unit and the input jack of the subwoofer.

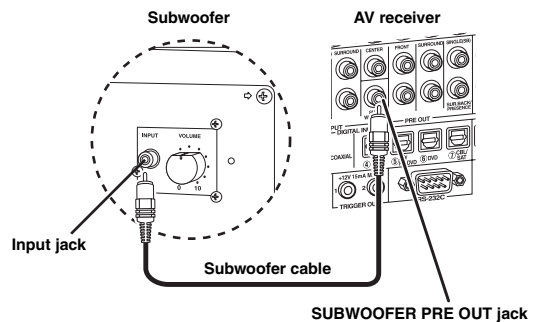

Step 2: Connect your DVD player and other components

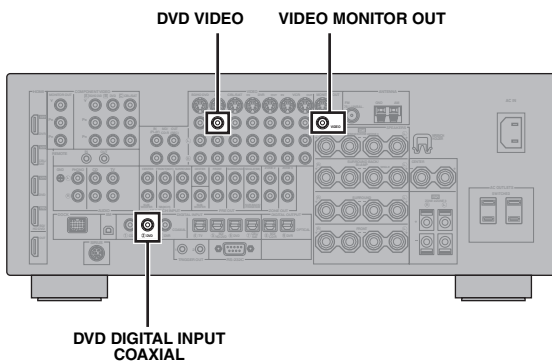

Make sure that this unit and the DVD player are unplugged from the AC wall outlets.

- 1 Connect the digital coaxial audio cable to the digital coaxial audio output jack of your DVD player and the DVD DIGITAL INPUT COAXIAL jack of this unit.

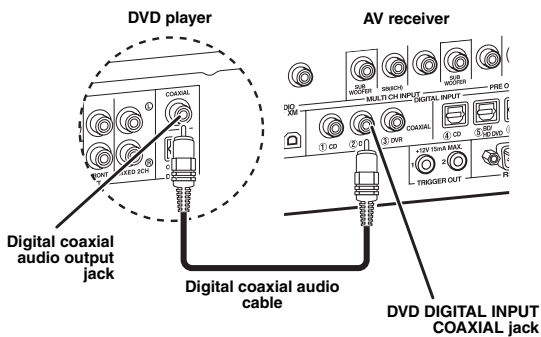

- 2 Connect the video cable to the composite video output jack of your DVD player and DVD VIDEO jack of this unit.

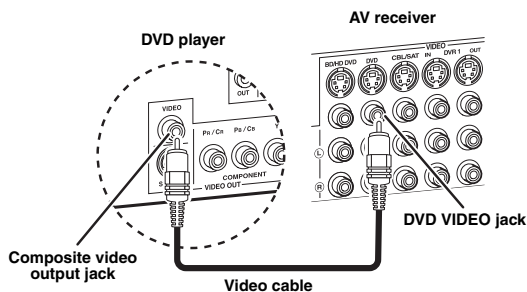

- 3 Connect the video cable to the VIDEO MONITOR OUT jack of this unit and the video input jack of your video monitor.

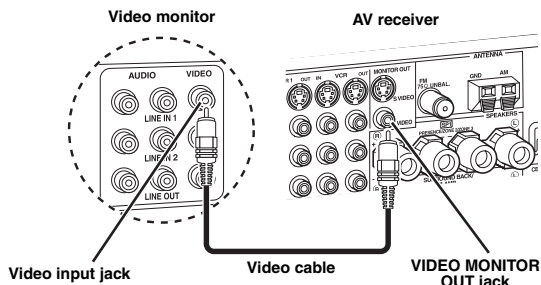

- 4 Connect the supplied power cable to this unit and then plug of the power cable and other components into the AC wall outlet.



For details about connecting the power cable, see page 25.

■ For other connections

- Other speaker combinations P. 13
- Information on jacks and cable plugs P. 16
- Information on HDMI™ P. 17
- TV monitor or projector P. 19
- Other components P. 20
- External amplifier P. 22
- Multi-format player or external decoder P. 23
- Yamaha iPod universal dock or Bluetooth wireless audio receiver P. 23
- FM/AM antennas P. 24
- XM Mini-Tuner Home Dock P. 52
- SiriusConnect tuner P. 57

Step 3: Turn on the power and start playback

Check the type of the connected speakers.

If the speakers are 6-ohm speakers, set "SPEAKER IMP." to "6Ω MIN" before using this unit (page 26). You can also use 4-ohm speakers as the front speakers (page 102).

1 Turn on the video monitor connected to this unit.

2 Press **Ⓐ** **MASTER ON/OFF** inward to the ON position on the front panel.

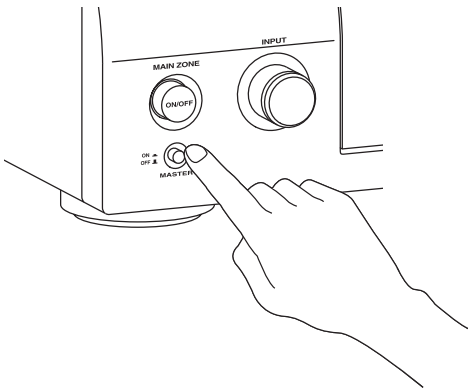

3 Rotate the **Ⓒ** **INPUT** selector to set the input source to "DVD".

4 Start playback of the desired DVD on your player.

5 Rotate **Ⓓ** **VOLUME** to adjust the volume.

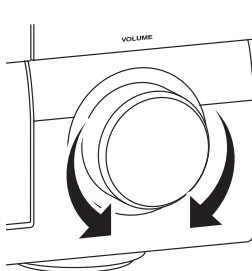

6 To set this unit to the standby mode, press **Ⓑ** **MAIN ZONE ON/OFF**.

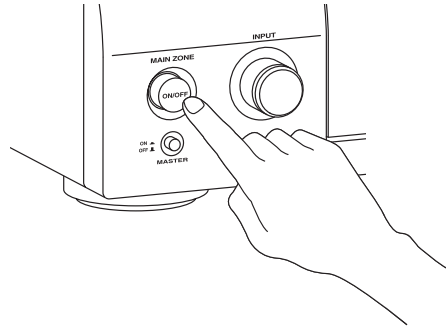

For details about turning on/off this unit and the standby mode, see page 26.

■ For other operations

- Optimizing the speaker parameters automatically Ⓔ P. 30
- Basic playback operations Ⓔ P. 35
- Sound field programs Ⓔ P. 39
- Pure high-fidelity sounds Ⓔ P. 46
- FM/AM radio tuning Ⓔ P. 47
- XM Satellite Radio tuning Ⓔ P. 52
- SIRIUS Satellite Radio tuning Ⓔ P. 57
- iPod playback Ⓔ P. 63
- Bluetooth component playback Ⓔ P. 65

Connections

Rear panel

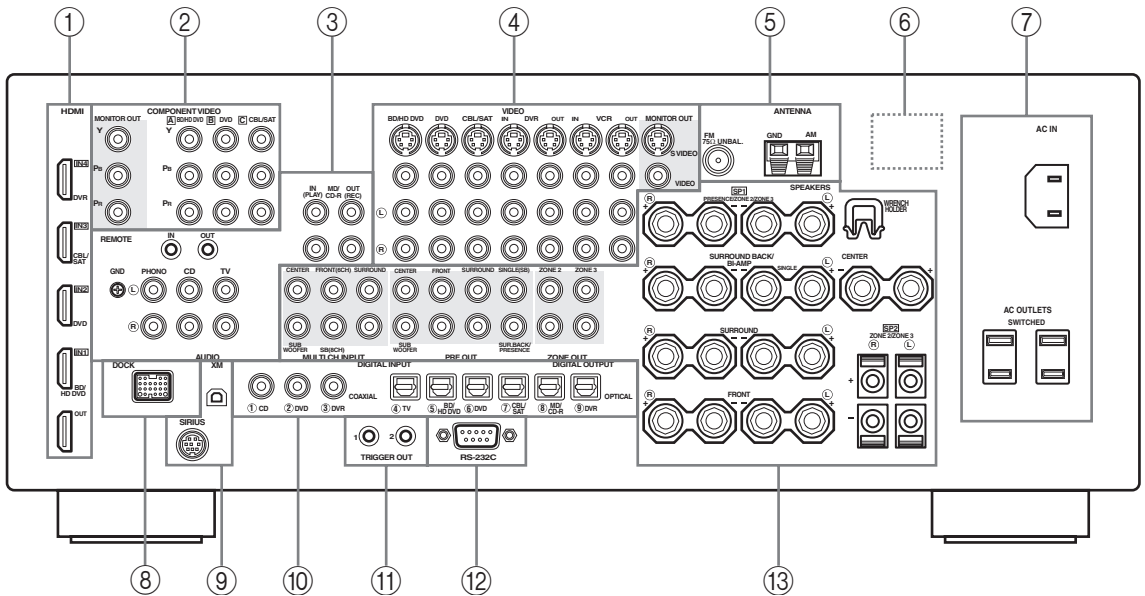

	Name	Page
①	HDMI jacks	17
②	COMPONENT VIDEO jacks	16
③	Audio component jacks	16
	REMOTE IN/OUT jacks	23, 99
④	Video component jacks	16
⑤	ANTENNA terminals	24
⑥	VOLTAGE SELECTOR (Asia and General models only)	25
⑦	AC IN	25
	AC OUTLET(S)	25
⑧	DOCK terminal	23
⑨	XM jack (U.S.A. and Canada models only)	52
	SIRIUS jack (U.S.A. and Canada models only)	57
⑩	DIGITAL INPUT/OUTPUT jacks	16
⑪	TRIGGER OUT jacks	—
⑫	RS-232C terminal	—

	Name	Page
⑬	MULTI CH INPUT jacks	23
	PRE OUT jacks	22
	ZONE OUT jacks	99
	Speaker terminals	13
	WRENCH HOLDER	15

Notes

- The TRIGGER OUT jacks are control expansion terminals for custom installation.
- The RS-232C terminal is a control expansion terminal for factory use only. Consult your dealer for details.

Placing speakers

The speaker layout below shows the speaker setting we recommend.

- 7.1-channel speaker layout is highly recommended for playback of the high definition digital audio sources (Dolby TrueHD, DTS-HD Master Audio, etc.) with sound field programs.
- We recommend that you add the presence speakers for the effect sounds of the CINEMA DSP sound field program.

7.1-channel speaker layout

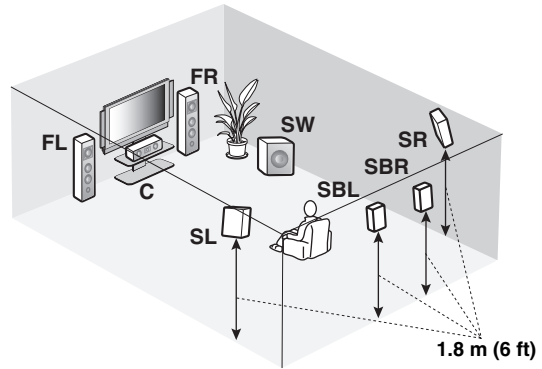
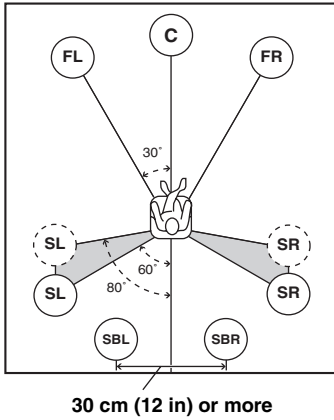

6.1-channel speaker layout

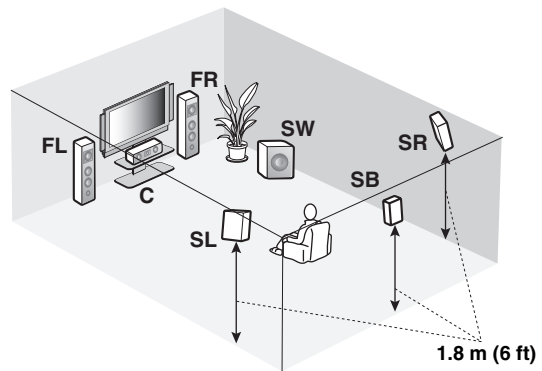
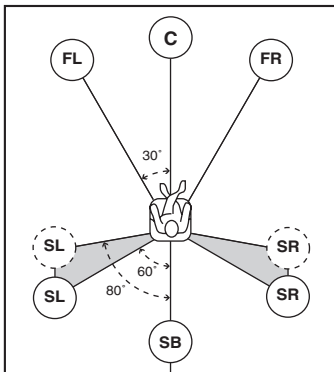

5.1-channel speaker layout

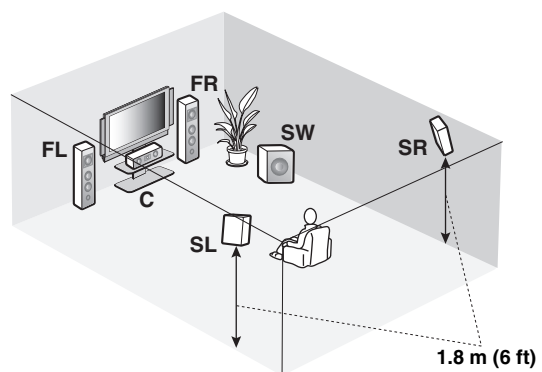
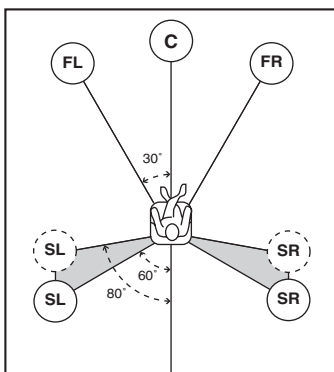

■ Speaker types

Front left and right speakers (FL and FR)

The front speakers are used for the main source sound plus effect sounds. Place these speakers at an equal distance from the ideal listening position. The distance of each speaker from each side of the video monitor should be the same.

Center speaker (C)

The center speaker is for the center channel sounds (dialog, vocals, etc.). If for some reason it is not practical to use a center speaker, you can do without it. Best results, however, are obtained with the full system.

Surround left and right speakers (SL and SR)

The surround speakers are used for effect and surround sounds.

For 5.1-channel speaker layout, place these speakers farther back compared with the placement in the 7.1-channel speaker layout.

Surround back left and right speakers (SBL and SBR)/Surround back speaker (SB)

The surround back speakers supplement the surround speakers and provide more realistic front-to-back transitions.

For 6.1-channel speaker layout, surround back left and right channel signals are mixed down and output at the single surround back speaker by configuring the “SUR.B L/R SP” setting (page 76).

For 5.1-channel speaker layout, surround back left and right channel signals are output at the surround left and right speakers by configuring the “SUR.B L/R SP” setting (page 76).

Subwoofer (SW)

The use of a subwoofer with a built-in amplifier, such as the Yamaha Active Servo Processing Subwoofer System, is effective not only for reinforcing bass frequencies from any or all channels, but also for reproducing the high fidelity sound of the LFE (low-frequency effect) channel included in bitstreams and multi-channel PCM sources.

The position of the subwoofer is not so critical, because low bass sounds are not highly directional. But it is better to place the subwoofer near the front speakers. Turn it slightly toward the center of the room to reduce wall reflections.

For other speaker combinations

You can enjoy multi-channel sources with sound field programs by using a speaker combination other than the 7.1/6.1/5.1-channel speaker combinations.

Use the automatic setup feature (pages 30) or set the “SPEAKER MENU” parameters (page 75) to output the surround sounds at the connected speakers.

■ Presence left and right speakers (PL and PR)

The presence speakers supplement the sound from the front speakers with extra ambient effects produced by the sound field programs (page 39). We recommend that you use the presence speakers especially for the CINEMA DSP sound field programs. To use the presence speakers, connect the speakers to SP1 speaker terminals and then set “PRESENCE SP” to “YES” (page 76).

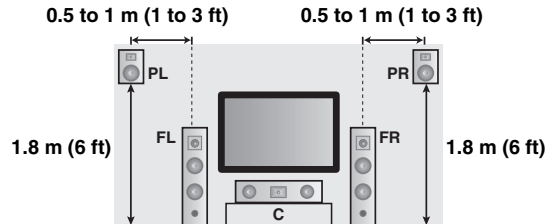

Connecting speakers

Be sure to connect the left channel (L), right channel (R), “+” (red) and “-” (black) properly. If the connections are faulty, this unit cannot reproduce the input sources accurately.

Caution

- Before connecting the speakers, make sure that this unit is turned off (page 26).
- Do not let the bare speaker wires touch each other or do not let them touch any metal part of this unit. This could damage this unit and/or speakers.
- Use magnetically shielded speakers. If this type of speaker still creates interference with the monitor, place the speakers away from the monitor.
- If you are to use 6-ohm speakers, be sure to set “SPEAKER IMP.” to “6Ω MIN” before using this unit (page 26). You can also use 4-ohm speakers as the front speakers (page 102).

Notes

- A speaker cord is actually a pair of insulated cables running side by side. Cables are colored or shaped differently, perhaps with a stripe, groove or ridge. Connect the striped (grooved, etc.) cable to the “+” (red) terminals of this unit and your speaker. Connect the plain cable to the “-” (black) terminals.
- You can connect both surround back and presence speakers to this unit, however they do not output sound simultaneously. This unit automatically switches the presence speakers and surround back speakers depending on the input sources and the selected sound field programs.

7.1-channel speaker connection

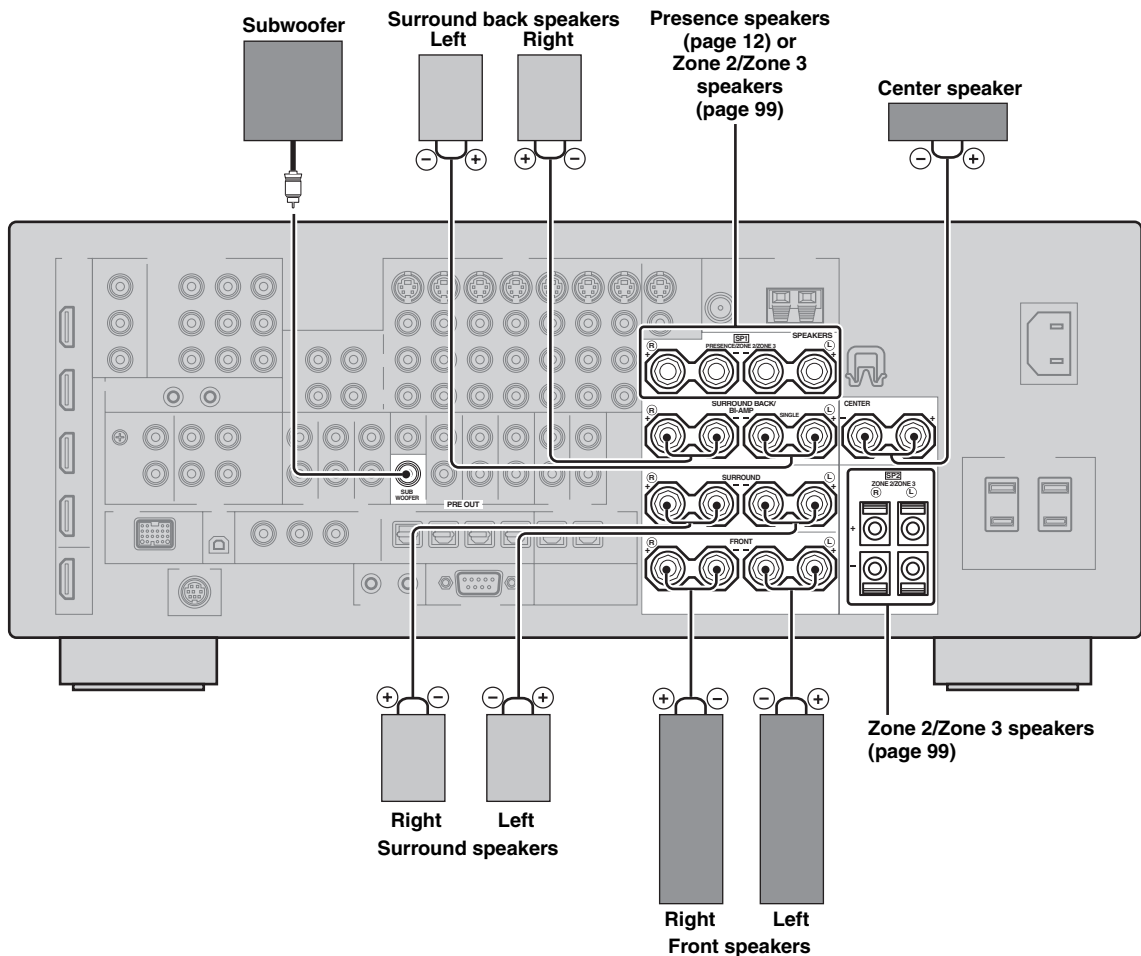

■ 6.1-channel speaker connection

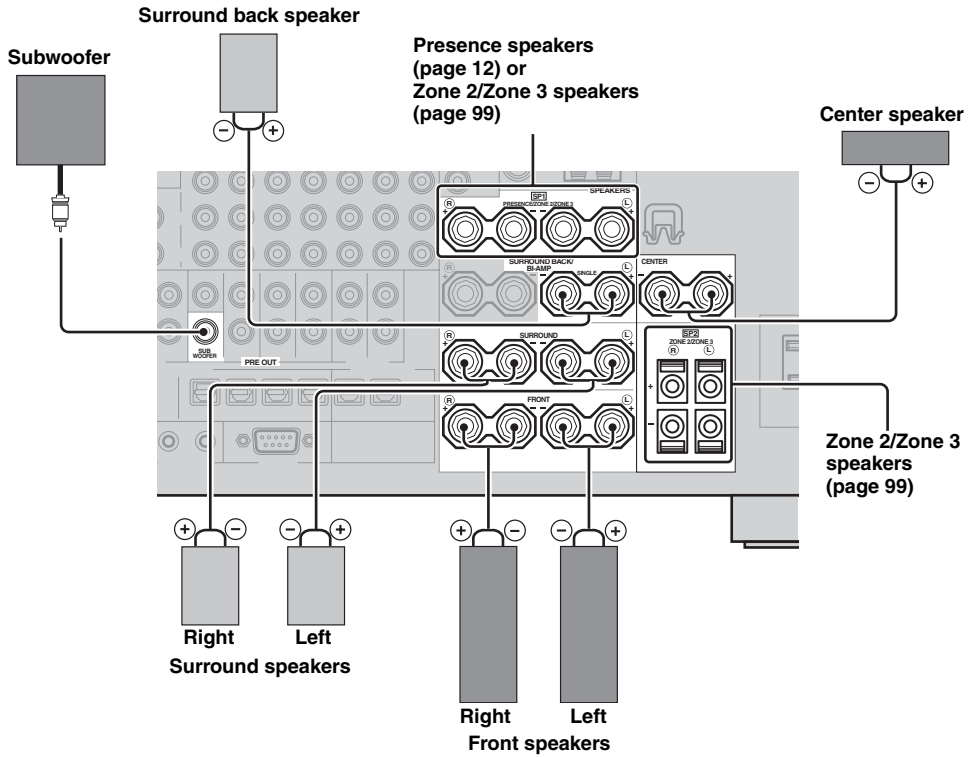

■ 5.1-channel speaker connection

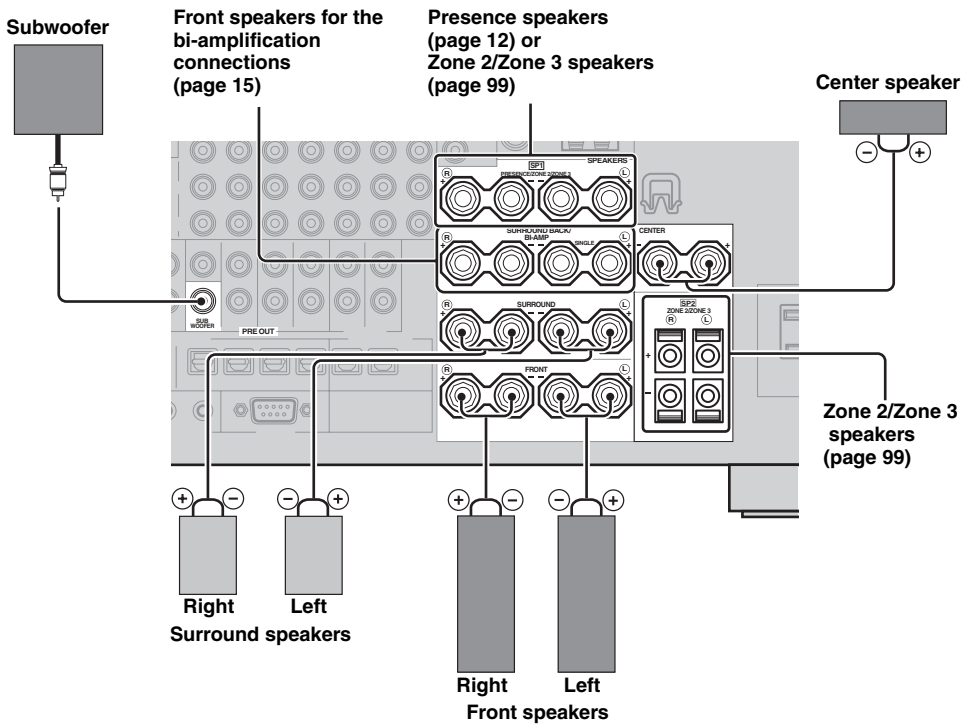

■ Connecting the speaker cable

- 1 Remove approximately 10 mm (0.4 in) of insulation from the end of each speaker cable and then twist the exposed wires of the cable together to prevent short circuits.

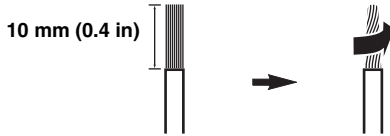

- 2 Loosen the knob using the supplied speaker terminal wrench, insert one bare wire into the hole and then tighten the knob.

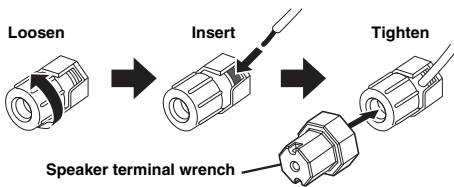

- 3 Hook the speaker terminal wrench onto **WRENCH HOLDER** on the rear panel of this unit when not in use.

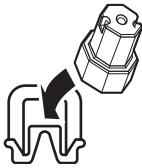

■ Connecting to the SP2 speaker terminals

Connect Zone 2 or Zone 3 speakers to these terminals (page 99).

Open the tab, insert one bare wire into the hole and then close the tab.

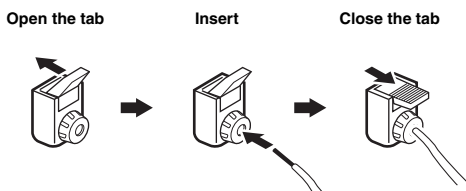

■ Connecting the banana plug (Except U.K., Europe, Asia and Korea models)

Tighten the knob using the supplied speaker terminal wrench and then insert the banana plug into the end of the terminal.

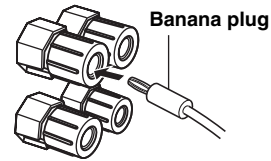

You can also use the banana plug with the SP2 speaker terminals. Open the tab and then insert one banana plug into the hole on the terminal. Do not close the tab after connecting the banana plug.

■ Using bi-amplification connections

Caution

Remove the shorting bars or bridges of your speakers to separate the LPF (low pass filter) and HPF (high pass filter) crossovers.

You can make bi-amplification connections to one speaker system which supports bi-amplification connection as shown below. To activate the connections, configure the "BI-AMP" setting (page 103).

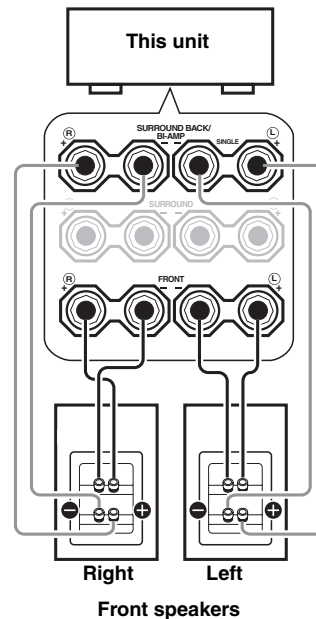

Note

When you make the conventional connection with the speakers, make sure that the shorting bars are put into the terminals of the speakers appropriately. Refer to the instruction manuals of the speakers for details.

Information on jacks and cable plugs

This unit has three types of audio jacks, three types of video jacks and HDMI jacks. You can choose the connection method depending on the component to be connected.

■ Audio jacks

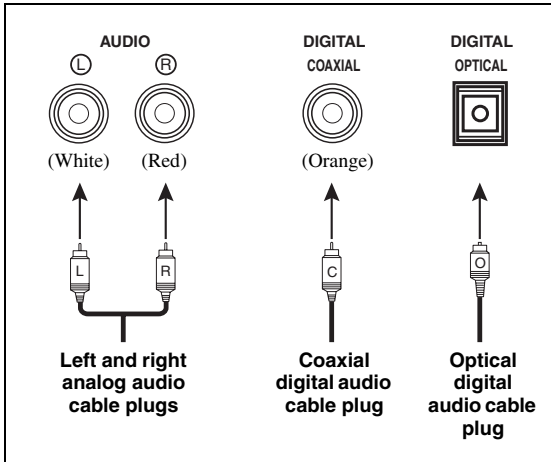

AUDIO jacks

For conventional analog audio signals transmitted via left and right analog audio cables. Connect red plugs to the right jacks and white plugs to the left jacks.

COAXIAL jacks

For digital audio signals transmitted via coaxial digital audio cables.

OPTICAL jacks

For digital audio signals transmitted via optical digital audio cables.

Note

You can use the digital jacks to input PCM, Dolby Digital and DTS bitstreams. When you connect components to both the COAXIAL and OPTICAL jacks, priority is given to the signals input at the COAXIAL jack. All digital input jacks are compatible with up to 96-kHz sampling digital signals.

■ Video jacks

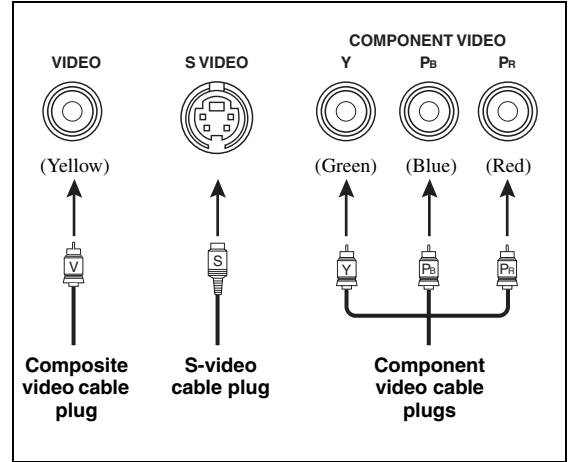

VIDEO jacks

For conventional composite video signals transmitted via composite video cables.

S VIDEO jacks

For S-video signals, separated into the luminance (Y) and chrominance (C) video signals transmitted on separate wires of S-video cables.

COMPONENT VIDEO jacks

For component video signals, separated into the luminance (Y) and chrominance (P_B, P_R) video signals transmitted on separate wires of component video cables.



This unit is equipped with the video conversion function. (page 18)

Information on HDMI™

This unit has four HDMI input jacks and one HDMI output jack for digital audio and video signal input/output.

■ HDMI jack and cable plug

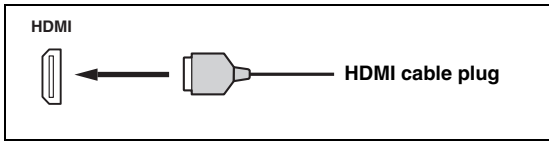

- We recommend that you use a commercially available HDMI cable shorter than 5 meters (16 feet) with the HDMI logo printed on it.
- Use a conversion cable (HDMI jack ↔ DVI-D jack) to connect this unit to other DVI components.
- You can check the potential problem about the HDMI connection (page 37).
- This unit is equipped with the video conversion function (page 18).

Notes

- Do not disconnect or connect the cable or turn off the power of the HDMI components connected to the HDMI OUT jack of this unit while data is being transferred. Doing so may disrupt playback or cause noise.
- The HDMI OUT jack outputs the audio signals input at the HDMI input jacks only.
- If you turn off the video monitor connected to the HDMI OUT jack via a DVI connection, the connection may fail.

■ HDMI signal compatibility with this unit

Audio signals

Audio signal types	Audio signal formats	Compatible media
2ch Linear PCM	2ch, 32-192 kHz, 16/20/24 bit	CD, DVD-Video, DVD-Audio, etc.
Multi-ch Linear PCM	8ch, 32-192 kHz, 16/20/24 bit	DVD-Audio, etc.
DSD	2/5.1ch, 2.8224 MHz, 1 bit	SACD, etc.
Bitstream	Dolby Digital, DTS	DVD-Video, etc.
Bitstream (High definition audio)	Dolby TrueHD, Dolby Digital Plus, DTS-HD Master Audio, DTS-HD High Resolution Audio	Blu-ray Disc, HD DVD, etc.



- If the input source component can decode the bitstream audio signals of audio commentaries, you can play back the audio sources with the audio commentaries mixed down by using the following connections:
 - multi-channel analog audio input (page 23)
 - DIGITAL INPUT OPTICAL (or COAXIAL)

- Refer to the instruction manuals of the input source component, and set the component appropriately.

Notes

- When CPPM copy-protected DVD audio is played back, video and audio signals may not be output depending on the type of the DVD player.
- This unit is not compatible with HDCP-incompatible HDMI or DVI components.
- To decode the audio bitstream signals on this unit, set the input source component appropriately so that the component outputs the audio bitstream signals directly (does not decode the bitstream signals on the component).
- This unit is not compatible with the audio commentary features (for example, the special audio contents downloaded via Internet) of Blu-ray Disc or HD DVD. This unit does not play back the audio commentaries of the Blu-ray Disc or HD DVD contents.

Video signals

This unit is compatible with the video signals of the following resolutions:

- 480i/60 Hz
- 576i/50 Hz
- 480p/60 Hz
- 576p/50 Hz
- 720p/60 Hz, 50 Hz
- 1080i/60 Hz, 50 Hz
- 1080p/60 Hz, 50 Hz, 24Hz

Compatibility with Deep Color and x.v.Color video signals

This unit accepts Deep Color (30 or 36-bit) and x.v.Color video signals. To output those video signals from the HDMI OUT jack without any processing, set “HDMI RES.” to “THROUGH” (page 81).

Note

If the video monitor is not compatible with Deep Color or x.v.Color video signals, the video source may not be played back correctly.

■ Default input assignment of HDMI input jacks

HDMI input jack	Assigned input source
IN1	BD/HD DVD
IN2	DVD
IN3	CBL/SAT
IN4	DVR

Audio and video signal flow

Audio signal flow

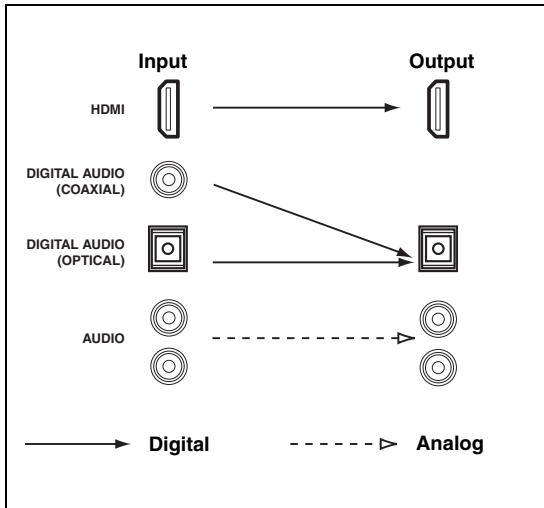

Note

Only the HDMI input jacks support DSD, Dolby TrueHD, Dolby Digital Plus, DTS-HD Master Audio and DTS-HD High Resolution Audio signal inputs.

Video signal flow

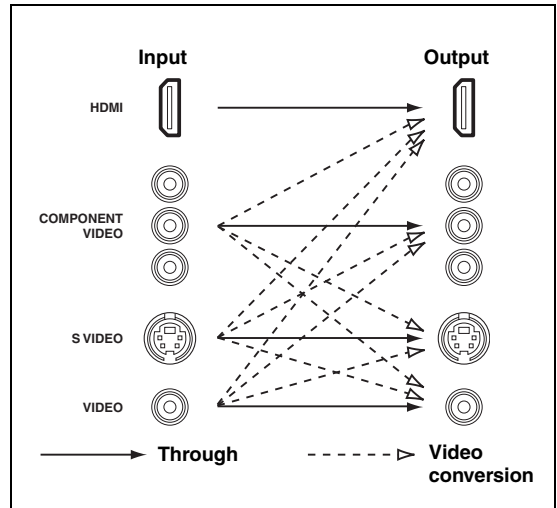

- To set the video conversion or change other video settings, configure the “VIDEO MENU” parameters (page 80).
- If different analog video signals are input concurrently, the following priority order will be applied.
 (1) COMPONENT VIDEO, (2) S VIDEO, (3) VIDEO.

Connecting a TV monitor or projector



Make sure that this unit and other components are unplugged from the AC wall outlets.



To select the types of the audio signals output at the HDMI OUT jack, configure the “HDMI AUDIO” setting (page 80).

Note

If you turn off the video monitor connected to the HDMI OUT jack via a DVI connection, the connection may fail. In this case, the HDMI indicator flashes irregularly.

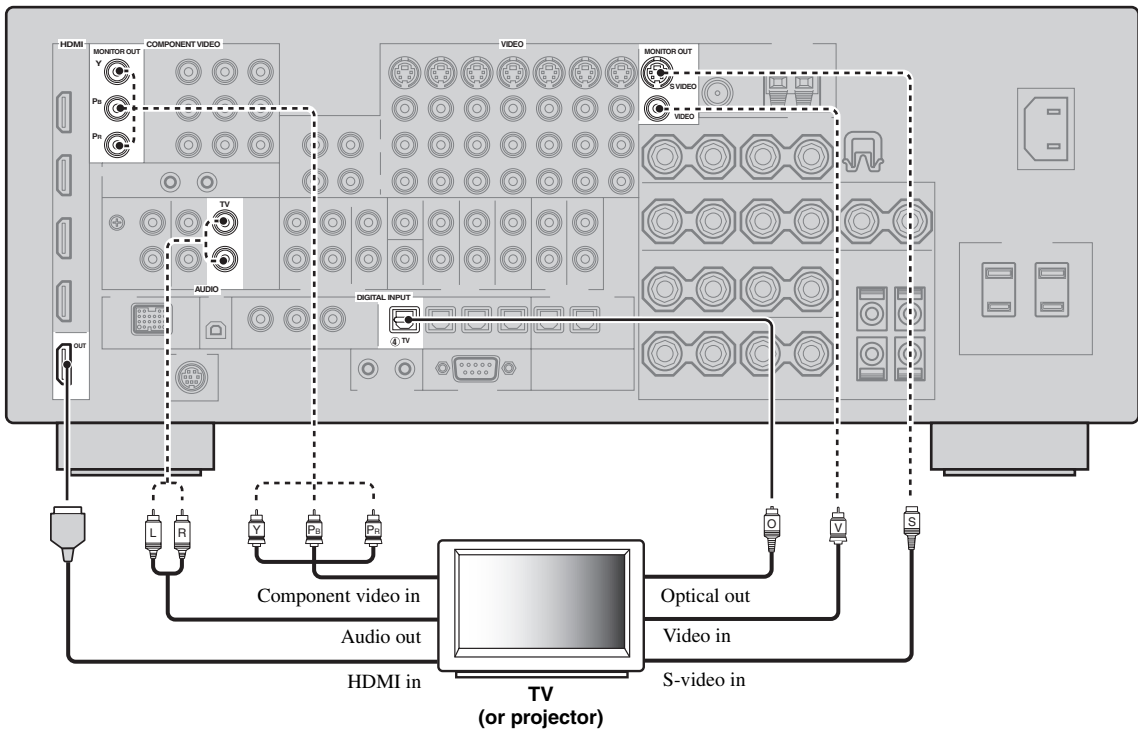

Connecting other components

■ Connecting audio and video components

This unit has three types of audio jacks, three types of video jacks and HDMI jacks. You can choose the connection method depending on the component to be connected.



HDMI can transmit both digital audio and video over a single HDMI cable.

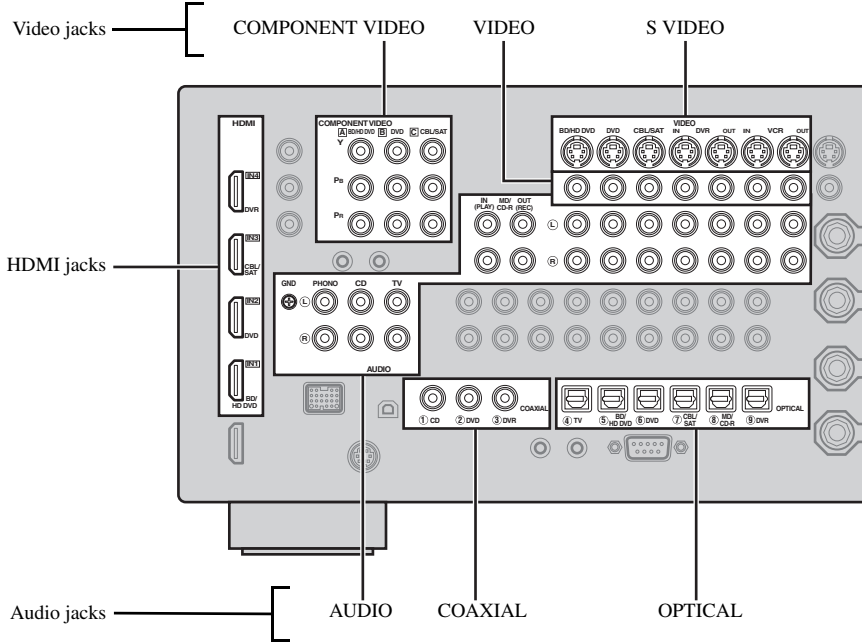

Connection example (connecting a DVD player)

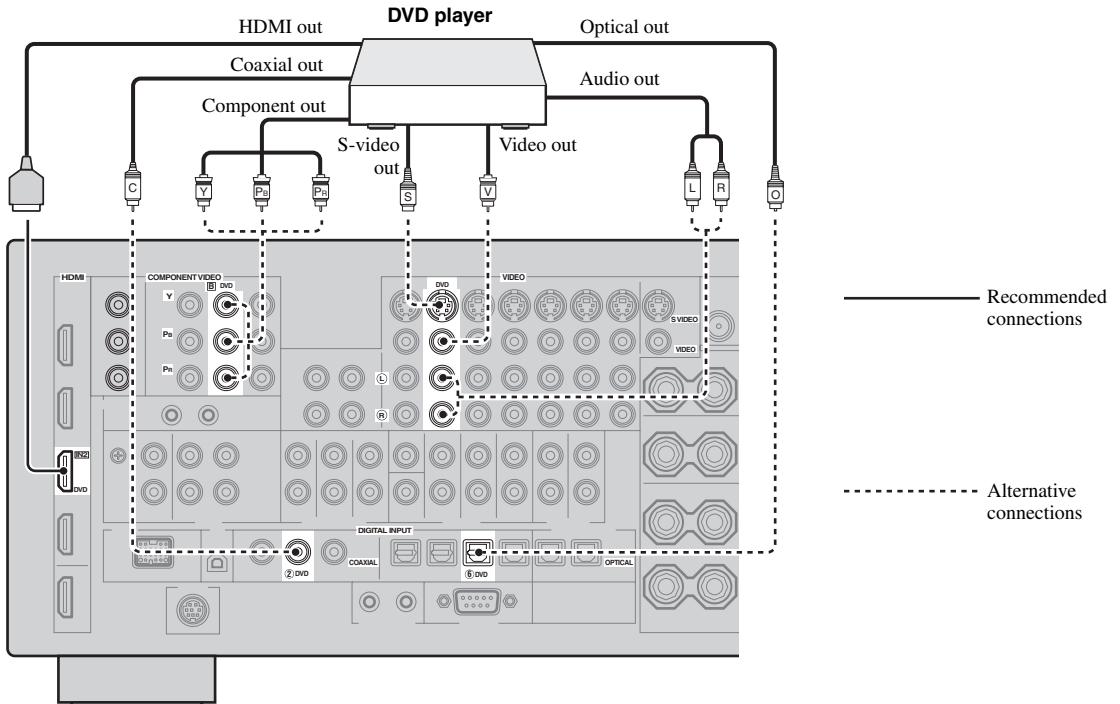

Jacks used for audio and video connections

Recommended connections are indicated by boldface. When connecting a recording component, you need to make additional connections for recording (signal transmission from this unit to the recording component).



Make sure that this unit and other components are unplugged from the AC wall outlets.



You can also use the VIDEO AUX jacks (page 24) on the front panel to connect an additional component.

Component	Signal type	Jacks to connect	
		On component	On this unit
Blu-ray Disc or HD DVD player	Audio/Video	HDMI out	HDMI IN1 (BD/HD DVD)
	Audio	Optical out	OPTICAL (BD/HD DVD)
		Audio out (analog)	AUDIO (BD/HD DVD)
		Video	Component out
	Video	S-video out	S VIDEO (BD/HD DVD)
		Video out (composite)	VIDEO (BD/HD DVD)
DVD player	Audio/Video	HDMI out	HDMI IN2 (DVD)
	Audio	Optical out	OPTICAL (DVD)
		Coaxial out	COAXIAL (DVD)
		Audio out (analog)	AUDIO (DVD)
	Video	Component out	COMPONENT VIDEO (DVD)
		S-video out	S VIDEO (DVD)
		Video out (composite)	VIDEO (DVD)
Set-top box		Audio/Video	HDMI out
	Audio	Optical out	OPTICAL (CBL/SAT)
		Audio out (analog)	AUDIO (CBL/SAT)
		Video	Component out
	Video	S-video out	S VIDEO (CBL/SAT)
		Video out (composite)	VIDEO (CBL/SAT)
DVD recorder	Audio/Video	HDMI out	HDMI IN4 (DVR)
	Audio	Coaxial out	COAXIAL (DVR)
		Audio out (analog)	AUDIO (DVR IN)
		Video	S-video out
	Video	Video out (composite)	VIDEO (DVR IN)
		Audio recording	Optical in
	Video recording	Audio in (analog)	AUDIO (DVR OUT)
		S-video in	S VIDEO (DVR OUT)
		Video in (composite)	VIDEO (DVR OUT)

Component	Signal type	Jacks to connect	
		On component	On this unit
VCR	Audio	Audio out (analog)	AUDIO (VCR IN)
	Video	S-video out	S VIDEO (VCR IN)
		Video out (composite)	VIDEO (VCR IN)
	Audio recording	Audio in (analog)	AUDIO (VCR OUT)
	Video recording	S-video in	S VIDEO (VCR OUT)
Video in (composite)		VIDEO (VCR OUT)	
CD player	Audio	Coaxial out	COAXIAL (CD)
		Audio out (analog)	AUDIO (CD)
MD or CD recorder	Audio	Audio out (analog)	AUDIO (MD/CD-R IN)
	Audio recording	Optical in	OPTICAL (MD/CD-R)
		Audio in (analog)	AUDIO (MD/CD-R OUT)
Turntable	Audio	Audio out (analog)	AUDIO (PHONO)

Notes

- Be sure to make the same type of video connections as those made for your TV if the video conversion is disabled. For example, if you connected your TV to the VIDEO MONITOR OUT jack of this unit, connect other components to the VIDEO jacks.
- Check the copyright laws in your country to record from CDs, radio, etc. Recording of copyrighted material may infringe copyright laws.
- If you connect your DVD player to both the OPTICAL and COAXIAL jacks, priority is given to the signals input at the COAXIAL jack.
- OSD signals are not output at the DVR OUT and VCR OUT jacks and cannot be recorded.
- To make a digital connection to a component other than the default one assigned to each DIGITAL INPUT or DIGITAL OUTPUT jack, configure the “I/O ASSIGNMENT” setting (page 82).
- When connecting a turntable with a low-output MC cartridge to the PHONO jack, use an in-line boosting transformer or MC-head amplifier.
- Connect your turntable to the GND terminal of this unit to reduce noise in the signal.

■ Connecting an external amplifier

This unit has more than enough power for any home use. However, if you want to add more power to the speaker output or if you want to use another amplifier, connect an external amplifier to the PRE OUT jacks. Each PRE OUT jack outputs the same channel signals as the corresponding SPEAKERS terminals.

Notes

- When you make connections to the PRE OUT jacks, do not make any connections to the SPEAKERS terminals.
- Adjust the volume level of the subwoofer with the control on the subwoofer.

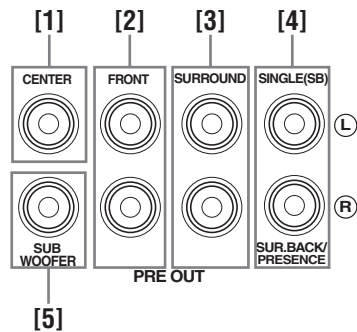

[1] CENTER PRE OUT jack
Center channel output jack.

[2] FRONT PRE OUT jacks
Front channel output jacks.

[3] SURROUND PRE OUT jacks
Surround channel output jacks.

[4] SUR.BACK/PRESENCE PRE OUT jacks

Surround back or presence channel output jacks. When you only connect one external amplifier for the surround back channel, connect it to the SINGLE (SB) jack.



- To output surround back channel signals at these jacks, set "PRESENCE SP" to "NONE" and "SUR.B L/R SP" to any parameter except "NONE" (page 76).
- To output presence channel signals at these jacks, set "PRESENCE SP" to "YES" and "SUR.B L/R SP" to "NONE" (page 76).

[5] SUBWOOFER PRE OUT jack

Connect a subwoofer with a built-in amplifier.

■ Connecting a multi-format player or an external decoder

This unit is equipped with 6 additional input jacks (FRONT L/R, CENTER, SURROUND L/R and SUBWOOFER) for discrete multi-channel input from a multi-format player, external decoder, etc. If you set "INPUT CH" to "8ch" (page 83), the analog audio input jacks assigned as "FRONT" can be used as the front channel input jacks.

Notes

- When you select "MULTI CH" as the input source, the digital sound field processor is automatically disabled.
- Since this unit does not redirect signals input at the MULTI CH INPUT jacks to accommodate for missing speakers, connect at least a 5.1-channel speaker system when using this feature.

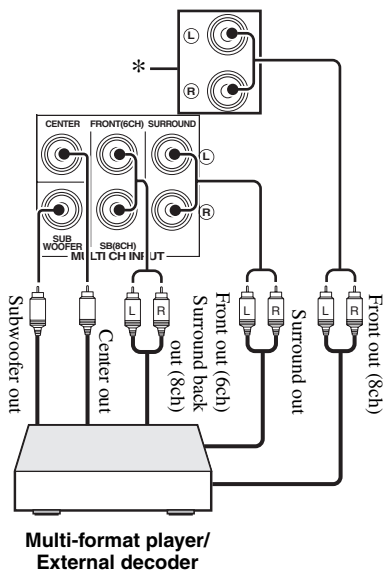

* The analog audio input jacks assigned as "FRONT" in "MULTI CH" (page 83).

■ Connecting a Yamaha iPod universal dock or Bluetooth wireless audio receiver

This unit is equipped with the DOCK terminal on the rear panel that allows you to connect a Yamaha iPod universal dock (such as YDS-11, sold separately) or Bluetooth wireless audio receiver (such as YBA-10, sold separately). Connect a Yamaha iPod universal dock or Bluetooth receiver to the DOCK terminal on the rear panel of this unit using its dedicated cable.

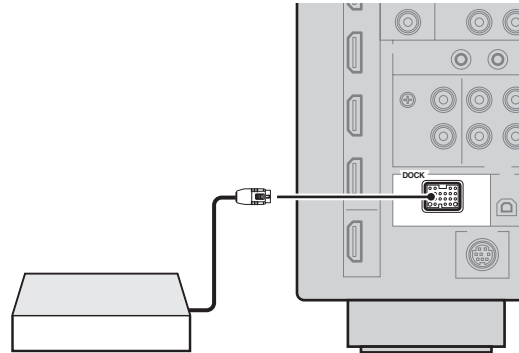

Yamaha iPod universal dock or Bluetooth wireless audio receiver

■ Using REMOTE IN/OUT jacks

When the components are the Yamaha products and have the capability of the transmission of the remote control signals, connect the REMOTE IN and REMOTE OUT jack to the remote control input and output jack with the monaural analog mini cable as follows.

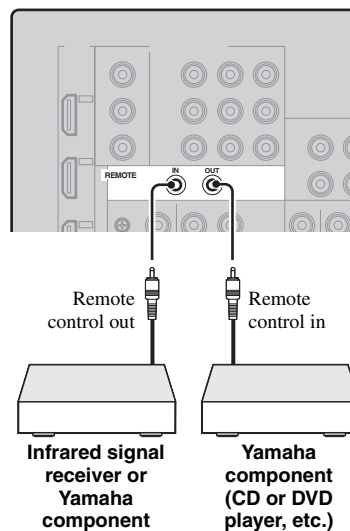

Using the VIDEO AUX jacks on the front panel

Use the VIDEO AUX jacks on the front panel to connect a game console or a video camera to this unit. To reproduce the source signals input at these jacks, select “V-AUX” as the input source.

Caution

Be sure to turn down the volume of this unit and other components before making connections.

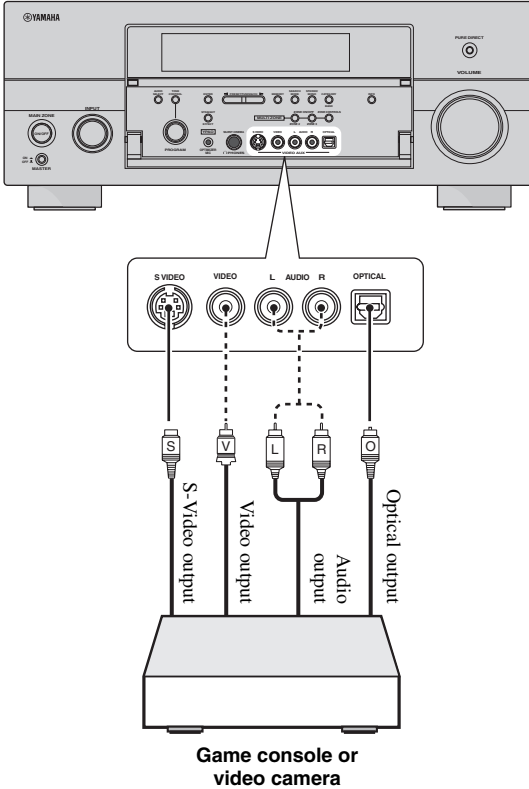

Connecting the FM and AM antennas

Both FM and AM indoor antennas are supplied with this unit. In general, these antennas should provide sufficient signal strength.

Notes

- The types of the supplied antennas and the FM antenna terminal of this unit are different depending on the models.
- (Asia and General models only) Be sure to set the tuner frequency step according to the frequency spacing in your area (page 103).
- The AM loop antenna should be placed away from this unit.
- The AM loop antenna should always be connected, even if an outdoor AM antenna is connected to this unit.
- If you experience poor reception quality, install an outdoor antenna. Consult the nearest authorized Yamaha dealer or service center about outdoor antennas.

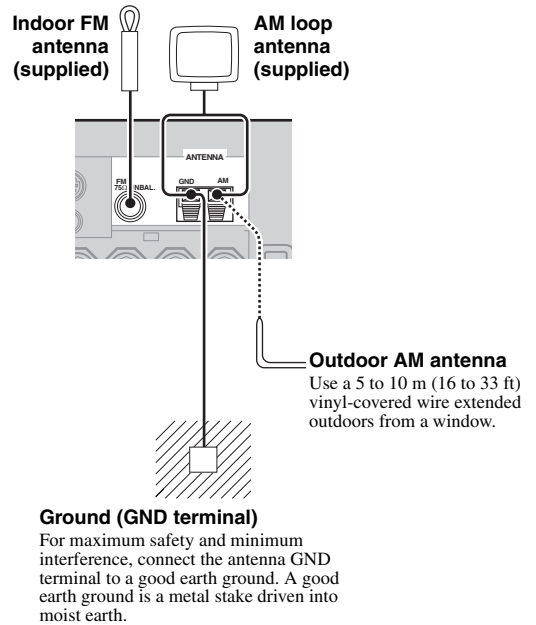

Assembling the supplied AM loop antenna

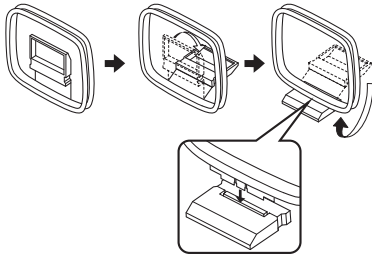

(U.S.A. model)

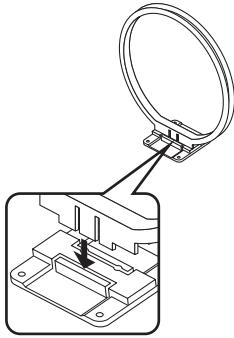

Connecting the wire of the AM loop antenna

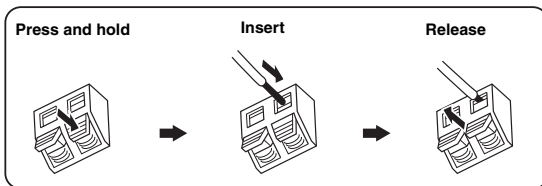

The wire of the AM loop antenna does not have any polarity and you can connect either end of the wire to AM or GND terminal.

Connecting the power cable

■ Connecting the AC power cable

Plug the supplied AC power cable into the AC inlet after all other connections are complete, then plug the AC power cable into an AC wall outlet.

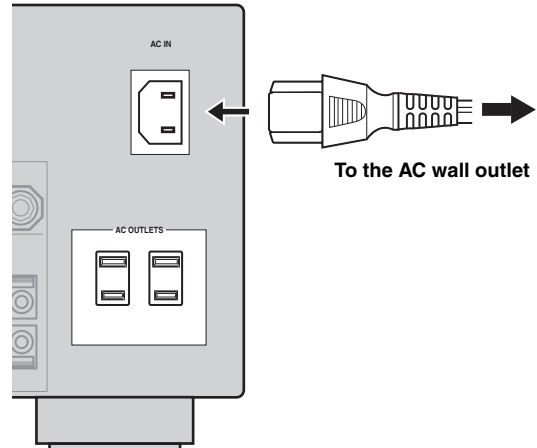

PREPARATION

Note

(Asia model only) Select one of the supplied power cables suitable for the type of AC wall outlet in your location before plugging this unit into the AC wall outlet.

■ AC OUTLET(S) (SWITCHED)

U.K. and Australia models 1 outlet
 Korea model None
 Other models 2 outlets

Use these outlet(s) to supply power to any connected components. Connect the power cable of your other components to these outlet(s). Power to these outlet(s) is supplied when this unit is turned on. However, power to these outlet(s) is cut off when this unit is turned off. For information on the maximum power or the total power consumption of the components that can be connected to these outlet(s), see “Specifications” (page 121).

Memory back-up

The memory back-up circuit prevents the stored data from being lost even if this unit is in the standby mode. However, the stored data will be lost in case the power cable is disconnected from the AC wall outlet or if the power supply is cut off for more than one week.

English

Setting the speaker impedance

Caution

If you are to use 6 ohm speakers, set “SPEAKER IMP.” to “6Ω MIN” as follows BEFORE using this unit. You can also use 4 ohm speakers as the front speakers (page 102).

- 1 Make sure this unit is turned off.
- 2 Press and hold **Ⓢ** **STRAIGHT** on the front panel and then press **Ⓜ** **MASTER ON/OFF** inward to the ON position.
This unit turns on, and the advanced setup menu appears in the front panel display.
- 3 Rotate the **Ⓝ** **PROGRAM** selector to select “SPEAKER IMP.”.
- 4 Press **Ⓢ** **STRAIGHT** repeatedly to select “6Ω MIN”.
- 5 Press **Ⓜ** **MASTER ON/OFF** to release it outward to the OFF position to save the new setting and turn off this unit.



Note

The setting you made is reflected next time you turn on this unit.

Turning this unit on and off

Turning on this unit

Press **Ⓜ** **MASTER ON/OFF** on the front panel inward to the ON position.

When you turn on this unit by pressing **Ⓜ** **MASTER ON/OFF**, the main zone is turned on.

Turning off this unit

Press **Ⓜ** **MASTER ON/OFF** on the front panel again to release it outward to the OFF position.

Set the main zone to the standby mode

Press **Ⓟ** **MAIN ZONE ON/OFF** (or **Ⓢ** **STANDBY**).

Turning on the main zone from the standby mode

Press **Ⓟ** **MAIN ZONE ON/OFF** (or **Ⓟ** **POWER**).



- Basically, we recommend that you use the standby mode to turn off this unit. In the standby mode, this unit consumes a small amount of power in order to receive infrared signals from the remote control.
- **Ⓟ** **MAIN ZONE ON/OFF**, **Ⓢ** **STANDBY** and **Ⓟ** **POWER** are operational only when **Ⓜ** **MASTER ON/OFF** is pressed inward to the ON position.
- When you turn on this unit, there will be a delay for a few seconds before this unit can reproduce sound.

If there are some problems...

- First, turn off and then turn on this unit again.
- If problems persist, initialize the parameters of this unit (page 115).

Front panel display

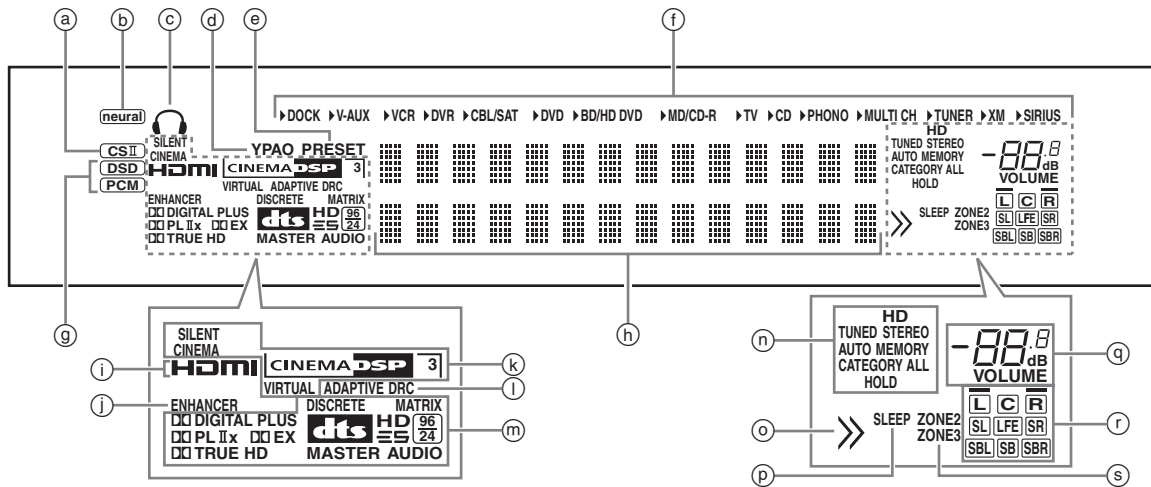

Ⓐ CSII indicator (U.S.A. model only)

Lights up when the SRS Circle Surround II decoder is active (page 66).

Ⓑ neural indicator (U.S.A. and Canada models only)

Lights up when the Neural-THX Surround decoder is active (page 66).

Ⓒ Headphones indicator

Lights up when headphones are connected (page 36).

Ⓓ YPAO indicator

Lights up when you run "AUTO SETUP" and when the speaker settings set in "AUTO SETUP" are used without any modifications (page 30).

Ⓔ PRESET indicator

Lights up while this unit is in the preset tuning mode.

Ⓕ Input source indicators

The corresponding cursor lights up to show the currently selected input source.

Note

The XM and SIRIUS indicators are only applicable to the U.S.A. and Canada models.

Ⓖ Input signal indicators

Lights up when this unit is reproducing DSD (Direct Stream Digital) or PCM (Pulse Code Modulation) digital audio signals.

Ⓗ Multi-information display

Shows the name of the current sound field program and other information when adjusting or changing settings.

Ⓘ HDMI indicator

Lights up when the signal of the selected input source is input at one of the HDMI input jacks (page 17).

⓫ ENHANCER indicator

Lights up when the Compressed Music Enhancer mode is turned on (page 44).

Ⓚ DSP indicators

The respective indicator lights up when any of the sound field programs are selected.

SILENT CINEMA indicator

Lights up when headphones are connected and a sound field program is selected (page 44).

CINEMA DSP indicator

Lights up when you select a CINEMA DSP sound field program (page 39).

3D indicator

Lights up when the CINEMA DSP 3D mode is turned on (page 45).

VIRTUAL indicator

Lights up when Virtual CINEMA DSP is active (see page 44).

Ⓛ ADAPTIVE DRC indicator

Lights up when the adaptive dynamic range control feature is turned on (page 77).

Ⓜ Decoder indicators

The respective indicator lights up when any of the decoders of this unit function.

Ⓝ Tuner indicators

Light up when this unit is in the FM, AM, XM Satellite Radio, or SIRIUS Satellite Radio tuning mode.

Note

The HD indicator is only applicable to the U.S.A. model only and lights up when this unit is turned into the HD Radio reception band.

Ⓞ Menu browsing indicator

Lights up if any items exist under the current item during menu browsing for iPod, etc.

Ⓟ SLEEP indicator

Lights up while the sleep timer is on (page 38).

Ⓠ VOLUME level indicator

- Indicates the current volume level.
- Flashes while the mute function is on (page 37).

Ⓡ Input channel and speaker indicators

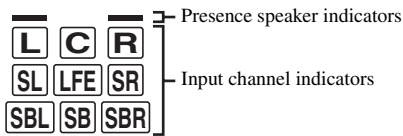

Input channel indicators

- Indicate the channel components of the current digital input signal.
- Light up or flash according to the settings of the speakers when this unit is in the automatic setup procedure (page 30).

Presence speaker indicators

Light up according to setting for “PRESENCE SP” (page 76) in “CONFIG” when this unit is in the auto setup procedure (page 30) or the speaker level setting procedure in the “LEVEL” (page 76).

Ⓢ ZONE2/ZONE3 indicators

Lights up when Zone 2 or Zone 3 is turned on (page 100).

Using the remote control

The remote control transmits a directional infrared ray. Be sure to aim the remote control directly at the remote control sensor on this unit during operation.

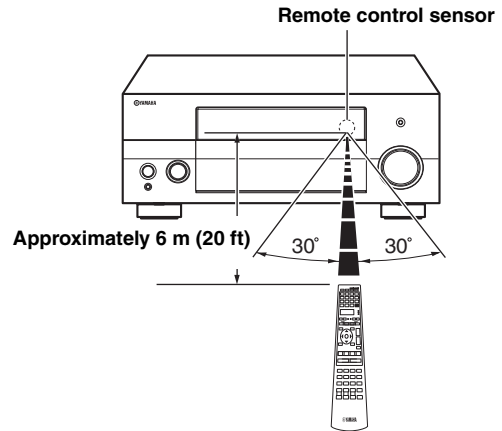

Display window (④)

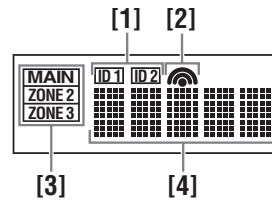

[1] ID1/ID2 indicator

Indicates the currently selected remote control ID (page 102).

[2] Transmit indicator

Appears while the remote control is sending infrared signals.

[3] Zone indicators

Indicates the currently controlling zone (page 100).

[4] Information display

Shows the name of the selected input source that you can control.

Infrared window (①)

Outputs infrared control signals. Aim this window at the component you want to operate.

Operation mode selector (15)

The function of some buttons depends on the operation mode selector position.

AMP

Operates the amplifier function of this unit.

SOURCE

Operates the component selected with an input selector button (page 90).

TV

Operates the TV (page 89).

Notes

- Do not spill water or other liquids on the remote control.
- Do not drop the remote control.
- Do not leave or store the remote control in the following conditions:
 - places of high humidity, such as near a bath
 - places of high temperatures, such as near a heater or stove
 - places of extremely low temperatures
 - dusty places
- To set the remote control codes for other components, see page 91.

Opening and closing the front panel door

When you want to use the controls behind the front panel door, open the door by gently pressing on the lower part of the panel. Keep the door closed when not using these controls.

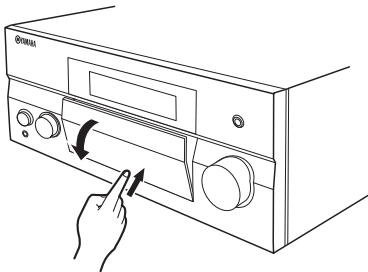

Optimizing the speaker setting for your listening room

This unit employs the YPAO (Yamaha Parametric room Acoustic Optimizer) technology which lets you avoid troublesome listening-based speaker setup and achieves highly accurate sound adjustments automatically. The supplied optimizer microphone collects and this unit analyzes the sound your speakers produce in your actual listening environment. In addition, the multi-point measurement feature enables you to optimize the setup of this unit for up to eight listening positions.

Before starting the automatic setup

1 Make sure of the following check points before starting the automatic setup operations.

- Speakers are connected appropriately.
- Headphones are disconnected from this unit.
- This unit is turned on.
- The connected subwoofer is turned on and the volume level is set to about half way (or slightly less).
- The crossover frequency controls of the connected subwoofer is set to the maximum.

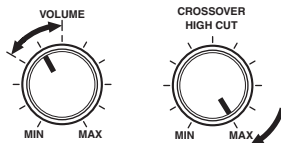

Controls of a subwoofer (example)

- The room is sufficiently quiet.
- Set the operation mode selector on the remote control to **16AMP**.

Notes

- Be advised that it is normal for loud test tones to be output during the automatic setup procedure.
- To achieve the best results, make sure the room is as quiet as possible while the automatic setup procedure is in progress. If there is too much ambient noise, the results may not be satisfactory.

2 Connect the supplied optimizer microphone to the OPTIMIZER MIC jack on the front panel.

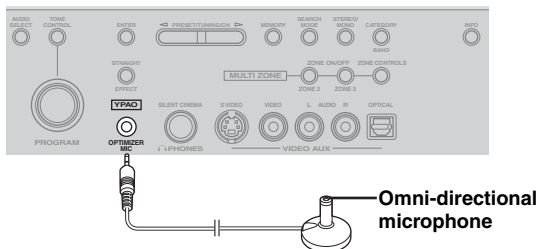

“MIC ON View OSD MENU” appears in the front panel display and the “AUTO SETUP” screen appears on the video monitor.

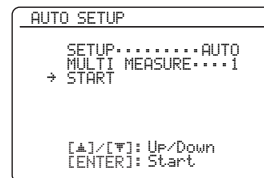

You can also run “AUTO SETUP” using the system menu that appears in the OSD or in the front panel display. This manual uses the OSD illustrations to explain the automatic setup procedure.

3 Start the automatic setup.

To optimize the setup of this unit for one listening position, follow “Basic automatic setup” (page 30). To optimize the setup of this unit for multiple listening positions, follow “Advanced automatic setup” (page 33).

Basic automatic setup

If you have done all the preparations necessary, follow the procedure below to optimize the setup of this unit for one listening position.

1 Place the optimizer microphone at your normal listening position on a flat level surface with the omni-directional microphone heading upward.

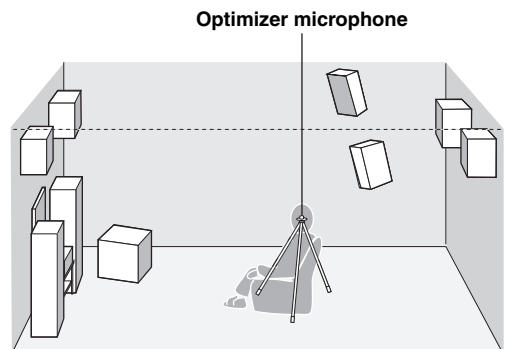



It is recommended that you use a tripod (etc.) to affix the optimizer microphone at the same height as your ears would be when you are seated in your listening position. You can use the attached screw of a tripod (etc.) to fix the optimizer microphone to the tripod (etc.).

2 Check if “START” is selected and then press **ⓈENTER.**

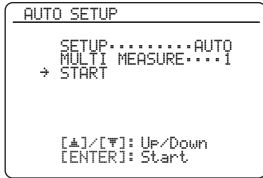

Before proceeding next operation

Once you perform the next operation, this unit starts the automatic setup procedure in 10 seconds. For more accurate measurements, we recommended that you get out of the room or move to the wall where speakers are not around during the measurement. It takes approximately 3 minutes.

3 Press **ⓈENTER to start the measurement.**

Loud test tones are output from each speaker during the measurement. Once all items are measured, “Measurement Complete” appears.

Notes

- During the automatic setup procedure, do not perform any operation on this unit.
- The measurement is canceled if an error occurs (page 32).

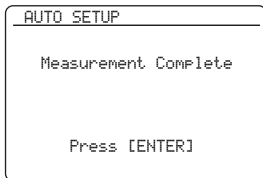
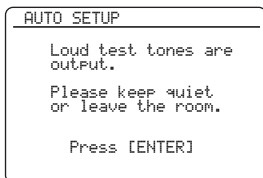

4 Press **ⓈENTER to display the result.**

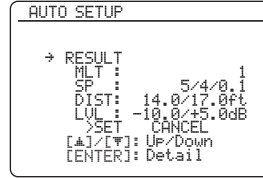

Number of the measured points MLT

Displays the number of listening positions actually measured.

Number of speakers SP

Displays the number of speakers connected to this unit in the following order:
Front/Back/Subwoofer

Speaker distance DIST

Displays the speaker distance from the listening position in the following order:
Closest speaker distance/Farthest speaker distance

Speaker level LVL

Displays the speaker output level in the following order:
Lowest speaker output level/Highest speaker output level

Note

“WARNING” and the number of warning messages appear in the above of “RESULT” if any potential problem occurs (page 33).

5 Press **ⓈENTER to display the setup results in detail.**

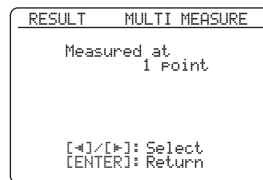

6 Press $\text{\textcircled{8}}$ </> repeatedly to toggle between the setup result displays.

Press $\text{\textcircled{8}}$ Δ / ∇ to toggle between the parameters in the result.

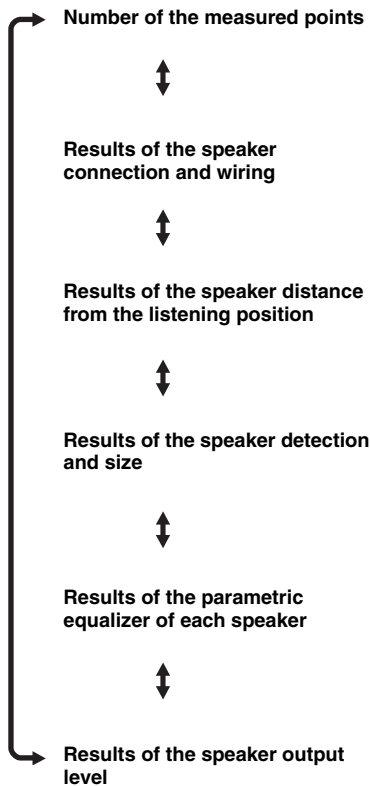

- If you are not satisfied with the results or want to manually adjust each parameter, use “MANUAL SETUP” (page 74).
- You can select the parametric equalizer type with “PEQ SELECT” (page 79).

Notes

- The distances displayed in the “DISTANCE” results may be longer than the actual distance depending on the characteristics of your subwoofer or external amplifiers if you connect them.
- In the “EQ” results, different values may be set for the same band to provide finer adjustments.

7 Press $\text{\textcircled{8}}$ ENTER to return to the top result display.

```
AUTO SETUP

RESULT
MLT :
SP : 5/4/0.1
DIST : 14.0/17.0ft
LVL : -10.0/+5.0dB
-> >SET CANCEL
[▲]/[▼]: Up/Down
[ENTER]: Enter
```

8 Press $\text{\textcircled{8}}$ </> to select “SET” or “CANCEL” and then press $\text{\textcircled{8}}$ ENTER.

```
AUTO SETUP

RESULT
MLT :
SP : 5/4/0.1
DIST : 14.0/17.0ft
LVL : -10.0/+5.0dB
-> >SET CANCEL
[▲]/[▼]: Up/Down
[ENTER]: Enter
```

Choices: **SET**, CANCEL

- Select “SET” to confirm the “AUTO SETUP” results.
- Select “CANCEL” to cancel the “AUTO SETUP” results.

9 Disconnect the optimizer microphone or press $\text{\textcircled{8}}$ MENU to exit from “SET MENU”.

Note

If you change speakers, speaker positions, or the layout of your listening environment, run “AUTO SETUP” again to recalibrate your system.

■ If an error screen appears

Press $\text{\textcircled{8}}$ </> to select “RETRY” or “EXIT” and then press $\text{\textcircled{8}}$ ENTER

The following screen is an example where “E-9:USER CANCEL” appears in the OSD.

```
ERROR

E-9:USER CANCEL
Don't operate
any function

-> >RETRY EXIT
[▲]/[▼]: Select
[ENTER]: Enter
```

Choices: **RETRY**, EXIT

- Select “RETRY” to retry the “AUTO SETUP” procedure.
- Select “EXIT” to exit from the “AUTO SETUP” procedure.



- If “E-5:NOISY” appears, you can also select “PROCEED” to

ignore the error and carry on the measurement. However, we recommend that you solve the problem before starting the measurement.

- If “E-10:INTERNAL ERROR” appears, you can select only “EXIT”.
- For details about each error message, see “AUTO SETUP” (page 113).

■ If “WARNING” appears

When this unit detects potential problems during the automatic setup procedure, “WARNING” appears in the result screen. Check the warning messages to correct your speaker settings.



The adjustments are made even if “WARNING” appears, however they may not be optimal.

- 1 Make sure the pointer is pointing at “WARNING” and then press **Ⓚ**ENTER to display the detailed information about the warning.**

The number on the right of “WARNING” indicates the number of warning messages.

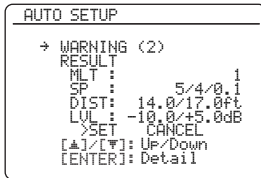

- 2 Press **Ⓚ**◀/▶ repeatedly to toggle between the warning displays.**

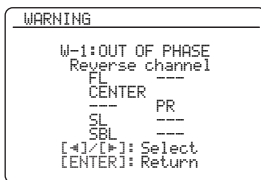

- For details about each warning message, see “AUTO SETUP” (page 113).
- When the corresponding warning message is not applicable to a speaker, “---” is displayed instead.
- If “SWFR:TOO LOW” or “SWFR:TOO HIGH” appears under “W-3:LEVEL ERROR”, adjust the volume level of the subwoofer.

- 3 Press **Ⓚ**ENTER to return to the top result display.**

Advanced automatic setup

If you have done all the preparations necessary, follow the procedure below to optimize the setup of this unit for multiple listening positions.

- 1 Place the optimizer microphone at the first listening position.**

The following illustration shows how to place the optimizer microphone in order to optimize the setup of this unit for seven listening positions for example.

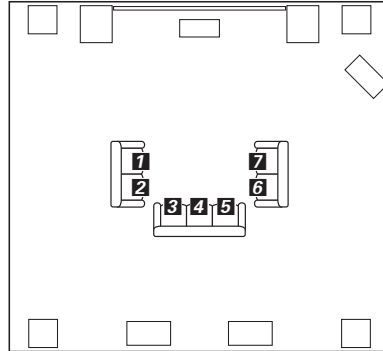

1/2/3/4/5/6/7: Listening positions

- 2 Press **Ⓚ**▲/▼ repeatedly to select “MULTI MEASURE” and then press **Ⓚ**◀/▶ repeatedly to set the number of the listening position you want to make the measurement at.**

Choices: 1 (default), 2, 3, 4, 5, 6, 7, 8

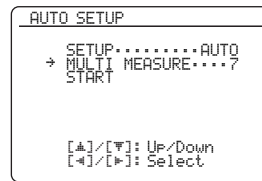

- 3 Press **Ⓚ**▲/▼ repeatedly to select “START” and then press **Ⓚ**ENTER.**

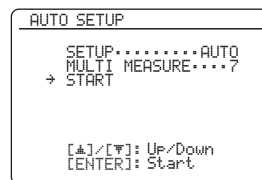

Before proceeding next operation

Once you perform the next operation, this unit starts the automatic setup procedure in 10 seconds. For more accurate measurements, we recommended that you get out of the room or move to the wall where speakers are not around during the measurement.

4 Press **Ⓢ**ENTER to start the measurement.

Loud test tones are output from each speaker during the measurement. Once all items for the first listening position are measured, the following message appears.

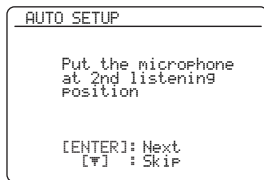

Notes

- During the automatic setup procedure, do not perform any operation on this unit.
- The measurement is canceled if an error occurs (page 32).

5 Move the optimizer microphone to the second listening position and then press **Ⓢ**ENTER to start the measurement.



To skip the measurements at the remaining listening positions, press **Ⓢ**▽.

6 Repeat step 5 until the measurement at all listening positions are made.

If you have made the measurement at all listening positions or skipped the measurement at the remaining listening positions, the following message appears.



7 Follow steps 4 to 10 in “Basic automatic setup” (page 30) to check the setup result and exit from “SET MENU”.

Reloading the automatic setup parameters

In case you are not satisfied with the speaker setup and sound adjustments made in “MANUAL SETUP”, you can restore the settings back to the values configured by the last automatic setup.

Note

If you reload the automatic setup parameters, the settings you have made in “MANUAL SETUP” are cleared. To save the settings before reloading the automatic setup parameters, see “SYSTEM MEMORY” (page 86).

1 Set the operation mode selector to **Ⓢ**AMP and then press **Ⓢ**MENU.

The top “SET MENU” screen appears in the OSD.

2 Press **Ⓢ**△ / ▽ repeatedly to select “AUTO SETUP” and then press **Ⓢ**ENTER.

3 Check if “SETUP” is selected and then press **Ⓢ**< / > repeatedly to select “RELOAD”.

4 Press **Ⓢ**△ / ▽ repeatedly to select “START” and then press **Ⓢ**ENTER.

The results of the last automatic setup are displayed.



For details about automatic setup results and how to display the setup results in detail, see “Basic automatic setup” (page 30).

5 Press **Ⓢ**△ / ▽ repeatedly to select “SET” and then press **Ⓢ**ENTER.

The automatic setup parameters are reloaded.



To cancel reloading the automatic setup parameters, press **Ⓢ**< / > repeatedly to select “CANCEL” and then press **Ⓢ**ENTER.

Playback

Caution

Extreme caution should be exercised when you play back CDs encoded in DTS. If you play back a CD encoded in DTS on a DTS-incompatible CD player, you will only hear some unwanted noise that may damage your speakers. Check whether your CD player supports CDs encoded in DTS. Also, check the sound output level of your CD player before you play back a CD encoded in DTS.



To play DTS-encoded CDs when using a digital audio connection, set "DECODER MODE" in "INPUT MENU" to "DTS" before the playback (page 82).

Before performing the following operations, set the operation mode selector on the remote control to **AMP**.

Basic procedure

1 Turn on the video monitor connected to this unit.



You can configure the display settings with "VIDEO MENU" (page 80) and "DISPLAY SET" (page 83).

2 Rotate the **INPUT** selector (or press one of the input selector buttons (3))

The name of the selected input source appears for a few seconds.

Available input sources

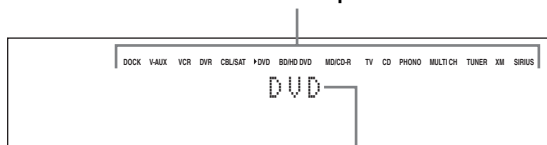

Selected input source

3 Start playback on the selected source component or select a broadcast station.

- Refer to the instruction manuals for the source component.
- FM/AM radio tuning (page 47)
- XM Satellite Radio tuning (page 52)
- SIRIUS Satellite Radio tuning (page 57)
- iPod playback (page 63)
- Bluetooth component playback (page 65)

4 Rotate **VOLUME** (or press **VOLUME +/-**) to adjust the volume to the desired output level.



To adjust the level of each speaker, see page 46.

5 Rotate the **PROGRAM** selector (or press one of the sound field program selector buttons (2) repeatedly) to select the desired sound field program.

For details about sound field program, see page 39.

Selected sound field program category

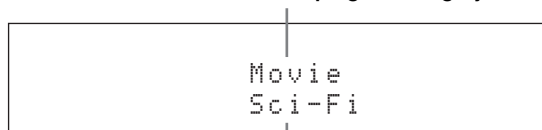

Selected sound field program



To switch the information (current input source, current sound field program, etc) displayed in the front panel display, press **INFO** (or set the operation mode selector to **AMP** and press **INFO**) repeatedly.

Selecting audio input jacks (AUDIO SELECT)

Use this feature (audio input jack select) to switch the input jack assigned to an input source when more than one jacks are assigned to an input source.

- 1 Rotate the **INPUT** selector (or press one of the input selector buttons (3)) to select the desired input source.
- 2 Press **AUDIO SELECT** (or set the operation mode to **AMP** and then press **AUDIO SEL**) repeatedly to select the desired audio input jack select setting.

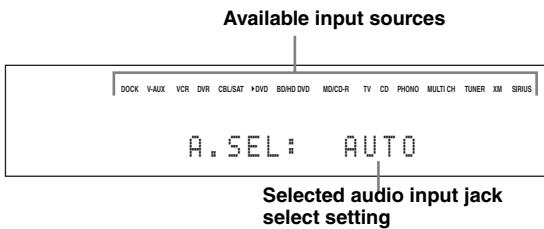

AUTO	Automatically selects input signals in the following order: (1) HDMI (2) Digital signals (3) Analog signals
HDMI	Selects only HDMI signals. When HDMI signals are not input, no sound is output.
COAX/OPT	Automatically selects input signals in the following order: (1) Digital signals input at the COAXIAL jack. (2) Digital signals input at the OPTICAL jack. When no signals are input, no sound is output.
ANALOG	Selects only analog signals. If no analog signals are input, no sound is output.



You can configure the default audio input jack select setting with "AUDIO SELECT" (page 84).

Note

This feature is not available if no digital input jack is assigned to the selected input source in "I/O ASSIGNMENT" (page 82). "HDMI" is available only when an HDMI input jack is assigned.

Selecting the multi-channel input component

Use this feature to select the component connected to the MULTI CH INPUT jacks (page 23) as the input source.

Rotate the **INPUT** selector on the front panel to select "MULTI CH" (or press **MULTI**).



You can configure the multi channel input settings with "MULTI CH" (page 81).

Note

Sound field programs cannot be selected when "MULTI CH" is selected as the input source.

Using your headphones

Connect a pair of headphones with a stereo analog audio cable plug to the PHONES jack on the front panel.

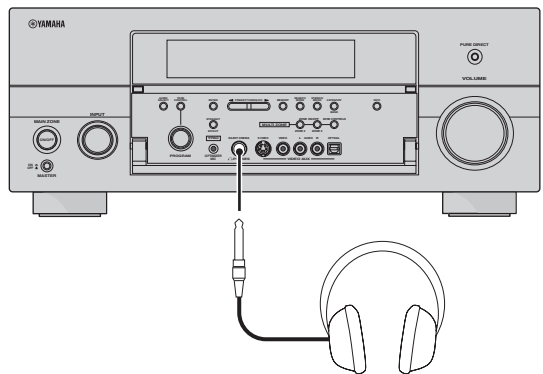

When you select a sound field program, SILENT CINEMA mode activates automatically (page 44).

Notes

- When you connect headphones, no signals are output at the speaker terminals.
- All digital multi-channel audio signals are mixed down to the left and right headphone channels.
- When "MULTI CH" is selected as the input source, only the signals input at the MULTI CH INPUT FRONT jacks are output.

Muting the audio output

Press **MUTE** on the remote control to mute the audio output. Press **MUTE** again to resume the audio output.



- The VOLUME level indicator flashes while the mute function is on.
- You can configure the muting level with “MUTING TYPE” (page 78).

Displaying the input source information (SIGNAL INFO)

You can display the format, sampling frequency, channel, bit rate and flag data of the current input signal.

- Set the operation mode selector to **AMP** and then press **MENU** on the remote control.

The top “SET MENU” screen appears in the OSD.

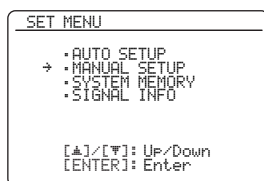

- Press **▽** repeatedly to select “SIGNAL INFO” and then press **ENTER**.

- Press **◀/▶** to toggle between the audio and video information.

- Press **MENU** on the remote control again to exit from “SET MENU”.

Audio information

FORMAT	Signal format. When this unit cannot detect a digital signal, it automatically switches to analog input.
SAMPLING	The number of samples per second taken from a continuous signal to make a discrete signal.
CHANNEL	The number of source channels in the input signal (front/surround/LFE). For example, a multi-channel soundtrack with 3 front channels, 2 surround channels and LFE, is displayed as “3/2/0.1”.
BITRATE	The number of bits passing a given point per second.
DIALOG	The dialogue normalization level preset to the current input bitstream signal.
FLAG	Flag data encoded in the bitstream, or PCM signals that cue this unit to automatically switch decoders.

Notes

- “—” appears when this unit cannot display the corresponding information.
- Some high definition audio bitstream contents may not include the discrete surround back left and right channel signals but are encoded at the bitrate of 192 kHz.
- Even if you make settings to output bitstreams directly, some players convert the Dolby TrueHD or Dolby Digital Plus bitstreams to the Dolby Digital bitstreams, while converting the DTS-HD Master Audio or DTS-HD High Resolution Audio bitstreams to the DTS bitstreams.

Video information

HDMI SIGNAL	Type of the source video signals and the video signals output at the HDMI OUT jack of this unit.
HDMI RES.	Resolution of the input signal (analog or HDMI) and the output signal (HDMI).
ANALOG RES.	Resolution of the source video signals and the analog video signals output at the COMPONENT MONITOR OUT jacks of this unit.
HDMI ERROR (HDMI MESSAGE)	Error message for HDMI sources or connected HDMI devices.

HDMI error message

Device over	The number of the connected HDMI components is over the limit.
HDCP Error	HDCP authentication failed.
Out of Res.	Out of resolution. The connected monitor is not compatible with the resolution of the input video signal.

Before performing the following operations, set the operation mode selector on the remote control to **AMP**.

Using the sleep timer

Use this feature to automatically set the main zone to the standby mode after a certain amount of time. The sleep timer is useful when you are going to sleep while this unit is playing or recording a source. The sleep timer also automatically turns off any external components connected to the AC OUTLET(S) (page 25).

Press **SLEEP on the remote control repeatedly to set the amount of time.**

The sleep timer setting changes as shown below.

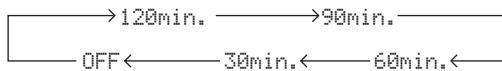

Once the sleep timer is set, the SLEEP indicator lights up in the front panel display, and the display returns to the selected sound field program.

To cancel the sleep timer

Press **SLEEP** on the remote control repeatedly to select "SLEEP OFF".



If you set the main zone to the standby mode, the sleep timer is automatically canceled.

Sound field programs

This unit is equipped with a variety of precise digital decoders that allow you to enjoy multi-channel playback from almost any stereo or multi-channel sound source. This unit is also equipped with a Yamaha digital sound field processing (DSP) chip containing several sound field programs which you can use to enhance your playback experience.

 The Yamaha CINEMA DSP sound field programs are compatible with all Dolby Digital, DTS, Dolby Surround, Dolby TrueHD and DTS-HD Master Audio sources.

Selecting sound field programs

Rotate the **PROGRAM** selector (or set the operation mode selector to **AMP** and then press one of the sound field selector buttons repeatedly).

The name of the selected sound field program appears in the front panel display and in the OSD.

- 
- You can select the desired sound field program and setting the parameters by using the OSD menu (page 67).
 - Available sound field parameters and the created sound field differ depending on the input sources and the settings of this unit.

Notes

- When you select an input source, this unit automatically selects the last sound field program used with the corresponding input source.
- Sound field programs cannot be selected when the component connected to the MULTI CH INPUT jacks is selected as the input source (page 36) or when this unit is in the Pure Direct mode (page 46).
- When you play back DTS 96/24 sources with any sound field program, this unit applies the selected program without activating the DTS 96/24 decoder.
- Sampling frequencies higher than 48 kHz are sampled down to 48 kHz or lower and then sound field programs are applied.

Descriptions of the characteristics of the sound field programs

Following indexes indicates the characteristics and trends of each sound field program.

Note

The characteristics of the sound field programs may differ depending on the settings of the listening room, etc.

Size of sound field space (Size)



Indicates the size of the sound field to be generated. If the value for this item is small, the sound is that of a small space, while if the value is large, the sound is that of a vast space.

Vertical/horizontal balance (V/H balance)



Indicates the balance of the vertical (height) and horizontal directions for the sound field to be generated. If this item is more in the horizontal direction, the sound is that of a space with strong reflections from the walls, while if it is more in the vertical direction, the sound is that of a space with strong reflections from the ceiling.

Front/rear balance (F/R balance)



A CINEMA DSP sound field processing expressing whether the effect is stronger towards the front or rear. When the effect is stronger towards the front, the listener senses a feeling of openness and depth towards the screen, while when the effect is stronger towards the rear, the listener gets a sense of envelopment and movement. Suits basically all types of contents for programs with a good front/rear balance, and is effective when selected appropriately for programs in which the balance is more towards either the front or rear.

Sound field atmosphere (Atmosphere)



The sound field to be generated is evaluated according to whether it is nearer to one or the other of the following; Simple: Sounds that fade straight-forwardly, with a light, gentle impression, depending on the program. This suits almost all contents relatively well, but provides little brilliance or powerfulness.

Complex: Sounds transform in complex ways as they fade out, with a rich, brilliant impression, depending on the program.

This is extremely effective for the right contents, but is suited for a smaller range of contents.



The sound field to be generated is evaluated according to whether it is nearer to one or the other of the following; Calm: An overall composed, moderate effect, stressing the overall quality of the atmosphere without aiming at any extreme effects. This suits almost all contents relatively well, but provides little showiness or powerfulness.

Powerful: Designed with specific contents in mind (expressing vast spaces, feverish excitement, etc.). This is extremely effective for the right contents, but is suited for a smaller range of contents.

■ For audio music sources



For audio music sources, we also recommend using the Pure Direct mode (page 46), the “STRAIGHT” mode (page 45), or surround decode mode (page 66).

CLASSICAL

CLASSICAL

<p>Hall in Munich</p> <p>This sound field simulates a concert hall with approximately 2500 seats in Munich, using stylish wood for the interior finishing as normal standards for European concert halls. Fine, beautiful reverberations spread richly, creating a calming atmosphere. The listener's virtual seat is at the center left of the arena.</p>	<p>Size Small —————○————— Large</p> <p>V/H balance Vertical —————○————— Horizontal</p> <p>Atmosphere Simple ○————— ————— Complex</p>
---	---

<p>Hall in Vienna</p> <p>This is an approximately 1700-seated, middle-sized concert hall with a shoebox shape that is traditional in Vienna. Pillars and ornate carvings create extremely complex reflections from all around the audience, producing a very full, rich sound.</p>	<p>Size Small —————○————— Large</p> <p>V/H balance Vertical —————○————— Horizontal</p> <p>Atmosphere Simple —————○————— Complex</p>
---	---

Hall in Amsterdam	Size Small <input type="range"/> Large V/H balance Vertical <input type="range"/> Horizontal Atmosphere Simple <input type="range"/> Complex
<p>The large, shoe box shaped hall seats about 2200 around the circle stage. Reflections are rich and pleasing while the sound travels freely.</p>	

Church in Freiburg	Size Small <input type="range"/> Large V/H balance Vertical <input type="range"/> Horizontal Atmosphere Simple <input type="range"/> Complex
<p>Located in the south of Germany, this grand, stone-built church has a pointed tower at 120 meters in height. Its long and narrow shape and the high ceiling enable the elongated reverberation time and limited initial reflection time. Thus, the rich reverberation rather than the sound itself reproduces the atmosphere of the church.</p>	

Chamber	Size Small <input type="range"/> Large V/H balance Vertical <input type="range"/> Horizontal Atmosphere Simple <input type="range"/> Complex
<p>This program creates a relatively wide space with a high ceiling like an audience hall in a palace. It offers pleasant reverberations that are suitable for courtly music and chamber music.</p>	

LIVE/CLUB
2 **LIVE/CLUB**

Village Vanguard	Size Small <input type="range"/> Large V/H balance Vertical <input type="range"/> Horizontal Atmosphere Simple <input type="range"/> Complex
<p>The Jazz club is on 7th Avenue, New York. This small club with the low ceiling makes the powerful reflections converge toward the stage located in the corner.</p>	

Warehouse Loft	Size Small <input type="range"/> Large V/H balance Vertical <input type="range"/> Horizontal Atmosphere Simple <input type="range"/> Complex
<p>The warehouse resembles some lofts in Soho. Sound reflects off the concrete walls clearly with a lot of energy.</p>	

Cellar Club	Size Small <input type="range"/> Large V/H balance Vertical <input type="range"/> Horizontal Atmosphere Simple <input type="range"/> Complex
<p>This program simulates a live house with a low ceiling and homey atmosphere. A realistic, live sound field features powerful sound as if the listener is in a row in front of a small stage.</p>	

The Roxy Theatre	Size Small <input type="range"/> Large V/H balance Vertical <input type="range"/> Horizontal Atmosphere Simple <input type="range"/> Complex
<p>This is the sound field of a rock music live house in Los Angeles, with approximately 460 seats. The listener's virtual seat is at the center left of the hall.</p>	

The Bottom Line	Size Small <input type="range"/> Large V/H balance Vertical <input type="range"/> Horizontal Atmosphere Simple <input type="range"/> Complex
<p>This is the sound field at stage front in The Bottom Line, that was a famous New York jazz club once. The floor can seat 300 people to the left and right in a sound field offering real and vibrant sound.</p>	

■ For various sources

ENTERTAIN
3 ENTERTAIN

Sports	Size Small Large
This program allows the listeners to enjoy stereo sport broadcasts and studio variety programs with enriched live feeling. In sports broadcasts, the voices of the commentator and sportscaster are positioned clearly on the center while the atmosphere of the stadium expands in an optimum space to offer the listeners with a feeling of presence in the stadium.	V/H balance Vertical Horizontal
	F/R balance Front Rear
	Atmosphere Calm Powerful

■ For game programs

ENTERTAIN
3 ENTERTAIN

Action Game	Size Small Large
This sound field is suitable for action games such as car racing and FPS games. It uses the reflection data that limits the effects range per channel in order to offer a powerful playing environment with a being-there feeling by enhancing various effects tones while maintaining a clear sense of directions.	V/H balance Vertical Horizontal
	F/R balance Front Rear
	Atmosphere Calm Powerful

Roleplaying Game	Size Small Large
This sound field is suitable for role-playing and adventure games. It combines the sound field effects for movies and the sound field design used with "Action Game" to represent the depth and spatial feeling of the field during play, while offering movie-like surround effects in the movie scenes in the game.	V/H balance Vertical Horizontal
	F/R balance Front Rear
	Atmosphere Calm Powerful

■ For visual sources of music

ENTERTAIN
3 ENTERTAIN

Music Video	Size Small Large
This sound field offers an image of a concert hall for live performance of pop, rock and jazz music. The listener can indulge oneself in a hot live space thanks to the presence sound field that emphasizes the vividness of vocals and solo play and the beat of rhythm instruments, and to the surround sound field that reproduces the space of a big live hall.	V/H balance Vertical Horizontal
	F/R balance Front Rear
	Atmosphere Calm Powerful

Recital/Opera	Size Small Large
This program controls the amount of reverberations at an optimum level and emphasizes the depth and clarity of human voices. "Recital/Opera" offers the reverberations of an orchestra box in front of the listener at the same time as providing the acoustic positioning and feeling of presence on the stage. The surround sound field is relatively moderate, but the data for concert hall effects are used to represent the inherent beauty of music. The listener will not be fatigued even after long hours of opera entertainment.	V/H balance Vertical Horizontal
	F/R balance Front Rear
	Atmosphere Calm Powerful

■ For movie sources



You can select the desired decoder (page 66) used with following sound field program (except “Mono Movie”).

MOVIE

<p>Standard</p> <p>This program create a sound field emphasizing the surrounding feeling without disturbing the original acoustic positioning of multi-channel audio such as Dolby Digital and DTS. It has been designed with the concept of “an ideal movie theater”, in which the audience is surrounded by beautiful reverberations from the left, right and rear.</p>	<p>Size Small Large</p> <p>V/H balance Vertical Horizontal</p> <p>F/R balance Front Rear</p> <p>Atmosphere Calm Powerful</p>
<p>Spectacle</p> <p>This program represents the spectacular feeling of large-scale movie productions. It reproduces a broad theater sound field matching the cinemascope and wider-screen movies with an excellent dynamic range from very small to extremely large sound.</p>	<p>Size Small Large</p> <p>V/H balance Vertical Horizontal</p> <p>F/R balance Front Rear</p> <p>Atmosphere Calm Powerful</p>
<p>Sci-Fi</p> <p>This program clearly reproduces the finely elaborated sound design of the latest science fiction and special effects-featuring movies. You can enjoy a variety of cinematographically created virtual spaces reproduced with clear separation between dialog, sound effects and background music.</p>	<p>Size Small Large</p> <p>V/H balance Vertical Horizontal</p> <p>F/R balance Front Rear</p> <p>Atmosphere Calm Powerful</p>
<p>Adventure</p> <p>This program is ideal for precisely reproducing the sound design of action and adventure movies. The sound field restrains reverberations but puts emphasis on reproducing a powerful space expanded widely to the left and right. The reproduced depth is also restrained relatively to ensure the separation between audio channels and the clarity of the sound.</p>	<p>Size Small Large</p> <p>V/H balance Vertical Horizontal</p> <p>F/R balance Front Rear</p> <p>Atmosphere Calm Powerful</p>
<p>Drama</p> <p>This sound field features stable reverberations that match a wide range of movie genres from serious dramas to musicals and comedies. The reverberations are modest but offer an optimum spatial feeling, reproducing effects tones and background music softly but cubically around clear words and center positioning in a way that does not fatigue the listener even after long hours of viewing.</p>	<p>Size Small Large</p> <p>V/H balance Vertical Horizontal</p> <p>F/R balance Front Rear</p> <p>Atmosphere Calm Powerful</p>
<p>Mono Movie</p> <p>This program is provided for reproducing monaural video sources such as a classic movie in an atmosphere of a good old movie theater. The program produces the optimum expansion and reverberation to the original audio to create a comfortable space with a certain sound depth.</p>	<p>Size Small Large</p> <p>V/H balance Vertical Horizontal</p> <p>F/R balance Front Rear</p> <p>Atmosphere Calm Powerful</p>

■ Stereo playback

STEREO
5 STEREO

2ch Stereo

Use this program to mix down multi-channel sources to 2 channels.

7ch Stereo

Use this program to output sound from all speakers. When you play back multi-channel sources, this unit downmixes the source to 2 channels, and then output the sound from all speakers. This program creates a larger sound field and is ideal for background music at parties, etc.

■ For compression artifacts (Compressed Music Enhancer mode)

ENHANCER
6 ENHANCER

Straight Enhancer

Use this program to improve the sound enhancer nearest to the original depth and width of the 2-channel or multi-channel compression artifacts.

7ch Enhancer

Use this program to play back compression artifacts in 7-channel stereo.

■ Surround decoder mode

SUR. DECODE
7 SUR. DECODE

Surround Decode

Use this program to play back sources with using the desired surround decoders (page 66).

■ Using sound field programs without surround speakers (Virtual CINEMA DSP)

Virtual CINEMA DSP allows you to enjoy the CINEMA DSP sound field programs without surround speakers. It creates virtual speakers to reproduce the natural sound field.

When you set “SUR. L/R SP” to “NONE” (page 76), Virtual CINEMA DSP activates automatically whenever you select a CINEMA DSP sound field program (page 39).

Note

- Virtual CINEMA DSP does not activate in the following cases:
- “MULTI CH” is selected as the input source (page 36).
 - headphones are connected to the PHONES jack.
 - the unit is in the “7ch Stereo” mode (page 44).

■ Enjoying multi-channel sources and sound field programs with headphones (SILENT CINEMA)

SILENT CINEMA allows you to enjoy multi-channel music or movie sound through ordinary headphones. SILENT CINEMA activates automatically whenever you connect headphones to the PHONES jack while listening to CINEMA DSP sound field programs (page 39). When activated, the SILENT CINEMA indicator lights up in the front panel display.

Note

- SILENT CINEMA does not activate in the following cases:
- “MULTI CH” is selected as the input source (page 36).
 - the unit is in the “2ch Stereo” (page 44), “STRAIGHT” (page 45) or “Pure Direct” (page 46) mode.

Before performing the following operation, set the operation mode selector on the remote control to **AMP**.

Using CINEMA DSP 3D mode

CINEMA DSP 3D mode creates the intensive and accurate stereoscopic sound field in the listening room. You can activate and deactivate the CINEMA DSP 3D mode.

Press **3D DSP repeatedly to turn on or off the CINEMA DSP 3D mode.**

While this unit is in the CINEMA DSP 3D mode, the 3D indicator lights up.

Note

CINEMA DSP 3D does not activate (“3D:--“ appears) in the following cases:

- the “PRESENCE SP” setting is set to “NONE” (page 76).
- no CINEMA DSP is selected.
- headphones are connected to the PHONES jack.

Before performing the following operation, set the operation mode selector on the remote control to **AMP**.

Enjoying unprocessed input sources

When this unit is in the “STRAIGHT” mode, 2-channel stereo sources are output from only the front left and right speakers. Multi-channel sources are decoded straight into the appropriate channels without any additional effect processing.

Press **STRAIGHT (or **STRAIGHT**) to select “STRAIGHT”.**

The names of the audio signal format of the input source and the active decoder appear in the front panel display.

To deactivate the “STRAIGHT” mode

Press **STRAIGHT** (or **STRAIGHT**) again or select another sound field program (page 39).

Using audio features

Before performing the following operation, set the operation mode selector on the remote control to **AMP**.

Enjoying pure hi-fi sound

Use the Pure Direct mode to enjoy the pure fidelity sound of the selected source. When the Pure Direct mode is activated, this unit plays back the selected source with the least circuitry.

Press **M PURE DIRECT** (or **Ⓜ PURE DIRECT**) to turn on or off the Pure Direct mode.

The **M PURE DIRECT** button on the front panel lights up and the front panel display and OSD automatically turns off while this unit is in the Pure Direct mode.

Notes

- The following operations are not possible when this unit is in the Pure Direct mode:
 - switching the sound field program
 - adjusting the “SET MENU” parameters
 - operating video functions (video conversion, etc.)
- The Pure Direct mode is automatically canceled whenever this unit is turned off.



To make this unit output video signals during the Pure Direct mode, configure the “PURE DIRECT” setting (page 80).

Adjusting the tonal quality

Use this feature to adjust the balance of bass and treble for the front L/R and center speaker channels and the subwoofer channel.

1 Press **E TONE CONTROL on the front panel repeatedly to select the high-frequency response (TREBLE) or the low-frequency response (BASS).**

2 Rotate the **N PROGRAM selector to adjust the high-frequency response (TREBLE) or the low-frequency response (BASS).**

Control range: -6.0 dB to +6.0 dB

Notes

- If you increase or decrease the high-frequency or the low-frequency sound to an extreme level, the tonal quality of the surround speakers may not match that of the front L/R and center speakers and the subwoofer.
- TONE CONTROL is not effective when the Pure Direct mode is activated, or when “MULTI CH” is selected as the input source.

Before performing the following operation, set the operation mode selector on the remote control to **AMP**.

Adjusting the speaker level

You can adjust the output level of each speaker while listening to a music source. This is also possible when playing sources input at the MULTI CH INPUT jacks.

Note

This operation will override the level adjustments made in “AUTO SETUP” (page 30) and “LEVEL” (page 76).

1 Press **Ⓜ LEVEL and then **Ⓢ Δ / ▽** repeatedly to select the speaker you want to adjust.**

Display	Adjusted speaker
FRONT L	Front left speaker
CENTER	Center speaker
FRONT R	Front right speaker
SUR. R	Surround right speaker
SB R	Surround back right speaker
SB L	Surround back left speaker
SUR. L	Surround left speaker
SWFR	Subwoofer
PRNS L	Presence left speaker
PRNS R	Presence right speaker



The available speaker channels differ depending on the speaker settings.

2 Press **Ⓢ ◀ / ▶ on the remote control to adjust the speaker output level.**

Control range: -10.0 dB to +10.0 dB

FM/AM tuning

Overview

You can use two tuning modes to tune into the desired FM/AM station:

Frequency tuning mode

You can search or specify the frequency of the desired FM/AM station automatically or manually (see “FM/AM tuning operations” on this page).

Preset tuning mode

You can preset the desired FM/AM station in advance, and then recall the station by specifying the preset group and number (see “Recalling a preset station” on page 49).

Note

Orient the connected FM and AM antennas for the best reception.

Before performing the following operations, set the operation mode selector on the remote control to **⑫SOURCE** and then press **③TUNER**.

FM/AM tuning operations

1 Press **ⓀBAND** (or **⑦BAND**) to select the desired reception band.

2 If the **PRESET** indicator in the front panel lights up, press **①SEARCH MODE** (or **⑩SRCH MODE**) to turn it off.

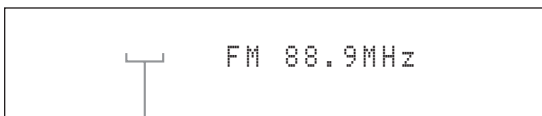

PRESET turns off

3 To search the station automatically, press and hold **ⓄPRESET/TUNING/CH** $\triangleleft/\triangleright$ (or press **⑧PRESET/CH** \triangle/∇) for about 2 seconds. To search the station manually, press **ⓄPRESET/TUNING/CH** $\triangleleft/\triangleright$ repeatedly.

- To tune into a higher frequency, press **Ⓞ▷** (or **⑧△**).
- To tune into a lower frequency, press **Ⓞ◁** (or **⑧▽**).

Note

If the signal from the station you want to select is weak, search the station manually or enter the frequency directly (page 47).



- When this unit is tuned into a station, the **TUNED** indicator lights up.
- To switch the information (current input source, current sound field program, etc) displayed in the front panel display, press **ⓁINFO** (or set the operation mode to **⑮AMP** and then press **⑫INFO**) repeatedly.
- To switch between stereo or monaural FM reception, press **④STEREO/MONO** (or **⑳AUDIO**).
- (U.S.A. model only)

If this unit is tuned into an HD Radio station (page 50), the HD indicator lights up in the front panel display.

Direct frequency tuning

Use this feature tune into the desired station directly by entering the frequency.

1 Follow steps 1 and 2 in “FM/AM tuning operations” (page 47) to select the desired reception band.

2 Enter the frequency of the desired station by pressing the numeric buttons (**⑪**).

Example: To tune into 103.7 MHz



If the entered frequency is out of the range of the FM/AM tuning, “WRONG STATION!” appears in the front panel display.

Before performing the following operations, set the operation mode selector on the remote control to **⑮SOURCE** and then press **③TUNER**.

Preset FM/AM stations

Use this feature to store up to 40 stations FM/AM stations (A1 to E8: 8 preset station numbers in each of the 5 preset station groups). Preset the desired stations to this unit by using the automatic or manual station preset.

Automatic station preset

You can use the automatic preset tuning feature to store up to 40 FM stations with strong signals in order.

(U.S.A. model only)

You can use the automatic preset tuning feature to store up to 40 AM HD Radio, FM HD Radio, and analog FM radio stations with strong signals.

(U.S.A. model only)

1 Press **ⓀBAND** (or **⑦BAND**) to select the desired reception band.

This unit searches the stations in the selected band and then another band.

2 Press and hold **ⓀBAND** (or **⑦BAND**) for more than 3 seconds.

The MEMORY indicator flashes and “AUTO MEMORY” appears in the front panel display. After approximately 5 seconds, automatic presetting starts from the current frequency and proceeds toward higher frequencies.

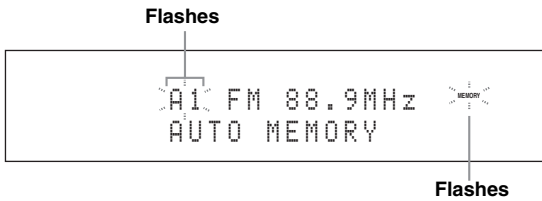

When automatic preset tuning is completed, the MEMORY indicator disappears.



- To specify the preset group and number from which this unit stores stations, press **ⓄPRESET/TUNING/CH** $\triangleleft/\triangleright$ (or **⑧CAT./A-E** $\triangleleft/\triangleright$ and **⑧PRESET/CH** \triangle/∇) repeatedly after you perform step 2.
- To cancel the automatic station preset, press **ⓀBAND** (or **⑦BAND**) again.

Notes

- Any stored station data existing under a preset station number is cleared when you store a new station under the same preset station number.
- If the number of received stations does not reach 40 (E8), automatic preset tuning automatically stops after searching for all the available stations.

- (U.S.A. model only)

When this unit stores the FM HD Radio stations with this feature, this unit stores only the main audio program of the stations (HD1). When you want to store the sub-audio programs of the FM HD Radio stations, preset the stations manually.

Manual station preset

Use this feature to store the FM or AM stations manually.

(U.S.A. model only)

You can store the analog FM/AM radio stations and FM/AM HD Radio stations manually, and you can also store the sub-audio programs of FM HD Radio station.

1 Tune into a station.

See page 47 for tuning instructions.



(U.S.A. model only)

To store a sub-audio program of the HD Radio station (HD2 to HD8), press **ⓄPRG SELECT** $\triangleleft\triangleleft/\triangleright\triangleright$ repeatedly to select the desired audio program (page 50).

2 Press **ⓂMEMORY** (or **⑨MEMORY**).

The PRESET indicator lights up in the front panel and this unit automatically selects an empty preset number.

Lights up

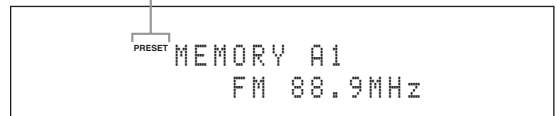

- To store the selected station under an empty preset number automatically, press and hold **ⓂMEMORY** (or **⑨MEMORY**) for more than 2 seconds instead of step 2. In this case, the following steps are unnecessary.
- To cancel the manual station preset, press **ⓂMEMORY** (or **⑨MEMORY**) again.

3 To select the preset group and number (A1 to E8), press **ⓄPRESET/TUNING/CH** $\triangleleft/\triangleright$ (or **⑧CAT./A-E** $\triangleleft/\triangleright$ and **⑧PRESET/CH** \triangle/∇) repeatedly.

- To select a higher preset station group and number, press **Ⓞ** \triangleright (or **⑧** \triangle).
- To select a lower preset station group and number, press **Ⓞ** \triangleleft (or **⑧** ∇).

Preset station group and number

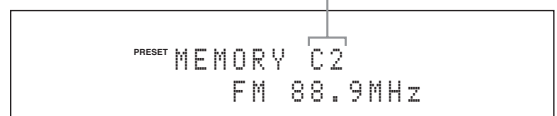



- You can also select a preset number (1 to 8) by pressing the numeric buttons (Ⓜ).
- If you select a preset number being used ("*" appears next to the preset number), the current preset station will be overwritten.

4 Press **ⓂENTER** (or **ⓂENTER**).

The preset station is set and the PRESET indicator disappears.

Note

The reception mode (stereo or monaural) is stored along with the station frequency.

■ Recalling a preset station

- If the PRESET indicator in the front panel turns off, press **ⓂSEARCH MODE** (or **ⓂSRCH MODE**) to turn it on.

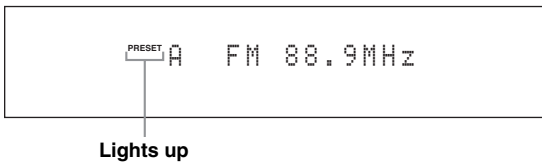

Note

You cannot enter the preset tuning mode if no preset station is set in advance.

- Press **ⓂPRESET/TUNING/CH** \triangleleft / \triangleright (or **ⓂPRESET/CH** \triangle / ∇) repeatedly to select the desired preset station group and number (A1 to E8).

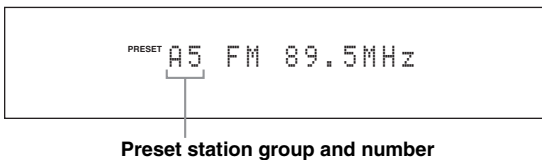

- Empty preset numbers are skipped.
- You can also select a preset station group (A to E) by pressing **ⓂCAT/A-E** \triangleleft / \triangleright and number (1 to 8) by pressing the numeric buttons (Ⓜ),

Note

- (U.S.A. model only)
When you recall one of the sub-audio program (HD2 to HD8) of an FM HD Radio station, it takes a few seconds for this unit to recall the desired program. While this unit recalls the sub-audio program, this unit outputs the sound of the analog service of the station.

- (U.S.A. model only)

If the selected sub-audio program is currently not available, this unit is tuned into the main audio program, and if the main audio program is also not available, this unit is tuned into the analog service.

■ Clearing preset stations

You can clear the assignments of preset stations.

- Select the preset station you want to clear.
For details, see "Recalling a preset station" (page 49).
- Press and hold **ⓂSEARCH MODE** (or **ⓂSRCH MODE**) until "CLEAR?" appears in the front panel display.

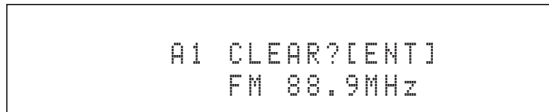

- Press **ⓂENTER** (or **ⓂENTER**) to clear the preset station.



To cancel the operation, press **ⓂSEARCH MODE** (or **ⓂSRCH MODE**) again.

Using HD Radio™ features (U.S.A. model only)

HD Radio technology is a new technology that enables FM and AM radio stations to broadcast programs digitally. Digital broadcasting provides listeners with radically improved audio quality and reception as well as new data services. Furthermore, supplemental program services allow listeners to select from up to 8 HD Radio programs multicast on a single FM HD Radio channel. For further information on HD Radio technology, visit “<http://www.iberiquity.com/>”. This unit is equipped with an HD Radio reception feature, facilitating CD quality FM broadcasts as well as analog FM stereo quality AM broadcasts. In addition, this unit can receive both audio and data (such as song titles, artist names, program types, and comments) from supplemental program services (HD1 to HD8).

Notes

- The tuning method for HD Radio stations are same as analog FM/AM radio stations; however, you cannot tune into a hybrid HD Radio station while this unit is in the monaural tuning mode (page 47).
- This unit is capable of receiving both hybrid and all-digital HD Radio station signals. However, this unit may not automatically receive all-digital FM station signals and the automatic tuning operation may stop. In this case, enter the frequency of the desired all-digital FM HD Radio station directly by using the numeric buttons (Ⓜ) (page 47).

Before performing the following operations, set the operation mode selector on the remote control to **⑤SOURCE** and then press **③TUNER**.

Selecting HD Radio™ audio programs

Use this feature to select one of the 8 HD Radio audio programs (HD1 to HD8) when the unit is in the tuner mode. Each audio program contains data programs. When the selected FM HD Radio station provides some audio programs, currently selected audio program number appears in the front panel display as follows.

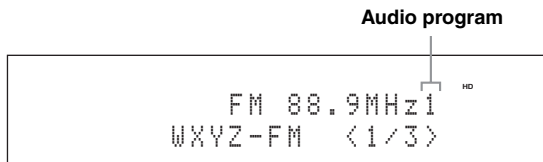

Press **⑩PRG SELECT** **◀◀ / ▶▶** on the remote control repeatedly to toggle between HD Radio audio programs.



You can also select the desired HD Radio audio program by pressing the numeric key. While this unit is in the automatic or manual tuning mode, press a numeric button (1-8) (Ⓜ) and then **③ENT**.

Notes

- Only 1 HD Radio audio program (HD1) is available for AM broadcasts, while up to 8 audio programs (HD1 to HD8) are available for FM broadcasts. The audio programs from HD2 to HD8 can be selected only when they contain data programs.
- When reception for an audio program ceases, the HD indicator disappears from the front panel display and HD1 is automatically selected after approximately 20 seconds.
- Some audio programs may not contain data programs depending on the broadcasting station and the time period.
- For the best reception, adjust the orientation of the antenna so that “|||.” or “|||” is displayed.

Displaying HD Radio™ information

Use this feature to display the HD Radio information in the front panel display or in the OSD.



- You can configure the display settings with "DISPLAY SET" (page 83).
- To hold or release the displayed information, set the operation mode selector to **SOURCE** and then press **ENTER**. While it is held, the HOLD indicator flashes in the front panel.

Front panel display

Press **INFO** (or set the operation mode selector to **AMP** and then press **INFO**) repeatedly to toggle between the following HD Radio information displays.

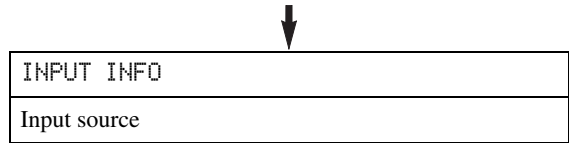
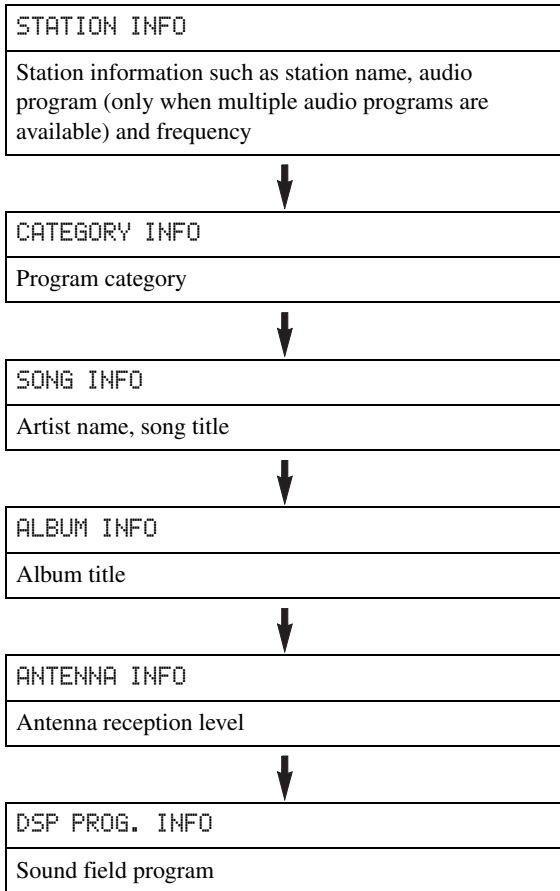

Back to "STATION INFO"

Video monitor (OSD)

Set the operation mode selector to **SOURCE** and then press **DISPLAY** on the remote control to turn on or off the information display. The following information is displayed in the OSD.



- [1] Preset station group and number, frequency, audio program (only when multiple audio programs are available)
- [2] Program category
- [3] Song title
- [4] Album title
- [5] Antenna reception level
- [6] Stereo/mono
- [7] Station name, audio program (only when multiple audio programs are available)
- [8] Artist name

XM[®] Satellite Radio tuning

XM Satellite Radio offers an extraordinary variety of commercial-free music, plus the best in sports, news, talk and entertainment. XM is broadcast in superior digital audio from coast to coast. From rock to reggae, from classical to hip hop, XM has something for every music fan.

XM Satellite Radio online information

For U.S. customers: <http://www.xmradio.com/>

For Canadian customers: <http://www.xmradio.ca/>

Note

The XM Satellite Radio service is only available in the 48 contiguous United States (not available in Alaska and Hawaii) and Canada.

XM READY legal disclaimer

XM monthly service subscription sold separately. XM Mini-Tuner and Home Dock required (each sold separately) to receive XM service. It is prohibited to copy, decompile, disassemble, reverse engineer, hack, manipulate or otherwise make available any technology or software incorporated in receivers compatible with the XM Satellite Radio System. Installation costs and other fees and taxes, including a one-time activation fee may apply. All fees and programming subject to change. Channels with frequent explicit language are indicated with an XL. Channel blocking is available for XM radio receivers by calling 1-800-XMRADIO (U.S. residents) and 1-877-GETXMSR (Canadian residents). XM service only available in the 48 contiguous United States and Canada. ©2008 XM Satellite Radio Inc. All rights reserved.

■ Enjoying XM HD Surround content

This unit is equipped with the NRL-THX and NRL-THX Music decoders that play back the XM HD surround sound content of the XM Satellite Radio broadcasts in multi-channels, resulting in a full surround sound experience (page 66).

Connecting XM Mini-Tuner Home Dock

Connect XM Mini-Tuner and XM Mini-Tuner Home Dock (sold separately) to the XM jack on the rear panel of this unit. For details, see the operating instructions provided with the XM Mini-Tuner Home Dock.

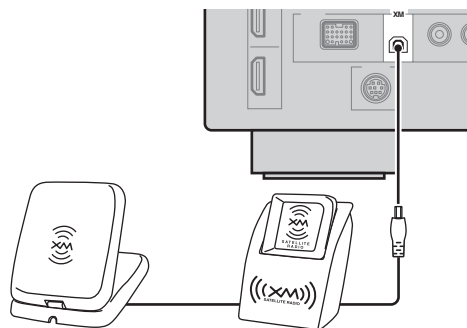

XM Mini-Tuner and XM Mini-Tuner Home Dock
(sold separately)



To ensure optimal reception of the XM Satellite Radio signals, the XM Mini-Tuner Home Dock must be placed at or near a southerly facing window with no obstacles in the path to the sky. You can mount it indoors or outdoors. Use the “ANTENNA INFO” information in the front panel or “XM Information” screen in the video monitor (page 56) to check the antenna reception level and adjust the orientation of the antenna.

Note

If “CHECK ANTENNA” or “CHECK XM TUNER” appears in the front panel display, the connection and setting of the antenna, XM Mini-Tuner Home Dock, or XM Mini-Tuner may not be correct.

Activating XM Satellite Radio

Once you have installed the XM Mini-Tuner Home Dock, inserted the XM Mini-Tuner, connected the XM Mini-Tuner Home Dock to your XM Ready® home audio system, and installed the antenna, you are ready to subscribe and begin receiving XM programming. There are three places to find your eight character XM Radio ID: On the XM Mini-Tuner, on the XM Mini-Tuner package, and on XM Channel 0. Record the XM Radio ID in the following eight squares for reference.



Note

The XM Radio ID does not use the letters “I”, “O”, “S” or “F”. Activate your XM Satellite Radio service in the U.S. online at <http://activate.xmradio.com/> or call 1-800-XM-RADIO (1-800-967-2346). Activate your XM Satellite Radio service in Canada online at <https://activate.xmradio.ca/> or call 1-877-GET-XMSR (1-877-438-9677). You will need a major credit card. XM will send a signal from the satellites to activate the full channel lineup. Activation normally takes 10 to 15 minutes, but during peak busy periods you may need to keep your XM Ready home audio system on for up to an hour. When you can access the full lineup on your XM Ready home audio system you are done.

Before performing the following operations, set the operation mode selector on the remote control to **⑮SOURCE**.

XM Satellite Radio operations

1 Rotate the **ⓈINPUT** selector (or press **③XM**) to select “XM” as the input source.

The cursor on the left of the XM indicator lights up in the front panel display and the XM Satellite Radio information (such as channel number, channel name, category, artist name, or song title) for the currently selected channel appears in the front panel display.

Lights up



When you select “XM” as the input source, this unit automatically recalls the previously selected channel.

Notes

- The XM Satellite Radio signals cannot be output at the analog AUDIO OUT jacks.
- If a status message or an error message appears in the front panel display or in the OSD, see “XM Satellite Radio” (page 109)

2 Search for a channel by using one of the XM Satellite Radio search modes.

- To select a channel from the all channel list, see “All Channel Search mode” (page 53).
- To select a channel by category, see “Category Search mode” (page 54).
- To select a channel from the preset channels, see “Preset Search mode” (page 54).
- To select the desired channel directly by entering the channel number, see “Direct number access mode” (page 54).



- You can use the Neural Surround decoder to enjoy the XM HD surround sound content of the XM Satellite Radio broadcasts in multi-channels (page 66).
- You can set the XM Satellite Radio preset channels (page 55).
- You can display the XM Satellite Radio information in the front panel display or in the OSD (page 56).

■ All Channel Search mode

1 Press **①SEARCH MODE** (or **⑱SRCH MODE**) repeatedly to select “ALL CH SEARCH”.

- 2 Press **ⓐ PRESET/TUNING/CH** $\triangleleft/\triangleright$ (or **ⓑ PRESET/CH** \triangle/∇) repeatedly to search for a channel within all channels.



You can search for a channel quickly by pressing and holding **ⓐ PRESET/TUNING/CH** $\triangleleft/\triangleright$ (or **ⓑ PRESET/CH** \triangle/∇).

■ Category Search mode

- 1 Press **ⓐ SEARCH MODE** (or **ⓑ SRCH MODE**) repeatedly to select “CAT SEARCH”.

- 2 Press **ⓐ CATEGORY** (or **ⓑ A-E/CAT.** $\triangleleft/\triangleright$) repeatedly to change the channel category.

- 3 Press **ⓐ PRESET/TUNING/CH** $\triangleleft/\triangleright$ (or **ⓑ PRESET/CH** \triangle/∇) repeatedly to search for a channel within the selected channel category.



You can search for a channel quickly by pressing and holding **ⓐ PRESET/TUNING/CH** $\triangleleft/\triangleright$ (or **ⓑ PRESET/CH** \triangle/∇).

■ Preset Search mode

Prior to selecting a preset channel in the Preset Search mode, you must preset XM Satellite Radio channels. For details, see “Setting the XM Satellite Radio preset channels” (page 55).

- 1 Press **ⓐ SEARCH MODE** (or **ⓑ SRCH MODE**) repeatedly to select “PRESET SEARCH”.

- 2 Press **ⓐ CATEGORY** (or **ⓑ A-E/CAT.** $\triangleleft/\triangleright$) repeatedly to change the preset channel group (A to E).

- 3 Press **ⓐ PRESET/TUNING/CH** $\triangleleft/\triangleright$ (or **ⓑ PRESET/CH** \triangle/∇) repeatedly to change the preset channel number (1 to 8).



You can also select the preset channel number directly by pressing the numeric buttons (1 to 8) (**ⓐ**).

■ Direct number access mode

- 1 Press **ⓑ SRCH MODE** on the remote control repeatedly to select “ALL CH SEARCH” or “CAT SEARCH”.

- 2 Press the numeric buttons (**ⓐ**) to enter the desired three-digit channel number.

For example, to enter the number 123, press the numeric buttons (**ⓐ**) as shown below.

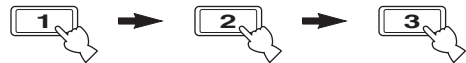

- To display the XM Radio ID number in the front panel display, select channel “0”.
- To enter a one-digit or two-digit channel number, press the numeric buttons (**ⓐ**) on the remote control and then press **ⓑ ENT** to confirm the input number.
- Instead of pressing **ⓑ ENT** to tune into the channel immediately, you can wait a few seconds until this unit confirms the entered channel number.
- Pressing a button other than the numeric buttons (**ⓐ**) or **ⓑ ENT** cancels the Direct Number Access mode procedure.

Before performing the following operations, set the operation mode selector on the remote control to **SOURCE** and then press **XM**.

Setting the XM Satellite Radio preset channels

You can use this feature to store up to 40 XM Satellite Radio channels (A1 to E8: 8 preset channel numbers in each of the 5 preset channel groups). You can then recall any preset channel easily by selecting the preset channel group and number as described in “Preset Search mode” (page 54).

1 Search for a channel you want to set as a preset channel by using one of the XM Satellite Radio search modes.

For details, see “XM Satellite Radio operations” (page 53).

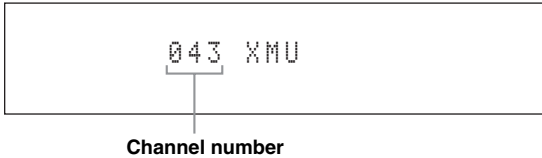

2 Press **MEMORY** (or **MEMORY**).

The PRESET indicator lights up in the front panel and this unit automatically selects an empty preset number.

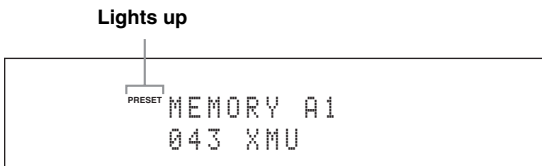

- To store the selected channel under an empty preset number automatically, press and hold **MEMORY** (or **MEMORY**) for more than 2 seconds instead of step 2. In this case, the following steps are unnecessary.
- To cancel the preset operation, press **MEMORY** (or **MEMORY**) again.

3 To select the preset channel group and number (A1 to E8), press **PRESET/TUNING/CH** $\triangleleft/\triangleright$ (or **CAT/A-E** $\triangleleft/\triangleright$ and **PRESET/CH** \triangle/∇) repeatedly.

- To select a higher preset channel group and number, press **PRESET/TUNING/CH** \triangleright (or **CAT/A-E** \triangleright).
- To select a lower preset channel group and number, press **PRESET/TUNING/CH** \triangleleft (or **CAT/A-E** \triangleleft).



- You can also select a preset number (1 to 8) by pressing the numeric buttons (1-8).
- If you select a preset number being used (“*” appears next to the preset number), the current preset channel will be overwritten.

4 Press **ENTER** (or **ENTER**).

The preset channel is set and the PRESET indicator disappears.

Clearing preset channels

You can clear the assignments of preset XM Satellite Radio channels.

1 Select the preset XM Satellite Radio channel to clear.

For details, see “Preset Search mode” (page 54).

2 Press and hold **SEARCH MODE** (or **SRCH MODE**) until “CLEAR?” appears in the front panel display.

3 Press **ENTER** (or **ENTER**) to clear the preset channel.

To cancel the operation, press **SEARCH MODE** (or **SRCH MODE**).

Before performing the following operations, set the operation mode selector on the remote control to **⑮SOURCE** and then press **③XM**.

Displaying the XM Satellite Radio information

Use this feature to display the XM Satellite Radio information in the front panel display or in the OSD.



- You can configure the display settings with “DISPLAY SET” (page 83).
- You can hold or release the displayed information by pressing **⑧ENTER**. While it is held, the HOLD indicator flashes in the front panel.

Notes

- If a status message or an error message appears in the front panel display or video monitor, see “XM Satellite Radio” (page 109).
- The current XM Satellite Radio reception level appears on the top of the XM Satellite Radio information screen. For the best reception, adjust the orientation of the antenna of Home Dock so that “|||” or “||||” is displayed here. “....” is displayed if the antenna cannot receive the signals correctly. In this case, adjust the orientation of the antenna (page 52).

■ Front panel display

Press **①INFO** (or set the operation mode selector to **⑮AMP** and then press **⑫INFO**) repeatedly to toggle between the following XM Satellite Radio information display modes.

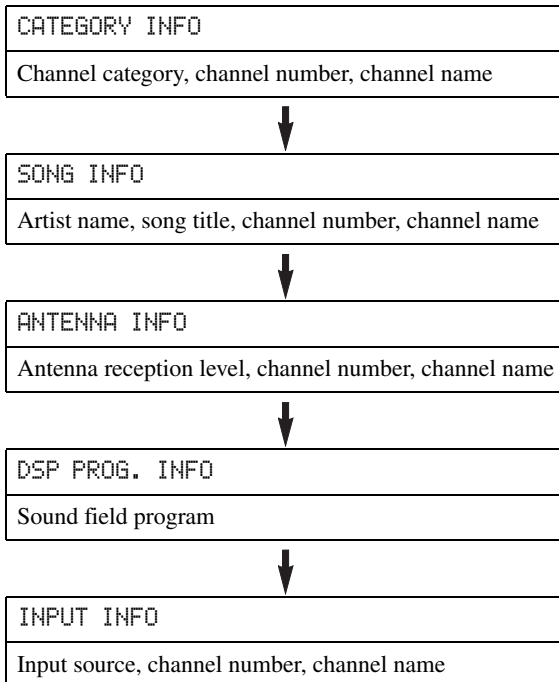

Back to “CATEGORY INFO”



- If the XM Satellite Radio information contains a character that cannot be recognized by this unit, the character will be displayed with a space.
- When the antenna of the XM Mini-Tuner Home Dock cannot receive the signals, “NO SIGNAL” appears in the front panel display.

■ Video monitor (OSD)

Press **ⓂDISPLAY** on the remote control to turn on or off the information display.

The following information is displayed in the OSD.

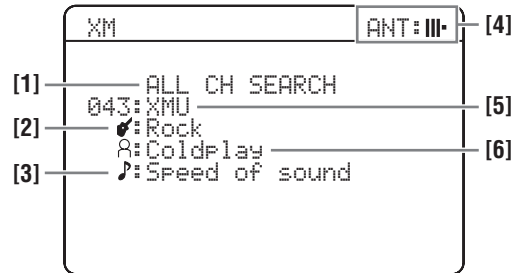

[1] Search mode (page 53)

[2] Channel category

[3] Song title

[4] Antenna reception level

[5] Channel number, channel name

[6] Artist name

SIRIUS Satellite Radio™ tuning

SIRIUS Satellite Radio provides over 130 channels of exclusive entertainment and 100% commercial-free music. Only SIRIUS has more than 65 original music channels, from today's hits to R&B, oldies, and classical masterpieces. From authentic country and real bluegrass to cool jazz, hot latin, reggae, rock and many more. Best of all, it's all 100% commercial-free.

SIRIUS also has more than 55 channels of world-class sports, news and entertainment. Included as part of your subscription, you get up to 16 NFL games a week, up to 40 NBA games a week and up to 40 NHL games a week. (Games are broadcast during their respective seasons.)

Coupled with great sports news from ESPN, the SIRIUS sports offering is unrivaled. And don't forget a host of other great news and entertainment, like NPR, CNBC, Fox News, Radio Disney and E! Entertainment Radio. For more information, visit <http://www.sirius.com/>.

SIRIUS Satellite Radio legal disclaimer

SIRIUS is available in the U.S.A. for subscribers with addresses in the continental U.S.A. and is available in Canada for subscribers with a Canadian address. To Get SIRIUS Satellite Radio a subscription and compatible tuner and antenna are required and sold separately. Visit sirius.com for the most complete and up-to-date channel lineup and information. "SIRIUS" and the SIRIUS dog logo and related marks are trademarks of SIRIUS Satellite Radio Inc.

Connecting the SiriusConnect™ tuner

Connect the SiriusConnect tuner (sold separately) to the SIRIUS jack on the rear panel of this unit. For details, see the operating instructions provided with the SiriusConnect tuner.

SiriusConnect™ tuner and the antenna
(sold separately)

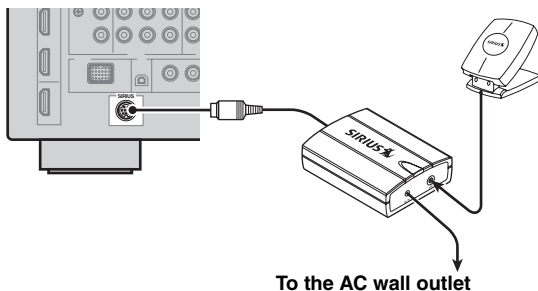

- To ensure optimal reception of the SIRIUS Satellite Radio signals, the antenna of the SiriusConnect tuner must be placed at or near a window with no obstacles in the path to the sky. The orientation of the antenna for the best reception differs depending on the area. Refer to the instruction manuals supplied with the SiriusConnect tuner for the installation of the antenna. You can mount it indoors or outdoors.
- Use the "ANTENNA INFO" information in the front panel or "SIRIUS Information" screen in the video monitor (page 62) to check the antenna reception level and adjust the orientation of the antenna.
- You need to connect the SiriusConnect tuner to the AC wall outlet.

Notes

- If "CHECK SR TUNER" or "ANTENNA ERROR" appears in the front panel display, the connection of the SiriusConnect tuner or antenna is incorrect. In such cases, check the connection of the SiriusConnect tuner and the antenna.
- If "NOT SUPPORTED" appears in the front panel display, this unit does not support the connected SiriusConnect tuner.

Activating SIRIUS Satellite Radio™ subscription

Before using the SIRIUS Satellite Radio feature, you need to activate your SIRIUS Satellite Radio subscription. To activate the subscription you need the Sirius ID which is uniquely assigned to the SiriusConnect tuner. Sirius ID is 12-digit number and it appears on the package of the SiriusConnect tuner, on the label of the SiriusConnect tuner, and when you tune into the SIRIUS Satellite Radio channel “0” (see below).

■ Displaying the Sirius ID of your SiriusConnect tuner

1 Set the operation mode selector on the remote control to **15 SOURCE** and then press **3 SIRIUS**.

2 Press **11 0** and then **20 ENT** to display the Sirius ID of your SiriusConnect tuner.

“000 Sirius IDxxxxxxxxxx” (“xxxxxxxxxxxxx” indicates the 12-digit Sirius ID of your SiriusConnect tuner) appears in the front panel display.

Write the Sirius ID below.

ID: _____

3 Contact SIRIUS Satellite Radio to activate your subscription.

SIRIUS Satellite Radio online information

Contact for activation

URL: <https://activate.siriusradio.com/>

Phone: 1-888-539-SIRIUS (1-888-539-7474)



Status messages appear in the front panel display or OSD during the activation. For details, see “SIRIUS Satellite Radio” (page 110). Once the activation is finished, “SUB UPDATED” appears.

Before performing the following operations, set the operation mode selector on the remote control to **15 SOURCE**.

SIRIUS Satellite Radio™ operations

1 Rotate the **20 INPUT** selector (or press **3 SIRIUS**) to select “SIRIUS” as the input source.

The cursor on the left of the SIRIUS indicator lights up in the front panel display and the SIRIUS Satellite Radio information (such as channel number, channel name, category, artist name, or song title) for the currently selected channel appears in the front panel display.

Lights up

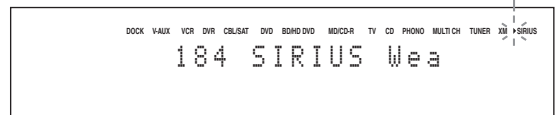

When you select “SIRIUS” as the input source, this unit automatically recalls the previously selected channel.

Notes

- The SIRIUS Satellite Radio signals cannot be output at the analog AUDIO OUT jacks.
- When you have not activated your subscription yet, you can only select “184” or “000”.
- If a status message or an error message appears in the front panel display or in the OSD, see “SIRIUS Satellite Radio” (page 110).

2 Search for a channel by using one of the SIRIUS Satellite Radio search modes.

- To select a channel from the all channel list, see “All Channel Search mode” (page 59).
- To select a channel by category, see “Category Search mode” (page 59).
- To select a channel from the preset channels, see “Preset Search mode” (page 59).
- To select the desired channel directly by entering the channel number, see “Direct number access mode” (page 59).



- If you tune into a channel that you do not subscribe, “CALL 888-539-SIRIUS TO SUBSCRIBE” appears in the front panel display.
- You can set the SIRIUS Satellite Radio preset channels (page 60).
- You can display the SIRIUS Satellite Radio information in the front panel display or in the video monitor (page 62).

■ All Channel Search mode

1 Press **①SEARCH MODE** (or **⑱SRCH MODE**) repeatedly to select “ALL CH SEARCH”.

2 Press **ⓄPRESET/TUNING/CH** $\triangleleft/\triangleright$ (or **⑧PRESET/CH** \triangle/∇) repeatedly to search for a channel within all channels.



- You can search for a channel quickly by pressing and holding **ⓄPRESET/TUNING/CH** $\triangleleft/\triangleright$ (or **⑧PRESET/CH** \triangle/∇).
- You can skip channels to the previous or next category by pressing **ⓀCATEGORY** (or **⑧A-E/CAT.** $\triangleleft/\triangleright$).

■ Category Search mode

1 Press **①SEARCH MODE** (or **⑱SRCH MODE**) repeatedly to select “CAT SEARCH”.

2 Press **ⓀCATEGORY** (or **⑧A-E/CAT.** $\triangleleft/\triangleright$) repeatedly to change the channel category.

3 Press **ⓄPRESET/TUNING/CH** $\triangleleft/\triangleright$ (or **⑧PRESET/CH** \triangle/∇) repeatedly to search for a channel within the selected channel category.



You can search for a channel quickly by pressing and holding **ⓄPRESET/TUNING/CH** $\triangleleft/\triangleright$ (or **⑧PRESET/CH** \triangle/∇).

Note

This unit skips the channels when this unit is in the All Channel Search mode or Category Search mode in the following cases (it is not malfunction of this unit):

- the channel is locked (page 61).
- the channel is out of service.
- you do not subscribe to the channel.

■ Preset Search mode

Prior to selecting a preset channel in the Preset Search mode, you must preset SIRIUS channels. For details, see “Setting the SIRIUS Satellite Radio™ preset channels” (page 60).

1 Press **①SEARCH MODE** (or **⑱SRCH MODE**) repeatedly to select “PRESET SEARCH”.

2 Press **ⓀCATEGORY** (or **⑧A-E/CAT.** $\triangleleft/\triangleright$) repeatedly to change the preset channel group (A to E).

3 Press **ⓄPRESET/TUNING/CH** $\triangleleft/\triangleright$ (or **⑧PRESET/CH** \triangle/∇) repeatedly to change the preset channel number (1 to 8).



You can also select the preset channel number directly by pressing the numeric buttons (1 to 8) **(⑪)**.

■ Direct number access mode

1 Press **⑱SRCH MODE** on the remote control repeatedly to select “ALL CH SEARCH” or “CAT SEARCH”.

2 Press the numeric buttons **(⑪)** to enter the desired three-digit channel number.

For example, to enter the number 123, press the numeric buttons **(⑪)** as shown below.

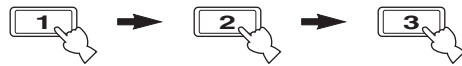

- To display the Sirius ID number displayed in the front panel display, select channel “0”.
- To enter a one-digit or two-digit channel number, press the numeric buttons **(⑪)** on the remote control and then press **ⓄENT** to confirm the input number.
- Instead of pressing **ⓄENT** to tune into the channel immediately, you can wait a few seconds until this unit confirms the entered channel number.
- If no button is pressed within a few seconds after you enter a one-digit or two-digit number, this unit automatically confirms the entered channel number.
- If the selected channel is locked, “PIN:___” appears in the front panel display. Enter the four-digit Parental Lock code number by using the numeric buttons **(⑪)** or press **ⓄENT** to cancel (page 61).

Before performing the following operations, set the operation mode selector on the remote control to **SOURCE** and then press **SIRIUS**.

Setting the SIRIUS Satellite Radio™ preset channels

You can use this feature to store up to 40 SIRIUS Satellite Radio channels (A1 to E8: 8 preset channel numbers in each of the 5 preset channel groups). You can then recall any preset channel easily by selecting the preset channel group and number as described in “Preset Search mode” (page 54).

1 Search for a channel you want to set as a preset channel by using one of the SIRIUS Satellite Radio search modes.

For details, see “SIRIUS Satellite Radio™ operations” (page 58).

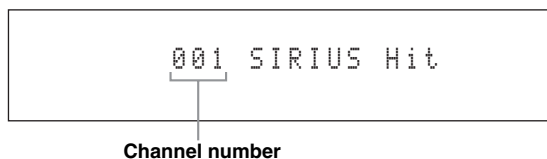

2 Press **MEMORY** (or **MEMORY**).

The PRESET indicator lights up in the front panel and this unit automatically selects an empty preset number.

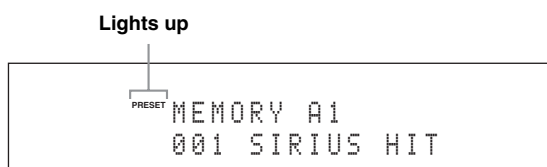

- To store the selected channel under an empty preset number automatically, press and hold **MEMORY** (or **MEMORY**) for more than 2 seconds instead of step 2. In this case, the following steps are unnecessary.
- To cancel the preset operation, press **MEMORY** (or **MEMORY**) again.

3 To select the preset channel group and number (A1 to E8), press **PRESET/TUNING/CH** $\triangleleft/\triangleright$ (or **CAT./A-E** $\triangleleft/\triangleright$) and **PRESET/CH** \triangle/∇) repeatedly.

- To select a higher preset channel group and number, press \triangleright (or \triangle).
- To select a lower preset channel group and number, press \triangleleft (or ∇).



- You can also select a preset number (1 to 8) by pressing the numeric buttons (1).
- If you select a preset number being used (“*” appears next to the preset number), the current preset channel will be overwritten.

4 Press **ENTER** (or **ENTER**).

The preset channel is set and the PRESET indicator disappears.

Clearing preset channels

You can clear the assignments of preset SIRIUS Satellite Radio channels.

1 Select the preset SIRIUS Satellite Radio channel to clear.

For details, see “Preset Search mode” (page 59).

2 Press and hold **SEARCH MODE** (or **SRCH MODE**) until “CLEAR?” appears in the front panel display.

3 Press **ENTER** (or **ENTER**) to clear the preset channel.

To cancel the operation, press **SEARCH MODE** (or **SRCH MODE**).

Before performing the following operations, set the operation mode selector on the remote control to **SOURCE** and then press **SIRIUS**.

Setting the Parental Lock

You can use the Parental Lock feature to limit the access to the desired SIRIUS Satellite channels. This unit automatically skips the locked channels when this unit is in the All Channel Search mode or Category Search mode and you search a channel by pressing **PRESET/TUNING/CH** $\triangleleft/\triangleright$ (or **PRESET/CH** \triangle/∇).

Setting the code number and the locking channels

Use this feature to set the Parental Lock code number (PIN) and select the channels to be locked.

1 Press **BAND**.

The "PARENTAL LOCK" screen appears.

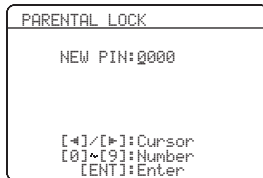

Note

If a SiriusConnect tuner is not connected to this unit, "Check Sirius Tuner" appears.



If the Parental Lock code number is already set, "PIN:___" appears instead of "NEW PIN:0000". Refer to step 4 and then proceed the operations.

2 Enter the desired 4-digit code number by using the numeric buttons (0-9).

3 Press **ENTER** to confirm the code number.

"OK" and then the SIRIUS Satellite Radio channel list appears. Refer to the step 5 and then proceed the operations.

4 Enter the 4-digit code number you set in step 2 above to unlock the protection.

When the code number is correct, "OK" and then the SIRIUS Satellite Radio channel list appears.

5 Press **◀/▶** repeatedly to select the desired channel category and then press **▲/▼** repeatedly to select the channel you want to lock.

Note

In the SIRIUS Satellite Radio channel list screen, this unit outputs the sound of the selected channel even if the channel is locked.

6 Press **ENTER** to lock the selected channel.

Check mark appears before the locked channel.



When you select the locked channel and press **ENTER**, this unit unlocks the selected channel.

7 Repeat steps 5 and 6 to lock the channels you want.

8 Press **BAND** to exit from the "PARENTAL LOCK" screen.

This unit is tuned into the last channel you select in the "PARENTAL LOCK" screen. If the channel is locked, this unit is tuned into "184 SIRIUS Weather & Emergency" or "000 Sirius ID".



- If you forget or want to change the Parental lock code number, use "SIRIUS PIN" (page 103) to reset the Parental Lock code number.
- Selecting "ALL" in "INITIALIZE" (page 103) will cancel all parental locks.

Tuning into the locked channels

You can tune into the locked channels by the Direct number access mode or preset tuning mode. When you tune into the locked channel, following message appears in the front panel display. Enter the code number you set for the Parental Lock feature by using the numeric buttons (0-9) or press **ENT** to cancel the tuning.

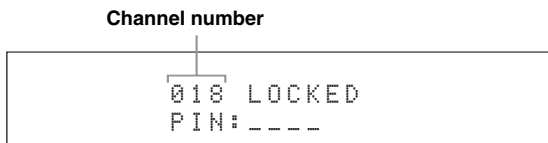

Notes

- If the entered code number is incorrect, "Wrong" appears in the front panel display and this unit is tuned into the previously selected channel.
- If a channel is unlocked, you can also select the channel in Zone 2 and Zone 3.

Before performing the following operations, set the operation mode selector on the remote control to **⑮SOURCE** and then press **③SIRIUS**.

Displaying the SIRIUS Satellite Radio™ information

Use this feature to display the SIRIUS Satellite Radio information in the front panel display or in the OSD.



- You can configure the display settings with “DISPLAY SET” (page 83).
- You can hold or release the displayed information by pressing **⑧ENTER**. While it is held, the HOLD indicator flashes in the front panel.

Note

If a status message or an error message appears in the front panel display or video monitor, see “SIRIUS Satellite Radio” (page 110).

■ Front panel display

Press **ⓁINFO** (or set the operation mode selector to **⑮AMP** and then press **⑫INFO**) repeatedly to toggle between the following SIRIUS Satellite Radio information display modes.

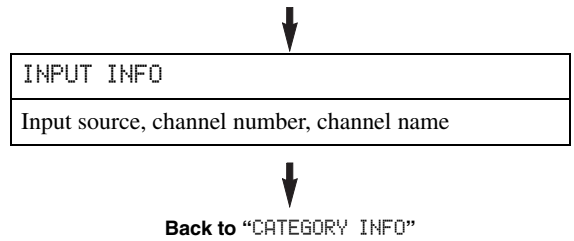
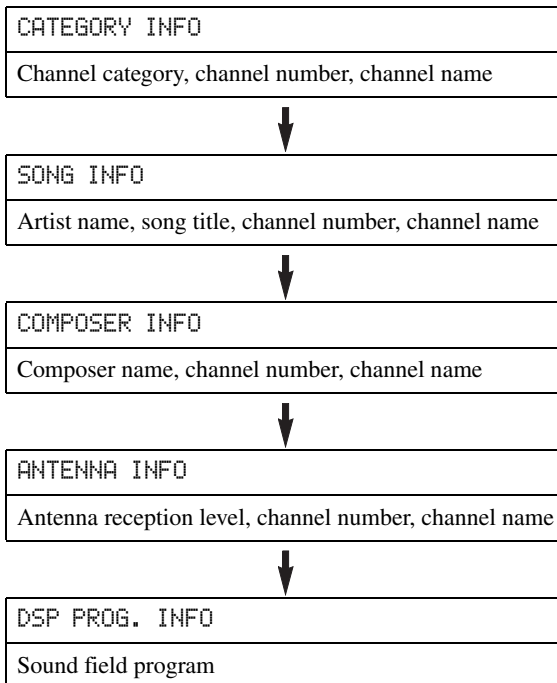

- If the SIRIUS Satellite Radio information contains a character that cannot be recognized by this unit, the character will be displayed with a space.
- When the antenna of the SiriusConnect tuner cannot receive the signals, “ACQUIRING” appears in the front panel display.
- When an information is unavailable, “----” appears.

■ Video monitor (OSD)

Press **ⓂDISPLAY** on the remote control to turn on or off the information display.

The following information is displayed in the OSD.



- [1] Search mode (page 58)
- [2] Channel category
- [3] Song title
- [4] Composer name
- [5] Antenna reception level
- [6] Channel number/name
- [7] Artist name

Using iPod™

Once you have stationed your iPod in a Yamaha iPod universal dock (such as YDS-11, sold separately) connected to the DOCK terminal of this unit (page 23), you can enjoy playback of your iPod using the supplied remote control. You can also use the Compressed Music Enhancer mode of this unit to enhance the sound quality of the compression artifacts (such as the MP3 format) stored on your iPod (page 44).

Notes

- This unit supports iPod touch, iPod (Click Wheel, including iPod classic), iPod nano and iPod mini.
- Some features may not be compatible depending on the model or the software version of your iPod.
- Some features may not be compatible depending on the model of your Yamaha iPod universal dock. The following description is based on using YDS-11.



- Once the connection between your iPod and this unit is complete, “iPod connected” appears in the front panel display.
- For details about status messages displayed in the front panel display and in the OSD, see “iPod” (page 112).
- You can select whether or not this unit charges the battery of the stationed iPod when this unit is in the standby mode by configuring the “STANDBY CHARGE” setting (page 82).

Before performing the following operations, set the operation mode selector on the remote control to **SOURCE** and then press **DOCK**.

Controlling iPod™

You can control your iPod when “DOCK” is selected as the input source. The operations of your iPod can be done with the aid of the OSD of this unit (menu browse mode) or without it (simple remote mode).

Remote control operation

Button	Function
ENTER	Subsequent menu
△	Menu up
▽	Menu down
◀	Previous menu
▶	Subsequent menu
⏮	Search backward (Press and hold)
⏭	Search forward (Press and hold)
⏩	Skip forward
⏪	Skip backward
□	Stop
⏸	Pause (Menu browse mode) Play/Pause (Simple remote mode)
▶	Play (Menu browse mode) Play/Pause (Simple remote mode)
DISPLAY	Display

Controlling iPod in the simple remote mode

You can perform the basic operations of your iPod (play, stop, skip, etc.) using the supplied remote control without the aid of the OSD of this unit.



Operations can be also done with the controls on your iPod.

Controlling iPod in the menu browse mode

You can perform the advanced operations of your iPod using the supplied remote control with the aid of the OSD of this unit.

You can also browse the songs and videos stored on your iPod in the OSD.

Further, you can change or adjust settings for your iPod to suit your personal preferences.



You can configure the display settings with “DISPLAY SET” (page 83).

Notes

- Operations cannot be done with the controls on your iPod.
- There are some characters that cannot be displayed in the front panel display or in the OSD of this unit. Those characters are replaced with underscores “_”.

1 Press **DISPLAY** on the remote control.

The following display appears in the OSD.



2 Press **Ⓢ** / **△** / **▽** to select “Music”, “Videos” or “Settings” and then press **Ⓢ** / **▷**.

- To browse the music contents stored on your iPod, select “Music”.
- To browse the video contents stored on your iPod, select “Videos”.
- To change the playback settings of your iPod, select “Settings”.

Note

“Videos” does not appear unless both your iPod and Yamaha iPod universal dock support the video browsing feature.

3 Press **Ⓢ** / **△** / **▽** / **◀** / **▶** on the remote control to navigate the iPod menu and then press **Ⓢ** / **ENTER** to begin playback of the selected item.

Items under “Music”

Playlists (playlists), Artists (artists), Albums (albums), Songs (songs), Genres (genres), Composers (composers)

- Playlists > Songs
- Artists > Albums > Songs
- Albums > Songs
- Songs
- Genres > Artists > Albums > Songs
- Composers > Albums > Songs

Items under “Videos”

Up to video contents stored on your iPod

Items under “Settings”

Shuffle, Repeat

Shuffle Shuffle

Use this feature to set this unit to play songs or albums in random order.

Choices: Off, Songs, Albums

- Select “Off” to deactivate this feature.
- Select “Songs” to set this unit to play songs in random order.
- Select “Albums” to set this unit to play albums in random order.

Repeat Repeat

Use this feature to set this unit to repeat one song or a sequence of songs.

Choices: Off, One, All

- Select “Off” to deactivate this feature.
- Select “One” to set this unit to repeat one song.
- Select “All” to set this unit to repeat a sequence of songs.



- To toggle between the setting parameters, press **Ⓢ** / **ENTER** repeatedly.
- While the shuffle function is on, “” appears in the OSD.
- While the repeat function is set to “One” or “All”, “” or “” appears in the OSD.

■ Function of the play information display



[1] Track number/total tracks

[2] Name of the artist

[3] Name of the album

[4] Name of the song

[5] Progress bar

[6] Elapsed time

[7] Shuffle and repeat icons

[8] (playback), (pausing), (search forward) or (search backward)

[9] Remaining time

Using Bluetooth™ components

You can connect a Yamaha Bluetooth receiver (such as YBA-10, sold separately) to the DOCK terminal of this unit and enjoy the music contents stored in your Bluetooth component (such as a portable music player) without wiring between this unit and the Bluetooth component. You need to perform “pairing” the connected Bluetooth wireless audio receiver and your Bluetooth component in advance.

Pairing the Bluetooth™ receiver and your Bluetooth component

Pairing must be performed when using a Bluetooth component with the Bluetooth receiver connected to this unit for the first time or if the pairing data has been deleted. “Pairing” refers to the operation of registering a Bluetooth component for Bluetooth communications.



- You need the pairing operation only for the first time when you use the Bluetooth component with the Bluetooth receiver.
- Pairing requires operations on this unit and on the other component with which Bluetooth communications are to be established. If necessary, refer to the other component’s operating instructions.

There are two pairing methods: pairing by using “START PAIRING” in “SET MENU” and quick pairing.

■ Pairing by using “SET MENU”

Use this feature to perform pairing with the OSD. For details, see “START PAIRING” (page 82).

■ Quick pairing

To ensure security, a time limit of 8 minutes is set for the pairing operation. You are recommended to read and fully understand all the instructions before starting.

1 Rotate the **ⒸINPUT** selector (or set the operation mode selector to **ⒺSOURCE** and then press **ⒹDOCK**) to select “DOCK” as the input source.

2 Turn on your Bluetooth component and then set the Bluetooth component to the pairing mode.

For details about how to operate the Bluetooth component, refer to the manual for it.

3 Press and hold **ⒺENTER** (or **ⒸENTER**) until “Searching” appears in the front panel display.

While the Bluetooth receiver is in the pairing mode, DOCK indicator flashes in the front panel display.



To cancel the pairing, press **ⒺENTER** (or **ⒸENTER**) again.

4 Check that the Bluetooth component detects the Bluetooth receiver.

If the Bluetooth component detects the Bluetooth receiver, “YBA-10 YAMAHA” (example) appears in the Bluetooth device list.

5 Select the Bluetooth receiver in the Bluetooth device list and then enter the pass key “0000” on the Bluetooth component.

When the pairing procedure is successful, “Completed” appears in the front panel display.

Note

The Yamaha Bluetooth receiver can be paired with up to eight Bluetooth components. When pairing is conducted successfully with a ninth component and the pairing data is registered, the pairing data for the least recently used other component is cleared.

Playback of the Bluetooth™ component

1 Rotate the **ⒸINPUT** selector (or set the operation mode selector to **ⒺSOURCE** and then press **ⒹDOCK**) to select “DOCK” as the input source.

2 Start playback of your Bluetooth component. When the connected Bluetooth receiver detects the Bluetooth component, “BT connected” appears in the front panel display.



- When you press **ⒸENTER** on the remote control, the connected Bluetooth receiver searches and connect to the last connected Bluetooth component. If the Bluetooth receiver cannot find the Bluetooth component, “Not found” appears in the front panel display.
- To disconnect the Bluetooth receiver from the Bluetooth component, press **ⒸENTER**.

Advanced sound configurations

Selecting decoders

■ Selecting decoders for 2-channel sources (surround decode mode)

Use this feature to play back sources with selected decoders. You can play back 2-channel sources on multi-channels.

Set the operation mode selector to **AMP** and then press **SUR. DECODE** repeatedly on the remote control to select the surround decode mode.

You can select desired surround decoder modes depending on the type of source you are playing and your personal preference.



You can change the decoder parameter settings in the OSD. For details on how to change the parameters, See “Changing sound field parameter settings” on page 67.

■ Decoder descriptions

Name of the decoder
(Decoder Type)

PLIIX Music
PLII Music

Dolby Pro Logic IIX (or Dolby Pro Logic II) processing for music sources. The Pro Logic IIX decoder is not available when “SUR.B L/R SP” (page 76) is set to “NONE” or using headphones.

Decoder description

PRO LOGIC

Dolby Pro Logic processing for any sources.

PLIIX Movie
PLII Movie

Dolby Pro Logic IIX (or Dolby Pro Logic II) processing for movie sources. The Pro Logic IIX decoder is not available when “SUR.B L/R SP” (page 76) is set to “NONE” or using headphones.

PLIIX Music
PLII Music

Dolby Pro Logic IIX (or Dolby Pro Logic II) processing for music sources. The Pro Logic IIX decoder is not available when “SUR.B L/R SP” (page 76) is set to “NONE” or using headphones.

PLIIX Game
PLII Game

Dolby Pro Logic IIX (or Dolby Pro Logic II) processing for game sources. The Pro Logic IIX decoder is not available when “SUR.B L/R SP” (page 76) is set to “NONE” or using headphones.

Neo:6 Cinema

DTS processing for movie sources.

Neo:6 Music

DTS processing for music sources.

CSII Cinema

(U.S.A. model only)

SRS Circle Surround II processing for movie sources.

CSII Music

(U.S.A. model only)

SRS Circle Surround II processing for music sources.

NRL-THX

(U.S.A. and Canada models only)

Neural-THX Surround processing for any sources. The Neural-THX Surround decoder is especially suitable for the XM HD Surround program of XM Satellite Radio.

NRL-THX Music

(U.S.A. and Canada models only)

Neural-THX Surround processing for music sources. The Neural-THX Surround decoder is especially suitable for the XM HD Surround music program of XM Satellite Radio.



When you select the surround decode mode for the multi-channel digital sources, this unit automatically selects the corresponding decoder for each source.

■ Selecting decoders used with MOVIE sound field programs

You can select one of the following decoder types for use with the MOVIE sound field programs (except “Mono Movie”). For details about the MOVIE sound field programs, see “For movie sources” (page 43). For details on how to select the decoder type, See “Changing sound field parameter settings” (page 67).

Choices: PLIIX Movie (PLII Movie), Neo:6 Cinema

■ Selecting decoders for multi-channel sources

If you connected surround back speakers, use this feature to enjoy 6.1/7.1-channel playback for multi-channel sources using the Dolby Pro Logic IIX, Dolby Digital EX, DTS-ES, or Neural-THX decoders.

Set the operation mode selector to **15 AMP** and then press **2 EXT D SUR.** on the remote control repeatedly to switch between 5.1 and 6.1/7.1-channel playback.

Choice	Functions
AUTO	Activates the optimum decoder to play back signals in 6.1/7.1 channels when this unit recognizes a signal flag being input.
Decoders (PLIIX Movie, PLIIX Music, EX/ES, Neural-THX)	Use this feature to activate the desired decoders for the playback of multi-channel sources manually.
OFF	Does not use any decoders to create 6.1/7.1 channels.



Use this feature to activate the desired decoder manually when this unit cannot detect the signal flag encoded to the input sources correctly.

Notes

- The available decoders vary depending on the setting of the speakers and the input sources.
- 6.1/7.1-channel playback is not possible in the following cases:
 - when “SUR. L/R SP” (page 75) or “SUR.B L/R SP” (page 76) is set to “NONE”.
 - when the component connected to the MULTI CH INPUT jacks is being played.
 - when the source being played does not contain surround left and right channel signals.
 - when a Dolby Digital KARAOKE source is being played.
 - when this unit is in the stereo playback, 7ch Enhancer (page 44) or Pure Direct (page 46) mode.
 - when “BI-AMP” is set to “ON” (page 103).
- You can set the initial extended decoder mode with “EXTD SUR.” (page 85).
- “Neural-THX” is only available on the U.S.A. and Canada models.

Changing sound field parameter settings

You can enjoy good quality sound with the initial factory settings. Although you do not have to change the initial factory settings, you can change some of the parameters to better suit the input source or your listening room.

Note

You cannot change the sound field parameter values when “MEMORY GUARD” in “OPTION MENU” is set to “ON” (page 84).

1 Turn on the video monitor connected to this unit.

2 Set the operation mode selector to **15 AMP and then press **2 PARAMETER** on the remote control.**

The following screen appears in the OSD.

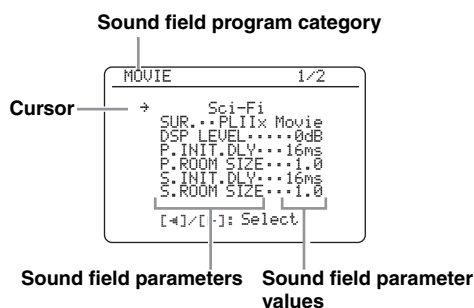

3 Press **8 </> repeatedly to select the desired sound field program you want to adjust.**

4 Press **8 Δ / ∇ to select the desired sound field parameter and then **8** </> to change the selected sound field parameter value.**

For details about each sound field parameter, see page 39.

- To increase the value, press **8** \triangleright .
- To decrease the value, press **8** \triangleleft .



- Repeat steps 3 and 4 as necessary to change other sound field program parameter settings.
- The available parameters for some of the sound field programs may be displayed on more than one page in the OSD. In this case, press **Ⓚ** Δ / ∇ to scroll through pages.
- When you set a sound field parameter to a value other than the initial factory settings, an asterisk mark (*) appears by the parameter name in the OSD.
- If you press and hold **Ⓚ** \triangleleft / \triangleright to change the value, the value shown in the front panel display will momentarily stop at the initial factory setting.
- To initialize the parameters of the selected sound field program, press **Ⓚ** Δ / ∇ repeatedly to select "INITIALIZE" and then press **Ⓚ** \triangleright . In the confirmation screen, press **Ⓚ** \triangleright to confirm or **Ⓚ** \triangleleft to cancel the initialization.

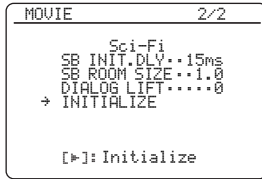

5 Press **Ⓚ PARAMETER to turn off the sound field parameter display.**

Basic configuration of sound field programs

Each sound field program has some parameters defining the characteristics of the program. To customize the selected sound field program, adjust "DSP LEVEL" and/or "DIALOG LIFT" first, and then try other parameters.



To change sound field parameter settings, see page 67 for details.

Adjusting the effect sound level of the sound field programs (DSP LEVEL)

Sound field programs add effect sounds (DSP effect sounds) to the original source sound to create sound field in the listening room. Use the "DSP LEVEL" parameter to adjust the level of the effect sounds.

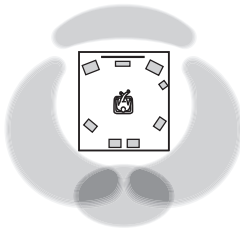

The DSP effect sound level is low

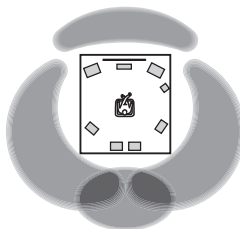

The DSP effect sound level is high

Adjust "DSP LEVEL" as follows:

Increase the value of "DSP LEVEL" when

- the effect sound of the selected sound field program is too weak.
- you cannot recognize any difference between the sound field programs.

Decrease the value of "DSP LEVEL" when

- the sound is vague.
- you feel that the additional sound effect is excessive.

Control range: -6 dB to +3 dB

Adjusting the vertical dialogue position (DIALOG LIFT)

Use this feature to adjust the vertical position of the dialogues in movies. The ideal position of the dialogues is at the center of the video monitor screen.

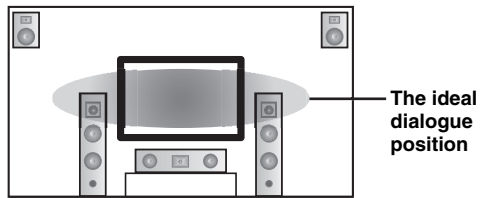

If the dialogues are heard at the lower position of the video monitor screen, increase the value of "DIALOG LIFT".

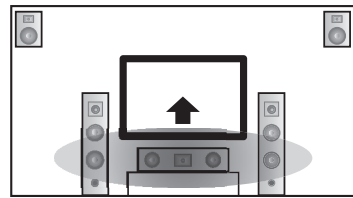

Move up to the ideal dialogue position

Choices: 0, 1, 2, 3, 4, 5

"0" (initial setting) is the lowest position, and "5" is the highest position.

Notes

- "DIALOG LIFT" is available only when "PRESENCE SP" is set to "YES" (page 76).
- You cannot move the dialogue position down from the initial dialogue position.

■ Sound field parameter descriptions

Use the following sound field parameters to customize the sound field programs in detail.



To change sound field parameter settings, see page 67 for details.

Sound field parameter	Features
INIT.DLY P.INIT.DLY S.INIT.DLY SB INIT.DLY	<p>Initial delay. Presence, surround, and surround back sound field initial delay. Changes the apparent size of the sound field by adjusting the delay between the direct sound and the first reflection heard by the listener. The smaller the value, the smaller the sound field seems to the listener.</p> <p> When you adjust the initial delay parameters, we also recommend that you adjust the corresponding room size parameters likewise.</p>

Control range: 1 to 99 ms (INIT.DLY and P.INIT.DLY)
1 to 49 ms (S.INIT.DLY and SB INIT.DLY)

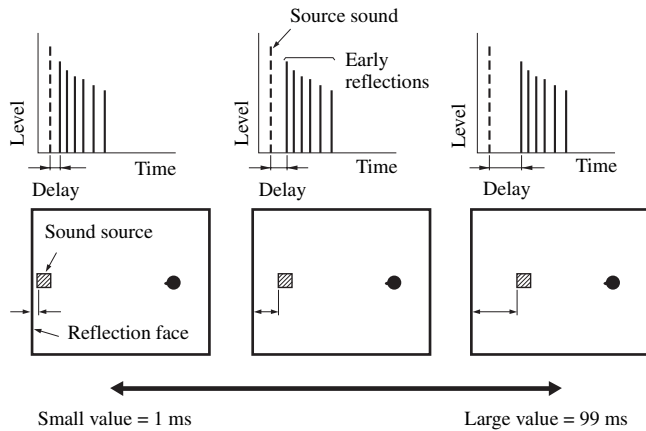

ROOM SIZE
P.ROOM SIZE
S.ROOM SIZE
SB ROOM SIZE

Room size. Presence, surround, and surround back room size. Adjusts the apparent size of the sound field. The larger the value, the larger the surround sound field becomes. As the sound is repeatedly reflected around a room, the larger the hall is, the longer the time between the original reflected sound and the subsequent reflections. By controlling the time between the reflected sounds, you can change the apparent size of the virtual venue. Changing this parameter from one to two doubles the apparent length of the room.



When you adjust the room size parameters, we also recommend that you adjust the corresponding initial delay parameters likewise.

Control range: 0.1 to 2.0

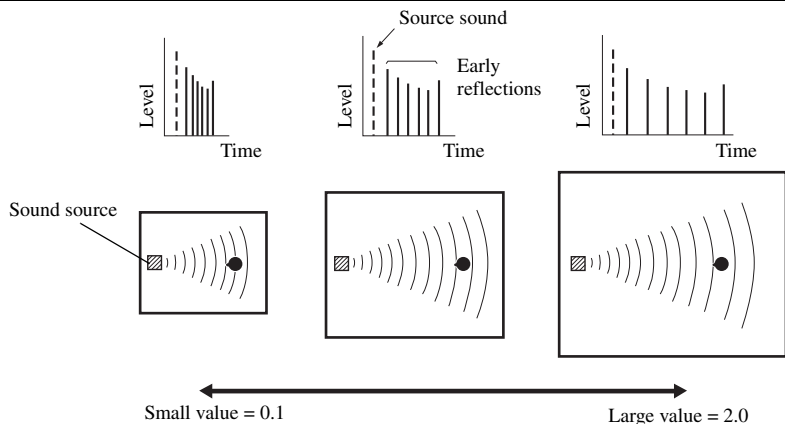

Sound field parameter	Features
-----------------------	----------

LIVENESS
 S.LIVENESS
 SB LIVENESS

Liveness. Surround and surround back liveness. Adjusts the reflectivity of the virtual walls in the hall by changing the rate at which the early reflections decay. The early reflections of a sound source decay much faster in a room with acoustically absorbent wall surfaces than in one which has highly reflective surfaces. A room with acoustically absorbent surfaces is referred to as "dead", while a room with highly reflective surfaces is referred to as "live". This parameter lets you adjust the early reflection decay rate and thus the "liveness" of the room.

Control range: 0 to 10

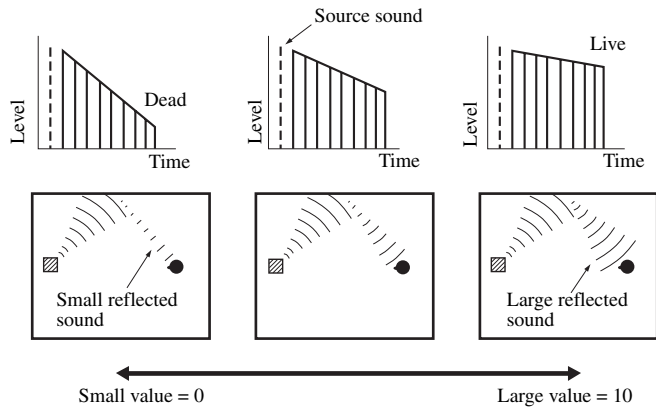

REV.TIME

Reverberation time. Adjusts the amount of time taken for the dense, subsequent reverberation sound to decay by 60 dB at 1 kHz. This changes the apparent size of the acoustic environment over an extremely wide range. Set a longer reverberation time for "dead" sources and listening room environments, and a shorter time for "live" sources and listening room environments.

Control range: 1.0 to 5.0 s

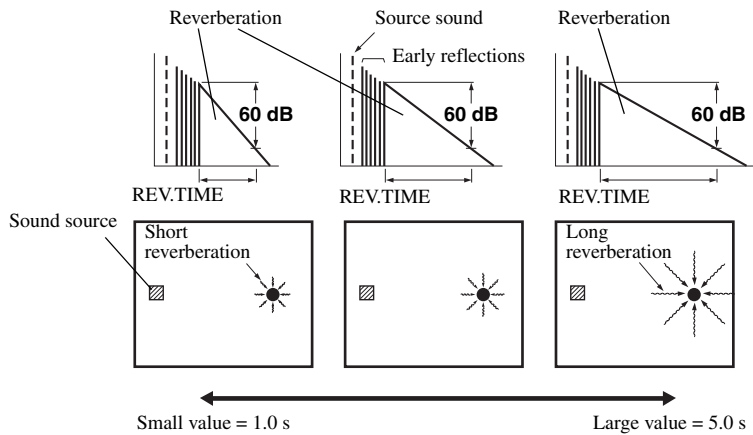

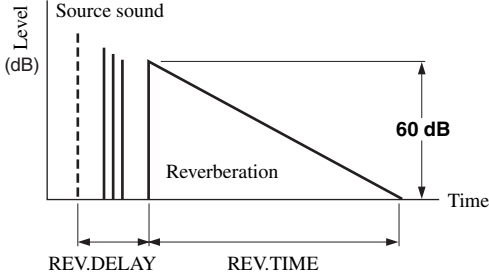
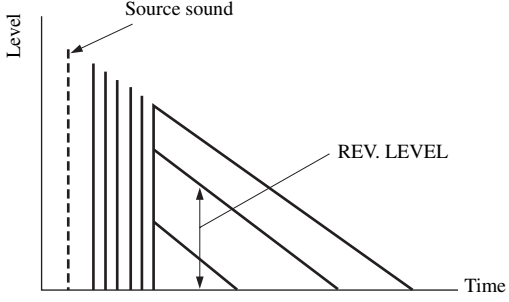
Sound field parameter	Features
REV. DELAY	<p>Reverberation delay. Adjusts the time difference between the beginning of the direct sound and the beginning of the reverberation sound. The larger the value, the later the reverberation sound begins. A later reverberation sound makes you feel as if you are in a larger acoustic environment.</p> <p>Control range: 0 to 250 ms</p>
	
REV. LEVEL	<p>Reverberation level. Adjusts the volume of the reverberation sound. The larger the value, the stronger the reverberation becomes.</p> <p>Control range: 0 to 100%</p>
	
DIRECT (“2ch Stereo” only)	<p>2-channel stereo direct. Bypasses the decoders and DSP processors of this unit for pure hi-fi stereo sound when playing 2-channel analog sources.</p> <p>Choices: AUTO, OFF</p>
<p>⚠</p> <ul style="list-style-type: none"> • Select “AUTO” to bypass the decoders, DSP processors and the tone control circuitry only when “BASS” and “TREBLE” are set to 0 dB (page 46). • Select “OFF” not to bypass the decoders, DSP processors and the tone control circuitry when “BASS” and “TREBLE” are set to 0 dB. • When multi-channel signals are input, they are downmixed to 2 channels and output from the front left and right speakers. • The low-frequency signals of the front left and right channels are redirected to the subwoofer in the following cases: <ul style="list-style-type: none"> – “LFE/BASS OUT” is set to “BOTH” (page 75). – “FRONT SP” is set to “SMALL” (page 75) and “LFE/BASS OUT” is set to “SWFR” (page 75). 	
CT LEVEL SL LEVEL SR LEVEL SB LEVEL PL LEVEL PR LEVEL (“7ch Stereo” only)	<p>7-channel stereo center, surround left, surround right, surround back, presence left and presence right levels. Adjusts the volume level of each channel in the 7-channel stereo mode.</p> <p>Control range: 0 to 100%</p>

Sound field parameter	Features
EFFECT LEVEL (“Straight Enhancer” and “7ch Enhancer” only)	Straight and 7-channel Compressed Music Enhancer effect level. The high-frequency signals of some sources may be emphasized too much. In this case, set the effect level to “LOW”. <hr/> Choices: HIGH , LOW <hr/> <ul style="list-style-type: none">• Select “HIGH” for a high effect level.• Select “LOW” for a low effect level.
SUR (MOVIE sound field programs (except “Mono Movie”) and “SUR.DECODE” only)	Decoder type. Select the decoder used with the selected sound field program. The decoder parameters for “SUR.DECODE” vary depending on the selected decoder type. See page 66 for details.

■ Decoder parameter descriptions

Use the following decoder parameters to customize the specific decoders in detail.

Decoder parameter	Features
PANORAMA (“PLIIX Music” and “PLII Music” only)	Pro Logic IIX Music and Pro Logic II Music panorama. Sends stereo signals to the surround speakers as well as the front speakers for a wraparound effect. Choices: OFF , ON
CENTER WIDTH (“PLIIX Music” and “PLII Music” only)	Pro Logic IIX Music and Pro Logic II Music center width. Moves the center channel output completely towards the center speaker or towards the front left and right speakers. A larger value moves the center channel output towards the front left and right speakers. Control range: 0 (center channel sound is output only from the center speaker) to 7 (center channel sound is output only from the front left and right speakers) Initial setting: 3
DIMENSION (“PLIIX Music” and “PLII Music” only)	Pro Logic IIX Music and Pro Logic II Music dimension. Adjusts the sound field either towards the front or towards the rear. Control range: -3 (towards the rear) to +3 (towards the front) Initial setting: STD (standard)
C. IMAGE (“Neo:6 Music” only)	DTS Neo:6 Music center image. Adjusts the front left and right channel output relative to the center channel to make the center channel more or less dominant as necessary. Control range: 0.0 (center channel sound is output only from the front left and right speakers) to 1.0 (center channel sound output only from the center speaker) Initial setting: 0.3
FOCUS (“CSII Cinema” and “CSII Music” only)	SRS Circle Surround II Cinema and SRS Circle Surround II Music focus. Adjusts the clearness of a sound image by elevating the perception of the sound image to compensate for non-optimally placed speakers from a lower location. A larger value makes speakers sound as if they are positioned at ear level. Control range: 0 (lower location) to 8 (higher location)
TRUBASS (“CSII Cinema” and “CSII Music” only)	SRS Circle Surround II Cinema and SRS Circle Surround II Music TruBass. Adjusts the lower register by producing the perception of improved low frequency performance. A larger value improves bass even without a subwoofer and provides deeper, richer bass in the presence of a subwoofer. Control range: 0 (standard low-frequency performance) to 8 (enhanced low-frequency performance)

Customizing this unit (MANUAL SETUP)

The “MANUAL SETUP” menu allows you to manually adjust speaker and system parameters using the remote control. For the complete menu structure, see “SET MENU tree” (page 123).



The initial factory settings are indicated in bold under each parameter.

Operating the MANUAL SETUP menu

This section explains how to configure parameters in the MANUAL SETUP menu using the OSD.



- To return to the previous menu level, press **ⓈRETURN**.
- Pressing **ⓈPARAMETER** cancels the menu operation.

1 Set the operation mode selector to **ⓈAMP** and then press **ⓈMENU** to enter “SET MENU”.

The top “SET MENU” screen appears in the OSD.

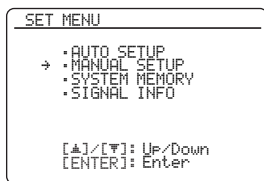

2 Press **Ⓢ△/▽** to select “MANUAL SETUP” and then press **ⓈENTER**.

The “MANUAL SETUP” screen appears in the OSD.

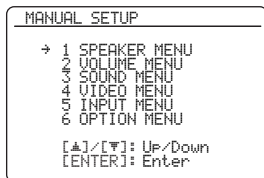

3 Press **Ⓢ△/▽** repeatedly and then press **ⓈENTER** to select and enter the desired menu.

As an example, the following screen appears if “SOUND MENU” is selected.

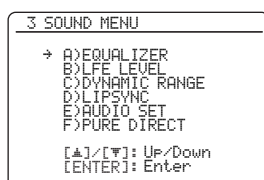

4 Press **Ⓢ△/▽** repeatedly and then press **ⓈENTER** to select and enter the desired submenu.

As an example, the following screen appears if “LFE LEVEL” is selected.

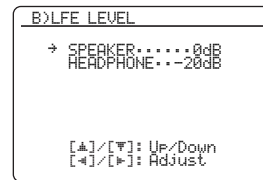

5 Press **Ⓢ△/▽** to select the desired parameter and then **Ⓢ◀/▶** to change the parameter settings.

- To increase the value, press **Ⓢ▶**.
- To decrease the value, press **Ⓢ◀**.

6 Press **ⓈMENU** to exit from “SET MENU”.

1 SPEAKER MENU

Use this feature to manually adjust the basic speaker settings. Most of the “SPEAKER MENU” parameters are set automatically when you run the automatic setup.



- Set “TEST TONE” to “ON” (page 77) to output the test tone for the “CONFIG”, “LEVEL” and “DISTANCE” settings.
- If your subwoofer can adjust the output volume and the crossover frequency, set the volume to about half way (or slightly less) and set the crossover frequency to the maximum.

■ Speaker configurations A)CONFIG

LFE/bass out LFE/BASS OUT

Use this feature to select the speakers that output the LFE (low-frequency effect) and the low-frequency signals.

LFE signals output

Choice	Subwoofer(s) and speakers		
	Subwoofer(s)	Front speakers	Other speakers
BOTH	Output	No output	No output
SWFR	Output	No output	No output
FRONT	No output	Output	No output

Low-frequency signals output

Choice	Subwoofer(s) and speakers		
	Subwoofer(s)	Front speakers	Other speakers
BOTH	*1	*2	*3
SWFR	*4	*3	*3
FRONT	No output	*1	*3

- *1 Output(s) the low-frequency signals of the front channels and other speakers set to “SMALL”.
- *2 Always output the low-frequency signals of the front channels.
- *3 Output the low-frequency signals if the speakers are set to “LARGE”.
- *4 Outputs the low-frequency signals of the speakers set to “SMALL”.

Measure for the speaker size

- The woofer section of a speaker is
- 16 cm (6.5 in) or larger: large
 - smaller than 16 cm (6.5 in): small

Front speakers FRONT SP

Choice	Descriptions
LARGE	Select this setting when the front speakers are large.
SMALL	Select this setting when the front speakers are small.

Note

When “LFE/BASS OUT” is set to “FRONT”, you can select only “LARGE” in “FRONT SP”. If the value of “FRONT SP” is set to other than “LARGE” in advance, this unit change the value to “LARGE” automatically.

Center speaker CENTER SP

Choice	Descriptions
LARGE	Select this setting when the center speaker is large.
SMALL	Select this setting when the center speaker is small.
NONE	Select this setting when you do not use the center speaker. The center channel signals are directed to the front left and right speakers.

Surround left/right speakers SUR. L/R SP

Choice	Descriptions
LARGE	Select this setting when the surround speakers are large.
SMALL	Select this setting when the surround speakers are small.
NONE	Select this setting when you do not use the surround speakers. This unit is set to the Virtual CINEMA DSP mode (page 44), and “SUR.B L/R SP” is automatically set to “NONE”.

Surround back left/right speakers

SUR. B L/R SP

Choice	Descriptions
LRGx1	Select this setting when the single surround back speaker is large.
LRGx2	Select this setting when the surround back left and right speakers are large.
SMLx1	Select this setting when the single surround back speaker is small.
SMLx2	Select this setting when the surround back left and right speakers are small.
NONE	Select this setting when you do not use the surround back speakers. The surround back channel signals are directed to the surround left and right speakers.

Presence speakers PRESENCE SP

Choice	Descriptions
YES	Select this setting when you use the presence speakers.
NONE	Select this setting when you do not use the presence speakers.

Bass cross over CROSS OVER

Use this feature to select the crossover frequency of all the speakers set to “SMALL” (or “SML”) in “CONFIG” (page 75). All frequencies below the selected frequency will be sent to the subwoofer or front speakers depending on the setting of “LFE/BASS OUT” (page 75).

Choices: 40Hz, 60Hz, **80Hz**, 90Hz, 100Hz, 110Hz, 120Hz, 160Hz, 200Hz



If your subwoofer can adjust the output volume and the crossover frequency, set the volume to about half way (or slightly less) and set the crossover frequency to the maximum.

Subwoofer phase SUBWOOFER PHASE

Use this feature to switch the phase of your subwoofer if bass sounds are lacking or unclear.

Choice	Functions
NORMAL	Does not change the phase of your subwoofer.
REVERSE	Sets the phase of your subwoofer to reverse.

Speaker level B)LEVEL

Use this feature to manually balance the speaker levels between the front left or surround left speakers and each speaker selected in “CONFIG” (page 75).

Control range: -10.0 dB to +10.0 dB

Control step: 0.5 dB

Initial setting:

FR.L/FR.R/SWFR/PR.L/PR.R: 0 dB

CENT./SUR.L/SUR.R/SB L/SB R: -1.0 dB

LEVEL	Adjusted speaker
FR.L	Front left speaker
FR.R	Front right speaker
CENT.	Center speaker
SUR.L	Surround left speaker
SUR.R	Surround right speaker
SB L	Surround back left speaker
SB R	Surround back right speaker
SWFR	Subwoofer
PR.L	Presence left speaker
PR.R	Presence right speaker

Notes

- The available speaker channels differ depending on the “CONFIG” setting.
- Instead of “SB L” and “SB R”, “SB” is displayed if “SUR. B L/R SP” is set to either “SMLx1” or “LRGx1”.

Speaker distance C)DISTANCE

Use this feature to manually adjust the distance of each speaker and the delay applied to the respective channel. Ideally, each speaker should be the same distance from the main listening position. However, this is not possible in most home situations. Thus, a certain amount of delay must be applied to the sound from each speaker so that all sounds will arrive at the listening position at the same time.

Unit for the speaker distance adjustment UNIT

Initial setting:

[U.S.A. and Canada models]: feet (ft)

[Other models]: meters (m)

Choice	Functions
meters (m)	Adjusts speaker distances in meters.
feet (ft)	Adjusts speaker distances in feet.

Speaker distances

Control range: 0.30 to 24.00 m (1.0 to 80.0 ft)

Control step: 0.10 m (0.5 ft)

Initial setting:

FRONT L/FRONT R/SWFR/PRNS L/PRNS R: 3.00 m (10.0 ft)

CENTER: 2.60 m (8.5 ft)

SUR. L/SUR. R/SB L/SB R: 2.40 m (8.0 ft)

DISTANCE	Adjusted speaker
FRONT L	Front left speaker
FRONT R	Front right speaker
CENTER	Center speaker
SUR. L	Surround left speaker
SUR. R	Surround right speaker
SB L	Surround back left speaker
SB R	Surround back right speaker
SWFR	Subwoofer
PRNS L	Presence left speaker
PRNS R	Presence right speaker

Notes

- The available speaker channels differ depending on the “CONFIG” setting.
- Instead of “SB L” and “SB R”, “SUR.B” is displayed if “SUR.B L/R SP” is set to either “SMLx1” or “LRGx1”.

■ Test tone D)TEST TONE

Turns the test tone output on or off for the “CONFIG”, “LEVEL” and “DISTANCE” settings.

Choice	Functions
OFF	This unit does not output the test tone for the “CONFIG”, “LEVEL” and “DISTANCE” settings.
ON	This unit outputs the test tone for the “CONFIG”, “LEVEL” and “DISTANCE” settings.



If you use a handheld sound pressure level meter, hold at arm’s length and point upwards so that the meter is in the listening position. With the meter set to the 70 dB scale and to C SLOW, calibrate each speaker to 75 dB.

Note

This function is automatically turned off if you exit from “SPEAKER MENU”.

2 VOLUME MENU

Use this menu to manually adjust the various volume settings.

Adaptive dynamic range control

ADAPTIVE DRC

Use this feature to adjust the dynamic range in conjunction with the volume level. This feature is useful when you are listening at lower volumes or at night. When “ADAPTIVE DRC” is set to “AUTO”, this unit controls the dynamic range as follows:

- If the VOLUME setting is low: the dynamic range is narrow
- If the VOLUME setting is high: the dynamic range is wide

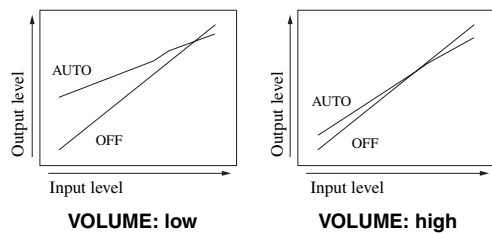

Choice	Functions
AUTO	Adjusts the dynamic range automatically.
OFF	Does not adjust the dynamic range automatically.



- You can also adjust the dynamic range of the bitstream signal sources by using “DYNAMIC RANGE” in “SOUND MENU” (page 79).
- This function is also useful for listening with your headphones.

Note

The adaptive dynamic range control feature does not function when this unit is in the Pure Direct mode (page 46).

Adaptive DSP level ADAPTIVE DSP LEVEL

Use this feature to make fine adjustments of the DSP effect level (page 68) automatically in conjunction with the volume level.

Choice	Functions
AUTO	Adjusts the DSP effect level in conjunction with the volume level.
OFF	Does not adjust the DSP effect level automatically.

Note

Even if you set “ADAPTIVE DSP LEVEL” to “AUTO”, this unit does not change but the fine-tunes the specified value of “DSP LEVEL” (page 68).

Muting type MUTING TYPE

Use this feature to adjust how much the mute function reduces the output volume (page 37).

Choice	Functions
FULL	Mutes all the audio output.
-20dB	Reduces the current volume by 20 dB.

Maximum volume MAX VOL.

Use this feature to set the maximum volume level in the main zone. This feature is useful to avoid the unexpected loud sound by mistake. For example, the original volume range is -80.0 dB to +16.5 dB. However, when “MAX VOL.” is set to -5.0 dB, the volume range becomes -80.0 dB to -5.0 dB.

Control range: -30.0 dB to +15.0 dB, **+16.5 dB**

Control step: 5.0 dB

Notes

- When this unit is in the automatic setup procedure, the volume level is automatically set to 0 dB regardless of the current “MAX VOL.” setting.
- The “MAX VOL.” setting takes priority over the “INIT. VOL.” setting.

Initial volume INIT. VOL.

Use this feature to set the volume level of the main zone when the power of this unit is turned on.

Choices: **OFF**, MUTE, -80.0 dB to +16.5 dB

Control step: 0.5 dB

Note

The “MAX VOL.” setting takes priority over the “INIT. VOL.” setting.

3 SOUND MENU

Use this feature to adjust the audio parameters.

■ **Equalizer** A)EQUALIZER

Use this feature to select the parametric equalizer or the graphic equalizer.

Equalizer type select EQ TYPE

Use this feature to select the type of equalizer.

Choice	Functions
AUTO PEQ	Uses the parametric equalizer adjusted in the automatic setup procedure.
GEQ	Uses the equalizer settings adjusted in “GEQ EDIT”.
OFF	Deactivates the equalizing feature.

Note

“AUTO PEQ” is available only after you have done the automatic setup procedure (page 30).

Graphic equalizer edit GEQ EDIT

Use this feature to adjust the tonal quality of each channel.
 Speaker channel: FRONT L, FRONT R, CENTER, SUR. L, SUR. R, SB L, SB R, PRNS L, PRNS R, SWFR

Frequency band: 63 Hz, 160 Hz, 400 Hz, 1 kHz, 2.5 kHz, 6.3 kHz, 16 kHz

Control range: -6.0 dB to +6.0 dB

Control step: 0.5 dB



To output a test tone while adjusting the tonal quality, set “TEST” to “ON”.

Notes

- “GEQ EDIT” is available only when “EQ TYPE” is set to “GEQ”.
- The available speaker channels differ depending on the “CONFIG” setting.
- Instead of “SB L” and “SB R”, “SB” is displayed if “SUR.B L/R SP” is set to either “SMLx1” or “LRGx1”.

Parametric equalizer select PEQ SELECT

Use this feature to select the parametric equalizer type that applied to the results of the automatic setup.

Choice	Functions
NATURAL	Averages out the frequency response of each all speakers with higher frequencies being less emphasized. Recommended if the “FLAT” setting sounds a little harsh.
FLAT	Averages frequency response of all speakers. Recommended if all of your speakers are of similar quality.
FRONT	Adjusts the frequency response of each speaker in accordance with the sound of your front speakers. Recommended if your front speakers are of much higher quality than your other speakers.

Note

“PEQ SELECT” is available only when “EQ TYPE” is set to “AUTO PEQ”.

■ **Low-frequency effect level**
B\LFE LEVEL

Use this feature to adjust the output level of the LFE (low-frequency effect) channel according to the capacity of your subwoofer or headphones. The LFE channel carries low-frequency special effects which are only added to certain scenes. This setting is effective when the input signal contains the LFE channel.

Control range: -20 to 0 dB
Control step: 1 dB

Speakers SPEAKER
Adjusts the speaker LFE level.

Headphones HEADPHONE
Adjusts the headphone LFE level.

Note

Depending on the “LFE/BASS OUT” setting (page 75), some signals may not be output at the SUBWOOFER PRE OUT jack.

■ **Dynamic range** C\DYNAMIC RANGE

Use this feature to select the amount of dynamic range compression to be applied to your speakers or headphones. This setting is effective only when this unit is decoding bitstream signals.

Speakers SPEAKER
Adjusts the dynamic range compression for the speakers.

Headphones HEADPHONE
Adjusts the dynamic range compression for the headphones.

Choice	Functions
MIN/AUTO	<ul style="list-style-type: none"> MIN: Adjusts the dynamic range to narrow when this unit is decoding bitstream signals (except Dolby TrueHD). AUTO: Adjusts the dynamic range according to the instruction of the input source signals when this unit is decoding Dolby TrueHD signals.
STD	Adjusts the dynamic range to medium. When this unit is decoding Dolby TrueHD signals, the dynamic range control is always active regardless of the instruction of the input source signals.
MAX	Preserves the greatest amount of dynamic range.

■ **Audio and video synchronization (lip sync)** D\LIPSYNC

HDMI automatic lip sync mode HDMI AUTO

If the connected video monitor is connected to the HDMI OUT jack of this unit and compatible with the automatic audio and video synchronization function (automatic lip sync), this unit adjusts the audio and video synchronization automatically. Use this feature to activate or deactivate the automatic lip sync.

Choice	Functions
OFF	Select this setting if the video monitor is not compatible with the automatic lip sync or you do not want to use the automatic lip sync. Use “MANUAL DELAY” to adjustment the audio and video synchronization.
ON	Select this setting if the connected video monitor is compatible with the automatic lip sync. Use “AUTO DELAY” to make fine adjustments of the audio and video synchronization.

Auto delay AUTO DELAY

Use this feature to make fine adjustments of the audio and video synchronization when you set “HDMI AUTO” to “ON”.

Control range: 0 to 240 ms
Control step: 1 ms



“offset” indicates the difference between the value of the audio delay that this unit sets automatically and the value of the audio delay that you set in “AUTO”. This unit stores the value of “offset” and applies the value to other automatic lip sync compatible video monitors.

Manual delay MANUAL DELAY

Use this feature to adjust the delay of the sound output manually to synchronize audio with video images when you set “HDMI AUTO” to “OFF”.

Control range: 0 to 240 ms
Control step: 1 ms

■ **Audio settings** E>AUDIO SET

Tone bypass TONE BYPASS

Use this feature to select whether the audio output bypasses the tone control circuitry when “TREBLE” and “BASS” are set to 0 dB (page 46).

Choice	Functions
AUTO	Automatically bypasses the tone control circuitry to provide the purest signal possible when “TREBLE” and “BASS” are set to 0 dB.
OFF	Does not bypass the tone control circuitry.

HDMI audio HDMI AUDIO

Use this feature to select the types of the audio signals output at the HDMI OUT jack on the rear panel of this unit.

Choice	Functions
AMP	Outputs audio signals that can be decoded by this unit.
AMP+TV	Outputs audio signals that can be decoded by your video monitor connected to the HDMI OUT jack of this unit.

Note

Available audio/video signals depend on the specification of the connected video monitor. Refer to the instruction manuals of your video monitor and audio source component.

■ **Pure direct** F>PURE DIRECT

Use this feature to select whether this unit outputs the video signals when this unit is in the Pure Direct mode.

Choice	Functions
AUDIO	Does not Output video signals.
AUDIO+VID EO	Outputs video signals. For the better sound quality, this unit only activates the limited video features.

Note

You cannot use the OSD menu even if “PURE DIRECT” is set to “AUDIO+VIDEO”.

4 VIDEO MENU

Use this feature to adjust the video parameters.



You can reset the all parameters in “VIDEO MENU” to the initial factory settings by using “VIDEO” of “INITIALIZE” in “ADVANCED SETUP” (page 103).

Video conversion VIDEO CONV.

Use this feature to set whether to convert the video signals input at the VIDEO, S VIDEO, and COMPONENT VIDEO jacks.

Choice	Functions
ON	Converts composite, S-video, and component video signals interchangeably and up-converts composite, S-video, and component video signals to HDMI video signals.
OFF	Does not convert any signals.

Notes

- This unit does not convert 480 line video signals and 576 line video signals interchangeably.
- 480p-, 576p-, 1080i- and 720p-resolution video signals cannot be output at the S VIDEO and VIDEO MONITOR OUT jacks.
- The converted video signals are only output at the MONITOR OUT jacks. When recording a video source, you must make the same type of video connections between each component.
- When composite video or S-video signals from a VCR are converted into component video signals, the picture quality may suffer depending on your VCR.
- Unconventional signals input at the composite video or S-video jacks cannot be converted or may be output abnormally. In such cases, set “VIDEO CONV.” to “OFF”.

Component interlace/progressive up-conversion COMPONENT I/P

Use this feature to activate or deactivate the analog interlace/progressive conversion of the analog video signals input at the composite video, S-video and component video jacks so that the analog video signals deinterlaced from 480i (NTSC)/576i (PAL) to 480p/576p are output at the COMPONENT MONITOR OUT jacks.

Choice	Functions
ON	Activates the analog interlace/progressive up-conversion of the analog video signals.
OFF	Deactivates the analog interlace/progressive up-conversion of the analog video signals.

Notes

- The “COMPONENT I/P” parameter appears only when you set “VIDEO CONV.” to “ON”.
- If your video monitor does not support analog video signals with 480p/576p of resolution, the SET MENU items may not be displayed on your video monitor when “COMPONENT I/P” is set to “ON”.

HDMI resolution HDMI RES.

Use this feature to activate or deactivate the HDMI up-scaling of the analog video signals input at the VIDEO, S VIDEO and COMPONENT VIDEO jacks so that the up-scaled video signals are output at the HDMI OUT jack. This unit up-scales the video signals as follows:

- 480i (NTSC)/576i (PAL) → 480p/576p, 1080i, 720p, or 1080p
- 480p/576p → 1080i, 720p, or 1080p

Choice	Functions
THROUGH	Does not up-scale any analog video signals.
480p (or 576p), 1080i, 720p, 1080p	Up-scales analog video signals to 480p or 576p, 1080i, 720p, or 1080p of resolution.

Notes

- “HDMI RES.” is available only when “VIDEO CONV.” is set to “ON”.
- This unit automatically detects the video signal resolutions supported by the connected video monitor and uses an asterisk (*) to indicate them. If this unit cannot detect the resolutions, set “MONITOR CHECK” to “SKIP” (page 103).

HDMI aspect ratio HDMI ASPECT

Use this feature to select the adjustment of aspect ratio for analog video signals output at the HDMI OUT jack.

Choice	Functions
THRGH	Does not make any adjustments to the aspect ratio for the HDMI video signal sources.
16:9	Displays video images with the aspect ratio of 4:3 on your video monitor with the aspect ratio of 16:9. Black stripes appear on the right and left sides as a result.
SMART	Fits video images with the aspect ratio of 4:3 to your video monitor with the aspect ratio of 16:9.

Notes

- “HDMI ASPECT” is available only when “HDMI RES.” is not set to “THROUGH”.
- If the aspect ratio of the input video source is other than 4:3, this unit automatically ignores the setting of “HDMI ASPECT”.
- When “HDMI ASPECT” is set to “SMART”, the video images of the edge of the video monitor are rather stretched.

5 INPUT MENU

Use this menu to adjust the parameters of each input source.

Input source	Parameter
A)SIRIUS (U.S.A. and Canada models only)	INPUT RENAME VOL. TRIM BGV
B)XM (U.S.A. and Canada models only)	
C)TUNER	
D)MULTI CH	INPUT RENAME VOL. TRIM BGV INPUT CH FRONT
E)PHONO	I/O ASSIGNMENT
F)CD	INPUT RENAME
G)TV	VOL. TRIM
H)MD/CD-R	DECODER MODE BGV
I)BD/HD DVD	I/O ASSIGNMENT
J)DVD	INPUT RENAME
K)CBL/SAT	VOL. TRIM
L)DVR	DECODER MODE
M)VCR	
N)V-AUX	
O)DOCK	INPUT RENAME VOL. TRIM STANDBY CHARGE
P)BLUETOOTH	INPUT RENAME VOL. TRIM BGV START PAIRING

Input/output assignment

I/O ASSIGNMENT

Use this feature to assign the input/output jacks according to the component to be used if the initial settings of this unit do not correspond to your needs. Change the parameter to reassign the respective jacks and effectively connect more components.

Once the input/output jacks are reassigned, you can select the corresponding component by using the **INPUT** selector (or the input selector buttons (③)).



- “NONE” appears in the OSD when no input source is assigned to the jack.
- You cannot select a specific item more than once for the same type of jack.
- An asterisk (*) appears to the right of the jack names that have been changed from their previous settings.
- The input source currently assigned to the selected jack is shown in the parentheses next to “Current”.

Input rename INPUT RENAME

Use this feature to change the name of the input source (up to 9 characters) that appears in the OSD and in the front panel display.

- To locate the position to edit, press **⊞** / **◀** / **▶**.
- To select a character, press **⊞** / **Δ** / **∇**.
- To confirm the setting, press **⊞** **ENTER**.
- To return to the previous screen without change, press **⊞** **RETURN**.



Press **⊞** / **∇** to change the character in the following order, or press **⊞** / **Δ** to go in the reverse order: A to Z, 0 to 9, a to z, symbols (#, *, -, +, etc.), space.

Volume trim VOL. TRIM

Use this feature to adjust the level of the signal input at each jack. This feature is useful if you want to balance the level of each input source to avoid sudden changes in volume when switching between input sources.

Control range: -6.0 dB to +6.0 dB

Control step: 0.5 dB

Initial setting: 0.0 dB



This parameter also affects the signals output at the audio ZONE OUT jacks.

Decoder mode DECODER MODE

Use this feature to switch the decoder activation mode.

Choice	Functions
AUTO	Automatically detects digital audio signal input types and selects the appropriate decoder.
DTS	Activates the DTS decoder and plays back only DTS digital audio signals when digital audio signals are input.

Note

“DECODER MODE” is available only when the digital audio input jacks (HDMI, OPTICAL and/or COAXIAL) are assigned to the selected input source.

Audio input BGV BGV

Use this feature to select the video source played in the background of the selected audio input source.

Choice	Functions
BD/HD DVD, DVD, CBL/SAT, DVR, VCR, V-AUX, DOCK	Selects the corresponding input source as the background video source.
OFF	Does not play the video source in the background.

Charge on standby STANDBY CHARGE

Use this feature to select whether this unit charges the battery of the stationed iPod or not when this unit is in the standby mode.

Choice	Functions
AUTO	Charges the battery of the stationed iPod when this unit is turned on and in the standby mode.
OFF	Charges the battery of the stationed iPod only when this unit is turned on.

Start pairing START PAIRING

Use this feature to start pairing the connected Yamaha Bluetooth wireless audio receiver (such as YBA-10, sold separately) with your Bluetooth component. For details about the pairing, refer to “Pairing the Bluetooth™ receiver and your Bluetooth component” (page 65).

To ensure security, a time limit of 8 minutes is set for the pairing operation. You are recommended to read and fully understand all the instructions before starting.

1 Press **⊞** **ENTER** to start pairing.

The connected Bluetooth receiver starts searching Bluetooth components. “Searching...” appears in the OSD.

2 Check that the Bluetooth component detects the Bluetooth receiver.

For details, refer to the instruction manual of the Bluetooth component.

3 Select the Bluetooth receiver in the Bluetooth device list and then enter the pass key "0000" on the Bluetooth component.

Once this unit completes the pairing successfully, "Completed" appears.



To cancel the pairing, press **Ⓢ**RETURN.

4 Press **Ⓢ**RETURN to exit from "START PAIRING".

Notes

- If the connected Bluetooth receiver cannot find any Bluetooth components, "Not found" appears.
- If a Bluetooth receiver is not connected to this unit, "No Bluetooth receiver" appears.

Input channels INPUT CH

Use this setting to select the number of channels input from an external decoder (page 23).

Choice	Functions
6ch	Select this setting if the connected component outputs discrete 6-channel audio signals.
8ch	Select this setting if the connected component outputs discrete 8-channel audio signals. You also need to configure the "FRONT" setting (below).

Front left and right channels input jack FRONT

If you set "INPUT CH" to "8CH", you need to specify the analog audio jacks at which the front left and right channel signals output from the connected external decoder are input.

Choices: CD, TV, MD/CD-R, **BD/HD DVD**, DVD, CBL/SAT, DVR, VCR, V-AUX

Note

"FRONT" is available only when "INPUT CH" is set to "8CH".

6 OPTION MENU

Use this menu to adjust the optional system parameters.

■ Display settings A)DISPLAY SET

Note

You can reset the "OSD SHIFT" and "GRAY BACK" settings to the initial factory settings by using "VIDEO" of "INITIALIZE" in "ADVANCED SETUP" (page 103).

Dimmer DIMMER

Use this feature to adjust the brightness of the front panel display.

Control range: -4 to 0

Control step: 1

- To make the front panel display dimmer, press **Ⓢ**<.
- To make the front panel display brighter, press **Ⓢ**>.

OSD shift OSD SHIFT

Use this feature to adjust the vertical position of the OSD.

Control range: -5 (downward) to +5 (upward)

Control step: 1

Initial setting: 0

- To lower the position of the OSD, press **Ⓢ**<.
- To raise the position of the OSD, press **Ⓢ**>.

Gray back GRAY BACK

Use this feature to display a gray background in your video monitor when there is no video signal being input.

Choice	Functions
AUTO	Displays a gray background on your video monitor when there is no video signal being input.
OFF	Does not display a gray background on your video monitor.

Note

Depending on the video signals being input or the system setting of your video monitor (NTSC or PAL), the OSD may be displayed abnormally. In such cases, set "GRAY BACK" to "OFF".

Short message display

SHORT MESSAGE

Use this feature to activate or deactivate the short message display function.

Choice	Functions
ON	Activates the short message display function. The contents of the front panel display appear at the bottom of the screen each time you operate this unit.
OFF	Deactivates the short message display function.

Note

The short message display does not appear in the following cases:

- when the component video signals with 480p/576p, 720p, 1080i or 1080p resolutions are input
- when HDMI video signals are input

On-screen display time ON SCREEN

Use this feature to set the amount of time to display the HD Radio (U.S.A. model only), XM Satellite Radio, or SIRIUS Satellite Radio information or iPod menu in the OSD after you perform a certain operation.

Choice	Functions
ALWAYS	Displays the OSD unceasingly during an operation.
10S	Turns off the OSD 10 seconds after you perform a certain operation.
30S	Turns off the OSD 30 seconds after you perform a certain operation.

Front panel display scroll FL SCROLL

Use this feature to set the mode to display the HD Radio (U.S.A model only), XM Satellite Radio information, SIRIUS Satellite Radio information, or iPod menu (such as song title or channel name) in the front panel display.

Choice	Functions
CONT	Select this to display the operation status in the front panel display in a continuous manner.
ONCE	Select this to display the operation status in the front panel display by the first 14 alphanumeric characters after scrolling all characters once.

Memory guard B)MEMORY GUARD

Use this feature to prevent accidental changes to sound field program parameter and other system settings.

Choice	Functions
OFF	Turns off the memory guard feature.
ON	Turns on the memory guard feature. While it is turned on ("G" appears at the top right of the "SET MENU" screen), the following settings are protected. <ul style="list-style-type: none"> - sound field program parameters - "AUTO SETUP" items - all speaker levels - "MANUAL SETUP" items

Note

You can change the following parameters even if "MEMORY GUARD" is set to "ON":

- "DECODER MODE" in "INPUT MENU" (page 82)
- "MEMORY GUARD"
- "SUR." of the sound field program parameter (page 72)
- "TONE BYPASS" in "SOUND MENU" (page 80)
- Loading the system settings (page 87)

Initial configuration C)INIT. CONFIG

Use this feature to select the settings of the audio input jack select, active decoders and extended surround when you turn on this unit.

Audio select AUDIO SELECT

Use this feature to designate the default audio input jack select setting (page 36) for the input sources connected to the DIGITAL INPUT jacks when you turn on the power of this unit.

Choice	Functions
AUTO	Automatically detects the type of input signals and selects the appropriate audio input jack select setting.
LAST	Automatically selects the last input jack select setting used for the connected input source.

Decoder mode DECODER MODE

Use this feature to designate the default decoder mode (page 82) for the input sources connected to the DIGITAL INPUT jacks when you turn on the power of this unit.

Choice	Functions
AUTO	Automatically detects the type of input signals and select the appropriate decoder mode setting.
LAST	Automatically selects the last decoder mode setting used for the connected input source.

Extended surround EXT.D SUR.

Use this feature to designate the extended decoder mode (page 67) for the input sources connected to the DIGITAL INPUT jacks when you turn on the power of this unit.

Choice	Functions
AUTO	Automatically detects the digital audio input signals and activates the appropriate decoder.
LAST	Automatically selects the decoder mode selected last time.

■ Zone set D)ZONE SET

Use this feature to set the items related in Zone 2 or Zone 3.

Note

"MAX VOL." and "INIT. VOL." are available only when "VOLUME" is set to "VAR".

Setting zone

Select the zone which you want to configure the settings for.

Zone 2/Zone 3 amplifier AMP

Use this feature to select how the Zone 2 or Zone 3 speakers are amplified. This parameter also effects the speaker settings and the sound output of sound field programs in the main zone.

Choice	Functions
EXT	Select this setting when the Zone 2 or Zone 3 speakers are connected to the external amplifier which is connected to the ZONE OUT (ZONE 2 or ZONE 3) jacks of this unit.
[SP1]	Select this setting when the Zone 2 or Zone 3 speakers are directly connected to the SP1 speaker terminals of this unit.
[SP2]	Select this setting when the Zone 2 or Zone 3 speakers are directly connected to the SP2 speaker terminals of this unit.
BOTH	Select this setting when the Zone 2 or Zone 3 speakers are connected to both the SP1 and SP2 speaker terminals of this unit (for example, the speakers are connected using the bi-amplifier connection or there are four speakers in the room) or when you want to play back the same source in the Zone 2 and Zone 3 simultaneously.



For details on Zone 2 and Zone 3 connections, see "Connecting the Zone 2 and Zone 3 components" (page 99).

Notes

- If "BI AMP" in "ADVANCED SETUP" is set to "ON" (page 103), the "AMP" setting is fixed to "EXT".
- When you set "AMP" to "[SP1]" and the corresponding zone is turned on, no sound is output from the surround back speakers.
- When you set "AMP" to "[SP2]" and the corresponding zone is turned on, no sound is output from both the surround and the surround back speakers.

- When you set "AMP" to "BOTH" for either "ZONE 2" or "ZONE 3", the "AMP" setting for another zone is fixed to "EXT".
- When you set "AMP" to "BOTH" and the corresponding zone is turned on, no sound is output from both the surround and surround back speakers.

Zone 2/Zone 3 volume VOLUME

Use this feature to select whether this unit controls the volume level of the audio signals output at the ZONE OUT (ZONE 2 or ZONE 3) jacks when you set "AMP" to "EXT" (page 85).

Choice	Functions
VAR	Select this setting if you want to adjust the ZONE OUT (ZONE 2 or ZONE 3) volume level using the remote control of this unit.
FIX	Select this setting if you want to adjust the Zone 2 or Zone 3 volume level on the external amplifier. This unit fixed the ZONE OUT (ZONE 2 or ZONE 3) volume level to a standard line level.

Zone 2/Zone 3 maximum volume MAX VOL.

Use this feature to set the maximum volume level in the Zone 2 or Zone 3.

Control range: -30.0 dB to +15.0 dB, **+16.5dB**

Control step: 5.0 dB

Note

The "MAX VOL." setting takes priority over the "INIT. VOL." setting.

Zone 2/Zone 3 initial volume INIT. VOL.

Use this feature to set the volume level of Zone 2 or Zone 3 when the power of Zone 2 or Zone 3 is turned on.

Choices: **OFF**, MUTE, -80.0 dB to +16.5 dB

Control step: 0.5 dB

Note

The "MAX VOL." setting takes priority over the "INIT. VOL." setting.

Saving and recalling the system settings (SYSTEM MEMORY)

Use this feature to save up to six of your favorite settings that can be easily recalled when needed. You can save the following system setting parameters:

Saved parameters	Page
“SPEAKER MENU” parameters (except “TEST TONE”)	75
“VOLUME MENU” parameters (except “INIT. VOL.”)	77
“SOUND MENU” parameters*	78
“VIDEO MENU” parameters	80
“DISPLAY SET” parameters (except “SHORT MESSAGE”)	83
Sound field program (or “Pure Direct”) currently selected	39
Sound field parameter settings	67
Tonal quality control settings*	46

* The settings of “DYNAMIC RANGE”, “LFE LEVEL”, and the tonal quality control for headphones are not saved.

Saving the system settings

■ Saving by the **ⓄSYSTEM MEMORY** buttons

You can save the system settings stored in “MEMORY1” to “MEMORY4” by pressing the corresponding **ⓄSYSTEM MEMORY** buttons.

Press and hold one of the **ⓄSYSTEM MEMORY buttons on the remote control for 4 seconds.**

“MEMORY 1 SAVE Done” (example) appears in the front panel display, and then this unit saves the current system setting to the corresponding memory number.

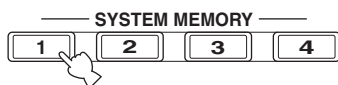

If system settings are already stored in the selected memory number, this unit overwrites the old settings.

■ Saving by the SET MENU operation

You can save the system settings stored in “MEMORY1” to “MEMORY6” by using the “SYSTEM MEMORY” menu in “SET MENU”.

- 1 Set the operation mode selector on the remote control to **ⓂAMP** and then press **ⓂMENU**.**
The top “SET MENU” screen appears in the OSD.
- 2 Press **Ⓜ∇** to select “SYSTEM MEMORY” and then press **ⓂENTER**.**
The “SYSTEM MEMORY” menu appears.
- 3 Press **Ⓜ∇** to select “SAVE” and then press **ⓂENTER**.**
The current system settings are displayed.

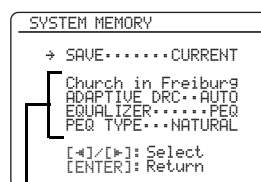

Current system settings

- 4 Press **Ⓜ◀/▶** repeatedly to select the desired memory number (“MEMORY1” to “MEMORY6”).**

The system settings currently stored in the selected memory number are displayed. If the memory number is not in use, “EMPTY” appears.

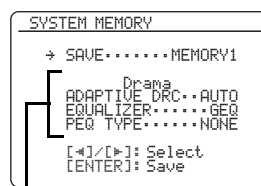

System settings stored in the selected memory number



- If system settings are already stored in the selected memory number, this unit overwrites the old settings.
- To load the system settings with the **ⓄSYSTEM MEMORY** button operation, use one of “MEMORY1” to “MEMORY4”.

- 5 Press **ⓂENTER** to save the current system settings to the selected memory number.**

6 Press **MENU** to exit from “SET MENU”.

Loading the system settings

Note

If you load the system settings, the settings currently configured are overwritten. If you do not want to erase the current settings, save the settings using the SYSTEM MEMORY feature in advance.

■ Loading by the **SYSTEM MEMORY** buttons

You can recall the system settings stored in “MEMORY1” to “MEMORY4” by pressing the corresponding **SYSTEM MEMORY** buttons.

1 Press one of the **SYSTEM MEMORY** buttons on the remote control to select the desired memory number.

“MEMORY 1 LOAD” (example) appears in the front panel display.

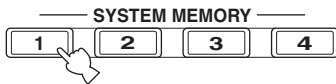

“EMPTY” appears in the menu screen if no system settings are stored in the selected memory number.

2 Press the selected **SYSTEM MEMORY** button once more to confirm the selection.

This unit loads the settings stored in the selected memory number.

■ Loading by the SET MENU operation

1 Set the operation mode selector on the remote control to **AMP** and then press **MENU**.

The top “SET MENU” display appears in the OSD.

2 Press **DOWN** to select “SYSTEM MEMORY” and then press **ENTER**.

The “SYSTEM MEMORY” menu appears.

3 Press **ENTER** to select “LOAD”.

The current system settings are displayed.

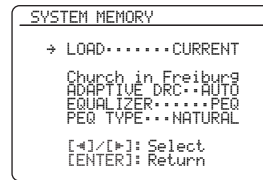

4 Press **LEFT** / **RIGHT** repeatedly to select the desired memory number where the system settings are stored and then press **ENTER**.

This unit loads the selected system settings.

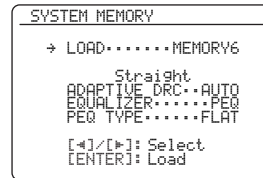

5 Press **MENU** to exit from “SET MENU”.

Using examples

■ Example 1: Comparing the results of the automatic setup and manual setup

This unit is equipped with three types of parametric equalizer settings (page 79), and you can also make your customized configuration of the sound settings of this unit by using the “MANUAL SETUP” parameters (see page 74). To compare the results of the automatic setup or your manual configuration, use the **SYSTEM MEMORY** buttons.

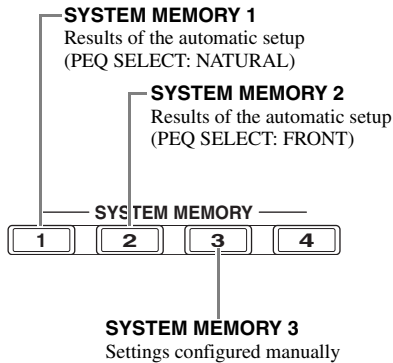

Saving each setting

- 1 Perform the automatic setup (page 30).**
- 2 Press and hold **SYSTEM MEMORY 1** for 4 seconds.**
This unit stores the results of the automatic setup (PEQ SELECT: NATURAL) to “MEMORY1”.
- 3 Set “PEQ SELECT” to “FRONT” (page 79).**
- 4 Press and hold **SYSTEM MEMORY 2** for 4 seconds.**
This unit stores the results of the automatic setup (PEQ SELECT: FRONT) to “MEMORY2”.
- 5 Configure the parameters of “SPEAKER MENU” (page 75) and “GEQ EDIT” (page 78) manually.**
- 6 Press and hold **SYSTEM MEMORY 3** for 4 seconds.**
This unit stores the settings configured manually to “MEMORY3”.

■ Example 2: Switching the settings for different room environments

The tonal characteristics of the listening room may vary depending on the situations of the room (for example, whether the curtains are open or closed), and the settings of this unit should be arranged for each situation of the room. You can switch between the settings of this unit easily by using **SYSTEM MEMORY** buttons.

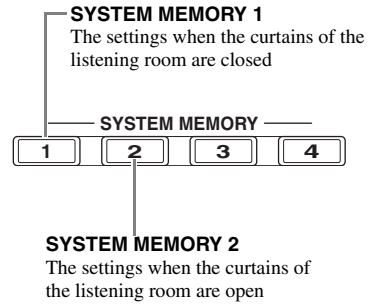

Saving each setting

- 1 Close the curtains of the listening room and then perform the automatic setup (page 30).**
- 2 Press and hold **SYSTEM MEMORY 1** for 4 seconds.**
This unit stores the settings for the current room situation (i.e. the curtains are closed) to “MEMORY1”.
- 3 Open the curtains of the listening room and then perform the automatic setup.**
- 4 Press and hold **SYSTEM MEMORY 2** for 4 seconds.**
This unit stores the current room situation (i.e. the curtains are open) to “MEMORY2”.

Remote control features

In addition to controlling this unit, the remote control can also operate other audiovisual components made by Yamaha and other manufacturers. To control your TV or other components, you must set up the appropriate remote control code for each input source (page 91).

Controlling this unit, a TV, or other components

Controlling this unit

Set the operation mode selector to **AMP** to control this unit.

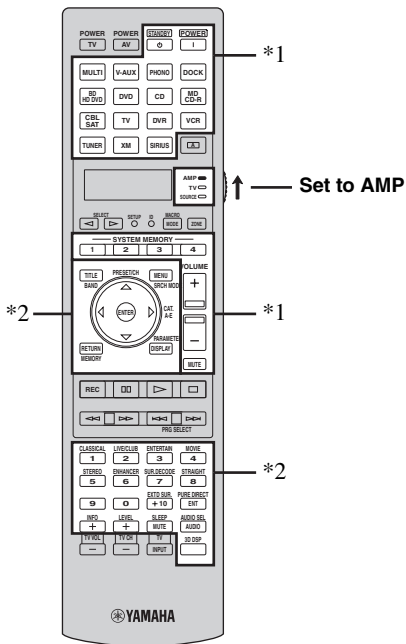

Notes

- *1 These buttons always control this unit regardless of the operation mode selector position.
- *2 These buttons control this unit only when the component operation mode selector is set to **AMP**.

Controlling a TV

Set the operation mode selector to **TV** to control your TV. To control your TV, you must set the appropriate remote control code for the TV operation mode in advance (page 91).



If no code has been set for the TV operation mode, the remote control operates the component that is set to the TV control area (page 91).

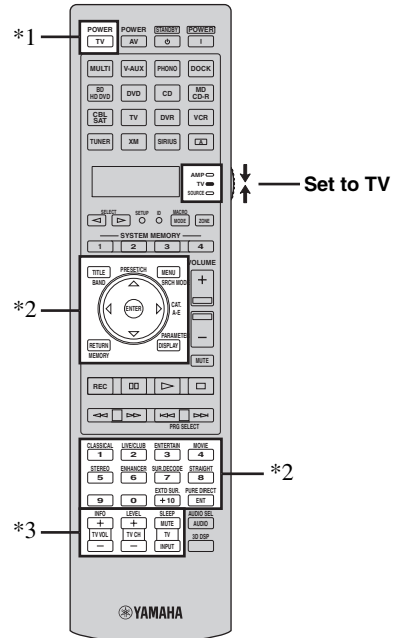

Notes

- *1 **TV POWER** can always turn on or off the power of the TV regardless of the operation mode selector position.
- *2 These buttons control your TV only when the operation mode selector is set to **TV**. For details, see the “TV” column on page 90.
- *3 These buttons control your TV only when the operation mode selector is set to **TV** or **SOURCE**.

Remote control	Functions
TV VOL +/-	Increases or decreases the volume level.
TV CH +/-	Changes the TV channel.
TV MUTE	Mutes the audio output.
TV INPUT	Changes the input source.

■ Controlling other components

Set the operation mode selector to **⑤SOURCE** to control other components selected with the input selector buttons (③) or **A**. You must set the appropriate remote control code for each input source in advance (page 91). The following table shows the function of each control button used to control other components assigned to each input selector button (③) or **A**. Be advised that some buttons may not correctly operate the selected component.



The remote control has 16 modes (input areas) to control components so that the remote control can operate up to 16 different components.

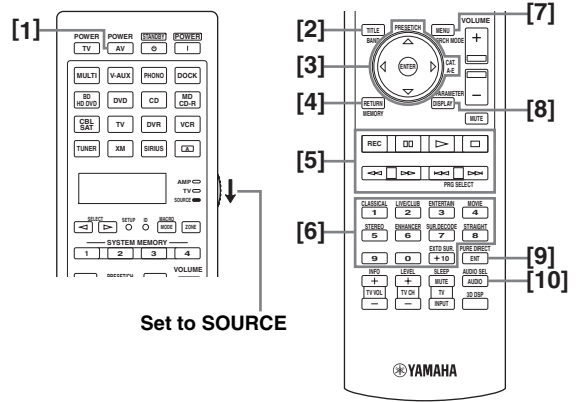

	Blu-ray Disc/ HD DVD player/ recorder	DVD player	LD player	DVD recorder/ Digital video recorder	VCR	TV	Cable TV/ Satellite tuner	CD player	MD recorder/ CD recorder	Tape deck	Tuner
[1] AV POWER	Power *1	Power *1	Power *1	Power *1	Power *1	DVR power *2	Power *1	Power *1	Power *1	Power *1	Power *1
[2] TITLE BAND	Title	Title		Title		Title					Band
[3] PRESET/ CH Δ	Menu up	Menu up		Menu up	Channel up	Menu up	Channel up				Menu up
PRESET/ CH ∇	Menu down	Menu down		Menu down	Channel down	Menu down	Channel down				Menu down
CAT. A-E Δ	Menu left	Menu left		Menu left		Menu left					Menu left
CAT. A-E ∇	Menu right	Menu right		Menu right		Menu right				Direction A/B	Menu right
ENTER	Menu enter	Menu enter		Menu enter		Menu enter					Menu enter
[4] RETURN, MEMORY	Return	Return		Return		Return					Memory
[5] REC	Record (recorder)	Disc skip		Record	Record	DVR record *2	DVR record *2	Disc skip	Record	Record	
⏸	Pause	Pause	Pause	Pause	Pause	DVR pause *2	DVR pause *2	Pause	Pause	Pause	
▶	Play	Play	Play	Play	Play	DVR play *2	DVR play *2	Play	Play	Play	
⏹	Stop	Stop	Stop	Stop	Stop	DVR stop *2	DVR stop *2	Stop	Stop	Stop	
◀◀	Search backward	Search backward	Search backward	Search backward	Search backward	DVR search backward *2	DVR search backward *2	Search backward	Search backward	Search backward	
▶▶	Search forward	Search forward	Search forward	Search forward	Search forward	DVR search forward *2	DVR search forward *2	Search forward	Search forward	Search forward	
⏮	Skip backward	Skip backward	Skip backward	Skip backward	Skip backward	DVR skip backward *2	DVR skip backward *2	Skip backward	Skip backward	Direction A	Audio program down *3
⏭	Skip forward	Skip forward	Skip forward	Skip forward	Skip forward	DVR skip forward *2	DVR skip forward *2	Skip forward	Skip forward	Direction B	Audio program up *3
[6] 1-9, 0, +10	Numeric buttons	Numeric buttons	Numeric buttons	Numeric buttons	Numeric buttons	Numeric buttons	Numeric buttons	Numeric buttons	Numeric buttons	Numeric buttons	Numeric buttons
[7] MENU, SRCH MODE	Menu	Menu		Menu		Menu					Search mode
[8] DISPLAY	Display	Display	Display	Display	Display	Display	Display	Display	Display	Display	Display
[9] ENT	Index	Index	Chapter/ time	Index	Enter	Enter	Enter	Index	Index		Enter
[10] AUDIO	Audio	Audio	Audio	Audio							

Notes

*1 This button is operational only when the original remote control supplied with the component has a power button.

*2 These buttons operate your video recorder (DVD recorder, etc.) only when you set the appropriate remote control code for DVR (page 91).

*3 These functions are used for selecting HD Radio audio programs (U.S.A. model only).

■ Selecting a component to be controlled

You can select a component to be controlled independently of the input source selected with the input selector buttons (3).

Press **5 SELECT** </> repeatedly to select the desired component.

The name of the component to be controlled appears in the display window (4) on the remote control.



■ Controlling optional components (Option mode)

“OPTN1” and “OPTN2” are optional component control areas that can be programmed with remote control functions independently from any input source. These areas are useful for programming commands that are to be used only as a part of a macro function or for components that do not have a valid remote control code.

To select the option mode, press **5 SELECT** </> repeatedly until “OPTN1” or “OPTN2” appears in the display window (4) on the remote control.

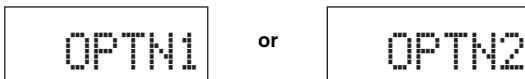

Note

You cannot set a remote control code for the optional areas. See page 93 to program buttons operated within this component control area.

Setting remote control codes

You can control other components by setting the appropriate remote control codes. Codes can be set up for each input area. For a complete list of available remote control codes, refer to “List of remote control codes” at the end of this manual.

The following table shows the default component (Library: component category) and the remote control code for each control area.

Remote control code default settings

Control area	Library (component category)	Manufacturer	Default code
MULTI	DVD	Yamaha	04306
V-AUX	—	—	—
PHONO	—	—	—
DOCK	SOURCE	Yamaha	00012
BD HD DVD	BD	Yamaha	04706
DVD	DVD	Yamaha	04306
CD	CD	Yamaha	01205
MD CD-R	CD-R	Yamaha	01405
CBL SAT	—	—	—
TV	—	—	—
DVR	DVR	Yamaha	00707
VCR	—	—	—
TUNER	SOURCE	Yamaha	00012
XM	SOURCE	Yamaha	00012
SIRIUS	SOURCE	Yamaha	00012
A	—	—	—

Note

You may not be able to operate your Yamaha component even if a Yamaha remote control code is preset as listed above. In this case, try setting another Yamaha remote control code.

1 Check the remote control code for your component in advance.

For a complete list of available remote control codes, see “List of remote control codes” at the end of this manual.

2 Set the operation mode selector on the remote control to **15 SOURCE**.

If you want to set the remote control code for “TV”, set the operation mode selector to **15 TV**.

3 Press **Ⓟ** **SETUP** using a ballpoint pen or similar object.

“SETUP” appears in the display window (④) on the remote control.



Note

In the “SETUP” menu, complete each of the operations within 30 seconds. Otherwise, the remote control automatically exits from the “SETUP” menu.

4 Press **Ⓢ** **▲** / **▼** repeatedly to select “P-SET” and then press **Ⓟ** **ENTER**.

The remote control enters the preset mode. “P-SET” and name of the currently selected control area appears in the display window (④) alternately.



5 Press an input selector button (③) or **Ⓟ** **SELECT** **<** / **>** repeatedly to select the control area you want to customize.

If you selected “TV” in step 2, skip this step.



6 Press **Ⓟ** **ENTER**.

The current code setting appears.



7 Press the numeric buttons (⑩) to enter the five-digit remote control code for your component.

8 Press **Ⓟ** **ENTER** to set the number.

“OK” appears in the display window (④) if setting was successful.

“NG” appears in the display window (④) if the setting was unsuccessful. In this case, start over from step 5.



If you continuously want to set up another code for another control area, repeat steps 5 through 8.

9 Press **Ⓟ** **SETUP** again to exit from the “SETUP” mode.

10 Press **Ⓢ** **AV POWER** or **Ⓟ** **>** to confirm whether you can control your component using the remote control.



- If operation is not possible and the manufacturer of your component has more than one code, try each of them until you find the correct one.
- If you set "00012" as the remote control code of the selected control area, you can operate the currently selected internal source (DOCK, TUNER, XM, or SIRIUS).

Notes

- “ERROR” appears in the display window (④) on the remote control if you press a button not indicated in the respective step, or when you press more than one button simultaneously.
- The supplied remote control does not contain all possible codes for commercially available audio and video components (including Yamaha components). If operation is not possible with any of the remote control codes, program the new remote control function using the learning feature (page 93) or use the remote control supplied with the component.
- Functions programmed using the learning mode take priority over remote control code functions.

Programming codes from other remote controls

You can program remote control codes from other remote controls. Use the learning feature if you want to program functions not included in the basic operations covered by the remote control codes, or an appropriate remote control code is not available. You can program the function of other remote control to the buttons in the highlighted areas in the following illustration. The buttons can be programmed independently for each control area.

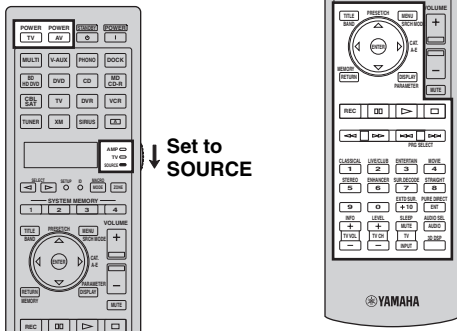

Notes

- The remote control transmits infrared rays. If the other remote control also uses infrared rays, this remote control can learn most of its functions. However, you may not be able to program some special signals or extremely long transmissions.
- You cannot program the desired remote control code even if you select the buttons in the highlighted area in the above illustration depending on the selected control area and the assigned library.

- Set the operation mode selector to **15 SOURCE** and then press an input selector button **(3)** to select the desired control area. If you want to program the remote control code for "TV", set the operation mode selector to **15 TV**.

Note

Make sure that the operation mode selector is set to **15 SOURCE** or **15 TV**. When you set the operation mode selector to **15 AMP** and program a remote control codes from other remote controls, the programmed key cannot operate the amplifier function of this unit.

- Press **16 SETUP** using a ballpoint pen or similar object.

"SETUP" appears in the display window **(4)**.

- Press **8 Δ / ▽** repeatedly to select "LEARN" and then press **8 ENTER**.

- Place this remote control about 5 to 10 cm (2 to 4 in) apart from the other remote control on a flat surface so that their infrared transmitters are aimed at each other and then press **8 ENTER**.

"L-KEY" appears in the display window **(4)**.

Other remote control

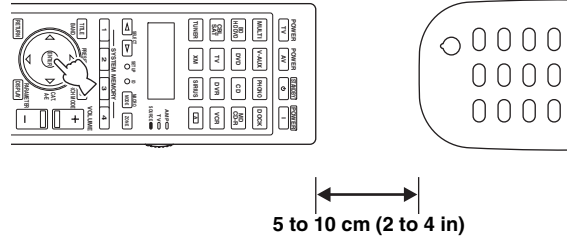

- Press the button for which you want to program the new function.

"START" appears in the display window **(4)**.

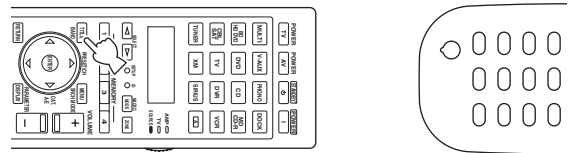

- Press and hold the button you want to program on the other remote control until "OK" appears in the display window **(4)**.

"NG" appears in the display window **(4)** if learning was unsuccessful. In this case, start over from step 4.

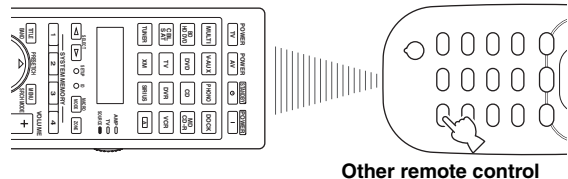

Other remote control



When you want to program another function, repeat steps 4 through 6.

7 Press **Ⓜ** **SETUP** again to exit the setup menu.

Notes

- “ERROR” appears in the display window (④) on the remote control if you press a button not indicated in the respective step, or when you press more than one button simultaneously.
- This remote control can learn approximately 200 functions. However, depending on the signals learned, “FULL” may appear in the display before you program 200 functions. In this case, clear unnecessary programmed functions to make room for further learning (page 97).
- Learning may not be possible in the following cases:
 - when the batteries in the remote control for this unit or other components are weak.
 - when the remote control is exposed to direct sunlight.
 - when the function to be programmed is continuous or uncommon.

Changing source names in the display window

You can change the name of the control area (input source) that appears in the display window (④) on the remote control.

1 Set the operation mode selector to **Ⓜ** **SOURCE** and then press an input selector button (③) to select the desired control area.

2 Press **Ⓜ** **SETUP** using a ballpoint pen or similar object.

“SETUP” appears in the display window.

3 Press **Ⓜ** **Δ** / **∇** repeatedly to select “RNAME” and then press **Ⓜ** **ENTER**.

4 Press **Ⓜ** **Δ** / **∇** repeatedly to select 3-letter name or 5-letter name you want to edit and then press **Ⓜ** **ENTER**.

Each control area has both 3-letter name and 5-letter name. You can rename the 3-letter name and 5-letter name independently.

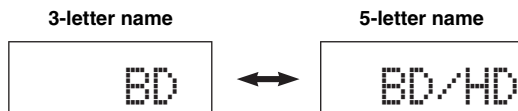

5 Edit the name of the control area.

To locate the position to edit, press **Ⓜ** **<** / **>**.

To select a character, press **Ⓜ** **Δ** / **∇**.



Press **Ⓜ** **Δ** to change the character in the following order, or press **Ⓜ** **∇** to go in the reverse order: A to Z, a to z, 0 to 9, space, symbols (–, +, /, :).

6 Press **Ⓜ** **ENTER** to set the new name.

“OK” appears in the display window (④) on the remote control if renaming was successful.



When you want to rename the another control area, press the input selector button (③) or **Ⓜ** **SELECT** **<** / **>** repeatedly to select the desired control area and then press **Ⓜ** **ENTER** and then carry out the operations of steps 4 through 6.

7 Press **Ⓜ** **SETUP** again to exit the setup menu.

Note

“ERROR” appears in the display window (④) on the remote control if you press a button not indicated in the respective step, or when you press more than one button simultaneously.

Macro programming features

The macro programming feature makes it possible to perform a series of operations with the press of a single button. For example, when you want to play a CD, normally you would turn on the components, select the CD input, and press the play button to start playback. The macro programming feature lets you perform all of these operations simply by pressing the CD macro button. The buttons listed as macro buttons below are factory set with macro programs. You can also program your own macros (page 96).

Recalling programmed macro-operations

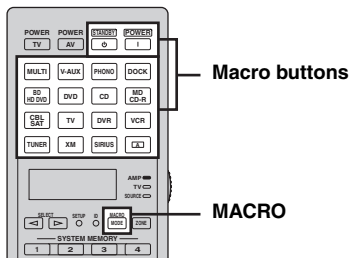

1 Press **MACRO** on the remote control.



2 Press the desired macro button.

"M:the 3-letter name of the selected control area" (for example, "M:DVD") appears in the display window (4), and this unit transmits the programmed functions. When you press **STANDBY** or **POWER**, "M:STB" or "M:PWR" appears in the display window (4), and this unit transmits the programmed functions.

3 Press **MACRO** again to exit from the macro-operation mode.

Notes

- While the remote control is running a macro program (the transmission indicator flashes), it does not accept any other operation.
- Continue to aim the remote control at the component the macro is operating until the macro operation is complete.
- If you do not complete each of the operations within 30 seconds, this unit automatically exits from the macro-operation mode.

Default macro functions

Pressing macro button	To automatically transmit these signals in order	
	First	Second
STANDBY ⓪	STANDBY ⓪	—
POWER I	(POWER) I	POWER (*1) TV
MULTI		MULTI
V-AUX		V-AUX
PHONO		PHONO
DOCK		DOCK
BD HD DVD		BD HD DVD
DVD		DVD
CD		CD
MD CD-R		MD CD-R
CBL SAT		CBL SAT
TV		TV
DVR		DVR
VCR		VCR
TUNER		TUNER (*2)
XM		XM (*2)
SIRIUS		SIRIUS (*2)
CA		CA

*1 Set the appropriate remote control code for TV in advance (page 91).

*2 This unit plays the last received station or selected contents before the unit was set in the standby mode.

■ Programming macro operations

You can program your own macro to transmit several remote control commands in sequence at the press of a button. Be sure to set up remote control codes or perform learning operations before programming the macro.

Notes

- The default macro is not cleared when a new macro is programmed for a button. The default macro can be used again when the programmed macro is cleared.
- It is not possible to add a new signal (macro step) to the default macro. Programming a macro changes all macro contents.
- We do not recommend that you program continuous operations (for example, volume control) in a macro.

1 Press **Ⓟ** **SETUP** using a ballpoint pen or similar object.

“SETUP” appears in the display window (④).

2 Press **Ⓢ** **Δ** / **∇** repeatedly to select “MACRO” and then press **Ⓢ** **ENTER**.

3 Press the desired macro button you want to assign the macro program to and then press **Ⓢ** **ENTER**.

“M:the three-letter name of the selected macro button” (for example, “M:DVD”) and the name of the currently selected control area appears in the display window (④) alternately.

When you press **Ⓢ** **STANDBY** or **Ⓢ** **POWER**, “M:STB” or “M:PWR” and the name of the currently selected control area appears in the display window (④) alternately.

4 Press the buttons for the functions you want to include in the macro operation in sequence.

Example

Set the input source to DVD → Turn on the DVD player → Turn on the video monitor

Step 1 (“MCR1”): Press DVD.

Step 2 (“MCR2”): Press AV POWER.

Step 3 (“MCR3”): Press TV POWER.

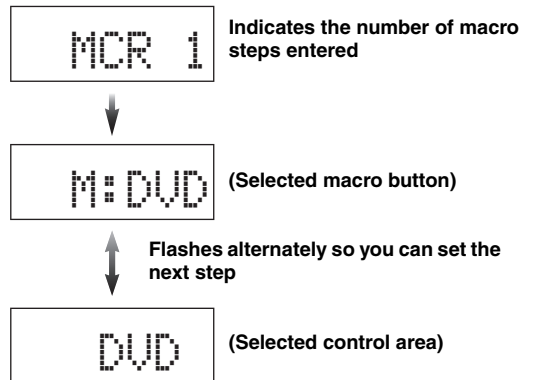
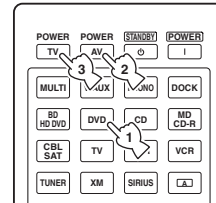

Notes

- To change the selected input area, press **Ⓢ** **SELECT** **</>**. Pressing the input selector buttons will program a macro step, whereas **Ⓢ** **SELECT** **</>** only changes the selected input area.
- The position of the operation mode selector (AMP/TV/SOURCE) affects the assigned function. When the operation mode selector is set to **Ⓢ** **AMP** or **Ⓢ** **TV**, the input source selectors do not function.

5 Press **Ⓢ** **MACRO** to confirm the program.

You can set up to 10 steps (10 functions). After you have set 10 steps, “FULL” appears and the remote control automatically exits from the macro programming mode.

6 Press **Ⓟ** **SETUP** again to exit from the setup mode.

Note

“ERROR” appears in the display window (④) if you press more than one button simultaneously.

Clearing configurations

You can clear all changes made in each function set, such as learned functions, macros, renamed control area names and setup remote control ID.

■ Clearing function sets

1 Press **Ⓜ** **SETUP** using a ballpoint pen or similar object.

“SETUP” appears in the display window (④).

2 Press **Ⓜ** **Δ** / **∇** repeatedly to select “CLEAR” and then press **Ⓜ** **ENTER**.

3 Press **Ⓜ** **Δ** / **∇** repeatedly to select the desired clear mode.

Clear mode	Descriptions
L: DVD (etc.)	(L: Three-digit name of the selected control area) Clears all learned functions the respective control area. You can change the control area to be cleared by pressing the desired input selector button (③) or Ⓜ SELECT < / > repeatedly.
L: AMP	Sets all learned functions for controlling the amplifier functions to the initial factory settings. Set the operation mode selector to Ⓜ AMP to select this clear mode.
L: TV	Clears all learned functions for TV control area. Set the operation mode selector to Ⓜ TV to select this clear mode.
L: ALL	Clears all learned functions.
M: DVD (etc.)	(M: Name of the selected macro button) Clears the macro programmed for the selected macro button (page 96). The assigned macro to the selected macro button reverts to the initial factory macro. Press the desired macro button if you want to change the macro button you want to clear the programmed functions of.
M: ALL	Clears all programmed macros. The assigned macro to the selected macro button reverts to the initial factory macro.
RNAME	Set all the name of the control areas to the default settings.
FCTRY	Set all settings of the remote control to the initial factory settings.

4 Press and hold **Ⓜ** **ENTER** for about 3 seconds.

When the clearing is successful, “OK” appears in the display window (④).

Notes

- “NG” appears in the display window (④) if clearing was unsuccessful.
- “ERROR” appears in the display window (④) if you press a button not indicated in the respective step, or if you press more than one button simultaneously.

5 Press **Ⓜ** **SETUP** again to exit from the setup mode.

■ Clearing a learned function

1 Press **Ⓜ** **SETUP** using a ballpoint pen or similar object.

“SETUP” appears in the display window (④).

2 Press **Ⓜ** **Δ** / **∇** repeatedly to select “ERASE” and then press **Ⓜ** **ENTER**.

3 Set the operation mode selector to **Ⓜ** **SOURCE** and then press an input selector button (③).

If you want to erase the function learned in the AMP or TV control area, set the operation mode selector to **Ⓜ** **AMP** or **Ⓜ** **TV**.

4 Press **Ⓜ** **ENTER**.

“E-KEY” appears in the display window (④).

5 Press and hold the button you want to clear for about 3 seconds.

If clearing is successful, “OK” appears in the display window (④).



- If you continuously want to clear another function, repeat step 3 through 5.
- Once you clear a learned function, the button reverts to the factory setting (or to the manufacturer setting if you have set remote control codes).

6 Press **Ⓜ** **SETUP** again to exit from the setup mode.

Notes

- “NG” appears in the display window (④) on the remote control if clearing was unsuccessful.
- “ERROR” appears in the display window (④) if you press more than one button simultaneously.

Simplified remote control

Use the supplied simplified remote control to make basic controls of this unit.

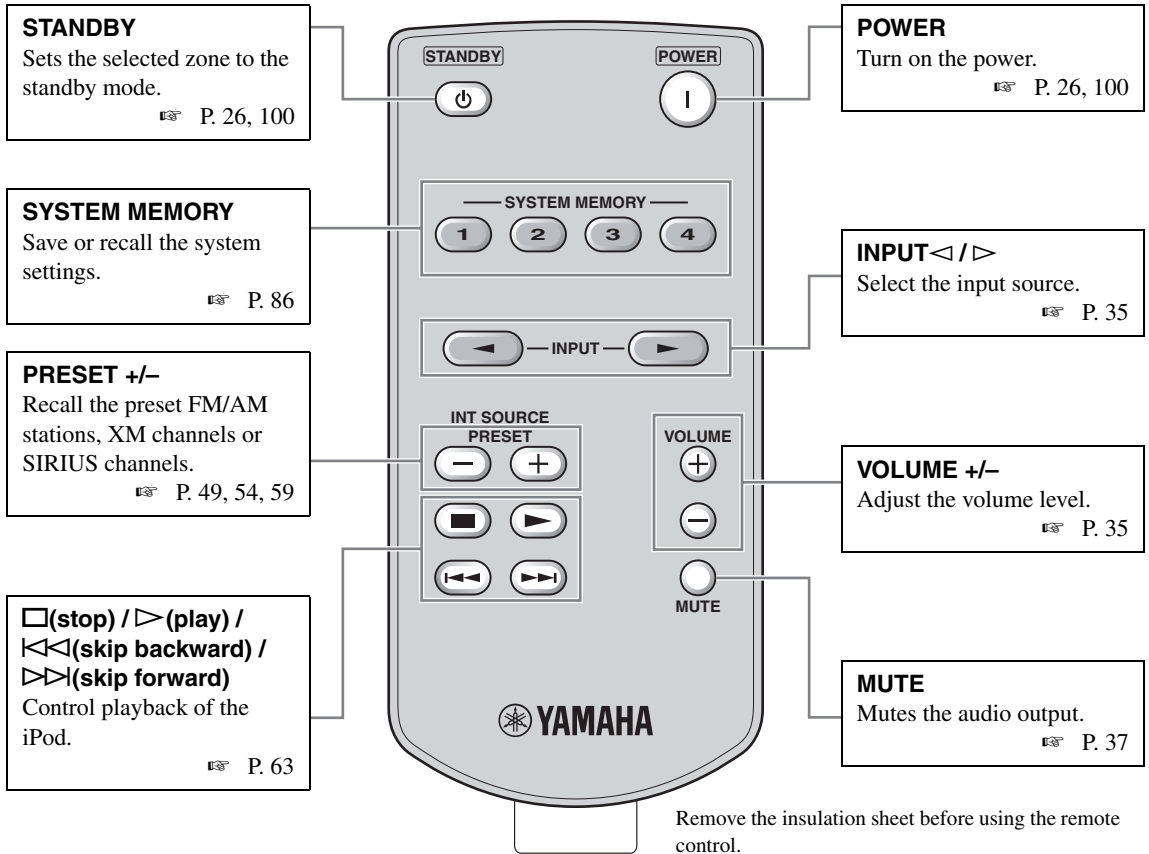

■ Setting the controlling zone of the simplified remote control

Use this feature to set the controlling zone (page 100) and remote control ID (page 102) of the simplified remote control.

Setting the remote control ID

- ID1: Press and hold <<< and 1 for 3 seconds.
- ID2: Press and hold <<< and 2 for 3 seconds.

Setting the controlling zone

- Main zone: Press and hold >>> and 1 for 3 seconds.
- Zone 2: Press and hold >>> and 2 for 3 seconds.
- Zone 3: Press and hold >>> and 3 for 3 seconds.

■ Replacing the battery in the simplified remote control

Change the battery when the operation range of the simplified remote control decreases.

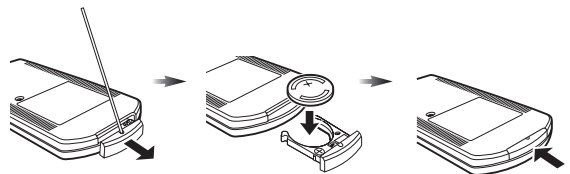

Use a straight pin to remove the cover.

Replace the battery with a new CR2025 battery.

Close the cover.

Notes

- Insert the battery according to the polarity markings (+ and -).
- If the batteries run out, immediately remove them from the simplified remote control to prevent an explosion or acid leak.
- If a battery starts leaking, dispose of it immediately. Be careful not to let the leaking battery acid touch your skin or clothing.
- Before inserting new batteries, wipe the compartment clean.
- Dispose of batteries according to your regional regulations.

Using multi-zone configuration

This unit allows you to configure a multi-zone audio system. The multi-zone configuration feature enables you to set this unit to reproduce separate input sources in the main zone, second zone (Zone 2) and third zone (Zone 3). You can control this unit from the second or third zone using the supplied remote control.

Only analog signals are sent to the second and third zones. Any source you want to listen to in the second zone and third zone must be connected to the analog AUDIO IN jacks of this unit.

Connecting the Zone 2 and Zone 3 components

You need the following additional equipment to use the multi-zone functions of this unit:

- An infrared signal receiver in the second zone and/or third zone.
- An infrared signal emitter in the main zone. This emitter transmits the infrared signals from the remote control via the infrared signal receiver in the second zone and/or third zone to a CD player or a DVD player, etc. in the main zone.
- An amplifier and speakers in the second zone and/or third zone.



- Since there are many possible ways to connect and use this unit in a multi-zone configuration, we recommend that you consult with your nearest authorized Yamaha dealer or service center about the Zone 2 and Zone 3 connections that best meet your requirements.
- Some Yamaha models are able to connect directly to the REMOTE jacks of this unit. If you own these products, you may not need to use an infrared signal emitter. Up to 6 Yamaha components can be connected as shown below.

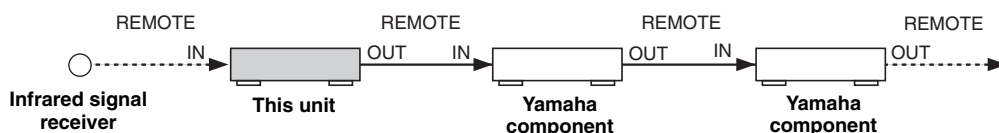

■ Using external amplifiers

To use an external amplifier in the second zone and/or third zone, connect the external amplifier to ZONE OUT jacks and set "AMP" to "EXT" (page 85).

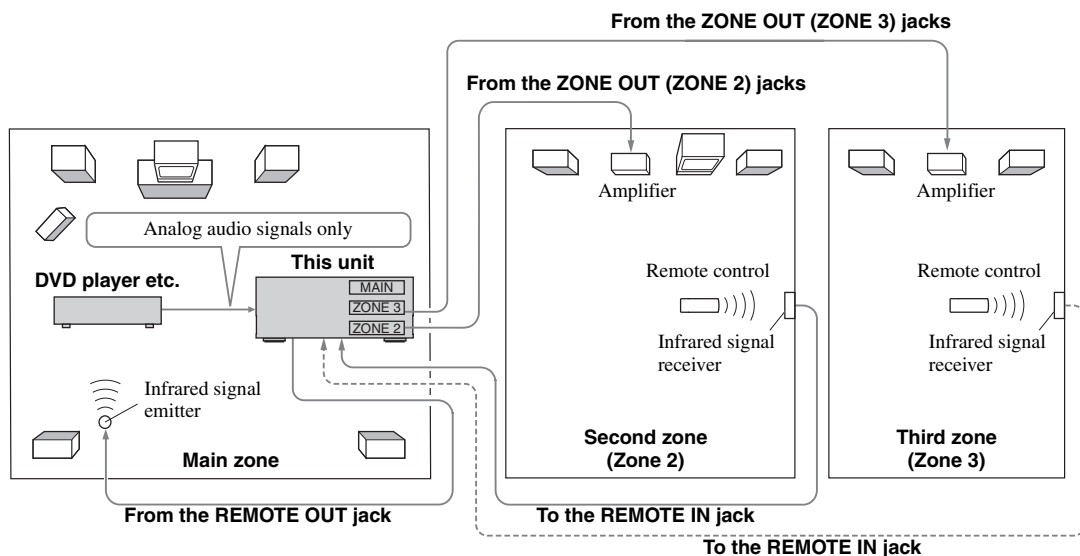

Notes

- To avoid unexpected noise, DO NOT use the Zone 2/Zone 3 feature with CDs encoded in DTS.
- Adjust the the second zone and/or third zone volume by using the amplifier in each zone when "VOLUME" are set to "FIX" (page 85).

■ Using the internal amplifiers of this unit

Important safety notice

The SP1 or SP2 speaker terminals of this Receiver should not be connected to a Passive Loudspeaker Selector Box or more than one loudspeaker per channel.

Connection to a Passive Loudspeaker Selector Box or multiple speakers per channel could create an abnormally low impedance load resulting in amplifier damage. See this owner's manual for correct usage.

Compliance with minimum speaker impedance information for all channels must be maintained at all times. This information is found on the back panel of your Receiver.

If you want to use one internal amplifier (SP1 or SP2) of this unit

Connect the Zone 2 or Zone 3 speakers directly to the SP1 or SP2 speaker terminals and set "AMP" to "[SP1]" or "[SP2]" (page 85).

If you want to use two internal amplifiers (SP1 and SP2) of this unit

Connect the Zone 2 and Zone 3 speakers directly to the SP1 and SP2 speaker terminals and set "AMP" to "BOTH" (page 85).

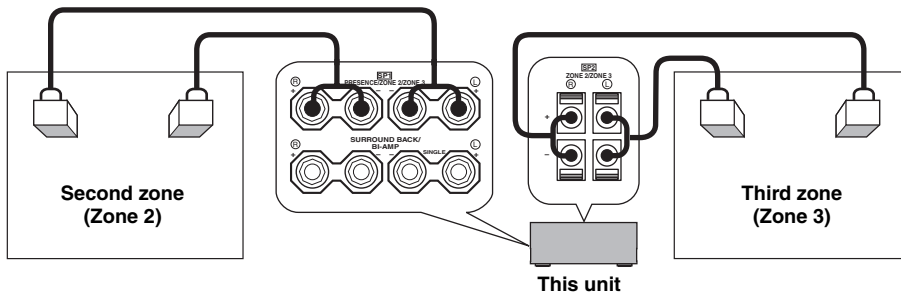

Controlling Zone 2 or Zone 3

You can select the zone you want to control by using the control buttons on the front panel or on the remote control.

■ Basic operation

Front panel operations

1 Press **ⓈZONE 2** or **ⓈZONE 3** on the front panel to individually turn on or off Zone 2 or Zone 3.

2 Press **ⓈZONE CONTROLS** on the front panel repeatedly to select the zone you want to control.

Each time you press **ⓈZONE CONTROLS**, the front panel display changes as shown below, and the indicator for the currently selected zone flashes for approximately 10 seconds. However, no indicator flashes when the main zone is selected.

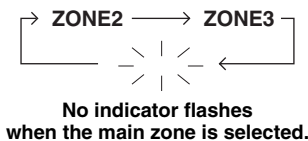

ZONE2

Controls the Zone 2 amplifier or tuner functions.

ZONE3

Controls the Zone 3 amplifier or tuner functions.



You must complete this step within 10 seconds while the selected zone flashes in the front panel display. Otherwise, the currently selected zone mode is automatically canceled.

3 Perform the desired operation in the selected zone (page 101).



To turn off the desired zone, press **ⓈZONE 2** or **ⓈZONE 3** again.

Remote control operations

1 Press **ⓈZONE** repeatedly to select the zone you want to control.

"MAIN", "ZONE 2", or "ZONE 3" indicator appears in the display window (④) on the remote control.



2 Press **Ⓜ POWER** to turn on the selected zone.

3 Perform the desired operation in the selected zone (page 101).



To turn off the desired zone, press **Ⓜ STANDBY**.

■ Selecting the input source of Zone 2 or Zone 3

Rotate the **Ⓢ INPUT** selector (or set the operation mode selector to **Ⓜ AMP** and then press one of the input selector buttons (**Ⓢ**)).

- Select “TUNER” as the input source to use the FM/AM tuning features (page 47) in the selected zone.
- Select “XM” as the input source to use the XM Satellite Radio features (page 52) in the selected zone.
- Select “SIRIUS” as the input source to use the SIRIUS Satellite Radio features (page 57) in the selected zone.
- Select “DOCK” as the input source to use the iPod features (page 63) or Bluetooth features (page 65) in the selected zone.

Note

The input sources are shared across all zones. You cannot select the same input source in multiple zones simultaneously.

■ Adjusting the volume level of Zone 2 or Zone 3

Rotate **Ⓢ VOLUME** (or press **Ⓜ VOLUME +/-**).



Press **Ⓜ MUTE** on the remote control to mute the sound output to the selected zone.

Note

When you use the external amplifiers in Zone 2 or Zone 3, **Ⓜ VOLUME +/-** can be used only when “VOLUME” is set to “VAR” in “ZONE SET” (page 85).

■ Adjusting the front speaker balance of Zone 2 or Zone 3

Press **Ⓢ TONE CONTROL** repeatedly to select “BALANCE” and then rotate the **Ⓢ PROGRAM** selector for adjustment.

■ Adjusting the tonal quality of Zone 2 or Zone 3

Press **Ⓢ TONE CONTROL** repeatedly to select the high-frequency response (TREBLE) or the low-frequency response (BASS) and then rotate the **Ⓢ PROGRAM** selector for adjustment.

Control range: -10.0 dB to +10.0 dB

■ Setting the sleep timer for Zone 2 or Zone 3

Use this feature to turn off the desired zone after a certain amount of time.

Set the operation mode to **Ⓜ AMP** and then press **Ⓜ SLEEP** repeatedly to set the amount of time.

The sleep timer setting changes as shown below.

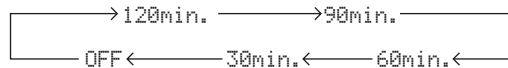

Advanced setup

This unit has additional menus that are displayed in the front panel display. The advanced setup menu offers additional operations to adjust and customize the way this unit operates. Change the initial settings (indicated in bold under each parameter) to reflect the needs of your listening environment.

Notes

- Only **ⒶMASTER ON/OFF**, **ⓄSTRAIGHT** and the **ⓃPROGRAM** selector are effective while you are using the advanced setup menu.
- All the other operations cannot be made while you are using the advanced setup menu.
- The advanced setup menu is only available in the front panel display.

Using the advanced setup menu

- 1 Press **ⒶMASTER ON/OFF** on the front panel to release it outward to the **OFF** position to turn off this unit.
- 2 Press and hold **ⓄSTRAIGHT** and then press **ⒶMASTER ON/OFF** inward to the **ON** position to turn on this unit.
This unit turns on, and “ADVANCED SETUP” appears in the front panel display.



- 3 Rotate the **ⓃPROGRAM** selector to select the parameter you want to adjust.
- 4 Press **ⓄSTRAIGHT** repeatedly to change the selected parameter setting.
- 5 Press **ⒶMASTER ON/OFF** to release it outward to the **OFF** position to save the new setting and turn off this unit.



The settings you made are reflected next time you turn on this unit.

■ Speaker impedance **SPEAKER IMP.**

Use this feature to set the speaker impedance of this unit so that it matches that of your speakers.

Choice	Descriptions
8ΩMIN	Select this setting to set the speaker impedance to 8 Ω. The impedance of each speaker must be 8 Ω or higher.
6ΩMIN	Select this setting to set the speaker impedance to 6 Ω. The impedance of each speaker must be 6 Ω or higher (front speakers only: 4 Ω or higher).

■ Remote sensor **REMOTE SENSOR**

Use this feature to activate or deactivate the signal-receiving capability of the remote control sensor on the front panel of this unit.

Choice	Descriptions
ON	Select this setting if you want to activate the signal-receiving capability of the remote control sensor.
OFF	Select this setting if you want to deactivate the signal-receiving capability of the remote control sensor.

Note

We recommend setting the parameter to “ON” in most cases.

■ Wake on RS-232C access

RS-232C STANDBY

Use this feature to set this unit to transmit data via the RS-232C interface when this unit is in the standby mode.

Choice	Functions
YES	Select this setting to set this unit to transmit data via the RS-232C interface.
NO	Select this setting to set this unit not to transmit data via the RS-232C interface.

Initial setting:

[U.S.A. and Canada models]: YES

[Other models]: NO

■ Remote control ID setting

REMOTE CON AMP

Use this feature to set the remote control ID of this unit for remote control recognition.

Choice	Descriptions
ID1	Select this setting when the ID of the remote control is set to “ID1”
ID2	Select this setting when the ID of the remote control is set to “ID2”

Setting remote control ID

Use this feature to set the remote control ID. This feature is useful when you control multiple Yamaha AV receiver or amplifier with using the remote control.

Press **ⓂID** repeatedly using a ballpoint pen or similar object on the remote control to select the desired remote control ID.

Each time you press **ⓂID**, the remote control ID indicator changes as shown below.

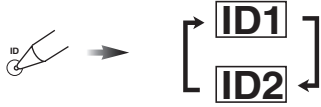

To set the remote control ID of the simplified remote control, see page 98 for details.

■ SIRIUS Satellite Radio Parental Lock code number reset **SIRIUS PIN (U.S.A. and Canada models only)**

Use this feature to set the code number for the SIRIUS Satellite Radio Parental Lock feature to the initial factory setting.

Choice	Descriptions
RESET	Sets the code number to the initial factory setting.
CANCEL	Cancels the reset of the code number.

■ Tuner frequency step **TUNER FRQ STEP (Asia and General models only)**

Use this feature to set the tuner frequency step according to the frequency spacing in your area.

Choice	Descriptions
AM10/ FM100	Select this setting for North, Central and South America.
AM9/FM50	Select this setting for all other countries.

■ Bi-amplifier mode **BI-AMP**

Use this feature to activate or deactivate the bi-amplifier function.

Choice	Descriptions
ON	Select this setting if you want to activate the bi-amplifier function.
OFF	Select this setting if you want to deactivate the bi-amplifier function.

Note

When “BI-AMP” is set to “ON”, the SURROUND BACK terminals cannot be used to connect surround back speakers in that the terminals are already used for the bi-amplifier connection (page 15).

■ Parameter initialization **INITIALIZE**

Use this feature to reset the parameters of this unit to the initial factory settings. You can select the category of parameters to be initialized.

Choice	Descriptions
DSP PARAM	Select this setting to initialize all the parameters of the sound field parameters (page 67).
VIDEO	Select this setting to initialize all the parameters in “VIDEO MENU” and “OSD SHIFT” and “GRAY BACK” in “DISPLAY SET”.
ALL	Select this setting to initialize all the parameters of this unit.
CANCEL	Select this setting to cancel the initialization procedure.



To initialize the parameters of each sound field program, use “INITIALIZE” in the sound field program menu (page 67).

■ HDMI monitor check **MONITOR CHECK**

Use this feature to activate or deactivate the monitor check function of this unit.

Choice	Descriptions
YES	This unit receives the information of the available video signal resolutions from the video monitor connected via HDMI and you can only select the resolutions supported by the video monitor in “HDMI RES.” (page 81).
SKIP	You can select any resolution in “HDMI RES.” (page 81).

Troubleshooting

Refer to the table below when this unit does not function properly. If the problem you are experiencing is not listed below or if the instruction below does not help, turn off this unit, disconnect the power cable, and contact the nearest authorized Yamaha dealer or service center.

■ General

Problem	Cause	Remedy	See page
This unit fails to turn on or enters the standby mode soon after the power is turned on.	The power cable is not connected or the plug is not completely inserted.	Connect the power cable firmly.	—
	The speaker impedance setting is incorrect.	Set the speaker impedance to match your speakers.	26
	The protection circuitry has been activated.	Make sure that all speaker wire connections on this unit and on all speakers are secure and that the wire for each connection does not touch anything other than its respective connection.	13
	This unit has been exposed to a strong external electric shock (such as lightning or strong static electricity).	Turn off this unit, disconnect the power cable, plug it back in after 30 seconds and then use it normally.	—
No sound.	Incorrect input or output cable connections.	Connect the cables properly. If the problem persists, the cables may be defective.	19-24
	Audio input jack select is set to “HDMI”, “COAX/OPT” or “ANALOG”.	Set the audio input jack select to “AUTO”.	36
	Audio input jack select is set to “ANALOG” while the input source component outputs digital audio signals.	Set the audio input jack select to “AUTO” or “COAX/OPT”.	36
	No appropriate input source has been selected.	Select an appropriate input source with the Ⓒ INPUT selector (or the input selector buttons (Ⓒ)).	35, 36
	Speaker connections are not secure.	Secure the connections.	13
	The volume is turned down or muted.	Turn up the volume.	—
	Signals this unit cannot reproduce are being input from a source component, such as a CD-ROM.	Play a source whose signals can be reproduced by this unit.	—
	The HDMI components connected to this unit do not support the HDCP copy protection standards.	Connect HDMI components that support the HDCP copy protection standards.	17

Problem	Cause	Remedy	See page
No picture.	The output and input for the picture are connected to different types of video jacks.	Set "VIDEO CONV." to "ON" or connect your source components in the same way as you connect your video monitor to this unit.	80
	1080p-resolution analog video signals are only output at the COMPONENT VIDEO MONITOR OUT jacks.	Connect your video monitor to the COMPONENT VIDEO MONITOR jacks.	19
	480p-, 576p-, 1080i- and 720p-resolution video signals cannot be output at the S VIDEO and VIDEO MONITOR OUT jacks.	Connect your video monitor to the HDMI OUT or COMPONENT VIDEO MONITOR OUT jacks.	—
	This unit outputs the video signals are not supported on the video monitor connected to the HDMI OUT jack.	Select "INITIALIZE" in "VIDEO" to reset the video parameters.	103
		Set "MONITOR CHECK" to "YES".	103
	Pure Direct mode is active.	Turn off the Pure Direct mode.	46
Short message displays do not appear on the video monitor.	"SHORT MESSAGE" is set to "OFF".	Set "SHORT MESSAGE" to "ON".	84
	"GRAY BACK" is set to "OFF".	Set "GRAY BACK" to "AUTO".	83
	"VIDEO CONV." is set to "OFF".	Set "VIDEO CONV." to "ON".	80
	The signals input at the HDMI input jacks are being output at the HDMI OUT jack.		
The sound suddenly goes off.	The protection circuitry has been activated because of a short circuit, etc.	Check that the speaker impedance setting is correct.	26, 102
		Check that the speaker wires are not touching each other and then turn this unit back on.	—
Sound is heard from the speaker on one side only.	The sleep timer has turned off this unit.	Turn on this unit, and play the source again.	—
	Incorrect cable connections.	Connect the cables properly. If the problem persists, the cables may be defective.	13
Only the center speaker outputs substantial sound.	The speaker level settings are incorrect.	Adjust "LEVEL" settings.	76
		When playing a monaural source with a CINEMA DSP program, the source signal is directed to the center channel, and the front and surround speakers output effect sounds.	
No sound is heard from the center speaker.	"CENTER SP" in "CONFIG" is set to "NONE".	Set "CENTER SP" to "SMALL" or "LARGE".	75
No sound is heard from the presence speakers.	This unit is in the "STRAIGHT" mode.	Press Ⓢ STRAIGHT to turn off the "STRAIGHT" mode.	45
	You are using a source or program combination that does not output sound from all channels.	Try another sound field program.	35

Problem	Cause	Remedy	See page
No sound is heard from the surround speakers.	"SUR. L/R SP" in "CONFIG" is set to "NONE".	Set "SUR. L/R SP" to "SMALL" or "LARGE".	75
	This unit is in the "STRAIGHT" mode and a monaural source is being played back.	Press STRAIGHT to turn off the "STRAIGHT" mode.	45
	The surround speakers are connected to the SURROUND BACK speaker terminals.	Connect the surround speakers to the SURROUND speaker terminals.	45
No sound is heard from the subwoofer.	"LFE/BASS OUT" in "CONFIG" is set to "FRONT" when a Dolby Digital or DTS signal is being played.	Set "LFE/BASS OUT" to "SWFR" or "BOTH".	75
	"LFE/BASS OUT" in "CONFIG" is set to "SWFR" or "FRONT" when a 2-channel source is being played.	Set "LFE/BASS OUT" to "BOTH".	75
	The source does not contain low-frequency signals.		
No sound is heard from the surround back speakers.	"SUR.B L/R SP" is set to "NONE".	Check whether "SUR. L/R SP" is set to "SMALL" or "LARGE" and configure "SUR.B L/R SP" properly.	75, 76
	While this unit is in the CINEMA DSP 3D mode, no sound is output at the surround back speakers.		
The audio input sources cannot be played in the desired digital audio signal format (Desired input source indicator or decoder indicator in the front panel display does not light up).	The connected component is not set to output the desired digital audio signals.	Make an appropriate setting following the operating instructions for your component.	—
	Audio input jack select is set to "ANALOG".	Set the audio input jack select to "AUTO".	36
A humming sound is heard.	Incorrect cable connections.	Connect the audio cables firmly. If the problem persists, the cables may be defective.	—
	No connection from the turntable to the GND terminal.	Connect the grounding cable of the turntable to the GND terminal of this unit.	22
The volume level is low while a record is being played.	The record is being played on a turntable with an MC cartridge.	Connect your turntable to this unit through an MC-head amplifier.	22
The volume level cannot be increased, or the sound is distorted.	The component connected to the AUDIO OUT (REC) jacks of this unit is turned off.	Turn on the power of the component.	—
A source cannot be recorded by the recording component.	The audio source connected to the MULTI CH INPUT jacks of this unit cannot be recorded.		
	A given input source is not output at the same output channel (e.g. DVR IN to DVR OUT).	Connect the recording component to another channel that is not being used for connecting the source component.	21
	You are trying to record a DTS source. (DTS signal is a digital bitstream. Attempting to record the DTS bitstream digitally will result in noise being recorded.)	Make a setting so that the analog signal will be output from your DTS-compatible player and then connect the DTS-compatible player to the AUDIO IN jacks while the recording component is connected to the analog AUDIO OUT (DVR, VCR or MD/CD-R) jacks.	21

Problem	Cause	Remedy	See page
An audio source cannot be recorded by the digital recording component connected to the DIGITAL OUTPUT jacks.	The audio source component is not connected to the DIGITAL INPUT jacks.	Connect the audio source component to the DIGITAL INPUT jacks.	21
	Some components cannot records Dolby Digital or DTS sources.		
	You are trying to record an audio source input at the DOCK terminal by the digital recording component connected to the DIGITAL OUTPUT jacks.	Connect the recording component to the analog AUDIO OUT (DVR, VCR or MD/CD-R) jacks.	21
	(U.S.A. model only) HD Radio signals are not output at the DIGITAL OUTPUT jacks	Connect the recording component to the analog AUDIO OUT (DVR, VCR or MD/CD-R) jacks.	21
An audio source cannot be recorded by the analog recording component connected to the analog AUDIO OUT (DVR, VCR or MD/CD-R) jacks.	The audio source component is not connected to the analog AUDIO IN jacks.	Connect the audio source component to the AUDIO IN jacks.	21
	XM Satellite Radio and SIRIUS Satellite Radio signals are not output at the analog AUDIO OUT (DVR, VCR or MD/CD-R) jacks.		
Recorded materials sound differently.	The settings made on this unit (such as tonal quality, volume level and sound field programs) do not affect recorded material.		
A video source cannot be recorded by the recording component.	"VIDEO CONV." is set to "ON".	While "VIDEO CONV." is set to "ON", video signals are output only at the MONITOR OUT jacks. To record a video source by the recording component, set "VIDEO CONV." to "OFF" and make the same type of video connections between each component (e.g. VCR IN (S VIDEO) to DVR OUT (S VIDEO)).	21, 80
The sound field parameters and some other settings of this unit cannot be changed.	"MEMORY GUARD" in "SET MENU" is set to "ON".	Set "MEMORY GUARD" to "OFF".	84
This unit does not operate properly.	The internal microcomputer has been frozen by an external electric shock (such as lightning or excessive static electricity) or by a power supply with low voltage.	Disconnect the power cable from the AC wall outlet and then plug it in again after about 30 seconds.	—
"CHECK SP WIRES" appears in the front panel display.	Speaker cables are short-circuited.	Make sure all speaker cables are connected correctly.	13
There is noise interference from digital or radio frequency equipment.	This unit is too close to the digital or high-frequency equipment.	Move this unit further away from such equipment.	—
The picture is disturbed.	The video source uses scrambled or encoded signals to prevent dubbing.		
This unit suddenly enters the standby mode.	The internal temperature becomes too high and the overheat protection circuitry has been activated.	Wait about 1 hour for this unit to cool down and then turn it back on.	—

■ HDMI

Problem	Cause	Remedy	See page
No picture or sound.	The number of the connected HDMI components is over the limit.	Reduce the number of the connected HDMI components.	—
	HDCP authentication failed.	Check that the connected HDMI components support the HDCP copy protection standards.	—

■ Tuner (FM/AM)

Problem	Cause	Remedy	See page	
FM	FM stereo reception is noisy.	The characteristics of FM stereo broadcasts may cause this problem when the transmitter is too far away or the antenna input is poor.	Check the antenna connections.	24
			Try using a high-quality directional FM antenna.	—
			Use the manual tuning method.	47
	There is distortion, and clear reception cannot be obtained even with a good FM antenna.	There is multi-path interference.	Adjust the antenna position to eliminate multi-path interference.	—
The desired station cannot be tuned into with the automatic tuning method.	The signal is too weak.	Use a high-quality directional FM antenna.	—	
		Use the manual tuning method.	47	
Previously preset stations can no longer be tuned into.	This unit has been disconnected for a long period.	Preset the stations again.	48	
AM	The desired station cannot be tuned into with the automatic tuning method.	The signal is weak or the antenna connections are loose.	Tighten the AM loop antenna connections and orient it for the best reception.	24
			Use the manual tuning method.	47
	There are continuous crackling and hissing noises.	Supplied AM loop antenna is not connected.	Connect the AM loop antenna correctly even if you use an outdoor antenna.	24
		Noises can result from lightning, fluorescent lamps, motors, thermostats and other electrical equipment.	Use an outdoor antenna and a ground wire. This will help somewhat, but it is difficult to eliminate all noise.	24
There are buzzing and whining noises.	A TV set is being used nearby.	Move this unit away from the TV set.	—	

■ HD Radio (U.S.A. model only)

Problem	Cause	Remedy	See page
This unit cannot receive the HD Radio signals of the selected radio station.	The radio station provides analog FM/AM radio service only.	Select other radio stations that provides the HD Radio service.	47
	The signal is too weak.	Adjust the antenna position.	—
		Use a high-quality FM/AM antenna.	—
This unit cannot select other audio programs than the main program.	The radio station provides an audio program only.		
HD Radio information does not appear.	The radio station does not provide the information.		

■ XM Satellite Radio

If an operation takes longer than usual or an error occurs, one of the following messages may appear in the front panel display. In this case, read the cause and follow the corresponding remedies.

Status message	Cause	Remedy	See page
CHECK XM TUNER	The XM Mini-Tuner is not installed in the XM Mini-Tuner Home Dock or the is not connected to this unit.	Confirm the XM Mini-Tuner is fully seated in the dock and check the XM Mini-Tuner Home Dock cable is connected to this unit.	52
CHECK ANTENNA	The XM antenna is not connected to the XM Mini-Tuner Home Dock or the XM antenna cable has become damaged.	Check that the XM antenna is securely connected to the XM Mini-Tuner Home Dock and check the antenna cable for damage. Replace the XM antenna if the cable is damaged.	52
LOADING	The XM Mini-Tuner is acquiring audio or program information from the XM satellite signal. This message can also occur in weak XM signal conditions. Note that this unit may not respond to some operations while this message is displayed.	This message should disappear in a few seconds in good signal conditions. If you see this message often, reposition the XM antenna to get better signal reception. Use the "ANTENNA INFO" information in the front panel or "XM Information" screen in the OSD to check the antenna reception level.	56
NO SIGNAL	The XM Mini-Tuner is not receiving the XM satellite signal. Something may be blocking the XM antenna's view of the satellites or the antenna is not properly aimed.	Check for antenna obstructions and reposition the XM antenna to get better signal reception. Use the "ANTENNA INFO" information in the front panel or "XM Information" screen in the OSD to check the antenna reception level. See instructions supplied with the XM Mini-Tuner and Dock for antenna installation information.	56
CH OFF AIR	The XM channel you selected is not currently broadcasting.	Check back at a later time; in the meantime, select another channel.	—
CH UNAUTH	You may be attempting to tune to an XM channel that is blocked or that you cannot receive with your XM subscription package.	Consult the latest channel guide at http://www.xmradio.com/ (US residents) and http://www.xmradio.ca/ (Canadian residents) for the current list of channels. For information on receiving this channel, visit http://www.xmradio.com/ (US residents) and http://www.xmradio.ca/ (Canadian residents) or contact XM Satellite Radio at 1-800-967-2346 (US residents) and 1-877-438-9677 (Canadian residents).	52
CH UNAVAIL	The selected channel is not available. The channel may have been reassigned to a different channel number. This message may occur initially with a new XM Mini-Tuner or an XM Mini-Tuner that has not received XM's signal for an extended period.	Consult the latest channel guide at http://www.xmradio.com/ (US residents) and http://www.xmradio.ca/ (Canadian residents) for the current list of channels. For cases of a new XM Mini-Tuner or an XM Mini-Tuner that has not received XM's signal for an extended period, allow the XM Mini-Tuner to receive the XM satellite signal for at least 5 minutes and then try to select the channel again.	—
- - - -	No artist name or song title is available for this selection.	No action required.	—

■ SIRIUS Satellite Radio

If an operation takes longer than usual or an error occurs, one of the following messages may appear in the front panel display. In this case, read the cause and follow the corresponding remedies.

Status message	Cause	Remedy	See page
ANTENNA ERROR	The antenna is not connected to the SiriusConnect tuner properly.	Check the connection of the antenna and SiriusConnect tuner.	57
CHECK SR TUNER	The SiriusConnect tuner is not connected to the SIRIUS jack of this unit correctly.	Check the connection of the SiriusConnect tuner and this unit.	57
	The SiriusConnect tuner is not connected to the AC wall outlet.	Connect the power cable of the SiriusConnect tuner to the AC wall outlet.	57
NOT SUPPORTED	This unit does not support the connected SIRIUS Satellite Radio tuner.	Connect the SiriusConnect tuner that this unit supports.	57
ACQUIRING	The signal is too weak.	Adjust the orientation of the antenna of the SiriusConnect tuner. Use the "ANTENNA INFO" information in the front panel display or "SIRIUS Information" screen in the OSD to check the antenna reception level.	62
UPDATING	The SiriusConnect tuner is updating the channel list.	Wait until the updating is complete.	—
	The period of the subscription is end.	Contact SIRIUS Satellite Radio to renew the subscription.	58
F/W UPDATING	The SiriusConnect tuner is updating the firmware.	Wait until the updating is complete.	—
CALL SIRIUS (CALL 888-539-SIRIUS TO SUBSCRIBE)	The selected channel is not subscribed.	Contact SIRIUS Satellite Radio to subscribe the selected channel. URL: https://activate.siriusradio.com/ Phone: 1-888-539-SIRIUS (1-888-539-7474)	58
		Select another channel.	58
SUB UPDATED	The subscription information is updated.		
INVALID	The selected channel is currently out of service.	Select another channel.	58
Not Available	The operation you made is not available.		

■ Remote control

Problem	Cause	Remedy	See page
The remote control does not work or function properly.	Wrong distance or angle.	The remote control will function within a maximum range of 6 m (20 ft) and no more than 30 degrees off-axis from the front panel.	28
	Direct sunlight or lighting (from an inverter type of fluorescent lamp, etc.) is striking the remote control sensor of this unit.	Reposition this unit.	—
	The batteries are weak.	Replace all batteries.	5
	The operation mode selector is set incorrectly.	Set the operation mode selector correctly. When operating this unit, set it to the AMP position. When operating the component selected by the input selector button, set it to the SOURCE position. When operating the TV set in the TV area, set it to the TV position.	—
	The control zone setting is incorrect.	Select the zone you want to control.	100
	The remote control code is not correctly set.	Set the remote control code correctly using “List of remote control codes” at the end of this manual.	91
		Try setting another code of the same manufacturer using “List of remote control codes” at the end of this manual.	91
	The remote control ID of the remote control and this unit do not match.	Match the remote control ID of this unit and the remote control.	98, 102
Even if the remote control code is correctly set, there are some models that do not respond to the remote control.	Program the necessary functions independently into the programmable buttons using the Learn feature.	93	
The remote control does not learn new functions.	The batteries of this remote control and/or the other remote control are too weak.	Replace the batteries.	5
	The distance between the two remote controls is too much or too little.	Place the remote controls at the proper distance.	93
	The signal coding or modulation of the other remote control is not compatible with this remote control.	Learning is not possible.	—
	Memory capacity is full.	Delete other unnecessary functions to make room for the new functions.	97

■ iPod

Note

In case of a transmission error without a status message appearing in the front panel and in the OSD, check the connection of your iPod (page 23).

Status message	Cause	Remedy	See page
Loading...	This unit is in the middle of recognizing the connection with your iPod. This unit is in the middle of acquiring song lists from your iPod.		
Connect error	There is a problem with the signal path from your iPod to this unit.	Turn off this unit and reconnect the Yamaha iPod universal dock to the DOCK terminal of this unit. Try resetting your iPod.	23 —
Unknown iPod	The iPod being used is not supported by this unit.	This unit supports iPod touch, iPod (Click Wheel, including iPod classic), iPod nano and iPod mini.	—
iPod connected	Your iPod is properly stationed in a Yamaha iPod universal dock (such as YDS-11, sold separately) connected to the DOCK terminal of this unit, and the connection between your iPod and this unit is complete.		
Disconnected	Your iPod was removed from a Yamaha iPod universal dock (such as YDS-11, sold separately) connected to the DOCK terminal of this unit.	Station your iPod back in a Yamaha iPod universal dock (such as YDS-11, sold separately) connected to the DOCK terminal of this unit.	23
Unable to Play	This unit cannot play back the songs currently stored on your iPod.	Check that the songs currently stored on your iPod are playable. Store some other playable music files on your iPod.	— —

■ Bluetooth

Status message	Cause	Remedy	See page
Searching...	The Bluetooth receiver and the Bluetooth component is in the middle of the pairing. The Bluetooth receiver and the Bluetooth component is in the middle of establishing the connection.		
Completed	The pairing is completed.		
Canceled	The pairing is canceled.		
BT connected	The connection between the Yamaha Bluetooth wireless audio receiver (such as YBA-10, sold separately) and the Bluetooth component is established.		
Disconnected	The Bluetooth component is disconnected from the Yamaha Bluetooth wireless audio receiver (such as YBA-10, sold separately).		
No BT receiver	The Bluetooth receiver is not connected to the DOCK terminal.	Connect the Yamaha Bluetooth wireless audio receiver (such as YBA-10, sold separately) to the DOCK terminal.	23

■ AUTO SETUP

Before AUTO SETUP

Error message	Cause	Remedy	See page
Connect MIC!	Optimizer microphone is not connected.	Connect the supplied optimizer microphone to the OPTIMIZER MIC jack on the front panel.	30
Unplug HP!	Headphones are connected.	Unplug the headphones.	—
Memory Guard!	The parameters of this unit are protected.	Set "MEMORY GUARD" to "OFF".	84

During AUTO SETUP

Error message	Cause	Remedy	See page
E-1:NO FRONT SP	Front L/R channel signals are not detected.	Check the front L/R speaker connections.	13
E-2:NO SUR. SP	A surround channel signal is not detected.	Check the surround speaker connections.	13
E-3:NO PRNS SP	A presence channel signal is not detected.	Check the presence speaker connections.	13
E-4:SBR→SBL	Only right surround back channel signal is detected.	Connect the surround back speaker to the SURROUND BACK (SINGLE) speaker terminal if you only have one surround back speaker.	13
E-5:NOISY	Background noise is too loud.	Try running "AUTO SETUP" in a quiet environment.	—
		Turn off noisy electric equipment like air conditioners or move them away from the optimizer microphone.	—
E-6:CHECK SUR.	Surround back speakers are connected, though surround L/R speakers are not.	Connect surround speakers when you use surround back speakers.	14
E-7:NO MIC	The optimizer microphone was unplugged during the "AUTO SETUP" procedure.	Connect the supplied optimizer microphone to the OPTIMIZER MIC jack on the front panel.	30
E-8:NO SIGNAL	The optimizer microphone does not detect test tones.	Check the microphone setting.	30
		Check the speaker connections and placement.	13
		The optimizer microphone or OPTIMIZER MIC jack may be defective. Contact the nearest Yamaha dealer or service center.	—
E-9:USER CANCEL	The "AUTO SETUP" procedure was cancelled due to user activity.	Run "AUTO SETUP" again.	30
E-10:INTERNAL ERROR	An internal error occurred.	Run "AUTO SETUP" again.	30

After AUTO SETUP

Warning message	Cause	Remedy	See page
W-1: OUT OF PHASE	Speaker polarity is not correct. This message may appear depending on the speakers even when the speakers are connected correctly.	Check the speaker connections for proper polarity (+ or -).	13
W-2: OVER 24m (80ft.)	The distance between the speaker and the listening position is over 24 m (80 ft).	Bring the speaker closer to the listening position.	—
W-3: LEVEL ERROR	The difference of volume level among speakers is excessive.	Readjust the speaker installation so that all speakers are set in locations with similar conditions.	—
		Check the speaker connections.	13
		Use speakers of similar quality.	—
		Adjust the output volume of the subwoofer.	30

Notes

- If the “ERROR” or “WARNING” screens appears, check the cause of the problem, then run “AUTO SETUP” again.
- If warning message “W-2” or “W-3” appears, the adjustments are made, however the adjustment may not be optimal.
- Depending on the speakers, warning message “W-1” may appears even if the speaker connections are correct.
- If error message “E-10” occurs repeatedly, contact a qualified Yamaha service center.

Resetting the system

Use this feature to reset all the parameters of this unit to the initial factory settings.

Notes

- This procedure completely resets all the parameters of this unit including the “SET MENU” parameters.
- The initial factory settings are activated next time you turn on this unit.

 To cancel the initialization procedure at any time without making any changes, press **Ⓐ MASTER ON/OFF** on the front panel to release it outward to the OFF position.

1 Press **Ⓐ MASTER ON/OFF** on the front panel to release it outward to the OFF position to turn off this unit.

2 Press and hold **Ⓞ STRAIGHT** and then press **Ⓐ MASTER ON/OFF** inward to the ON position to turn on this unit.

This unit turns on, and “ADVANCED SETUP” appears in the front panel display.



3 Rotate the **Ⓝ PROGRAM** selector to select “INITIALIZE”.



4 Press **Ⓞ STRAIGHT** repeatedly to select “ALL”.



 Select “CANCEL” to cancel the initialization procedure without making any changes.

5 Press **Ⓐ MASTER ON/OFF** to release it outward to the OFF position to confirm your selection and turn off this unit.

Glossary

■ Audio and video synchronization (lip sync)

Lip sync, an abbreviation for lip synchronization, is a technical term that involves both a problem and a capability of maintaining audio and video signals synchronized during post-production and transmission. Whereas the audio and video latency requires complex end-user adjustments, HDMI version 1.3 incorporates an automatic audio and video syncing capability that allows devices to perform this synchronization automatically and accurately without user interaction.

■ Bi-amplification connection

A bi-amplification connection uses two amplifiers for a speaker. One amplifier is connected to the woofer section of a loudspeaker while the other is connected to the combined mid and tweeter section. With this arrangement each amplifier operates over a restricted frequency range. This restricted range presents each amplifier with a much simpler job and each amplifier is less likely to influence the sound in some way. The internal crossover of the speaker consists of a LPF (low pass filter) and a HPF (high pass filter). As its name implies, the LPF passes frequencies below a cutoff and rejects frequencies above the cutoff frequency. Likewise, the HPF passes frequencies above its cutoff.

■ Component video signal

With the component video signal system, the video signal is separated into the Y signal for the luminance and the Pb and Pr signals for the chrominance. Color can be reproduced more faithfully with this system because each of these signals is independent. The component signal is also called the “color difference signal” because the luminance signal is subtracted from the color signal. A monitor with component input jacks is required in order to output component signals.

■ Composite video signal

With the composite video signal system, the video signal is composed of three basic elements of a video picture: color, brightness and synchronization data. A composite video jack on a video component transmits these three elements combined.

■ Deep Color

Deep Color refers to the use of various color depths in displays, up from the 24-bit depths in previous versions of the HDMI specification. This extra bit depth allows HDTVs and other displays go from millions of colors to billions of colors and eliminate on-screen color banding for smooth tonal transitions and subtle gradations between colors. The increased contrast ratio can represent many times more shades of gray between black and white. Also Deep Color increases the number of available colors within the boundaries defined by the RGB or YcbCr color space.

■ Dolby Digital

Dolby Digital is a digital surround sound system that gives you completely independent multi-channel audio. With 3 front channels (front L/R and center), and 2 surround stereo channels, Dolby Digital provides 5 full-range audio channels. With an additional channel especially for bass effects, called LFE (Low Frequency Effect), the system has a total of 5.1-channels (LFE is counted as 0.1 channel). By using 2-channel stereo for the surround speakers, more accurate moving sound effects and surround sound environment are possible than with Dolby Surround. The wide dynamic range from maximum to minimum volume reproduced by the 5 full-range channels and the precise sound orientation generated using digital sound processing provide listeners with unprecedented excitement and realism. With this unit, any sound environment from monaural up to a 5.1-channel configuration can be freely selected for your enjoyment.

■ Dolby Digital EX

Dolby Digital EX creates 6 full-bandwidth output channels from 5.1-channel sources. This is done using a matrix decoder that derives 3 surround channels from the 2 in the original recording. For the best results, Dolby Digital EX should be used with movie sound tracks recorded with Dolby Digital Surround EX. With this additional channel, you can experience more dynamic and realistic moving sound especially with scenes with “fly-over” and “fly-around” effects.

■ Dolby Digital Plus

Dolby Digital Plus is an advanced audio technology developed for high-definition programming and media including HD broadcasts, HD DVD, and Blu-ray Disc. Selected as a mandatory audio standard for HD DVD and as an optional audio standard for Blu-ray Disc, this technology delivers multichannel sound with discrete channel output. Supporting bitrates up to 6.0 Mbps, Dolby Digital Plus can carry up to 7.1 discrete audio channels simultaneously. Supported by HDMI version 1.3 and designed for the optical disc players and AV receivers/amplifiers of the future, Dolby Digital Plus also remains fully compatible with the existing multichannel audio systems that incorporate Dolby Digital.

■ Dolby Pro Logic II

Dolby Pro Logic II is an improved technique used to decode vast numbers of existing Dolby Surround sources. This new technology enables a discrete 5-channel playback with 2 front left and right channels, 1 center channel, and 2 surround left and right channels instead of only 1 surround channel for conventional Pro Logic technology. There are three modes available: “Music mode” for music sources, “Movie mode” for movie sources and “Game mode” for game sources.

■ Dolby Pro Logic IIx

Dolby Pro Logic IIx is a new technology enabling discrete multi-channel playback from 2-channel or multi-channel sources. There are three modes available: “Music mode” for music sources, “Movie mode” for movie sources (for 2-channel sources only) and “Game mode” for game sources.

■ Dolby Surround

Dolby Surround uses a 4-channel analog recording system to reproduce realistic and dynamic sound effects: 2 front left and right channels (stereo), a center channel for dialog (monaural), and a surround channel for special sound effects (monaural). The surround channel reproduces sound within a narrow frequency range. Dolby Surround is widely used with nearly all video tapes and laser discs, and in many TV and cable broadcasts as well. The Dolby Pro Logic decoder built into this unit employs a digital signal processing system that automatically stabilizes the volume on each channel to enhance moving sound effects and directionality.

■ Dolby TrueHD

Dolby TrueHD is an advanced lossless audio technology developed for high-definition disc-based media including HD DVD and Blu-ray Disc. Selected as a mandatory audio standard for HD DVD and as an optional audio standard for Blu-ray Disc, this technology delivers sound that is bit-for-bit identical to the studio master, offering a high-definition home theater experience. Supporting bitrates up to 18.0 Mbps, Dolby TrueHD can carry up to 8 discrete channels of 24-bit/96 kHz audio simultaneously. Supported by HDMI version 1.3 and designed for the optical disc players and AV receivers/amplifiers of the future, Dolby TrueHD also remains fully compatible with the existing multichannel audio systems and retains the metadata capability of Dolby Digital, allowing dialog normalization and dynamic range control.

■ DSD

Direct Stream Digital (DSD) technology stores audio signals on digital storage media, such as Super Audio CDs. Using DSD, signals are stored as single bit values at a high-frequency sampling rate of 2.8224 MHz, while noise shaping and oversampling are used to reduce distortion, a common occurrence with very high quantization of audio signals. Due to the high sampling rate, better audio quality can be achieved than that offered by the PCM format used for normal audio CDs.

■ DTS 96/24

DTS 96/24 offers an unprecedented level of audio quality for multi-channel sound on DVD video, and is fully backward-compatible with all DTS decoders. “96” refers to a 96 kHz sampling rate compared to the typical 48 kHz sampling rate. “24” refers to 24-bit word length.

DTS 96/24 offers sound quality transparent to the original 96/24 master, and 96/24 5.1-channel sound with full-quality full-motion video for music programs and motion picture soundtracks on DVD video.

■ DTS Digital Surround

DTS digital surround was developed to replace the analog soundtracks of movies with a 6.1-channel digital sound track, and is now rapidly gaining popularity in movie theaters around the world. DTS, Inc. has developed a home theater system so that you can enjoy the depth of sound and natural spatial representation of DTS digital surround in your home. This system produces practically distortion-free 6-channel sound (technically, front left and right, center, surround left and right, and LFE 0.1 (subwoofer) channels for a total of 5.1 channels). This unit incorporates a DTS-ES decoder that enables 6.1-channel reproduction by adding the surround back channel to the existing 5.1-channel format.

■ DTS Express

DTS Express is an advanced audio technology for the optional feature on Blu-ray Disc or HD DVD, which offers high-quality, low bit rate audio optimized for network streaming, and Internet applications. DTS Express is used for the Secondary Audio feature of Blu-ray Disc or the Sub Audio feature of HD DVD. These features deliver audio commentaries (for example, the additional commentaries made by the director of a film) on demand by the users via the Internet, etc. DTS Express signals are mixed down with the main audio stream on the player component, and the component sends the mixed audio stream to the AV receivers/amplifiers via digital coaxial, digital optical, or analog connections.

■ DTS-HD High Resolution Audio

DTS-HD High Resolution Audio is an high resolution audio technology developed for high-definition disc-based media including HD DVD and Blu-ray Disc. Selected as an optional audio standard for both HD DVD and Blu-ray Disc, this technology delivers sound that is virtually indistinguishable from the original, offering a high-definition home theater experience. Supporting bitrates up to 3.0 Mbps for HD DVD and 6.0 Mbps for Blu-ray Disc, DTS-HD High Resolution Audio can carry up to 7.1 discrete channels of 24-bit/96 kHz audio simultaneously. Supported by HDMI version 1.3 and designed for the optical disc players and AV receivers/amplifiers of the future, DTS-HD High Resolution Audio also remains fully compatible with the existing multichannel audio systems that incorporate DTS Digital Surround.

■ DTS-HD Master Audio

DTS-HD Master Audio is an advanced lossless audio technology developed for high-definition disc-based media including HD DVD and Blu-ray Disc. Selected as a mandatory audio standard for both HD DVD and Blu-ray Disc, this technology delivers sound that is bit-for-bit identical to the studio master, offering a high-definition home theater experience. Supporting bitrates up to 18.0 Mbps for HD DVD and up to 24.5 Mbps for Blu-ray Disc, DTS-HD Master Audio can carry up to 7.1 discrete channels of 24-bit/96 kHz audio simultaneously. Supported by HDMI version 1.3 and designed for the optical disc players and AV receivers/amplifiers of the future, DTS-HD Master Audio also remains fully compatible with the existing multichannel audio systems that incorporate DTS Digital Surround.

■ HDMI

HDMI (High-Definition Multimedia Interface) is the first industry-supported, uncompressed, all-digital audio/video interface. Providing an interface between any source (such as a set-top box or AV receiver) and an audio/video monitor (such as a digital television), HDMI supports standard, enhanced or high-definition video as well as multi-channel digital audio using a single cable. HDMI transmits all ATSC HDTV standards and supports 8-channel digital audio, with bandwidth to spare to accommodate future enhancements and requirements.

When used in combination with HDCP (High-bandwidth Digital Content Protection), HDMI provides a secure audio/video interface that meets the security requirements of content providers and system operators. For further information on HDMI, visit the HDMI website at “<http://www.hdmi.org/>”.

■ LFE 0.1 channel

This channel reproduces low-frequency signals. The frequency range of this channel is from 20 Hz to 120 Hz. This channel is counted as 0.1 because it only enforces a low-frequency range compared to the full-range reproduced by the other 5/6 channels in Dolby Digital or DTS 5.1/6.1-channel systems.

■ Neo:6

Neo:6 decodes the conventional 2-channel sources for 6-channel playback by the specific decoder. It enables playback with the full-range channels with higher separation just like digital discrete signal playback. There are two modes available: "Music mode" for music sources and "Cinema mode" for movie sources.

■ Neural-THX Surround

"Neural-THX®" Surround is taking surround sound to the next level. This revolutionary new technology delivers the rich envelopment and discrete image detail of surround sound in a format that is fully compatible with stereo. Neural-THX Surround reduces the bandwidth needed for broadcasters to deliver true, multi-channel surround presentations, and enables 7.1-channel support for gaming and movies. By unmasking the audio details, typically lost by other playback systems, audiences will experience the deep ambience and subtle details of movies, music and games. And with this technology being used by sound designers during content creation, as well as embedded into playback devices, Neural-THX Surround promises a listening experience that is true to the original mix. Neural-THX Surround has been chosen as the official surround sound broadcast format for XM Satellite Radio's "XM HD Surround", as well as other leading FM/HD radio stations worldwide. For additional information, please visit <http://www.neuralsurround.com/>.

■ PCM (Linear PCM)

Linear PCM is a signal format under which an analog audio signal is digitized, recorded and transmitted without using any compression. This is used as a method of recording CDs and DVD audio. The PCM system uses a technique for sampling the size of the analog signal per very small unit of time. Standing for "Pulse Code Modulation", the analog signal is encoded as pulses and then modulated for recording.

■ Sampling frequency and number of quantized bits

When digitizing an analog audio signal, the number of times the signal is sampled per second is called the sampling frequency, while the degree of fineness when converting the sound level into a numeric value is called the number of quantized bits. The range of rates that can be played back is determined based on the sampling rate, while the dynamic range representing the sound level difference is determined by the number of quantized bits. In principle, the higher the sampling frequency, the wider the range of frequencies that can be played back, and the higher the number of quantized bits, the more finely the sound level can be reproduced.

■ SRS CS II (SRS Circle Surround II™)

SRS CS II (SRS Circle Surround II) is a high-performance 6.1 channel matrix surround sound decoding system. It is the next-generation of the original SRS Circle Surround technology, incorporating powerful industry-first features including the dialog clarity enhancement technology and added cinema-like bass to the front channels and subwoofer.

■ S-video signal

With the S-video signal system, the video signal normally transmitted using a pin cable is separated and transmitted as the Y signal for the luminance and the C signal for the chrominance through the S-video cable. Using the S VIDEO jack eliminates video signal transmission loss and allows recording and playback of even more beautiful images.

■ "x.v.Color"

A color space standard supported by HDMI version 1.3. It is a more extensive color space than sRGB, and allows the expression of colors that could not be expressed before. While remaining compatible with the color gamut of sRGB standards, "x.v.Color" expands the color space and can thus produce more vivid, natural images. It is particularly effective for still pictures and computer graphics.

Sound field program information

■ Elements of a sound field

What really creates the rich, full tones of a live instrument are the multiple reflections from the walls of the room. In addition to making the sound live, these reflections enable us to tell where the player is situated as well as the size and shape of the room in which we are sitting. There are two distinct types of sound reflections that combine to make up the sound field in addition to the direct sound coming straight to our ears from the player's instrument.

Early reflections

Reflected sounds reach our ears extremely rapidly (50 ms to 100 ms after the direct sound), after reflecting from one surface only (for example, from a wall or the ceiling). Early reflections actually add clarity to the direct sound.

Reverberations

These are caused by reflections from more than one surface (for example, from the walls, and/or the ceiling) so numerous that they merge together to form a continuous sonic afterglow. They are non-directional and lessen the clarity of the direct sound.

Direct sound, early reflections and subsequent reverberations taken together help us to determine the subjective size and shape of the room, and it is this information that the digital sound field processor reproduces in order to create sound fields.

If you could create the appropriate early reflections and subsequent reverberations in your listening room, you would be able to create your own listening environment. The acoustics in your room could be changed to those of a concert hall, a dance floor, or a room with virtually any size at all. This ability to create sound fields at will is exactly what Yamaha has done with the digital sound field processor.

■ CINEMA DSP

Since the Dolby Surround and DTS systems were originally designed for use in movie theaters, their effect is best felt in a theater having many speakers designed for acoustic effects. Since home conditions, such as room size, wall material, number of speakers, and so on, can differ so widely, it is inevitable that there are differences in the sound heard. Based on a wealth of actually measured data, Yamaha CINEMA DSP provides the audiovisual experience of a movie theater in the listening room of your own home by using the Yamaha original sound field technology combined with various digital audio systems.

■ CINEMA DSP 3D

The actually measured sound field data contain the information of the height of the sound images. CINEMA DSP 3D feature achieves the reproduction of the accurate height of the sound images so that it creates the accurate and intensive stereoscopic sound fields in a listening room.

■ SILENT CINEMA

Yamaha has developed a natural, realistic sound effect DSP algorithm for headphones. Parameters for headphones have been set for each sound field so that accurate representations of all the sound field programs can be enjoyed on headphones.

■ Virtual CINEMA DSP

Yamaha has developed a Virtual CINEMA DSP algorithm that allows you to enjoy DSP sound field surround effects even without any surround speakers by using virtual surround speakers. It is even possible to enjoy Virtual CINEMA DSP using a minimal two-speaker system that does not include a center speaker.

■ Compressed Music Enhancer

The Compressed Music Enhancer feature of this unit enhances your listening experience by regenerating the missing harmonics in a compression artifact. As a result, flattened complexity due to the loss of high-frequency fidelity as well as lack of bass due to the loss of low-frequency bass is compensated, providing improved performance of the overall sound system.

Parametric equalizer information

This unit employs Yamaha Parametric room Acoustic Optimizer (YPAO) technology to optimize the frequency characteristics of its parametric equalizer to match your listening environment. YPAO uses a combination of the following three parameters (Frequency, Gain and Q factor) to provide highly precise adjustment of the frequency characteristics.

■ Frequency

This parameter is adjustable in one-third octave increments between 32 Hz and 16 kHz.

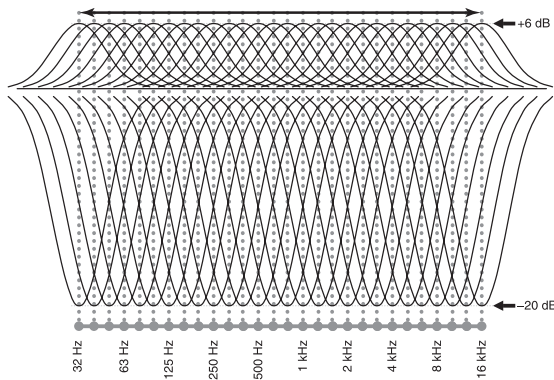

■ Gain

This parameter is adjustable in increments of 0.5 dB between -20 and +6 dB.

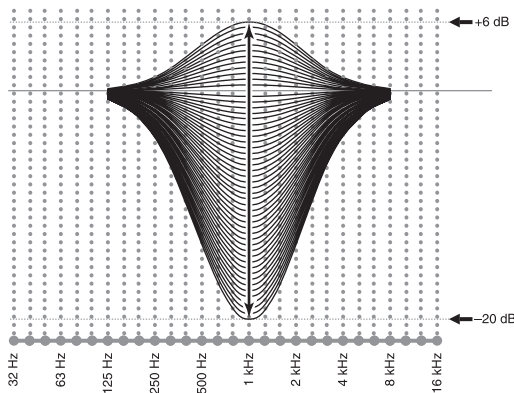

■ Q factor

The width of the specified frequency band is referred to as the Q factor. This parameter is adjustable between the values 0.5 and 10.

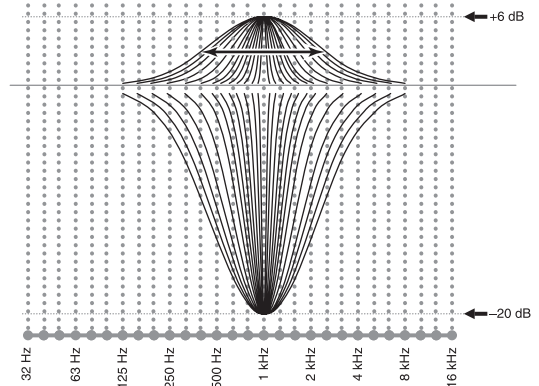

YPAO adjusts frequency characteristics to suit your listening requirements using a combination of the above three parameters (Frequency, Gain and Q factor) for each equalizer band in this unit's parametric equalizer. This unit has 7 equalizer bands for each channel.

The use of multiple equalizer bands enables more precise adjustments of frequency characteristics (as in Figure 2). This is not possible using only a single equalizer band (as in Figure 1).

Figure 1

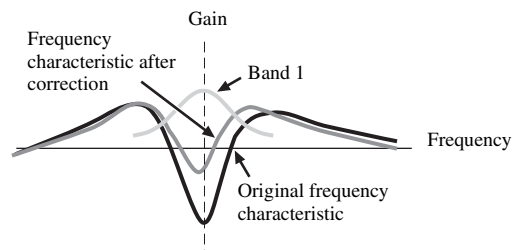
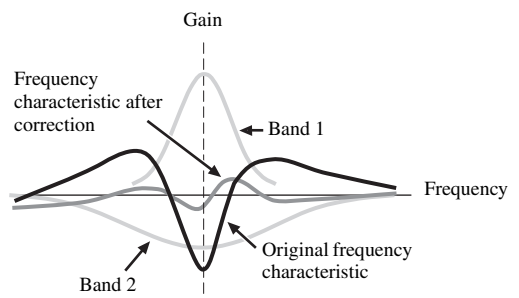

Figure 2



Specifications

AUDIO SECTION

- Minimum RMS Output Power for Front, Center, Surround, Surround back
20 Hz to 20 kHz, 0.04% THD, 8 Ω 130 W
- Dynamic Power (IHF)
8/6/4/2 Ω 160/195/255/335 W
- Maximum Useful Output Power (JEITA)
[Asia, General, China and Korea models]
1 kHz, 10% THD, 8 Ω 175 W
- Maximum Output Power [U.K. and Europe models]
1 kHz, 0.7% THD, 4 Ω 180 W
- Dynamic Headroom
[U.S.A., Canada, General, Asia, China, Korea, and Australia models]
8 Ω 0.9 dB
- IEC Output Power [U.K. and Europe models]
1 kHz, 0.04% THD, 8 Ω 130 W
- Damping Factor (IHF)
1 kHz, 8 Ω 150 or more
- Input Sensitivity/Input Impedance
PHONO 3.5 mV/47 kΩ
CD, etc. 200 mV/47 kΩ
MULTI CH INPUT 200 mV/47 kΩ
- Maximum Input Voltage
PHONO (1 kHz, 0.1% THD) 60 mV or more
CD, etc. (1 kHz, 0.5% THD) 2.4 V or more
- Rated Output Voltage/Output Impedance
OUT (REC) 200 mV/900 Ω
PRE OUT 1.0 V/1.2 kΩ
SUBWOOFER 2.0 V/1.2 kΩ
ZONE 2/ZONE 3 OUT 1.0 V/1.4 kΩ
- Headphone Jack Rated Output/Impedance
CD, etc. (1 kHz, 40 mV, 8 Ω) 150 mV/100 Ω
- Frequency Response
CD to Front L/R, Pure Direct 10 Hz to 100 kHz, +0/-3 dB
- RIAA Equalization Deviation
PHONO (20 Hz to 20 kHz) 0 ± 0.5 dB
- Total Harmonic Distortion
PHONO to OUT (REC)
(20 Hz to 20 kHz, 1 V) 0.02% or less
CD, etc. to Front L/R
(20 Hz to 20 kHz, 65 W, 8 Ω) 0.04% or less
- Signal to Noise Ratio (IHF-A Network)
PHONO (5 mV) to Front L/R
[Australia, U.K. and Europe models] 81 dB or more
[Other models] 86 dB or more
CD, etc. (250 mV) to Front L/R 100 dB or more
- Residual Noise (IHF-A Network)
Front L/R 150 μV or less
- Channel Separation (1 kHz/10 kHz)
PHONO (shortened) to Front L/R 60 dB/55 dB or more
CD, etc. (5.1 kΩ shortened)
to Front L/R 60 dB/45 dB or more

- Tone Control (Front L/R, Center, Subwoofer)
BASS Boost/Cut ±6 dB/50 Hz
BASS Turnover Frequency 350 Hz
TREBLE Boost/Cut ±6 dB/20 kHz
TREBLE Turnover Frequency 3.5 kHz
- Zone 2/Zone 3 Tone Control (Front L/R)
BASS Boost/Cut ±10 dB/100 Hz
BASS Turnover Frequency 450 Hz
TREBLE Boost/Cut ±10 dB/10 kHz
TREBLE Turnover Frequency 2.0 kHz
- Filter Characteristics (fc=40/60/80/90/100/110/120/160/200 Hz)
H.P.F. (Front, Center, Surround, Surround back) 12 dB/oct.
L.P.F. (Subwoofer) 24 dB/oct.

VIDEO SECTION

- Video Format (Gray Back)
[U.S.A., Canada, General and Korea models] NTSC
[U.K., Europe, Australia, Asia and China models] PAL
- Video Format (Video Conversion) NTSC/PAL
- Signal Level
Composite 1 Vp-p/75 Ω
S-video 1 Vp-p/75 Ω (Y), 0.286 Vp-p/75 Ω (C)
Component 1 Vp-p/75 Ω (Y), 0.7 Vp-p/75 Ω (P_B/P_R)
- Maximum Input Level (Video Conversion Off)
..... 1.5 Vp-p or more
- Signal to Noise Ratio (Video Conversion Off)
..... 60 dB or more
- Frequency Response (MONITOR OUT)
Component (Video Conversion Off)
..... 5 Hz to 100 MHz, ±3 dB

FM SECTION

- Tuning Range
[U.S.A. and Canada models] 87.5 to 107.9 MHz
[Asia and General models] 87.5/87.50 to 108.0/108.00 MHz
[Other models] 87.50 to 108.00 MHz
- 50 dB Quieting Sensitivity (IHF)
Mono/Stereo 2.0/25 μV (17.3/39.2 dBf)
- Usable Sensitivity (IHF) 1.0 μV (11.2 dBf)
- Selectivity (400 kHz) 70 dB
- Signal to Noise Ratio (IHF)
Mono/Stereo 76 dB/70 dB
- Harmonic Distortion (1 kHz)
Mono/Stereo 0.2/0.3%
- Stereo Separation (1 kHz)
Stereo 42 dB
- Frequency Response
Stereo 20 Hz to 15 kHz, +0.5, -2 dB
- Antenna Input (unbalanced) 75 Ω

AM SECTION

- Tuning Range
[U.S.A. and Canada models] 530 to 1710 kHz
[Asia and General models] 530/531 to 1710/1611 kHz
[Other models] 531 to 1611 kHz
- Usable Sensitivity 300 μV/m

GENERAL

- Power Supply
 - [U.S.A. and Canada models] AC 120 V, 60 Hz
 - [General and Asia models] AC 110/120/220/230–240 V, 50/60 Hz
 - [China model] AC 220 V, 50 Hz
 - [Korea model] AC 220 V, 60 Hz
 - [Australia model] AC 240 V, 50 Hz
 - [U.K. and Europe models] AC 230 V, 50 Hz
- Power Consumption
 - [U.S.A. and Canada models] 500 W/630 VA
 - [Other models] 500 W
- Standby Power Consumption
 - [General model] (AC 240 V, 50 Hz) 0.33 W or less
 - [Other models] 0.1 W or less
- Maximum Power Consumption [General model only]
6ch, 10% THD 1100 W
- AC Outlets
 - [U.S.A. and Canada models] 2 (Total 100 W/0.8 A maximum)
 - [Asia, General and China models] 2 (Total 50 W maximum)
 - [Australia model] 1 (100 W maximum)
 - [U.K. model] 1 (100 W/0.4 A maximum)
 - [Europe model] 2 (Total 100 W/0.4 A maximum)
- Dimensions (W x H x D) 435 x 171 x 438.5 mm
(17-1/8 x 6-3/4 x 17-1/4 in)
- Weight 17.1 kg (37 lbs. 11 oz.)

* Specifications are subject to change without notice.

We Want You Listening For A Lifetime



Yamaha and the Electronic Industries Association’s Consumer Electronics Group want you to get the most out of your equipment by playing it at a safe level. One that lets the sound come through loud and clear without annoying blaring or distortion – and, most importantly, without affecting your sensitive hearing. Since hearing damage from loud sounds is often undetectable until it is too late, Yamaha and the Electronic Industries Association’s Consumer Electronics Group recommend you to avoid prolonged exposure from excessive volume levels.

SET MENU tree

Press **MENU** on the remote control

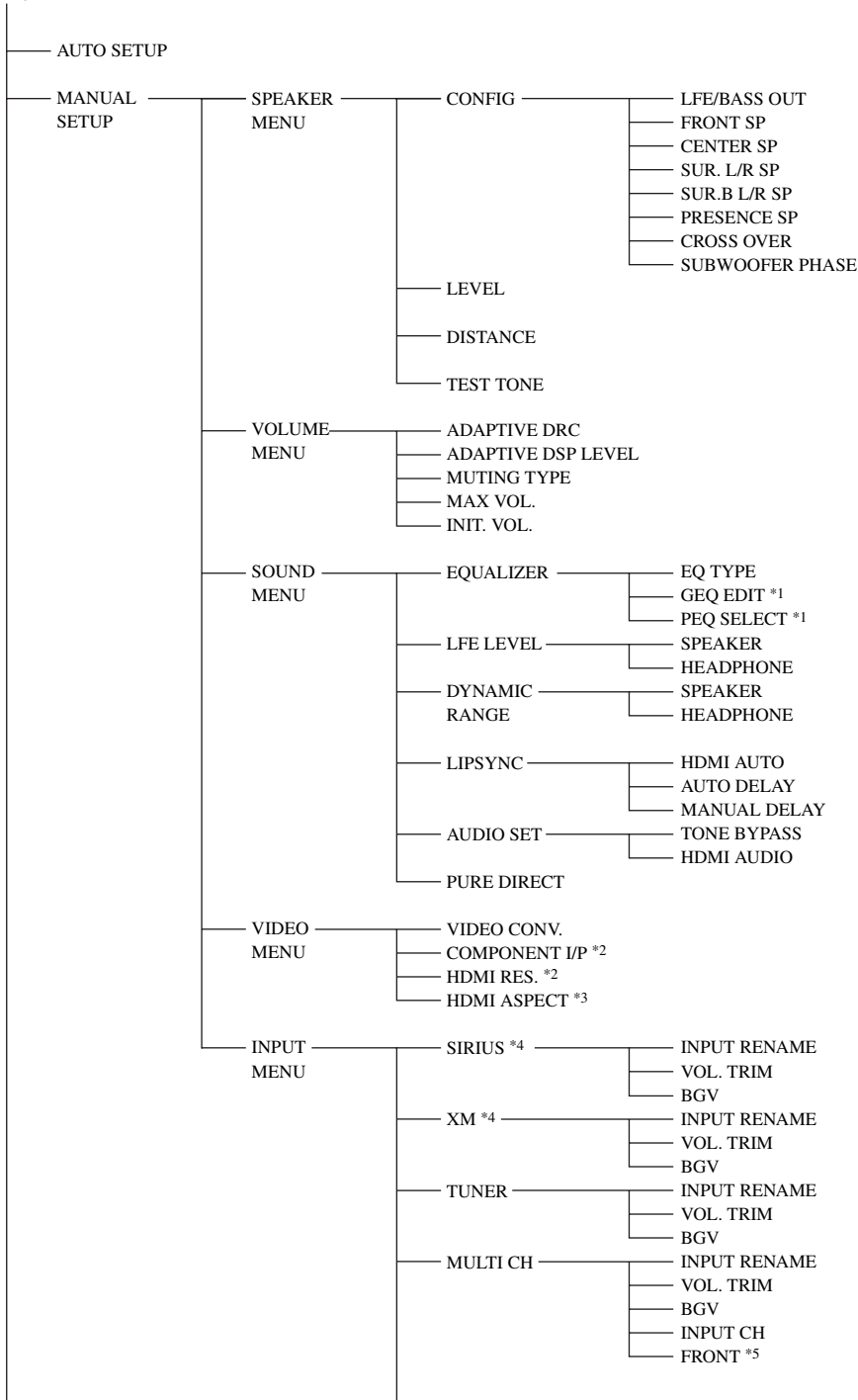

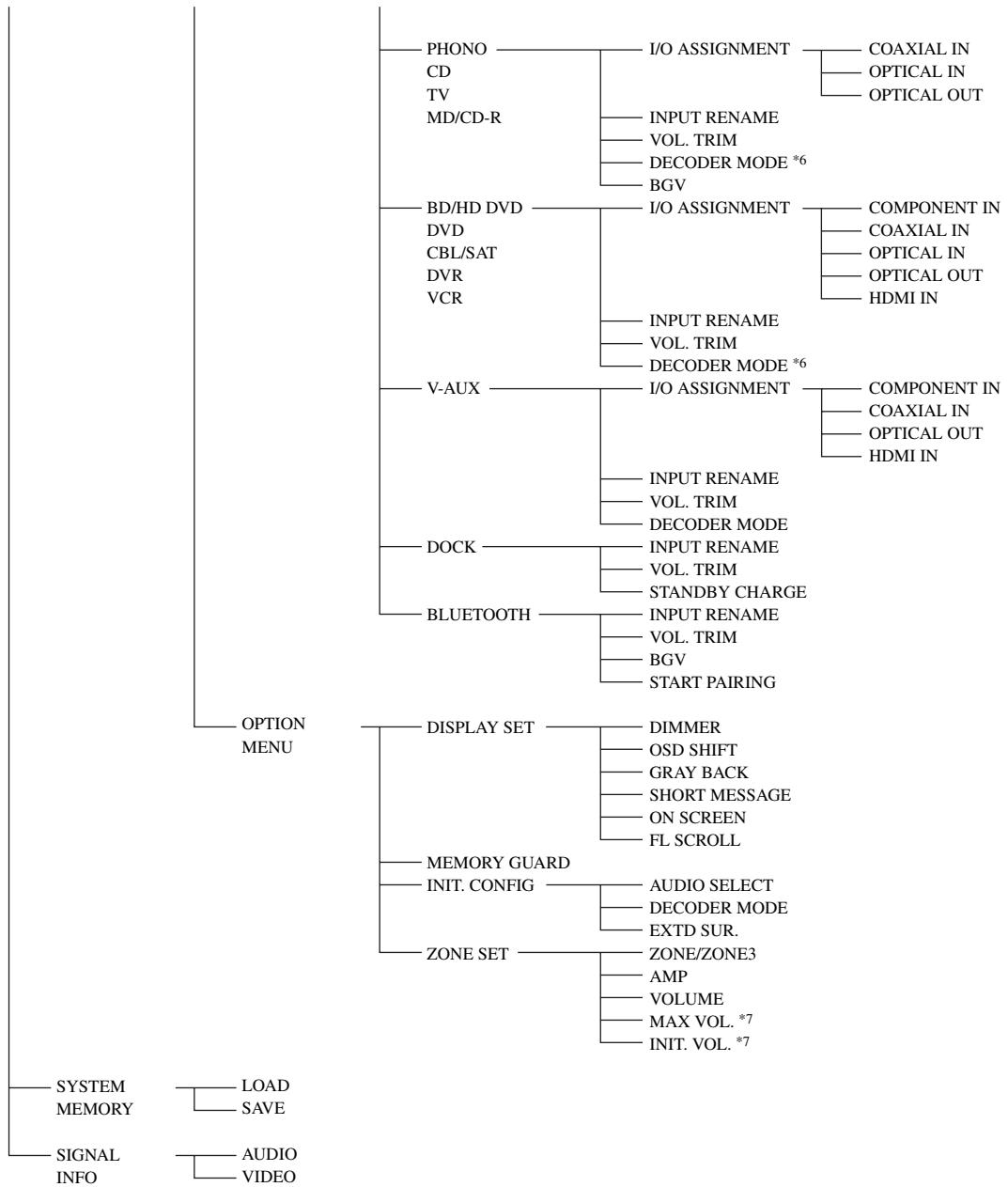

Notes

- *1 Available depending on the parameter selected in "EQ TYPE".
- *2 Available when "VIDEO CONV." is set to "ON".
- *3 Available when "HDMI RES." is not set to "THRGH".
- *4 U.S.A. and Canada models only.
- *5 Available when "INPUT CH" is set to "8ch".
- *6 Available when a digital audio input jack is assigned in "I/O ASSIGNMENT".
- *7 Available when "VOLUME" is not set to "FIX".

Index

■ Numerics

1 SPEAKER MENU, MANUAL SETUP	75
2 VOLUME MENU, MANUAL SETUP	77
2ch Stereo, sound field program	44
3 SOUND MENU, MANUAL SETUP	78
3D indicator	27
4 VIDEO MENU, MANUAL SETUP	80
5 INPUT MENU, MANUAL SETUP	81
5.1-channel speaker connection	14
5.1-channel speaker layout	11
6 OPTION MENU, MANUAL SETUP	83
6.1-channel speaker connection	14
6.1-channel speaker layout	11
7.1-channel speaker connection	13
7.1-channel speaker layout	11
7ch Enhancer, sound field program	44
7ch Stereo, sound field program	44

■ A

A)CONFIG, SPEAKER MENU	75
A)DISPLAY SET, OPTION MENU	83
A)EQUALIZER, SOUND MENU	78
AC OUTLET(S)	25
AC power cable connection	25
Action Game, sound field program	42
Activating SIRIUS Satellite Radio subscription	58
Activating XM Satellite Radio	53
ADAPTIVE DRC indicator	27
ADAPTIVE DRC, VOLUME MENU	77
ADAPTIVE DSP LEVEL, VOLUME MENU	77
Adaptive DSP level, VOLUME MENU	77
Adaptive dynamic range control, VOLUME MENU	77
Advanced setup	102
Advanced sound configurations	66
Adventure, sound field program	43
All Channel Search mode, SIRIUS tuning	59
All Channel Search mode, XM tuning	53
AM antenna connection	24
AM tuner, troubleshooting	108
AM tuning	47
AM tuning operation	47
AMP, operation mode selector	29
AMP, zone set	85
ANALOG RES., input source information	37
ANTENNA terminals	10

Audio and video synchronization, SOUND MENU	79
Audio input BGV, INPUT MENU	82
Audio input jack selection	36
AUDIO jacks	16
Audio jacks	16
AUDIO SELECT	36
AUDIO SELECT, initial configuration	84
Audio select, initial configuration	84
Audio settings, SOUND MENU	80
Audio signal flow	18
Audio signals, HDMI	17
AUTO DELAY, lip sync	79
Auto delay, lip sync	79
AUTO SETUP	30
AUTO SETUP, message	113
Automatic setup	30
Automatic station preset, FM/AM tuning	48

■ B

B)LEVEL, SPEAKER MENU	76
B)LFE LEVEL, SOUND MENU	79
B)MEMORY GUARD, OPTION MENU	84
Banana plug	15
Bass cross over, speaker configurations	76
BGV, INPUT MENU	82
BI-AMP, advanced setup	103
Bi-amplification connections	15
Bi-amplifier mode, advanced setup	103
BITRATE, input source information	37
Bluetooth component playback	65
Bluetooth receiver connection	23
Bluetooth, troubleshooting	112
Blu-ray Disc player connection	21

■ C

C)DISTANCE, SPEAKER MENU	76
C)DYNAMIC RANGE, SOUND MENU	79
C)INIT. CONFIG, OPTION MENU	84
C.IMAGE, decoder parameter	73
Category Search mode, SIRIUS tuning	59
Category Search mode, XM tuning	54
CD player connection	22
CD recorder connection	22
Cellar Club, sound field program	41
CENTER jack	23
CENTER PRE OUT jack	22
CENTER SP, speaker configurations	75
Center speaker	12
Center speaker, speaker configurations	75
CENTER WIDTH, decoder parameter	73
Chamber, sound field program	41

CHANNEL, input source information	37
Charge on standby, INPUT MENU	82
Church in Freiburg, sound field program	41
CINEMA DSP 3D mode	45
CINEMA DSP indicator	27
CLASSICAL, sound field program	40
Clearing configurations, remote control	97
Clearing preset channels, SIRIUS tuning	60
Clearing preset channels, XM tuning	55
Clearing preset stations, FM/AM tuning	49
COAXIAL jacks	16
COMPONENT I/P, VIDEO MENU	80
Component interlace/progressive up-conversion, VIDEO MENU	80
COMPONENT VIDEO jacks	16
Compressed Music Enhancer mode	44
Connecting AC power cable	25
Connecting AM antenna	24
Connecting Bluetooth receiver	23
Connecting Blu-ray Disc player	21
Connecting CD player	22
Connecting CD recorder	22
Connecting DVD player	21
Connecting DVD recorder	21
Connecting external amplifier	22
Connecting FM antenna	24
Connecting HD DVD player	21
Connecting iPod universal dock	23
Connecting MD recorder	22
Connecting power cable	25
Connecting projector	19
Connecting set-top box	21
Connecting SiriusConnect tuner	57
Connecting speaker cable	15
Connecting speakers	13
Connecting turntable	22
Connecting TV monitor	19
Connecting VCR	22
Connecting XM Mini-Tuner Home Dock	52
Connecting YBA-10	23
Connecting YDS-11	23
Connecting Zone 2/3 components	99
Connections	10
Controlling other components	90
Controlling Zone 2/3	100
CROSS OVER, speaker configurations	76
CSII Cinema	66
CSII indicator	27
CSII Music	66
CT LEVEL, sound field parameter	71

■ D

- D)LIPSYNC, SOUND MENU 79
- D)TEST TONE, SPEAKER MENU ... 77
- D)ZONE SET, OPTION MENU 85
- Decoder descriptions 66
- Decoder indicators 27
- DECODER MODE,
 - initial configuration 84
- Decoder mode, initial configuration ... 84
- DECODER MODE, INPUT MENU ... 82
- Decoder mode, INPUT MENU 82
- Decoder parameter 73
- Decoder selection 66
- DIALOG LIFT,
 - sound field parameter 68
- DIALOG, input source information 37
- DIGITAL INPUT jacks 10
- DIGITAL OUTPUT jacks 10
- DIMENSION, decoder parameter 73
- DIMMER, Display settings 83
- Dimmer, Display settings 83
- Direct frequency tuning,
 - FM/AM tuning 47
- Direct number access mode,
 - SIRIUS tuning 59
- Direct number access mode,
 - XM tuning 54
- DIRECT, sound field parameter 71
- Display settings, OPTION MENU 83
- Display window, remote control 28
- Displaying HD Radio information 51
- Displaying input source information ... 37
- Displaying SIRIUS Satellite Radio
 - information 62
- Displaying XM Satellite Radio
 - information 56
- DIST, automatic setup 31
- Drama, sound field program 43
- DSP indicators 27
- DSP LEVEL, sound field parameter ... 68
- DVD player connection 21
- DVD recorder connection 21
- Dynamic range, SOUND MENU 79

■ E

- E)AUDIO SET, SOUND MENU 80
- EFFECT LEVELL,
 - sound field parameter 72
- Effect sound level,
 - sound field parameter 68
- ENHANCER indicator 27
- ENHANCER, sound field program 44
- ENTERTAIN, sound field program 42
- Equalizer type select, equalizer 78
- Equalizer, SOUND MENU 78
- EXTD SUR., initial configuration 85
- Extended surround,
 - initial configuration 85
- External amplifier connection 22

■ F

- F)PURE DIRECT, Audio settings 80
- FL SCROLL, Display settings 84
- FLAG, input source information 37

- FM antenna connection 24
- FM tuner, troubleshooting 108
- FM tuning 47
- FM tuning operation 47
- FOCUS, decoder parameter 73
- FORMAT, input source information ... 37
- FRONT L/R jacks 23
- Front left and right channels input jack,
 - INPUT MENU 83
- Front left/right speaker 12
- Front panel display scroll,
 - Display settings 84
- Front panel door 29
- FRONT PRE OUT jacks 22
- FRONT SP, speaker configurations 75
- Front speakers,
 - speaker configurations 75
- FRONT, INPUT MENU 83

■ G

- GEQ EDIT, equalizer 78
- Graphic equalizer edit, equalizer 78
- Gray back, Display settings 83
- GRAY BACK, Display settings,
 - Display settings 83

■ H

- Hall in Amsterdam,
 - sound field program 41
- Hall in Munich, sound field program ... 40
- Hall in Vienna, sound field program 40
- HD DVD player connection 21
- HD Radio 50
- HD Radio audio program selection 50
- HD Radio information display 51
- HD Radio, troubleshooting 108
- HDMI aspect ratio, VIDEO MENU 81
- HDMI ASPECT, VIDEO MENU 81
- HDMI AUDIO, Audio settings 80
- HDMI audio, Audio settings 80
- HDMI cable plug 17
- HDMI error message 37
- HDMI information 17
- HDMI jack 17
- HDMI monitor check,
 - advanced setup 103
- HDMI RES.,
 - input source information 37
- HDMI RES., VIDEO MENU 81
- HDMI resolution, VIDEO MENU 81
- HDMI signal 17
- HDMI SIGNAL,
 - input source information 37
- HDMI, troubleshooting 108
- HEADPHONE, dynamic range 79
- Headphones indicator 27
- Headphones use 36
- Headphones, dynamic range 79

■ I

- I/O ASSIGNMENT, INPUT MENU ... 82
- ID1/ID2 indicator 28
- Information display 28
- Infrared window, remote control 28

- INIT. VOL., zone set 85
- INIT.DLY, sound field parameter 69
- Initial configuration,
 - OPTION MENU 84
- INITIALIZE, advanced setup 103
- INPUT CH, INPUT MENU 83
- Input channel indicators 28
- Input channels, INPUT MENU 83
- INPUT RENAME, INPUT MENU 82
- Input rename, INPUT MENU 82
- Input signal indicators 27
- Input source indicators 27
- Input source information display 37
- Input/output assignment,
 - INPUT MENU 82
- iPod control 63
- iPod playback 63
- iPod universal dock connection 23
- iPod, troubleshooting 112

■ L

- LFE/BASS OUT,
 - speaker configurations 75
- LFE/bass out, speaker configurations .. 75
- Lip sync, SOUND MENU 79
- LIVE/CLUB, sound field program 41
- LIVENESS, sound field parameter 70
- Loading system settings 87
- Low-frequency effect level,
 - SOUND MENU 79
- LVL, automatic setup 31

■ M

- Macro programming, remote control ... 95
- MANUAL DELAY, lip sync 79
- Manual delay, lip sync 79
- MANUAL SETUP 74
- MANUAL SETUP operation 74
- Manual station preset,
 - FM/AM tuning 48
- MAX VOL., VOLUME MENU 78
- MAX VOL., zone set 85
- Maximum volume,
 - VOLUME MENU 78
- MD recorder connection 22
- Memory guard, OPTION MENU 84
- Menu browse mode control,
 - iPod playback 63
- Menu browsing indicator 28
- MONITOR CHECK,
 - advanced setup 103
- Mono Movie, sound field program 43
- MOVIE, sound field program 43
- MULTI CH INPUT jacks 10
- Multi-channel input component
 - selection 36
- Multi-channel sources with
 - headphones 44
- Multi-zone configuration 99
- Music Video, sound field program 42
- Muting audio output 37
- MUTING TYPE, VOLUME MENU ... 78
- Muting type, VOLUME MENU 78

■ N

Neo:6 Cinema	66
Neo:6 Music	66
neural indicator	27
NRL-THX	66
NRL-THX Music	66
Number of speakers, automatic setup ..	31

■ O

ON SCREEN, Display settings	84
On-screen display time, Display settings	84
Operation mode selector	29
OPTICAL jacks	16
Optimizing speaker setting	30
OSD SHIFT, Display settings	83
OSD shift, Display settings	83

■ P

P.INIT.DLY, sound field parameter	69
Pairing with Bluetooth component	65
PANORAMA, decoder parameter	73
Parameter initialization, advanced setup	103
Parametric equalizer information	120
Parametric equalizer select, equalizer ..	79
Parental Lock, SIRIUS tuning	61
PEQ SELECT, equalizer	79
PHONES jack	36
PL LEVEL, sound field parameter	71
Placing speakers	11
PLII Game	66
PLII Movie	66
PLII Music	66
PLIIx Game	66
PLIIx Movie	66
PLIIx Music	66
Power cable connection	25
PR LEVEL, sound field parameter	71
PRE OUT jacks	10
Presence left/right speaker	12
PRESENCE SP, speaker configurations	76
Presence speaker indicators	28
Presence speakers, speaker configurations	76
Preset channel clear, SIRIUS tuning	60
Preset channel clear, XM tuning	55
Preset channel setting, SIRIUS tuning	60
Preset channel setting, XM tuning	55
PRESET indicator	27
Preset Search mode, SIRIUS tuning	59
Preset Search mode, XM tuning	54
Preset stations, FM/AM tuner	48
Pro Logic	66
Programming other remote controls	93
Projector connection	19
Pure Direct mode	46
Pure direct, Audio settings	80
Pure hi-fi sound listening	46

■ R

Rear panel	10
Recalling a preset station, FM/AM tuning	49
Recital/Opera, sound field program	42
REMOTE CON AMP, advanced setup	102
Remote control	89
Remote control code setting	91
Remote control ID setting, advanced setup	102
Remote control use	28
Remote control, installing batteries	5
Remote control, troubleshooting	111
REMOTE IN/OUT jacks	23
REMOTE SENSOR, advanced setup	102
Remote sensor, advanced setup	102
Repeat, iPod playback	64
Resetting system	115
REV.DELAY, sound field parameter ..	71
REV.LEVEL, sound field parameter ..	71
REV.TIMES, sound field parameter	70
Roleplaying Game, sound field program	42
ROOM SIZE, sound field parameter ..	69
RS-232C STANDBY, advanced setup	102

■ S

S VIDEO jacks	16
S.INIT.DLY, sound field parameter	69
S.LIVENESS, sound field parameter ..	70
S.ROOM SIZE, sound field parameter	69
SAMPLING, input source information	37
Saving system settings	86
SB INIT.DLY, sound field parameter ..	69
SB LEVELSEL LEVEL	71
SB LIVENESS, sound field parameter	70
SB ROOM SIZE, sound field parameter	69
Sci-Fi, sound field program	43
Selecting audio input jacks	36
Selecting HD Radio audio programs	50
Selecting multi-channel input component	36
Selecting sound field programs	39
SET MENU tree	123
Setting preset channels, SIRIUS tuning	60
Setting preset channels, XM tuning	55
Setting remote control ID, remote control ID setting	102
Setting zone, zone set	85
Set-top box connection	21
Short message display	84
SHORT MESSAGE, Display settings	84
Shuffle, iPod playback	64
Signal flow	18
SIGNAL INFO	37

SILENT CINEMA	44
SILENT CINEMA indicator	27
Simple remote mode control, iPod playback	63
Simplified remote control	98
Sirius ID diplay	58
SIRIUS PIN, advanced setup	103
SIRIUS Satellite Radio information display	62
SIRIUS Satellite Radio operations	58
SIRIUS Satellite Radio Parental Lock code number reset, advanced setup	103
SIRIUS Satellite Radio subscription activation	58
SIRIUS Satellite Radio tuning	57
SIRIUS Satellite Radio, troubleshooting	110
SiriusConnect tuner connection	57
SL LEVEL, sound field parameter	71
SLEEP indicator	28
Sleep timer	38
Sound field parameter	69
Sound field parameter settings	67
Sound field program information	119
Sound field program selection	39
Sound field programs	39
Sound field programs with headphones	44
Sound field programs without surround speakers	44
Source name change	94
SOURCE, operation mode selector	29
SP, automatic setup	31
SP2 speaker terminals	15
Speaker cable connection	15
Speaker configurations, SPEAKER MENU	75
Speaker connection	13
Speaker distance, automatic setup	31
Speaker distance, SPEAKER MENU ..	76
SPEAKER IMP., advanced setup	102
Speaker impedance setting	26
Speaker impedance, advanced setup	102
Speaker level adjustment	46
Speaker level, automatic setup	31
Speaker level, SPEAKER MENU	76
Speaker placement	11
Speaker setting optimization	30
Speaker terminals	10
SPEAKER, dynamic range	79
Speakers, dynamic range	79
Specifications	121
Spectacle, sound field program	43
Sports, sound field program	42
SR LEVEL, sound field parameter	71
Standard, sound field program	43
STANDBY CHARGE, INPUT MENU	82
Standby mode	26
START PAIRING, INPUT MENU	82
Start pairing, INPUT MENU	82
Stereo playback	44

- STEREO, sound field program 44
- Straight Enhancer,
sound field program 44
- STRAIGHT mode 45
- Subwoofer 12
- SUBWOOFER jack 23
- SUBWOOFER PHASE,
speaker configurations 76
- Subwoofer phase,
speaker configurations 76
- SUBWOOFER PRE OUT jack 23
- Supplied accessories 3
- SUR, sound field parameter 72
- SUR. DECODE,
sound field program 44
- SUR. L/R SP, speaker configurations .. 75
- SUR.B L/R SP,
speaker configurations 76
- SUR.BACK/PRESENCE PRE OUT
jacks 23
- Surround back left/right speaker 12
- Surround back left/right speakers,
speaker configurations 76
- Surround back speaker 12
- Surround Decode,
sound field program 44
- Surround decoder mode 44
- SURROUND L/R jacks 23
- Surround left/right speaker 12
- Surround left/right speakers,
speaker configurations 75
- SURROUND PRE OUT jacks 22
- SYSTEM MEMORY 86
- System settings 86
- **T**
- Test tone, SPEAKER MENU 77
- The Bottom Line,
sound field program 41
- The Roxy Theatre,
sound field program 41
- Tonal quality adjustment 46
- TONE BYPASS, Audio settings 80
- Tone bypass, Audio settings 80
- Transmit indicator 28
- Troubleshooting 104
- TruBass, decoder parameter 73
- Tuner frequency step,
advanced setup 103
- TUNER FRQ STEP,
advanced setup 103
- Tuner indicators 27
- Turning off 26
- Turning on 26
- Turntable connection 22
- TV control, remote control 89
- TV monitor connection 19
- TV, operation mode selector 29
- **U**
- Unit for the speaker distance
adjustment 76
- UNIT, speaker distance 76
- Unprocessed input source listening 45
- **V**
- VCR connection 22
- Vertical dialogue position,
sound field parameter 68
- VIDEO AUX jacks 24
- VIDEO CONV., VIDEO MENU 80
- Video conversion, VIDEO MENU 80
- VIDEO jacks 16
- Video jacks 16
- Video signal flow 18
- Video signals, HDMI 17
- Village Vanguard,
sound field program 41
- Virtual CINEMA DSP 44
- VIRTUAL indicator 27
- VOL. TRIM, INPUT MENU 82
- VOLTAGE SELECTOR 5
- VOLUME level indicator 28
- Volume trim, INPUT MENU 82
- VOLUME, zone set 85
- **W**
- Wake on RS-232C access,
advanced setup 102
- Warehouse Loft,
sound field program 41
- WRENCH HOLDER 15
- **X**
- XM Mini-Tuner Home Dock
connection 52
- XM Satellite Radio activation 53
- XM Satellite Radio information
display 56
- XM Satellite Radio operations 53
- XM Satellite Radio tuning 52
- XM Satellite Radio,
troubleshooting 109
- **Y**
- YBA-10 connection 23
- YDS-11 connection 23
- YPAO 30
- YPAO indicator 27
- **Z**
- Zone 2/3 component connection 99
- Zone 2/3 control 100
- Zone 2/Zone 3 amplifier, zone set 85
- Zone 2/Zone 3 initial volume,
zone set 85
- Zone 2/Zone 3 maximum volume,
zone set 85
- Zone 2/Zone 3 volume, zone set 85
- Zone indicators 28
- ZONE OUT jacks 10
- Zone set, OPTION MENU 85
- ZONE2/ZONE3 indicators 28

“(A) MASTER ON/OFF” or
“(B) DVD” (example) indicates the
name of the parts on the front panel
or the remote control. Refer to the
attached sheet or the pages at the
end of this manual for the
information about each position of
the parts.

■ Front panel

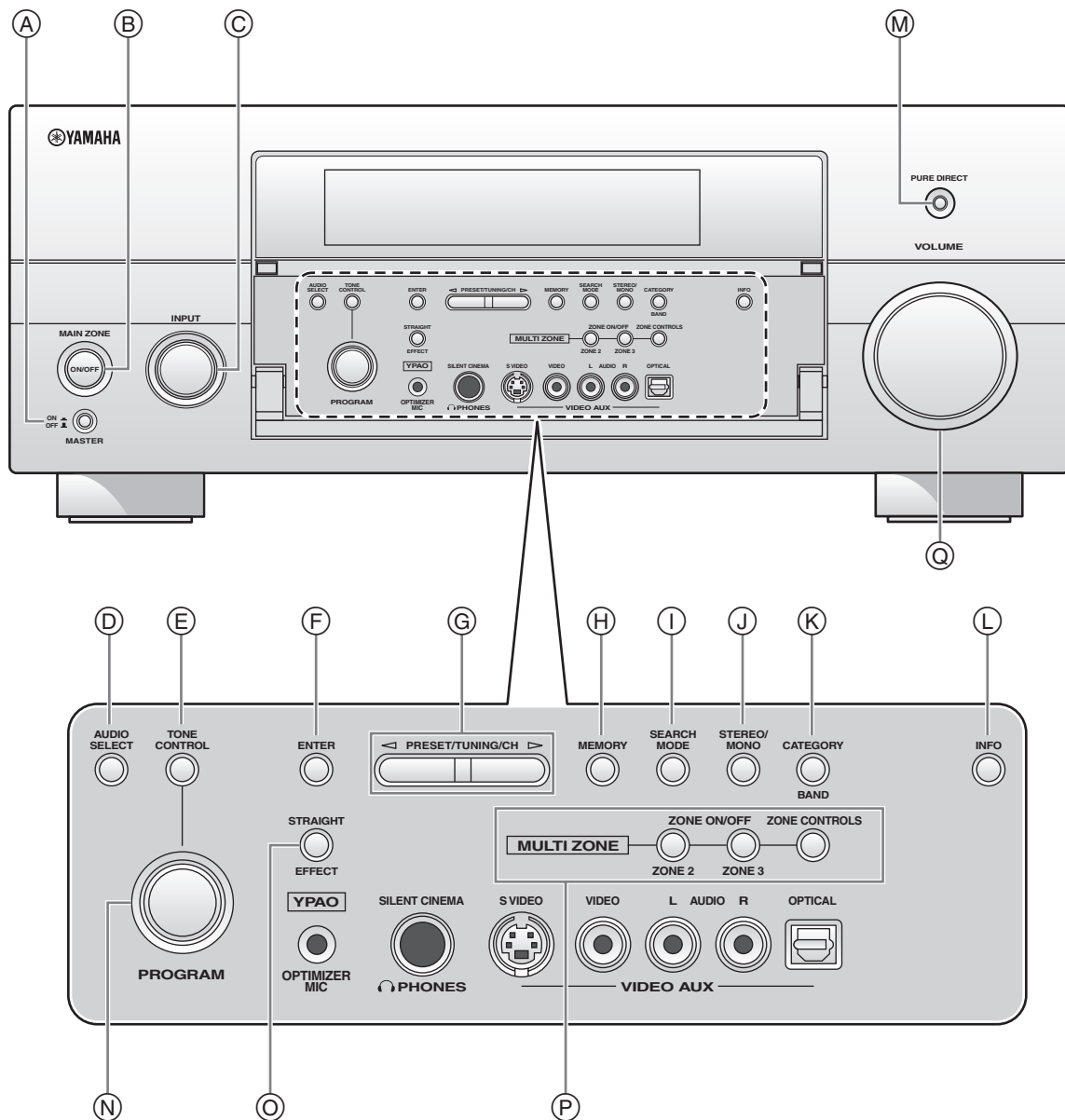

■ Remote control

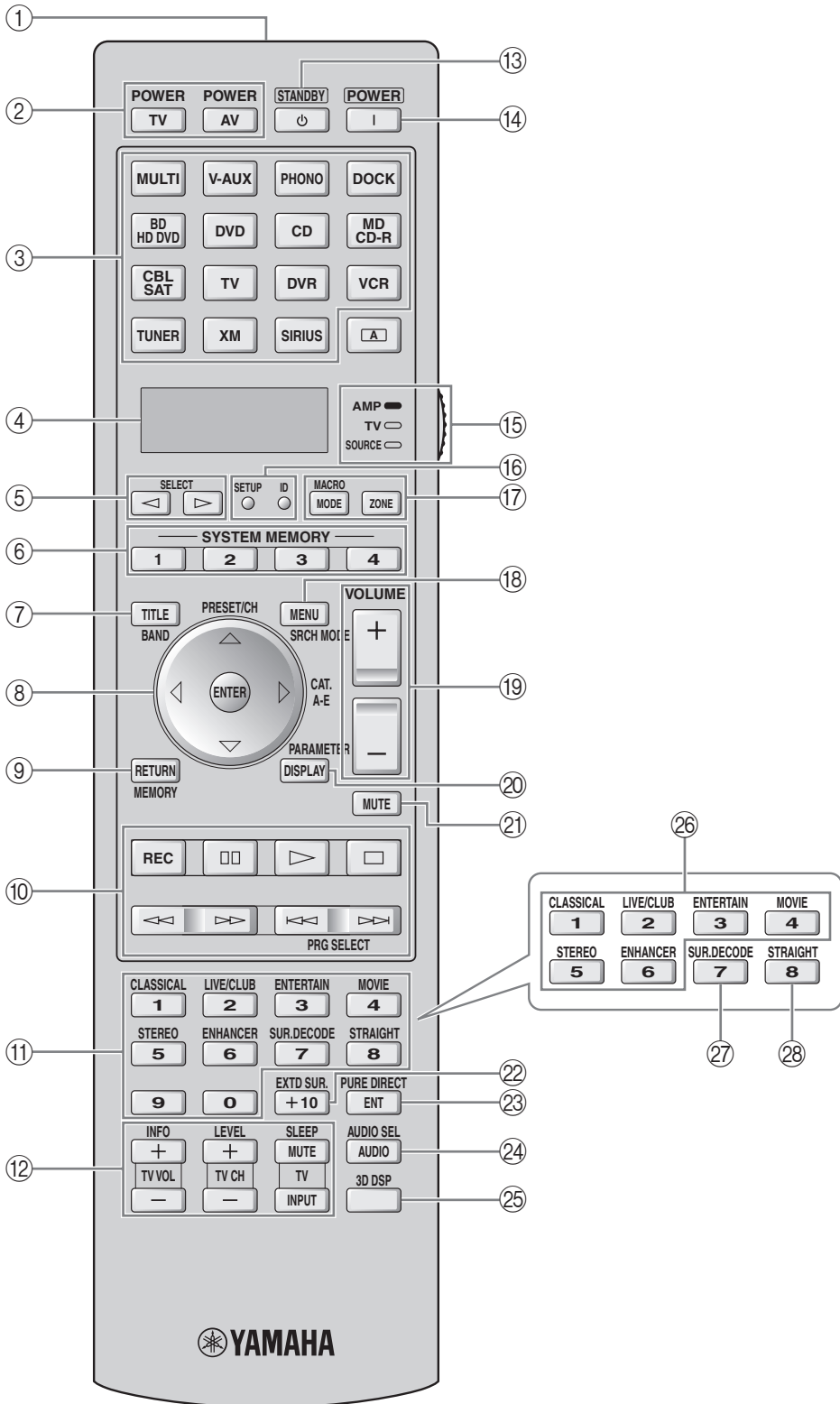

Sound output in each sound field program

- L Front left speaker
- C Center speaker
- R Front right speaker
- SL Surround left speaker
- SR Surround right speaker
- SBL Surround back left speaker
- SBR Surround back right speaker
- PL Presence left speaker
- PR Presence right speaker
- Speaker from which sound is being output
- Speaker from which no sound is being output

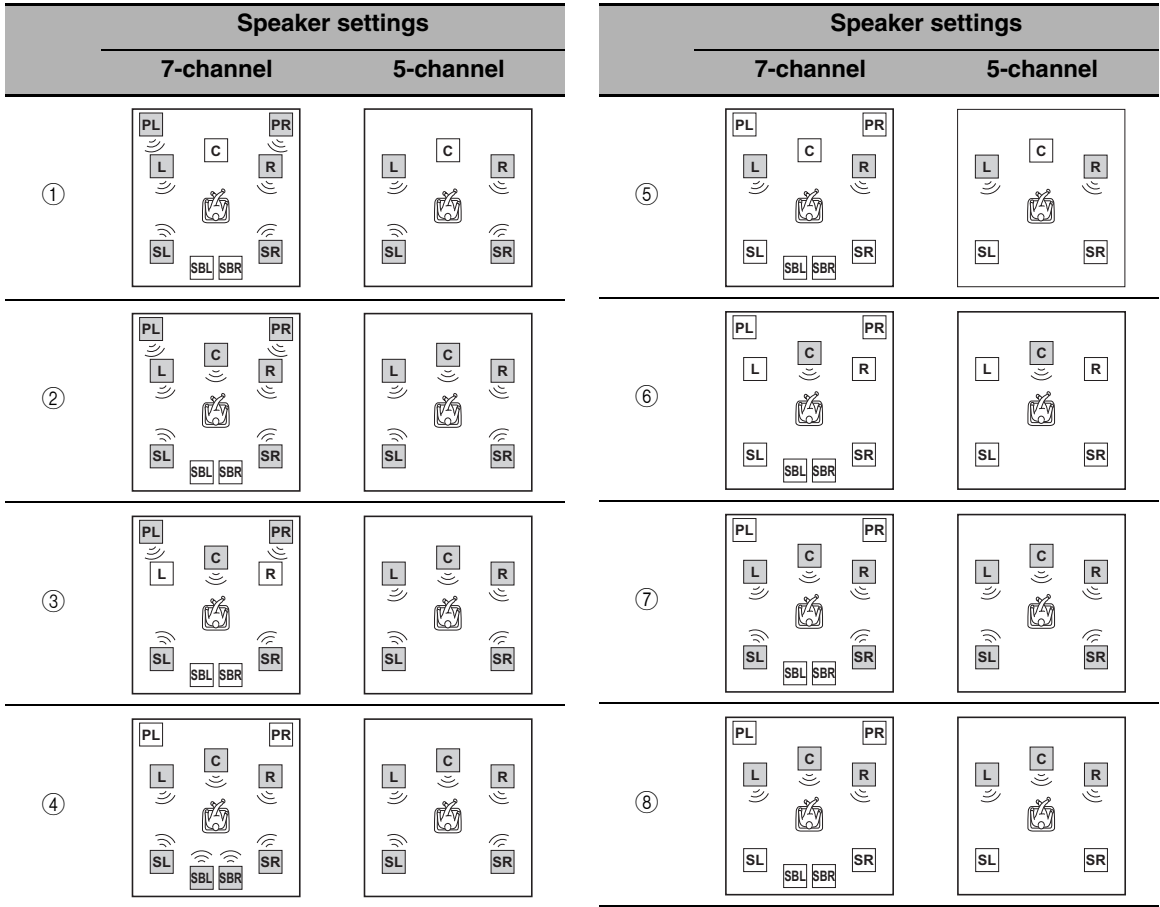

*1 EX / PL IIx / **Trc** _{ES} / (neural): OFF

*2 EX / PL IIx / **Trc** _{ES} / (neural): ON or discrete 6.1/7.1-channel audio signals are input.

		Input audio source			
Program	3D	2-channel (monaural)	2-channel (stereo)	5.1-channel*1	6.1/7.1-channel*2
CLASSICAL Hall in Munich Hall in Vienna Hall in Amsterdam	ON	①	①	②	②
	OFF				
CHAMBER LIVE/CLUB Village Vanguard Warehouse Loft Cellar Club The Roxy Theatre The Bottom Line		①	①	②	④

Program	3D	Input audio source			
		2-channel (monaural)	2-channel (stereo)	5.1-channel*1	6.1/7.1-channel*2
ENTERTAINMENT Sports	ON	②	②	②	②
Action Game	OFF				
Roleplaying Game					
Music Video					
Recital/Opera					
MOVIE					
Standard		⑦	④	②	④
Spectacle					
Sci-Fi					
Adventure					
Drama					
MOVIE	ON	②	②	②	②
Mono Movie	OFF	③	②	②	④
STEREO 2ch Stereo	--	⑤	⑤	⑤	⑤
STEREO 7ch Stereo	--	④	④	④	④
MUSIC ENHANCER 7ch Enhancer					
SUR.DECODE Surround Decoder (Pro Logic) (PLII Movie) (PLII Game)	--	⑥	⑦	⑦	④
SUR.DECODE Surround Decoder (PLII Music)	--	⑧	⑦	⑦	④
SUR.DECODE Surround Decoder (PLIIX Movie) (PLIIX Game) (Neo:6 Cinema) (CSII Cinema) (NRL-THX)	--	⑥	④	⑦	④
SUR.DECODE Surround Decoder (PLIIX Music) (Neo:6 Music) (CSII Music) (NRL-THX Music)	--	⑧	④	⑦	④
STRAIGHT Pure Direct MUSIC ENHANCER Straight Enhancer	--	⑤	⑤	⑦	④

List of remote control codes

TV		CENTURION	00401	FINLUX	00401, 01401,	IMPERIAL	03301, 04701,
ACURA	00101	CGE	03301		01501, 04401,		05201
ADDISON	01201, 01601,	CHANGHONG	09701	FIRSTAR	06801	INDIANA	00401
	08401	CHING TAI	00101, 01201	FIRSTLINE	00101, 03101	INFINITY	00801
ADMIRAL	01301, 02201,	CHUN YUN	00001, 00101,		00101, 03301,	INGELEN	02201
	05801		01201, 02701	FISHER	08501	INNO HIT	06801
ADVENT	09601	CHUNG HSIN	00701, 01601,		01401, 02001,	INNOVA	00401
AGB	06801		02701	FLINT	02901, 04701	INTEQ	00201
AIKO	01201	CIMLINE	00101	FORMENTI	05701	INTERFUNK	00401, 02201,
AKAI	00101, 00301,	CINERAL	01201, 05601	FORTRESS	00401, 04101		03301, 04601,
	02901, 04601,	CITIZEN	00301, 00901,	FRONTECH	01301		06701
	06801, 08901,		01201		02201, 03301,	INTERVISION	00401, 03701,
	10501	CLARION	02701	FUJITSU	03701		05001
AKURA	03701	CLARIVOX	00401	FUNAI	08701, 10401	ITS	04801
ALBA	00101, 00401,	CLATRONIC	03301, 04701		02501, 02701,	ITT	02201, 04601,
	04801, 08501	CONDOR	04101, 04701		03701		06901
AMERICA ACTION		CONRAC	10301	FUTURETECH	02701	JBL	00801
	02701	CONTEC	00101, 02701	GATEWAY	13301, 13401	JCB	00001
AMPRO	09401	CRAIG	02701	GE	00301, 00501,	JEAN	00101, 00601,
AMSTRAD	00101, 00401,	CROSLEY	00801		00601, 01201,		01201, 02101,
	02501, 04801,	CROWN	00101, 00401,		02601, 02701,		03101
	05101, 05301,		02701, 04701,		05601, 07101,	JENSEN	09601
	06801	CTC	05201		11801, 12201,	JVC	00701, 04801,
ANAM	00101, 02701,		03301	GEC	12601		05801, 08401,
	03401	CURTIS MATHES			00401, 06801		08701
ANAM NATIONAL			00301, 00501,	GELOSO	00101	KAISUI	00101
	03401, 08301		00801, 00901,	GENEXXA	02201	KAPSCH	02201
ANITECH	00101		01301, 01801,	GIBRALTER	00201, 00301	KARCHER	07701
AOC	00101, 00301,		02001, 02301,	GOLDSTAR	00301, 00401,	KATHREIN	07001
	00901, 01201,	CXC	05601, 08901,		01701, 02001,	KEC	02701
	01301, 01601,		11801, 12201		02601, 05001	KENDO	00401
	02601, 02701,	DAEWOO	02701	GOODMANS	00401, 04801,	KENWOOD	00301
	05601		00101, 00301,		04901, 08201	KNEISSEL	03501, 05401
APEX DIGITAL	09301, 09701,		00401, 01201,	GOREMJE	04701	KOLIN	00701, 01601,
	09901		01601, 02001,	GRADIENTE	00701, 02401		02701
ASA	01401		02401, 02601,	GRAETZ	02201, 04601	KORPEL	00401
AUDIOSONIC	00401, 01701		02701, 04901,	GRANADA	00401, 02901,	KOYODA	00101
AWA	00101		05601, 07901,		04301, 06801	KTV	00301, 02701
BANG & OLUFSEN		DANSAI	08201, 13101	GRANDIN	07701	L&S ELECTRONIC	
	07201		00401	GRUNDIG	00401, 02801,		10301
BASIC	00101	DAYTON	00101		06301, 07001,	LEYCO	00401, 03701
BAUR	00401, 04601,	DE GRAAF	02901, 06901		07401	LG	00301, 00401,
	06701	DECCA	00401, 06801	GRUNPY	02701		00901, 01601,
BAYSONIC	02701	DENON	01801	HALLMARK	02601		02601, 09001
BEAUMARK	02601	DIGATRON	00401	HANKOOK	00301, 02601,	LIESENK & TTER	
BEKO	04701, 06201,	DIXI	00101, 00401		02701		00401
	09001, 09101	DUMONT	00201	HANSEATIC	00401, 04101,	LOEWE	06701
BELL & HOWELL		DWIN	09201, 10101		04601, 05201,	LUXOR	04501, 04601
	02001	ECE	00401		07001	LXI	00501, 00801,
BEON	00401	ELBE	03501	HANTAREX	06801		02001, 02101,
BLAUPUNKT	02801	ELECTROBAND		HARMAN/KARDON	00801		02601
BLUE SKY	08501, 11401		00001		00801	M ELECTRONIC	
BONDSTEC	03301	ELIN	00401, 06901	HARVARD	02701		00101, 00401,
BRADFORD	02701	ELITE	04101	HAVERMY	01301		01401, 01501,
BRANDT	01701, 04201	ELTA	00101	HCM	00101, 05101		01701, 02201,
BROKSONIC	03101, 05801	EMERSON	02001, 02601,	HELLO KITTY	05601		03801, 04401,
BUSH	00101, 00101,		02701, 03101,	HINARI	00101, 00401		04901, 06001
	00401, 04801,		04601, 05801,	HISAWA	05701	MAGNADYNE	03301, 06801
	04901, 08501,		07901	HITACHI	00101, 00301,	MAGNAFON	06801
	11401	ENVISION	00301, 10601		01201, 01501,	MAGNAVOX	00301, 00801,
BYDESIGN	14301, 14401,	EPSON	11001		01701, 01801,		12001, 12601
	14501, 14601	ERRES	00401		02201, 02601,	MANESTH	03701, 04101
CANDLE	00301	ETHER	00101, 00301		03001, 04501,	MARANTZ	00301, 00401,
CARNIVALE	00301	ETRON	00101		06101, 06901,		00801, 07001
CARVER	00801, 02401	EUROPHON	06801		07301, 11701,	MARK	00401
CASCADE	00101	FERGUSON	00401, 01001,	HUA TUN	12101	MATSUI	00101, 00401,
CATHAY	00401		01701, 03201,		00101		02901, 04801,
CCE	00401		03801, 04201,	HUANYU	04901		06301, 06801
CELEBRITY	00001		07101	HYPSON	00401, 03701	MATSUSHITA	03401, 08301
CELERA	09701	FIDELITY	04601	ICE	03701, 04801	MEDIATOR	00401
		FINLANDIA	02901, 04401				

MEDION	08501, 10301, 11401	PENNEY	00301, 00501, 00601, 00901, 02101, 02601, 12201	SAMPO	00101, 00301, 01201, 01301, 02001, 02501, 02601, 08301, 13301	TACICO	00101, 01201, 02601
MEGATRON	01801, 02601					TAI YI	00101
MEMOREX	00101, 01901, 02001, 02601, 03401, 05801, 11401	PERDIO	04101			TANDY	01301, 02201
METZ	05501	PHILCO	00301, 00401, 00801, 01801, 02601, 02701, 03301, 05801, 13101	SAMSUNG	00101, 00301, 00401, 00901, 01101, 01201, 02001, 02601, 03701, 04701, 07001, 07401, 07801, 08901, 09801, 10501, 10701	TASHIKO	01201, 08301
MGA	00301, 01901, 02601					TATUNG	00101, 00401, 00601, 00801, 00901, 02001, 02101, 06801
MICROMAXX	10301	PHILIPS	00001, 00301, 00401, 00601, 00801, 01201, 01601, 02601, 04901, 07001, 08801, 12601	SANSEI	05601	TCM	10301
MICROSTAR	10301			SANSUI	05801	TEAC	00101, 00401, 03701, 05101, 05201, 05701, 08501, 11401
MIDLAND	00201, 00501, 00601			SANYO	01401, 02001, 02701, 02901, 04301, 10201	TEC	03301
MINERVA	06301			SBR	00401	TECHNEMA	04101
MINOKA	05101	PHONOLA	00401	SCHAUB LORENZ	04601	TECHNICS	00601, 03401, 08301
MITSUBISHI	00301, 01301, 01601, 01901, 02001, 02601, 02701, 03101, 03401, 06701, 11201, 11901	PILOT	00301	SCHNEIDER	00401, 03301, 04801, 08501	TECHWOOD	00601
MIVAR	03901, 04001, 06801, 07601	PIONEER	01701, 02201, 02301, 03801, 08601, 09501, 11301	SCOTCH	02601	TECO	00101, 00601, 01201, 01301, 02601, 03701, 08401
MOTOROLA	01301	PORTLAND	01201	SCOTT	02601, 02701, 03101	TEKNIKA	00801, 00901, 01201, 01901, 02701
MTC	00301, 00901, 06701	PRANDONI-PRINCE	06801	SEARS	00501, 00801, 02001, 02101, 02501, 02601	TELEFUNKEN	01701, 03601, 04201, 08001, 08901
MULTITECH	00101, 02701	PRIMA	09601	SEG	03701, 08501	TELEMEISTER	04101
MYRYAD	07001	PRISM	00601	SEI	06801	TELETECH	00101
NAD	02101, 02601, 04601, 11301	PROFEX	00101, 04601	SELECO	02201, 03501	TENSAI	04101
NEC	00101, 00301, 00601, 02001, 02101, 02401, 02601, 05701, 06501, 13201	PROSCAN	00501	SEMIVOX	02701	TERA	00301
NECKERMANN		PROTECH	00101, 00401, 03301, 03701, 05201, 08501	SEMP	02101	THOMSON	01701, 03801, 07101, 08001, 12501
NEI	00401	PROTON	00101, 00301, 02601	SHARP	00301, 01301, 08301	THORN	00401, 01401, 04601, 06701
NETSAT	00401	PULSAR	00201	SHEN YING	00101, 01201	TMK	02601
NEWAVE	00101, 01201, 01301, 02601	QUASAR	00601, 03401, 08301	SHENG CHIA	00101, 01301, 03101	TNCI	00201
NIKKAI	00401, 03701	QUELLE	00401, 01401, 04601, 06701	SIAREM	06801	TOSHIBA	00901, 02001, 02101, 06601, 07801, 08301, 10901, 12101, 12301, 13001, 13201
NIKKO	00301, 01201, 02601	RADIOLA	00401	SIEMENS	00401, 02801	TRIUMPH	06801
NOKIA	04601, 05901, 06001, 06901, 08101	RADIOMARELLI	06801	SINUDYNE	06801	TUNTEX	00101, 00301, 01201
NORCENT	09301, 10801	RADIOHACK	00301, 00501, 02001, 02601, 02701	SKANTIC	04501	TVS	05801
NORDMENDE	01701, 03801, 07101	RCA	00001, 00301, 00501, 01101, 01201, 02601, 08601, 11501, 11801, 13901, 12201, 12501, 12601, 12801	SKY	00401	UHER	04101
NTC	01201			SKYGIANT	02701	UNIVERSUM	00401, 01401, 01501, 03701, 04401, 04701, 06401
OCEANIC	02201, 04601	REALISTIC	00301, 02001, 02601, 02701	SKYWORTH	00401	VECTOR RESEARCH	00301
ONWA	02701, 05301	REOC	09001	SOLAVOX	02201	VESTEL	00401
OPTIMUS	02001, 02301, 03401, 08301	REVOX	00401	SONITRON	02901	VICTOR	00701, 03401, 08301, 08401
OPTONICA	01301	REX	02201, 03501, 03701	SONOKO	00101, 00401	VIDEOSAT	03301
ORION	00401, 03101, 04101, 05801, 06801	RFT	05201	SONOLOR	02201, 02901	VIDTECH	02601
OSAKI	03701, 05101	R-LINE	00401	SONTEC	00401	VIEWSONIC	13301
OTTO VERSAND		ROADSTAR	00101, 03701, 05201	SONY	00001, 08301, 11101, 11601, 12701, 12901	VISION	04101
PALLADIUM	04701, 05201			SOUNDDESIGN	02601, 02701	VOXSON	02201
PANAMA	03701	RUNCO	00201, 00301, 06501, 07501	SOUNDWAVE	00401, 05201	WALTHAM	04501
PANASONIC	00401, 00601, 00801, 02201, 03401, 08301, 12401	SABA	01701, 02201, 03801, 04201	SOWA	00601, 00901, 01201, 02101, 02601	WARDS	00301, 00801, 02601, 11301
PATHE CINEMA		SACCS	03201	SQUAREVIEW	02501	WATSON	00401, 04101
PAUSA	03201, 04101, 00101	SAGEM	07701	SSS	02701	WAYCON	02101
		SAISHO	00101, 03701, 06801	STANDARD	00101	WHITE WESTINGHOUSE	00401, 04101, 05801, 07901
		SALORA	02201, 04601, 06901	STARLITE	02701		
		SAMBERS	06801	STERN	02201, 03501		
				SUPREME	00001		
				SYLVANIA	00301, 00801, 02501		
				SYMPHONIC	02501, 02701		
				SYNCO	00001, 00901, 01201, 01301, 02601, 05601		
				SYSLINE	00401		
				T + A	05501		

YAMAHA	00301, 01801, 08301, 10001, 11001, 13501, 13601, 13701, 13801, 14001, 14101, 14201	DE GRAAF	00702	KEC	00402, 02102	OTTO VERSAND	
		DECCA	00002, 01502	KENWOOD	00602, 01302		01502
		DENON	00702	KLH	01402	PALLADIUM	00402, 00602, 01402
		DUAL	00602	KODAK	00302, 00402	PANASONIC	00302, 01802, 01902, 03102, 03702, 04502
		DUMONT	00002, 01502, 01602	KOLIN	00602, 00802		
YAPSHE	03401	DYNATECH	00002	KORPEL	01402	PATHE MARCONI	00602
YOKO	00401, 03701	ELCATECH	01402	LENCO	02102		
ZENITH	00201, 01201, 02601, 05801	ELECTROHOME	00402	LEYCO	01402		
				LG	00402, 00702, 00902, 02902	PENNEY	00302, 00402, 00702, 02002, 03702, 04202
		ELECTROPHONIC	00402	LLOYD'S	00002		
VCR		EMEREX	00102	LOEWE	00402, 01502, 04502	PENTAX	00702
ADMIRAL	01102	EMERSON	00002, 00302, 00402, 00802, 00902, 01702,	LOGIK	01402, 02002	PERDIO	00002
ADVENTURA	00002		02002, 02102, 04302, 04402	LUXOR	00802, 01102, 01602	PHILCO	00302
AIKO	02102	ESC	02002, 02102	LXI	00402	PHILIPS	00302, 01502, 03202, 03902, 04002
AIWA	00002, 00402, 02202, 02602, 02702	FERGUSON	00602, 02402	M ELECTRONIC	00002	PHONOLA	01502
		FIDELITY	00002	MAGNASONIC	04302	PILOT	00402
AKAI	00602, 02302	FINLANDIA	01502, 01602	MAGNAVOX	00002, 00302, 00502, 01502	PIONEER	00702, 01302, 01502
AKIBA	01402	FINLUX	00002, 00702, 01502, 01602	MAGNIN	02002	POLK AUDIO	01502
ALBA	01402, 02102, 02302, 02702	FIRSTLINE	00402, 00802, 00902, 01402	MANESTH	00902, 01402	PROFITRONIC	02002
AMERICA ACTION	02102	FISHER	01002, 01602	MARANTZ	00302, 01502	PROLINE	00002
AMERICAN HIGH	00302	FUJI	00202, 00302	MARTA	00402	PROSCAN	01202, 03802
AMSTRAD	00002	FUJITSU	00002, 00902	MATSUI	02602, 02702	PROTEC	01402
ANAM	00402, 01902, 02002, 02102, 02902	FUNAI	00002	MATSUSHITA	00302	PULSAR	00502
		GARRARD	00002	MEDION	02602	PYE	01502
ANAM NATIONAL	01902, 04502	GE	00302, 01202, 02002, 03502, 03702, 03802	MEI	00302	QUASAR	00302, 03702
ANITECH	01402	GEC	01502	MEMOREX	00002, 00302, 00402, 00502, 01002, 01102, 01602, 02002, 02202, 02602, 04202	QUELLE	01502
ASA	00402, 01502	GENERAL	00902	MEMPHIS	01402	RADIOLA	01502
ASHA	02002	GO VIDEO	02802	METZ	00402, 02502, 04502	RADIO SHACK	00002
ASUKA	00402	GOLDHAND	01402			RADIX	00402
AUDIOVOX	00402, 02102	GOLDSTAR	00402, 01802, 02902, 04202			RANDEX	00402
BAIRD	00002, 00602, 01602	GOODMANS	00002, 00402, 01402, 02102	MGA	00802, 02002	RCA	00302, 00702, 01202, 02002, 03502, 03702, 03802
BASIC LINE	01402, 02102	GRADIENTE	00002	MGN TECHNOLOGY	02002	REALISTIC	00002, 00302, 00402, 01002, 01102, 01602
BEAUMARK	02002	GRAETZ	00602, 01602, 02002	MINOLTA	00702	REOC	02602
BELL & HOWELL	01602	GRANADA	01502, 01602	MITSUBISHI	00602, 00802, 01302, 01502, 03502	REPLAYTV	03002, 03102
BLAUPUNKT	01902	GRANDIN	00002, 00402, 01402	MOTOROLA	00302, 01102	REX	00602
BRANDT	02402	GRUNDIG	01402, 01502, 01902, 02502	MTC	00002, 02002	ROADSTAR	00402, 01402, 02002, 02102
BRANDT ELECTRONIC	00602	HANSEATIC	00402	MULTITECH	00002, 01402	RUNCO	00502
BROKSONIC	01702, 02602, 04402	HARLEY DAVIDSON	00002	MURPHY	00002	SABA	00602, 02402
BUSH	01402, 02102, 02702	HARMAN/KARDON	01502	MYRYAD	01502	SALORA	00802
		HARWOOD	01402	NAD	01602	SAMPO	00402, 01102
CALIX	00402	HCM	01402	NATIONAL	01902	SAMSUNG	00902, 02002, 02802
CANON	00302	HINARI	01402, 02002, 02702	NEC	00302, 00402, 00602, 01102, 01302, 01602	SANKY	00502, 01102
CARVER	01502	HI-Q	01002	NECKERMANN	01502	SANSUI	00002, 00602, 01302, 04402
CCE	01402, 02102	HITACHI	00002, 00402, 00602, 00702, 02002	NEC	01402	SANYO	01002, 01602, 02002
CGE	00002	HUGHES NETWORK SYSTEMS	00702	NEC	00402	SAVILLE	02702
CIMLINE	01402	HYPSON	01402	NEC	00402	SBR	01502
CINERAL	02102	IMPERIAL	00002	NIKKO	00402	SCHAUB LORENZ	
CITIZEN	00402, 02102, 04302	INTERFUNK	01502	NOBLEX	02002		00002, 00602, 01602
COLT	01402	ITT	00602, 01602, 02002	NOKIA	00602, 01602, 02002	SCHNEIDER	00002, 01402, 01502
COMBITECH	02702	ITV	00402, 02102	NORDMENDE	00602, 02402	SCOTT	00802, 00902, 01702
CRAIG	00402, 01002, 01402, 02002	JENSEN	00602	OCEANIC	00002, 00602	SEARS	00002, 00302, 00402, 00702, 01002, 01602, 04202
CROWN	01402, 02102	JVC	00602, 00902, 01302	OKANO	02302, 02602	SEG	02002
CURTIS MATHES	00302, 00602, 01202, 03702	KAISUI	01402	OLYMPUS	00302, 01902	SEI	01502
CYBERNEX	02002			OPTIMUS	00402, 01102, 01602, 02802	SELECO	00602
CYRUS	01502			ORION	01702, 02602, 02702, 04402	SEMP	00902
DAEWOO	00902, 01602, 02102, 03402, 04302			OSAKI	00002, 00402, 01402		
DANSAI	01402						

SHARP 01102, 03502
 SHINTOM 01402, 01602
 SIEMENS 00402, 01502, 01602
 SILVA 00402
 SINGER 00902, 01402
 SINUDYNE 01502
 SONIC BLUE 03002, 03102
 SONTEC 00402
 SONY 00002, 00102, 00202, 00302, 03302, 04102
 STS 00702
 SUNKAI 02602
 SUNSTAR 00002
 SUNTRONIC 00002
 SYLVANIA 00002, 00302, 00802, 01502
 SYMPHONIC 00002
 TANDY 00002, 01602
 TASHIKO 00002, 00402
 TATUNG 00002, 00602, 00902, 01302, 01502
 TEAC 00002, 00602, 02102, 02202, 03402
 TECHNICS 00302, 01902
 TECO 00302, 00402, 00602, 01102
 TEKNIKA 00002, 00302, 00402
 TELEAVIA 00602
 TELEFUNKEN 00602, 02402
 TENOSAL 01402
 TENSAI 00002
 THOMAS 00002
 THOMSON 00602, 01202, 01302, 02402
 THORN 00602, 01602
 TIVO 03202, 03302
 TMK 02002
 TOSHIBA 00602, 00802, 00902, 01302, 01502, 03602
 TOTEVISION 00402, 02002
 UHER 02002
 UNITECH 02002
 UNIVERSUM 00002, 00402, 01502, 02002
 VECTOR 00902
 VICTOR 00602, 01302
 VIDEO CONCEPTS 00902
 VIDEOMAGIC 00402
 VIDEOSONIC 02002
 VILLAIN 00002
 WARDS 00002, 00302, 00702, 01002, 01102, 01202, 01402, 01502, 02002
 WHITE WESTINGHOUSE 01402
 XR-1000 00002, 00302, 01402
 YAMAHA 00602
 YAMISHI 01402
 YOKAN 01402
 YOKO 02002
 ZENITH 00002, 00202, 00502, 04402

CABLE

ABC 00103, 00203
 AMERICAST 02003
 BELL SOUTH 02003
 BIRMINGHAM CABLE COMMUNICATIONS 00803
 BRITISH TELECOM 00103
 DAERYUNG 00203, 01403, 01903
 DIRECTOR 01303
 FILMNET 01203
 GENERAL INSTRUMENT 00103, 00803, 01303, 01703
 GOLDSTAR 00503
 HAMLIN 00303, 00703
 JERROLD 00103, 00803, 01303, 01703
 LG 00503
 MEMOREX 00003
 MNET 01203
 MOTOROLA 00803, 01303, 01703, 02303
 NOOS 01803
 PACE 00603, 02203
 PANASONIC 00003, 00203, 00403
 PARAGON 00003
 PHILIPS 01003, 01103
 PIONEER 00503, 01603, 01903
 PULSAR 00003
 PVP STEREO VISUAL MATRIX 00103
 QUASAR 00003
 RCA 02403, 02503
 REGAL 00703, 00903
 RUNCO 00003
 SAGEM 01803
 SAMSUNG 00003, 00503
 SCIENTIFIC ATLANTA 00203, 01403, 01903
 SONY 02103
 STARCOM 00103
 SUPERCABLE 00803
 TELE+1 01203
 TORX 00103
 TOSHIBA 00003
 TRANS PX 00803
 TS 00103
 UNITED CABLE 00103
 ZENITH 00003, 01503, 02003

SATELLITE TUNER

@SAT 06404
 ABSAT 00104
 ALBA 01404
 ALPHASTAR 02504
 AMSTRAD 03004
 ASTON 00304, 05004
 ASTRO 00604
 ATSAT 06404
 AVALON 01304
 BLAUPUNKT 00604
 BRITISH SKY BROADCASTING 03004, 05204
 CANAL DIGITAL 03104

CANAL SATELLITE

03104
 CANAL+ 03104
 CHAPARRAL 00804
 CITYCOM 05304
 CONNEXIONS 01304
 CROSSDIGITAL 04604
 CYRUS 00704
 DAERYUNG 01304
 DAEWOO 06304
 D-BOX 02104, 04904
 DIGENIUS 01104
 DIRECTV 00904, 01204, 01504, 01704, 02204, 02304, 02804, 04104, 04604, 05104, 06904
 DISH NETWORK SYSTEM 02604, 03704
 DISHPRO 02604, 03704
 DISTRATEL 00004
 DMT 04004
 DNT 00704, 01304
 DREAM MULTIMEDIA 05804
 ECHOSTAR 00504, 01304, 01604, 02604, 03104, 03604, 03704, 04304
 ENGEL 03804
 EXPRESSVU 02604
 FINLUX 01404
 FOXTEL 07004, 07104, 07204, 07304, 07404
 FRACARRO 03604
 FTE 03404
 FUBA 01304
 GALAXIS 03404, 04704
 GE 01504
 GENERAL INSTRUMENT 03504
 GOI 02604
 GOLD BOX 03104
 GRUNDIG 00604, 03004
 HIRSCHMANN 00604, 01304
 HITACHI 01404, 02804
 HTS 02604
 HUGHES NETWORK SYSTEM 02304, 05104, 06904
 HUMAX 03404, 05304
 INVIDEO 03604
 JVC 02604
 KATHREIN 00104, 00604, 00704, 01004, 01804, 05604
 KREISELMEYER 00604
 LABGEAR 06304
 LOGIX 03804
 LORENZEN 01104
 MAGNAVOX 02004, 02204
 MANHATTAN 01404, 03804, 04204
 MARANTZ 00704
 MEDIASAT 03104
 MEMOREX 02204
 METRONIC 00004
 MITSUBISHI 02304
 MOTOROLA 03504
 MYRYAD 00704
 NEXT LEVEL 03504

NOKIA 01404, 02104, 02404, 04904, 05704, 06804
 OCTALTV 03704
 ORBITECH 04504
 PACE 01404, 03004, 05204, 06604
 PANASONIC 00904, 01904, 03004, 06504
 PANDA 01404
 PAYSAT 02204
 PHILIPS 00204, 00704, 01404, 02004, 02204, 02304, 03104, 04104, 05104, 06904
 PIONEER 03104
 PROMAX 01404
 PROSCAN 01204, 01504
 RADIOLA 00704
 RADIOSHACK 03504
 RADIX 01304
 RCA 00404, 01204, 01504, 03204
 RFT 00704
 SABRE 01404
 SAGEM 02904, 04804, 05904
 SAMSUNG 03804, 04604, 06004, 06204
 SAT CONTROL 06404
 SATSTATION 04204
 SCHWAIGER 04704
 SEEMANN 01304
 SIEMENS 00604
 SKY 03004, 03304, 05204
 SM ELECTRONIC 05404
 SONY 01704, 03004, 06704
 STAR CHOICE 03504
 STRONG 06404
 TANTEC 01404
 TECHNISAT 04404, 04504
 TELESTAR 04504
 THOMSON 01404, 03104, 03904, 06104
 TOPFIELD 05504
 TOSHIBA 02304, 02704, 06904
 TPS 02904, 05904
 ULTIMATETV 01204, 01704
 UNIDEN 02004, 02204
 UNIVERSUM 00604
 VENTANA 00704
 WISI 00604, 01304, 01404
 XSAT 00104
 ZEHLER 04004
 ZENITH 03304

CD PLAYER

AIWA 00605
 ARCAM 00605
 AUDIO RESEARCH 00605
 AUDIO TON 00605
 AUDIOLAB 00605
 AUDIOMECA 00605
 CAIRN 00605
 CALIFORNIA AUDIO LABS 00205
 CARVER 00605, 00805

CYRUS 00605
DENON 01005
DKK 00005
DMX ELECTRONICS 00605
DYNAMIC BASS 00805
EMERSON 00905
FISHER 00805
GENEXXA 00305, 00905
GOODMANS 00905
GRUNDIG 00605
HARMAN/KARDON 00605, 00705
HITACHI 00305
JVC 00505
KENWOOD 00105, 00405
KRELL 00605
LINN 00605
LXI 00905
MAGNAVOX 00605, 00905
MARANTZ 00205, 00605
MATSUI 00605
MCS 00205
MEMOREX 00905
MERIDIAN 00605
MICROMEGA 00605
MIRO 00005
MISSION 00605
MYRYAD 00605
NAD 00005
NAIM 00605
NSM 00605
OPTIMUS 00005, 00305, 00405, 00805, 00905
PANASONIC 00205
PHILIPS 00605
PIONEER 00305, 00905
POLK AUDIO 00605
PROTON 00605
QED 00605
QUAD 00605
QUASAR 00205
RCA 00305, 00805, 00905
REALISTIC 00805
REVOX 00605
ROTEL 00605
SAE 00605
SANSUI 00605, 00905
SANYO 00805
SCOTT 00905
SEARS 00905
SHARP 00405
SIMAUDIO 00605
SONIC FRONTIERS 00605
SONY 00005
SYMPHONIC 00905
TAG MCLAREN 00605
TANDY 00305
TECHNICS 00205
THORENS 00605
THULE 00605
UNIVERSUM 00605
VICTOR 00505
WARDS 00605
YAMAHA 01105, 01205

CD RECORDER

KENWOOD 01305
MARANTZ 01305

PHILIPS 01305
YAMAHA 01405

BLU-RAY/DVD PLAYER

ACOUSTIC SOLUTIONS

ALBA 02606
AMSTRAD 02306
APEX DIGITAL 02106, 02606, 03006, 03506, 03606, 03706, 04106

BLAUPINKT 02606
BLUE PARADE 01006
BUSH 02306
CENTREX 02106
CLATRONIC 03406
CYBERHOME 02406
DAEWOO 03206, 03306
DANSAI 03206
DECCA 03206
DENON 00006
DIAMOND 03106
DIGITREX 02106
DVD2000 02006
EMERSON 01206
ENTERPRISE 01206
FISHER 02006
GE 00306, 02606
GO VIDEO 02506
GOLDSTAR 02906, 04906
GRADIENTE 01806
GREENHILL 02606
GRUNDIG 00706
HITACHI 01106, 01507, 01906

HITEKER 02106
JVC 00906, 01306
KENWOOD 00006, 00606
KLH 02606
KOSS 01806
LG 02906
LIMIT 03106
MAGNAVOX 00106, 02206
MARANTZ 00706
MEMOREX 03806
MICO 02706
MICROSOFT 00306
MINTEK 02606
MITSUBISHI 00206
MUSTEK 02806
NESA 02606
ONKYO 00106, 04806
ORITRON 01806
PALSONIC 02106
PANASONIC 00006, 00007, 00107, 00207, 01606, 04206, 05006

PHILIPS 00106, 00706, 00807, 01706, 03906, 05206
PIONEER 00406, 00407, 00507, 00607, 01006, 01506, 01606, 05306

POLK AUDIO 00706
PROSCAN 00306
QWESTAR 01806
RCA 00306, 01006, 02606, 04806

ROTEL 01306
SAMSUNG 01106, 04506
SANYO 02006

SHARP 01207, 01307, 01406
SHERWOOD 03206
SHINSONIC 00506
SLIM ART 03306
SM ELECTRONIC 02806

SONY 00506, 00907, 01007, 01107, 04006, 05106

SYLVANIA 02206
TATUNG 03206
TEAC 01006, 02606
TECHNICS 00006
THETA DIGITAL 01006

THOMSON 00306
TOSHIBA 00106, 00307, 04606, 04806, 05406

URBAN CONCEPTS 00106

VICTOR 01407
XBOX 00306
YAMAHA 00006, 00706, 00707, 00806, 04306, 04406, 04706

ZENITH 00106, 01206, 02906

ZEUS 03306

LD PLAYER

CARVER 00108
DENON 00008
MARANTZ 00108
MITSUBISHI 00008
NAD 00008
NAGSMI 00008
OPTIMUS 00008
PHILIPS 00108
PIONEER 00008
SALORA 00108
SONY 00208
TELEFUNKEN 00008
YAMAHA 00308

MD RECORDER

KENWOOD 00109
ONKYO 00309
SHARP 00209
SONY 00009
YAMAHA 00409, 00509, 00609

RECEIVER (TUNER)

ADC 00710
AIWA 00410, 01210, 03610, 03910, 04410
ALCO 03810
ANAM 04310
APEX DIGITAL 01810
AUDIOLAB 01510
AUDIOTRONIC 01510
AUDIOVOX 03810
BOSE 01610
CAMBRIDGE SOUNDWORKS 03310
CAPETRONIC 00710
CARVER 01210, 01510
CENTREX 01810

DENON 03210
FERGUSON 00710
FINE ARTS 01510
GRUNDIG 01510
HARMAN/KARDON 00210, 02610
INTEGRA 00310, 02510
JBL 00210, 02710
JVC 00110, 00710, 03410, 04110
KENWOOD 01010, 03010
KLH 03810, 04010
MAGNAVOX 00710, 01210, 01510, 02110
MARANTZ 00010, 01210, 01510, 02410
MCS 00010
MICROMEGA 01510
MUSICMAGIC 01210
MYRYAD 01510
NAD 00610
NORCENT 03710
ONKYO 00310, 00810, 02510
OPTIMUS 00710, 00910
PANASONIC 00010, 02310, 04210, 04710
PHILIPS 01210, 01510, 01910, 02010, 02110, 02210, 02410
PIONEER 00710, 00910, 03510

POLK AUDIO 02410
PROSCAN 01710
QUASAR 00010
RCA 00710, 00910, 01710, 03810, 04310
SABA 00710
SANSUI 01210
SCHNEIDER 00710
SONY 00410, 01110, 01310, 04510, 04610

STEREOPHONICS 00910
SUNFIRE 03010
TEAC 03810
TECHNICS 00010, 02810, 02910, 04210

TELEFUNKEN 00710
THOMSON 01710
THORENS 01510
UHER 00710
VENTURER 03810
VICTOR 00110
WARDS 00410
YAMAHA 00510, 01410, 03110, 04810, 05510, 05610, 05710, 05810, 05910, 06010

YAMAHA (iPOD) 05310
YAMAHA (TUNER ID1) 04910
YAMAHA (TUNER ID2) 05010
YAMAHA (XM ID1) 05110
YAMAHA (XM ID2) 05210

TAPE DECK

AIWA	00111
CARVER	00111
GRUNDIG	00111
HARMAN/KARDON	00111
MAGNAVOX	00111
MARANTZ	00111
MYRYAD	00111
OPTIMUS	00011
PHILIPS	00111
PIONEER	00011
POLK AUDIO	00111
RCA	00011
REVOX	00111
SANSUI	00111
SONY	00211
THORENS	00111
WARDS	00011
YAMAHA	00311, 00411



The circled numbers and alphabets correspond to those in the Owner's Manual.
 Les nombres et lettres dans un cercle correspondent à ceux du mode d'emploi.

■ Front panel / Face avant

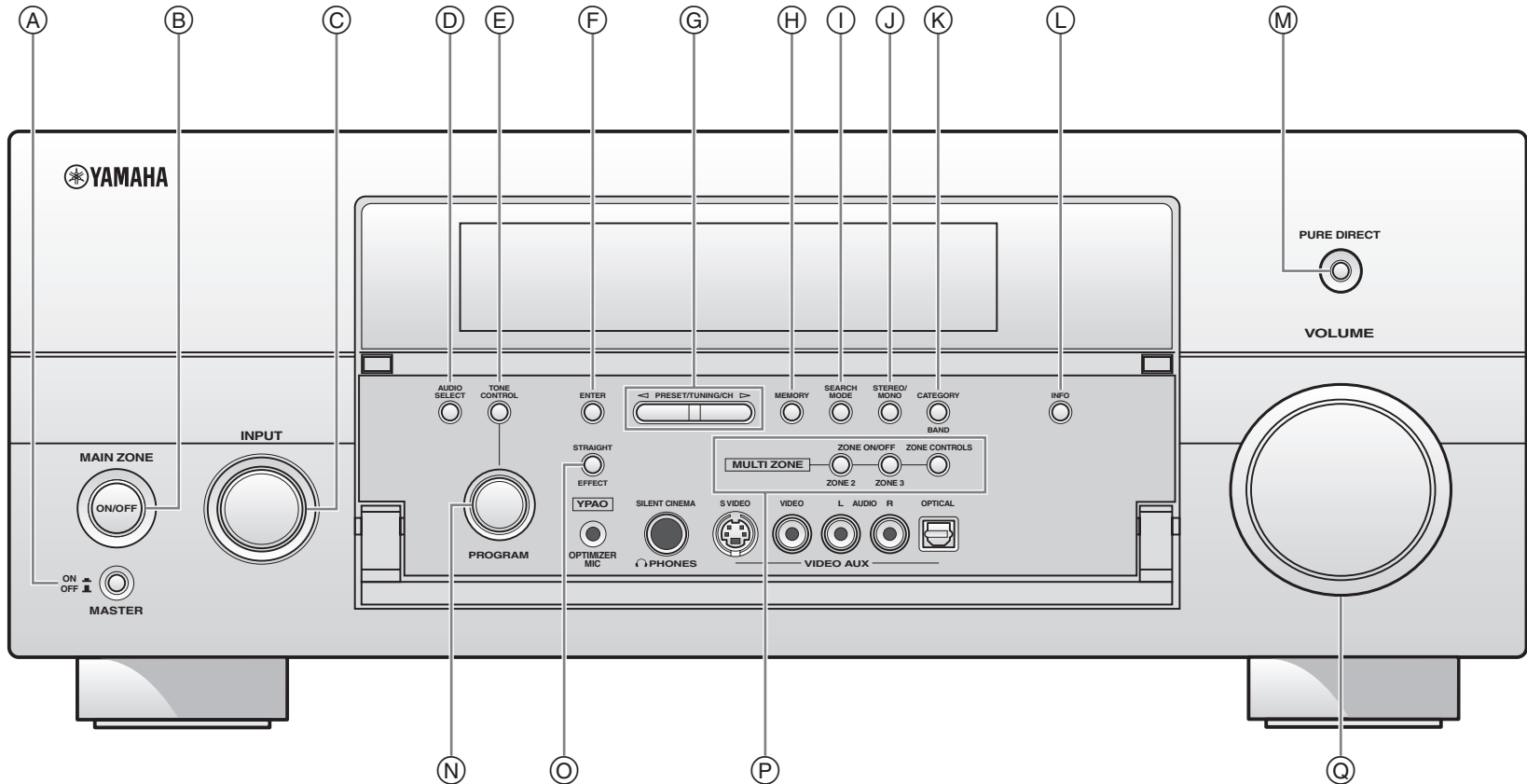

■ Remote control / Boîtier de télécommande

