

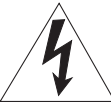



RX-V465

AV Receiver

IMPORTANT SAFETY INSTRUCTIONS



CAUTION
RISK OF ELECTRIC SHOCK DO NOT OPEN



CAUTION: TO REDUCE THE RISK OF ELECTRIC SHOCK, DO NOT REMOVE COVER (OR BACK). NO USER-SERVICEABLE PARTS INSIDE. REFER SERVICING TO QUALIFIED SERVICE PERSONNEL.

• Explanation of Graphical Symbols



The lightning flash with arrowhead symbol, within an equilateral triangle, is intended to alert you to the presence of uninsulated "dangerous voltage" within the product's enclosure that may be of sufficient magnitude to constitute a risk of electric shock to persons.



The exclamation point within an equilateral triangle is intended to alert you to the presence of important operating and maintenance (servicing) instructions in the literature accompanying the appliance.

Note to CATV system installer:

This reminder is provided to call the CATV system installer's attention to Article 820-40 of the NEC that provides guidelines for proper grounding and, in particular, specifies that the cable ground shall be connected to the grounding system of the building, as close to the point of cable entry as practical.

- 1 Read these instructions.
- 2 Keep these instructions.
- 3 Heed all warnings.
- 4 Follow all instructions.
- 5 Do not use this apparatus near water.
- 6 Clean only with dry cloth.
- 7 Do not block any ventilation openings. Install in accordance with the manufacturer's instructions.
- 8 Do not install near any heat sources such as radiators, heat registers, stoves, or other apparatus (including amplifiers) that produce heat.
- 9 Do not defeat the safety purpose of the polarized or grounding-type plug. A polarized plug has two blades with one wider than the other. A grounding type plug has two blades and a third grounding prong. The wide blade or the third prong are provided for your safety. If the provided plug does not fit into your outlet, consult an electrician for replacement of the obsolete outlet.
- 10 Protect the power cord from being walked on or pinched particularly at plugs, convenience receptacles, and the point where they exit from the apparatus.
- 11 Only use attachments/accessories specified by the manufacturer.
- 12 Use only with the cart, stand, tripod, bracket, or table specified by the manufacturer, or sold with the apparatus. When a cart is used, use caution when moving the cart/apparatus combination to avoid injury from tip-over.
- 13 Unplug this apparatus during lightning storms or when unused for long periods of time.
- 14 Refer all servicing to qualified service personnel. Servicing is required when the apparatus has been damaged in any way, such as power-supply cord or plug is damaged, liquid has been spilled or objects have fallen into the apparatus, the apparatus has been exposed to rain or moisture, does not operate normally, or has been dropped.



FCC INFORMATION (for US customers)

1 IMPORTANT NOTICE: DO NOT MODIFY THIS UNIT!

This product, when installed as indicated in the instructions contained in this manual, meets FCC requirements. Modifications not expressly approved by Yamaha may void your authority, granted by the FCC, to use the product.

- 2 **IMPORTANT:** When connecting this product to accessories and/or another product use only high quality shielded cables. Cable/s supplied with this product **MUST** be used. Follow all installation instructions. Failure to follow instructions could void your FCC authorization to use this product in the USA.

- 3 **NOTE:** This product has been tested and found to comply with the requirements listed in FCC Regulations, Part 15 for Class "B" digital devices. Compliance with these requirements provides a reasonable level of assurance that your use of this product in a residential environment will not result in harmful interference with other electronic devices.

This equipment generates/uses radio frequencies and, if not installed and used according to the instructions found in the users manual, may cause interference harmful to the operation of other electronic devices.

Compliance with FCC regulations does not guarantee that interference will not occur in all installations. If this product is found to be the source of interference, which can be determined by turning the unit "OFF" and "ON", please try to eliminate the problem by using one of the following measures:

Relocate either this product or the device that is being affected by the interference.

Utilize power outlets that are on different branch (circuit breaker or fuse) circuits or install AC line filter/s.

In the case of radio or TV interference, relocate/reorient the antenna. If the antenna lead-in is 300 ohm ribbon lead, change the lead-in to coaxial type cable.

If these corrective measures do not produce satisfactory results, please contact the local retailer authorized to distribute this type of product. If you can not locate the appropriate retailer, please contact Yamaha Electronics Corp., U.S.A. 6660 Orangethorpe Ave, Buena Park, CA 90620.

The above statements apply **ONLY** to those products distributed by Yamaha Corporation of America or its subsidiaries.

Caution: Read this before operating your unit.

- 1 To assure the finest performance, please read this manual carefully. Keep it in a safe place for future reference.
- 2 Install this sound system in a well ventilated, cool, dry, clean place – away from direct sunlight, heat sources, vibration, dust, moisture, and/or cold. Allow ventilation space of at least 30 cm on the top, 20 cm on the left and right, and 20 cm on the back of this unit.
- 3 Locate this unit away from other electrical appliances, motors, or transformers to avoid humming sounds.
- 4 Do not expose this unit to sudden temperature changes from cold to hot, and do not locate this unit in an environment with high humidity (i.e. a room with a humidifier) to prevent condensation inside this unit, which may cause an electrical shock, fire, damage to this unit, and/or personal injury.
- 5 Avoid installing this unit where foreign objects may fall onto this unit and/or this unit may be exposed to liquid dripping or splashing. On the top of this unit, do not place:
 - Other components, as they may cause damage and/or discoloration on the surface of this unit.
 - Burning objects (i.e. candles), as they may cause fire, damage to this unit, and/or personal injury.
 - Containers with liquid in them, as they may fall and liquid may cause electrical shock to the user and/or damage to this unit.
- 6 Do not cover this unit with a newspaper, tablecloth, curtain, etc. in order not to obstruct heat radiation. If the temperature inside this unit rises, it may cause fire, damage to this unit, and/or personal injury.
- 7 Do not plug in this unit to a wall outlet until all connections are complete.
- 8 Do not operate this unit upside-down. It may overheat, possibly causing damage.
- 9 Do not use force on switches, knobs and/or cords.
- 10 When disconnecting the power cable from the wall outlet, grasp the plug; do not pull the cable.
- 11 Do not clean this unit with chemical solvents; this might damage the finish. Use a clean, dry cloth.
- 12 Only voltage specified on this unit must be used. Using this unit with a higher voltage than specified is dangerous and may cause fire, damage to this unit, and/or personal injury. Yamaha will not be held responsible for any damage resulting from use of this unit with a voltage other than specified.
- 13 To prevent damage by lightning, keep the power cord and outdoor antennas disconnected from a wall outlet or the unit during a lightning storm.
- 14 Do not attempt to modify or fix this unit. Contact qualified Yamaha service personnel when any service is needed. The cabinet should never be opened for any reasons.
- 15 When not planning to use this unit for long periods of time (i.e. vacation), disconnect the AC power plug from the wall outlet.
- 16 Install this unit near the AC outlet and where the AC power plug can be reached easily.
- 17 Be sure to read the “Troubleshooting” section on common operating errors before concluding that this unit is faulty.
- 18 Before moving this unit, press **(A) STANDBY/ON** to set this unit in the standby mode, and disconnect the AC power plug from the wall outlet.
- 19 **VOLTAGE SELECTOR** (Asia and General models only)
The **VOLTAGE SELECTOR** on the rear panel of this unit must be set for your local main voltage **BEFORE** plugging into the AC wall outlet. Voltages are:
 -AC 110/120/220/230–240 V, 50/60 Hz (General model)
 - AC 220/230–240 V, 50/60 Hz (Asia model)
- 20 The batteries shall not be exposed to excessive heat such as sunshine, fire or like.
- 21 Excessive sound pressure from earphones and headphones can cause hearing loss.
- 22 When replacing the batteries, be sure to use batteries of the same type. Danger of explosion may happen if batteries are incorrectly replaced.

WARNING

TO REDUCE THE RISK OF FIRE OR ELECTRIC SHOCK, DO NOT EXPOSE THIS UNIT TO RAIN OR MOISTURE.

As long as this unit is connected to the AC wall outlet, it is not disconnected from the AC power source even if you turn off this unit by **(A) STANDBY/ON**. In this state, this unit is designed to consume a very small quantity of power.

FOR CANADIAN CUSTOMERS

To prevent electric shock, match wide blade of plug to wide slot and fully insert.
This Class B digital apparatus complies with Canadian ICES-003.

POUR LES CONSOMMATEURS CANADIENS

Pour éviter les chocs électriques, introduire la lame la plus large de la fiche dans la borne correspondante de la prise et pousser jusqu'au fond.
Cet appareil numérique de la classe B est conforme à la norme NMB-003 du Canada.

IMPORTANT

Please record the serial number of this unit in the space below.

MODEL:

Serial No.:

The serial number is located on the rear of the unit. Retain this Owner's Manual in a safe place for future reference.

Contents

INTRODUCTION

Features.....	2
About this manual.....	3
Supplied accessories.....	3
Part names and functions.....	4
Front panel.....	4
Rear panel.....	5
Front panel display.....	6
Remote control.....	7
Quick start guide.....	8

PREPARATION

Preparing remote control.....	9
Installing batteries in the remote control.....	9
Using the remote control.....	9
Connections.....	10
Placing speakers.....	10
Connecting speakers.....	11
Information on jacks and cable plugs.....	13
Connecting a TV monitor or projector.....	14
Connecting other components.....	15
Connecting a Yamaha iPod universal dock or Bluetooth™ wireless audio receiver.....	16
Using the VIDEO AUX jacks on the front panel.....	16
Connecting the FM and AM antennas.....	17
Connecting the power cable.....	17
Turning this unit on and off.....	17
Optimizing the speaker setting for your listening room (YPAO).....	18
Using Auto Setup.....	18
When an error message is displayed during measurement.....	20
When a warning message is displayed after measurement.....	20

BASIC OPERATION

Playback.....	21
Basic procedure.....	21
Using the SCENE function.....	21
Muting audio output temporarily (MUTE).....	22
Adjusting high/low frequency sound (tone control).....	22
Enjoying pure hi-fi sound.....	22
Using the sleep timer.....	22
Using your headphones.....	22
Displaying input signal information.....	23
Changing information on the front panel display.....	23
Enjoy the sound field programs.....	24
Selecting sound field programs.....	24
Enjoying unprocessed input sources (Straight decoding mode).....	27
Enjoying sound field programs without surround speakers (Virtual CINEMA DSP).....	27
Enjoy sound field programs with headphones (SILENT CINEMA™).....	27
FM/AM tuning.....	28
Tuning in to the desired FM/AM station (Frequency tuning).....	28
Registering FM/AM stations and tuning in (Preset tuning).....	28
Using iPod™.....	30
Controlling iPod™.....	30

Using Bluetooth™ components.....	32
Pairing the Bluetooth™ wireless audio receiver and your Bluetooth component.....	32
Playback of the Bluetooth™ component.....	32

ADVANCED OPERATION

Setting the option menu for each input source (OPTION menu).....	33
OPTION menu items.....	33
Editing surround decoders/sound field programs	36
Selecting a decoder used with a sound field program	36
Setting sound field parameters.....	36
Sound field parameters.....	36
Operating various settings for this unit (Setup menu).....	38
Basic operation of the setup menu.....	39
Speaker Setup.....	39
Sound Setup.....	41
Function Setup.....	42
DSP Parameter.....	43
Memory Guard.....	43
Controlling other components with the remote control.....	44
Setting remote control codes.....	44
Resetting all remote control codes.....	44
Advanced setup.....	45

APPENDIX

Troubleshooting.....	46
General.....	46
HDMI.....	49
Tuner (FM/AM).....	49
Remote control.....	50
iPod.....	50
Bluetooth™.....	51
Auto Setup (YPAO).....	51
Glossary.....	53
Sound field program information.....	55
Information on HDMI™.....	55
Specifications.....	56
Index.....	57

(at the end of this manual)

List of remote control codes.....	i
-----------------------------------	---

INTRODUCTION

Features

■ Built-in 5-channel power amplifier

- Minimum RMS output power (1 kHz, 0.9% THD, 8 Ω)
- FRONT L/R: 105 W + 105 W
- CENTER: 105 W
- SURROUND L/R: 105 W + 105 W

■ Speaker/Preout outputs

- Speaker jacks (5-channel), preout output jacks (surround back L/R, subwoofer)

■ Input/Output terminals

Input terminals

- HDMI input x 4
- Audio/Visual input
 - [Audio] Digital input (coaxial) x 2, digital input (optical) x 2, analog input x 2
 - [Video] Component video x 2, composite video x 4
- Audio input (analog) x 2
- Dock input x 1
- V-AUX input
 - [Audio] Analog x 1
 - [Video] Composite video x 1

Output terminals

- Monitor output
 - [Audio/Video] HDMI x 1
 - [Video] Component video x 1, Composite video x 1
- Audio/Visual output
 - [Audio] Analog x 1
 - [Video] Composite video x 1
- Audio output
 - Analog x 1

■ Proprietary Yamaha technology for the creation of sound fields

- CINEMA DSP
- Compressed Music Enhancer mode
- Virtual CINEMA DSP
- SILENT CINEMA

■ Digital audio decoders

- Dolby TrueHD, Dolby Digital Plus decoder
- DTS-HD Master Audio, DTS-HD High Resolution Audio, DTS Express
- Dolby Digital/Dolby Digital EX decoder
- DTS, DTS 96/24 decoder, DTS-ES Matrix 6.1, DTS-ES Discrete 6.1
- Dolby Pro Logic/Dolby Pro Logic II/Dolby Pro Logic IIx decoder
- DTS NEO:6 decoder

■ Sophisticated FM/AM tuner

- 40-station random and direct preset tuning
- Automatic preset tuning

■ HDMI™

(High-Definition Multimedia Interface)

- HDMI interface for standard, enhanced or high-definition video as well as multi-channel digital audio.
 - Automatic audio and video synchronization (lip sync) information capability
 - Deep Color video signal (30/36 bit) transmission capability
 - “x.v.Color” video signal transmission capability
 - High refresh rate and high resolution video signals capability
 - High definition digital audio format signals capability

■ DOCK terminal

- DOCK terminal to connect a Yamaha iPod universal dock (such as YDS-11, sold separately) or Bluetooth wireless audio receiver (such as YBA-10, sold separately)



■ Automatic speaker setup features

- “YPAO” (Yamaha Parametric Room Acoustic Optimizer) for automatically optimizing speaker outputs suitable for listening environments.

■ Other features

- 192-kHz/24-bit D/A converter
- Direct mode for pure hi-fi sound for all sources
- Adaptive dynamic range controlling capability
- Sleep timer

About this manual

-  indicates a tip for your operation.
- Some operations can be performed by using either the keys on the front panel or the ones on the remote control. In case the key names differ between the front panel and the remote control, the key name on the remote control is given in parentheses.
- This manual is printed prior to production. Design and specifications are subject to change in part as a result of improvements, etc. In case of differences between the manual and product, the product has priority.
- “**(A)STANDBY/ON**” or “**(7)HDMI 1**” (example) indicates the name of the parts on the front panel or the remote control. Refer to the attached sheet or the pages at the end of this manual for the information about each position of the parts.
-  indicates the page describing the related information.



Manufactured under license from Dolby Laboratories.

Dolby, Pro Logic and the double-D symbol are trademarks of Dolby Laboratories



Manufactured under license under U.S. Patent No's:

5,451,942;5,956,674;5,974,380;5,978,762;6,226,616;6,487,535 & other U.S. and worldwide patents issued & pending. DTS is a registered trademark and the DTS logos, Symbol, DTS-HD and DTS-HD Master Audio are trademark of DTS, Inc. © 1996-2007 DTS, Inc. All Rights Reserved.

iPod™

“iPod” is a trademark of Apple Inc., registered in the U.S. and other countries.

Bluetooth™

Bluetooth is a registered trademark of Bluetooth SIG and is used by Yamaha in accordance with a license agreement.



“HDMI,” the “HDMI” logo and “High-Definition Multimedia Interface” are trademarks, or registered trademarks of HDMI Licensing LLC.

x.v.Color™

“x.v.Color” is a trademark of Sony Corporation. “SILENT CINEMA” is a trademark of Yamaha Corporation.

SILENT™ CINEMA

“SILENT CINEMA” is a trademark of Yamaha Corporation.

Supplied accessories

Check that you received all of the following parts.

- Remote control
- Batteries (2) (AAA, R03, UM-4)
- Optimizer microphone
- AM loop antenna
- Indoor FM antenna

Part names and functions

Front panel

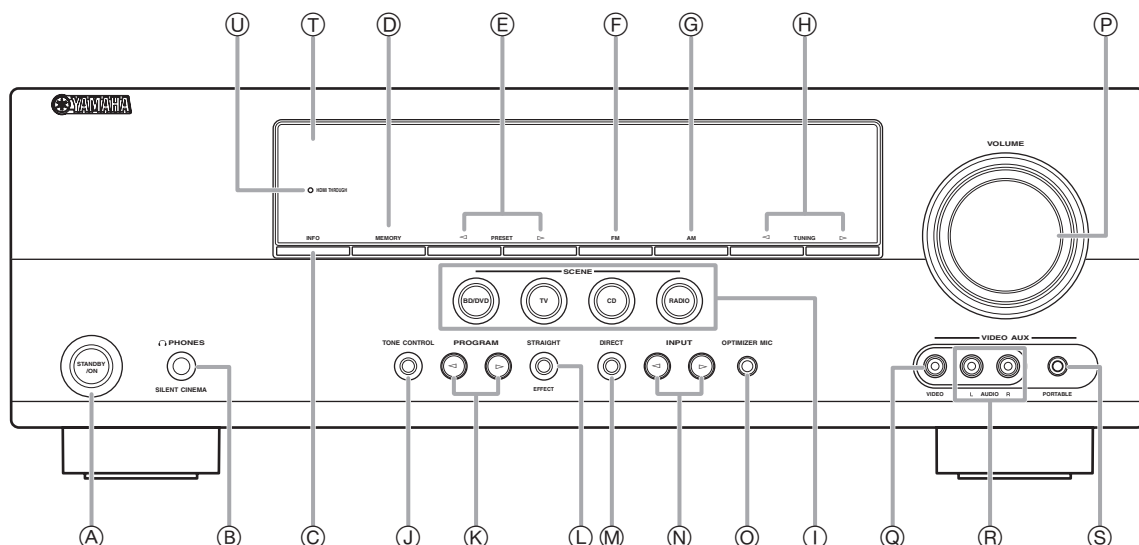

- (A) STANDBY/ON**
Switches this unit between standby and on (see page 17).
- (B) PHONES jack**
For plugging headphones (see page 22).
- (C) INFO**
Changes information display screens on the front panel display (see page 23).
- (D) MEMORY**
Registers FM/AM stations as preset stations (see page 29).
- (E) PRESET </>**
Selects an FM/AM preset station (see page 29).
- (F) FM**
Sets the FM/AM tuner band to FM (see page 28).
- (G) AM**
Sets the FM/AM tuner band to AM (see page 28).
- (H) TUNING </>**
Changes FM/AM tuner frequencies (see page 28).
- (I) SCENE**
Switches between linked sets of input sources and sound field programs (see page 21).
- (J) TONE CONTROL**
Adjusts high-frequency/low-frequency output of speakers (see page 22).
- (K) PROGRAM </>**
Changes sound field programs (see page 24).
- (L) STRAIGHT**
Changes a sound field program to straight decoding mode (see page 27).
- (M) DIRECT**
Changes a sound field program to direct mode (see page 22).
- (N) INPUT </>**
Selects an input source (see page 21).
- (O) OPTIMIZER MIC jack**
For connecting the supplied optimizer microphone and adjusting output characteristics of speakers (see page 18).
- (P) VOLUME control**
Controls the volume of this unit (see page 21).
- (Q) VIDEO (VIDEO AUX) jack**
For connecting the video output cable of a camcorder or game console (see page 16).
- (R) AUDIO L/R (VIDEO AUX) jack**
For connecting the audio output cable of a camcorder or game console (see page 16).
- (S) PORTABLE (VIDEO AUX) jack**
For connecting the audio output cable of a portable music player (see page 16).
- (T) Front panel display**
Displays information on this unit (see page 6).
- (U) HDMI THROUGH**
Lights up during pass-through output of an HDMI signal input to this unit while this unit is on standby (see page 42).

Rear panel

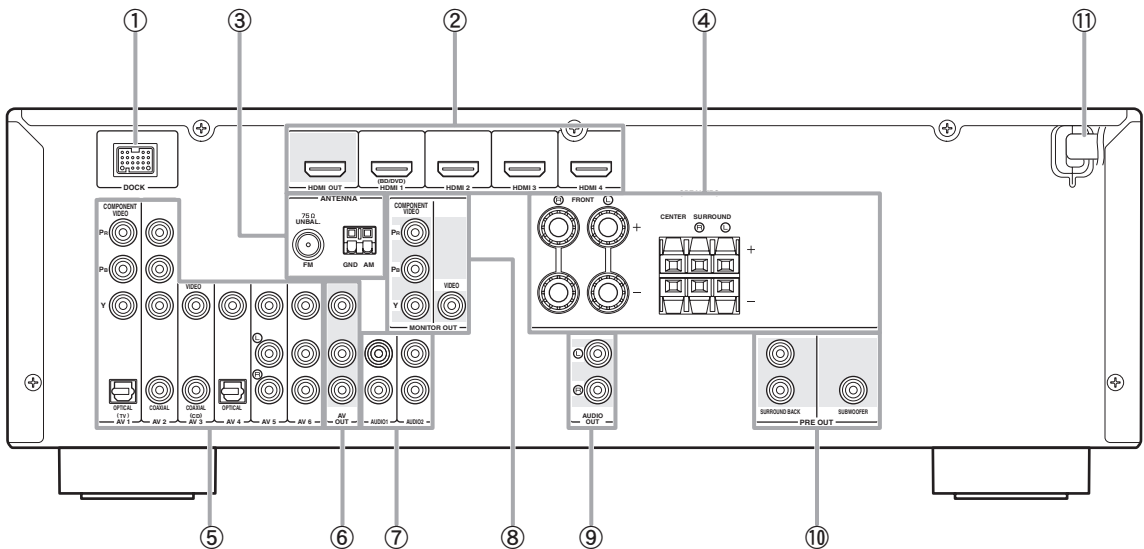

- ① **DOCK terminal**
For connecting an optional Yamaha iPod universal dock (YDS-11) or Bluetooth wireless audio receiver (YBA-10) (see page 16).
- ② **HDMI OUT/HDMI 1-4**
For connecting an HDMI-compatible video monitor or external components for HDMI inputs 1-4 (see page 15).
- ③ **ANTENNA jack**
For connecting supplied FM and AM antennas (see page 17).
- ④ **SPEAKERS terminal**
For connecting front right and left, center and surround speakers (see page 11).
- ⑤ **AV 1-6**
For connecting external components for audio/visual inputs 1-6 (see page 15).
- ⑥ **AV OUT**
Outputs audio/visual signals from a selected analog input source to an external component (see page 16).
- ⑦ **AUDIO 1/2**
For connecting external components for audio inputs 1-2 (see page 16).
- ⑧ **MONITOR OUT**
Outputs visual signals from this unit to a video monitor, such as a TV (see page 14).
- ⑨ **AUDIO OUT**
Outputs audio signals from a selected analog input source to an external component (see page 16).
- ⑩ **PRE OUT**
Outputs the surround back L/R channel signals and subwoofer channel signals. For connecting an external amplifier or subwoofer (see page 11).
- ⑪ **Power Cable**
For connecting this cable to an AC wall outlet (see page 17).

Front panel display

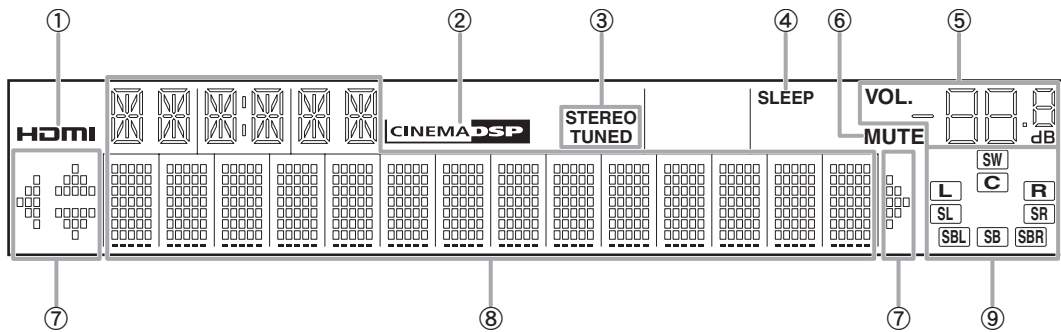

- ① **HDMI indicator**
Lights up during normal communication when HDMI is selected as an input source.
- ② **CINEMA DSP indicator**
Lights up when a sound field program that uses CINEMA DSP is selected.
- ③ **Tuner indicator**
Lights up while receiving a radio broadcast signal from an FM/AM station (see page 28).
- ④ **SLEEP indicator**
Lights up when the sleep timer is activated (see page 22).
- ⑤ **VOLUME indicator**
Displays volume levels.
- ⑥ **MUTE indicator**
Flashes when audio is muted.
- ⑦ **Cursor indicators**
Light up if corresponding cursors on the remote control are available for operations.
- ⑧ **Multi information display**
Displays menu items and settings for the current operation.
- ⑨ **Speaker indicators**
Indicate speaker terminals or the PRE OUT jack from which signals are currently output.

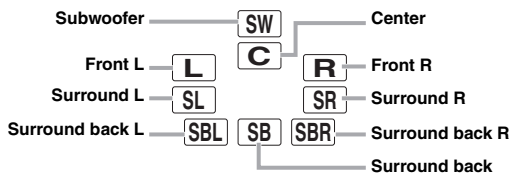

Remote control

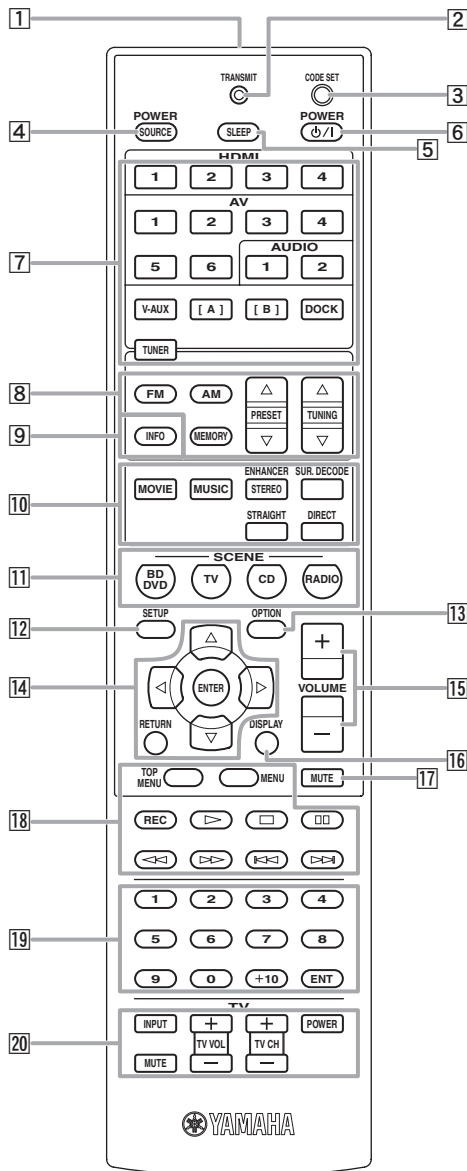

- 1 Remote control signal transmitter**
Transmits infrared signals.
- 2 TRANSMIT**
Lights up when a signal is output from the remote control.
- 3 CODE SET**
Sets remote control codes for external component operations (see page 44).
- 4 SOURCE POWER**
Switches an external component on and off.
- 5 SLEEP**
Switches the sleep timer operations (see page 22).
- 6 POWER**
Switches this unit on and standby.

7 Input selection keys

HDMI 1-4
AV 1-6
AUDIO 1/2
V-AUX

Selects HDMI inputs 1 through 4.
Selects AV inputs 1 through 6.
Selects AUDIO inputs 1 and 2.
Selects the V-AUX jack on the front panel of this unit.

[A]/[B]

To control external components using the **18 External component operation keys** separately from

operations of this unit (see page 44).

DOCK

Selects a Yamaha iPod universal dock/Bluetooth wireless audio receiver connected to the DOCK jack.

TUNER

Selects the FM/AM tuner.

8 Tuner keys

FM

Switches a band between FM and AM.

AM

MEMORY

Presets radio stations.

PRESET Δ / ∇

Selects a preset station.

TUNING Δ / ∇

Changes tuning frequencies.

9 INFO

Changes the information shown on the front panel display (see page 23).

10 Sound selection keys

Selects sound field programs (see pages 22 and 24).

11 SCENE

Switches between linked sets of input sources and sound field programs (see page 21).

12 SETUP

Displays the setup menu (see page 39).

13 OPTION

Displays the option menu (see page 33).

14 Cursors $\Delta / \nabla / \triangleleft / \triangleright$ / ENTER / RETURN

Cursors $\Delta / \nabla / \triangleleft / \triangleright$ Select menu items displayed on the front panel display or change settings.

ENTER Confirms a selected item.

RETURN Returns to the previous screen or ends the menu screen.

15 VOLUME +/-

Adjust the volume of this unit (see page 21).

16 DISPLAY

Changes the operation mode of the iPod connected to the Yamaha iPod universal dock (see page 30).

17 MUTE

Turns the mute function of the sound output on and off (see page 22).

18 External component operation keys

Operate recording, playback etc. of external components (see page 44).

19 Numeric keys

Enter numbers.

20 TV control keys

Operate a monitor such as a TV or projector.

Quick start guide

When you use this product for the first time, perform setup following the steps below. See the related pages for details on operations and settings.

Step 1: Prepare items for setup

Prepare speakers, DVD player, cables, and other items necessary for setup.

For example, prepare the following items for setting up a 5.1-channel sound system.

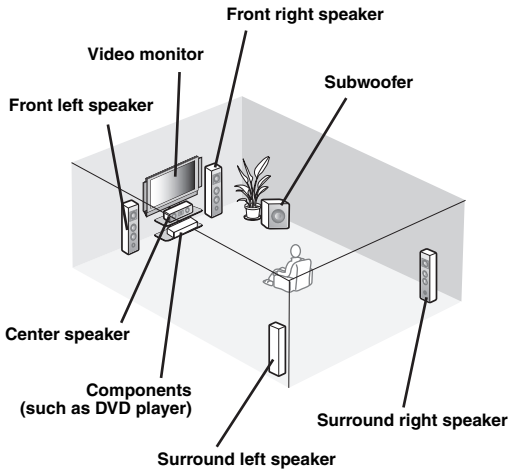

Requirements		qty.
Speakers	Front speaker	2
	Center speaker	1
	Surround speaker	2
Active subwoofer		1
Speaker cable		5
Subwoofer cable		1
Reproduction component such as DVD player		1
Video monitor such as TV		1
Video cable or HDMI cable		2
Audio cable		2

- ☀️
 - Prepare two speakers (for front). The priority of the requirement of other speakers is as follows:
 - 1 Two surround speakers
 - 2 One center speaker
 - For surround back speakers, prepare speakers with another amplifier connected.
 - If your video monitor is a CRT, we recommend that you use magnetically shielded speakers.

Step 2: Set up your speakers

Place your speakers in the room and connect them to this unit.

- Placing speakers ☞ P. 10
- Connecting speakers ☞ P. 11



- This unit has a YPAO (Yamaha Parametric Room Acoustic Optimizer) that automatically optimizes this unit based on room acoustic characteristics (audio characteristics of the speakers, speaker positions, and room acoustics, etc.). You can enjoy good balanced sound without special knowledge by using the YPAO technology (see page 18).

Step 3: Connect your components

Connect your TV, DVD player, or other components.

- Connecting a TV monitor or projector ☞ P. 14
- Connecting other components ☞ P. 15
- Connecting a Yamaha iPod universal dock or Bluetooth wireless audio receiver ☞ P. 16
- Connecting the FM and AM antennas ☞ P. 17

Step 4: Turn on the power

Connect the power cable and turn on this unit.

- Connecting the power cable ☞ P. 17
- Turning this unit on and off ☞ P. 17

Step 5: Select the input source and start playback

Select the component connected in the step 3 as an input source and start playback.

- Basic procedure ☞ P. 21
- Selecting sound field programs ☞ P. 24



- This unit supports the SCENE function that changes the input source and sound field program at one time. Four scenes are preset for different purposes for Blu-ray disc, DVD and CD, and you can select from a scene from those just by pressing a remote control key. See page 21 for details.

PREPARATION

Preparing remote control

Installing batteries in the remote control

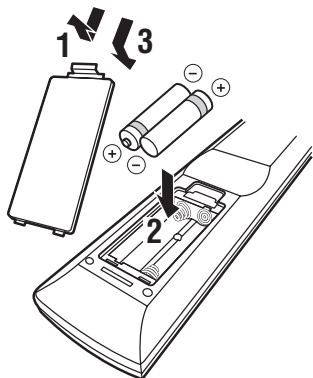

- 1** Take off the battery compartment cover.
- 2** Insert the two supplied batteries (AAA, R03, UM-4) according to the polarity markings (+ and -) on the inside of the battery compartment.
- 3** Snap the battery compartment cover back into place.

Notes

- Change all batteries if you notice the following conditions:
 - the operation range of the remote control narrows
 - the transmit indicator does not flash or is dim
- Do not use old batteries together with new ones.
This may shorten the life of the new batteries or cause old batteries to leak.
- Do not use different types of batteries (such as alkaline and manganese batteries) together. Specification of batteries may be different even though they look the same.
- If you find leaking batteries, discard the batteries immediately, taking care not to touch the leaked material. If the leaked material comes into contact with your skin or gets into your eyes or mouth, rinse it away immediately and consult a doctor. Clean the battery compartment thoroughly before installing new batteries.
- Dispose of the old batteries correctly in accordance with your local regulations.
- If the remote control is without batteries for more than 2 minutes, or if exhausted batteries remain in the remote control, the contents of the memory may be cleared. In such a case, install new batteries and set the remote control code.

Using the remote control

The remote control transmits a directional infrared ray. Be sure to aim the remote control directly at the remote control sensor on this unit during operation.

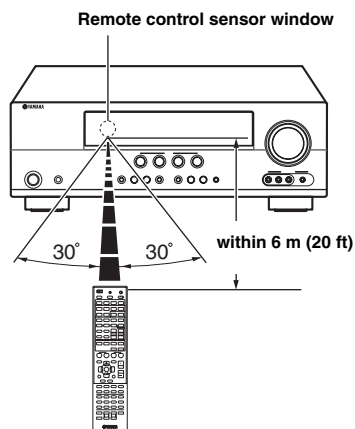

Notes

- Do not spill water or other liquids on the remote control.
- Do not drop the remote control.
- Do not leave or store the remote control in the following conditions:
 - places of high humidity, such as near a bath
 - places of high temperatures, such as near a heater or stove
 - places of extremely low temperatures
 - dusty places
- ☀️ You can operate external components with this remote control by setting the remote control code. See page 44 for details.

Placing speakers

This unit supports up to 7.1-channel surround. We recommend the following speaker layout in order to obtain the optimum surround effect.

7.1-channel speaker layout

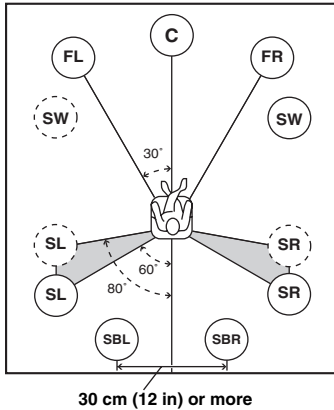

6.1-channel speaker layout

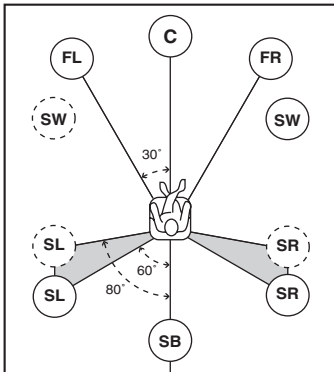

5.1-channel speaker layout

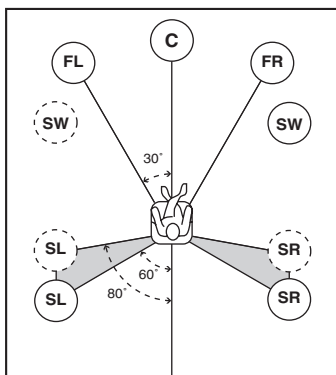

Speaker channels

■ Front left and right speakers (FL and FR)

The front speakers are used for the front channel sounds (stereo sound) and effect sounds. Place these speakers at an equal distance from the ideal listening position. When using a screen, the appropriate top positions of the speakers are about 1/4 of the screen from the bottom.

■ Center speaker (C)

The center speaker is for the center channel sounds (dialog, vocals, etc.). Place it halfway between the left and right speakers. When using a TV, place the speaker just above or just under the center of the TV with the front surfaces of the TV and the speaker aligned. When using a screen, place it just under the center of the screen.

■ Surround left and right speakers (SL and SR)

The surround speakers are used for effect and surround sounds.

Place them at the rear left and rear right facing the listening position.

To obtain a natural sound flow in the 5.1-channel speaker layout, place them slightly further back than in the 7.1-channel speaker layout.

■ Surround back left and right speakers (SBL and SBR) / Surround back speaker (SB)

The surround back left and right speakers are used for rear effect sounds. When using the surround back speakers, connect an external amplifier to the SURROUND BACK jacks of the PRE OUT terminals. Place them at the rear of the room facing the listening position at least 30 cm away from each other, ideally at the same distance as that between the front left and right speakers.

In the 6.1-channel speaker layout, surround back left and right channel sound signals are mixed down and output from the single surround back speaker.

In the 5.1-channel speaker layout, surround back left and right channel sound signals are output from the surround left and right speakers.

■ Subwoofer (SW)

The subwoofer speaker is used for bass sounds and low-frequency effect (LFE) sounds included in Dolby Digital and DTS signals. Use a subwoofer with a built-in amplifier, such as the Yamaha Active Servo Processing Subwoofer System. Place it exterior to the front left and right speakers facing slightly inward to reduce reflections from a wall.

Connecting speakers

When you connect speakers, connect them to the respective terminals as follows, according to your speaker layout.

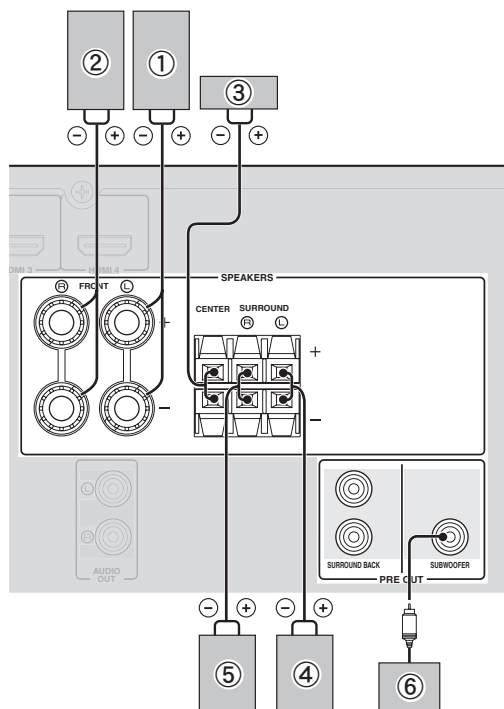

■ 5.1-channel

Speakers	Jacks on this unit
① Front speaker L	FRONT (L)
② Front speaker R	FRONT (R)
③ Center speaker	CENTER
④ Surround speaker L	SURROUND (L)
⑤ Surround speaker R	SURROUND (R)
⑥ Subwoofer	SUB WOOFER

Connecting the surround back speakers

Connecting an external amplifier to the SURROUND BACK L/R jacks of the PRE OUT terminals allows you to create the maximum of 7.1-channel surround system with a surround back channel.

For a 6.1-channel system, connect the external amplifier to the SURROUND BACK L jack of the PRE OUT terminals.

For a 7.1-channel system, connect it to the SURROUND BACK L/R jacks.

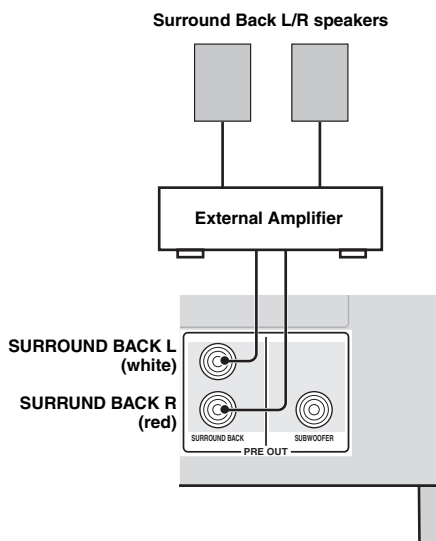

You can adjust the surround back speaker volume with a volume control of the external amplifier. To obtain the balanced sound during playback, set the speaker output characteristics in advance using the Yamaha Parametric Room Acoustic Optimize (YPAO, see page 18) or “Speaker Setup” of the setup menu (see page 39).

Connecting the speaker cable

Caution

- A speaker cable is a pair of insulated cables running side by side in general. One of the cables is colored differently or striped to indicate a polarity. Connect one end of the colored/striped cable to the “+” (red) terminal of this unit and the other end to that of your speaker, and connect one end of the other cable to the “-” (black) terminal of this unit and the other end to that of your speaker.
- Before connecting the speakers, be sure to disconnect the power cable.
- Do not let the bare speaker wires touch each other or any metal part of this unit. This could damage this unit and/or speakers. If the circuit shorts out, “CHECK SP WIRES!” appears on the front panel display when this unit is turned on.
- Use magnetically shielded speakers. If images on the monitor are still distorted even when you use the magnetically shielded speakers, place the speakers away from the monitor.
- Use speakers with an impedance of 6-ohm or larger. Set speaker impedance in “ADVANCED SETUP” before connecting the speakers (see page 45).

■ Connecting to the FRONT terminals

- 1 Remove approximately 10 mm (0.4 in) of insulation from the end of each speaker cable and then twist bare wires of the cable together so that they will not cause a short circuits.

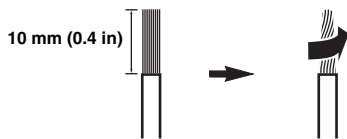

- 2 Loosen the knob, insert the twisted bare wires into the hole, and then tighten the knob.

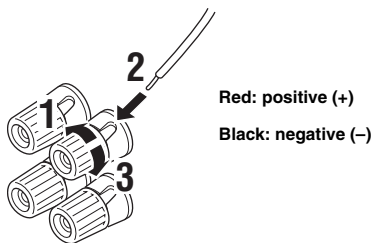

Connecting the banana plug (Except U.K., Europe, Asia and Korea models)

Tighten the knob, and then insert the banana plug into the end of the terminal.

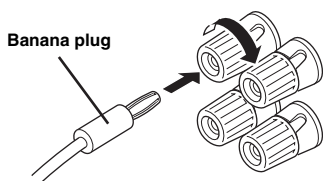

■ Connecting to the CENTER and SURROUND terminals

- 1 Press down the tab and insert the bare end of the speaker cable into the hole in the terminal.

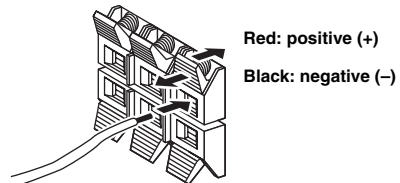

- 2 Release the tab to secure the wire.

Information on jacks and cable plugs

This unit has the following input and output jacks. Use jacks and cables appropriate for components that you are connecting.

■ Audio jacks

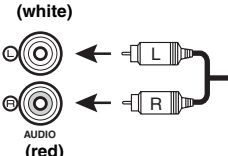
Jack and cables	Description
AUDIO jacks (white) 	To transmit conventional analog left and right audio signals. Use stereo pin cables. Connect red plugs to red jacks (R) and white plugs to white jacks (L).

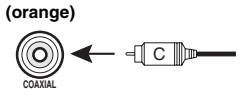
COAXIAL jacks (orange) 	To transmit coaxial digital audio signals. Use pin cables for digital audio signals.
---	--

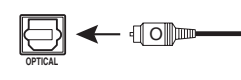
OPTICAL jacks 	To transmit optical digital audio signals. Use optical fiber cables for optical digital audio signals.
---	--

■ Video jacks

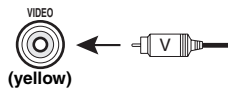
Jack and cables	Description
VIDEO jacks VIDEO (yellow) 	To transmit conventional composite video signals. Use video pin cables.

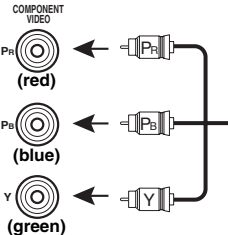
COMPONENT VIDEO jacks COMPONENT VIDEO Pr (red) Pb (blue) Y (green) 	To transmit component video signals that include luminance (Y), chrominance blue (PB) and chrominance red (PR) components. Use component video cables.
---	--

■ Video/audio jacks

Jack and cables	Description
HDMI jacks 	To transmit digital video and digital audio signals. Use HDMI cables.



- We recommend that you use a commercially available 19-pin HDMI cable no longer than 5 meters (16 feet) with the HDMI logo printed on it.
- You can check the potential problem about the HDMI connection (see page 23).
- You can check error information on HDMI connections (see page 23).

A video signal input to this unit is output from the output terminals in MONITOR OUT for the same kind of signal as the input signal.

For example, if a VCR with a composite output signal and a DVD player with a COMPONENT VIDEO output signal are connected, connect both VIDEO jack and COMPONENT VIDEO jack in MONITOR OUT to the video monitor.

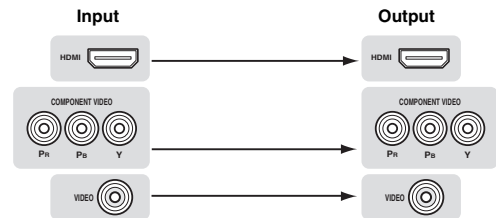

Connecting a TV monitor or projector

Connect a video monitor such as a TV or projector to an output terminal of this unit. You can select one of the following three types according to the input signal format supported by the video monitor.

Note

- When you connect this unit to the video monitor, make sure that this unit is on standby.

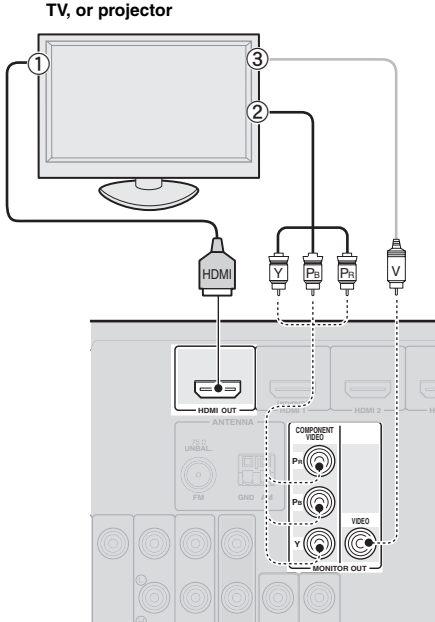

■ To connect an HDMI video monitor

Jacks on components	Jacks on this unit
① HDMI input	HDMI OUT



- This unit supports the HDMI control function. By connecting a TV that supports the HDMI control, operations of this unit can be controlled with the remote control of the TV. For details, see page 44.

■ To connect component video monitor

Note

- Only video signals input from this unit via the component input terminal are output from the component output terminal.

Jacks on components	Jacks on this unit
② Component video output	MONITOR OUT (COMPONENT VIDEO)

■ To connect composite video monitor

Note

- Only video signals input from this unit via the composite video input terminal are output from the composite video output terminal.

Jacks on components	Jacks on this unit
③ Video input (composite)	MONITOR OUT (VIDEO)

Outputting sound of a TV from this unit

To output sound of a TV from this unit, make connection between the AV input 1-6 and an audio output terminal. If the TV supports an optical digital output, we recommend that you use the AV input 1. Connecting to the AV input 1 allows you to switch an input source to the AV input 1 with just a single key operation using the SCENE function (see page 21).

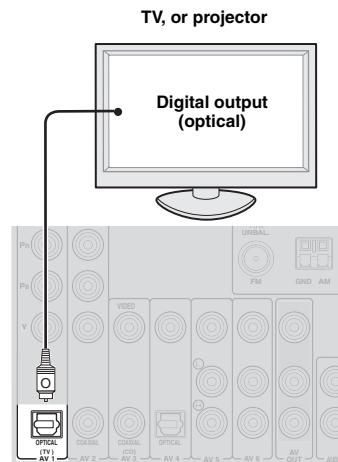

Connecting other components

This unit has input and output terminals for respective input and output sources. You can reproduce sound and movies from input sources selected with the front panel display or remote control.

Note

- When you connect this unit to the external components, make sure that this unit is on standby.

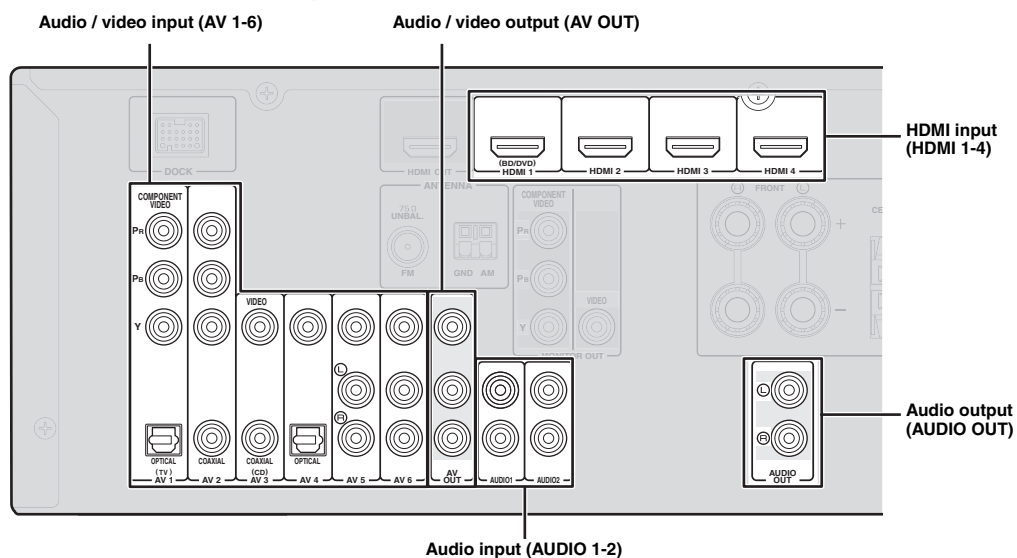

■ Audio and video player / Set-top box

Output jacks on the connected external component			Input sources/jacks of this unit	
External components	Signals	Output jacks		
External component with HDMI output	Audio/Video	HDMI output	HDMI 1 (BD/DVD)	HDMI 1
			HDMI 2	HDMI 2
			HDMI 3	HDMI 3
			HDMI 4	HDMI 4
External component with component video output	Audio	Optical digital output	AV 1 (TV)	OPTICAL
		Component video		COMPONENT VIDEO
	Video	Coaxial digital output	AV 2	COAXIAL
		Component video output		COMPONENT VIDEO
External component with composite video output	Audio	Coaxial digital output	AV 3 (CD)	COAXIAL
		Composite output		VIDEO
	Video	Optical digital output	AV 4	OPTICAL
		Composite output		VIDEO
	Audio	Analog audio output	AV 5	AUDIO
		Composite output		VIDEO
	Video	Analog audio output	AV 6	AUDIO
		Composite output		VIDEO



- Input sources in parentheses are recommended to connect to the respective jacks. If your Yamaha component has the Remote in/out terminal, you can switch the input source to that component with a single key operation using the SCENE function (see page 21).
- You can change the name of the input source displayed on the front panel display as necessary (see page 43).

■ Audio player

Output jacks on the connected external component		Input sources/jacks of this unit	
External components	Output jacks		
External component with optical digital output	Optical digital output	AV 1 (TV)	OPTICAL
		AV 4	OPTICAL
External component with coaxial digital output	Coaxial digital output	AV 2	COAXIAL
		AV 3 (CD)	COAXIAL
External component with analog audio output	Analog audio output	AV 5	AUDIO
		AV 6	AUDIO
		AUDIO 1	AUDIO
		AUDIO 2	AUDIO



- We recommend connecting the coaxial digital output terminal of a CD player to the AV3 jack.

About audio/video output terminals

Among the analog audio and analog video signals input to this unit via input terminals, the audio/video signals of the selected input sources are output from the AV OUT jack and AUDIO OUT jack. An HDMI input signal, COMPONENT VIDEO input signal or digital audio input signal cannot be output.

When using the AV OUT jack: connect an external component to the composite or analog audio terminal.

When using the AUDIO OUT jack: connect an external component to the analog audio terminal.

Connecting a Yamaha iPod universal dock or Bluetooth™ wireless audio receiver

This unit has the DOCK jack, to which you can connect a Yamaha iPod universal dock (YDS-11, sold separately) or a Bluetooth wireless audio receiver (YBA-10, sold separately). You can play an iPod or a Bluetooth component with this unit by connecting it to the DOCK jack.

Use a dedicated cable for connection between the dock/receiver and this unit.

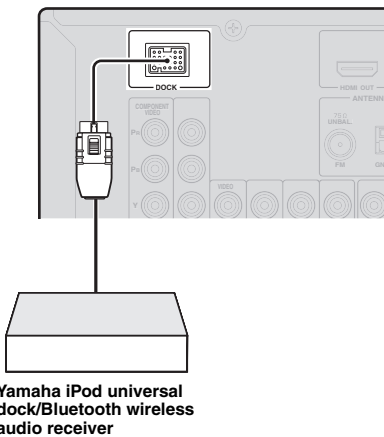

Using the VIDEO AUX jacks on the front panel

Use the VIDEO AUX jacks on the front panel to connect a game console or a video camera to this unit. Be sure to turn down the volume of this unit and other components before making connections.

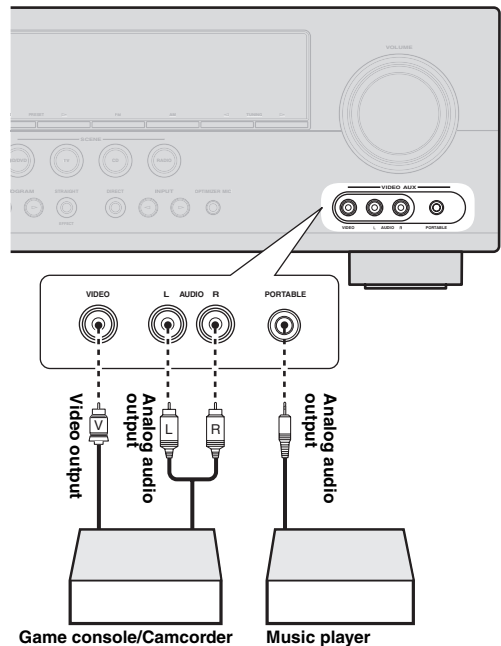

Note

- When external components are connected both the PORTABLE jack and AUDIO jack, sound input from the PORTABLE jack is output.

Connecting the FM and AM antennas

An indoor FM antenna and an AM loop antenna are supplied with this unit. Connect these antennas properly to the respective jacks.

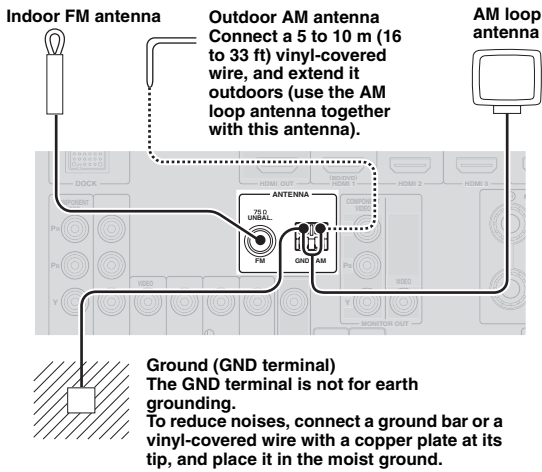

- The supplied antennas are normally sensitive enough to obtain good reception.
- Position the AM loop antenna away from this unit.
- If you cannot get good reception, we recommend that you use an outdoor antenna. For more details, consult the nearest authorized Yamaha dealer or service center.
- Always use the AM loop antenna even when the outdoor antenna is connected.

Assembling the AM loop antenna

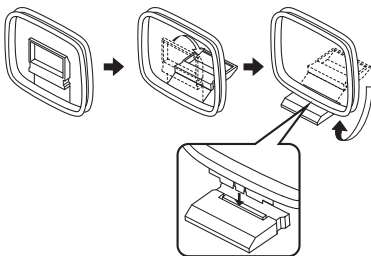

Connecting the AM loop antenna

The wires of the AM loop antenna have no polarity. You can connect either wire to the AM terminal and the other to the GND terminal.

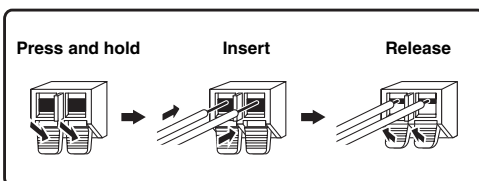

Connecting the power cable

After all connections are complete, plug the AC power cable of this unit into an AC wall outlet.

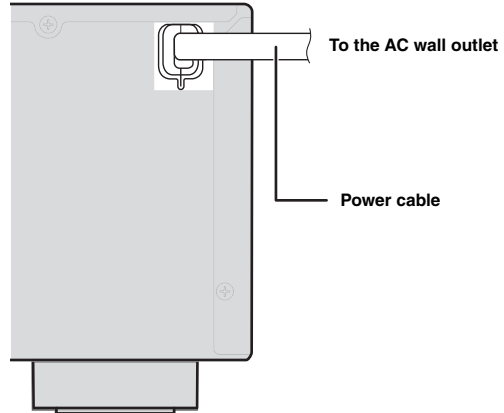

Turning this unit on and off

- 1 Press **Ⓐ** **STANDBY/ON** on the front panel (or **Ⓔ** **POWER** on the remote control) to turn on this unit.
- 2 Press **Ⓐ** **STANDBY/ON** (or **Ⓔ** **POWER**) again to turn off this unit (standby mode).



- The unit needs a few seconds until ready to play back.
- You can also turn on this unit by pressing **Ⓚ** **SCENE** (or **Ⓛ** **SCENE**).
- This unit consumes a small amount of electricity even in the standby mode. We recommend disconnecting the power cable from the AC wall outlet.

Caution

Do not unplug this unit while it is turned on. Doing so may damage this unit or cause the settings of this unit to be saved incorrectly.

Optimizing the speaker setting for your listening room (YPAO)

This unit has a Yamaha Parametric Acoustic Optimizer (YPAO). With the YPAO, this unit automatically adjusts the output characteristics of your speakers based on speaker position, speaker performance, and the acoustic characteristics of the room. We recommend that you first adjust the output characteristics with the YPAO when you use this unit.

Caution

- Be advised that it is normal for loud test tones to be output during the “Auto Setup” procedure. Do not allow small children to enter the room during the procedure.
- To achieve the best results, make sure the room is as quiet as possible while the “Auto Setup” procedure is in progress. If there is too much ambient noise, the results may not be satisfactory.



- See page 39 for the “Manual Setup” procedure.

Using Auto Setup

1 Check the following points.

Before starting the automatic setup, check the following.

- All speakers and subwoofer are connected properly.
- Headphones are disconnected from this unit.
- If the surround back speakers are connected to this unit via an external amplifier, turn on the external amplifier and adjust the volume to the proper level.
- The connected subwoofer is turned on and the volume level is set to about half way (or slightly less).
- The crossover frequency controls of the connected subwoofer are set to the maximum.

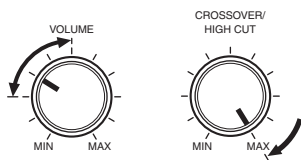

Subwoofer

Note

- If the volume of the external amplifier is not set at the proper level while the surround speakers being connected, the surround back speakers may not be recognized by the YPAO or a warning message may appear.

2 Connect the supplied optimizer microphone to the OPTIMIZER MIC jack on the front panel.

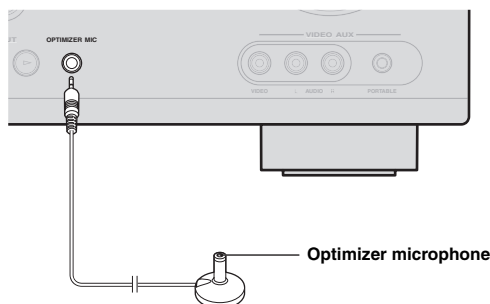

“MIC ON. YPAO START” appears on the front panel display.



- You can bring up the “Auto Setup” from the setup menu (see page 39).

3 Place the optimizer microphone at your normal listening position on a flat level surface with the omni-directional microphone heading upward.

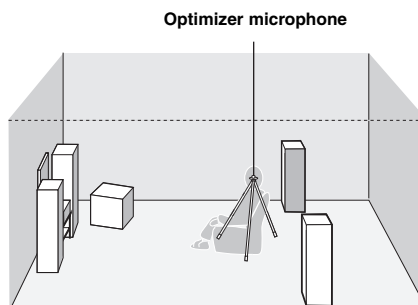

- It is recommended that you use a tripod or something similar to fix the optimizer microphone at the same height as your ears would be when seated in your listening position. You can fix the optimizer microphone to the tripod with the attaching screw of the tripod.

- 4 To select a sound character for adjustment, press **[F4]Cursor** Δ to select “EQ” and then press **[F4]Cursor** $\triangleleft/\triangleright$.**

If this unit does not work when you press **[F4]Cursor**, press **[F2]SETUP** once and then operate this unit.



YPAO
EQ.....Natural

This unit has a parametric equalizer that adjusts the output levels for each frequency range. The equalizer is adjusted to produce a cohesive sound field based on automatically measured speaker characteristics. In “EQ,” you can select the following parametric equalizer characteristics suitable for the desired sound characteristics.

Natural

This adjusts all speakers to achieve natural sound. Select this if sounds in the high frequency range seem too strong when “EQ” is set to “Flat.”

Flat

This adjusts each speaker to obtain the same characteristics. Select this if your speakers have similar qualities.

Front

This adjusts each speaker to obtain the same characteristics as the front left and right speakers. Select this if your front left and right speakers have significantly better qualities than the other speakers.

- 5 Press **[F4]Cursor** ∇ to select “Start” and then press **[F4]ENTER** to start the setup procedure.**

A countdown starts and a measurement starts in 10 seconds. A loud test tone is output during measurement.

Notes

- During the automatic setup procedure, do not perform any operation on this unit.
- Press **[F4]Cursor** Δ to cancel the automatic setup procedure.

Measurement takes about 3 minutes. To obtain precise results, stay where you will not disturb the measurement, such as to the side of or behind the speakers or outside the room.

When measurement is successfully completed, “YPAO Complete” appears on the front panel display.



YPAO
YPAO Complete

Notes

- When “E-xx” (xx indicates the number) appears during Auto Setup, it means that measurement is canceled due to an error. For details, see “When an error message is displayed during measurement” (page 20).
- When an error occurs during measurement, “W-xx” (xx indicates the number) appears. For details, see “When a warning message is displayed after measurement” (page 20).

- 6 Press **[F4]ENTER** to confirm the settings.**

The speaker characteristics are adjusted according to measurement results.



YPAO
>Set Cancel

- 7 To cancel the operation, press **[F4]Cursor** $\triangleleft/\triangleright$ to select “Cancel” and press **[F4]ENTER**.**

When “Disconnect MIC” appears, remove the optimizer microphone. Auto Setup is complete.

The optimizer microphone is sensitive to heat. Store it in a cool place and away from direct sunlight after measurement. Do not leave it in a place where it will be subjected to high temperatures such as on an AV component.



- If you do not want to apply the measurement results, select “Cancel.”
- Perform “Auto Setup” again if you change the number or positions of speakers.
- If you press **[F4]ENTER** before removing the optimizer microphone, “1 Auto Setup” of “Speaker Setup” in the setup menu (see page 39) is displayed.

When an error message is displayed during measurement

Select **“Retry”** or **“Exit”** using **[14]Cursor** </> and then press **[14]ENTER**.

Retry

Performs “Auto Setup” again.

Exit

Terminates the measurement and “Auto Setup.”



- See page 51 for details on error messages.
- When “E-5:NOISY” appears, you can continue measurement. To continue measurement, select “Proceed.” However, we recommend that you solve the problem first and then perform measurement again.

When a warning message is displayed after measurement

If a problem occurs during measurement, “W-xx” (xx indicates the number) is displayed on the front panel display. Check the error and solve the problems.



- See page 52 for details on warning messages.
- Optimization will not be performed while a warning message is displayed. We recommend that you solve the problem and perform “Auto Setup” again.

1 If a warning message is displayed, press [14]ENTER.

Details of the warning message are displayed. If there are multiple warning messages, you can display the next message using **[14]Cursor** >.

2 To return to the top result display, press [14]ENTER again.

BASIC OPERATION

Playback

Basic procedure

- 1 Turn on external components (TV, DVD player, etc.) connected to this unit.
- 2 Press **INPUT** $\triangleleft/\triangleright$ (or **Input selection keys**) to select an input source. The name of the selected input source is displayed for a few seconds.

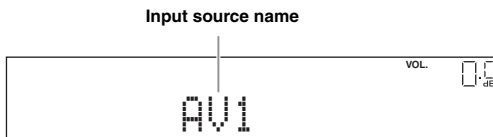

- 3 Play the external component that you have selected as the source input, or select a radio station on the tuner.

Refer to the operating instructions of the external component for details on playback. For selecting radio stations or playback of an iPod or Bluetooth component using this unit, see the following.

- FM/AM radio tuning (see page 28)
- Bluetooth component playback (see page 32)
- iPod playback (see page 30)

- 4 Turn the **VOLUME** control to adjust the volume (or press **VOLUME +/-**).

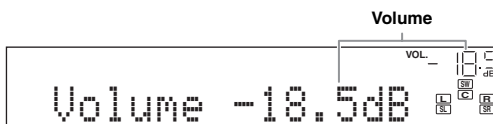

Note

When you play back a DTS-CD, noise may be output in some conditions, which may cause a speaker malfunction. Make sure that the volume is set to low before starting playback. If noise is output, do the following.

- 1) When only noise is output
If a DTS bitstream signal is not properly input to this unit, only noise is output. Connect the playback component to this unit by digital connection and play back the DTS-CD. If the condition is not improved, the problem may result from the playback component. Consult the manufacturer of the playback component.
- 2) When noise is output during playback or skip operation
Before playing back the DTS-CD, display the option menu after selecting the input source and set "Decoder Mode" to "DTS" (see page 33).

Using the SCENE function

This unit has a SCENE function that allows you to change input sources and sound field programs with one key. Four scenes are available for different usages, such as playing movies or music. The following input sources and sound field programs are provided as the initial factory settings.

	Input source	Sound field program
BD/DVD	HDMI 1	Straight
TV	AV 1	Straight
CD	AV 3	Straight
RADIO	TUNER	7ch Enhancer



- When this unit is on standby, you can turn on this unit by pressing the SCENE key.

Selecting a SCENE

Press **SCENE** (or **SCENE**).

Registering input source/sound field program

Select the desired input source/sound field program, and pressing down **SCENE** (or **SCENE**) until "SET Complete" appears on the front panel display.

Switching remotely controlled external components linked to scene selections

You can operate an external component with the remote control of this unit by setting a remote control code for the external component for each input source. Setting remote control codes for desired input sources allows you to switch between external components linked to scene selections.

- 1 Register the remote control code of an external component to the desired input source (see page 44).

Note

- Remote control codes cannot be registered to a TUNER input.

- 2** Press **[7]** **Input selection keys** on the remote control for the input source whose remote control code was registered in step 1 for about 3 seconds while pressing down **[11]** **SCENE** key whose assignment you want to change.

The external component can now be controlled remotely just by selecting a scene.

Muting audio output temporarily (MUTE)

- 1** Press **[17]** **MUTE** on the remote control to mute the audio output.

The MUTE indicator on the front panel display flashes while audio output is muted.

- 2** Press **[17]** **MUTE** again to resume audio output.

Adjusting high/low frequency sound (tone control)

You can adjust the balance of the high frequency range (Treble) and low frequency range (Bass) of sounds output from the front left and right speakers to obtain desired tone.

- 1** Press **[⊙]** **TONE CONTROL** on the front panel repeatedly to select “Treble” or “Bass.”

The current setting is displayed on the front panel display.



- 2** Adjust the frequency range using

[K] **PROGRAM** **[<]** **[>]**.

Control range: -10.0 dB to +10.0 dB

The display returns the previous screen soon after you release the key.

Notes

- The tone control settings are not effective during playback in direct mode.
- If you set the balance extremely off, sounds may not match those from other channels well.

Enjoying pure hi-fi sound

Use Direct mode to enjoy the pure high fidelity sound of the selected source. When Direct mode is activated, this unit plays back the selected source with the least circuitry.

Press **[M]** **DIRECT** (or **[10]** **DIRECT**) to turn the Direct mode on or off.

The following features are disabled in Direct mode.

- sound field program, tone control
- display and operation of the option menu and setup menu



- While direct mode is on, the front panel display becomes dim. When setting it back off, the brightness of the front panel display returns to the previous setting.

Using the sleep timer

The sleep timer is useful if you want to go to sleep while this unit is playing or recording a source.

Press **[5]** **SLEEP** repeatedly to set the amount of time.

Each time you press **[5]** **SLEEP**, the front panel display changes as shown below.

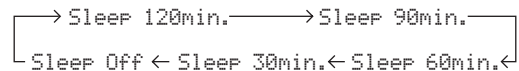

When the sleep timer is set, the SLEEP indicator on the front panel display lights up.

Press **[5]** **SLEEP** on the remote control repeatedly until “Sleep Off” appears on the front panel display.

Using your headphones

Plug your headphones in the **[B]** **PHONES** jack on the front panel.

When you select a sound field program while using the headphones, the mode is automatically set to SILENT CINEMA mode.

Notes

- When you connect headphones, no signals are output at the speaker terminals.
- When multi-channel signals are processed, sounds in all channels are divided to left and right channels.

Displaying input signal information

You can display information on audio/video signals input to this unit for each input source.

1 Select the desired input source, and press **[13]OPTION.**

The option menu for the selected input source is displayed (see page 33).

2 Press **[14]Cursor** Δ / ∇ to select "Signal Info," and press **[14]ENTER.**

Information on input signals is displayed. See page 34 on messages displayed on the front panel display.

3 Press **[14]Cursor** Δ / ∇ to select the desired item.



Note

- If an HDMI related error occurs, when an HDMI related error has occurred, press **[14]Cursor** to display an error message.

4 To end the information display, press **[13]OPTION.**

Changing information on the front panel display

Information displayed on the front panel display can be changed by pressing **[9]INFO** (or **[9]INFO**).

The following information can be displayed according to the input source.

For example, if you select HDMI1 input and display "DSP Program," the following screen appears on the front panel display.



The following information is displayed for each input source.

HDMI1-4:	Input, DSP Program, Audio Decoder
AV1-6:	Input, DSP Program, Audio Decoder
AUDIO1-2:	Input, DSP Program, Audio Decoder
V-AUX:	Input, DSP Program, Audio Decoder
FM/AM:	Frequency, DSP Program, Audio Decoder
iPod (Simple remote mode):	Input, DSP Program, Audio Decoder
iPod (Menu browse mode):	(in PlayInfo displayed) Artist, Album, Song, DSP Program, Audio Decoder (in Play menu displayed) List
Bluetooth:	Input, DSP Program, Audio Decoder

Enjoy the sound field programs

This unit is also equipped with a Yamaha digital sound field processing (DSP) chip. You can enjoy multi-channel sounds for almost all input sources using various sound field programs stored on the chip and a variety of surround decoders.

Selecting sound field programs

■ Selecting a sound field program on the front panel

Press **PROGRAM** </> repeatedly to select a desired sound field program.

■ Selecting a sound field program with the remote control

Perform the following operations depending on the category of the sound field programs.

- Sound field programs for movies/TV programs Press **MOVIE** repeatedly.
- Sound field programs for music Press **MUSIC** repeatedly.
- Stereo reproduction Press **STEREO** repeatedly.
- Multi-channel stereo reproduction Press **STEREO** repeatedly.
- Compressed music enhancer Press **STEREO** repeatedly.
- Surround decoder Press **SUR.DECODE** repeatedly.

For example, if you select “Sci-Fi” in “movie/TV program,” the following screen appears on the front panel display.

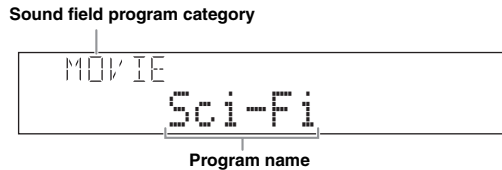

Notes

- Sound field programs are stored for each input source. When you change the input source, the sound field program previously selected for that input source is applied again.
- When you play back the Dolby Digital Plus, Dolby TrueHD, DTS Express, DTS-HD Master Audio, or DTS-HD High Resolution Audio sources, this unit does not apply any sound field program other than the surround decoder and they are played back in straight decode mode.
- If the sampling frequency of an input source is higher than 96 kHz, this unit does not apply any sound field programs.

Sound field program descriptions

This unit provides sound field programs for multiple categories including music, movies and stereo reproduction. Select a sound field program based on your listening preference, not merely on the name of the program, etc.



- You can check what speakers are currently outputting signals with the speaker indicators on the front panel display (see page 6).
- Each program can adjust sound field elements (sound field parameters). For details, see page 36.
- **CINEMA DSP** in the table indicates the sound field program with CINEMA DSP.

For movie/TV program sources



Program	Descriptions
Standard	This program creates a sound field emphasizing the surrounding feeling without disturbing the original acoustic positioning of multi-channel audio such as Dolby Digital and DTS. It has been designed with the concept of “an ideal movie theater,” in which the audience is surrounded by beautiful reverberations from the left, right and rear.
Spectacle	This program represents the spectacular feeling of large-scale movie productions. It reproduces a broad theater sound field matching the cinemascope and wider-screen movies with an excellent dynamic range from very small to extremely large sound.
Sci-Fi	This program clearly reproduces the finely elaborated sound design of the latest science fiction and special effects-featuring movies. You can enjoy a variety of cinematographically created virtual spaces reproduced with clear separation between dialog, sound effects and background music.
Adventure	This program is ideal for precisely reproducing the sound design of action and adventure movies. The sound field restrains reverberations but puts emphasis on reproducing a powerful space expanded widely to the left and right. The reproduced depth is also restrained relatively to ensure the separation between audio channels and the clarity of the sound.

Program	Descriptions
Drama	This sound field features stable reverberations that match a wide range of movie genres from serious dramas to musicals and comedies. The reverberations are modest but offer an optimum 3D feeling, reproducing effects tones and background music softly but cubically around clear words and center positioning in a way that does not fatigue the listener even after long hours of viewing.
Mono Movie	This program is provided for reproducing monaural video sources such as a classic movie in an atmosphere of a good old movie theater. The program produces the optimum expansion and reverberation to the original audio to create a comfortable space with a certain sound depth.
Sports	This program allows the listeners to enjoy stereo sport broadcasts and studio variety programs with enriched live feeling. In sports broadcasts, the voices of the commentator and sportscaster are positioned clearly at the center while the atmosphere of the stadium expands in an optimum space to offer the listeners with a feeling of presence in the stadium.
Action Game	This sound field has been suitable for action games such as car racing and FPS games. It uses the reflection data that limits the effects range per channel in order to offer a powerful playing environment with a being-there feeling by enhancing various effects tones while maintaining a clear sense of directions.
Roleplaying Game	This sound field has been suitable for role-playing and adventure games. It combines the sound field effects for movies and the sound field designs for "Action Game" to represent the depth and 3D feeling of the field during play, while offering movie-like surround effects in the movie scenes in the game.

For audio music sources



Program	Descriptions
Hall in Munich	This sound field simulates a concert hall with approximately 2500 seats in Munich, using stylish wood for the interior finishing as normal standards for European concert halls. Fine, beautiful reverberations spread richly, creating a calming atmosphere. The listener's virtual seat is at the center left of the arena.
Hall in Vienna	This is an approximately 1700-seated, middle-sized concert hall with a shoebox shape that is traditional in Vienna. Pillars and ornate carvings create extremely complex reflections from all around the audience, producing a very full, rich sound.
Chamber	This program creates a relatively wide space with a high ceiling like an audience hall in a palace. It offers pleasant reverberations that are suitable for courtly music and chamber music.
Cellar Club	This program simulates a live house with a low ceiling and homey atmosphere. A realistic, live sound field features powerful sound as if the listener is in a row in front of a small stage.
The Roxy Theatre	This is the sound field of a rock music live house in Los Angeles, with approximately 460 seats. The listener's virtual seat is at the center left of the hall.
The Bottom Line	This is the sound field at stage front in The Bottom Line, that was a famous New York jazz club once. The floor can seat 300 people to the left and right in a sound field offering real and vibrant sound.
Music Video	This sound field offers an image of a concert hall for live performance of pop, rock and jazz music. The listener can indulge oneself in a hot live space thanks to the presence sound field that emphasizes the vividness of vocals and solo play and the beat of rhythm instruments, and to the surround sound field that reproduces the space of a big live hall.

For stereo reproduction

Program	Descriptions
2ch Stereo	Use this program to mix down multi-channel sources to 2 channels.



- When multi-channel signals (Dolby Digital and DTS) are input, they are downmixed to 2 channels and output from the front left and right speakers.

For Multi-channel stereo reproduction



Program	Descriptions
7ch Stereo	Use this program to output sound from all speakers. When you play back multi-channel sources, this unit downmixes the source to 2 channels, and then outputs the sound from all speakers. This program creates a larger sound field and is ideal for background music at parties, etc.

The Compressed Music Enhancer

Program	Descriptions
Straight Enhancer	Use this program to enhance the sound nearest to the original depth and width of the 2-channel or multi-channel compression artifacts.
7ch Enhancer	Use this program to play back compression artifacts in 7-channel stereo.

Surround decode mode

Select this program to playback sources with selected decoders. You can playback 2-channel sources on multi-channels.

Decoder	Descriptions
Pro Logic	Dolby Pro Logic decoder suitable for all kinds of sources.
PLIIx Movie / PLII Movie	Dolby Pro Logic IIx (or Dolby Pro Logic II) decoder suitable for movies. If your listening environment is as follows, you cannot select the Dolby Pro Logic IIx decoder. <ul style="list-style-type: none"> • When the surround back speakers are not connected • When headphones are connected
PLIIx Music / PLII Music	Dolby Pro Logic IIx (or Dolby Pro Logic II) decoder suitable for music. If your listening environment is as follows, you cannot select the Dolby Pro Logic IIx decoder. <ul style="list-style-type: none"> • When the surround back speakers are not connected • When headphones are connected
PLIIx Game / PLII Game	Dolby Pro Logic IIx (or Dolby Pro Logic II) decoder suitable for games. If your listening environment is as follows, you cannot select the Dolby Pro Logic IIx decoder. <ul style="list-style-type: none"> • When the surround back speakers are not connected • When headphones are connected
Neo:6 Cinema	DTS decoder suitable for movies.
Neo:6 Music	DTS decoder suitable for music.



- An input source is played back in straight decode mode (see page 27) when multi-channel audio signal is input.

Enjoying unprocessed input sources (Straight decoding mode)

In straight decoding mode, sounds are reproduced without sound field effect. 2-channel stereo sources are output from only the front left and right speakers. Multi-channel input sources are decoded straight into the appropriate channels and multi-channel sounds are reproduced without a sound field effect.

- To enable straight decoding mode, press**
Ⓛ STRAIGHT (or 10 STRAIGHT).
 “Straight” appears on the front panel display.

- To cancel straight decoding mode, press**
Ⓛ STRAIGHT (or 10 STRAIGHT) again.
 A sound field program name appears on the front panel display, and sound is reproduced with that sound field effect.

Enjoying sound field programs without surround speakers (Virtual CINEMA DSP)

Virtual CINEMA DSP allows you to enjoy DSP sound field surround effects even without any surround speakers by using virtual surround speakers. You can even enjoy Virtual CINEMA DSP using a minimal two-speaker system that does not include a center speaker. When “Sur. L/R” in the setup menu is set to “None” (see page 40), this unit operates in Virtual CINEMA DSP mode.

- Note**
- Virtual CINEMA DSP is not available in the following conditions even if you set “Sur. L/R” to “None” (see page 40).
 - headphone plug is connected to the PHONES jack.
 - 7ch Stereo of the field sound program is selected.
 - direct mode or straight decoding mode is used.

Enjoy sound field programs with headphones (SILENT CINEMA™)

SILENT CINEMA allows you to enjoy multi-channel sources with your headphones. SILENT CINEMA mode is automatically selected when you connect the headphone plug to the PHONES jack.

Note

- SILENT CINEMA mode is not available in the following conditions.
 - 2ch Stereo of the sound field program is selected.
 - direct mode or straight decoding mode is selected.

FM/AM tuning

The FM/AM tuner of this unit provides the following two modes for tuning.

■ Frequency tuning mode (Auto tuning / Manual tuning)

You can tune in to a desired FM/AM station by searching or specifying its frequency.

■ Preset tuning mode (Preset tuning)

You can preset the frequencies of FM/AM stations by registering them to specific numbers, and later just select those numbers to tune in.

Note

- Adjust the FM/AM antennas connected to this unit for the best reception.

Tuning in to the desired FM/AM station (Frequency tuning)

- 1 Press **INPUT** $\triangleleft/\triangleright$ (or **TUNER**) repeatedly and switch the input source to "TUNER."
- 2 Press **FM** (**FM**) or **AM** (**AM**) to select a band.
"FM" or "AM" appears on the front panel display according to the band that you have selected.
- 3 Press **TUNING** $\triangleleft/\triangleright$ (or **TUNING** \triangle/∇) to specify the frequency.
To adjust the frequency to a higher range, press \triangleright (or \triangle). To adjust it to the lower range, press \triangleleft (or ∇).
The TUNED indicator on the front panel display lights up when the tuner is tuned in to a station. The STEREO indicator also lights up if the program being broadcasted is in stereo.

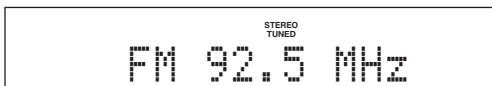

The frequency changes in the following manner according to how you press **TUNING** $\triangleleft/\triangleright$ (or **TUNING** \triangle/∇).

When you press the key more than 1 second.

The tuner searches the frequency of a station that is detectable around the current frequency. This is effective when the tuner can receive strong signals without any interference. Once the search starts, release the key. When you keep holding the key, the search continues even when a station is detected. This is useful when you want to tune in to a specific station.

When you press and release the key

The tuner increases or decreases the frequency in steps. Use this method when the tuner cannot receive strong signals and stations are skipped during the search. You can listen to better quality sound even when the tuner cannot receive a strong signal.



- You can switch between stereo and monaural for FM broadcast in the option menu (see page 34).

4 To tune in by direct frequency tuning, enter the frequency of the desired station using the numeric keys on the remote control.

Enter only integers. For example, if you want to set the frequency to 88.9 MHz, enter "889" using **Numeric keys**.

Note

- "Wrong Station!" appears on the front panel display when you enter a frequency that is out of receivable range. Make sure that the entered frequency is correct.

Registering FM/AM stations and tuning in (Preset tuning)

You can register up to 40 FM/AM stations (Preset) using "Automatic station preset" or "Manual station preset."

Registering stations by automatic station preset

The tuner automatically detects FM stations with strong signals and registers up to 40 stations. AM stations cannot be automatically registered. Use manual station preset.

- 1 Press **INPUT** $\triangleleft/\triangleright$ repeatedly (or press **TUNER**) to switch the input source to "TUNER."
- 2 Press **OPTION** on the remote control.
The option menu screen for setting options of tuner input appears on the front panel display.

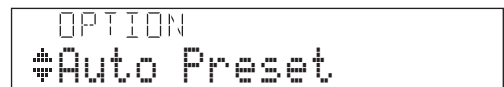
 - For details on the option menu, see page 33.
- 3 Select "Auto Preset," and press **ENTER**.



Automatic station preset starts about 5 seconds later from the lowest frequency upwards.

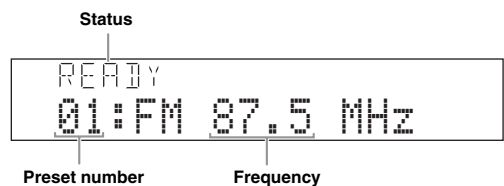

- You can select the preset number at which the preset starts by pressing **PRESET** \triangle/∇ or **Cursor** \triangle/∇ while the front panel display is in the state as shown in the below figure.
- To cancel registration, press **RETURN** on the remote control.



During the automatic station preset, the upper area of the screen changes as follows: READY → SEARCH → MEMORY each time a station is registered.

When registration is complete, "FINISH" appears and the option menu screen automatically reappears.

When you press **[13]OPTION** on the remote control, the screen returns to the original state.

Registering stations by manual station preset

You can manually register AM stations or FM stations with weak signals.

1 Tune in to a station referring to "Tuning in to the desired FM/AM station (Frequency tuning)" (see page 28).

2 Press **[0]MEMORY (or **[8]MEMORY**).**

"Manual Preset" appears on the front panel display, followed soon by the preset number to which the station will be registered.



- By pressing down **[0]MEMORY** (or **[8]MEMORY**) for more than 2 seconds, you can skip step 3 and register the preset number to be one higher than the last preset number.

3 Press **[E]PRESET </> (or **[8]PRESET** Δ / ▽) on the remote control to select the preset number to which the station will be registered.**

When you select a preset number to which no station is registered, "Empty" appears on the display. When you select a registered preset number, a registered frequency is displayed on the right of the preset number.

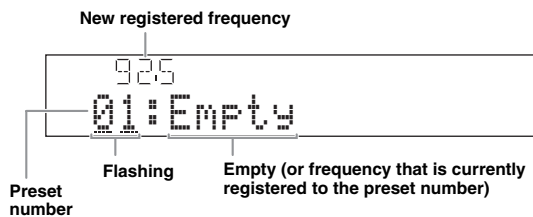

- You can select a preset number using the **[9]Numeric keys**.

4 Press **[0]MEMORY (or **[8]MEMORY**) again to register.**

When registration is complete, the screen returns to the original state.

To end the operation, press **[13]OPTION**.



- To cancel registration, press **[4]RETURN** on the remote control or leave the tuner without any operations for about 30 seconds.

Calling a preset station (Preset tuning)

You can call preset stations registered by automatic station preset or manual station preset.

Press **[E]PRESET </> (or **[8]PRESET** Δ / ▽) to select a preset number.**



- Preset numbers to which no stations are registered will be skipped.
- When "No Presets" or "No Presets in Memory" is displayed it means that no stations are registered. See page 28 and register stations.
- You can directly select a preset number by pressing a **[9]Numeric keys** while calling a preset station. "Empty" appears on the display if you enter a preset number to which no station is registered. "Wrong Num." appears if you enter an invalid number.

Clearing the preset station

1 Press **[N]INPUT </> repeatedly (or press **[7]TUNER**) to switch the input source to "TUNER."**

2 Press **[13]OPTION on the remote control.**

The option menu screen for setting options of tuner input appears on the front panel display.

3 Display "Clear Preset" using the **[14]Cursor Δ / ▽ and press **[14]ENTER**.**

The following screen appears on the display.

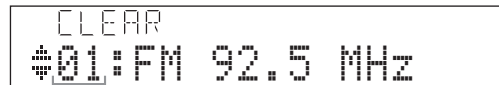

Preset number of the registered station you want to clear.



- You can cancel the operation and return to the option menu screen by pressing **[14]RETURN** on the remote control.

4 Select the preset number of the registered station you want to clear using the **[14]Cursor Δ / ▽ and press **[14]ENTER**.**

The preset station registered to the selected preset number is cleared. To clear the registration of multiple preset numbers, repeat the above steps. To end the operation, press **[13]OPTION**.

Using iPod™

Once you have stationed your iPod in a Yamaha iPod universal dock (such as the YDS-11, sold separately) connected to the DOCK terminal on the rear panel of this unit (see page 16), you can enjoy playback of your iPod using the supplied remote control. You can also use the Compressed Music Enhancer mode of this unit to improve the sound quality of the compression artifacts (such as MP3 format) stored on your iPod (see page 24).

Notes

- iPod touch, iPod (Click and Wheel including iPod classic), iPod nano, and iPod mini are supported.
- Some features may not be compatible depending on the model or the software version of your iPod.
- Some features may not be available depending on the model of Yamaha iPod universal dock. The following sections describe the procedure when using the YDS-11.



- Once the connection between your iPod and this unit is complete, "iPod connected" appears on the front panel display.
- For a complete list of status messages that appear on the front panel display, see the "iPod" section on page 50.

Controlling iPod™

You can control your iPod when you set it in the iPod universal dock and switch the input source to DOCK. The operations of your iPod can be done with the aid of the front panel display (menu browse mode) or without it (simple remote mode).

When you connect your iPod to this unit, you can perform the following operations with the remote control.

Key	Function
ENTER	Subsequent menu
△	Menu up
[14] ▽	Menu down
◀	Previous menu
▶	Subsequent menu
◀◀	Search backward (Press and hold)
▶▶	Search forward (Press and hold)
▶▶▶	Skip forward
◀◀◀	Skip backward
[18] □	Stop
⏸	Pause (Menu browse mode) Play/Pause (Simple remote mode)
▶	Play (Menu browse mode) Play/Pause (Simple remote mode)
[16] DISPLAY	Switch between Menu browse mode and Simple remote mode



- You can directly operate your iPod while it is connected to this unit.

1 Change the input source to "iPod (DOCK)" using **[N]INPUT** </> (or **[7]DOCK**).

Press **[16]DISPLAY** on the remote control to change between menu browse mode and simple remote mode, as required.

When you select menu browse mode, the front panel display changes as follows.

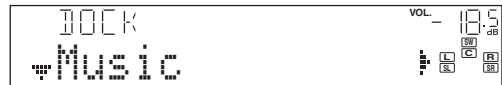

2 Press **[14]Cursor** △ / ▽ / </> to select a menu item and then **[14]ENTER** to start playback.

The following menu items are available.

Playlists, Artists, Albums, Songs, Genres, Composers

- Playlists > Songs
- Artists > Albums > Songs
- Albums > Songs
- Songs
- Genres > Artists > Albums > Songs
- Composers > Albums > Songs



- You can change information screens on the front panel display using **[C]INFO** (or **[9]INFO**) (see page 23). Items displayed on the front panel display vary depending on mode that is currently selected.

Shuffle/repeat playback

You can use a special playback function such as shuffle playback and repeat playback by setting the option menu.

- 1 Press **[16] DISPLAY** to switch to menu browse mode while “DOCK” is selected as the input source.

The option menu can be displayed only in menu browse mode. Press **[16] DISPLAY** to switch to menu browse mode before starting shuffle or repeat playback.

- 2 Press **[13] OPTION**.

The option menu is displayed.

- 3 Press **[14] Cursor** Δ / ∇ to select the desired playback function, Shuffle or Repeat, then press **[14] ENTER**.

The following playback styles are available depending on the playback function selected.

Shuffle: Plays back songs or albums in random order (Choices: Off, Songs, Albums).

- Select “Off” if you do not want to play back in random order.
- Select “Songs” to play back songs in random order.
- Select “Albums” to play back albums in random order.

Repeat: Plays back songs or albums repeatedly (Choices: Off, One, All).

- Select “Off” if you do not want to play back repeatedly.
- Select “One” to repeat each song.
- Select “All” to repeat all songs.

- 4 Select the desired style using **[14] Cursor** \triangleleft / \triangleright .

The style is selected. Playback starts with the function selected in step 3.

To return to the previous screen, press **[14] RETURN**.

To return to the previous playback function, redo the above steps.

Using Bluetooth™ components

You can connect a Yamaha Bluetooth wireless audio receiver (such as YBA-10, sold separately) to the DOCK terminal of this unit and enjoy the music contents stored in your Bluetooth component (such as a portable music player) without wiring between this unit and the Bluetooth component. You need to perform “Pairing” the connected Bluetooth wireless audio receiver and your Bluetooth component in advance.

Note

- This unit supports A2DP (Advanced Audio Distribution Profile) of the Bluetooth profile.

Pairing the Bluetooth™ wireless audio receiver and your Bluetooth component

“Pairing” refers to the operation of registering a Bluetooth component for Bluetooth communications. Pairing must be performed when using a Bluetooth component with the Bluetooth wireless audio receiver connected to this unit for the first time or if the pairing data has been deleted.



- You only need the pairing operation for the first time that you use the Bluetooth component with the Bluetooth wireless audio receiver.
- Pairing requires operations on this unit and on the other component with which Bluetooth communications are to be established. If necessary, refer to the other component’s operating instructions.

■ Pairing the Bluetooth™ wireless audio receiver and your Bluetooth™ component

To ensure security, a time limit of 8 minutes is set for the pairing operation. You are recommended to read and fully understand all the instructions before starting.

1 Change the input source to “DOCK” using **[N]INPUT </> (or **[7]DOCK**).**

2 Turn on the Bluetooth component you want to pair with and set it to pairing mode.

For details on operation of the Bluetooth component, refer to its operating instructions.

3 Press **[13]OPTION.**

The option menu for DOCK input appears on the front panel display.

4 Press **[14]Cursor ▽ to select “Pairing” and press **[14]ENTER**.**

“Searching” appears on the front panel display and the pairing operation starts.



- To cancel pairing, press **[14]RETURN**.
- You can also start pairing operation by pressing and holding **[D]MEMORY** on the front panel.

5 Make sure the Bluetooth component recognizes the Bluetooth wireless audio receiver.

If the Bluetooth have recognized the Bluetooth wireless audio receiver, “YBA-10 YAMAHA,” for instance, is displayed in the Bluetooth device list.

6 Select the Bluetooth wireless audio receiver from the Bluetooth device list, and enter a path key “0000” into the Bluetooth component.

When pairing is complete, “Completed” appears on the front panel display.



- The Yamaha Bluetooth wireless audio receiver can be paired with up to eight Bluetooth components. When pairing is conducted successfully with a ninth component and the pairing data is registered, the pairing data for the least recently used other component is cleared.

Playback of the Bluetooth™ component

1 Change the input source to “DOCK” using **[N]INPUT </> (or **[7]DOCK**).**

2 Press **[13]OPTION.**

3 Press **[14]Cursor ▽ repeatedly to select “Connect” and press **[14]ENTER**.**

After you execute “Connect,” communication with the Bluetooth component is established. When the connected Bluetooth wireless audio receiver recognizes the Bluetooth component, “BT Connected” appears on the front panel display.



- When you press **[14]ENTER** on the remote control, the connected Bluetooth wireless audio receiver searches and connects to the last connected Bluetooth component. If the Bluetooth wireless audio receiver cannot find the Bluetooth component, “Not found” appears on the front panel display.
- To disconnect the Bluetooth wireless audio receiver from the Bluetooth component, display the option menu again, select “Disconnect,” and press **[14]ENTER**.

4 Start playback of the Bluetooth component.

ADVANCED OPERATION

Setting the option menu for each input source (OPTION menu)

This unit has an OPTION menu of frequently used menu items for input sources compatible with this unit. The procedure for setting the OPTION menu items is described below.

1 Select an input source using N INPUT $\triangleleft/\triangleright$ (or 7 Input selection keys).

2 Press 13 OPTION on the remote control.
The OPTION menu appears. The displayed OPTION menu items differ depending on the input source. For details, see the following section.



3 Select the desired menu item using 14 Cursor \triangle/∇ , and press 14 ENTER.
Parameters of the selected menu item are displayed.

4 Change the setting of the selected menu item (or enable a function) using 14 Cursor $\triangle/\nabla/\triangleleft/\triangleright$ and 14 ENTER.
Details of the selected menu item are displayed. Parameters you can set differ depending on the menu items.

5 To close the OPTION menu, press 13 OPTION.
You can also use 14 RETURN to return to the previous screen or close the OPTION menu.



- When 14 Cursor or other keys do not work after completing the menu, select the input source again using 7 Input selection keys.

OPTION menu items

The following menu items are provided for each input source.

Input Source	Menu item			
	Volume Trim	Decoder Mode	EXTD Surround	Signal Info
HDMI1-4	Volume Trim	Decoder Mode	EXTD Surround	Signal Info
AV1-4	Volume Trim	Decoder Mode	EXTD Surround	Signal Info
AV5-6	Volume Trim			
AUDIO1-2	Volume Trim			
V-AUX	Volume Trim			
TUNER	Volume Trim	FM Mode	Auto Preset	Clear Preset
iPod (DOCK)	Volume Trim	Shuffle	Repeat	
Bluetooth (DOCK)	Volume Trim	Connect/Disconnect	Pairing	

Details of the menu items are as follows:



- The default settings are marked with “*.”

■ Volume Trim

Input source: All
Adjustable range: -6.0 dB to 0.0 dB* to +6.0 dB
(in 0.5 dB steps)

Reduces any change in volume when switching input sources by correcting volume differences between input sources.

You can set this parameter for each input source.

■ Decoder Mode

Input source: HDMI1-4, AV1-4

Choices: Auto*/DTS

Selects DTS digital audio signals for reproduction.

Auto Automatically selects audio input signals.

DTS Selects DTS signals only. Other input signals are not reproduced.

■ EXT D Surround

Input source: HDMI1-4, AV1-4

Choices: Auto*/PLIIXMovie/PLIIXMusic/EX/ES/Off

Selects whether to reproduce multi-channel input signals in 6.1- or 7.1-channel when surround back speakers are used.

Auto Automatically selects the most suitable decoder according to whether a flag for reproducing surround back channel is present, and reproduces the signals in 6.1- or 7.1-channel.

PLIIXMovie Always reproduces signals in 6.1- or 7.1-channel using the PLIIXMovie decoder whether or not surround back channel signals are contained. You can select this parameter when one or two speakers are connected.

PLIIXMusic Always reproduces signals in 6.1- or 7.1-channel using the PLIIXMusic decoder whether or not surround back channel signals are contained. You can select this parameter when one or two speakers are connected.

EX/ES Automatically selects the most suitable decoder for input signals whether or not the flag for reproducing surround back channel is present, and always reproduces signals in 6.1-channel.

Off Always reproduces signals in 5.1-channel whether or not the flag for reproducing surround back channel is present.

Signal Info

Input source: HDMI1-4, AV1-4

Displays information on audio and video signals on the front panel display. You can change items to be displayed using **[4]Cursor** Δ / ∇ .

Signal Info parameters

■ Audio information

Information	Description
FORMAT	Format of digital audio signals.
CHAN	The number of input signal channels (front/surround/LFE). For example, if input signal channels are 3 front channels, 2 surrounds and LFE, "3/2/0.1" is displayed. If a channel that cannot be expressed as the above, a total number of channels such as "5.1ch" may be displayed.
SAMPL	The sampling frequency per second in analog-to-digital conversion.
B RATE	The bit rate of input signal per second.

Notes

- "No Signal" is displayed when no signals are input and "---" is displayed when signals that this unit cannot recognize are input.
- The bit rate may vary during playback.

■ Video information

Information	Description
V IN	Format and resolution of video input signal.
V OUT	Format and resolution of video output signal.

HDMI error information

(appears only when an error has occurred)

Information	Description
VMSSG	Error messages about HDMI signals and HDMI components. See the following for details of the error messages.
HDCP Error	HDCP authentication failed.
Device Over	The number of HDMI components connected is over the limit.

■ FM Mode

Input source: TUNER

Choices: Stereo*/Mono

Sets FM broadcasting receiving mode.

Stereo Receives in stereo mode.

Mono Receives in monaural mode. You can get better reception in MONO mode.

■ Auto Preset

Input source: TUNER

Automatically detects radio stations in the FM frequency band and registers them as preset stations (see page 28).

■ Clear Preset

Input source: TUNER

Clears the preset stations (see page 29).

■ Shuffle

Input source: iPod (DOCK)

Choices: Off*/Songs/Albums

Changes the shuffle playback style (see page 31).

■ Repeat

Input source: iPod (DOCK)

Choices: Off*/One/All

Changes the repeat playback style (see page 31).

■ Connect / Disconnect

Input source: Bluetooth (DOCK)

Switches communication with a Bluetooth component on and off (see page 32).

■ Pairing

Input source: Bluetooth (DOCK)

Performs pairing of this unit and a Bluetooth component (see page 32).

Editing surround decoders/sound field programs

Selecting a decoder used with a sound field program

When using sound field programs for movies or TV programs (except for Mono Movie), you can select a surround decoder to be used with the sound field program after setting the parameters from the following decoders. To set the parameters for sound field programs, see the following section.

Decoders that can be used with a sound field program

- PLIIx Movie (PLII Movie)
- Neo:6 Cinema

Setting sound field parameters

Although the field sound programs would satisfy you as they are with the default parameters, you can arrange sound effect or decoders suitable for acoustical conditions of sources or rooms by setting the parameters (sound field elements).



- You can protect the sound field against the changes of parameters the sound field parameters when “Memory Guard” of the setup menu is set to “On” (see page 43). To change the parameters, set it to “Off.”

- 1 Press **[F12]**SETUP on the remote control.**
The setup menu appears on the front panel display.
- 2 Press **[F14]**Cursor Δ / ∇ to select “DSP Parameter” and press **[F14]**ENTER.**
The screen changes as follows.

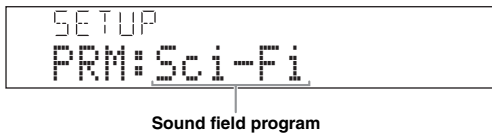

- 3 Press **[F14]**Cursor \triangleleft / \triangleright to select the sound field program.**
- 4 Press **[F14]**Cursor Δ / ∇ to select the parameter that you want to change, and press **[F14]**Cursor \triangleleft / \triangleright to change the parameter.**
You can change the parameter display in the following order by pressing **[F14]**Cursor ∇ repeatedly.
 - sound field program
 - surround decoder
 - sound field parameterFor sound field parameters, see “Sound field parameters” on this page.



- Repeat steps 4 and 5 to change other sound field program parameters.

- 5 To end the edit, press **[F14]**RETURN.**

To initialize the parameters of the selected sound field program, **[F14]**Cursor ∇ repeatedly to select “Initialize” and then press, **[F14]**Cursor \triangleright . When “Press Again \triangleright ” appears on the front panel display, press **[F14]**Cursor \triangleright again, press **[F14]**Cursor \triangleright to confirm the initialization or **[F14]**Cursor \triangleleft to cancel it.

Sound field parameters



- The default settings are marked with “*.”

CINEMA DSP parameters

DSP Level

Adjustable range: -6 dB to 0 dB* to +3 dB

Fine adjusts an effect level (level of the sound field effect to be added). You can adjust the level of the sound field effect while checking sound levels. Adjust “DSP Level” as follows.

- The effect sound is too soft.
→Increase the effect level.
- There are no differences between effects of the sound field programs.
- The sound is dull.
→Reduce the effect level.
- The sound field effect is added too much.
→Reduce the effect level.

Parameters only usable in certain sound field programs

■ 2ch Stereo only

Direct

Choices: Auto*/Off

Automatically bypasses the DSP circuit and tone control circuit when an analog sound source is selected as the input source. You can enjoy a higher quality sound.

Auto Outputs sound by bypassing the DSP circuit and tone control circuit when the “Bass” and “Treble” tone controls are both set to 0 dB.

Off Do not bypass the DSP circuit and tone control circuit.

■ 7ch Stereo only

CT Level/SL Level/SR Level/SB Level

Adjustable range: 0 to 100%

Adjusts the volume of the center (CT), surround L (SL) surround R (SR) and surround back (SB) channels in the 7ch Stereo program. The available parameters differ depending on the setting of the speakers.

■ Straight Enhancer/7ch Enhancer only

EFCT LVL

Choices: High*/Low

Adjusts the Compressed Music Enhancer effect level. When the high-frequency signals of the source is emphasized too much, set the effect level to “Low.” To reduce the effect, set this parameter to “Low.” To increase the effect, set it to “High.”

Decoder parameters

You can customize decoder effects by setting the following parameters. For kinds of decoders, see page 26.

■ When PLIIx Music/PLII Music is selected

Panorama

Choices: Off*/On

Adjusts the soundscape of the front sound field. Sends stereo signals to the surround speakers as well as the front speakers for a wraparound effect.

Dimension

Adjustable range: -3 to STD* to +3

Adjusts the difference in level between the front sound field and the surround sound field. You can adjust the difference in level created by the software being played back to obtain the preferred sound balance. The surround sound gets stronger as you make the value more negative and the front sound gets stronger as you make the value more positive.

CT Width

Adjustable range: 0 to 3* to 7

You can spread the center sound toward left and right according to your preference. Set this parameter to 0 for outputting the center sound from the center speaker only, or to 7 for outputting it from the front left/right speaker.

■ When Neo:6 Music is selected

C. Image

Adjustable range: 0.0 to 0.3* to 1.0

Adjusts the front left and right channel output relative to the center channel to make the center channel more or less dominant as necessary.

Operating various settings for this unit (Setup menu)

You can call the setup menu using the remote control and change the settings of various menus.

You can change the following settings in the setup menu. For details, read “Basic operation of the setup menu” first, and see the respective pages.

Menu/Submenu	Function	Page
Speaker Setup	Sets items for speakers.	39
1 Auto Setup (YPAO)	Automatically adjusts output characteristics of speakers.	39
2 Manual Setup	Manually adjusts output characteristics of speakers.	39
A)Config	Sets speaker configurations, such as connection status of speaker and a size of the connected speaker (sound reproduction capacity), suitable for the listening environment.	39
B)Level	Separately adjusts volume of each speaker.	41
C)Distance	Adjusts timing at which each speaker outputs sound based on distances between speakers and the listening position.	41
D)Equalizer	Selects an equalizer that adjusts speaker output characteristics.	41
E)Test Tone	Generates test tones.	41
Sound Setup	Sets various items for sound outputs.	41
1 D. Range	Adjusts dynamic ranges of speakers and headphones.	41
2 Lipsync	Adjusts delay in output timing between video signals and audio signals.	41
HDMI Auto	Sets on or off of automatic adjustments for delay between output timing between video signals input from the HDMI jack and audio signals.	41
Auto	Fine adjusts a delay time of HDMI Auto.	42
Manual	Manually fine adjusts the delay of audio and visual output.	42
Func. Setup	Set various items for HDMI and display.	42
1 HDMI	Sets various items for input sources.	42
Standby	Selects on or off of output of HDMI signals input from the HDMI IN jack to the HDMI OUT jack when this unit is on standby.	42
Audio	Selects this unit or a component connected to this unit via the HDMI OUT jack of this unit for reproducing sound signals input from the HDMI IN jack.	42
2 Display	Set items for the front panel display.	42
Dimmer	Sets brightness of the front panel display.	42
FL Scroll	Selects the way to display characters on the front panel display.	42
3 Volume	Sets items for volumes.	42
Adptv DRC	Adjust the dynamic range (difference between the maximum volume and the minimum volume) in conjunction with the volume level.	42
MaxVol	Sets the maximum volume level so that the volume will not be accidentally increased.	43
IniVol	Sets the volume at the time this unit is turned on.	43
4 Input Rename	Changes input source names to be displayed on the front panel display.	43
DSP Parameter	Sets parameters for the sound field programs.	43
Memory Guard	Protects some settings against accidental alteration.	43

Basic operation of the setup menu

1 Press $\boxed{12}$ SETUP on the remote control.
The setup menu screen appears.

2 Select a menu using $\boxed{14}$ Cursor Δ / ∇ , and press $\boxed{14}$ ENTER.

Items of the selected menu are displayed. For example, the following screen appears when you select “Function Setup.”



You can return to the previous screen by pressing $\boxed{14}$ RETURN.

3 To display submenus, select a menu that you want to set using $\boxed{14}$ Cursor Δ / ∇ , and press $\boxed{14}$ ENTER.

For example, the following screen appears when you select “2 Display.”



4 Select an item using $\boxed{14}$ Cursor Δ / ∇ , and change the setting of the item using $\boxed{14}$ Cursor $\triangleleft / \triangleright$.



You can change other items by repeating step 4.

5 To finish the setting, press $\boxed{12}$ SETUP.



When $\boxed{14}$ Cursor or other keys do not work after completing the menu, select the input source again using $\boxed{7}$ Input selection keys.

Speaker Setup

You can set various items for speakers. Two kinds of adjustments are available. One is “Auto Setup (YPAO)” for automatic adjustment and another is “Manual Setup” for manual adjustment.



The default settings are marked with “*.”

1 Auto Setup

Automatically adjusts output characteristics of speakers to obtain optimum balance for the output sound based on positions and performances of the speakers and acoustic characteristics or the room, which are automatically measured. For details on operations, see page 18.

2 Manual Setup

Adjusts output characteristics of speakers based on manually set parameters.

After Auto Setup (YPAO) is performed, you can check automatically adjusted parameters in the Manual Setup menu. Fine adjust the parameters for your preference if necessary.

■ A)Config

Sets speaker configurations, such as connection status of speaker and a size of the connected speaker (sound reproduction capacity), suitable for the listening environment.



The speaker configuration includes items for defining a speaker size: Large or Small. Large and Small refer to speakers with woofer diameters 16 cm or larger and smaller than 16 cm, respectively.

Bass Out

Choices: SWFR/Front/Both*

Selects speaker(s) for outputting low-frequency components of the LFE (low-frequency effect sound) channel or other channels. The output status is as follows.

LFE channel signals

Parameter	Subwoofer	Front speakers	Other speakers
Both	Output	Not output	Not output
SWFR	Output	Not output	Not output
Front	Not output	Output	Not output

Low-frequency components of other channel signals

Parameter	Subwoofer	Front speakers	Other speakers
Both	[1]	[2]	[3]
SWFR	[4]	[3]	[3]
Front	Not output	[1]	[3]

- [1] Outputs low-frequency components of the front left and right channels and the channel of speaker, the size of which is set to "Small."
- [2] Outputs low-frequency components of the front left and right channels.
- [3] Outputs low frequency components when the sizes of speakers are set to "Large."
- [4] Outputs low-frequency components of the channel of speaker, the size of which is set to "Small."

Front

Choices: Small/Large*

Sets the sizes of front left and right speakers.

- Small** Select this when small speakers are connected. Low-frequency components of the front left and right channels are output from a subwoofer.
- Large** Select this when large speakers are connected.

Note

- When "Bass Out" is set to "Front," you can only select "Large." If "Bass Out" is changed to "Front," "Front" automatically switches to "Large" even when it is set to "Small."

Center

Choices: None/Small*/Large

Sets the size of center speaker.

- None** Select this when no center speaker is connected. Center channel signals are spread to front left and right speakers.
- Small** Select this when a small center speaker is connected. Low-frequency components of center channel are output from a subwoofer. If a subwoofer is not connected they are output from front speakers.
- Large** Select this when a large center speaker is connected.

Sur. LR

Choices: None/Small*/Large

Sets sizes of left and right surround speakers.

- None** Select this when no surround speakers are connected. Surround channel signals are spread to front left and right speakers. "Sur.B" automatically switches to "None" when this is selected.

- Small** Select this when small surround speakers are connected. Low-frequency components of surround channels are output from a subwoofer. If a subwoofer is not connected they are output from front speakers.
- Large** Select this when large surround speakers are connected.



- When "None" is selected, the sound field programs automatically enter the Virtual CINEMA DSP mode.

Sur. B

Choices: None*/SMLx1/SMLx2/LRGx1/LRGx2

Sets sizes of left and right surround back speakers. When using the surround back speakers, connect an external amplifier to the SURROUND BACK jacks of the PRE OUT terminals.

- None** Select this when no surround back speaker are connected. Surround back channel signals are output from the surround L/R speakers and subwoofer. If the subwoofer is disabled, they are output from the surround L/R speakers and front speakers.
- SMLx1** Select this when one small surround back speaker is connected to an external amplifier for the surround back speaker.
- SMLx2** Select this when two small surround back speakers are connected to an external amplifier for the surround back speakers.
- LRGx1** Select this when one large surround back speaker is connected to an external amplifier for the surround back speaker.
- LRGx2** Select this when two large surround back speakers are connected to an external amplifier for the surround back speakers.



- When "None" is selected, "PLIIX Movie" or "PLIIX Music" cannot be selected.

Crossover

Choices: 40Hz/60Hz/80Hz*/90Hz/100Hz/110Hz/120Hz/160Hz/200Hz

Sets the lower limit of the low frequency component output from a speaker with a size set to "Small (SMLx1/SMLx2)." Sound with a frequency below that limit is output from a subwoofer or front speakers. If your subwoofer has a volume control or a crossover frequency control, set the volume to half or the crossover frequency at the maximum.

SWFR Phase

Choices: NRM*/REV

Sets the phase of your subwoofer if bass sounds are lacking or unclear.

- NRM** Select this not to change the phase of your subwoofer.
- REV** Select this to reverse the phase of your subwoofer.

■ B)Level

Adjustable range: -10.0dB to +10.0dB (0.5 dB step)

Defaults: "FL/FR/SW" 0dB*
"C/SL/SR/SBL/SBR" -1.0dB

Separately adjusts volume of each speaker so that the sounds from speakers are at the same volume at the listening position. Items to be displayed vary depending on the number of speakers connected.



- When only one surround back speaker is connected, "SB" appears instead of "SBL" and "SBR."
- You can adjust the volume listening to test tones when you set "Test Tone" to "On" (see page 41).
- If your subwoofer has a volume control or a crossover frequency control, set the volume to half or the crossover frequency at the maximum.

■ C)Distance

Adjusts timing at which each speaker outputs sound so that sounds from speakers reach the listening position at the same time. Set unit (Unit) first and set the distance of each speaker.

Unit

Choices: meters (m)/feet (ft)*

meters (m) Displays the speaker distance in meters.

feet (ft) Displays the speaker distance in feet.

Front L/Front R/Center/Sur. L/
Sur. R/Sur.B L/Sur.B R/SWFR

Adjustable range: 0.30m to 24.00m (1.0ft to 80.0ft)

Defaults: 3.00m (10.0ft) "Front L/Front R/
SWFR"
2.60m (8.5ft) "Center"
2.40m (8.0ft) "Sur. L/Sur. R/
Sur.B L/Sur.B R"



- Different items are displayed depending on settings of "A)Config" (see page 39).
- When only one surround back speaker is connected, "Sur. B" appears instead of "Sur.B L" and "Sur.B R."

Note

- If Auto Setup is executed while an external amplifier for the surround back speaker being connected, a distance to the surround back speaker longer than an actual distance may be displayed depending on the volume or balance setting of the external amplifier.

■ D)Equalizer

Adjusts sound quality and tone using a parametric graphic equalizer.

EQ Select.

Choices: PEQ/GEQ*/Off

Select an equalizer type.

PEQ Uses a parametric equalizer selected in "1 Auto Setup."

GEQ Uses a graphic equalizer. Press **[4]ENTER** to adjust the characteristics of the graphic equalizer.

Off Not use a graphic equalizer.

GEQ

Choices: 63Hz/160Hz/400Hz/1kHz/2.5kHz/
6.3kHz/16kHz

Adjustable range: -6.0dB to 0dB* to +6.0dB (0.5 dB step)

Adjusts sound quality of each speaker using a graphic equalizer. The graphic equalizer of this unit can adjust signal levels in 7 frequency ranges.

To adjust the signal level within each range, select the desired speaker with **[4]Cursor** </> while "Channel" is displayed, then the desired frequency band with **[4]Cursor** Δ / ▽, and adjust the signal level with **[4]Cursor** </>.

■ E)Test Tone

Choices: Off*/On

Switches between on and off of an oscillator that generates test tones. To turn on the oscillator, select "On" using **[4]Cursor** </>. When "On" is selected, you can adjust the settings of "2 Manual Setup" while listening to a test tone.

Off Not generate test tones.

On Generates test tones.

Sound Setup

You can set various items for sound outputs.

■ 1 D.Range

Choices: Min/Auto/STD/Max*

Selects the dynamic range adjustment method for reproducing bitstream signals.

Min/Auto (Min) Sets the dynamic range suitable for low volume or a quiet environment, such as at night, for bitstream signals except for Dolby TrueHD signals.

(Auto) Adjusts the dynamic range for Dolby TrueHD signals based on input signal information.

STD Sets the standard dynamic range recommended for regular home use.

Max Outputs sound without adjusting the dynamic range of the input signals.

■ 2 Lipsync

Adjusts delay between video output and audio output.

HDMI Auto

Choices: Off*/On

Automatically adjusts output timing of audio and video signals when a monitor that supports an automatic lip-sync function is connected to this unit.

Off Select this when the connected monitor does not support the automatic lip-sync function or you do not use the automatic lip-sync function. Set the correction time in "Manual."

On Select this when the connected monitor supports the automatic lip-sync function. Fine adjust the correction time in "Auto Delay."

Auto

Adjustable range: 0 to 240ms (1 ms step)

Enables manual fine adjustment of the correction time when “HDMI Auto” is set to “On.”

Manual

Adjustable range: 0* to 240ms (1 ms step)

Manually adjusts the correction time. Select this when the connected monitor does not support the automatic lip-sync function or you set “HDMI Auto” to “Off.”

Function Setup

You can set various items for HDMI and display.

1 HDMI

You can set items for HDMI.

■ Standby

Choices: On/Off*

Selects on or off of output of HDMI signals input from the HDMI IN jack to the HDMI OUT jack when this unit is on standby. When this parameter is set to “On” signals input from the HDMI 1-4 jacks can be output to a monitor component.

On Outputs the HDMI signals to the HDMI OUT jack.

Off Not output the HDMI signals to the HDMI OUT jack.



- To enable pass-through output, any one of the input sources connected to the HDMI-4 must be selected before switching to standby.
- When Standby Through turns on, the HDMI THROUGH indicator on the front panel display lights up. While the indicator lights up, this unit consumes up to 3W of power even on standby.

■ Audio

Choices: AMP*/TV/AMP+TV

Selects this unit or a component connected to this unit via the HDMI OUT jack of this unit for reproducing sound signals input from the HDMI IN jack.

AMP Outputs HDMI sound signals from the speakers connected to this unit.

TV Outputs HDMI sound signals from the speakers of a TV connected to this unit. Sound output from the speakers connected to this unit is muted.

AMP+TV Outputs HDMI sound signals from the speakers connected to this unit and the speakers of a TV connected to this unit.

Note

- Signal formats of audio and visual signals output from this unit to the monitor vary depending on specifications of the monitor.

2 Display

You can set items for the front panel display.

■ Dimmer

Adjustable range: -4 to 0*

Sets brightness of the front panel display. As the value is lowered, the brightness of the front panel display is darkened.

Note

- The brightness of display does not become bright in direct mode even if the value is increased.

■ FL Scroll

Choices: Cont*/Once

Selects the way to scroll the screen when a total number of characters exceed a display area of the front panel display.

Cont Repeatedly displays all characters by scrolling.

Once Displays all characters by scrolling once, halts scrolling, and then displays first 14 characters.

3 Volume

You can set items for volumes.

■ Adaptive DRC

Choices: Auto/Off*

Adjust the dynamic range in conjunction with the volume level. This feature is useful when you are listening at lower volumes or at night. When this function is enabled, the dynamic range is adjusted as follows.

If the VOLUME setting is low:
the dynamic range is narrow

If the VOLUME setting is high:
the dynamic range is wide

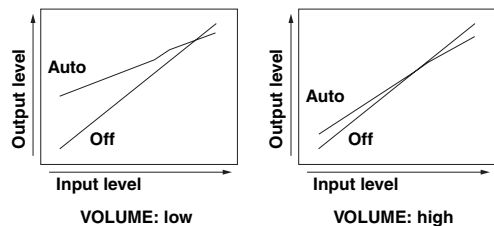

Auto Adjusts the dynamic range automatically.

Off Not adjust the dynamic range automatically.



- The Adaptive DRC setting is effective for headphones.

■ MaxVol

Adjustable range: -30.0dB to +15.0dB/+16.5dB* (5.0 dB step)

Sets the maximum volume level so that the volume will not be accidentally increased. For example, you can adjust the volume between -80.0 dB and -5.0 dB when you set this parameter to "-5.0dB." The volume increases to the maximum level when this parameter is set to +16.5 dB (default).

■ IniVol

Choices: Off*/Mute/-80.0dB to +16.5dB (0.5 dB step)

Sets the volume at the time this unit is turned on. When this parameter is set to "Off," the volume is set to a level that last time this unit is set to standby.

Note

- When you set "MaxVol" and "IniVol," the setting of "MaxVol" becomes effective. For example, when you set "MaxVol" to "-30.0dB" and "IniVol" to "0.0dB," the volume is automatically set to "-30.0dB" at the next time this unit is turned on.

4 Input Rename

Changes input source names to be displayed on the front panel display.

You can select an input source that you want to change the name to be displayed using **[4]Cursor**.

Selecting a name to be displayed from templates

Select an input source that you want to change the name, and select a name from the following templates using Cursor.

- Blu-ray	- Satellite
- DVD	- VCR
- SetTopBox	- Tape
- Game	- MD
- TV	- PC
- DVR	- iPod
- CD	- HD DVD
- CD-R	- "blank"

Entering an original name

Select an input source that you want to name, and press **[4]ENTER**. You can enter up to 9 characters by selecting one character at a time with the following keys according to the following operation.

- [4]Cursor** </> For selecting characters that you want to change
- [4]Cursor** Δ / ▽ For selecting characters to be entered
- [4]ENTER** For entering the selected characters

The following characters are available for input.

A to Z, 0 to 9, a to z, symbols (#, *, -, +, etc.) and space

DSP Parameter

You can set parameters for the sound field programs. For details, see page 36.

Memory Guard

Choices: Off*/On

Protects settings of setup menu against accidental alteration.

- Off Not protect settings.
- On Protects the settings of the setup menu (except for the Memory Guard setting).

Controlling other components with the remote control

You can control external components for a selected input source with the remote control. The keys available for controlling external components are as follows:

4 SOURCE POWER

Turns on and off an external component.

14 Cursor, ENTER, RETURN

Operates the menus of external components.

16 DISPLAY

Switches between the screens of external components.

18 External component operation keys

Function as a recording or playback key of an external component, or a menu display key.

19 Numeric keys

Function as numeric keys of an external component.

20 TV control keys

INPUT Switches visual inputs of TV

MUTE Mute audio of TV

TV VOL +/- Controls the volume of TV

TV CH +/- Switches channels of TV

POWER Turns on and off TV



- You can use **20 TV control keys** only for controls of TV regardless of selected input sources.
- You need to set the remote control code first to control external components.
- The remote control keys for controlling external components are available only when the external components have corresponding control keys.

The following remote control codes are assigned to input sources as factory default settings. For a complete list of available remote control codes, refer to “List of remote control codes” at the end of this manual.

Default remote control code settings

Input source	Category	Manufacturer	Default code
[HDMI1]	Blu-ray Disc	Yamaha	2018
[HDMI2]	—	—	—
[HDMI3]	—	—	—
[HDMI4]	—	—	—
[AV1]	—	—	—
[AV2]	—	—	—
[AV3]	CD	Yamaha	5013
[AV4]	—	—	—
[AV5]	—	—	—
[AV6]	—	—	—
[AUDIO1]	—	—	—
[AUDIO2]	—	—	—
[V-AUX]	—	—	—
[TUNER]	Tuner	Yamaha	5007

Input source	Category	Manufacturer	Default code
[DOCK]	DOCK	Yamaha	5011
[A]/[B]	—	—	—

“—” indicates no assignment



- An external component that is controlled by the remote control can be automatically selected according to selection of the scenes (see page 21).

Setting remote control codes

You can control other components by setting the appropriate remote control codes. For a complete list of available remote control codes, refer to “List of remote control codes” at the end of this manual.

1 Press 3 CODE SET on the remote control using a pointed object such as the tip of a ballpoint pen.
2 TRANSMIT on the remote control blinks twice.

2 Press 7 Input selection keys.

3 Enter a remote control code using 19 Numeric keys.

Once the remote control code is registered, **2 TRANSMIT** on the remote control blinks twice. If it fails, **2 TRANSMIT** blinks six times. Repeat from step 1.

Resetting all remote control codes

You can clear all the remote control codes previously set, and reset all of them to the initial factory settings.

1 Press 3 CODE SET on the remote control using a pointed object such as a tip of a ballpoint pen.
2 TRANSMIT on the remote control blinks twice.

2 Press 12 SETUP on the remote control.

3 Enter “9981” using 19 Numeric keys.
 Once the initialization is complete, **2 TRANSMIT** on the remote control blinks twice. If it fails, **2 TRANSMIT** blinks six times. Repeat from step 1.

Advanced setup

In the advanced setup, you can set basic operations of this unit, such as on and off of a bi-amp connection, or initialize user settings. Perform the following steps to change settings.

1 Set this unit to the standby mode.

2 Press **Ⓐ**STANDBY/ON while pressing and holding **Ⓛ**STRAIGHT on the front panel.

The advanced setup menu appears on the front panel display.



ADVANCED SETUP

3 Press **Ⓚ**PROGRAM **◀/▶** repeatedly to select the parameter you want to change.

The default setting are marked with “*.”



- XXX in the following parameters indicate the set values.

SP IMP. - XXX

Choices: 60MIN/80MIN*

Selects output impedance of this unit according to connected speakers.

REMOTE ID-XXX

Choices: ID1*/ID2

Sets a remote control ID. When using multiple Yamaha AV receivers, you can operate them with a single remote control by setting the receiver IDs to the same setting.

INIT-XXXXXXXX

Choices: DSP PARAM/ALL/CANCEL

Initializes various settings stored in this unit. You can select an initialization method from the following.

DSP PARAM: All parameters of sound field programs
ALL: Reset this unit to initial factory settings
CANCEL: Cancellation of initialization

4 Press **Ⓛ**STRAIGHT a few times to select the value you want to change.

The value selected here becomes effective when this unit is turned on the next time. You can change multiple settings by repeating steps 3 and 4.

5 Press **Ⓐ**STANDBY/ON, turns off this system, and press **Ⓐ**STANDBY/ON again.

The value set in step 3 becomes effective, and this unit turns on. When you select initialization in step 3, the initialization is performed.

Setting a remote control ID

Two IDs are provided for the remote control of this unit. If another Yamaha amplifier is in the same room, setting a different remote control ID to this unit prevents unwanted operation of the other amplifier.

ID1 is set for both remote control and amplifier by default. When you change the remote control ID, display “Advance Setup” (see the previous section) and change the ID for the amplifier too.

1 Press **Ⓜ**CODE SET on the remote control using a pointed object such as the tip of a ballpoint pen.

ⓂTRANSMIT blinks twice.

2 Press **Ⓜ**SETUP on the remote control.

3 Enter the desired remote control ID code.

To switch to ID1:

Enter “5019” using **Ⓜ**Numeric keys.

To switch to ID2:

Enter “5020” using **Ⓜ**Numeric keys.

Once the remote control code is registered,

ⓂTRANSMIT blinks twice.

If it fails, **Ⓜ**TRANSMIT blinks six times. Repeat from step 1.



- Initializing the remote control code (see page 44) returns it to ID1.

APPENDIX

Troubleshooting

Refer to the table below when this unit does not function properly. If the problem you are experiencing is not listed below or if the instruction below does not help, turn off this unit, disconnect the power cable, and contact the nearest authorized Yamaha dealer or service center.

General

Problem	Cause	Remedy	See page
This unit fails to turn on or enters the standby mode soon after the power is turned on.	The power cable is not connected or the plug is not completely inserted.	Connect the power cable properly to an AC wall outlet.	—
	The speaker impedance setting is incorrect.	Set the speaker impedance to match your speakers.	45
	(When this unit is turned back on and “CHECK SP WIRES!” is displayed.) The protection circuitry has been activated because this unit was turned on while a speaker cable was shorted.	Make sure that all speaker cables between this unit and speakers are connected properly.	11
This unit cannot be turned off.	The internal microcomputer is frozen due to an external electric shock (such as lightning or excessive static electricity) or by a drop in power supply voltage.	Disconnect the power cable from the AC wall outlet, wait about 30 seconds and then plug it in again.	—
No sound.	“Audio” in “1 HDMI” of Function Setup is set to “TV.”	Select a choice for “Audio” (Function Setup→1 HDMI→Audio) other than “TV.”	42
	A proper audio decoder is not selected.	Display the OPTION menu and set “Decoder Mode” to “Auto.”	33
	Incorrect input or output cable connections.	Connect the cables properly. If the problem persists, the cables may be defective.	14-16
	No appropriate input source has been selected.	Select an appropriate input source with INPUT < > or the Input selection keys on the remote control.	21
	Speaker connections are not secure.	Secure the connections.	11
	The volume is turned down or muted.	Turn up the volume.	—
	Signals this unit cannot reproduce are being input from a source component, such as a CD-ROM.	Display Signal info of the option menu and check the input signal format. If “No Signal” is displayed, check if the playback component is properly connected to this unit (or a proper input source is selected). If “___” is displayed, the input signal in that format cannot be reproduced by this unit.	—
	The HDMI components connected to this unit do not support the HDCP copy protection standards.	Connect HDMI components that support the HDCP copy protection standards.	55

Problem	Cause	Remedy	See page
No picture.	An appropriate video input is not selected on the monitor.	Select an appropriate video input on the monitor.	—
	The composite output terminals are used to output a component video signal, or the COMPONENT VIDEO jacks are used to output a composite video signal.	If your monitor does not support the HDMI connection, connect it to the COMPONENT OUT jacks or the composite output terminals and select an appropriate video input on the monitor.	14
	Non-standard video signals are input.	Connect the monitor to this unit via the COMPONENT OUT jacks or the composite output terminals.	14
The sound suddenly goes off.	The protection circuitry has been activated because of a short circuit, etc.	Check that the speaker impedance setting is correct.	45
		Check that the speaker wires are not touching each other and then turn this unit back on.	—
	The sleep timer has turned off this unit.	Turn on this unit, and play the source again.	—
Sound is heard from the speaker on one side only.	The playback component or speakers are not connected properly.	Connect the cables properly. If the problem persists, the cables may be defective.	11
	The speaker level settings are incorrect.	Adjust “B)Level” settings.	41
Only the center speaker outputs substantial sound.	When a monaural source sound field program is applied, sound of all channels are output from the center speaker for some surround decoders.	Try another sound field program.	24
No sound is output from a specific speaker.	Output from that speaker is disabled.	Check the Speaker indicators on the front panel display. If the corresponding indicator is turned off, try the following. 1) Change the input source to another one. 2) With the selected sound field program, sound is not output from that speaker. Select another sound field program. 3) “None” may have been selected for that speaker on this unit. Display Speaker Setup in the Setup menu and enables output of that speaker.	6, 21, 24, 40
		The volume of that speaker is set to minimum in Speaker Setup in the Setup menu.	Display Speaker Setup in the Setup menu and adjust the volume (Manual Setup→B)Level).
	This unit or speaker is malfunction.	Check the Speaker indicators on the front panel display. If the corresponding indicator lights up, connect another speaker and check if sound is output. If sound is not output, this unit may be malfunction.	6, 10
No sound is heard from the surround speakers.	This unit is in the “STRAIGHT” mode and a monaural source is being played back.	Press ⏪ STRAIGHT or the ⏩ STRAIGHT on the remote control to turn off the “STRAIGHT” mode.	27
	Sound may not be output from certain channels depending on input sources or sound field programs.	Try another sound field program.	24

Problem	Cause	Remedy	See page
No sound is heard from the subwoofer.	“Bass Out” of “A)Config” in “Speaker Setup” of the setup menu (Speaker Setup→Manual Setup→A)Config) is set to “Front” when a Dolby Digital, DTS or AAC signal is being played.	Set “Bass Out” to “SWFR” or “Both.”	39
	“Bass Out” of “A)Config” in “Speaker Setup” of the setup menu (Speaker Setup→Manual Setup→A)Config) is set to “SWFR” or “Front” when a 2-channel source is being played.	Set “Bass Out” to “Both.”	39
	The source does not contain low frequency signals.		
No sound is heard from the surround back speakers.	“EXTD Surround” in the OPTION menu is set to “Off,” or an input signal does not contain a surround back flag with “EXTD Surround” set to “Auto.”	Set “EXTD Surround” other than “Off” or “Auto.”	40
The audio input sources cannot be played in the desired digital audio signal format.	The connected component is not set to output the desired digital audio signals.	Set the playback component properly referring to its operating instructions.	—
Noise/hum noise is heard.	Incorrect cable connection.	Connect the audio cables properly. If the problem persists, the cables may be defective.	—
	A DTS-CD is being played back.	1) When only noise is output If a DTS bitstream signal is not properly input to this unit, only noise is output. Connect the playback component to this unit by digital connection and play back the DTS-CD. If the condition is not improved, the problem may result from the playback component. Consult the manufacturer of the playback component. 2) When noise is output during playback or skip operation Before playing back the DTS-CD, display the option menu after selecting the input source and set “Decoder Mode” to “DTS.”	16, 34
“Memory Guard!” is displayed and the setting cannot be changed.	“Memory Guard” in “Set Menu” is set to “On.”	Set “Memory Guard” to “Off.”	43
This unit does not operate properly.	The internal microcomputer is frozen due to an external electric shock (such as lightning or excessive static electricity) or by a drop in power supply voltage.	Disconnect the power cable from the AC wall outlet, wait about 30 seconds and then plug it in again.	—
“CHECK SP WIRES!” appears on the front panel display.	Speaker cables are short-circuited.	Make sure all speaker cables are connected correctly.	12
There is noise interference from digital or radio frequency equipment.	This unit is too close to other digital or radio frequency equipment.	Move this unit further away from such equipment.	—

Problem	Cause	Remedy	See page
The picture is disturbed.	The video software is copy-protected.		
This unit suddenly enters the standby mode.	The internal temperature becomes too high and the overheat protection circuitry has been activated.	Wait about 1 hour for this unit to cool down and then turn it back on.	—

HDMI

Problem	Cause	Remedy	See page
No picture or sound.	The number of the connected HDMI components is over the limit.	Disconnect some of the HDMI components.	—
	The connected HDMI component does not support high-bandwidth digital copyright protection (HDCP).	Connect an HDMI component that supports HDCP.	15

Tuner (FM/AM)

Problem	Cause	Remedy	See page
FM stereo reception is noisy.	You are too far from the station transmitter or the input from the antenna is weak.	Check the antenna connections.	17
		Replace the outdoor antenna with a more sensitive multi-element antenna.	—
		Switch to monaural mode.	34
FM There is distortion, and clear reception cannot be obtained even with a good FM antenna.	There is multi-path interference.	Adjust the antenna height or orientation, or place it in a different location.	—
The desired station cannot be tuned into with the automatic tuning method.	You are in an area far from a station or an input from the antenna is weak.	Replace an outdoor antenna with more sensitive multi element antenna.	—
		Tune in manually or by direct frequency tuning.	28
The desired station cannot be tuned into with the automatic tuning method.	The signal is weak or the antenna connections are loose.	Adjust the AM loop antenna orientation.	17
		Use the manual tuning method.	28
AM There are continuous crackling and hissing noises.	Supplied AM loop antenna is not connected.	Connect the AM loop antenna correctly even if you use an outdoor antenna.	17
	The noises may be caused by lightning, fluorescent lamps, motors, thermostats and other electrical equipment.	It is difficult to completely eliminate noise, but it can be reduced by installing and properly grounding an outdoor AM antenna.	17
There are buzzing and whining noises.	A TV set is being used nearby.	Move this unit away from the TV set.	—

Remote control

Problem	Cause	Remedy	See page	
The remote control does not work or function properly.	Wrong distance or angle.	The remote control will function within a maximum range of 6 m (20 ft) and no more than 30 degrees offaxis from the front panel.	9	
	Direct sunlight or lighting (from an inverter type of fluorescent lamp, strobe light, etc.) is striking the remote control sensor of this unit.	Adjust the lighting angle or reposition this unit.	—	
	The batteries are weak.	Replace all batteries.	9	
	The remote control ID of the remote control and this unit do not match.	Match the remote control ID of this unit and the remote control.	45	
	The remote control code is not correctly set.		Set the remote control code correctly using “List of remote control codes” at the end of this manual.	44
			Try setting another code of the same manufacturer using “List of remote control codes” at the end of this manual.	44
		If this unit does not work when you press [4]Cursor , do the following. When the key does not work during DVD disc menu operation: press the [7]Input selection keys on the remote control again. When the key does not work during OPTION menu/SETUP menu operation: press the key applicable for the current menu operation again.	—	
	Even if the remote control code is correctly set, there are some models that do not respond to the remote control.			

iPod

Note

- In case of a transmission error without a status message appearing on the front panel display, check the connection of your iPod (see page 16).

Problem	Cause	Remedy	See page
Loading...	This unit is in the middle of recognizing the connection with your iPod.		
	This unit is in the middle of acquiring song lists from your iPod.		
Connect error	There is a problem with the signal path from your iPod to this unit.	Turn off this unit and reconnect the Yamaha iPod universal dock to the DOCK terminal of this unit.	16
		Remove your iPod in the Yamaha iPod universal dock and then place it back in the dock.	16
Unknown iPod	The iPod being used is not supported by this unit.	This unit supports iPod Touch, iPod (Click Wheel), iPod nano and iPod mini.	—
iPod Connected	Your iPod is properly placed in the Yamaha iPod universal dock.		
Disconnected	Your iPod is removed from the Yamaha iPod universal dock.	Place your iPod in the Yamaha iPod universal dock.	16

Problem	Cause	Remedy	See page
Unable to play	This unit cannot play back the songs currently stored on your iPod.	Check that the songs currently stored on your iPod are playable. Store some other playable music files on your iPod.	— —

Bluetooth™

Problem	Cause	Remedy	See page
Searching...	The Bluetooth wireless audio receiver and the Bluetooth component are in the middle of the pairing. The Bluetooth wireless audio receiver and the Bluetooth component are in the middle of establishing the connection.		
Completed	The pairing is completed.		
Canceled	The pairing is canceled.		
BT Connected	The connection between the Yamaha Bluetooth wireless audio receiver and the Bluetooth component is established.		
BT Disconnected	The Bluetooth component is disconnected from the Yamaha Bluetooth wireless audio receiver.		

Auto Setup (YPAO)

Notes

- If the "ERROR" or "WARNING" message appears, resolve the problem and then run "Auto Setup" again.
- Warning message "W-2" or "W-3" indicates that the adjusted settings may not be optimal.
- Depending on the speakers, warning message "W-1" may appear even if the speaker connections are correct.
- If error message "E-10" occurs repeatedly, contact a qualified Yamaha service center.

Before Auto Setup

Error message	Cause	Remedy	See page
Connect MIC!	Optimizer microphone is not connected.	Connect the supplied optimizer microphone to the OPTIMIZER MIC jack on the front panel.	18
Unplug HP!	Headphones are connected.	Unplug the headphones.	—
Memory Guard!	The parameters of this unit are protected.	Set "Memory Guard" to "Off."	43

During Auto Setup

Error message	Cause	Remedy	See page
E-1:NO FRONT SP	Front L/R channel signals are not detected.	Check the front L/R speaker connections.	11
E-2:NO SUR. SP	Only a signal from one of the surround channels are detected.	Check the surround L/R speaker connections.	11
E-4:SBR->SBL	Only right surround back channel signal is detected.	If you connect only one surround back speaker, connect it to the L-side (SINGLE) terminal.	11

Error message	Cause	Remedy	See page
E-5:NOISY	Measurement cannot be performed accurately due to loud ambient noise.	Try running "Auto Setup" in a quiet environment.	—
		Turn off noisy electric equipment like air conditioners or move them away from the optimizer microphone.	—
E-6:CHECK SUR.	Surround back speakers are connected, though surround L/R speakers are not.	When using surround back speakers, you need to connect surround L/R speakers.	11
E-7:NO MIC	The optimizer microphone was unplugged during the "Auto Setup" procedure.	Do not touch the optimizer microphone during "Auto Setup."	18
E-8:NO SIGNAL	The optimizer microphone does not detect test tones.	Check whether the microphone is properly placed.	18
		Check whether the speakers are properly placed and connected.	11
		The optimizer microphone or OPTIMIZER MIC jack may be defective. Contact the nearest Yamaha dealer or service center.	18
E-9:USER CANCEL	"Auto Setup" was cancelled due to an inappropriate user operation.	Run "Auto Setup" again.	18
E-10:INTERNAL ERROR	An internal error occurred.	Run "Auto Setup" again.	18

After Auto Setup

Error message	Cause	Remedy	See page
W-1:OUT OF PHASE	Speaker polarity is not correct. This message may appear depending on the speakers even when the speakers are connected correctly.	Check the polarities (+, -) of the displayed speaker. If they are correct, the speakers work properly even when this message is displayed.	11
W-2:OVER 24m (80ft)	The distance between the speaker and the listening position is over 24 m (80 ft).	Bring the speaker within 24 m (80 ft.) area around the listening position.	—
W-3:LEVEL ERROR	The difference of volume level among speakers is excessive.	Recheck the speaker positions and make sure all speakers are placed in a similar environment.	—
		Check the polarities (+, -) of the speakers.	11
		We recommended that you use speakers with the same or similar specifications.	—
		Adjust the output volume of the subwoofer.	—
	If a warning message related to the surround back speaker is displayed, the volume or right and left balance of the external amplifier may not be properly set.	Check if the volume or balance of the external amplifier is proper.	—

■ Audio and video synchronization (lip sync)

Lip sync, an abbreviation for lip synchronization, is a technical term that involves both a problem and a capability of maintaining audio and video signals synchronized during post-production and transmission. Whereas the audio and video latency requires complex end-user adjustments, HDMI version 1.3 incorporates an automatic audio and video syncing capability that allows devices to perform this synchronization automatically and accurately without user interaction.

■ Bi-amplification connection

A bi-amplification connection uses two amplifiers for a speaker. One amplifier is connected to the woofer section of a loudspeaker while the other is connected to the combined mid and tweeter section. With this arrangement each amplifier operates over a restricted frequency range. This restricted range presents each amplifier with a much simpler job and each amplifier is less likely to influence the sound in some way.

■ Component video signal

With the component video signal system, the video signal is separated into the Y signal for the luminance and the PB and PR signals for the chrominance. Color can be reproduced more faithfully with this system because each of these signals is independent. The component signal is also called the “color difference signal” because the luminance signal is subtracted from the color signal. A monitor with component input jacks is required in order to output component signals.

■ Composite video signal

With the composite video signal system, the video signal is composed of three basic elements of a video picture: color, brightness and synchronization data. A composite video jack on a video component transmits these three elements combined.

■ Deep Color

Deep Color refers to the use of various color depths in displays, up from the 24-bit depths in previous versions of the HDMI specification. This extra bit depth allows HDTVs and other displays go from millions of colors to billions of colors and eliminate on-screen color banding for smooth tonal transitions and subtle gradations between colors. The increased contrast ratio can represent many times more shades of gray between black and white. Also Deep Color increases the number of available colors within the boundaries defined by the RGB or YCbCr color space.

■ Dolby Digital

Dolby Digital is a digital surround sound system that gives you completely independent multi-channel audio. With 3 front channels (front L/R and center), and 2 surround stereo channels, Dolby Digital provides 5 full-range audio channels. With an additional channel especially for bass effects, called LFE (Low Frequency Effect), the system has a total of 5.1-channels (LFE is counted as 0.1 channel). By using 2-channel stereo for the surround speakers, more accurate moving sound effects and surround sound environment are possible than with Dolby Surround. The wide dynamic range from maximum to minimum volume reproduced by the 5 full-range channels and the precise sound orientation generated using digital sound processing provide listeners with unprecedented excitement and realism. With this unit, any sound environment from monaural up to a 5.1-channel configuration can be freely selected for your enjoyment.

■ Dolby Digital Surround EX

Dolby Digital EX creates 6 full-bandwidth output channels from 5.1-channel sources.

For the best results, Dolby Digital EX should be used with movie sound tracks recorded with Dolby Digital Surround EX. With this additional channel, you can experience more dynamic and realistic moving sound especially with scenes with “fly-over” and “fly-around” effects.

■ Dolby Digital Plus

Dolby Digital Plus is an advanced audio technology developed for high-definition programming and media including HD broadcasts, and Blu-ray Disc. Selected as an optional audio standard for Blu-ray Disc, this technology delivers multichannel sound with discrete channel output. Supporting bitrates up to 6.0 Mbps, Dolby Digital Plus can carry up to 7.1 discrete audio channels simultaneously. Supported by HDMI version 1.3 and designed for the optical disc players and AV receivers/amplifiers of the future, Dolby Digital Plus also remains fully compatible with the existing multichannel audio systems that incorporate Dolby Digital.

■ Dolby Pro Logic II

Dolby Pro Logic II is an improved technique used to decode vast numbers of existing Dolby Surround sources. This new technology enables a discrete 5-channel playback with 2 front left and right channels, 1 center channel, and 2 surround left and right channels instead of only 1 surround channel for conventional Pro Logic technology. There are three modes available: “Music mode” for music sources, “Movie mode” for movie sources and “Game mode” for game sources.

■ Dolby Pro Logic IIx

Dolby Pro Logic IIx is a new technology enabling discrete multichannel playback from 2-channel or multi-channel sources. There are three modes available: “Music mode” for music sources, “Movie mode” for movie sources (for 2-channel sources only) and “Game mode” for game sources.

■ Dolby Surround

Dolby Surround is widely used with nearly all video tapes and laser discs, and in many TV and cable broadcasts as well. Dolby Surround uses a 4-channel analog recording system to reproduce realistic and dynamic sound effects: 2 front left and right channels (stereo), a center channel for dialog (monaural), and a surround channel for special sound effects (monaural). The surround channel reproduces sound within a narrow frequency range. The Dolby Pro Logic decoder built into this unit employs a digital signal processing system that automatically stabilizes the volume on each channel to enhance moving sound effects and directionality.

■ Dolby TrueHD

Dolby TrueHD is an advanced lossless audio technology developed for high-definition disc-based media including Blu-ray Disc. Selected as an optional audio standard for Blu-ray Disc, this technology delivers sound that is bit-for-bit identical to the studio master, offering a high-definition home theater experience. Supporting bitrates up to 18.0 Mbps, Dolby TrueHD can carry up to 8 discrete channels of 24-bit/96 kHz audio simultaneously. Dolby TrueHD also remains fully compatible with the existing multichannel audio systems and retains the metadata capability of Dolby Digital, allowing dialog normalization and dynamic range control.

■ DSD

Direct Stream Digital (DSD) technology stores audio signals on digital storage media, such as Super Audio CDs. Using DSD, signals are stored as single bit values at a high-frequency sampling rate of 2.8224 MHz, while noise shaping and oversampling are used to reduce distortion, a common occurrence with very high quantization of audio signals. Due to the high sampling rate, better audio quality can be achieved than that offered by the PCM format used for normal audio CDs. The frequency is equal to or higher than 100 kHz and the dynamic range is 120 dB. This unit can transmit or receive DSD signals via the HDMI jack.

■ DTS 96/24

DTS 96/24 offers an unprecedented level of audio quality for multi-channel sound on DVD video, and is fully backward-compatible with all DTS decoders. “96” refers to a 96 kHz sampling rate compared to the typical 48 kHz sampling rate. “24” refers to 24-bit word length. DTS 96/24 offers sound quality transparent to the original 96/24 master, and 96/24 5.1-channel sound with full-quality full-motion video for music programs and motion picture soundtracks on DVD video.

■ DTS Digital Surround

DTS digital surround was developed to replace the analog soundtracks of movies with a 5.1-channel digital sound track, and is now rapidly gaining popularity in movie theaters around the world. DTS, Inc. has developed a home theater system so that you can enjoy the depth of sound and natural spatial representation of DTS digital surround in your home. This system produces practically distortion-free 6-channel sound (technically, front left and right, center, surround left and right, and LFE 0.1 (subwoofer) channels for a total of 5.1 channels). This unit incorporates a DTS-ES decoder that enables 6.1-channel reproduction by adding the surround back channel to the existing 5.1-channel format.

■ DTS Express

This is an audio format for next-generation optical discs such as Blu-ray discs. It uses optimized low bit rate signals for network streaming. In the case of a Blu-ray disc, this format is used with secondary audio, enabling you to enjoy the commentary of the movie producer via the Internet while playing the main program.

■ DTS-HD High Resolution Audio

DTS-HD High Resolution Audio is a high resolution audio technology developed for high-definition disc-based media including Blu-ray Disc. Selected as an optional audio standard for Blu-ray Disc, this technology delivers sound that is virtually indistinguishable from the original, offering a high-definition home theater experience. Supporting bitrates up to 6.0 Mbps for Blu-ray Disc, DTS-HD High Resolution Audio can carry up to 7.1 discrete channels of 24-bit/96 kHz audio simultaneously.

DTS-HD High Resolution Audio also remains fully compatible with the existing multichannel audio systems that incorporate DTS Digital Surround.

■ DTS-HD Master Audio

DTS-HD Master Audio is an advanced lossless audio technology developed for high-definition disc-based media including Blu-ray Disc. Selected as an optional audio standard for Blu-ray Disc, this technology delivers sound that is bit-for-bit identical to the studio master, offering a high-definition home theater experience. Supporting bitrates up to 24.5 Mbps for Blu-ray Disc, DTS-HD Master Audio can carry up to 7.1 discrete channels of 24-bit/96 kHz audio simultaneously. Supported by HDMI version 1.3 and designed for the optical disc players and AV receivers/amplifiers of the future, DTS-HD Master Audio also remains fully compatible with the existing multichannel audio systems that incorporate DTS Digital Surround.

■ HDMI

HDMI (High-Definition Multimedia Interface) is the first industry-supported, uncompressed, all-digital audio/video interface. Providing an interface between any source (such as a set-top box or AV receiver) and an audio/video monitor (such as a digital television), HDMI supports standard, enhanced or high-definition video as well as multi-channel digital audio using a single cable. HDMI transmits all ATSC HDTV standards and supports 8-channel digital audio, with bandwidth to spare to accommodate future enhancements and requirements.

When used in combination with HDCP (High-bandwidth Digital Content Protection), HDMI provides a secure audio/video interface that meets the security requirements of content providers and system operators. For further information on HDMI, visit the HDMI website at “<http://www.hdmi.org/>”

■ LFE 0.1 channel

This channel reproduces low-frequency signals. The frequency range of this channel is from 20 Hz to 120 Hz. This channel is counted as 0.1 because it only enforces a low-frequency range compared to the full-range reproduced by the other 5/6 channels in Dolby Digital or DTS 5.1/6.1-channel systems.

■ Neo:6

Neo:6 decodes the conventional 2-channel sources for 6-channel playback by the specific decoder. It enables playback with the full-range channels with higher separation just like digital discrete signal playback. There are two modes available: “Music mode” for music sources and “Cinema mode” for movie sources.

■ PCM (Linear PCM)

Linear PCM is a signal format under which an analog audio signal is digitized, recorded and transmitted without using any compression. This is used as a method of recording CDs and DVD audio. The PCM system uses a technique for sampling the size of the analog signal per very small unit of time. Standing for “Pulse Code Modulation,” the analog signal is encoded as pulses and then modulated for recording.

■ Sampling frequency and number of quantized bits

When digitizing an analog audio signal, the number of times the signal is sampled per second is called the sampling frequency, while the degree of fineness when converting the sound level into a numeric value is called the number of quantized bits. The range of rates that can be played back is determined based on the sampling rate, while the dynamic range representing the sound level difference is determined by the number of quantized bits. In principle, the higher the sampling frequency, the wider the range of frequencies that can be played back, and the higher the number of quantized bits, the more finely the sound level can be reproduced.

■ “x.v.Color”

A color space standard supported by HDMI version 1.3. It is a more extensive color space than sRGB, and allows the expression of colors that could not be expressed before. While remaining compatible with the color gamut of sRGB standards, “x.v.Color” expands the color space and can thus produce more vivid, natural images. It is particularly effective for still pictures and computer graphics.

Sound field program information

■ CINEMA DSP

Since the Dolby Surround and DTS systems were originally designed for use in movie theaters, their effect is best felt in a theater having many speakers designed for acoustic effects. Since home conditions, such as room size, wall material, number of speakers, and so on, can differ so widely, it is inevitable that there are differences in the sound heard.

Based on a wealth of actually measured data, Yamaha CINEMA DSP provides the audiovisual experience of a movie theater in the listening room of your own home by using the Yamaha original sound field technology combined with various digital audio systems.

■ SILENT CINEMA

Yamaha has developed a natural, realistic sound effect DSP algorithm for headphones. Parameters for headphones have been set for each sound field so that accurate representations of all the sound field programs can be enjoyed on headphones.

■ Virtual CINEMA DSP

Yamaha has developed a Virtual CINEMA DSP algorithm that allows you to enjoy DSP sound field surround effects even without any surround speakers by using virtual surround speakers. It is even possible to enjoy Virtual CINEMA DSP using a minimal two-speaker system that does not include a center speaker.

■ Compressed Music Enhancer

The Compressed Music Enhancer feature of this unit enhances your listening experience by regenerating the missing harmonics in a compression artifact. As a result, flattened complexity due to the loss of high-frequency fidelity as well as lack of bass due to the loss of low-frequency bass is compensated, providing improved performance of the overall sound system.

Information on HDMI™

■ HDMI signal compatibility

Audio signals

Audio signal types	Audio signal formats	Compatible media
2ch Linear PCM	2ch, 32-192 kHz, 16/20/24 bit	CD, DVD-Video, DVD-Audio, etc.
Multi-ch Linear PCM	8ch, 32-192 kHz, 16/20/24 bit	DVD-Audio, Blu-ray Disc, HD DVD, etc.
DSD	2/5.1ch, 2.8224 MHz, 1 bit	SA-CD, etc.
Bitstream	Dolby Digital, DTS	DVD-Video, etc.
Bitstream (High definition audio)	Dolby TrueHD, Dolby Digital Plus, DTS-HD Master Audio, DTS-HD High Resolution Audio, DTS Express	Blu-ray Disc, HD DVD, etc.



- If the input source component can decode the bitstream audio signals of audio commentaries, you can play back the audio sources with the audio commentaries mixed down by using the DIGITAL INPUT OPTICAL (or COAXIAL) connections.
- Refer to the supplied instruction manuals of the input source component, and set the component appropriately.

Notes

- When CPPM copy-protected DVD-Audio is played back, video and audio signals may not be output depending on the type of the DVD player.
- This unit is not compatible with HDCP-incompatible HDMI or DVI components.
- To decode audio bitstream signals on this unit, set the input source component appropriately so that the component outputs the bitstream audio signals directly (does not decode the bitstream signals on the component). Refer to the supplied instruction manuals for details.
- This unit is not compatible with the audio commentary features (for example, the special audio contents downloaded via Internet) of Blu-ray Disc or HD DVD. This unit does not play back the audio commentaries of the Blu-ray Disc or HD DVD contents.

Video signals

This unit is compatible with the video signals of the following resolutions:

- 480i/60 Hz
- 576i/50 Hz
- 480p/60 Hz
- 576p/50 Hz
- 720p/60 Hz, 50 Hz
- 1080i/60 Hz, 50 Hz
- 1080p/60 Hz, 50 Hz, 24 Hz

Specifications

AUDIO SECTION

- Minimum RMS Output Power for Front, Center, Surround, Surround back
[U.S.A. and Canada models]
1 kHz, 0.9% THD, 8 Ω 105 W
[Other models]
1 kHz, 0.9% THD, 6 Ω 105 W
- Dynamic Power (IHF)
[U.S.A. and Canada models]
Front Speakers 8/6/4/2 Ω 110/130/160/180 W
[Other models]
Front Speakers 6/4/2 Ω 100/130/150 W
- Maximum Useful Output Power (JEITA) [China, Korea, General and Asia models]
1 kHz, 10% THD, 6 Ω 140 W
- Maximum Output Power [U.K., Europe and Asia models]
1 kHz, 0.7% THD, 4 Ω 120 W
- Dynamic Headroom [U.S.A. and Canada models]
8 Ω 0.2 dB
- IEC Output Power [U.K., Europe and Asia models]
Front Speakers 1 kHz, 0.9% THD, 8 Ω 105 W
- Input Sensitivity/Input Impedance
AV5, etc. 200 mV/47 kΩ
- Maximum Input Voltage
AV5, etc. (1 kHz, 0.5% THD) 2.3 V or more
- Rated Output Voltage/Output Impedance
AUDIO OUT 200 mV/1.2 kΩ
PRE OUT 1.0 V/1.2 kΩ
SUBWOOFER (2ch Stereo & Front: Small)
..... 1.0 V/1.2 kΩ
- Headphone Jack Rated Output/Impedance
AV5, etc. (1 kHz, 50 mV, 8 Ω) 100 mV/470 Ω
- Frequency Response
AV5 to FRONT 10 Hz to 100 kHz, +0/-3 dB
- Total Harmonic Distortion
AV5, etc. to FRONT, Pure Direct
[U.S.A. and Canada models]
(1 kHz, 50 W, 8 Ω) 0.06% or less
[Other models]
(1 kHz, 50 W, 6 Ω) 0.06% or less
- Signal to Noise Ratio (IHF-A Network)
AV5, etc. Input Shorted (250 mV to Front Speakers)
..... 100 dB or more
- Residual Noise (IHF-A Network)
Front Speakers 150 μV or less
- Channel Separation (1 kHz/10 kHz)
AV5, etc. (5.1 kΩ shortened) 60 dB/45 dB or more
- Volume Control MUTE / -80 dB to +16.5 dB
- Tone Control (Front Speakers)
BASS Boost/Cut ±10 dB at 50 Hz
BASS Turnover Frequency 350 Hz
TREBLE Boost/Cut ±10 dB at 20 kHz
TREBLE Turnover Frequency 3.5 kHz
- Filter Characteristics (fc=40/60/80/90/100/110/120/160/200 Hz)
H.P.F. (Front, Center, Surround, Surround back: Small)
..... 12 dB/oct.
L.P.F. (Subwoofer) 24 dB/oct.

VIDEO SECTION

- Video Signal Type (Gray Back)
[U.S.A., Canada, Korea and General models] NTSC
[Other models] PAL
- Signal Level
Composite 1 V_{p-p}/75 Ω
Component 1 V_{p-p}/75 Ω (Y)
- Maximum Input Level (Video Conversion Off)
..... 1.5 V_{p-p} or more
- Signal to Noise Ratio 50 dB or more
- Frequency Response [MONITOR OUT]
Component (Video Conversion Off)
..... 5 Hz to 60 MHz, -3 dB

FM SECTION

- Tuning Range
[U.S.A. and Canada models] 87.5 to 107.9 MHz
[Asia and General models] 87.5/87.50 to 108.0/108.00 MHz
[Other models] 87.50 to 108.00 MHz
- 50 dB Quieting Sensitivity (IHF)
Mono 3.0 μV (20.8 dBf)
- Signal to Noise Ratio (IHF)
Mono/Stereo 74 dB/69 dB
- Harmonic Distortion (1 kHz)
Mono/Stereo 0.3/0.3%
- Antenna Input (unbalanced) 75 Ω

AM SECTION

- Tuning Range
[U.S.A. and Canada models] 530 to 1710 kHz
[Asia and General models] 530/531 to 1710/1611 kHz
[Other models] 531 to 1611 kHz

GENERAL

- Power Supply
[U.S.A. and Canada models] AC 120 V, 60 Hz
[General models] AC 110/120/220/230-240 V, 50/60 Hz
[China model] AC 220 V, 50 Hz
[Korea model] AC 220 V, 60 Hz
[Australia model] AC 240 V, 50 Hz
[U.K. and Europe models] AC 230 V, 50 Hz
[Asia models] AC 220/230-240 V, 50/60 Hz
- Power Consumption
[U.S.A. and Canada models] 270 W/320 VA
[Other models] 280 W
- Standby Power Consumption
Standby through off 0.2 W or less
Standby through on 3 W or less
- Dimensions (W x H x D) 435 x 151 x 364 mm
(17-1/8 x 6 x 14-3/8 in)
- Weight 8.4 kg (18.5 lbs)

* Specifications are subject to change without notice.

Index

■ Numerics

1 Dynamic Range, sound setup	41
1 HDMI, function setup	42
2 Display, function setup	42
2 Lipsync, sound setup	41
2ch Stereo, sound field program	25
3 Volume, function setup	42
4 Input Rename, function setup	43
5.1-channel speaker layout	10
6.1-channel speaker layout	10
7.1-channel speaker layout	10
7ch Enhancer, sound field program	26
7ch Stereo, sound field program	26

■ A

A)Config, speaker setup	39
Action Game, sound field program	25
Adjusting high frequency sound	22
Adjusting low frequency sound	22
Adptv DRC, 3 Volume, function setup	42
Advanced setup	45
Adventure, sound field program	24
AM antenna connection	17
AM tuning	28
AM, front panel	4
ANTENNA jack, rear panel	5
AUDIO 1/2, rear panel	5
Audio and video player connection	15
AUDIO jack	13
Audio jack	13
AUDIO L/R jack, front panel	4
AUDIO OUT, rear panel	5
Audio player connection	16
Audio, 1 HDMI, function setup	42
Auto Preset, OPTION menu	35
Auto Setup (YPAO), troubleshooting	51
Auto, 2 Lipsync, sound setup	42
Automatic setup	18
AV 1-6, rear panel	5
AV OUT, rear panel	5

■ B

B)Level, speaker setup	41
Basic operation, setup menu	39
Bass Out, A)Config, speaker setup	39
Bluetooth component playback	32
Bluetooth wireless audio receiver connection	16
Bluetooth, troubleshooting	51

■ C

C)Distance, speaker setup	41
C.Image, decoder parameter	37
Cellar Club, sound field program	25
Center speaker	10
Center width, decoder parameter	37
Center, A)Config, speaker setup	40
Center, C)Distance, speaker setup	41
Chamber, sound field program	25
CINEMA DSP indicator, front panel display	6
CINEMA DSP parameter	36
Clear Preset, OPTION menu	35
COAXIAL jack	13
CODE SET, remote control	7
COMPONENT VIDEO jack	13
Connect, OPTION menu	35
Connecting AM antenna	17
Connecting audio and video player	15
Connecting audio player	16
Connecting Bluetooth wireless audio receiver	16
Connecting FM antenna	17
Connecting iPod universal dock	16
Connecting power cable	17
Connecting projector	14

Connecting set-top box	15
Connecting speaker	11
Connecting speaker cable	12
Connecting the surround back speakers	11
Connecting TV monitor	14
Connection	10
Controlling other component, remote control	44
Crossover, A)Config, speaker setup	40
CT Level, sound field parameter	36
Cursor indicator, front panel display	6
Cursors $\Delta / \nabla / \triangleleft / \triangleright$, remote control	7

■ D

D)Equalizer, speaker setup	41
Decoder Mode, OPTION menu	34
Decoder parameter	37
Dimension, decoder parameter	37
Dimmer, 2 Display, function setup	42
DIRECT, front panel	4
Direct, sound field parameter	36
Disconnect, OPTION menu	35
DISPLAY, remote control	7
Displaying input signal information	23
DOCK terminal, rear panel	5
Drama, sound field program	25
DSP Level, sound field parameter	36
DSP Parameter, Setup menu	43

■ E

E)Test Tone, speaker setup	41
Editing sound field program	36
Editing surround decoder	36
EFCT LVL, sound field parameter	37
ENTER, remote control	7
EQ Select, D)Equalizer, speaker setup	41
EXTD Surround, OPTION menu	34
External component operation key, remote control	7

■ F

FL Scroll, 2 Display, function setup	42
FM antenna connection	17
FM Mode, OPTION menu	34
FM tuning	28
FM, front panel	4
Frequency tuning	28
Front L, C)Distance, speaker setup	41
Front left speaker	10
Front panel	4
Front panel display	6
Front panel display, front panel	4
Front R, C)Distance, speaker setup	41
Front right speaker	10
Front, A)Config, speaker setup	40
Function setup, setup menu	42

■ H

Hall in Munich, sound field program	25
Hall in Vienna, sound field program	25
HDMI Auto, 2 Lipsync, sound setup	41
HDMI indicator, front panel display	6
HDMI information	55
HDMI jack	13
HDMI OUT/HDMI 1-4, rear panel	5
HDMI THROUGH, front panel	4
HDMI, troubleshooting	49
Headphones using	22
Hi-fi sound playback	22
High frequency sound adjustment	22

■ I

INFO, front panel	4
INFO, remote control	7
INIT, advanced setup	45
Initialize setting, advanced setup	45

IniVol, 3 Volume, function setup	43
INPUT $\triangleleft / \triangleright$, front panel	4
Input selection key, remote control	7
Input signal information displaying	23
Input source registration	21
Installing batteries, remote control	9
iPod playback	30
iPod universal dock connection	16
iPod, troubleshooting	50

■ L

Low frequency sound adjustment	22
--------------------------------	----

■ M

Manual, 2 Lipsync, sound setup	42
MaxVol, 3 Volume, function setup	43
Memory guard, setup menu	43
MEMORY, front panel	4
MONITOR OUT, rear panel	5
Mono Movie, sound field program	25
Multi information display, front panel display	6
Music Video, sound field program	25
MUTE indicator, front panel display	6
MUTE, remote control	7

■ N

Numeric key, remote control	7
-----------------------------	---

■ O

OPTICAL jack	13
OPTIMIZER MIC jack, front panel	4
OPTION menu	33
OPTION, remote control	7

■ P

Pairing Bluetooth components	32
Pairing, OPTION menu	35
Panorama, decoder parameter	37
PHONES jack, front panel	4
Placing speaker	10
PORTABLE jack, front panel	4
Power cable connection	17
Power Cable, rear panel	5
POWER, remote control	7
PRE OUT, rear panel	5
PRESET $\triangleleft / \triangleright$, front panel	4
Preset tuning	28
PROGRAM $\triangleleft / \triangleright$, front panel	4
Projector connection	14

■ R

Registering input source	21
Registering sound field program	21
Remote control	7
Remote control code resetting	44
Remote control code setting	44
Remote control ID, advanced setup	45
Remote control signal transmitter, remote control	7
Remote control, controlling other component	44
Remote control, preparation	9
Remote control, troubleshooting	50
REMOTE ID, advanced setup	45
Repeat playback, iPod	31
Repeat, OPTION menu	35
Resetting remote control code	44
RETURN, remote control	7
Roleplaying Game, sound field program	25

■ S

SB Level, sound field parameter	36
SCENE function	21
SCENE, front panel	4

SCENE, remote control 7
 Sci-Fi, sound field program 24
 Selecting SCENE 21
 Setting remote control code 44
 Set-top box connection 15
 Setup menu 38
 Setup menu basic operation 39
 SETUP, remote control 7
 Shuffle playback, iPod 31
 Shuffle, OPTION menu 35
 Signal Info parameter 34
 Signal Info, OPTION menu 34
 SILENT CINEMA 27
 SL Level, sound field parameter 36
 SLEEP indicator, front panel display 6
 Sleep timer 22
 SLEEP, remote control 7
 Sound field parameter 36
 Sound field program editing 36
 Sound field program registration 21
 Sound selection key, remote control 7
 Sound setup, setup menu 41
 SOURCE POWER, remote control 7
 SP IMP, advanced setup 45
 Speaker cable connection 12
 Speaker connection 11
 Speaker impedance, advanced setup 45
 Speaker indicator, front panel display 6
 Speaker layout 10
 Speaker placement 10
 Speaker setup 39
 SPEAKERS terminal, rear panel 5
 Specifications 56
 Spectacle, sound field program 24
 Sports, sound field program 25
 SR Level, sound field parameter 36
 Standard, sound field program 24
 Standby, 1 HDMI, function setup 42
 STANDBY/ON, front panel 4
 Straight decoding mode 27
 Straight Enhancer, sound field program 26
 STRAIGHT, front panel 4
 Subwoofer 10
 Subwoofer Phase, A)Config,
 speaker setup 40
 Sur. B, A)Config, speaker setup 40
 Sur. L, C)Distance, speaker setup 41
 Sur. LR, A)Config, speaker setup 40
 Sur. R, C)Distance, speaker setup 41
 Sur.B L, C)Distance, speaker setup 41
 Sur.B R, C)Distance, speaker setup 41
 Surround back left speaker 10
 Surround back right speaker 10
 Surround back speaker 10
 Surround decoder editing 36
 Surround left speaker 10
 Surround right speaker 10
 SWFR, C)Distance, speaker setup 41

■ **T**

The Bottom Line, sound field program 25
 The Roxy Theatre, sound field program 25
 Tone control 22
 TONE CONTROL, front panel 4
 TRANSMIT, remote control 7
 Troubleshooting 46
 Tuner indicator, front panel display 6
 Tuner key, remote control 7
 Tuner, troubleshooting 49
 TUNING </>, front panel 4
 Tuning, AM 28
 Tuning, FM 28
 Turning off 17
 Turning on 17
 TV control key, remote control 7
 TV monitor connection 14

■ **U**

Using the remote control 9

■ **V**

VIDEO jack 13
 Video jack 13
 VIDEO jack, front panel 4
 Video/audio jack 13
 Virtual CINEMA DSP 27
 VOLUME +/-, remote control 7
 VOLUME control, front panel 4
 VOLUME indicator, front panel display 6
 Volume Trim, OPTION menu 33

■ **Y**

YPAO 18
 YPAO, troubleshooting 51

“(A) **STANDBY/ON**” or
 “[6] **POWER**” (example) indicates
 the name of the parts on the front
 panel or the remote control. Refer
 to “Part names and functions” on
 page 4.

List of remote control codes

TV		Ausind		Clatronic		Durabrand	
A.R. Systems	0274	Autovox	0249, 0257, 0259, 0260, 0328		0243, 0249, 0259, 0260, 0261, 0262, 0268, 0269, 0273, 0274, 0328	Dux	0077, 0097, 0133, 0225
Acme	0260	Aventura	0097			Dwin	0271
Acura	0261, 0273	Awa	0327, 0328	CMS	0327	Dynatron	0224
ADC	0259	Axion	0206	CMS Hightec	0328	Dynex	0268, 0271, 0274
Admiral	0100, 0224, 0257, 0258, 0259, 0264, 0265	Baird	0328	Coby	0151	Elbe	0181, 0182
Advent	0204	Bang & Olufsen	0230, 0257	Colortyme	0072, 0090		0243, 0250, 0274, 0328
Adventura	0107	Basic Line	0261, 0262, 0268, 0273, 0274, 0328	Commercial Solutions	0071	Elcit	0257
Adyson	0260, 0327, 0328	Bastide	0260, 0328	Concerto	0072, 0090	Electa	0270
Agashi	0327, 0328	Baur	0271, 0274	Concorde	0261, 0273	ELECTRO TECH	0261
Agazi	0259	Bazin	0328	Condor	0243, 0260, 0268, 0269, 0273, 0274, 0327	Electroband	0057, 0101
Aiko	0260, 0261, 0273, 0274, 0327, 0328	Beko	0243, 0269, 0274, 0282, 0351, 0357, 0372, 0380			Electrograph	0226
Aim	0274	Belcor	0090	Contec	0225, 0260, 0261, 0266, 0273, 0327	Electrohome	0072, 0090, 0101, 0102
Aiwa	0028, 0297	Bell & Howell	0065, 0100	Contec/Cony	0094, 0104	Element	0180
Akai	0063, 0096, 0101, 0205, 0231, 0261, 0262, 0268, 0271, 0273, 0274, 0327, 0328	Benq	0051, 0160, 0315	Continental Edison	0267	Elin	0260, 0268, 0271, 0273, 0274, 0327
Akiba	0262, 0274	Beon	0268, 0271, 0274			Elite	0262, 0268, 0274
Akura	0259, 0262, 0273, 0274	Best	0243	Cosmel	0261, 0273	Elman	0263
Alaron	0327	Bestar	0243, 0268, 0274	Craig	0104, 0225	Elta	0261, 0273, 0327
Alba	0243, 0260, 0261, 0262, 0266, 0269, 0271, 0273, 0274, 0294, 0300, 0327	Binatone	0260, 0328	Crosley	0088, 0119, 0249, 0257	Emerson	0065, 0072, 0077, 0082, 0085, 0090, 0094, 0095, 0097, 0104, 0105, 0119, 0225, 0243, 0257, 0274
Albatron	0222	Blue Sky	0262, 0274			Emprex	0200
Alcyon	0249	Blue Star	0270	Crown	0104, 0225, 0243, 0249, 0261, 0268, 0269, 0271, 0273, 0274	Envision	0072, 0090, 0096
Alleron	0105	Boots	0260, 0328			Epson	0156, 0201, 0309
Allorgan	0328	BPL	0270, 0274	CS Electronics	0260, 0262, 0327	Erres	0268, 0271, 0274
Allstar	0268, 0274	Bradford	0104, 0225	CTC Clatronic	0263	ESA	0097
America Action	0225	Brandt	0267, 0272	CTX	0159	ESC	0328
AMOi	0326	Brilliant	0228	Curtis Mathes	0065, 0071, 0072, 0085, 0088, 0090, 0096, 0099, 0224	Etron	0261
Amplivision	0243, 0260, 0275, 0328	Brinkmann	0274			Eurofeel	0328
Amstrad	0259, 0261, 0262, 0273, 0274	Briovvega	0257, 0268, 0271, 0274	CXC	0104, 0225	Euro-Feel	0259
Amtron	0104			Cybertron	0262	Euroline	0271
Anam	0225, 0261	Britannia	0260, 0327, 0328	Cytron	0202	Euroman	0243, 0327, 0328
Anam National	0102, 0104	Brockwood	0090	Daewoo	0072, 0085, 0090, 0103, 0119, 0245, 0260, 0261, 0268, 0273, 0274, 0281, 0285, 0303, 0321, 0327, 0328, 0344, 0361, 0387	Euromann	0259, 0260, 0268, 0274
Anglo	0261, 0273	Broksonic	0063, 0225			Europhon	0260, 0263, 0268, 0274, 0327, 0328
Anitech	0249, 0259, 0261, 0273, 0274	Bruns	0257	Dainichi	0262, 0327	Expert	0275
Ansonic	0243, 0250, 0261, 0263, 0273, 0274	BTC	0262	Dansai	0259, 0268, 0271, 0274, 0327, 0328	Exquisit	0274
AOC	0072, 0090, 0096, 0103	Bush	0261, 0262, 0264, 0266, 0268, 0270, 0271, 0273, 0274, 0282, 0286, 0294, 0300, 0328, 0329, 0351, 0388, 0394, 0413	Daytron	0243, 0271	Fenner	0261, 0273
Apex	0061, 0117, 0139	Capsonic	0259	De Graaf	0264	Ferguson	0267, 0271, 0272
Arcam	0327, 0328	Carena	0274	Decca	0072, 0085, 0090, 0261, 0273	Fidelity	0260, 0264, 0274, 0327
Arcam Delta	0260	Carnivale	0096	Dell	0260, 0268, 0271, 0274, 0328	Filsai	0328
Aristona	0268, 0271, 0274	Carrefour	0266	Denver	0167, 0195	Finlandia	0264
Arthur Martin	0275	Carver	0088	Desmet	0308, 0312	Finlux	0249, 0257, 0260, 0263, 0268, 0271, 0274, 0328
ASA	0257, 0265	Cascade	0261, 0273, 0274	Diamant	0268, 0271, 0274	FIRST LINE	0260, 0261, 0268
Asberg	0249, 0268, 0274	Casio	0317	Diamond	0274	Firstline	0273, 0274, 0327, 0328
Astra	0261	Cathay	0268, 0271, 0274	DiamondVision	0213, 0221	Fisher	0065, 0243, 0257, 0260, 0266, 0269, 0328
Asuka	0259, 0260, 0262, 0327, 0328	CCE	0229, 0328	Dimensia	0099	Flint	0268, 0274
Atlantic	0260, 0268, 0271, 0274, 0327	Celebrity	0057, 0101	Disney	0137	Formenti	0249, 0257, 0258, 0260, 0271, 0327
Atori	0261, 0273	Celera	0117	Dixi	0261, 0268, 0271, 0273, 0274, 0328	Formenti/Phoenix	0327
Auchan	0275	Centurion	0268, 0271, 0274	Dream Vision	0415, 0416	Fortress	0257, 0258
Audiosonic	0243, 0260, 0261, 0262, 0268, 0271, 0274, 0328	Century	0257	DTS	0261, 0273	Fraba	0243, 0274
AudioTon	0243, 0260, 0328	CGE	0243, 0249	Dual	0260, 0274, 0328	Friac	0243
Audiovox	0104, 0144, 0225	Changhong	0117	Dual-Tec	0260, 0261	Frontech	0259, 0261, 0264, 0265, 0273, 0328
		Chimei	0323	Dumont	0076, 0090, 0108, 0257, 0260, 0263, 0328	Fujitsu	0023, 0024, 0025, 0105, 0328
		Chimline	0261, 0273			Fujitsu General	0328
		Citizen	0072, 0085, 0090, 0096, 0104				
		City	0261, 0273				
		Clarion	0225				
		Clarivox	0271				

Fujitsu Siemens	0425, 0426, 0427, 0428, 0429	Hinari	0261, 0262, 0266, 0268, 0271, 0273, 0274	Kaisui	0260, 0261, 0262, 0270, 0273, 0274, 0327, 0328	Magnavox	0072, 0088, 0090, 0091, 0095, 0096, 0098, 0114, 0115, 0129, 0134, 0176, 0178, 0189, 0210
Funai	0033, 0034, 0035, 0036, 0037, 0097, 0104, 0105, 0225, 0259	Hisawa	0262, 0270, 0275	Kamosonic	0260		0259, 0261
Futuretech	0104, 0225	Hisense	0006, 0014, 0015, 0016, 0042, 0072, 0090, 0094, 0173, 0254, 0255, 0256, 0260, 0264, 0265, 0266, 0274, 0285, 0300, 0319, 0328, 0348, 0349, 0385, 0402, 0410	Kamp	0260, 0327	Magnum	0100
Galaxi	0269, 0274	Hitachi	0006, 0014, 0015, 0016, 0042, 0072, 0090, 0094, 0173, 0254, 0255, 0256, 0260, 0264, 0265, 0266, 0274, 0285, 0300, 0319, 0328, 0348, 0349, 0385, 0402, 0410	Kapsch	0265	Majestic	0259
Galaxis	0243, 0274			Karcher	0243, 0260, 0261, 0271, 0274	Mandor	0259, 0260, 0268, 0271, 0274, 0328
Gateway	0163, 0226, 0227			Kawasho	0072, 0090, 0101, 0327	Manesth	0271, 0274, 0328
GBC	0261, 0266, 0273			KEC	0225	Marantz	0072, 0088, 0090, 0096, 0158, 0268, 0271, 0274
GE	0069, 0071, 0072, 0073, 0077, 0090, 0099, 0102, 0106, 0112, 0131	Hornyphon	0268, 0274	Kendo	0243, 0263, 0264, 0274		
Geant Casino	0275	Hoshai	0262	Kenwood	0072, 0090, 0096	Marelli	0257
GEC	0260, 0265, 0268, 0271, 0274, 0328	Huanyu	0260, 0327	KIC	0328	Mark	0268, 0271, 0273, 0274, 0327, 0328
Geloso	0261, 0264, 0273	Hygashi	0260, 0327, 0328	Kingsley	0260, 0327		
General Technic	0261, 0273	Hyper	0260, 0261, 0273, 0327, 0328	KLH	0117	Masuda	0328
Genexxa	0262, 0265, 0268, 0274	Hypson	0259, 0260, 0268, 0270, 0271, 0274, 0275, 0328	Kloss Novabeam	0104, 0107	Matsui	0260, 0261, 0264, 0266, 0268, 0271, 0273, 0274, 0328, 0405
GFM	0177, 0210			Kneissel	0243, 0250, 0274		
Giant	0328	Hyundai	0223	Kolster	0268, 0274	Matsushita	0067
Gibraltar	0076, 0090, 0096, 0108	Iberia	0274	Konka	0262	Maxent	0193, 0226
GoldHand	0327	ICE	0259, 0260, 0261, 0262, 0268, 0273, 0274, 0327, 0328	Korting	0274	Mediator	0268, 0271, 0274
Goldline	0274			Kosmos	0261	Medion	0259, 0261, 0274
GoldStar	0072, 0077, 0085, 0090, 0094, 0096, 0103, 0243, 0260, 0261, 0264, 0268, 0271, 0273, 0274, 0327, 0328	ICeS	0327	Koyoda	0261	Megapower	0222
		Ilo	0198, 0203	KTV	0085, 0096, 0104, 0225, 0229, 0260, 0328	Megatron	0072, 0077
		IMA	0104			MElectronic	0273, 0274, 0327, 0328
		Imperial	0243, 0249, 0265, 0268, 0269, 0274	Kyoto	0327, 0328		
		Indiana	0268, 0271, 0274	Lasat	0243	Melvox	0275
		Infinity	0088	Lenco	0261, 0273	Memorex	0065, 0072, 0077, 0100, 0103, 0133, 0219, 0261, 0273
		InFocus	0168, 0277, 0313, 0397, 0430	Lenoir	0260, 0261, 0273		
		Ingelen	0265	Leyco	0259, 0268, 0271, 0274	Memphis	0261, 0273
		Ingersol	0261, 0273	LG	0016, 0038, 0039, 0077, 0103, 0145, 0222, 0243, 0246, 0253, 0260, 0261, 0264, 0268, 0271, 0273, 0274, 0282, 0290, 0299, 0316, 0327, 0328, 0351, 0359, 0367, 0382, 0384, 0389, 0396	Mercury	0273, 0274
		Initial	0203			Metz	0257
		Inno Hit	0249, 0260, 0261, 0262, 0268, 0271, 0273, 0274, 0328	LG/GoldStar	0246	MGA	0072, 0077, 0090, 0096, 0103
		Innovation	0259, 0261	Liesenk	0271	Micromaxx	0259, 0261
		Insignia	0182, 0188, 0190, 0209	Liesenkotter	0274	Microstar	0259, 0261
		Inteq	0076	Life	0259, 0261	Midland	0069, 0071, 0073, 0076, 0085, 0106, 0108
		Interactive	0243	Lifetec	0259, 0261, 0273, 0274		
		Interbuy	0261, 0273			Minerva	0249
		Interfunk	0243, 0257, 0265, 0268, 0271, 0274	Lloyds	0273	Minoka	0268, 0274
		International	0327	Loewe	0243, 0250, 0274, 0280, 0306, 0347	Mintek	0203
		Intervision	0243, 0259, 0260, 0263, 0274, 0328	Loewe Opta	0257, 0268, 0271	Mitsubishi	0006, 0015, 0016, 0048, 0072, 0077, 0090, 0103, 0196, 0224, 0257, 0266, 0268, 0274, 0298, 0371
		Irradio	0249, 0261, 0262, 0268, 0271, 0273, 0274	Logik	0100	Mivar	0243, 0249, 0250, 0260, 0327, 0328
				Luma	0264, 0271, 0273, 0274	Monivision	0222
		Isukai	0262, 0274	Lumatron	0264, 0268, 0271, 0274, 0328	Montgomery Ward	0100
		ITC	0260, 0328			Motion	0249
		ITS	0262, 0268, 0270, 0274, 0327	Lux May	0268	Motorola	0102, 0224
		ITT	0261, 0265	Luxman	0072, 0090	MTC	0072, 0090, 0096, 0103, 0243, 0327
		ITV	0261, 0271, 0274	Luxor	0260, 0264, 0328	Multi System	0271
		Janeil	0107	LXI	0061, 0065, 0071, 0072, 0073, 0077, 0088, 0099	Multitech	0104, 0225, 0229, 0243, 0260, 0261, 0263, 0264, 0266, 0271, 0273, 0274, 0327, 0328
		JBL	0088				
		JC Penney	0072, 0073, 0085, 0090, 0099, 0103, 0106	M Electronic	0260, 0261, 0265, 0267, 0268, 0271	Murphy	0260, 0327
		JCB	0057, 0101	MAG	0050	NAD	0061, 0072, 0077
		Jensen	0072, 0090	Magnadyne	0257, 0263, 0271	Naonis	0264
		JVC	0017, 0018, 0019, 0092, 0093, 0094, 0106, 0251, 0252, 0266, 0268, 0293, 0360, 0379	Magnafon	0249, 0260, 0263, 0327	NEC	0026, 0053, 0072, 0090, 0096, 0102, 0103, 0266, 0328
Hema	0273, 0328						
Hewlett Packard	0146						
Higashi	0327						
HiLine	0274						

Neckermann	0243, 0257, 0260, 0264, 0268, 0269, 0271, 0274, 0328		0114, 0135, 0143, 0176, 0178, 0189, 0210, 0212, 0232, 0233, 0257, 0260, 0268, 0271, 0274, 0278, 0287, 0301, 0302, 0307, 0311, 0314, 0330, 0331, 0333, 0337, 0338, 0339, 0341, 0343, 0345, 0355, 0363, 0365, 0377, 0378, 0381, 0383, 0406, 0409, 0414	RCA	0071, 0072, 0073, 0074, 0075, 0090, 0099, 0102, 0103, 0109, 0120, 0179, 0218	SEI-Sinudyne	0257, 0263, 0265 0264, 0265, 0266 0261, 0273 0273 0327	
NEI	0268, 0271, 0274			Realistic	0065, 0077, 0096, 0225	Sharp	0009, 0010, 0011, 0072, 0080, 0081, 0082, 0083, 0085, 0090, 0094, 0110, 0148, 0183, 0216, 0224, 0247, 0248, 0258, 0266, 0288, 0304, 0324, 0325, 0340, 0358, 0362, 0369, 0386, 0392, 0398, 0400, 0401, 0403	
Net-TV	0226			Recor	0274			
Neufunk	0273, 0274			Redstar	0274			
New Tech	0261, 0268			Reflex	0274			
New World	0262			Revox	0243, 0268, 0271, 0274			
NewTech	0273, 0274, 0328			Rex	0259, 0264, 0265			
Nicamagic	0260, 0327			RFT	0243, 0250, 0257			
Nikkai	0259, 0260, 0262, 0268, 0271, 0273, 0274, 0327, 0328			Rhapsody	0327			
Nikko	0072, 0077, 0096			R-Line	0268, 0271, 0274			
Noblisko	0249, 0260, 0263, 0327	Philips Magnavox Phoenix	0089, 0114, 0115 0243, 0257, 0268, 0271, 0274, 0327	Roadstar	0259, 0261, 0262, 0273	Sheng Chia	0224	
Nokia	0265	Phonola	0257, 0268, 0271, 0274, 0327	Robotron	0257	Shogun	0090	
Norcent	0155			Rowa	0327, 0328	Siarem	0257, 0263, 0274	
Nordic	0328			Royal Lux	0243	Sierra	0268, 0274	
Nordmende	0257, 0265, 0267, 0268	Pilot	0085, 0090, 0096	RTF	0257	Siesta	0243	
Nordvision	0271	Pioneer	0012, 0013, 0072, 0090, 0243, 0265, 0267, 0268, 0271, 0274, 0408	Runco	0076, 0096, 0108	Signature	0100	
Novatron	0274			Saba	0257, 0265, 0267, 0272, 0376	Silva	0327	
Oceanic	0265, 0275			Saisho	0259, 0260, 0261, 0273, 0328	Silver	0266	
Okano	0243, 0269, 0274	Plantron	0259, 0268, 0273, 0274			Singer	0257, 0263, 0275	
Olevia	0052, 0140, 0149, 0154, 0157					Sinudyne	0257, 0263, 0271, 0274	
ONCEAS	0260	Playsonic	0328	Salora	0264, 0265	Skantic	0265	
Onwa	0104, 0225	Polaroid	0117, 0152, 0184, 0220	Sambers	0249, 0263	Solavox	0265	
Opera	0274			Sampo	0072, 0085, 0090, 0096, 0226	Sonitron	0243, 0328	
Oppo	0208	Poppy	0261, 0273	Samsung	0029, 0030, 0031, 0032, 0044, 0045, 0046, 0047, 0072, 0077, 0084, 0085, 0086, 0087, 0090, 0094, 0096, 0103, 0118, 0217, 0229, 0235, 0236, 0237, 0243, 0259, 0260, 0261, 0268, 0269, 0271, 0273, 0274, 0284, 0295, 0327, 0328, 0336, 0346, 0390, 0407		Sonolor	0265, 0275
Optimus	0065, 0067	Portland	0072, 0085, 0090, 0103			Sontec	0243, 0268, 0271, 0274	
Optoma	0194	Prandoni-Prince	0249, 0264			Sony	0041, 0057, 0058, 0059, 0060, 0101, 0116, 0125, 0126, 0127, 0142, 0169, 0170, 0171, 0172, 0174, 0234, 0261, 0266, 0276, 0289, 0292, 0393, 0411 0262, 0263	
Optonica	0224	Precision	0260, 0328			Sound & Vision	0072, 0077, 0090, 0104, 0105, 0225	
Orbit	0268, 0274	Prima	0161, 0207, 0261, 0265, 0273			Soundwave	0268, 0271, 0274 0097	
Orion	0121, 0192, 0261, 0268, 0271, 0273, 0274, 0282, 0329	Princeton	0222			Squareview	0090, 0104, 0225	
Orline	0274	Prism	0069, 0106			SSS	0260, 0261, 0262, 0268, 0273, 0274, 0328	
Osaki	0259, 0260, 0262, 0274, 0328	Profex	0261, 0273			Starlite	0104, 0225, 0271, 0273, 0274	
Oso	0262	Profi-Tronic	0268, 0274			Stenway	0270	
Otto Versand	0258, 0260, 0266, 0268, 0270, 0271, 0274, 0328	Proline	0268, 0274			Stern	0264, 0265	
		Proscan	0071, 0073, 0099			Strato	0273, 0274	
		Prosonic	0243, 0260, 0271, 0274, 0327, 0328			Stylandia	0328	
		Protech	0259, 0260, 0261, 0263, 0268, 0271, 0328	Sandra	0260, 0327, 0328	Sunkai	0261	
Pael	0260, 0327			Sansui	0063, 0121, 0268, 0274	Sunstar	0273, 0274	
Palladium	0243, 0260, 0269, 0274, 0328	Proton	0072, 0077, 0090, 0094	Sanyo	0020, 0021, 0022, 0049, 0065, 0090, 0141, 0191, 0243, 0250, 0260, 0266, 0273, 0291, 0327, 0328, 0370, 0373, 0391	Sunwood	0261, 0268, 0273, 0274	
Palsonic	0328							
Panama	0259, 0260, 0261, 0273, 0274, 0327, 0328	Protron	0150					
Panasonic	0006, 0007, 0066, 0067, 0068, 0069, 0070, 0102, 0106, 0113, 0147, 0215, 0241, 0265, 0274, 0279, 0310, 0332, 0334, 0368, 0374	PROVIEW	0050, 0164					
		Provision	0271, 0274					
		Pulsar	0076, 0090, 0108					
		Pye	0268, 0271, 0274, 0296, 0338					
		Pymi	0261, 0273	SBR	0271, 0274			
		Quandra Vision	0275	Sceptre	0166, 0185			
		Quasar	0067, 0069, 0102, 0106	Schaub Lorenz	0265			
Panavision	0274	Quelle	0259, 0260, 0268, 0271, 0274, 0328	Schneider	0260, 0262, 0268, 0271, 0274, 0287, 0300, 0328, 0364, 0366			
Pathe Cinema	0243, 0250, 0260, 0275, 0327	Questa	0266					
Pausa	0261, 0273	Radialva	0274	Scotch	0072, 0077			
Penney	0061, 0069, 0071, 0077, 0096	RadioShack	0065, 0071, 0077, 0096, 0225, 0274	Scott	0072, 0077, 0090, 0094, 0104, 0105, 0199, 0225			
Perdio	0274, 0327							
Perfekt	0274	RadioShack/Realistic	0072, 0085, 0090, 0094, 0099, 0104	Sears	0061, 0065, 0071, 0072, 0073, 0077, 0088, 0090, 0097, 0099, 0105	Superla	0260, 0327, 0328	
Philco	0072, 0088, 0090, 0091, 0094, 0096, 0102, 0103, 0243, 0249, 0257, 0274	Radiola	0268, 0271, 0274, 0328			Superscan	0095, 0224	
		Radiomarelli	0257, 0274			SuperTech	0273, 0274, 0327	
Philharmonic	0260, 0328	Radiotone	0243, 0268, 0273, 0274	SEG	0259, 0260, 0263, 0266, 0271, 0273, 0274, 0300, 0327, 0328	Supra	0261, 0273	
Philips	0040, 0088, 0089, 0090, 0091, 0094, 0098, 0099, 0102,	Rank	0266			Supre-Macy	0107	
						Supreme	0057, 0101	
						Susumu	0262	
						Sutron	0261, 0273	
						SVA	0197	
						Sydney	0260, 0327, 0328	
				SEI	0274			

Sylvania	0072, 0088, 0089, 0090, 0091, 0095, 0096, 0097, 0098, 0175, 0177, 0210	Triumph	0274	Adventura	1023	Dumont	1072, 1078
		Uher	0243, 0249, 0265, 0268, 0274	Adyson	1090	Durabrand	1032
		Ultravox	0257, 0260, 0263, 0274, 0327	Aiwa	1023, 1072, 1073, 1074	Dynatech	1023
Symphonic	0097, 0104, 0108, 0133, 0210, 0225	United	0274	Akai	1071, 1073	Echostar	1064
Syntax	0149	Unic Line	0274	Akiba	1079, 1090	Elbe	1091
Syntax-Brilliant	0149	United	0271	Akura	1073, 1079, 1090	Elcatech	1090
Sysline	0271	Universum	0243, 0249, 0259, 0268, 0269, 0271, 0274, 0328	Alba	1074, 1075, 1076, 1079, 1090, 1091	Electrohome	1021
Sytong	0327			Alienware	1066	Electrohome	1021
Tandy	0224, 0258, 0260, 0262, 0265, 0328	Univox	0274	Ambassador	1076	Elsay	1090
		Vector Research	0096	American High	1022	Elta	1079, 1090, 1091
Tashiko	0260, 0264, 0266, 0327, 0328	Vestel	0264, 0265, 0268, 0269, 0271, 0274, 0328	Amstrad	1072, 1090, 1091	Emerson	1021, 1022, 1023, 1070, 1090
Tatung	0102, 0227, 0260, 0268, 0271, 0274, 0328	Vexa	0261, 0271, 0273, 0274	Anitech	1079, 1090	ESC	1075, 1091
TCM	0259, 0261	Victor	0093, 0266, 0268	Apex	1010	Etzuko	1079, 1090
Teac	0274, 0328	VIDEOLÓGIC	0327	ASA	1077, 1078	Expressvu	1064
Tec	0260, 0261, 0273, 0328	Videologique	0260, 0262, 0327, 0328	Asa	1020	Ferguson	1073
Technics	0067, 0069, 0106	VideoSystem	0268, 0274	Asuka	1072, 1077, 1078, 1079, 1090	Fidelity	1072, 1090
TechniSat	0320, 0417, 0418, 0419	Videotechnic	0327, 0328	Audio Dynamics	1018	Finlandia	1078
		Vidikron	0088	Audiosonic	1091	Finlux	1072, 1073, 1078
Techwood	0069, 0072, 0090, 0106	Vidtech	0072, 0077, 0090, 0103	Audiovox	1021	Firstline	1074, 1077, 1079, 1090
TEDELEX	0328	Viewsonic	0153, 0186, 0226, 0318	Baird	1072, 1073, 1075, 1091	Fisher	1019
Teknika	0072, 0085, 0088, 0090, 0094, 0100, 0103, 0104, 0105, 0225	Viking	0107	Bang & Olufsen	1067	Flint	1074
Televia	0267	Viore	0198	Basic Line	1074, 1075, 1076, 1079, 1090, 1091	Formenti/Phoenix	1078
Telecor	0274, 0328	Visiola	0260, 0327	Baur	1078	Frontech	1076
Telefunken	0267, 0268, 0272, 0274	Vision	0268, 0274, 0328	Beaumarck	1020	Fuji	1022
		Vizio	0090, 0136, 0160, 0227, 0420, 0421, 0422, 0423, 0424	Bell & Howell	1019	Fujitsu	1072
Telegazi	0274	Vortec	0268, 0271, 0274	Bestar	1075, 1076, 1091	Funai	1023, 1072
Telemeister	0274	Voxson	0249, 0257, 0264, 0265, 0268, 0274	Black Panther Line	1075, 1091	Galaxy	1072
Telesonic	0274			Blaupunkt	1078	Garrard	1023
Telestar	0274	Waltham	0260, 0274, 0328	Bondstec	1076, 1090	Gateway	1066
Teletech	0261, 0271, 0273, 0274	Wards	0072, 0077, 0088, 0090, 0091, 0096, 0098, 0099, 0100, 0103, 0105	Broksonic	1054	GBC	1076, 1079
Teleton	0260, 0328			Bush	1074, 1075, 1079, 1090, 1091, 1097, 1099, 1109, 1139	GE	1020, 1022
Televideon	0327	Watson	0268, 0271, 0274	Bush	1074, 1075, 1079, 1090, 1091, 1097, 1099, 1109, 1139	GEC	1078
Televiso	0275	Watt Radio	0260, 0263, 0327	Calix	1021	Geloso	1079
Tensai	0261, 0262, 0268, 0273, 0274, 0328	Waycon	0061	Candle	1020, 1021	General	1076
		Wega	0257, 0266, 0274	Canon	1022	General Technic	1074
Tesmet	0268	Wegavox	0273	Cathay	1091	GOI	1064
Tevion	0259, 0261	Weltblick	0268, 0271, 0274, 0328	Catron	1076	GoldHand	1079, 1090
Textet	0260, 0273, 0327, 0328	Westinghouse	0057, 0138, 0142	CGE	1072, 1073	Goldstar	1018, 1021, 1072, 1077
Thomson	0238, 0239, 0240, 0260, 0267, 0268, 0272, 0274, 0335	White Westinghouse	0008, 0119, 0260, 0263, 0271, 0274, 0327	Cimline	1074, 1079, 1090	Goodmans	1072, 1075, 1076, 1077, 1079, 1090, 1091
				CineVision	1058	Gradiente	1023
Thorn	0072, 0077, 0090	Wincom	0055, 0056	Citizen	1020, 1021	Graetz	1073
TMK	0076	Xrypton	0274	Clatronic	1076, 1090	Granada	1078
TNCi	0268, 0274, 0328	Yamaha	0000, 0001, 0002, 0003, 0004, 0005, 0103	Colortyme	1018	Grandin	1072, 1075, 1076, 1077, 1079, 1090, 1091
Tokai	0260, 0327			Condor	1075, 1076, 1091	Grundig	1078, 1079
Tokyo	0270			Craig	1020, 1021	Hanseatic	1077, 1078, 1091
Tomashi	0027, 0043, 0053, 0054, 0061, 0062, 0063, 0064, 0065, 0122, 0123, 0124, 0128, 0130, 0132, 0139, 0214, 0244, 0266, 0283, 0305, 0328, 0329, 0342, 0350, 0352, 0353, 0354, 0375, 0404	Yamishi	0274, 0328	Crown	1075, 1076, 1079, 1090, 1091	Harley Davidson	1023
Toshiba	0027, 0043, 0053, 0054, 0061, 0062, 0063, 0064, 0065, 0122, 0123, 0124, 0128, 0130, 0132, 0139, 0214, 0244, 0266, 0283, 0305, 0328, 0329, 0342, 0350, 0352, 0353, 0354, 0375, 0404	Yokan	0274	Curtis Mathes	1018, 1020, 1022	Harman/Kardon	1018
		Yoko	0243, 0259, 0260, 0261, 0262, 0268, 0271, 0273, 0274, 0327, 0328	Cybernex	1020	Harwood	1090
				CyberPower	1066	HCM	1079, 1090
Totevision	0085	Yorx	0262	Daewoo	1023, 1075, 1076, 1091, 1116, 1141	Headquarter	1019
Towada	0265, 0328	Zanussi	0264, 0328	Dansai	1079, 1090, 1091	Hewlett Packard	1066
Trakton	0328	Zenith	0076, 0077, 0078, 0079, 0090, 0100, 0108, 0111	Dantax	1074	Hinari	1074, 1079, 1090, 1091
Trans Continens	0274, 0328			Daytron	1075, 1091	Hisawa	1074
Transtec	0327			DBX	1018	Hitachi	1072, 1073, 1078, 1089, 1108, 1124
Trident	0328			De Graaf	1078	HNS	1060
				Decca	1072, 1073, 1078	Howard Computers	1066
				Dell	1066		1066
				Denko	1090	HP	1066
				DiamondVision	1050	HTS	1064
				DigiFusion	1092	Hughes	1035, 1040, 1061
				DIRECTV	1035, 1038, 1040, 1059, 1060, 1061, 1065	Hughes Network Systems	1038, 1060
				Dish Network	1064	Humax	1035, 1060, 1094
				Dishpro	1064	Hush	1066
				Dual	1073, 1078, 1091	Hypson	1074, 1079, 1090, 1091

VCR

ABS 1066

iBUYPOWER	1066	Multitech	1020, 1023, 1072,	Ricavision	1066	Telefunken	1073
Impego	1076		1076, 1078, 1079,	Roadstar	1075, 1077, 1079,	Teletech	1090, 1091
Imperial	1072		1090		1090, 1091	Tenosal	1079, 1090
Inno Hit	1075, 1076, 1078,	Murphy	1072	Royal	1090	Tensai	1072, 1077, 1079,
	1079, 1090, 1091	NEC	1018, 1019, 1073	Runco	1032		1090
Innovation	1074	Neckermann	1073, 1078	Saba	1073	Tevion	1074
Instant Replay	1022	NEI	1078	Saisho	1074, 1079	Thomson	1073, 1087
Interbuy	1077, 1090	Nesco	1079, 1090	Samsung	1006, 1020, 1038,	Thorn	1073
Interfunk	1078	Nikkai	1076, 1090, 1091		1040, 1046, 1060,	Tivo	1035, 1036, 1037,
Intervision	1072, 1091	Nikko	1021		1080, 1107, 1110,		1039, 1040, 1060,
Irradio	1077, 1079, 1090	Niveus Media	1066		1112, 1121, 1123,		1061, 1062
ITT	1073	Noblex	1020		1140, 1142	TMK	1020
ITV	1075, 1077, 1091	Nokia	1073, 1091	Samurai	1076, 1090	Tokai	1077, 1079, 1090
JC Penney	1018, 1019, 1020,	Nordmende	1073	Sanky	1032	Tonsai	1079
	1021, 1022	Northgate	1066	Sansui	1033, 1056, 1069,	Toshiba	1004, 1005, 1034,
JCL	1022	Oceanic	1072, 1073		1073		1051, 1063, 1066,
JVC	1011, 1012, 1013,	Okano	1074, 1090, 1091	Sanyo	1019, 1020, 1114		1073, 1078, 1086,
	1014, 1015, 1016,	Olympus	1022	Saville	1091		1099, 1102, 1119,
	1017, 1018, 1019,	Optimus	1021	SBR	1078		1144
	1028, 1035, 1064,	Orion	1033, 1069, 1074,	Schaub Lorenz	1072, 1073	Totevision	1020, 1021
	1073, 1085, 1117,		1097, 1139	Schneider	1072, 1074, 1075,	Touch	1066
	1130, 1131, 1133,	Orson	1072		1076, 1077, 1078,	Towada	1079, 1090
	1134, 1135, 1136	Osaki	1072, 1077, 1079,		1079, 1090, 1091	Towika	1079, 1090
Kaisui	1079, 1090		1090	Sears	1019, 1021, 1022	TVA	1076
Karcher	1078	Otto Versand	1078	SEG	1079, 1090, 1091	Uher	1077
Kendo	1074, 1075, 1076,	Palladium	1073, 1077, 1079,	SEI-Sinudyne	1078	UltimateTV	1065
	1090		1090	Seleco	1073	Ultravox	1091
Kenwood	1018, 1019, 1073	Panasonic	1007, 1008, 1009,	Sentra	1076, 1090	Unitech	1020
Kodak	1021, 1022		1022, 1026, 1042,	Sentron	1079, 1090	United Quick Star	1075, 1091
Korpel	1079, 1090		1043, 1068, 1082,	Sharp	1031, 1045, 1057,	Universum	1072, 1077, 1078
Kyoto	1090		1101, 1126, 1132		1081, 1115, 1137	Vector Research	1018
Lenco	1075	Pathe Marconi	1073	Shintom	1079, 1090	Video Concepts	1018
Leyco	1079, 1090	Perdio	1072	Shivaki	1077	Videon	1074
LG	1021, 1053, 1072,	Philco	1022, 1090	Shogun	1020	Videosonic	1020
	1077, 1088, 1100,	Philips	1022, 1030, 1035,	Siemens	1077	Viewsonic	1066
	1106, 1125, 1143		1038, 1039, 1040,	Silva	1077	Voodoo	1066
Lifetec	1074		1044, 1055, 1060,	Silver	1091	Wards	1020, 1021, 1022,
Linksys	1066		1078, 1084, 1095,	Singer	1022		1023
Lloyd's	1023		1096, 1104, 1105,	Sinudyne	1078	Weltblick	1077
Loewe Opta	1077, 1078		1111, 1113, 1122,	Solavox	1076	XR-1000	1022, 1023
Logik	1079, 1090		1124, 1127, 1128,	Sonic Blue	1041, 1068	Yamaha	1018, 1019
Lumatron	1075, 1091		1129	Sonneclair	1090	Yamishi	1079, 1090
Luxor	1090	Philips Magnavox	1030	Sonoko	1075, 1091	Yokan	1079, 1090
LXI	1021	Phonola	1078	Sontec	1077	Yoko	1076, 1077, 1079,
M Electronic	1072	Pilot	1021	Sony	1000, 1001, 1002,		1090
Magnavox	1022, 1032, 1044,	Pioneer	1078, 1118		1003, 1024, 1027,	Zenith	1032
	1070	Polaroid	1010, 1049		1036, 1062, 1066,	ZT Group	1066
Magnin	1021	Portland	1075, 1076, 1091		1083, 1098, 1103,		
Manesth	1079, 1090	Prinz	1072		1138	DVD	
Marantz	1018, 1019, 1022,	Profex	1079	Stack	1066	4Kus	2097
	1078	Proline	1072	Stack 9	1066	Accurian	2220
Mark	1091	Proscan	1065	Standard	1075, 1091	Advent	2169, 2201
Marta	1021	Prosonic	1074, 1091	Stern	1091	AEG	2312
Matsui	1074, 1077	Pulsar	1032	STS	1022	Airis	2318
Matsushita	1022	Pye	1052, 1078	Sunkai	1074	Aiwa	2272
Media Center PC	1066	Quarter	1019	Sunstar	1072	Akai	2170, 2195, 2225,
Mediator	1078	Quartz	1019	Suntronic	1072		2227
Medion	1074	Quasar	1022	Sunwood	1079, 1090	Akura	2310
MEI	1022	Quelle	1072, 1078	Superscan	1070	Alba	2018, 2232, 2247,
Memorex	1019, 1020, 1021,	Radialva	1090	Sylvania	1022, 1023, 1044,		2259, 2264
	1022, 1023, 1032,	RadioShack	1021		1052, 1070	Alco	2199
	1048, 1069, 1072,	RadioShack/Realistic		Symphonic	1023, 1044, 1090	Alize	2315
	1077		1019, 1020, 1021,	Systemax	1066	Allegro	2215
Memphis	1079, 1090		1022, 1023	Tagar Systems	1066	Amitech	2312
MGN Technology	1020	Radiola	1078	Taisho	1074	Amphion MediaWorks	
Micromaxx	1074	Radix	1021	Tandberg	1091		2145
Microsoft	1066	Randex	1021	Tandy	1019	AMW	2145, 2313
Microstar	1074	RCA	1020, 1022, 1025,	Tashiko	1021, 1072	Apex	2044, 2045, 2046,
Migros	1072		1035, 1040, 1047,	Tatung	1072, 1073, 1078		2047, 2076, 2208,
Mind	1066		1060, 1065	TCM	1074, 1093, 1120		2209
Mitsubishi	1029, 1072, 1078	Realistic	1019, 1020, 1021,	Teac	1023, 1091	Apple	2163
Motorola	1022		1022, 1023	Tec	1076, 1090, 1091	Arrgo	2216
MTC	1020	ReplayTV	1041, 1068	Technics	1022	Asono	2318
		Rex	1073	Teknika	1021, 1022, 1023	Aspire	2140, 2202
		RFT	1076, 1078, 1090	Teleavia	1073	Astar	2162

ATACOM	2318	Enzer	2302	LG	2080, 2107, 2115,	2252, 2256, 2260,
Audiovox	2111, 2199	Epson	2165		2116, 2141, 2188,	2268, 2282, 2332,
Avious	2317	ESA	2219		2211, 2215, 2237,	2333, 2343, 2344,
Awa	2313	Finlux	2304, 2312, 2317		2239, 2285, 2293,	2345, 2367, 2371,
Axion	2171	Fintec	2299		2295, 2348, 2370	2373, 2380, 2382,
Bang & Olufsen	2210	Fisher	2212	Life	2228	2385
Baze	2317	Funai	2219	Lifetec	2228	Phonotrend
BBK	2318	Gateway	2097	Limit	2305	Pioneer
Bellagio	2313	GE	2079, 2206, 2209	Liquid Video	2204	2012, 2013, 2014,
Best Buy	2309	Gericom	2269	Liteon	2097, 2121, 2220	2063, 2064, 2065,
Blaupunkt	2209	GFM	2176	Loewe	2274	2066, 2067, 2113,
Blue Parade	2207	Giec	2300	LogicLab	2305	2134, 2207, 2230,
Boghe	2300	Global Solutions	2305	Magnavox	2075, 2096, 2178,	2236, 2265, 2266,
Brainwave	2312	Global Sphere	2305		2180, 2196, 2205,	2267, 2297, 2322,
Brandt	2198, 2238	Go Video	2135, 2215		2219, 2308	2351, 2352, 2353,
Broksonic	2192, 2195	Goodmans	2247, 2289, 2298,	Magnex	2317	2354, 2355, 2356,
Bush	2018, 2060, 2248,		2300, 2308, 2330,	Majestic	2314	2357, 2358, 2359,
	2264, 2301, 2308,		2369	Marantz	2282	2377
	2317, 2350, 2368	GPX	2177	Marquant	2312	Pointer
California Audio Labs		Gradiente	2197	Matsui	2198, 2296	Polaroid
		Graetz	2302	McIntosh	2149	Portland
Cambridge Audio	2304	Greenhill	2209	Mecotek	2312	Powerpoint
CAT	2306, 2307	Grundig	2271	Medion	2228	Prima
CAVS	2146	Grunkel	2312, 2316	Memorex	2078, 2184, 2195	Proceed
Centrum	2307	GVG	2299	MiCO	2300, 2304	Proscan
CGV	2304, 2312	H&B	2308	Micromaxx	2228	Prosonic
Changhong	2222	H_her	2318	Microsoft	2206	2299, 2314
Cinetec	2313	Haaz	2304, 2305	Microstar	2228	Prottron
CineVision	2191, 2215	Haier	2172	Minoka	2312	2152
Clatronic	2308, 2317	Harman/Kardon	2125, 2213	Minowa	2317	Provision
Coby	2077, 2124, 2314	HiMAX	2309	Mintek	2167, 2209	2308
Conia	2301	Hitachi	2008, 2033, 2108,	Mitsubishi	2081	Pye
Continental Edison			2302, 2309, 2320,	Mizuda	2308, 2309	2194
			2366	Monyka	2302	Qwestar
Crown	2312	Hiteker	2208	Mustek	2232	2198
C-Tech	2305	Home Tech Industries	2318	Mx Onda	2304	Raite
Curtis Mathes	2217		2316	Mystral	2316	2058, 2059, 2071,
CVG	2299	Hyundai	2316	Naiko	2312	2079, 2183, 2199,
CyberHome	2048, 2068, 2216,	Ilo	2167	Nesa	2209	2206, 2207, 2209
	2233, 2258	Initial	2167, 2209	Neufunk	2302	2310, 2312, 2314
Cytron	2166	Innovation	2228	Nevir	2312	RedStar
Daenyx	2313	Insignia	2080, 2175, 2219	Next Base	2221	Regent
Daewoo	2083, 2215, 2280,	Integra	2207	Nexxtech	2161	2203
	2299, 2312, 2313,	Irradio	2103	NU-TEC	2301	Reoc
	2326, 2376	iSymphony	2164	Onkyo	2205, 2290	2305
Daewoo International		JBL	2213	Oopla	2097	Rimax
		JVC	2049, 2050, 2051,	Oppo	2150, 2173	2315
Dalton	2311		2052, 2053, 2054,	Optim	2303	Rio
Dansai	2303, 2312		2055, 2056, 2057,	Optimus	2230	2281, 2308
Daytek	2145, 2234, 2313		2070, 2242, 2261,	Orava	2308	Ronin
Dayton	2313		2275, 2276, 2277,	Orbit	2313	2313
DEC	2308		2278, 2339, 2340,	Orion	2027, 2060	2153
Decca	2312		2341, 2342, 2386,	Oritron	2198, 2204	Rowa
Denon	2105, 2147, 2197,		2387, 2389, 2390,	P&B	2308	2200, 2301
	2286		2391	Pacific	2305	2307
Denver	2288, 2308, 2310,	Jwin	2148	Panasonic	2015, 2016, 2017,	Saba
	2314	Kansai	2314		2036, 2037, 2038,	2198, 2238
Denzel	2302	Kawasaki	2199		2039, 2040, 2041,	Sabaki
Desay	2159	Kennex	2312		2042, 2043, 2074,	2305
Diamond	2304, 2305	Kenwood	2123, 2197, 2270		2089, 2104, 2108,	2305
DiamondVision	2179, 2186	KeyPlug	2312		2112, 2120, 2131,	ScanMagic
Disney	2078, 2088	Kiiro	2312		2132, 2197, 2205,	2232
DK Digital	2257	Kingavon	2308		2244, 2245, 2246,	Schaub Lorenz
Dmtech	2226	Kiss	2302		2253, 2254, 2255,	2226
Dual	2302	KLH	2199, 2209		2292, 2321, 2324,	Schneider
Durabrand	2218	Koda	2308		2327, 2328, 2329,	2226
DVX	2305	Koss	2095, 2198, 2204		2331, 2383, 2388	Scientific Labs
Easy Home	2309	KXD	2309	Parasound	2151	2305
Eclipse	2304	Landel	2221	peeKTON	2318	Scott
E-Dem	2318	Lasonic	2214	Philips	2026, 2061, 2062,	2243, 2311
Electrohome	2312	Lawson	2305		2075, 2090, 2094,	Seeltech
Elin	2312	Lecson	2303		2096, 2097, 2103,	2318
Elita	2263, 2312, 2315	Lenco	2308, 2312, 2317		2110, 2126, 2180,	SEG
Emerson	2196, 2211, 2219	Lenoxx	2203, 2218		2193, 2205, 2231,	2240, 2302, 2305,
Enterprise	2211				2235, 2241, 2251,	2313
						Sharp
						2009, 2010, 2084,
						2122, 2142, 2143,
						2144, 2181, 2190,
						2228, 2262, 2375
						2167
						Shinsonic
						2309, 2318
						SigmaTek
						2310
						Silva
						2304, 2305
						Singer
						2279, 2305
						Skymaster

Viewmaster	3045	Condor	4074, 4090, 4137	Fuba	4074, 4083, 4090,	Lasat	4074, 4088, 4090,
Vision	3045	Connexions	4074, 4092		4092, 4093, 4101,		4100, 4133, 4134,
Visiopass	3051, 3054, 3055	Conrad	4074, 4133, 4136,		4133		4137
Vortex View	3045		4137	Galaxis	4074, 4087, 4090,	Lasonic	4062
Wittenberg	3048	Conrad Electronic	4137, 4139		4091, 4096, 4098,	Lenco	4074, 4083, 4099,
Zenith	3035, 3040, 3046	Contec	4096		4133, 4140		4133, 4137, 4139
Zentek	3044	Coolsat	4050	GE	4015, 4016, 4061,	Leng	4095
		Cosat	4098		4151	Lennox	4098
		Coship	4063	General Instrument		Lenson	4136
		Crown	4089		4027, 4065	Lexus	4103
Sattelite		Daeryung	4092	GMI	4089	LG	4053, 4057, 4099
AB Sat	4138, 4139	Daewoo	4107, 4139	GOI	4039	Lifesat	4074, 4090, 4134,
AccessHD	4058	DDC	4085	Goldbox	4135		4139
ADB	4142	Delega	4085	GoldStar	4099	Lifetec	4090
AGS	4138	Dew	4096	Goodmans	4079, 4080, 4084	Lorenzen	4137
Akai	4101, 4103	Diamond	4097	Goodmind	4061	Lorraine	4099
Alba	4083, 4084, 4085,	Digiality	4137	Grandin	4077	Lupus	4074, 4090
	4086, 4108, 4139	Digital Stream	4059	Grothusen	4083, 4099	Luxor	4136
Aldes	4085, 4087, 4088	DIRECTV	4017, 4018, 4020,	Grundig	4084, 4086, 4093,	Lyonnaise	4102
Allsat	4098, 4101, 4103		4021, 4022, 4024,		4113, 4129, 4136,	Macab	4102
Allsonic	4074, 4087, 4090		4037, 4038, 4040,	Hänsel & Gretel	4137	Magnavox	4045, 4055
Alltech	4139		4041, 4043, 4045,	Hantor	4083, 4095	Manata	4077, 4138, 4139
Alpha	4103		4057, 4106, 4143,	Hanuri	4088	Manhattan	4084, 4088, 4098,
Alpha Digital	4058		4144, 4145, 4146,	Hauppauge	4126		4138
Alphastar	4031		4147, 4148, 4149,	Heliocom	4137	Marantz	4101
Amitronica	4139		4150, 4151, 4152,	Hinari	4085	Mascom	4088
Amstrad	4089, 4113, 4136,		4153, 4154, 4155,	Hirschmann	4074, 4093, 4128,	Maspro	4084, 4139
	4139	Discoverer	4156, 4157		4136, 4137, 4138,	Matsui	4138
Anglo	4139	Discovery	4138		4095	Max	4137
Ankaro	4074, 4087, 4090,	Diseqc	4138	Hisawa	4066	Mediabox	4135
	4139	Dish Network	4011, 4012, 4013,	Hisense	4066	Mediamarkt	4089
Anttron	4083, 4086		4014, 4019, 4039,	Hitachi	4032, 4084, 4149,	Mediasat	4091, 4135, 4136
Apollo	4083		4064	Homecast	4153	Medion	4074, 4090, 4139
Armstrong	4089, 4103	Dishpro	4039, 4064	Houston	4005, 4006, 4007	Medison	4139
Artec	4054	Distrisat	4103	HTS	4098	Mega	4101, 4103
Asat	4101, 4103	Ditrisatrad	4098	Hughes	4039	Memorex	4045
ASLF	4139	DNT	4092, 4101, 4103		4018, 4022, 4144,	Metronic	4077, 4078, 4083,
Astacom	4138	Drake	4026		4146, 4150, 4152		4086, 4087, 4088,
Astra	4089, 4091, 4100,	DStv	4140	Hughes Network Systems			4139
	4137, 4139	Dune	4074		4021	Metz	4093
Astro	4074, 4086, 4088,	Echostar	4011, 4019, 4039,	Humax	4051, 4075, 4076,	Micro electronic	4136, 4137, 4139
	4090, 4093, 4135,		4064, 4092, 4139		4110	Micro Technology	4139
	4136, 4137	Einhell	4083, 4087, 4089,	Huth	4087, 4089, 4094,	MicroGem	4056
AudioTon	4086, 4098		4136, 4139		4095, 4096, 4098,	Micromaxx	4074, 4090
Aurora	4140	Elap	4138, 4139		4137, 4141	Microstar	4090
Austar	4140	Elekta	4088	Hypson	4077	Microtec	4139
Axiel	4138	Elsat	4139	Ilo	4066	Minerva	4093
Axis	4074, 4090, 4091,	Elta	4074, 4083, 4090,	Imex	4077	Mitsubishi	4084, 4093, 4152
	4096		4098, 4101, 4103	Innovation	4090	Mitsumi	4100
Best	4074, 4090	Emanon	4083	Insignia	4057	Morgan's	4089, 4100, 4101,
Blaupunkt	4093	Emme Esse	4074, 4090	Intertronic	4089		4103, 4139
Blue Sky	4139	Engel	4139	Intervision	4098, 4137	Motorola	4008, 4009, 4010,
Boca	4089, 4100, 4105,	Ep Sat	4084	ITT Nokia	4084		4065
	4139	EURIEULT	4077	Jerrold	4065	Multichoice	4140
Boston	4138	Eurodec	4102	Johansson	4095	Multitec	4134
Brain Wave	4095	Europa	4103, 4136, 4137	JOK	4138	Muratto	4099
Broadcast	4094	Europhon	4137	JSR	4098	Mysat	4139
Broco	4139	Eurosat	4089	JVC	4011, 4019, 4039,	Navex	4095
BSkyB	4113, 4123	Eurosky	4074, 4089, 4090,		4079	Neuhaus	4091, 4098, 4136,
BT	4138		4133, 4136, 4137	Kamm	4139		4137, 4139
Bubu Sat	4139	Eurostar	4089, 4133, 4137	Kathrein	4093, 4101, 4103,	Neusat	4139
Bush	4084, 4127	Eutelsat	4139		4109, 4112, 4120,	Next Level	4065
Bush	4136	Exator	4083, 4086		4133, 4138, 4139	NextWave	4141
Cambridge	4136	Expressvu	4039	Kathrein Eurostar	4133	Nikko	4089, 4139
Canal Satellite	4135	Fenner	4074, 4134, 4139	Klap	4138	Nokia	4084, 4122
Canal+	4135	Ferguson	4084, 4102, 4132	Konig	4137	Nordmende	4083, 4084, 4085,
CaptiveWorks	4049	Fidelity	4136	Kosmos	4099		4088, 4102
Channel Master	4060, 4085	Finlandia	4084	KR	4086	Nova	4140
Chaparral	4025	Finlux	4084	Kreiselmeyer	4093	Novis	4095
CHEROKEE	4138	FinnSat	4096, 4102	K-SAT	4139	Oceanic	4097
Chess	4134, 4139	Flair Mate	4139	Kyostar	4083	Octagon	4083, 4086, 4096
CityCom	4084, 4133, 4137	Foxtel	4140	L&S Electronic	4074	Okano	4089
Clatronic	4095	Freecom	4083, 4099, 4136			Optex	4098
CNT	4088	FTEmaximal	4074, 4139			Optus	4135, 4140, 4141
Comag	4000, 4001, 4002,						
	4003, 4004						
Commlink	4087						
Comtech	4096						

Orbitech	4083, 4134, 4135, 4136	Satcom	4094, 4137	Tivax	4058
OSat	4086	Satec	4139	Tivo	4150
Otto Versand	4093	Satelco	4074	Tokai	4103
Pace	4084, 4093, 4113, 4121, 4125, 4138	Satford	4094	Tonna	4084, 4094, 4098, 4136, 4139
Pacific	4097	Satmaster	4094	Toshiba	4144, 4152, 4153
Packsat	4138	Satplus	4134	Triad	4099
Palcom	4085	Schneider	4090, 4134, 4138	Triasat	4136
Palladium	4089, 4136	Schwaiger	4097, 4134, 4137	Triax	4093, 4133, 4136, 4139
Palsat	4134, 4136	SCS	4133	Turnsat	4139
Panasat	4140	Seemann	4089, 4091, 4092	Tvronics	4132
Panasonic	4043, 4044, 4046, 4084, 4113, 4118, 4143, 4148	SEG	4074, 4083, 4090, 4095	Twiner	4077, 4139
Panda	4084, 4137	Seleco	4098	UEC	4140
Pansat	4047	Servi Sat	4077, 4139	Uher	4134
Patriot	4138	Siemens	4093	UltimateTV	4020
Paysat	4045	Silva	4099	Uniden	4029, 4045
PCT	4060	Skantin	4139	Unisat	4089, 4096, 4103
Philco	4055	Skardin	4091	Unitor	4095
Philips	4021, 4022, 4045, 4084, 4101, 4103, 4111, 4115, 4135, 4138, 4150, 4152, 4153, 4155, 4156	Skinsat	4136	Universum	4093, 4133, 4137
Phoenix	4096	SKR	4139	US Digital	4066
Phonotrend	4084, 4087, 4098	Skymaster	4067, 4068, 4087, 4134, 4139	Variosat	4093
Pioneer	4124, 4135	Skymax	4101, 4103	Vega	4074
Polsat	4102	SkySat	4134, 4136, 4137, 4139	Ventana	4101, 4103
Predki	4095	Skyvision	4098	Viewsat	4048
Premiere	4098, 4135	SM Electronic	4134, 4139	Visiosat	4095, 4098, 4138, 4139
Priesner	4089	Smart	4133, 4139	Voom	4065
Primestar	4030	Sony	4017, 4020, 4135	Vortec	4083
Profile	4138	SR	4089, 4100	Welltech	4134
Promax	4084	Star Choice	4065	WeTeKom	4134, 4136
Prosat	4085, 4087	Starland	4139	Wevasat	4084
Proscan	4015, 4016, 4040, 4151	Starring	4095	Wewa	4084
Protek	4097	Start Trak	4083	Winersat	4095
Proton	4066	Strong	4074, 4083, 4086, 4090, 4099, 4140	Wisi	4084, 4092, 4093, 4136, 4137
Provision	4088	STS	4033	Woorisat	4088
Quadral	4074, 4085, 4087, 4090, 4138	STVI	4077	Worldsat	4138
Quelle	4093, 4133, 4137	Sumida	4089	Xrypton	4074
Quiero	4102	Sunny Sound	4074	XSat	4139
RadioShack	4065	Sunsat	4139	Zehnder	4074, 4088, 4090, 4131, 4133
Radiola	4101, 4103	Sunstar	4074, 4089, 4100	Zenith	4052, 4057, 4145
Radix	4092, 4119	Supermax	4141	Zodiac	4086
Rainbow	4086	Tandberg	4102		
RCA	4015, 4016, 4034, 4035, 4036, 4037, 4038, 4040, 4151, 4157	Tandy	4086		
Realistic	4028	Tantec	4084		
Redpoint	4091	TCM	4090		
Redstar	4074, 4090	Techniland	4094		
RFT	4087, 4101, 4103	TechniSat	4071, 4072, 4073, 4092, 4103, 4116, 4117, 4134, 4135, 4136		
Roadstar	4139	Technology	4140		
Roch	4077	Technosat	4141		
Rover	4074, 4139	Technowelt	4137		
Saba	4088, 4133, 4137, 4138	Teco	4089, 4100		
Sabre	4084	Telanor	4085		
Sagem	4069, 4102	Telasat	4133, 4137		
Sakura	4096	Telecom	4139		
Samsung	4018, 4021, 4023, 4041, 4042, 4081, 4082, 4083, 4114, 4150, 4154	Telefunken	4067, 4083, 4138		
SAT	4085, 4136	Teleka	4086, 4089, 4092, 4136, 4137		
Sat Cruiser	4141	Telemaster	4088		
Sat Partner	4083, 4086, 4088, 4095, 4099, 4136	Telesat	4137		
Sat Team	4139	Telestar	4134, 4135, 4136		
		Televcs	4084, 4136		
		Telewire	4098		
		Tempo	4141		
		Tevion	4090, 4139		
		Thomson	4070, 4084, 4102, 4104, 4130, 4133, 4135, 4137, 4138, 4139		
		Thorens	4097		
		Thorn	4084		

CD

Yamaha 5000, 5013

CD Recoder

Yamaha 5001

MD

Yamaha 5002, 5003, 5004

Tape

Yamaha 5005, 5006

Tuner

Yamaha 5007, 5008, 5009,
5010, 5014, 5015,
5016, 5017, 5018

USB

Yamaha 5012, 5021

DOCK

Yamaha 5011, 5022

LD

Yamaha 2002



© 2009 Yamaha Corporation All rights reserved.

YAMAHA CORPORATION
Printed in China © WQ95630

The letters in circles and the numbers in squares correspond to those in the Owner's Manual.

Les lettres dans les cercles et les numéros dans les carrés correspondent à ceux du mode d'emploi.

Die Buchstaben in Kreisen und die Nummern in Kästchen entsprechen denen in der Bedienungsanleitung.

Bokstäverna i cirkelarna och siffrorna i rutorna motsvarar de i bruksanvisningen.

Le lettere cerchiate e i numeri nei quadratini corrispondono a quelli nel Manuale di istruzioni.

Las letras enmarcadas en un círculo y los números enmarcados en un cuadrado se corresponden con aquellos del manual de instrucciones.

De letters in cirkels en de nummers in hokjes corresponderen met de in de Gebruiksaanwijzing.

Буквы в кружочках и цифры в квадратиках соответствуют таковым в инструкции по эксплуатации.

圆圈内的字母和正方形内的数字与说明书内的同类字母和数字相对应。

원 안의 문자들과 사각형 안의 숫자들은 사용자 설명서에 있는 것들과 일치합니다.

■ **Front panel/Face avant/Frontblende/Frontpanelen/Pannelo anteriore/Panel delantero/Voorpaneel/
Фронтальная панель/ 前部面板 / 전면 패널**

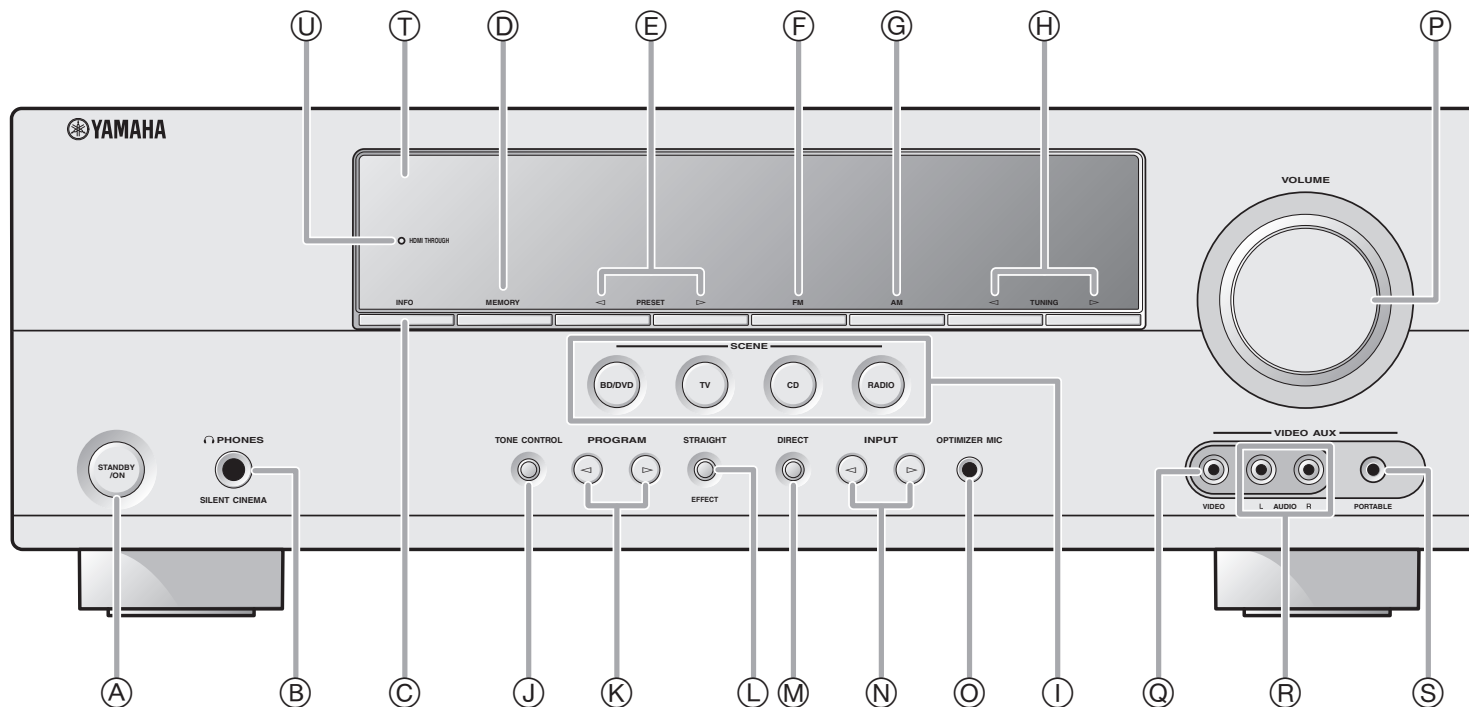

Remote control/Boîtier de télécommande/Fernbedienung/Fjärrkontrollen/Telecomando/Mando a distancia/Afstandsbediening/Пульт ДУ/ 遥控器 / 리모콘

