



RX-V361

AV Receiver

OWNER'S MANUAL

Important safety instructions

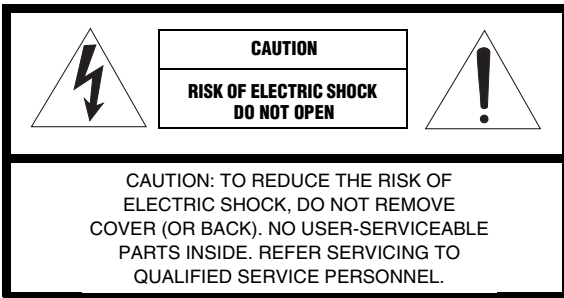

• Explanation of Graphical Symbols



The lightning flash with arrowhead symbol, within an equilateral triangle, is intended to alert you to the presence of uninsulated “dangerous voltage” within the product’s enclosure that may be of sufficient magnitude to constitute a risk of electric shock to persons.



The exclamation point within an equilateral triangle is intended to alert you to the presence of important operating and maintenance (servicing) instructions in the literature accompanying the appliance.

- 1 Read Instructions – All the safety and operating instructions should be read before the product is operated.
- 2 Retain Instructions – The safety and operating instructions should be retained for future reference.
- 3 Heed Warnings – All warnings on the product and in the operating instructions should be adhered to.
- 4 Follow Instructions – All operating and use instructions should be followed.
- 5 Cleaning – Unplug this product from the wall outlet before cleaning. Do not use liquid cleaners or aerosol cleaners.
- 6 Attachments – Do not use attachments not recommended by the product manufacturer as they may cause hazards.
- 7 Water and Moisture – Do not use this product near water – for example, near a bath tub, wash bowl, kitchen sink, or laundry tub; in a wet basement; or near a swimming pool; and the like.
- 8 Accessories – Do not place this product on an unstable cart, stand, tripod, bracket, or table. The product may fall, causing serious injury to a child or adult, and serious damage to the product. Use only with a cart, stand, tripod, bracket, or table recommended by the manufacturer, or sold with the product. Any mounting of the product should follow the manufacturer’s instructions, and should use a mounting accessory recommended by the manufacturer.
- 9 A product and cart combination should be moved with care. Quick stops, excessive force, and uneven surfaces may cause the product and cart combination to overturn.
- 10 Ventilation – Slots and openings in the cabinet are provided for ventilation and to ensure reliable operation of the product and to protect it from overheating, and these openings must not be blocked or covered. The openings should never be blocked by placing the product on a bed, sofa, rug, or other similar surface. This product should not be placed in a built-in installation such as a bookcase or rack unless proper ventilation is provided or the manufacturer’s instructions have been adhered to.
- 11 Power Sources – This product should be operated only from the type of power source indicated on the marking label. If you are not sure of the type of power supply to your home, consult your product dealer or local power company. For products intended to operate from battery power, or other sources, refer to the operating instructions.
- 12 Grounding or Polarization – This product may be equipped with a polarized alternating current line plug (a plug having one blade wider than the other). This plug will fit into the power outlet only one way. This is a safety feature. If you are unable to insert the plug fully into the outlet, try reversing the plug. If the plug should still fail to fit, contact your electrician to replace your obsolete outlet. Do not defeat the safety purpose of the polarized plug.
- 13 Power-Cord Protection – Power-supply cords should be routed so that they are not likely to be walked on or pinched by items placed upon or against them, paying particular attention to cords at plugs, convenience receptacles, and the point where they exit from the product.
- 14 Lightning – For added protection for this product during a lightning storm, or when it is left unattended and unused for long periods of time, unplug it from the wall outlet and disconnect the antenna or cable system. This will prevent damage to the product due to lightning and power-line surges.
- 15 Power Lines – An outside antenna system should not be located in the vicinity of overhead power lines or other electric light or power circuits, or where it can fall into such power lines or circuits. When installing an outside antenna system, extreme care should be taken to keep from touching such power lines or circuits as contact with them might be fatal.
- 16 Overloading – Do not overload wall outlets, extension cords, or integral convenience receptacles as this can result in a risk of fire or electric shock.
- 17 Object and Liquid Entry – Never push objects of any kind into this product through openings as they may touch dangerous voltage points or short-out parts that could result in a fire or electric shock. Never spill liquid of any kind on the product.
- 18 Servicing – Do not attempt to service this product yourself as opening or removing covers may expose you to dangerous voltage or other hazards. Refer all servicing to qualified service personnel.
- 19 Damage Requiring Service – Unplug this product from the wall outlet and refer servicing to qualified service personnel under the following conditions:
 - a) When the power-supply cord or plug is damaged,
 - b) If liquid has been spilled, or objects have fallen into the product,
 - c) If the product has been exposed to rain or water,



- d) If the product does not operate normally by following the operating instructions. Adjust only those controls that are covered by the operating instructions as an improper adjustment of other controls may result in damage and will often require extensive work by a qualified technician to restore the product to its normal operation,
 - e) If the product has been dropped or damaged in any way, and
 - f) When the product exhibits a distinct change in performance - this indicates a need for service.
- 20 Replacement Parts** – When replacement parts are required, be sure the service technician has used replacement parts specified by the manufacturer or have the same characteristics as the original part. Unauthorized substitutions may result in fire, electric shock, or other hazards.
- 21 Safety Check** – Upon completion of any service or repairs to this product, ask the service technician to perform safety checks to determine that the product is in proper operating condition.
- 22 Wall or Ceiling Mounting** – The unit should be mounted to a wall or ceiling only as recommended by the manufacturer.
- 23 Heat** – The product should be situated away from heat sources such as radiators, heat registers, stoves, or other products (including amplifiers) that produce heat.

- 24 Outdoor Antenna Grounding** – If an outside antenna or cable system is connected to the product, be sure the antenna or cable system is grounded so as to provide some protection against voltage surges and built-up static charges. Article 810 of the National Electrical Code, ANSI/NFPA 70, provides information with regard to proper grounding of the mast and supporting structure, grounding of the lead-in wire to an antenna discharge unit, size of grounding conductors, location of antenna discharge unit, connection to grounding electrodes, and requirements for the grounding electrode.

EXAMPLE OF ANTENNA GROUNDING

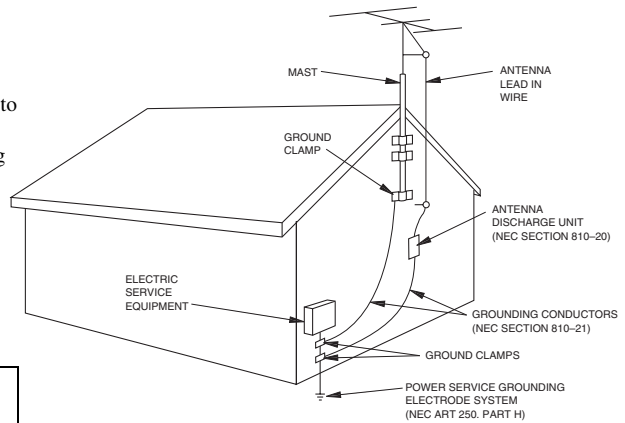

NEC – NATIONAL ELECTRICAL CODE

Note to CATV system installer:

This reminder is provided to call the CATV system installer's attention to Article 820-40 of the NEC that provides guidelines for proper grounding and, in particular, specifies that the cable ground shall be connected to the grounding system of the building, as close to the point of cable entry as practical.

FCC INFORMATION (for US customers)

1 IMPORTANT NOTICE: DO NOT MODIFY THIS UNIT!

This product, when installed as indicated in the instructions contained in this manual, meets FCC requirements. Modifications not expressly approved by Yamaha may void your authority, granted by the FCC, to use the product.

- 2 IMPORTANT:** When connecting this product to accessories and/or another product use only high quality shielded cables. Cable/s supplied with this product **MUST** be used. Follow all installation instructions. Failure to follow instructions could void your FCC authorization to use this product in the USA.

- 3 NOTE:** This product has been tested and found to comply with the requirements listed in FCC Regulations, Part 15 for Class "B" digital devices. Compliance with these requirements provides a reasonable level of assurance that your use of this product in a residential environment will not result in harmful interference with other electronic devices.

This equipment generates/uses radio frequencies and, if not installed and used according to the instructions found in the users manual, may cause interference harmful to the operation of other electronic devices.

Compliance with FCC regulations does not guarantee that interference will not occur in all installations. If this product is found to be the source of interference, which can be determined by turning the unit "OFF" and "ON", please try to eliminate the problem by using one of the following measures:

Relocate either this product or the device that is being affected by the interference.

Utilize power outlets that are on different branch (circuit breaker or fuse) circuits or install AC line filter/s.

In the case of radio or TV interference, relocate/reorient the antenna. If the antenna lead-in is 300 ohm ribbon lead, change the lead-in to coaxial type cable.

If these corrective measures do not produce satisfactory results, please contact the local retailer authorized to distribute this type of product. If you can not locate the appropriate retailer, please contact Yamaha Electronics Corp., U.S.A. 6660 Orangethorpe Ave., Buena Park, CA 90620.

The above statements apply **ONLY** to those products distributed by Yamaha Corporation of America or its subsidiaries.

Caution: Read this before operating your unit.

- 1 To assure the finest performance, please read this manual carefully. Keep it in a safe place for future reference.
- 2 Install this sound system in a well ventilated, cool, dry, clean place – away from direct sunlight, heat sources, vibration, dust, moisture, and/or cold. Allow ventilation space of at least 30 cm on the top, 20 cm on the left and right, and 20 cm on the back of this unit.
- 3 Locate this unit away from other electrical appliances, motors, or transformers to avoid humming sounds.
- 4 Do not expose this unit to sudden temperature changes from cold to hot, and do not locate this unit in an environment with high humidity (i.e. a room with a humidifier) to prevent condensation inside this unit, which may cause an electrical shock, fire, damage to this unit, and/or personal injury.
- 5 Avoid installing this unit where foreign object may fall onto this unit and/or this unit may be exposed to liquid dripping or splashing. On the top of this unit, do not place:
 - Other components, as they may cause damage and/or discoloration on the surface of this unit.
 - Burning objects (i.e. candles), as they may cause fire, damage to this unit, and/or personal injury.
 - Containers with liquid in them, as they may fall and liquid may cause electrical shock to the user and/or damage to this unit.
- 6 Do not cover this unit with a newspaper, tablecloth, curtain, etc. in order not to obstruct heat radiation. If the temperature inside this unit rises, it may cause fire, damage to this unit, and/or personal injury.
- 7 Do not plug in this unit to a wall outlet until all connections are complete.
- 8 Do not operate this unit upside-down. It may overheat, possibly causing damage.
- 9 Do not use force on switches, knobs and/or cords.
- 10 When disconnecting the power cable from the wall outlet, grasp the plug; do not pull the cord.
- 11 Do not clean this unit with chemical solvents; this might damage the finish. Use a clean, dry cloth.
- 12 Only voltage specified on this unit must be used. Using this unit with a higher voltage than specified is dangerous and may cause fire, damage to this unit, and/or personal injury. Yamaha will not be held responsible for any damage resulting from use of this unit with a voltage other than specified.
- 13 To prevent damage by lightning, keep the power cord and outdoor antennas disconnected from a wall outlet or the unit during a lightning storm.
- 14 Do not attempt to modify or fix this unit. Contact qualified Yamaha service personnel when any service is needed. The cabinet should never be opened for any reasons.
- 15 When not planning to use this unit for long periods of time (i.e. vacation), disconnect the AC power plug from the wall outlet.
- 16 Install this unit near the AC outlet and where the AC power plug can be reached easily.
- 17 Be sure to read the “Troubleshooting” section on common operating errors before concluding that this unit is faulty.
- 18 Before moving this unit, press STANDBY/ON to set this unit in the standby mode, and disconnect the AC power plug from the wall outlet.
- 19 **VOLTAGE SELECTOR** (Asia and General models only)
The VOLTAGE SELECTOR on the rear panel of this unit must be set for your local main voltage BEFORE plugging into the AC wall outlet.
Voltages are 110–120/220–240 V AC, 50/60 Hz.
- 20 The batteries shall not be exposed to excessive heat such as sunshine, fire or like.

WARNING

TO REDUCE THE RISK OF FIRE OR ELECTRIC SHOCK, DO NOT EXPOSE THIS UNIT TO RAIN OR MOISTURE.

This unit is not disconnected from the AC power source as long as it is connected to the wall outlet, even if this unit itself is turned off by STANDBY/ON. This state is called the standby mode. In this state, this unit is designed to consume a very small quantity of power.

FOR CANADIAN CUSTOMERS

To prevent electric shock, match wide blade of plug to wide slot and fully insert.
This Class B digital apparatus complies with Canadian ICES-003.

POUR LES CONSOMMATEURS CANADIENS

Pour éviter les chocs électriques, introduire la lame la plus large de la fiche dans la borne correspondante de la prise et pousser jusqu'au fond.
Cet appareil numérique de la classe B est conforme à la norme NMB-003 du Canada.

IMPORTANT

Please record the serial number of this unit in the space below.
MODEL:
Serial No.:
The serial number is located on the rear of the unit.
Retain this Owner's Manual in a safe place for future reference.

Contents

INTRODUCTION

Features	2
Getting started	3
Quick start guide	4
Preparation: Check the items	4
Step 1: Set up your speakers	5
Step 2: Connect your DVD player and other components	6
Step 3: Turn on the power and press SCENE 1 button	8
What do you want to do with this unit?	9

PREPARATION

Connections	10
Rear panel	10
Placing speakers	11
Connecting speakers	12
Setting the speaker impedance (U.S.A. and Canada models only)	13
Information on jacks and cable plugs	14
Connecting video components	15
Connecting audio components	17
Connecting the FM and AM antennas	18
Connecting the power cable	18
Turning on and off the power	18
Front panel display	19
Basic setup	21

BASIC OPERATION

Selecting the SCENE templates	23
Selecting the desired SCENE template	23
Creating your original SCENE templates	26
Playback	27
Basic operations	27
Additional operations	28
Sound field programs	31
Sound field program descriptions	31
FM/AM tuning	34
Automatic tuning	34
Manual tuning	34
Automatic preset tuning	35
Manual preset tuning	35
Selecting preset stations	36
Exchanging preset stations	36
XM Satellite Radio tuning	37
Connecting the XM Mini-Tuner Dock	37
Activating XM Satellite Radio	38
Basic XM Satellite Radio operations	38
Setting XM Satellite Radio preset channels	40
Displaying the XM Satellite Radio information	41
Recording	42

ADVANCED OPERATION

Set menu	43
Using set menu	44
1 SOUND MENU	45
2 INPUT MENU	48
3 OPTION MENU	50
Remote control features	51
Using remote control on the SCENE feature	51
Controlling this unit, a TV, or other components	52
Setting remote control codes	54
Advanced setup	55

ADDITIONAL INFORMATION





Troubleshooting	56
Glossary	61
Specifications	63
Index	64

APPENDIX

(at the end of this manual)

Front panel	i
Remote control	ii
List of remote control codes	iii

About this manual

-  indicates a tip for your operation.
- Some operations can be performed by using either the buttons on the front panel or the ones on the remote control. In case the button names differ between the front panel and the remote control, the button name on the remote control is given in parentheses.
- This manual is printed prior to production. Design and specifications are subject to change in part as a result of improvements, etc. In case of differences between the manual and product, the product has priority.
- “ **STANDBY/ON**” or “ **MULTI CH IN**” (example) indicates the name of the parts on the front panel or the remote control. Refer to the attached sheet or the top pages of this manual for the information about each position of the parts.
- The symbol “ ” with page number(s) indicates the corresponding reference page(s).

Features

Built-in 5-channel power amplifier

- ◆ Minimum RMS output power
[U.S.A. and Canada models]
(1 kHz, 0.9% THD, 8 Ω)
Front: 100 W + 100 W
Center: 100 W
Surround: 100 W + 100 W
[Other models]
(1 kHz, 0.9% THD, 6 Ω)
Front: 100 W + 100 W
Center: 100 W
Surround: 100 W + 100 W

SCENE select function

- ◆ Preset SCENE templates for various situations
- ◆ 4 original SCENE templates for customizing capability

Decoders and DSP circuits

- ◆ Proprietary Yamaha technology for the creation of multi-channel surround sound
- ◆ Compressed Music Enhancer mode to improve the sound quality of compression artifacts (such as the MP3 format) to that of a high-quality stereo
- ◆ Dolby Digital decoder
- ◆ Dolby Pro Logic/Dolby Pro Logic II decoder
- ◆ DTS decoder
- ◆ Neural Surround decoder
(U.S.A. and Canada models only)
- ◆ Virtual CINEMA DSP
- ◆ SILENT CINEMA™

Sophisticated FM/AM tuner

- ◆ 40-station random and direct preset tuning
- ◆ Automatic preset tuning

XM Satellite Radio

(U.S.A. and Canada models only)

- ◆ XM Satellite Radio tuning capability (using the “XM Mini-Tuner Dock” sold separately)
- ◆ Neural Surround decoder to play back the XM HD content of XM Satellite Radio broadcasts in multi-channels, resulting in a full surround sound experience

Other features

- ◆ 192-kHz/24-bit D/A converter
- ◆ 6 additional input jacks for discrete multi-channel input
- ◆ Component video input/output capability
(3 COMPONENT VIDEO INs and 1 MONITOR OUT)
- ◆ Optical and coaxial digital audio signal jacks
- ◆ Sleep timer
- ◆ Cinema and music night listening modes
- ◆ Remote control with preset remote control codes



Manufactured under license from Dolby Laboratories.

“Dolby”, “Pro Logic”, and the double-D symbol are trademarks of Dolby Laboratories.

SILENT™
CINEMA

“SILENT CINEMA” is a trademark of YAMAHA CORPORATION.



“DTS” and “DTS Digital Surround” are registered trademarks of DTS, Inc.



The XM name and related logos are registered trademarks of XM Satellite Radio Inc.



Neural Surround™ name and related logos are trademarks owned by Neural Audio Corporation.

We Want You Listening For A Lifetime

Yamaha and the Electronic Industries Association’s Consumer Electronics Group want you to get the most out of your equipment by playing it at a safe level. One that lets the sound come through loud and clear without annoying blaring or distortion – and, most importantly, without affecting your sensitive hearing.

Since hearing damage from loud sounds is often undetectable until it is too late, Yamaha and the Electronic Industries Association’s Consumer Electronics Group recommend you to avoid prolonged exposure from excessive volume levels.



Getting started

■ Checking the supplied accessories

Check that you received all of the following parts.

Remote control



Batteries (2)
(AAA, R03, UM-4)

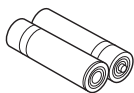

AM loop antenna

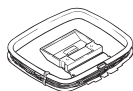

Indoor FM antenna

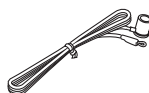

Note

The form of the supplied accessories varies depending on the models.

■ VOLTAGE SELECTOR (Asia and General models only)

Caution

The VOLTAGE SELECTOR on the rear panel of this unit must be set for your local voltage BEFORE plugging the power cable into the AC wall outlet. Improper setting of the VOLTAGE SELECTOR may cause damage to this unit and create a potential fire hazard.

Select the switch position (upper or lower) according to your local voltage using a straight slot screwdriver.

Voltages are 110-120/220-240 V AC, 50/60 Hz.

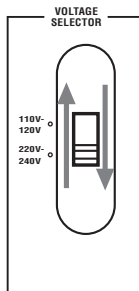

■ Installing batteries in the remote control

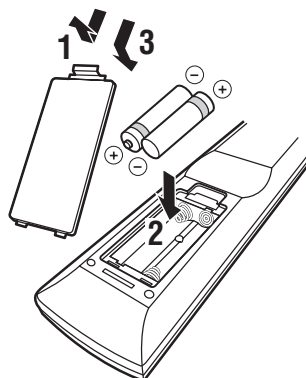

1 Take off the battery compartment cover.

2 Insert the two supplied batteries (AAA, R03, UM-4) according to the polarity markings (+ and -) on the inside of the battery compartment.

3 Snap the battery compartment cover back into place.

Notes

- Change all of the batteries if you notice the following condition:
 - the operation range of the remote control decreases.
- Do not use an old battery and a new one together.
- Do not use different types of batteries (such as alkaline and manganese batteries) together. Read the packaging carefully as these different types of batteries may have the same shape and color.
- If the batteries have leaked, dispose of them immediately. Avoid touching the leaked material or letting it come into contact with clothing, etc. Clean the battery compartment thoroughly before installing new batteries.
- Do not throw away batteries with general house waste; dispose of them correctly in accordance with your local regulations.
- If the remote control is without batteries for more than 2 minutes, or if exhausted batteries remain in the remote control, the contents of the memory may be cleared. When the memory is cleared, insert new batteries and set up the remote control code.

Quick start guide

The following steps describe the easiest way to enjoy DVD movie playback in your home theater.

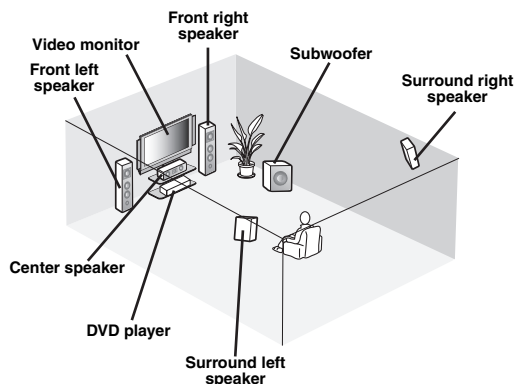

Step 1: Set up your speakers

P. 5

Step 2: Connect your DVD player and other components

P. 6

Step 3: Turn on the power and press SCENE 1 button

P. 8

Enjoy DVD playback!

Preparation: Check the items

In these steps, you need the following supplied accessories.

- Indoor FM antenna
- AM loop antenna

The following items are not included in the package of this unit.

- Speakers**
 - Front speakers 2
 - Center speaker 1
 - Surround speakers 2Select magnetically shielded speakers. The minimum required speakers are two front speakers.
- Active subwoofer** 1
Select an active subwoofer equipped with an RCA input jack.
- Speaker cables** 5
- Subwoofer cable** 1
Select a monaural RCA cable.
- DVD player** 1
Select DVD player equipped with coaxial digital audio output jack and composite video output jack.
- Video monitor** 1
Select a TV monitor, video monitor or projector equipped with a composite video input jack.
- Video cable** 1
Select an RCA composite video cable.
- Digital coaxial audio cable** 1

Step 1: Set up your speakers

Place your speakers in the room and connect them to this unit.

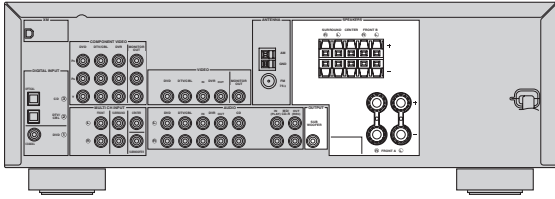

1 Place your speakers and subwoofer in the room.

2 Connect speaker cables to each speaker.

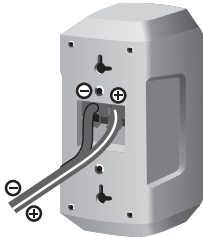

Cables are colored or shaped differently, perhaps with a stripe, groove or ridge. Connect the striped (grooved, etc.) cable to the “+” (red) terminals of your speaker. Connect the plain cable to the “-” (black) terminals.

3 Connect each speaker cable to the corresponding speaker terminal of this unit.

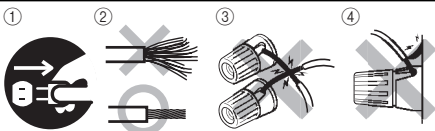

- ① Make sure that this unit and the subwoofer are unplugged from the AC wall outlets.
- ② Twist the exposed wires of the speaker cables together to prevent short circuits.
- ③ Do not let the bare speaker wires touch each other.
- ④ Do not let the bare speaker wires touch any metal part of this unit.

Be sure to connect the left channel (L), right channel (R), “+” (red) and “-” (black) properly.

Front speakers

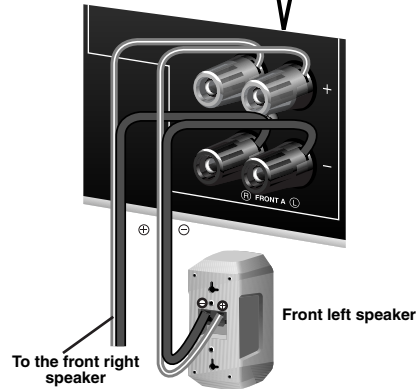
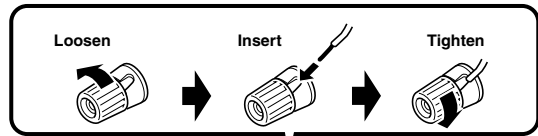

Center and surround speakers

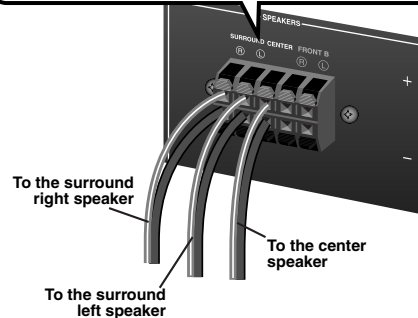
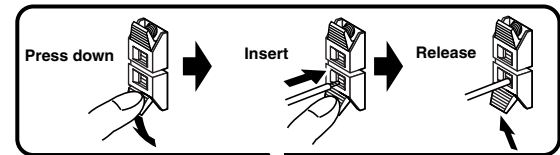

4 Connect the subwoofer cable to the input jack of the subwoofer and the SUBWOOFER OUTPUT jack of this unit.

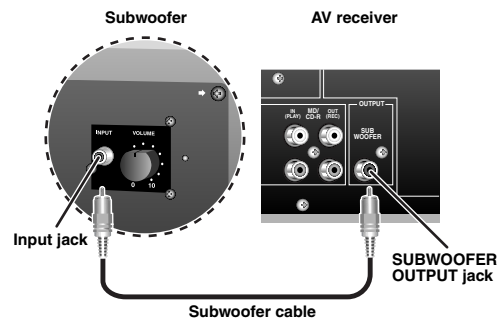

Step 2: Connect your DVD player and other components

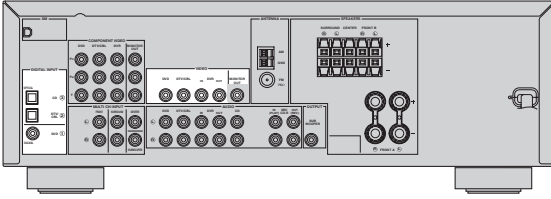

Make sure that this unit and the DVD player are unplugged from the AC wall outlets.

- 1 Connect the digital coaxial audio cable to the digital coaxial audio output jack of your DVD player and the DVD DIGITAL INPUT COAXIAL jack of this unit.

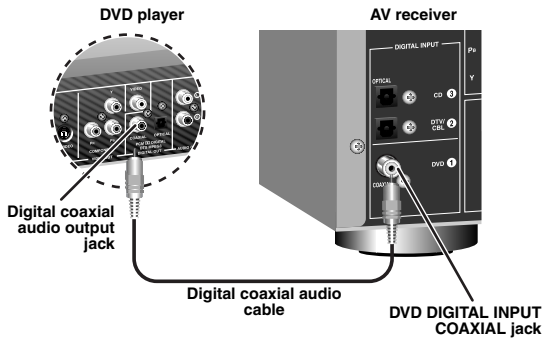

- 2 Connect the video cable to the composite video output jack of your DVD player and the DVD VIDEO jack of this unit.

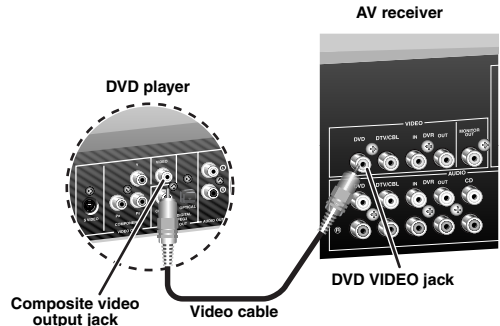

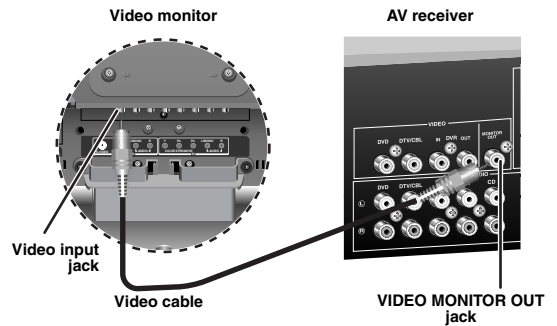

- 3 Connect the video cable to the video input jack of your video monitor and the VIDEO MONITOR OUT jack of this unit.

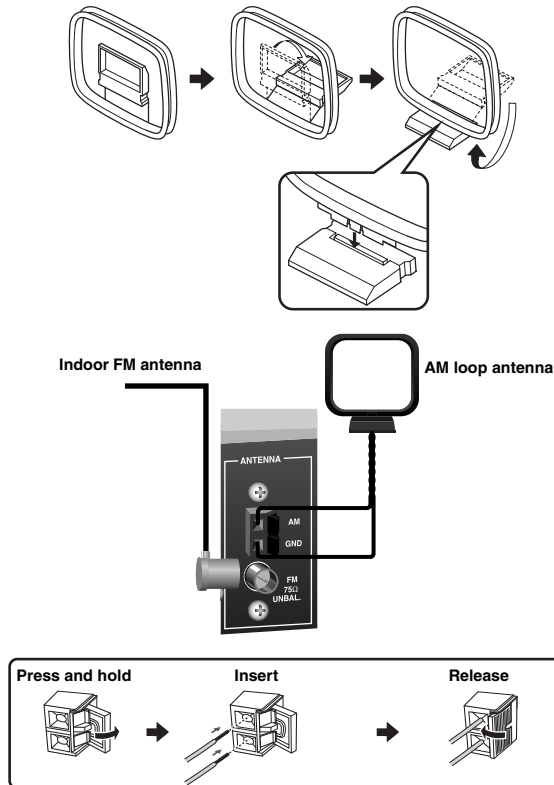

4 Connect the FM and AM antennas to this unit.

See page 18 for the details.



 The wire of the AM loop antenna does not have any polarity and you can connect either end of the wire to AM or GND terminal.

5 Connect the power plug of this unit and other components into the AC wall outlet.

■ For further connections

- Using the other kind of speaker combinations ➤ P. 11
- Connecting a video monitor and DVD player ➤ P. 15
- Connecting a cable TV/satellite tuner and DVD recorder ➤ P. 15
- Connecting to the COMPONENT VIDEO jacks ➤ P. 16
- Using the VIDEO AUX jacks on the front panel ➤ P. 16
- Connecting a CD player and an MD recorder ➤ P. 17
- Connecting a DVD player via analog multi-channel audio connection ➤ P. 17
- Connecting an outdoor FM/AM antenna ➤ P. 18
- Connecting the XM Mini-Tuner Dock ➤ P. 37

Step 3: Turn on the power and press SCENE 1 button

Check the type of the connected speakers.
If the speakers are 6 ohm speakers, set “SP IMP.” to “6ΩMIN” before using this unit (see page 13).

- 1 Turn on the video monitor connected to this unit.
- 2 Press ① **STANDBY/ON** on the front panel.



- 3 Press ⑯ **SCENE 1**.
“DVD Viewing” appears in the front panel display, and this unit automatically optimize own status for the DVD playback.

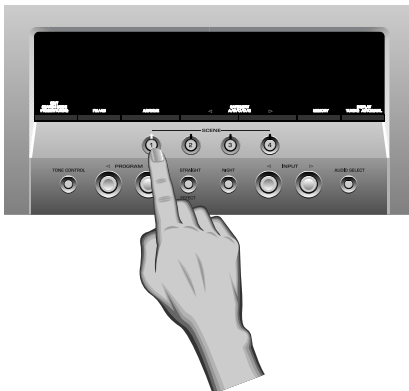

The indicator on the selected SCENE button lights up while this unit is in the SCENE mode.

- 4 Start playback of the desired DVD on your player.

- 5 Rotate ⑧ **VOLUME** to adjust the volume.



Note

When you change the input source or sound field program, the SCENE mode is deactivated and the indicator on the SCENE button turns off.

■ Using the other SCENE buttons

In the following cases, try pressing the corresponding SCENE button to enjoy playback of the desired sources.

Case A: “I want to listen to a music disc from the connected DVD player as the back ground music for this room...”

➔ Press ⑯ **SCENE 2** (or ② **SCENE 2**) to select “Disc Listening”.

Case B: “I want to watch a TV program...”

➔ Press ⑯ **SCENE 3** (or ③ **SCENE 3**) to select “TV Viewing”.

Note

To use the “TV Viewing” template, you must connect a cable TV or satellite tuner to this unit in advance. See page 15 for details.

Case C: “I want to listen to a music program from the FM radio station...”

- ➔ Press **Ⓜ SCENE 4** (or **Ⓜ SCENE 4**) to select “Radio Listening”.

Notes

- To use the “Radio Listening” template, you must tune into the desired radio station in advance. See pages 34 to 36 for tuning information.
- To achieve the best possible reception, orient the connected AM loop antenna, or adjust the position of the end of the indoor FM antenna.



If you cannot find the desired situation, you can select and change the assigned SCENE template for the SCENE buttons. See page 23 for details.

■ After using this unit...

Press **Ⓜ STANDBY/ON** on the front panel to set this unit to the standby mode.



This unit is set to the standby mode. In the standby mode, this unit consumes a small amount of power in order to receive infrared signals from the remote control. To turn on this unit from the standby mode, press **Ⓜ STANDBY/ON** (or **Ⓜ POWER**) on the front panel. See page 18 for details.

Note

In the standby mode, this unit consumes a small amount of power in order to receive infrared signals from the remote control.

What do you want to do with this unit?

■ Customizing the SCENE templates

- Using various SCENE templates

➔ P. 23

■ Using various input sources

- Basic controls of this unit

➔ P. 27

- Enjoying FM/AM radio programs

➔ P. 34

- Enjoying XM Satellite Radio programs

➔ P. 37

■ Using various sound features

- Using various sound field programs

➔ P. 31

■ Adjusting the parameters of this unit

- Optimizing the speaker parameters for your listening room (BASIC SETUP)

➔ P. 21

- Manually adjusting various parameters of this unit

➔ P. 43

- Setting the remote control

➔ P. 51

- Adjusts the advanced parameters

➔ P. 55

■ Additional features

- Automatically turning off this unit

➔ P. 30

Connections

Rear panel

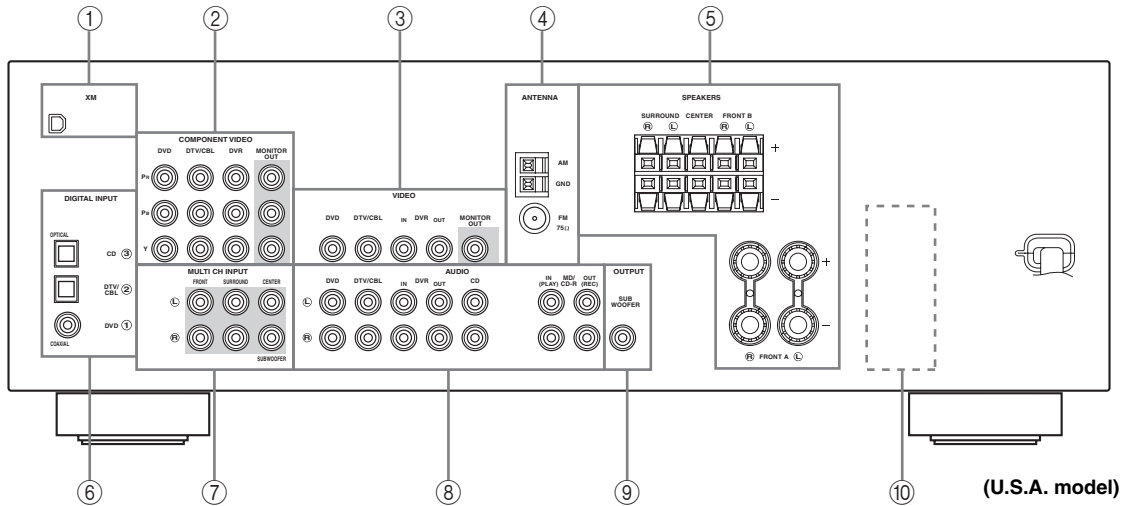

① XM jack (U.S.A. and Canada models only)

See page 37 for connection information.

② COMPONENT VIDEO jacks

See page 16 for connection information.

③ VIDEO jacks

See pages 15 for connection information.

④ ANTENNA terminals

See page 18 for connection information.

⑤ SPEAKERS terminals

See page 12 for connection information.

⑥ DIGITAL INPUT jacks

See page 17 for connection information.

⑦ MULTI CH INPUT jacks

See page 17 for connection information.

⑧ AUDIO jacks

See pages 15 and 17 for connection information.

⑨ SUBWOOFER OUTPUT jack

See page 12 for connection information.

⑩ VOLTAGE SELECTOR (Asia and General models only)

See page 3 for details.

Placing speakers

The speaker layout below shows the speaker setting we recommend. You can use it to enjoy CINEMA DSP and multi-channel audio sources.

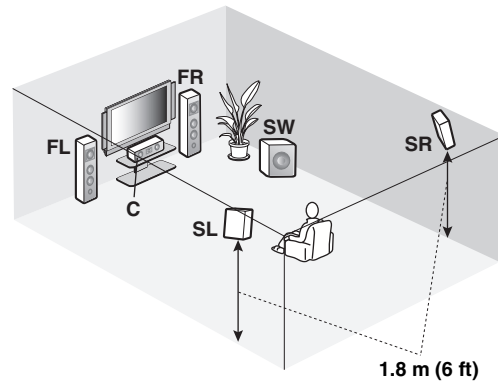
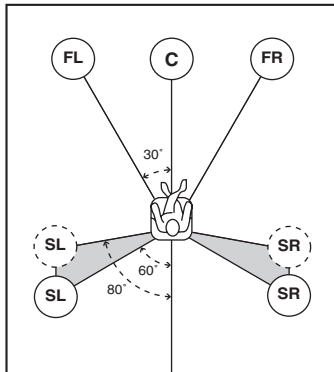

Front left and right speakers (FL and FR)

The front speakers are used for the main source sound plus effect sounds. Place these speakers at an equal distance from the ideal listening position. The distance of each speaker from each side of the video monitor should be the same.

Center speaker (C)

The center speaker is for the center channel sounds (dialog, vocals, etc.). If for some reason it is not practical to use a center speaker, you can do without it. Best results, however, are obtained with the full system.

Surround left and right speakers (SL and SR)

The surround speakers are used for effect and surround sounds.

Subwoofer (SW)

The use of a subwoofer with a built-in amplifier, such as the Yamaha Active Servo Processing Subwoofer System, is effective not only for reinforcing bass frequencies from any or all channels, but also for high fidelity sound reproduction of the LFE (low-frequency effect) channel included in Dolby Digital and DTS sources. The position of the subwoofer is not so critical, because low bass sounds are not highly directional. But it is better to place the subwoofer near the front speakers. Turn it slightly toward the center of the room to reduce wall reflections.

Connecting speakers

Be sure to connect the left channel (L), right channel (R), “+” (red) and “-” (black) properly. If the connections are faulty, this unit cannot reproduce the input sources accurately.

Caution

- Use speakers with the specified impedance shown on the rear panel of this unit.
- If you are to use 6 ohm speakers, be sure to set “SP IMP.” to “6Ω MIN” before using this unit (see page 13).
- Before connecting the speakers, make sure that this unit is turned off.
- Do not let the bare speaker wires touch each other or let them touch any metal part of this unit. This could damage this unit and/or speakers.
- Use magnetically shielded speakers. If this type of speakers still creates the interference with the monitor, place the speakers away from the monitor.

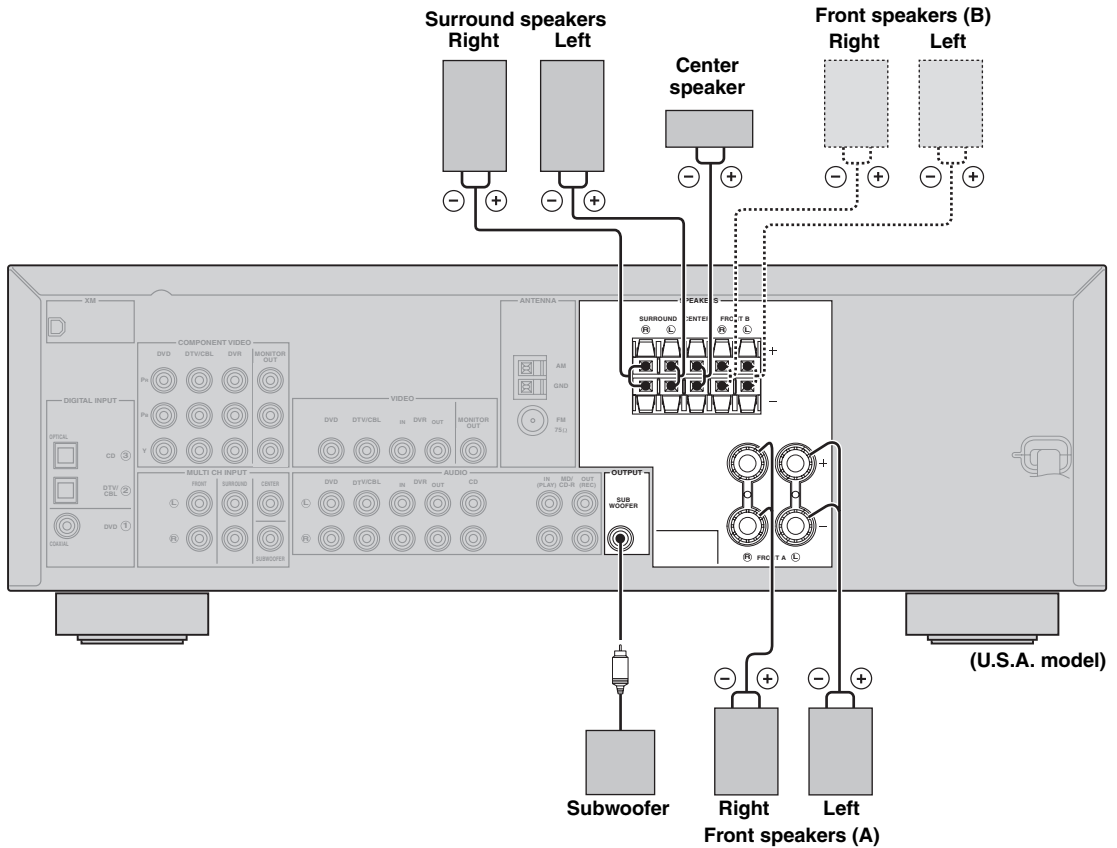

■ Before connecting to the SPEAKERS terminal

A speaker cord is actually a pair of insulated cables running side by side. Cables are colored or shaped differently, perhaps with a stripe, groove or ridges. Connect the striped (grooved, etc.) cable to the “+” (red) terminals of this unit and your speaker. Connect the plain cable to the “-” (black) terminals.

Remove approximately 10 mm (3/8”) of insulation from the end of each speaker cable and then twist the bare wires of the cable together to prevent short circuits.

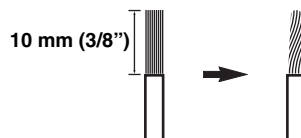

■ Connecting to the FRONT A terminals

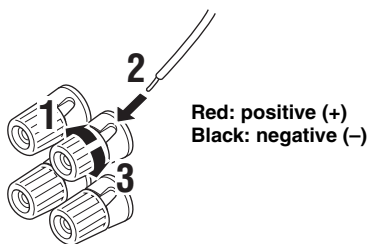

- 1 Loosen the knob.
- 2 Insert the bare end of the speaker wire into the hole on the terminal.
- 3 Tighten the knob to secure the wire.

Connecting the banana plug (except Europe, Korea and Asia models)

The banana plug is a single-pole electrical connector widely used to terminate speaker cables. First, tighten the knob and then insert the banana plug connector into the end of the corresponding terminal.

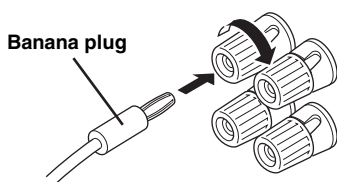

■ Connecting to the FRONT B, CENTER, and SURROUND terminals

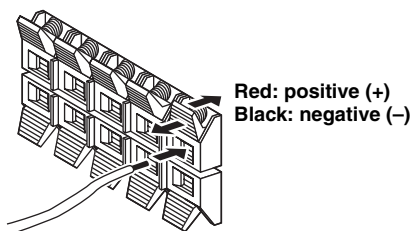

- 1 Press down the tab.
- 2 Insert the bare end of the speaker wire into the hole on the terminal.
- 3 Release the tab to secure the wire.

Setting the speaker impedance (U.S.A. and Canada models only)

Caution

If you are to use 6 ohm speakers, set "SP IMP." to "6Ω MIN" as follows BEFORE using this unit.

- 1 **Make sure this unit is turned off.**
See page 18 for details about turning on or off this unit.
- 2 **Press and hold ⑩ TONE CONTROL and then press ① STANDBY/ON to turn on this unit.**
This unit turns on, and the advanced setup menu appears in the front panel display.
- 3 **Press ① PROGRAM </> repeatedly to select "SP IMP.".**
The following display appears in the front panel display.

SP IMP.- 8ΩMIN

- 4 **Press ⑫ STRAIGHT repeatedly to select "6Ω MIN".**
The following display appears in the front panel display.
- 5 **Press ① STANDBY/ON to confirm your selection and set this unit to the standby mode.**

Note

The setting you made is reflected next time you turn on this unit.

Information on jacks and cable plugs

Audio jacks and cable plugs

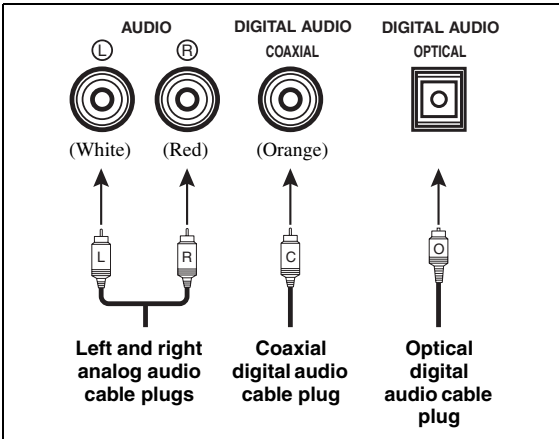

Video jacks and cable plugs

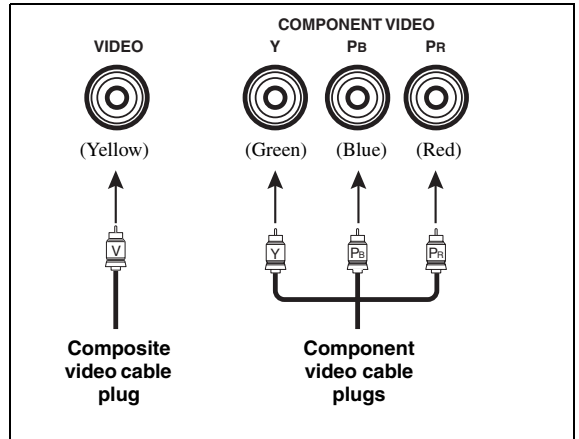

■ Audio jacks

This unit has three types of audio jacks. Connection depends on the availability of audio jacks on your other components.

AUDIO jacks

For conventional analog audio signals transmitted via left and right analog audio cables. Connect red plugs to the right jacks and white plugs to the left jacks.

DIGITAL AUDIO COAXIAL jacks

For digital audio signals transmitted via coaxial digital audio cables.

DIGITAL AUDIO OPTICAL jacks

For digital audio signals transmitted via optical digital audio cables.

Notes

- You can use the digital jacks to input PCM, Dolby Digital and DTS bitstreams. All digital input jacks are compatible with digital signals with up to 96 kHz of sampling frequency.
- This unit handles digital and analog signals independently. Thus audio signals input at the digital jacks are not output at the analog AUDIO OUT (REC) jacks.
- Pull out the cap from the optical jack before you connect the fiber optic cable. Do not discard the cap. When you are not using the optical jack, be sure to put the cap back in place. This cap protects the jack from dust.



■ Video jacks

This unit has two types of video jacks. Connection depends on the availability of input jacks on your video monitor.

VIDEO jacks

For conventional composite video signals transmitted via composite video cables.

COMPONENT VIDEO jacks

For component signals, separated into the luminance (Y) and chrominance (PB, PR) video signals transmitted on separate wires of component video cables.

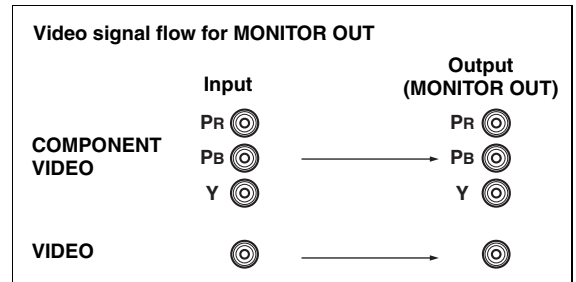

Connecting video components

Connect the video components as follows.



You can also connect a video monitor, DVD player, digital TV, and cable TV to this unit using the COMPONENT VIDEO connection (see page 16).



Make sure that this unit and other components are unplugged from the AC wall outlets.

■ Connecting a video monitor and a DVD player

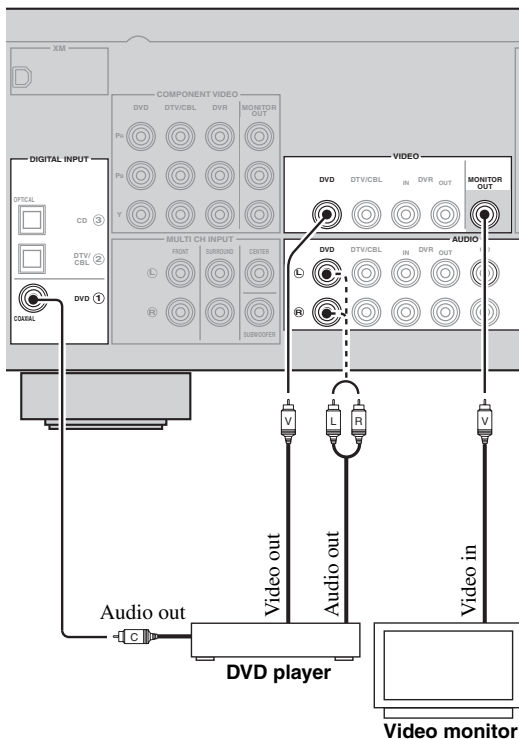

———— indicates recommended connections

- - - - - indicates alternative connections

■ Connecting a cable TV/satellite tuner and a DVD recorder

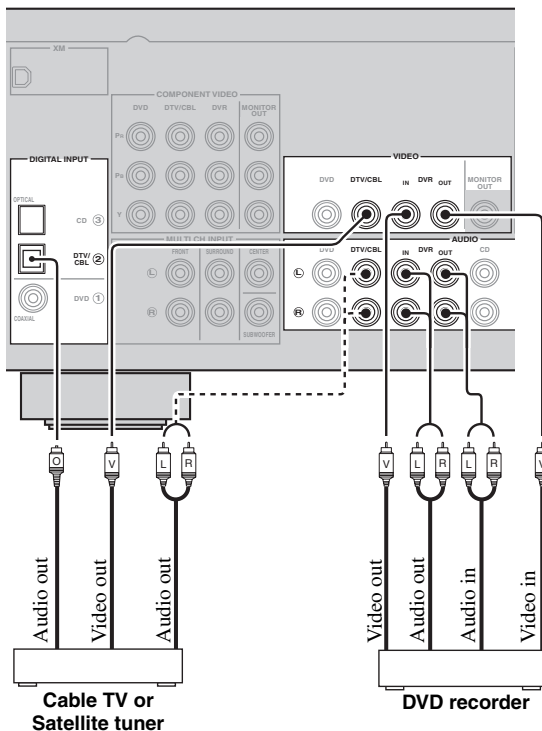

———— indicates recommended connections

- - - - - indicates alternative connections

PREPARATION

English

■ Connecting to the COMPONENT VIDEO jacks

You can enjoy high-quality pictures by connecting your video monitor and video source components to this unit using COMPONENT VIDEO connection.

Note

Be sure to connect your video source components in the same way you connect your video monitor to this unit. For example, if you connect your video monitor to this unit using a COMPONENT VIDEO connection, connect your video source components to this unit using the COMPONENT VIDEO connection.

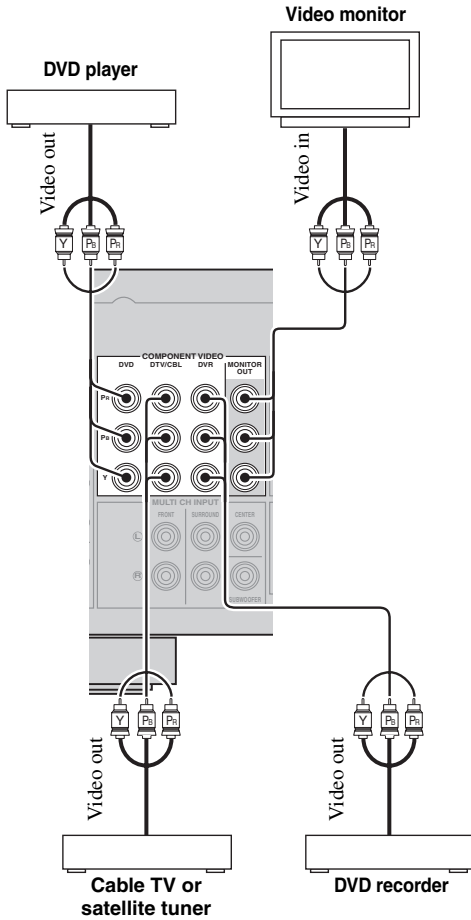

■ Connecting to the VIDEO AUX jacks on the front panel

Use the VIDEO AUX jacks on the front panel to connect a game console or a video camera to this unit.

Caution

Be sure to turn down the volume of this unit and other components before making connections.

Notes

- To reproduce the source signals input at these jacks, select "V-AUX" as the input source.
- The audio signals input at the PORTABLE mini jack take priority over the ones input at the AUDIO L/R jacks.

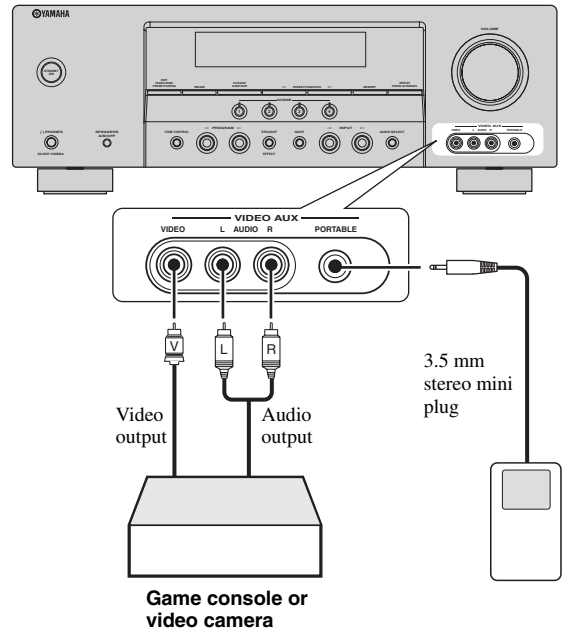

Connecting audio components

Connect the audio components as follows.

■ Connecting a CD player and a CD recorder/MD recorder

Note

When you connect your CD player via analog and digital connection, priority is given to the signal input at the DIGITAL INPUT jack.



Make sure that this unit and other components are unplugged from the AC wall outlets.

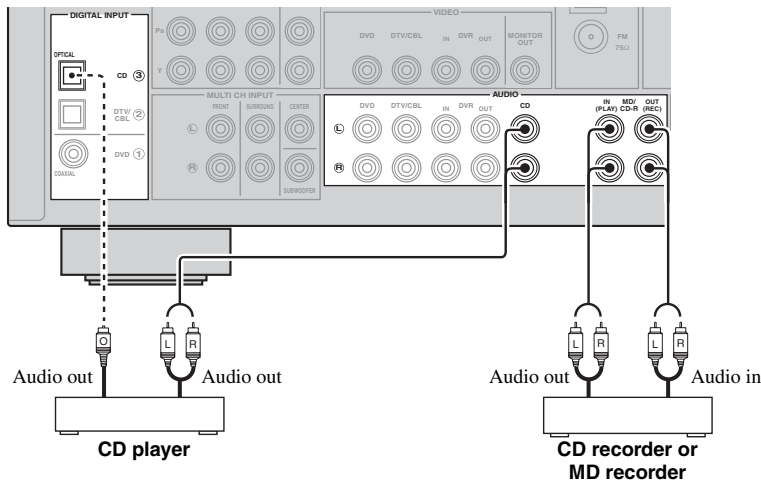

———— indicates recommended connections
 - - - - - indicates alternative connections

■ Connecting to the MULTI CH INPUT jacks

This unit is equipped with 6 additional input jacks (FRONT L/R, SURROUND L/R, CENTER and SUBWOOFER) for discrete multi-channel input from a multi-format player, external decoder or sound processor. Connect the output jacks on your multi-format player or external decoder to the MULTI CH INPUT jacks. Be sure to match the left and right output jacks to the left and right input jacks for the front and surround channels.

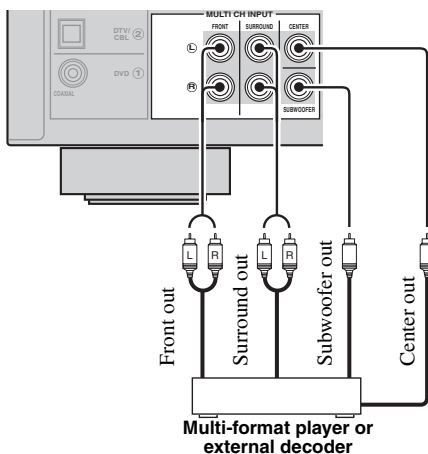

Notes

- When you select the component connected to the MULTI CH INPUT jacks as the input source (see page 28), this unit automatically turns off the digital sound field processor, and you cannot select sound field programs.
- This unit does not redirect signals input at the MULTI CH INPUT jacks to accommodate for missing speakers. We recommend that you connect a 5.1-channel speaker system before using this feature.

Connecting the FM and AM antennas

Both FM and AM indoor antennas are supplied with this unit. In general, these antennas should provide sufficient signal strength. Connect each antenna correctly to the designated terminals.

Notes

- The AM loop antenna should be placed away from this unit.
- A properly installed outdoor antenna provides clearer reception than an indoor one. If you experience poor reception quality, install an outdoor antenna. Consult the nearest authorized Yamaha dealer or service center about outdoor antennas.
- The AM loop antenna should always be connected, even if an outdoor AM antenna is connected to this unit.

Outdoor AM antenna

Use a 5 to 10 m (16 to 32 ft) of vinyl-covered wire extended outdoors from a window.

AM loop antenna (supplied)

Indoor FM antenna (supplied)

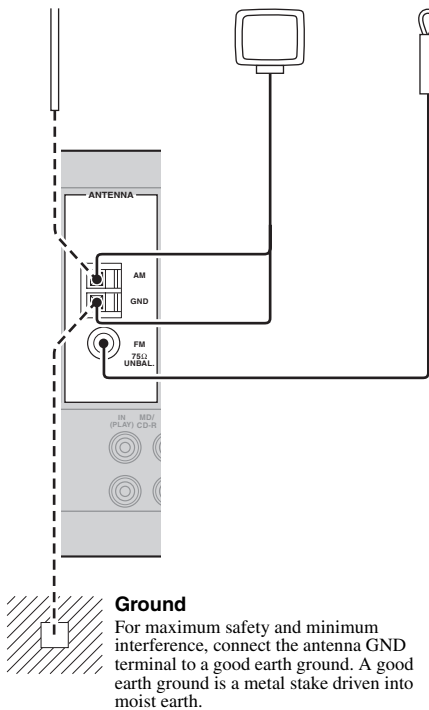

Connecting the power cable

Once all connections are complete, plug the power cable into the AC wall outlet.

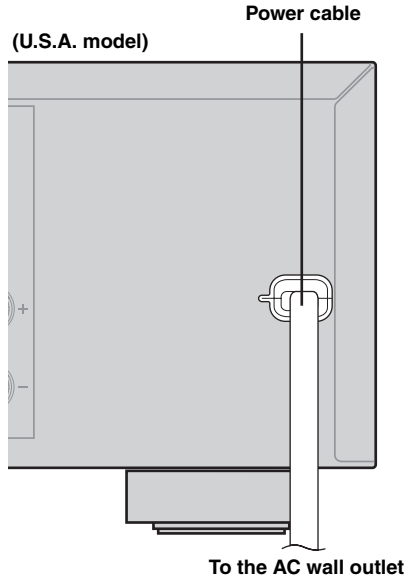

Turning on and off the power

■ Turning on this unit

Press **Ⓛ** **STANDBY/ON** (or **Ⓛ** **POWER**) to turn on this unit.



When you turn on this unit, there will be a 4 to 5-second delay before this unit can reproduce sound.

■ Set this unit to the standby mode

Press **Ⓜ** **STANDBY/ON** (or **Ⓜ** **STANDBY**) to set this unit to the standby mode.

In the standby mode, this unit consumes a small amount of power in order to receive infrared signals from the remote control.

Front panel display

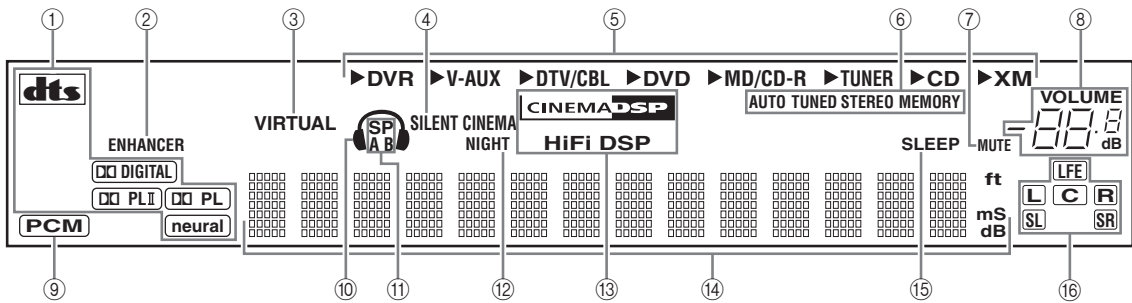

① Decoder indicator

Lights up when any of the decoders of this unit functions.

② ENHANCER indicator

Lights up when the Compressed Music Enhancer mode is selected (see page 31).

③ VIRTUAL indicator

Lights up when Virtual CINEMA DSP is active (see page 33).

④ SILENT CINEMA indicator

Lights up when headphones are connected and a sound field program is selected (see page 33).

⑤ Input source indicators

The corresponding cursor lights up to show the currently selected input source.

⑥ Tuner indicators

Lights up when this unit is in the FM, AM or XM Satellite Radio tuning mode (see pages 34 and 37).

⑦ MUTE indicator

Flashes while the MUTE function is on (see page 28).

⑧ VOLUME level indicator

Indicates the current volume level.

⑨ PCM indicator

Lights up when this unit is reproducing PCM (Pulse Code Modulation) digital audio signals.

⑩ Headphones indicator

Lights up when headphones are connected (see page 28).

⑪ SP A B indicators

Light up according to the set of front speakers selected (see page 27).

⑫ NIGHT indicator

Lights up when you select a night listening mode (see page 28).

⑬ CINEMA DSP indicator

Lights up when you select a CINEMA DSP sound field program (see page 31).

HiFi DSP indicator

Lights up when you select a HiFi DSP sound field program (see page 31).

⑭ Multi-information display

Shows the name of the current sound field program and other information when adjusting or changing settings.

⑮ SLEEP indicator

Lights up while the sleep timer is on (see page 30).

⑯ Input channel and speaker indicators

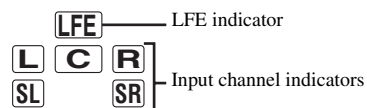

LFE indicator

Lights up when the input signal contains the LFE signal.

Input channel indicators

Indicate the channel components of the current digital input signal.

■ Using the remote control

The remote control transmits a directional infrared ray. Be sure to aim the remote control directly at the remote control sensor on this unit during operation.

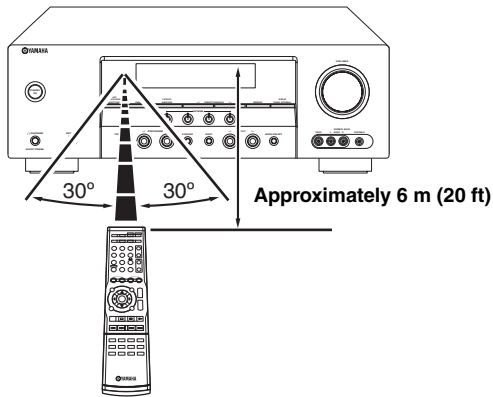

⊗ Infrared window

Outputs infrared control signals. Aim this window at the component you want to operate.



To set the remote control codes for other components, see page 54.

Notes

- Do not spill water or other liquids on the remote control.
- Do not drop the remote control.
- Do not leave or store the remote control in the following types of conditions:
 - places of high humidity, such as near a bath
 - places of high temperature, such as near a heater or stove
 - places of extremely low temperatures
 - dusty places

Basic setup

The “BASIC SETUP” feature is a useful way to set up your system quickly and with minimal effort.

Notes

- Make sure you disconnect your headphones from this unit.
- If you wish to configure this unit manually using more precise adjustments, use the detailed parameters in “SOUND MENU” (see page 45).
- Altering any parameters in “BASIC SETUP” resets all parameters manually adjusted in “SOUND MENU” (see page 45).
- Initial settings are indicated in bold under each parameter.
- Press **⏪** **RETURN** on the remote control to return to the previous menu level.

1 Press **⏪ AMP on the remote control.**

2 Press **⏪ MENU.**

“BASIC SETUP” appears in the front panel display.

• BASIC SETUP

3 Press **⏪ ENTER to enter “BASIC SETUP”.**

“ROOM” appears in the front panel display.

ROOM: S >M L

4 Press **⏪ </> to select the desired setting.**

Select the size of the room where you have installed your speakers. In general, the room sizes are defined as follows:

Choices: S, M, L

[U.S.A. and Canada models]

S (small) 16 x 13 ft, 200 ft² (4.8 x 4.0 m, 20 m²)

M (medium) 20 x 16 ft, 300 ft² (6.3 x 5.0 m, 30 m²)

L (large) 26 x 19 ft, 450 ft² (7.9 x 5.8 m, 45 m²)

[Other models]

S (small) 3.6 x 2.8 m, 10 m²

M (medium) 4.8 x 4.0 m, 20 m²

L (large) 6.3 x 5.0 m, 30 m²

5 Press **⏪ ▽ to select “SUBWOOFER” and then **⏪** </> to select the desired setting.**















SUBWOOFER • YES

Choices: YES, NONE

- Select “YES” if you have a subwoofer in your system.
- Select “NONE” if you do not have a subwoofer in your system.

6 Press **⏪ ▽ to select “SPEAKERS” and then **⏪** </> to select the number of speakers connected to this unit.**

SPEAKERS • 5spk

Choice	Display	Speakers
2spk	 	Front L/R
3spk	  	Front L/R, Center
4spk	   	Front L/R, Surround L/R
5spk	    	Front L/R, Center, Surround L/R

- 7** Press **Ⓞ** **∇** to select “SET” and then **Ⓞ** **◀/▶** to select the desired setting.

SET >CANCEL

Choices: SET, **CANCEL**

- Select “SET” to apply the settings you made.
- Select “CANCEL” to cancel the setup procedure without making any changes.



You can also press **Ⓟ** **MENU** to cancel the setup procedure.

- 8** Press **Ⓞ** **ENTER** to confirm your selection.

If you selected “SET” in step 7, each speaker outputs a test tone twice in turn. “CHECK:TestTone” appears in the front panel display for a few seconds and then “CHECK OK?” appears in the front panel display.

CHECK:TestTone



- Check the speaker connections (see page 5) and adjust the “SPEAKERS” settings back in step 6, if necessary.
- The indicator of the speaker currently outputting the test tone flashes in the front panel display.

- 9** Press **Ⓞ** **◀/▶** to select the desired setting.

CHECK OK? . . YES

Choices: **YES**, NO

- Select “YES” to complete the setup procedure if the test tone levels from each speaker were satisfactory.
- Select “NO” to proceed to the speaker level adjustment menu to balance the output level of each speaker.

- 10** Press **Ⓞ** **ENTER** to confirm your selection.

- If you selected “YES” in step 9, the setup procedure is completed and the display returns to the top set menu display.
- If you selected “NO” in step 9, the front speaker level adjustment display appears in the front panel display.

- 11** Press **Ⓞ** **△/▽** to select a speaker and then **Ⓞ** **◀/▶** to adjust the balance.

The selected speaker and the front left speaker (or the surround left speaker) output a test tone in turn.

- Press **▶** to increase the value.
- Press **◀** to decrease the value.

FR -----||-----

- Select “FR” to adjust the balance between the front left and right speakers.
- Select “C” to adjust the balance between the front left and center speakers.
- Select “SL” to adjust the balance between the front left and surround left speakers.
- Select “SR” to adjust the balance between the surround left and surround right speakers.
- Select “SW” to adjust the balance between the front left speaker and the subwoofer.

Note

The available speaker channels differ depending on the setting of the speakers.

- 12** Press **Ⓟ** **MENU** to exit from “BASIC SETUP”.

Selecting the SCENE templates

This unit is equipped with 13 preset SCENE templates for various situations of using this unit. As the initial factory setting, the following SCENE templates are assigned to each SCENE button:

- SCENE 1:** DVD Viewing
- SCENE 2:** Disc Listening
- SCENE 3:** TV Viewing
- SCENE 4:** Radio Listening

If you want to use other SCENE templates, you can select the desired SCENE templates from the SCENE template library and assign the templates to the selected SCENE buttons on the front panel and the remote control.

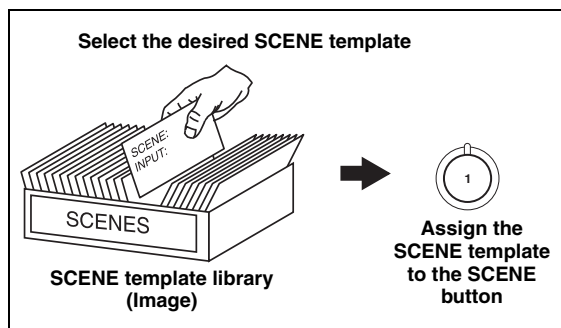

Selecting the desired SCENE template

- 1 Press and hold the desired **16 SCENE** (or **ENTER SCENE**) button for 3 seconds.

The indicator on the selected SCENE button on the front panel starts to flash, and the name of currently assigned SCENE template appears in the front panel display.

3 seconds



or

3 seconds



Flashes

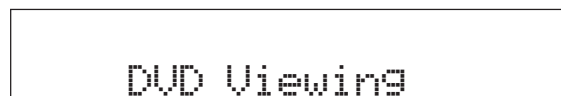

- 2 Press **14 INPUT** $\triangleleft/\triangleright$ (or press **ENTER** and then **16** $\triangleleft/\triangleright$) to select the desired template.

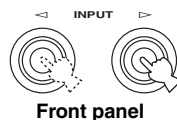

Front panel

or

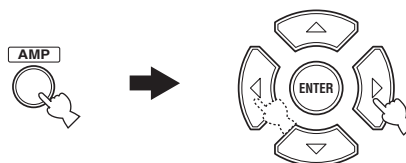

Remote control



- 3 Press the **16 SCENE** (or **ENTER SCENE**) button again to confirm the selection.

The selected SCENE template is assigned to the button.



Front panel

or



Remote control

Notes

- If you do not carry out any operation within 30 seconds from the last operation in these steps, this procedure is automatically canceled.
- Once the desired SCENE templates are assigned to the corresponding SCENE buttons, you may need to set the input source of the SCENE template on the remote control. See page 51 for details.

■ Which SCENE template would you like to select?

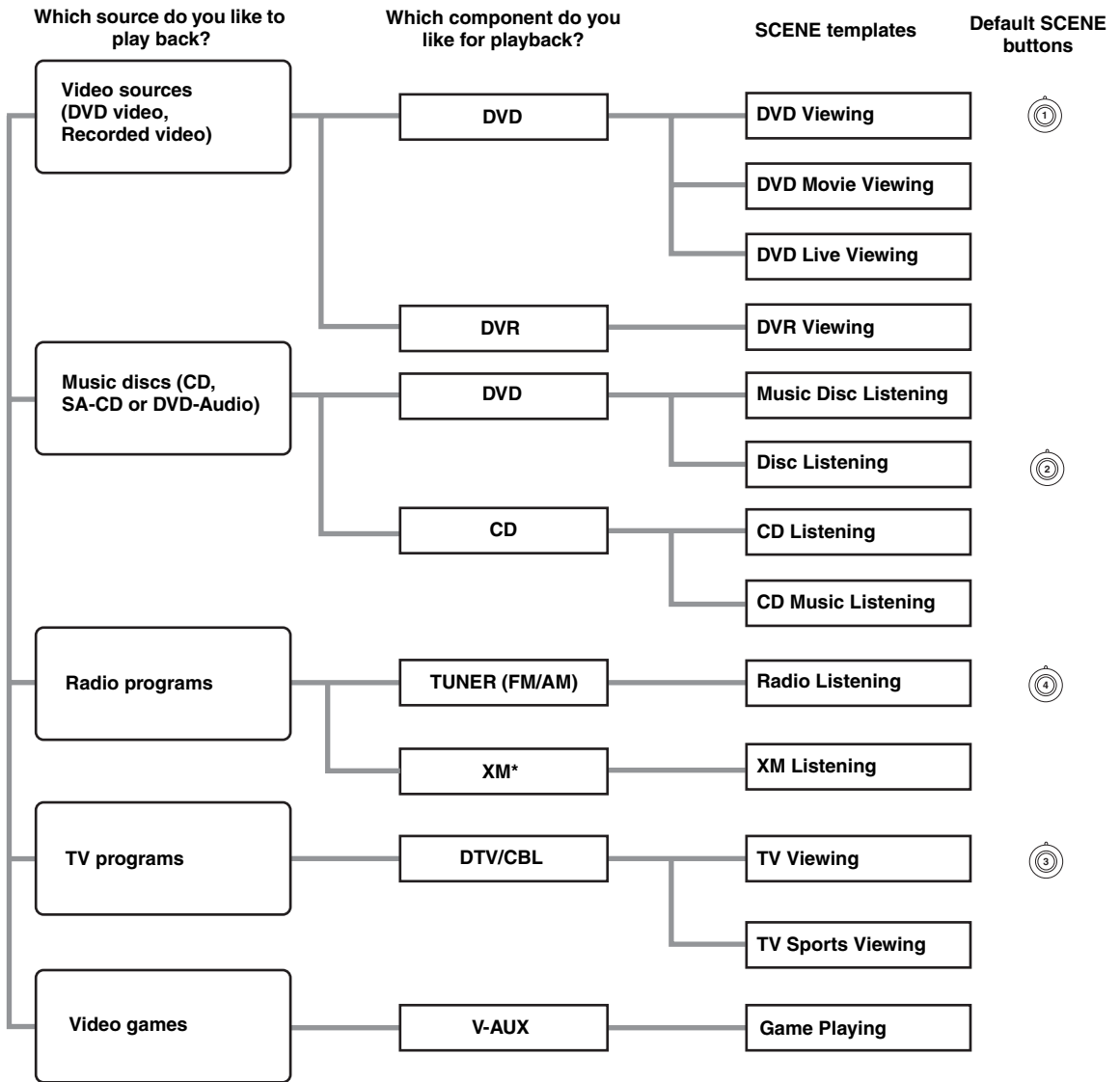

Note

* To enjoy XM Satellite Radio programs, you need to connect the XM Mini-Tuner Dock (sold separately) to this unit (see page 37).



You can create your original SCENE templates by editing the preset SCENE templates. See page 26 for details.

■ Preset SCENE template descriptions

SCENE template	
Features	
Input source	Playback mode

DVD Viewing (SCENE 1 as the default setting)	
Select this SCENE template when you play back general contents on your DVD player.	
DVD	STRAIGHT

DVD Movie Viewing	
Select this SCENE template when you play back movies on your DVD player.	
DVD	Movie Dramatic

DVD Live Viewing	
Select this SCENE template when you enjoy music live video on your DVD player.	
DVD	Pop/Rock

DVR Viewing	
Select this SCENE template when you play back movies on your digital video recorder.	
DVR	Movie Dramatic

Music Disc Listening	
Select this SCENE template when you play back music discs on your DVD player.	
DVD	2ch Stereo

Disc Listening (SCENE 2 as the default setting)	
Select this SCENE template when you play back music sources as the back ground music on your DVD player.	
DVD	5ch Stereo

CD Listening	
Select this SCENE template when you play back music discs on your CD player.	
CD	2ch Stereo

CD Music Listening	
Select this SCENE template when you play back music source as the back ground music on your CD player.	
CD	5ch Stereo

Radio Listening (SCENE 4 as the default setting)	
Select this SCENE template when you enjoy FM or AM radio programs.	
TUNER	MUSIC ENHANCER 5ch STEREO

XM Listening	
Select this SCENE template when you enjoy XM Satellite Radio programs.	
XM	MUSIC ENHANCER 5ch STEREO

TV Viewing (SCENE 3 as the default setting)	
Select this SCENE template when you enjoy TV programs.	
DTV/CBL	STRAIGHT

TV Sports Viewing	
Select this SCENE template when you enjoy sports programs on TV.	
DTV/CBL	TV Sports

Game Playing	
Select this SCENE template when you play video games.	
V-AUX	Game

Creating your original SCENE templates

You can create your original SCENE templates for each SCENE button. You can refer to the preset 13 SCENE templates to create the original SCENE templates.

■ Customizing the preset SCENE templates

Use this feature to customize the preset SCENE templates.

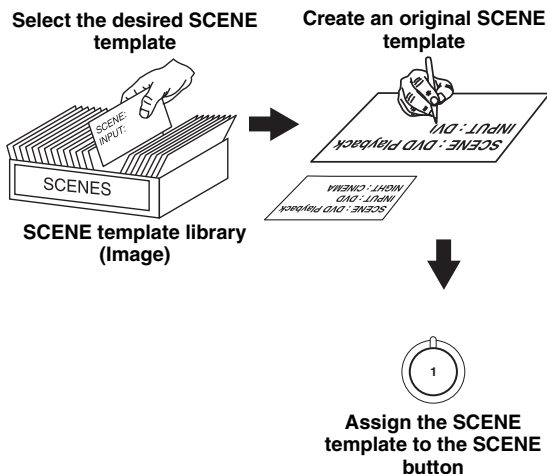

1 Press and hold the desired **SCENE** button for 3 seconds and then press **AMP**.

The SCENE template customizing screen appears on the front panel display.



Note

When the SCENE template you want to customize is not assigned to any of the **SCENE** button, press **SCENE**, press **SCENE** repeatedly to recall the desired SCENE template (see page 23).

2 Press **SCENE** / **SCENE** to select the desired parameter of the SCENE template and then **SCENE** / **SCENE** to select the desired value of the selected parameter.

You can adjust the following parameters for a SCENE template:

- The input source component
- The active sound field programs or STRAIGHT mode
- The night listening mode setting (see page 28)
 - SYSTEM: Keeps the current night listening mode.
 - CINEMA: Sets the night listening mode to the CINEMA mode.
 - MUSIC: Sets the night listening mode to the MUSIC mode.

3 Press the **SCENE** button again to confirm the edit.



An asterisk mark (*) appears by the name of the original SCENE template.

Notes

- After changing the assignment of the SCENE template to the **SCENE** buttons, you may need to set the input source of the SCENE template on the remote control. See page 51 for details.
- You can create a customized SCENE template for each **SCENE** button, and if you create another customized SCENE template, this unit overwrites the old customized SCENE template with the new one.
- The customized SCENE template is only available for the assigned **SCENE** button.

Playback

Caution

Extreme caution should be exercised when you play back CDs encoded in DTS. If you play back a CD encoded in DTS on a DTS-incompatible CD player, you will only hear some unwanted noise that may damage your speakers. Check whether your CD player supports CDs encoded in DTS. Also, check the sound output level of your CD player before you play back a CD encoded in DTS.

Basic operations

1 Turn on the video monitor connected to this unit.

2 Press ⑨ SPEAKERS repeatedly to select the front speakers you want to use.

The respective speaker indicators lights up in the front panel display.

3 Press ⑭ INPUT </> repeatedly (or press one of the input selector buttons (C)) to select the desired input source.

The name of the currently selected input source appears in the front panel display for a few seconds.

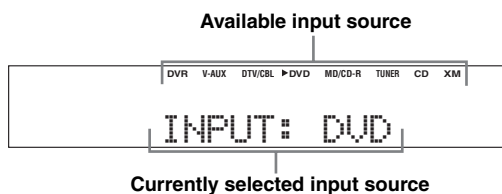

Currently selected input source

4 Start playback on the selected component or select a broadcast station.

- Refer to the operating instructions for the source component.
- See page 34 for details about FM/AM tuning instructions.
- See page 37 for details about XM Satellite Radio tuning instructions.

5 Rotate ⑧ VOLUME (or press ③ VOLUME +/-) to adjust the volume to the desired output level.

6 Press ⑪ PROGRAM </> (or press ② AMP and then press ① PROG </>) repeatedly to select the desired sound field program.

The name of the selected sound field program appears in the front panel display.

See page 31 for details about sound field programs.



Notes

- Choose a sound field program based on your listening preference, not merely on the name of the program.
- When you select an input source, this unit automatically selects the last sound field program used with the corresponding input source.
- Sound field programs cannot be selected when the component connected to the MULTI CH INPUT jacks is selected as the input source (see page 28).
- When PCM signals with a sampling frequency higher than 48 kHz are input, this unit is automatically set to the "STRAIGHT" mode (see page 33).
- To display information about the currently selected input source in the front panel display, see page 30 for details.

Guide to contents

When you want to...	See page
Adjust the tonal quality of the front speakers	29
Edit parameters of sound field programs	32
Enjoy the sources which have wide dynamic range at night	28
Use headphones	28
Select a decoder to play back sources with	32
Set this unit to the standby mode automatically	30

Additional operations

■ Using your headphones

Connect a pair of headphones with a stereo analog audio cable plug to the PHONES jack on the front panel.

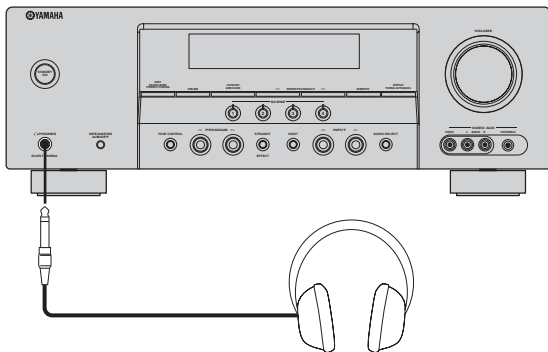

When you select a sound field program, SILENT CINEMA mode activates automatically (see page 33).

Notes

- When you connect headphones, no signals are output at the speaker terminals.
- All Dolby Digital and DTS audio signals are mixed down to the left and right headphone channels.

■ Muting the audio output

Press **(N) MUTE** to mute the audio output.

Press **(N) MUTE** again to resume the audio output.



- You can also rotate **(B) VOLUME** (or press **(Q) VOLUME +/-**) to resume the audio output.
- You can adjust the muting level by using "MUTE TYP." in "SOUND MENU" (see page 48).
- The MUTE indicator flashes in the front panel display when the audio output is muted and disappears from the front panel display when the audio output is resumed.

■ Selecting the component connected to the MULTI CH INPUT jacks as the input source

Use this feature to select the component connected to the MULTI CH INPUT jacks (see page 17) as the input source.

Press **(14) INPUT** **(</>)** repeatedly (or press **(A) MULTI CH IN**) so that "MULTI CH" appears in the front panel display.



Use "MULTI CH SET" menu in "INPUT MENU" to set the parameter for MULTI CH INPUT (see page 49).

Notes

- Sound field programs mode cannot be selected when the component connected to the MULTI CH INPUT jacks is selected as the input source.
- When headphones are used, signals are output only from the front left and right channels.

■ Selecting the night listening mode

The night listening modes are designed to improve listenability at lower volumes or at night.

1 Press **(D) AMP** and then press **(K) NIGHT** repeatedly to select "NIGHT:CINEMA" or "NIGHT:MUSIC".

Choices: NIGHT:CINEMA, NIGHT:MUSIC, NIGHT OFF

- Select "NIGHT:CINEMA" to reduce the dynamic range of film soundtracks and make dialog easier to hear at lower volumes.
- Select "NIGHT:MUSIC" to preserve ease-of-listening for all sounds.
- Select "NIGHT OFF" if you do not want to use this feature.



When a night listening mode is selected, the NIGHT indicator lights up in the front panel display.

2 Press **Ⓞ** </> to adjust the effect level while “NIGHT:CINEMA” or “NIGHT:MUSIC” is displayed in the front panel display.

Choices: MIN, MID, MAX

- Select “MIN” for minimum compression.
- Select “MID” for standard compression.
- Select “MAX” for maximum compression.



“NIGHT:CINEMA” and “NIGHT:MUSIC” adjustments are stored independently.

Notes

- You cannot use the night listening modes in the following cases:
 - when the component connected to the MULTI CH INPUT jacks is selected as the input source.
 - when headphones are connected to the PHONES jack.
- The night listening modes may vary in effectiveness depending on the input source and surround sound settings you use.

■ Selecting audio input jacks (AUDIO SELECT)

This unit comes with a variety of input jacks. Use this feature (audio input jack select) to switch the input jack assigned to an input source when more than one jacks are assigned to an input source.



- We recommend setting audio input jack select to “AUTO” in most cases.
- You can adjust the default audio input jack select of this unit by using “AUDIO SELECT” in “OPTION MENU” (see page 50).

Press **Ⓟ** **AUDIO SELECT** (or **Ⓟ** **AUDIO SEL**) repeatedly to select the desired Audio input jack select setting.



Audio input jack select setting

- AUTO** Automatically selects input signals in the following order:
- (1) Digital signals
 - (2) Analog signals
- ANALOG** Selects only analog signals. If no analog signals are input, no sound is output.

Note

This feature is not available when no digital input jack are assigned to the currently selected input source.

■ Adjusting the tonal quality

Use this feature to adjust the balance of bass and treble for the front left and right speaker channels.

Press **Ⓟ** **TONE CONTROL** repeatedly to select “BASS” or “TREBLE” and then press **Ⓟ** **PROGRAM** </> to adjust the corresponding frequency response level.

- Select “BASS” to adjust the low-frequency response.
- Select “TREBLE” to adjust the high-frequency response.

Notes

- Speaker and headphone adjustments are stored independently.
- If you increase or decrease the high-frequency or low-frequency sound to an extreme level, the tonal quality of the surround speakers may not match that of the front left and right speakers.

■ Adjusting speaker levels during playback

You can adjust the output level of each speaker while listening to a music source.

Note

This operation will override the level adjustment made in “SP LEVEL” (see page 46).

1 Press **Ⓟ** **AMP** and then press **Ⓟ** **LEVEL** repeatedly to select the speaker you want to adjust.

Display	Adjusted speaker
FRONT L	Front left speaker
FRONT R	Front right speaker
CENTER	Center speaker
SUR. L	Surround left speaker
SUR. R	Surround right speaker
SWFR	Subwoofer



Once you press **Ⓟ** **LEVEL** on the remote control, you can also select the speaker by pressing **Ⓞ** </>.

2 Press **Ⓞ** </> on the remote control to adjust the speaker output level.

The control range is from -10 dB to +10 dB.



You can press **Ⓞ** **A/B/C/D/E** to select a speaker and then **Ⓟ** **PRESET/TUNING/CH** </> to adjust the speaker output level.

■ Displaying the signal information

You can display the format, sampling frequency, channel, bit rate and flag data of the current input signal.

1 Press Ⓚ AMP and then press Ⓜ MENU on the remote control.

“BASIC SETUP” appears in the front panel display.

▪ BASIC SETUP

2 Press Ⓜ / Ⓜ repeatedly to select “SIGNAL INFO” and then press Ⓚ ENTER.

3 Press Ⓜ / Ⓜ to switch the displayed information.

The following information about the input source appears in the front panel display.

Display	Description
FORMAT	Signal format.
SAMPL.	The number of samples per second taken from a continuous signal to make a discrete signal.
CH	The number of source channels in the input signal (front/surround/LFE).
B. RATE	The number of bits passing a given point per second.
FLAG	Flag data encoded in DTS, Dolby Digital, or PCM signals that cue this unit to automatically switch decoders.

4 Press Ⓜ MENU to exit.

■ Using the sleep timer

Use this feature to automatically set this unit to the standby mode after a certain amount of time.

Press Ⓚ AMP and then press Ⓜ SLEEP repeatedly to set the amount of time.

Each time you press Ⓜ SLEEP, the front panel display changes as shown below.

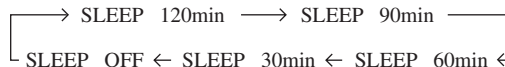

The SLEEP indicator flashes while you are switching the amount of time for the sleep timer. Once the sleep timer is set, the SLEEP indicator lights up in the front panel display, and the display returns to the selected sound field program.



- To cancel the sleep timer, press Ⓜ SLEEP on the remote control repeatedly until “SLEEP OFF” appears in the front panel display.
- You can also cancel the sleep timer setting by pressing Ⓚ STANDBY/ON (or Ⓜ STANDBY) to set this unit to the standby mode.

■ Playing video sources in the background

You can combine a video image from a video source with sound from an audio source. For example, you can enjoy listening to classical music while viewing beautiful scenery from the video source on the video monitor.

Press the input selector buttons on the remote control to select a video source and then an audio source.

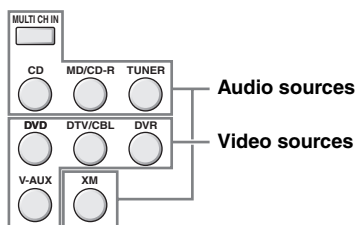

Sound field programs

This unit is equipped with a variety of precise digital decoders that allow you to enjoy multi-channel playback from almost any stereo or multi-channel sound source.

Press **Ⓜ PROGRAM** $\triangleleft/\triangleright$ (or press **Ⓜ AMP** and then press **Ⓜ PROG** $\triangleleft/\triangleright$ repeatedly).

The name of the selected sound field program appears in the front panel display.

Notes

- When you select an input source, this unit automatically selects the last sound field program used with the corresponding input source.

- Sound field programs cannot be selected when the component connected to the MULTI CH INPUT jacks is selected as the input source (see page 28).
- When PCM signals with a sampling frequency higher than 48 kHz are input, this unit is automatically set to the “STRAIGHT” mode (see page 33).



- Choose a sound field program based on your listening preference, not merely on the name of the program itself.
- You can select “Music Enh. 2ch” and “Music Enh. 5ch” by pressing **Ⓜ ENHANCER** on the remote control repeatedly.

Sound field program descriptions

Category	Program	Features
MUSIC	Pop/Rock	CINEMA DSP processing. This program presents an image of pop, rock, or jazz live concert. The sound field reproduces the spaciousness of a massive pavilion with an emphasis on the vividness of vocals on the stage and solo instruments and the beats of rhythm instruments.
	Hall	HiFi DSP processing. This sound field is suitable for classic and orchestral music. The program uses data collected in a large concert hall in Munich. You can enjoy delicate and beautiful reverberation and a majestic atmosphere.
	Jazz	HiFi DSP processing. The sound field is suitable for jazz and fusion music. It uses data collected in a famous jazz club in New York. You can enjoy clear reverberation.
ENTERTAIN	Game	CINEMA DSP processing. You can enjoy dynamic and thrilling sound effects as you play games. The program lets you feel the depth and three-dimensional surrounding sounds of the field where you are playing, and offers cinema-like surrounding sound effects for the scenes of movies.
	TV Sports	CINEMA DSP processing. You can enjoy sports relays broadcast in stereo and variety shows with a live sound environment. For sports relays, the voices of commentators and announcers come clearly from the center; the cheers and atmosphere in the stadium spread around within a comfortable range, and you can feel like as if you are in the stadium.
MOVIE	Movie Spacious	CINEMA DSP processing. The sound field is suitable for movies with an emphasis on spectacular sound effects, and is a perfect fit with a wide screen. The program reproduces a wide dynamic range from minimum sound effects to powerful sounds.
	Movie Dramatic	CINEMA DSP processing. This sound field is also suitable for movies with an emphasis on three-dimensional sound effects. It restrains reverberation to an moderate extent, but reproduces sound effects and background music in a soft, three-dimensional manner with clarity and center orientation of voices as pivots.
STEREO	2ch Stereo	Downmixes multi-channel sources to 2 channel or plays back 2-channel sources as they are.
	5ch Stereo	Using this program increases the listening position range. This is a sound field suitable for background music at parties.
ENHANCER	Music Enh. 2ch Music Enh. 5ch	Select these programs to play back compression artifacts (such as the MP3 format) in 2-channel or 5-channel stereo. This program enhances your listening experience by regenerating the missing harmonics in a compression artifact.

Note

The sound field programs of this unit are recreations of real-world acoustic environments made from precise measurements taken in the actual concert hall, music venue, movie theater, etc. Thus, you may notice variations in the strength of the reflections coming from the front, back, left and right.

■ **Selecting decoders for 2-channel sources (surround decode mode)**

Signals input from 2-channel sources can also be played back on multi-channels.

Press **Ⓧ AMP** and then press **Ⓨ SUR. DECODE** repeatedly to select a decoder.

You can select from the following decoders depending on the type of source you are playing and your personal preference.

STANDARD	Functions
PRO LOGIC	Dolby Pro Logic processing for any sources
PLII Movie	Dolby Pro Logic II processing for movie sources
PLII Music	Dolby Pro Logic II processing for music sources
PLII Game	Dolby Pro Logic II processing for game sources
Neural	Neural Surround processing for any sources

■ **Editing sound fields parameters**

You can enjoy good quality sound with the factory preset parameters. Although you do not have to change the initial settings, you can change some of the parameters to better suit the input source or your listening room.

1 While listening to a source, press **Ⓧ AMP** and then press **Ⓞ Δ / ▽** to select the desired parameter.

2 Press **Ⓞ ◀ / ▶** to change the parameter value.

Note

You cannot change parameter values when “MEM. GUARD” in “OPTION MENU” is set to “ON” (see page 50).



Initial settings are indicated in bold under each parameter.

For Pop/Rock, Hall, Jazz, Game, TV Sports, Movie Spacious and Movie Dramatic:

DSP level DSP LEVEL

Function: Adjusts the effect level.

Choices: **MIN, MID, MAX**

For PRO LOGIC II Music:

Panorama PANORAMA

Function: Sends stereo signals to the surround speakers as well as the front speakers for a wraparound effect.

Choices: **OFF, ON**

Dimension DIMENSION

Function: Gradually adjusts the sound field either towards the front or towards the rear.

Control range: -3 (towards the rear) to +3 (towards the front), initial setting is STD (standard).

Center width CT WIDTH

Function: Adjusts the center image from all three front speakers to varying degrees. A larger value adjusts the center image towards the front left and right speakers.

Control range: 0 (center channel sound is output only from center speaker) to 7 (center channel sound is output only from front left and right speakers), initial setting is 3.

For Music Enh. 2ch and Music Enh. 5ch

Effect level

Function: Adjusts the effect level.

Choices: **LOW, HIGH**

■ Using sound field programs without surround speakers (Virtual CINEMA DSP)

Virtual CINEMA DSP allows you to enjoy the CINEMA DSP programs without surround speakers by creating virtual speakers.

If you set "SUR. LR" to "NONE" (see page 45), Virtual CINEMA DSP activates automatically whenever you select a CINEMA DSP or HiFi DSP program (see page 31).

Note

Virtual CINEMA DSP will not activate even when "SUR. LR" is set to "NONE" (see page 45) in the following cases:

- when "5ch Stereo" (see page 31) is selected.
- when headphones are connected to the PHONES jack.

■ Enjoying multi-channel sources and sound field programs with headphones (SILENT CINEMA)

SILENT CINEMA allows you to enjoy multi-channel music or movie sound, including Dolby Digital and DTS sources, through ordinary headphones. SILENT CINEMA activates automatically whenever you connect headphones to the PHONES jack while listening to CINEMA DSP or HiFi DSP sound field programs (see page 31). When activated, the SILENT CINEMA indicator lights up in the front panel display.

Note

SILENT CINEMA does not activate when the component connected to the MULTI CH INPUT jacks is selected as the input source (see page 28).

■ Enjoying unprocessed input sources (Straight decoding mode)

When this unit is in the "STRAIGHT" mode, multi-channel sources are decoded straight into the appropriate channels without any additional effect processing. 2-channel stereo sources are output from only the front left and right speakers.

Press Ⓜ STRAIGHT (or press Ⓜ AMP and then Ⓜ STRAIGHT) to select "STRAIGHT".

To deactivate the "STRAIGHT" mode, press Ⓜ STRAIGHT (or Ⓜ STRAIGHT) again so that "STRAIGHT" disappears from the front panel display.

FM/AM tuning

There are 2 tuning methods: automatic and manual. Automatic tuning is effective when station signals are strong and there is no interference. If the signal from the station you want to select is weak, tune into it manually. You can also use the automatic and manual preset tuning features to store up to 40 stations.

Automatic tuning

Automatic tuning is effective when station signals are strong and there is no interference.

- 1 Press **14 INPUT** $\triangleleft/\triangleright$ repeatedly so that “TUNER” is displayed in the front panel display.
- 2 Press **3 FM/AM** to select the reception band (FM or AM).
- 3 Press **7 TUNING AUTO/MAN'L** so that the AUTO indicator lights up in the front panel display.

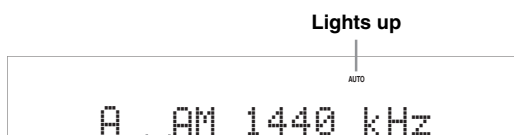

No colon (:)

If a colon (:) appears in the front panel display, automatic tuning is not possible. Press **2 PRESET/TUNING** to turn the colon (:) off.

- 4 Press **5 PRESET/TUNING/CH** $\triangleleft/\triangleright$ once to begin automatic tuning.

When this unit is tuned into a station, the TUNED indicator lights up and the frequency of the received station is shown in the front panel display.

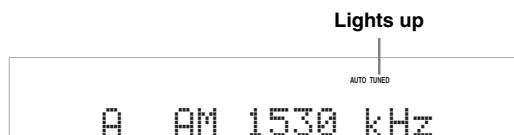

Manual tuning

If the signal received from the station you want to select is weak, tune into it manually.

Note

Manually tuning into an FM station automatically switches the tuner to monaural reception to increase the signal quality.

- 1 Press **14 INPUT** $\triangleleft/\triangleright$ repeatedly so that “TUNER” is displayed in the front panel display.
- 2 Press **3 FM/AM** to select the reception band (FM or AM).
- 3 Press **7 TUNING AUTO/MAN'L** so that the AUTO indicator disappears from the front panel display.

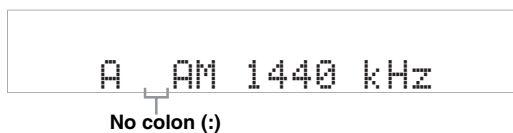

If a colon (:) appears in the front panel display, manual tuning is not possible. Press **2 PRESET/TUNING** to turn the colon (:) off.

- 4 Press **5 PRESET/TUNING/CH** $\triangleleft/\triangleright$ to tune into the desired station manually. You can hold down the button to continue searching.

Automatic preset tuning

You can use the automatic preset tuning feature to store FM stations with strong signals up to 40 (A1 to E8: 8 preset station numbers in each of the 5 preset station groups) of those stations in order. You can then recall any preset station easily by selecting the preset station number.

- 1 Press **14 INPUT** $\triangleleft/\triangleright$ repeatedly so that “TUNER” is displayed in the front panel display.
- 2 Press **3 FM/AM** to select “FM” as the reception band.
- 3 Press and hold **6 MEMORY** for more than 3 seconds.

The preset station number as well as the MEMORY and AUTO indicators flashes. After approximately 5 seconds, automatic presetting starts from the current frequency and proceeds toward the higher frequencies.

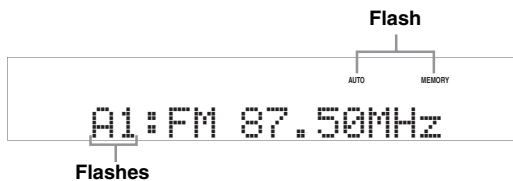

When automatic preset tuning is completed, the front panel display shows the frequency of the last preset station.



You can select the preset station group and the preset station number where the first received station will be stored by pressing **4 A/B/C/D/E** and then **5 PRESET/TUNING/CH** $\triangleleft/\triangleright$.

Notes

- Any stored station data existing under a preset station number is cleared when you store a new station under the same preset station number.
- Only FM stations with sufficient signal strength are stored automatically by automatic preset tuning. If the station you want to store is weak in signal strength, tune into it manually and store it as described in “Manual preset tuning” on this page.

Manual preset tuning

You can also store up to 40 stations (A1 to E8: 8 preset station numbers in each of the 5 preset station groups) manually.

- 1 Tune into a station automatically or manually. See page 34 for tuning instructions.
- 2 Press **6 MEMORY**. The MEMORY indicator flashes in the front panel display for approximately 10 seconds.
- 3 Press **4 A/B/C/D/E** and **5 PRESET/TUNING/CH** $\triangleleft/\triangleright$ repeatedly to select a preset station group (A1 to E8) while the MEMORY indicator is flashing. Check that the colon (:) appears in the front panel display.

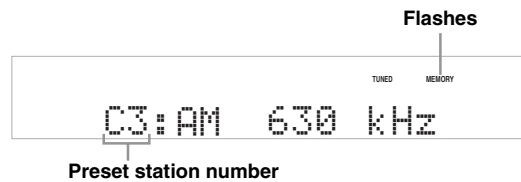

- 4 Press **6 MEMORY** while the MEMORY indicator is flashing. The station band and frequency appear in the front panel display with the preset station group and number you have selected.



Notes

- Any stored station data existing under a preset station number is cleared when you store a new station under the same preset station number.
- The reception mode (stereo or monaural) is stored along with the station frequency.

Selecting preset stations

You can tune into any desired station simply by selecting the preset station group and number under which it was stored.



When performing this operation with the remote control, press **Ⓞ TUNER** to select “TUNER” as the input source.

- 1 Press **④ A/B/C/D/E** (or **Ⓞ A-E/CAT. </>**) repeatedly to select the desired preset station group (A to E).

The preset station group letter appears in the front panel display and changes each time you press the button.

- 2 Press **⑤ PRESET/TUNING/CH </>** (or **Ⓞ PRESET/CH Δ / ▽**) to select the desired preset station number (1 to 8).

The preset station group and number appear in the front panel display along with the station band and frequency.



You can select the desired preset station number (1 to 8) directly by pressing the numeric buttons on the remote control.

Exchanging preset stations

You can exchange the assignments of two preset stations with each other. The example below describes the procedure to exchange preset station “E1” with “A5”.

- 1 Select preset station “E1” using **④ A/B/C/D/E** and **⑤ PRESET/TUNING/CH </>**.
See “Selecting preset stations” on this page.

- 2 Press and hold **② PRESET/TUNING** for more than 3 seconds.

“E1” and the MEMORY indicator flash in the front panel display.



- 3 Select preset station “A5” using **④ A/B/C/D/E** and **⑤ PRESET/TUNING/CH </>**.

“A5” and the MEMORY indicator flash in the front panel display.

See “Selecting preset stations” on this page.

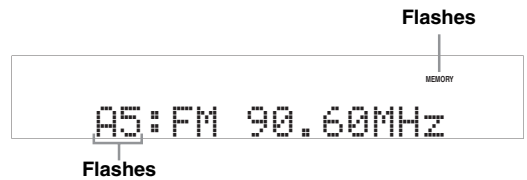

- 4 Press **② PRESET/TUNING** again.

“EDIT E1–A5” appears in the front panel display and the assignments of the two preset stations are exchanged.

XM Satellite Radio tuning

XM Satellite Radio offers an extraordinary variety of commercial-free music, plus the best in sports, news, talk and entertainment. XM is broadcast in superior digital audio from coast to coast. From rock to reggae, from classical to hip hop, XM has something for every music fan. XM's dedication to playing the richest selection of music is matched by its passion for live sporting events, talk radio, up-to-the-minute news, stand-up comedy, children's programming, and much more.

For U.S. customers, information about XM Satellite Radio is available online at www.xmradio.com.

For Canadian customers, information about XM Canada is online at www.xmradio.ca.

This unit is equipped with the Neural Surround decoder that plays back the XM HD surround sound content of the XM Satellite Radio broadcasts in multi-channels, resulting in a full surround sound experience.

Note

The XM Satellite Radio service is only available in the 48 contiguous United States (not available in Alaska and Hawaii) and Canada.

■ Information from XM Satellite Radio Inc.

Hardware and required monthly subscription sold separately. Other fees and taxes, including a one-time activation fee may apply. Subscription fee is consumer only. All fees and programming subject to change. Subscriptions subject to Customer Agreement available at xmradio.com (US residents) and xmradio.ca (Canadian residents). Only available in the 48 contiguous United States and Canada. ©2006 XM Satellite Radio Inc. All rights reserved. All other trademarks are the property of their respective owners.

Connecting the XM Mini-Tuner Dock

Connect XM Mini-Tuner and XM Dock (sold separately) to the XM jack on the rear panel of this unit.

For details, see the operating instructions provided with XM Mini-Tuner Dock.

XM Mini-Tuner and XM Dock (sold separately)

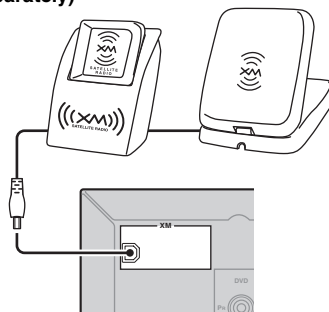

- To ensure optimal reception of the XM Satellite Radio signals, the XM Mini-Tuner Dock must be placed at or near a southerly facing window with no obstacles in the path to the sky. You can mount it indoors or outdoors.
- Use the "XM ANT." parameter in "OPTION MENU" (see page 50) to display the XM Satellite Radio reception level in the front panel display. For the best reception, orient the connected XM Mini-Tuner so that a value of 60% or more is displayed.

Note

If "CHECK ANTENNA" appears in the front panel display, the XM Mini-Tuner Dock may not be connected to the XM jack on the rear panel of this unit properly. See "Connecting the XM Mini-Tuner Dock" on this page and check the connection.

Activating XM Satellite Radio

Once you have installed the XM Mini-Tuner Dock, inserted the XM Mini-Tuner, connected the XM Dock to your XM Ready® home audio system, and installed the antenna, you are ready to subscribe and begin receiving XM programming. There are three places to find your eight character XM Radio ID: on the XM Mini-Tuner, on the XM Mini-Tuner package, and on XM Channel 0. Record the Radio ID in the following eight squares for reference.

□	□	□	□	□	□	□	□
---	---	---	---	---	---	---	---

Note

The XM Radio ID does not use the letters “I”, “O”, “S” or “F”. Activate your XM Satellite Radio service in the U.S. online at <http://www.xmradio.com/> or call 1-800-XM-RADIO (1-800-967-2346). You will need a major credit card. XM will send a signal from the satellites to activate the full channel lineup. Activation normally takes 10 to 15 minutes, but during peak busy periods you may need to keep your XM Ready home audio system on for up to an hour. When you can access the full channel lineup on your XM Ready home audio system you are done. For more information or to subscribe in Canada, visit XM on the Web at www.xmradio.ca or call XM’s Listener Care at 1-877-GET-XMSR (1-877-438-9677).

Basic XM Satellite Radio operations

- 1 Press **INPUT** $\triangleleft/\triangleright$ repeatedly (or press **XM**) to select “XM” as the input source.

The cursor on the left of the XM indicator lights up in the front panel display and the XM Satellite Radio information (such as channel number, channel name, category, artist name, or song title) for the currently selected channel appears in the front panel display.

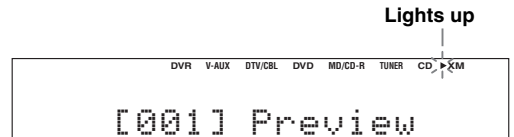

When you select “XM” as the input source, this unit automatically recalls the previously selected channel.

- 2 Search for a channel by using one of the XM Satellite Radio search modes.

- To select a channel from the all channel list, see “All Channel Search mode” on page 39.
- To select a channel by category, see “Category Search mode” on page 39.
- To select a channel from the preset channels, see “Preset Search mode” on page 39.
- To select the desired channel directly by entering the channel number, see “Direct Number Access mode” on page 39.



- You can use the Neural Surround decoder to enjoy the XM HD surround sound content of the XM Satellite Radio broadcasts in multi-channels (see page 32).
- You can set the XM Satellite Radio preset channels (see page 40).
- You can display the XM Satellite Radio information in the front panel display (see page 41).



When performing these operations with the remote control, press **Ⓞ XM** to select “XM” as the input source.

■ All Channel Search mode

1 Press **Ⓜ SEARCH MODE** (or **Ⓟ SRCH MODE**) repeatedly to select “ALL CH SEARCH”.

2 Press **Ⓟ PRESET/TUNING/CH** $\triangleleft / \triangleright$ (or **Ⓞ PRESET/CH** \triangle / ∇) repeatedly to search for a channel within all channels.



- You can search for a channel quickly by pressing and holding **Ⓟ PRESET/TUNING/CH** $\triangleleft / \triangleright$ (or **Ⓞ PRESET/CH** \triangle / ∇).
- To display the XM Radio ID number displayed in the front panel display, select channel “0”.

■ Category Search mode

1 Press **Ⓜ SEARCH MODE** (or **Ⓟ SRCH MODE**) repeatedly to select “CAT SEARCH”.

2 Press **Ⓞ CATEGORY** (or **Ⓞ A-E/CAT.** $\triangleleft / \triangleright$) repeatedly to change the channel category.

3 Press **Ⓟ PRESET/TUNING/CH** $\triangleleft / \triangleright$ (or **Ⓞ PRESET/CH** \triangle / ∇) repeatedly to search for a channel within the selected channel category.



You can search for a channel quickly by pressing and holding **Ⓟ PRESET/TUNING/CH** $\triangleleft / \triangleright$ (or **Ⓞ PRESET/CH** \triangle / ∇).

■ Preset Search mode

Prior to selecting a preset channel in the Preset Search mode, you must preset XM Satellite Radio channels. For details, see “Setting XM Satellite Radio preset channels” on page 40.



All preset channels (A1 to E8) recalls “001 Preview” by the initial factory setting.

1 Press **Ⓜ SEARCH MODE** (or **Ⓟ SRCH MODE**) repeatedly to select “PRESET SEARCH”.

2 Press **Ⓞ CATEGORY** (or **Ⓞ A-E/CAT.** $\triangleleft / \triangleright$) repeatedly to change the preset channel group (A to E).

3 Press **Ⓟ PRESET/TUNING/CH** $\triangleleft / \triangleright$ (or **Ⓞ PRESET/CH** \triangle / ∇) repeatedly to change the preset channel number (1 to 8).



You can also select the preset channel number directly by pressing the numeric buttons (1 to 8) on the remote control.

■ Direct Number Access mode

1 Press **Ⓟ SRCH MODE** repeatedly to select “ALL CH SEARCH” or “CAT SEARCH”.

2 Press the numeric buttons (**Ⓟ**) to enter the desired three-digit channel number.

For example, to enter the number 123, press the numeric buttons as shown below.

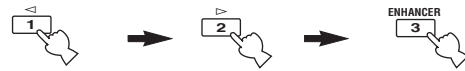

The display changes as follows.

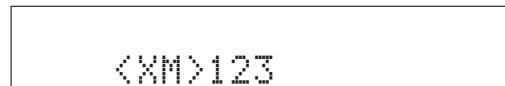
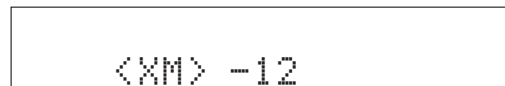
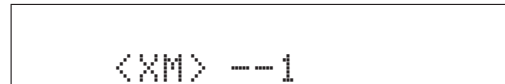

- To enter a one-digit or two-digit channel number, press the numeric buttons (**Ⓟ**) and then press **Ⓜ ENT.** to confirm the input number. Instead of pressing **Ⓜ ENT.** to tune into the channel immediately, you can wait a few seconds until this unit confirms the entered channel number.
- If no button is pressed within a few seconds after you enter a one-digit or two-digit number, this unit automatically confirms the entered channel number.
- Pressing a button other than the numeric buttons (**Ⓟ**) or **Ⓜ ENT.** cancels the Direct Number Access mode procedure.

Setting XM Satellite Radio preset channels

You can use this feature to store up to 40 XM Satellite Radio channels (A1 to E8: 8 preset channel numbers in each of the 5 preset channel groups). You can then recall any preset channel easily by selecting the preset channel group and number as described in “Preset Search mode” on page 39.

1 Search for a channel you want to set as a preset channel by using one of the XM Satellite Radio search modes.

See “Basic XM Satellite Radio operations” on page 38 for details.

2 Press **MEMORY** (or **XM MEMORY**).

The MEMORY indicator flashes in the front panel display for approximately 10 seconds.

Note

You must proceed to and carry out steps 3 through 5 while the MEMORY indicator is flashing in the front panel display.

3 Press **CATEGORY** (or **A-E/CAT.** $\triangleleft/\triangleright$) repeatedly to select a preset channel group (A to E) while the MEMORY indicator is flashing.

The preset channel group letter appears in the front panel display.

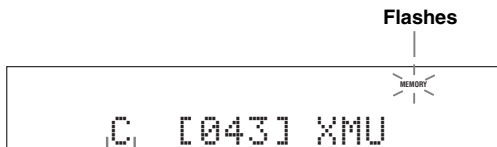

Currently selected preset channel group

4 Press **PRESET/TUNING/CH** $\triangleleft/\triangleright$ (or **PRESET/CH** \triangle/∇) repeatedly to select a preset channel number (1 to 8) while the MEMORY indicator is flashing.

The preset channel number appears in the front panel display.

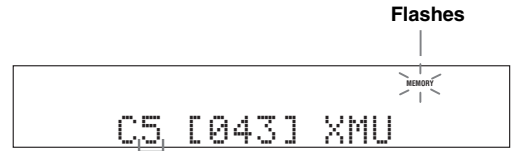

Currently selected preset channel number

5 Press **MEMORY** (or **XM MEMORY**) to set the selected XM Satellite Radio channel as a preset channel while the MEMORY indicator is flashing.

A colon (:) appears next to the preset channel number for confirmation, and the MEMORY indicator turns off in the front panel display.

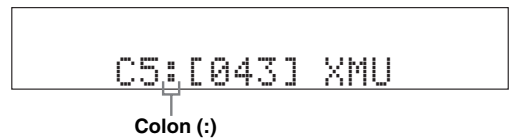

Note

Once you set a new preset channel, the one previously stored in the same preset channel group and number is cleared.

Displaying the XM Satellite Radio information

You can display the XM Satellite Radio information (such as channel number, channel name, category, artist name, or song title) for the currently selected channel in the front panel display.

Note

If a status message or an error message appears in the front panel display, see the “XM Satellite Radio (U.S.A. and Canada models only)” section in “Troubleshooting” on page 59 for appropriate remedies.

■ Displaying the XM Satellite Radio information in the front panel display

Press **⑦ DISPLAY** (or **Ⓡ DISPLAY**) repeatedly to toggle between the following XM Satellite Radio information display modes.

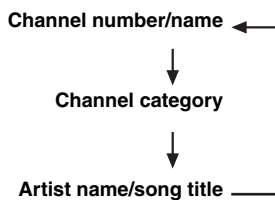

- The front panel display can indicate up to 14 alphanumeric characters at once. You can set whether to display the XM Satellite Radio information in the front panel display in a continuous manner or by 14 alphanumeric characters at once by using the “FL SCROLL” parameter in “OPTION MENU” (see page 50).
- If the XM Satellite Radio information contains a character that cannot be recognized by this unit, the character will be displayed with a space.

Recording

Recording adjustments and other operations are performed from the recording components. Refer to the operating instructions for those components.

Notes

- When this unit is set to the standby mode, you cannot record between other components connected to this unit.
- The settings of TONE CONTROL (see page 29) and VOLUME settings, speaker levels (see page 29) and the sound field programs (see page 31) do not affect recorded material.
- The source connected to the MULTI CH INPUT jacks of this unit cannot be recorded.
- The XM Satellite Radio signals cannot be output at the AUDIO OUT (REC) jacks.
- Digital signals input at the DIGITAL INPUT jacks are not output at the analog AUDIO OUT (REC) jacks for recording. Therefore, if your source component is connected to provide only digital signals, you cannot record the source.
- A given input source is not output on the same OUT (REC) channel.
- Once you have connected a recording component to this unit, keep the component turned on while using this unit. If the component is turned off, this unit may distort the sound from other components.
- Check the copyright laws in your country to record from CDs, radio, etc. Recording of copyrighted material may infringe copyright laws.



Do a test recording before you start an actual recording.

If you play back a video source that uses scrambled or encoded signals to prevent it from being dubbed, the picture itself may be disturbed due to those signals.

1 Turn on all the connected components.

2 Press  INPUT </> repeatedly (or press one of the input selector buttons (C)) to select the source component you want to record from.

3 Start playback on the selected source component or select a broadcast station.

4 Start recording on the recording component.

Set menu

You can use the following parameters in set menu to adjust a variety of system settings and customize the way this unit operates. Change the initial settings (indicated in bold under each parameter) to reflect the needs of your listening environment.

■ **Basic setup** BASIC SETUP

Use this feature to automatically adjust speaker and system parameters (see page 21).

■ **Manual setup** MANUAL SETUP

Use this feature to manually adjust speaker and system parameters.

Sound menu 1 SOUND MENU

Use this menu to manually adjust any speaker settings, alter the quality and tone of the sound output by the system or compensate for video signal processing delays when using LCD monitors or projectors.

Parameter	Features	Page
A)SPEAKER SET	Selects the size of each speaker, the speakers for low-frequency signal output, the crossover frequency, and the location of the front speakers connected to the FRONT B terminals.	45
B)SP LEVEL	Adjusts the output level of each speaker.	46
C)SP DISTANCE	Adjusts the distance of each speaker.	47
D)CENTER GEO	Adjusts the tonal quality of the center speaker.	47
E)LFE LEVEL	Adjusts the output level of the LFE channel for Dolby Digital or DTS signals.	47
F)D. RANGE	Adjusts the dynamic range of Dolby Digital or DTS signals.	47
G)AUDIO SET	Adjusts the muting level, audio delay settings, maximum volume level and initial volume level.	48

Input menu 2 INPUT MENU

Use this menu to manually reassign the input jacks, select the input mode or rename the input source.

Parameter	Features	Page
A)INPUT ASSIGN	Assigns the input jacks of this unit according to the component to be used.	48
B)INPUT RENAME	Changes the name of the input source.	49
C)VOLUME TRIM	Adjusts the output volume of each jack.	49
D)DECODER MODE	Selects the decoder mode for the sources connected to the DIGITAL INPUT jacks on the rear panel of this unit.	49
E)MULTI CH SET	Select the video source played in the background of the sources in put from the MULTI CH INPUT jacks.	49

Option menu 3 OPTION MENU

Use this menu to manually adjust the optional system parameters.

Parameter	Features	Page
A>DISPLAY SET	Adjusts the brightness of the front panel display and the way in which the XM information is displayed.	50
B>MEMORY GUARD	Locks sound field program parameters and other set menu settings.	50
C>AUDIO SELECT	Designates the default audio input jack select setting mode for the input sources connected to the DIGITAL INPUT jacks when you turn on the power of this unit.	50
D>PARAM. INI	Sets all the parameters of the sound field programs to the initial factory settings.	50
E>XM RADIO SET	Displays the current reception level of the XM Satellite Radio signals.	50

Note

The “XM RADIO SET” parameter is only applicable to the U.S.A. and Canada models.

■ **Signal information** SIGNAL INFO

Use this feature to check audio signal information (see page 30).

Using set menu

Use the remote control to access and adjust each parameter.



You can change the set menu parameters while this unit is reproducing sound.

- 1** Press **Ⓞ** AMP and then press **Ⓜ** MENU on the remote control.
“BASIC SETUP” appears in the front panel display.

• BASIC SETUP

- 2** Press **Ⓞ** Δ / ▽ to select “MANUAL SETUP”.

• MANUAL SETUP

- 3** Press **Ⓞ** ENTER to enter “MANUAL SETUP”.
“1 SOUND MENU” appears in the front panel display.

1 SOUND MENU

- 4** Press **Ⓞ** Δ / ▽ repeatedly and then press **Ⓞ** ENTER to select and enter the desired menu.

The following menus appear in the front panel display as you press **Ⓞ** Δ / ▽ repeatedly.

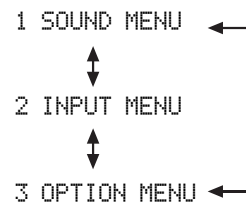

- 5** Press **Ⓞ** Δ / ▽ repeatedly and then press **Ⓞ** ENTER to select and enter the desired submenu.

- Repeat steps 5 and 6 to navigate to and enter the items you want to adjust.
- To return to the previous menu level, press **Ⓞ** RETURN.

- 6** Press **Ⓞ** Δ / ▽ to select the desired parameter and then **Ⓞ** < / > to change the parameter value.

- Press **Ⓞ** > to increase the value.
- Press **Ⓞ** < to decrease the value.

- 7** Press **Ⓜ** MENU to exit from set menu.

1 SOUND MENU

Use this menu to manually adjust any speaker settings or compensate for video signal processing delays when using LCD monitors or projectors.

■ Speaker settings A>SPEAKER SET

Use this feature to manually adjust any speaker settings.

FRONT B speaker setting FRONT B

Use this feature to select the location of the front speakers connected to the FRONT B terminals.

Choices: **FRONT**, ZONE B

- Select "FRONT" to turn FRONT A and B on and off when the FRONT B speakers are set in the main zone.
- Select "ZONE B" if the speakers connected to the FRONT B terminals are set in another zone. If FRONT A is turned off and FRONT B is turned on, all the speakers including the subwoofer in the main zone are muted and this unit outputs sound at the FRONT B terminals only.

Notes

- If you connect headphones to the PHONES jack of this unit, the sound is output from both headphones and the FRONT B terminals when "FRONT B" is set to "ZONE B".
- If a DSP program is selected when "FRONT B" is set to "ZONE B", this unit automatically enters the Virtual CINEMA DSP mode (see page 33).

Woofer section of a speaker is 16 cm (6.5 in) or larger: large
Woofer section of a speaker is smaller than 16 cm (6.5 in): small

Front speakers FRONT

Choices: SMALL, **LARGE**

When the front speakers are large

Select "LARGE" (large).

When the front speakers are small

Select "SMALL" (small).

Note

When "BASS OUT" is set to "FRNT" (see page 46), you can select only "LARGE" in "FRONT". If the value of "FRONT" is set to a setting other than "LARGE" in advance, this unit automatically changes the value to "LARGE".

Center speaker CENTER

Choices: NONE, **SML**, LRG

When the center speaker is large

Select "LRG" (large).

When the center speaker is small

Select "SML" (small).

When you do not use the center speaker

Select "NONE" (none). The center channel signals are directed to the front left and right speakers.

Surround left/right speakers SUR. LR

Choices: NONE, **SML**, LRG

When the surround speakers are large

Select "LRG" (large).

When the surround speakers are small

Select "SML" (small).

When you do not use the surround speakers

Select "NONE" (none). This unit is set to the Virtual CINEMA DSP mode (see page 33).

LFE/Bass out BASS OUT

Use this feature to select the speakers that output the LFE (low-frequency effect) and the low-frequency signals.

Choices: SWFR, FRNT, **BOTH**



If you are not satisfied with the bass sounds from your speakers, you can change these settings according to your preference.

When a subwoofer is connected to this unit and you want to get natural bass sound

Select “SWFR” (subwoofer). The LFE signals as well as the low-frequency signals of other speakers set to “SML” (or “SMALL”) are directed to the subwoofer.

When a subwoofer is connected to this unit and you want to get rich bass sound

Select “BOTH” (both). The low-frequency signals of any source are output from the subwoofer. The LFE signals as well as the low-frequency signals of other speakers set to “SML” (or “SMALL”) are directed to the subwoofer. The low-frequency signals of the front left and right channels are directed to the front left and right speakers and the subwoofer regardless of the “FRONT” setting (see page 45).

When you do not use a subwoofer

Select “FRNT” (front). The LFE signals, the low-frequency signals of the front left and right channels, and the low-frequency signals of other speakers set to “SML” (or “SMALL”) are all directed to the front left and right speakers regardless of the “FRONT” setting (see page 45).

Crossover CROSSOVER

Use this feature to select a crossover frequency of all the speakers set to “SML” (or “SMALL”) or to “NONE” in “SPEAKER SET” (see pages 44 and 45). All frequencies below the selected frequency will be sent to the subwoofer or to the speakers set to “LRG” (or “LARGE”) in “SPEAKER SET” (see pages 44 and 45).

Choices: 40Hz, 60Hz, **80Hz**, 90Hz, 100Hz, 110Hz, 120Hz, 160Hz, 200Hz

Subwoofer phase SWFR PHASE

Use this feature to switch the phase of your subwoofer if bass sounds are lacking or unclear.

Choices: **NRM**, REV

- Select “NRM” if you do not want to reverse the phase of your subwoofer.
- Select “REV” to reverse the phase of your subwoofer.

Speaker level B>SP LEVEL

Use this feature to manually adjust the output level of each speaker.

Control range: -10 to +10 dB

Control step: 1 dB

Initial setting: 0 dB

SP LEVEL	Adjusted speaker
FL	Front left speaker
FR	Front right speaker
C	Center speaker
SL	Surround left speaker
SR	Surround right speaker
SWFR	Subwoofer

Note

The available speaker channels differ depending on the setting of the speakers.

■ Speaker distance C)SP DISTANCE

Use this feature to manually adjust the distance of each speaker and the delay applied to the respective channel. Ideally, each speaker should be the same distance from the main listening position. However, this is not possible in most home situations. Thus, a certain amount of delay must be applied to the sound from each speaker so that all sounds will arrive at the listening position at the same time.

Unit UNIT

Choices: meters (m), feet (ft)

Initial setting:

[U.S.A. and Canada models]: feet (ft)

[Other models]: meters (m)

- Select “meters” to adjust speaker distances in meters.
- Select “feet” to adjust speaker distances in feet.

Speaker distances

Control range: 0.30 to 24.00 m (1.0 to 80.0 ft)

Control step: 0.10 m (0.5 ft)

Initial setting: 3.00 m (10.0 ft)

SP DISTANCE	Adjusted speaker
FRONT L	Front left speaker
FRONT R	Front right speaker
CENTER	Center speaker
SUR. L	Surround left speaker
SUR. R	Surround right speaker
SWFR	Subwoofer

Note

The available speaker channels differ depending on the setting of the speakers.

■ Center graphic equalizer D)CENTER GEQ

Use this feature to adjust the built-in 5-frequency band (100Hz, 300Hz, 1kHz, 3kHz and 10kHz) graphic equalizer for the center channel so that the tonal quality of the center speaker matches that of the front speakers. You can make adjustments while listening to the currently selected source component or a test tone.

Control range: -6.0 to +6.0 dB

Control step: 0.5 dB

Initial setting: 0 dB



Press \odot Δ / ∇ to select a frequency band and \odot \triangleleft / \triangleright to adjust the selected frequency band.

Following is an example where “100Hz” is selected as the frequency band.



Test tone TEST

Use this feature to make adjustments for “CENTER GEQ” while listening to a test tone.

Choices: **OFF**, ON

- Select “OFF” to stop test tones and output the currently selected source component.
- Select “ON” to output test tones from the center and front left speakers.

■ Low-frequency effect level E)LFE LEVEL

Use this feature to adjust the output level of the LFE (low-frequency effect) channel according to the capacity of your subwoofer or headphones. The LFE channel carries low-frequency special effects which are only added to certain scenes. This setting is effective only when this unit decodes Dolby Digital or DTS signals.

Control range: -20 to 0 dB

Control step: 1 dB

Speaker LFE SP LFE

Adjusts the speaker LFE level.

Headphone LFE HP LFE

Adjusts the headphone LFE level.

Note

Depending on the settings of “BASS OUT” (see page 46), some signals may not be output at the SUBWOOFER OUTPUT jack.

■ Dynamic range F)D. RANGE

Use this feature to select the amount of dynamic range compression to be applied to your speakers or headphones. This setting is effective only when this unit is decoding Dolby Digital and DTS signals.

Choices: MIN, STD, **MAX**

- Select “MIN” (minimum) if you regularly listen at low volume levels.
 - Select “STD” (standard) for general use.
- Select “MAX” (maximum) to preserve the greatest amount of dynamic range.

Speaker dynamic range SP D.R

Adjusts the speaker compression.

Headphone dynamic range HP D.R

Adjusts the headphone compression.

■ Audio settings G)AUDIO SET

Use this feature to adjust the overall audio settings of this unit.

Mute type MUTE TYP.

Use this feature to adjust how much the mute function reduces the output volume (see page 28).

Choices: **FULL**, -20dB

- Select “FULL” to completely mute all the audio output.
- Select “-20dB” to reduce the current volume by 20 dB.

Audio delay A.DELAY

Use this feature to delay the sound output and synchronize it with the video image. This may be necessary when using certain LCD monitors or projectors.

Control range: **0** to 160 ms

Control step: 1 ms

Maximum volume MAX VOL.

Use this feature to set the maximum volume level in the main zone. This feature is useful to avoid the unexpected loud sound by mistake. For example, the original volume range is 16 dB to -80 dB. However, when “MAX VOL.” is set to -5 dB, the volume range becomes -5 dB to -80 dB.

Control range: **16 dB**, 10 dB to -30 dB

Control step: 5 dB

Note

The “MAX VOL.” setting takes priority over the “Initial Volume” setting. For example, if “INI VOL.” is set to -20 dB and “MAX VOL.” is set to -30 dB, the volume level is automatically set to -30 dB when you turn on the power of this unit next time.

Initial volume INI VOL.

Use this feature to set the volume level when the power of this unit is turned on.

Choices: **Off**, -80 dB to +16 dB

Control step: 1 dB

Note

The “MAX VOL.” setting takes priority over the “INI VOL.” setting.

2 INPUT MENU

Use this menu to reassign the input jacks, select the input mode or rename the input source.

■ Input assignment

A)INPUT ASSIGN

Use this feature to assign the input jacks according to the component to be used if the initial settings of this unit do not correspond to your needs. Change the following parameters to reassign the respective jacks and effectively connect more components.

Once the input jacks are reassigned, you can select the corresponding component by using **14** **INPUT** $\triangleleft/\triangleright$ (or the input selector buttons (C)) on the remote control).

For COAXIAL INPUT jacks 1

IN (1)

Choices: (1) CD, MD/CD-R, **DVD**, DTV/CBL, V-AUX, DVR

For OPTICAL INPUT jacks 2 and 3

IN (2)

IN (3)

Choices: (2) CD, MD/CD-R, DVD, **DTV/CBL**, V-AUX, DVR

(3) **CD**, MD/CD-R, DVD, DTV/CBL, V-AUX, DVR

Note

You cannot select a specific item more than once.

■ Input rename B)INPUT RENAME

Use this feature to change the name of the input source that appears in the front panel display.

The following is an example where “DVD” is renamed “My DVD”.



- 1 Press one of the input selector buttons (C) or (A) **MULTI CH IN** to select the input source you want to change the name of.

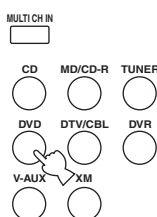

- 2 Press (D) **AMP** and then press (G) </> on the remote control to place the “_” (underscore) under the space or the character you want to edit.

- 3 Press (G) Δ / ▽ to select the character you want to use and then press (G) </> to move to the next space.

Notes

- You can use up to 8 characters for each input.
- Press (G) ▽ to change the character in the following order, or press (G) Δ to go in the reverse order:
A to Z, a space, 0 to 9, a space, a to z, a space, symbols (#, *, -, +, etc.)

- 4 Repeat steps 1 through 3 to rename each input source.

- 5 Press (P) **MENU** to exit from “INPUT RENAME”.

■ Volume trim C)VOLUME TRIM

Use this feature to adjust the level of the signal input at each jack. This is useful if you want to balance the level of each input source to avoid sudden changes in volume when switching between input sources.

Choices: CD, MD/CD-R, TUNER, DVD, DTV/CBL, V-AUX, DVR, MULTI CH IN, XM RADIO

Control range: -6.0 to +6.0 dB

Control step: 1.0 dB

Initial setting: 0.0 dB

■ Decoder mode D)DECODER MODE

Decoder select mode

Use this feature to designate the default decoder mode for the input sources connected to the DIGITAL INPUT jacks when you turn on the power of this unit.

Choices: **AUTO**, **LAST**

- Select “AUTO” if you want this unit to automatically detect the type of input signals and select the appropriate decoder mode.
- Select “LAST” if you want this unit to automatically select the last decoder mode used the connected input source.

DTS decoder prioritize setting

Choices: **AUTO**, **DTS**

- Select “AUTO” if you want this unit to automatically detect input signal types and select the appropriate input mode.
- Select “DTS” when you play back a DTS-CD.

■ Multi channel input setup

E)MULTI CH SET

BGV BGV

Use this feature to select the video source played in the background of the sources input from the MULTI CH INPUT jacks.

Choices: **LAST**, **DVR**, **V-AUX**, **DTV/CBL**, **DVD**



Select “LAST” to set this unit to automatically select the last selected video source as the background video source.

3 OPTION MENU

Use this menu to adjust the optional system parameters.

■ Display settings A)DISPLAY SET

Dimmer DIMMER

Use this feature to adjust the brightness of the front panel display.

Control range: -4 to 0

Control step: 1

- Press $\text{Ⓢ} \leftarrow$ to make the front panel display dimmer.
- Press $\text{Ⓢ} \rightarrow$ to make the front panel display brighter.

Front panel display scroll FL SCROLL

Use this feature to set whether to display the information (such as song title or channel name) in the front panel display in a continuous manner or by the first 14 alphanumeric characters after scrolling all characters once when "XM" is selected as the input source.

Choices: **CONT**, **ONCE**

- Select "CONT" to display the operation status in the front panel display in a continuous manner.
- Select "ONCE" to display the operation status in the front panel display by the first 14 alphanumeric characters after scrolling all characters once.

■ Memory guard B)MEMORY GUARD

Memory guard MEM. GUARD

Use this feature to prevent accidental changes to DSP program parameter values and other system settings.

Choices: **OFF**, **ON**

- Select "OFF" to turn off the "MEM. GUARD" feature.
- Select "ON" to protect:
 - sound field program parameters
 - all set menu items
 - all speaker levels
 - SCENE template parameters

Note

When "MEM. GUARD" is set to "ON", you cannot select and adjust any other set menu items.

■ Audio select C)AUDIO SELECT

Use this feature to designate the default audio input jack select setting for the input sources when you turn on the power of this unit.

Choices: **AUTO**, **LAST**

- Select "AUTO" if you want this unit to automatically detect the type of input signals and select the appropriate input mode.
- Select "LAST" if you want this unit to automatically select the last input mode used for the connected input source (see page 29).

■ Parameter initialization D)PARAM. INI

Use this feature to set all the parameters of the sound field programs to the initial factory settings.

Choices: **NO**, **YES**

- Select "NO" to cancel the parameter initialization and return to the previous menu level.
- Select "YES" to set all the sound field parameters to the initial factory settings.

Notes

- You cannot automatically revert to the previous parameter settings once you initialize the sound field program parameters.
- You cannot separately initialize individual sound field programs.
- You cannot initialize any sound field program groups when "MEM. GUARD" is set to "ON".

■ XM Radio setting E)XM RADIO SET (U.S.A. and Canada models only)

XM Radio antenna XM ANT.

Use this feature to check the current reception level of the XM Satellite Radio signals (see page 37). For the best reception, orient XM Mini-Tuner Dock so that a value of 60% or more is displayed here.

Display status: **NONE**, 0 to 100%

Note

"NONE" is displayed if XM Mini-Tuner Dock is not connected to this unit. In this case, check the antenna connections (see page 37).

Remote control features

In addition to controlling this unit, the remote control can also operate other audiovisual components made by Yamaha and other manufacturers. To control your TV or other components, you must set up the appropriate remote control code for each input source (see page 54).

Using remote control on the SCENE feature

■ Controlling the input source components in the SCENE mode

You can operate both this unit and the input source component by using the remote control. You must set the appropriate remote control code for each input source in advance (see page 54).

1 Press the desired **SCENE** button on the remote control.

2 Press the desired buttons in the * area below to control the input source component of the selected SCENE template.

■ Setting input source of the customized SCENE template on the remote control

If you customize the input source of the selected SCENE template, you must set the input source of the SCENE template on the remote control to operate the input source component correctly.

Press and hold the SCENE button and the desired input selector button (C) for 3 seconds.



Press the **SCENE** button again to operate the input source component.

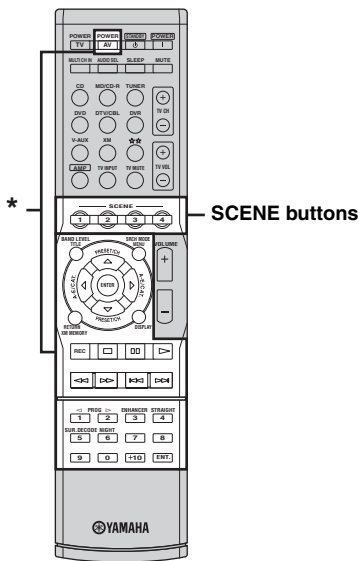

Note

* These buttons control the input source component. See page 53 for details of the function of each button.

■ Controlling other components

Press one of the input selector buttons (C) or ☆☆ to control other components. You must set the appropriate remote control code for each input source in advance (see page 54). The following table shows the function of each control button used to control other components assigned to each input selector button. Be advised that some buttons may not correctly operate the selected component.



The remote control has 9 modes (input areas) to control components so that the remote control can operate up to 9 different components.

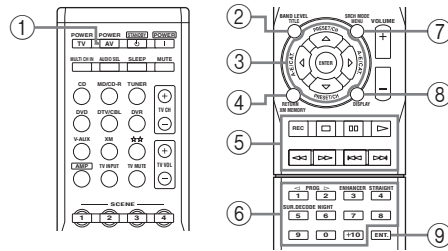

Remote control	DVD player/ recorder	VCR	Digital TV/ Cable TV	LD player	CD player	MD/CD recorder	Tuner
① AV POWER	Power *1	Power *1	Power *2	Power *1	Power *1	Power *1	
② TITLE	Title						Band
③ PRESET/CH Δ	Up	VCR channel up	Up				Preset up (1-8)
PRESET/CH ∇	Down	VCR channel down	Down				Preset down (1-8)
A-E/CAT. <	Left		Left				Preset down (A-E)
A-E/CAT. >	Right		Right				Preset up (A-E)
ENTER	Enter		Enter				
④ RETURN	Return		Return				
⑤ REC	Disc skip (player) Rec (recorder)	Rec	Rec *2		Disc skip	Rec	
▷	Play	Play	Play *2	Play	Play	Play	
◁◁	Search backward	Search backward	Search backward *2	Search backward	Search backward	Search backward	
▷▷	Search forward	Search forward	Search forward *2	Search forward	Search forward	Search forward	
⏸	Pause	Pause	Pause *2	Pause	Pause	Pause	
◁◁	Skip backward	Skip backward	Skip backward *2	Skip backward	Skip backward	Skip backward	
▷▷	Skip forward	Skip forward	Skip forward *2	Skip forward	Skip forward	Skip forward	
◻	Stop	Stop	Stop *2	Stop	Stop	Stop	
⑥ 1-9, 0, +10	Numeric buttons	Numeric buttons	Numeric buttons	Numeric buttons	Numeric buttons	Numeric buttons	Preset stations (1-8)
⑦ MENU	Menu		Menu				
⑧ DISPLAY	Display	Display	Display	Display	Display	Display	
⑨ ENT.	Title/Index	Enter	Enter	Chapter/Time	Index	Index	

Notes

*1 This button is operational only when the original remote control supplied with the component has a POWER button.

*2 These buttons operate your DVD recorder only when you set the appropriate remote control code for DVR (see page 54).

Setting remote control codes

You can control other components by setting the appropriate remote control codes. For a complete list of available remote control codes, refer to “List of remote control codes” at the end of this manual.

Remote control code default settings

Input source	Component category	Manufacturer	Default code
CD	CD	YAMAHA	5013
MD/CD-R	CD-R	YAMAHA	5001
TUNER	TUNER	YAMAHA	5007
DVD	DVD	YAMAHA	2000
DTV/CBL	-	-	-
V-AUX	TUNER	YAMAHA	5011
XM	TUNER	YAMAHA	5009
DVR	DVR	YAMAHA	2011
☆☆	TUNER	YAMAHA	5012

Note

You may not be able to operate your Yamaha component even if a Yamaha remote control code is preset as listed above. In this case, try setting another Yamaha remote control code.

- 1 While pressing and holding one of the input selector buttons (Ⓢ) on the remote control to select the input area you want to set up, press **AV POWER** for more than 3 seconds.

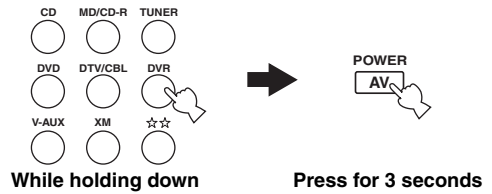

- 2 Press the numeric buttons (0 to 9) (Ⓢ) to enter the four-digit remote control code for the component to be used.

Notes

- If the manufacturer of your component has more than one code, try each of them until you find the correct one.
- If you do not press any buttons within 30 seconds in step 2, the setup process is canceled. If this happens, repeat the setup procedure.

Advanced setup

This unit has additional menus that are displayed in the front panel display. The advanced setup menu offers additional operations to adjust and customize the way this unit operates. Change the initial settings (indicated in bold under each parameter) to reflect the needs of your listening environment.

Notes

- Only **① STANDBY/ON**, **⑪ PROGRAM** </> and **⑫ STRAIGHT** are effective while you are using the advanced setup menu.
- No other operations can be made while you are using the advanced setup menu.
- The advanced setup menu is only available in the front panel display.

1 Press ① STANDBY/ON on the front panel to set this unit to the standby mode.

2 Press and hold ⑩ TONE CONTROL and then press ① STANDBY/ON to turn on this unit.

This unit turns on, and the advanced setup menu appears in the front panel display.

3 Press ⑪ PROGRAM </> to select the parameter you want to adjust.

The name of the selected parameter appears in the front panel display.

4 Press ⑫ STRAIGHT repeatedly to change the selected parameter setting.

5 Press ① STANDBY/ON to confirm your selection and set this unit to the standby mode.



The settings you made are reflected next time you turn on this unit.

■ Speaker impedance SP IMP. (U.S.A. and Canada models only)

Use this feature to set the speaker impedance of this unit so that it matches that of your speakers.

Choices: **8Ω MIN**, 6Ω MIN

- Select “8Ω MIN” to set the speaker impedance to 8 Ω .
- Select “6Ω MIN” to set the speaker impedance to 6 Ω .

SP IMP.	Speaker	Impedance level
8Ω MIN	Front (A or B)	The impedance of each speaker must be 8 Ω or higher.
	Center	
	Surround	
6Ω MIN	Front (A or B)	The impedance of each speaker must be 6 Ω or higher.
	Center	
	Surround	

■ Factory presets PRESET

Use this feature to reset all the parameters of this unit to the initial factory settings.

Choices: **CANCEL**, RESET

- Select “CANCEL” not to reset any parameters of this unit.
- Select “RESET” to reset the parameters of this unit.

Notes

- This setting completely resets all the parameters of this unit including the set menu parameters. However, the advanced setup menu parameters will not be initialized.
- The initial factory settings are activated next time you turn on this unit.

■ Tuner frequency step TU (Asia and General models only)

Use this feature to set the tuner frequency step according to the frequency spacing in your area.

Choices: **AM10/FM100**, AM9/FM50

- Select “AM10/FM100” for North, Central and South America.
- Select “AM9/FM50” for all other areas.

Troubleshooting

Refer to the table below when this unit does not function properly. If the problem you are experiencing is not listed below or if the instruction below does not help, turn off this unit, disconnect the power cable, and contact the nearest authorized Yamaha dealer or service center.

■ General

Problem	Cause	Remedy	See page
This unit fails to turn on or enters the standby mode soon after the power is turned on.	The power cable is not connected or the plug is not completely inserted.	Connect the power cable firmly.	—
	The speaker impedance setting is incorrect.	Set the speaker impedance to match your speakers.	13
	The protection circuitry has been activated.	Make sure that all speaker wire connections on this unit and on all speakers are secure and that the wire for each connection does not touch anything other than its respective connection.	12
	This unit has been exposed to a strong external electric shock (such as lightning or strong static electricity).	Set this unit to the standby mode, disconnect the power cable, plug it back in after 30 seconds and then use it normally.	—
No sound	Incorrect input or output cable connections.	Connect the cables properly. If the problem persists, the cables may be defective.	14-17
	No appropriate Audio input jack select has been set.	Set an appropriate Audio input jack select.	29
	No appropriate input source has been selected.	Select an appropriate input source with INPUT $\triangleleft/\triangleright$ on the front panel (or the input selector buttons on the remote control).	27, 28
	Speaker connections are not secure.	Secure the connections.	12
	The front speakers to be used have not been selected properly.	Select the front speakers with SPEAKERS .	27
	The volume is turned down.	Turn up the volume.	—
	The sound is muted.	Press MUTE or VOLUME +/- on the remote control to resume audio output and then adjust the volume.	28
	Signals this unit cannot reproduce are being input from a source component, such as a CD-ROM.	Play a source whose signals can be reproduced by this unit.	—

Problem	Cause	Remedy	See page
The sound suddenly goes off.	The protection circuitry has been activated because of a short circuit, etc.	Check that the impedance setting is correct.	13
		Check that the speaker wires are not touching each other and then turn this unit back on.	—
	The sleep timer has turned off this unit.	Turn on this unit, and play the source again.	—
	The sound is muted.	Press MUTE or VOLUME +/- on the remote control to resume audio output.	28
Sound is heard from the speaker on one side only.	Incorrect cable connections.	Connect the cables properly. If the problem persists, the cables may be defective.	14-17
	Incorrect settings in “SP LEVEL”.	Adjust the “SP LEVEL” settings.	29
Only the center speaker outputs substantial sound.	When playing a monaural source with a CINEMA DSP program, the source signal is directed to the center channel, and the front and surround speakers output effect sounds.		
No sound is heard from the center speaker.	“CENTER” in “SPEAKER SET” is set to “NONE”.	Set “CENTER” to “SML” or “LRG”.	45
	One of the HiFi DSP programs (except for 5ch Stereo) has been selected.	Try another sound field program.	31
No sound is heard from the surround speakers.	“SUR. LR” in “SPEAKER SET” is set to “NONE”.	Set “SUR. LR” to “SML” or “LRG”.	45
	This unit is in the “STRAIGHT” mode and a monaural source is being played back.	Press STRAIGHT on the front panel so that “STRAIGHT” disappears from the front panel display.	33
No sound is heard from the subwoofer.	“BASS OUT” in “SPEAKER SET” is set to “FRNT” when a Dolby Digital or DTS signal is being played.	Set “BASS OUT” to “SWFR” or “BOTH”.	46
	“BASS OUT” in “SPEAKER SET” is set to “SWFR” or “FRNT” when a 2-channel source is being played.	Set “BASS OUT” to “BOTH”.	46
	The source does not contain low-frequency bass signals.		

Problem	Cause	Remedy	See page
Dolby Digital or DTS sources cannot be played. (Dolby Digital or DTS indicator in the front panel display does not light up.)	The connected component is not set to output Dolby Digital or DTS digital signals.	Make an appropriate setting following the operating instructions for your component.	—
	Audio input jack select is set to “ANALOG”.	Set Audio input jack select to “AUTO”.	29
A humming sound is heard.	Incorrect cable connections.	Connect the audio cables firmly. If the problem persists, the cables may be defective.	—
The volume level cannot be increased, or the sound is distorted.	You are attempting to set the volume level higher than the maximum volume level.	Adjust “MAX VOL.” setting.	48
	The component connected to the AUDIO OUT (REC) jacks of this unit is turned off.	Turn on the power of the component.	—
The sound effect cannot be recorded.	It is not possible to record the sound effect with a recording component.		
A source cannot be recorded by an analog component connected to the AUDIO OUT (REC) jacks.	The source component is not connected to the analog AUDIO IN jacks of this unit.	Connect the source component to the analog AUDIO IN jacks.	15, 17
The sound field parameters and some other settings of this unit cannot be changed.	“MEM. GUARD” in “OPTION MENU” is set to “ON”.	Set “MEM. GUARD” to “OFF”.	50
This unit does not operate properly.	The internal microcomputer has been frozen by an external electric shock (such as lightning or excessive static electricity) or by a power supply with low voltage.	Disconnect the power cable from the AC wall outlet and then plug it in again after about 30 seconds.	—
“CHECK SP WIRES” appears in the front panel display.	Speaker cables are short-circuited.	Make sure all speaker cables are connected correctly.	12
There is noise interference from digital or radio frequency equipment.	This unit is too close to the digital or high-frequency equipment.	Move this unit further away from such equipment.	—
The picture is disturbed.	The video source uses scrambled or encoded signals to prevent dubbing.		
This unit suddenly enters the standby mode.	The internal temperature is too high and the overheat protection circuitry has been activated.	Wait about 1 hour for this unit to cool down and then turn it back on.	—

■ Tuner

	Problem	Cause	Remedy	See page
FM	FM stereo reception is noisy.	The characteristics of FM stereo broadcasts may cause this problem when the transmitter is too far away or the antenna input is poor.	Check the antenna connections.	18
			Try using a high-quality directional FM antenna.	—
			Use the manual tuning method.	34
	There is distortion, and clear reception cannot be obtained even with a good FM antenna.	There is multi-path interference.	Adjust the antenna position to eliminate multi-path interference.	—
FM	The desired station cannot be tuned into with the automatic tuning method.	The signal is too weak.	Use a high-quality directional FM antenna.	—
			Use the manual tuning method.	34
	Previously preset stations can no longer be tuned into.	This unit has been disconnected for a long period.	Set preset stations.	35
AM	The desired station cannot be tuned into with the automatic tuning method.	The signal is weak or the antenna connections are loose.	Tighten the AM loop antenna connections and orient it for the best reception.	—
			Use the manual tuning method.	34
	There are continuous crackling and hissing noises.	Noises result from lightning, fluorescent lamps, motors, thermostats and other electrical equipment.	Use an outdoor antenna and a ground wire. This will help somewhat, but it is difficult to eliminate all noise.	—
	There are buzzing and whining noises.	A TV set is being used nearby.	Move this unit away from the TV set.	—

■ XM Satellite Radio (U.S.A. and Canada models only)

If an operation takes longer than usual or an error occurs, one of the following messages may appear in the front panel display. In this case, read the cause and follow the corresponding remedies.

Status message	Cause	Remedy	See page
CHECK ANTENNA	The XM Mini-Tuner and XM Dock are not connected to the XM jack of this unit or do not work properly.	Check XM Mini-Tuner and XM Dock connections and orient for the best reception level.	37
UPDATING	The XM user encryption code is being updated.	Wait until the encryption code is updated.	—
NO SIGNAL	The signal is too weak.	Adjust the orientation of the XM Mini-Tuner for the best reception level.	37
LOADING	It takes longer than four seconds for audio or text data to be decoded.	Wait until the decoding process has finished.	—
OFF AIR	The XM Satellite Radio channel you selected is not currently broadcasting any signals.	Check the channel number again or select another XM Satellite Radio channel.	—
<XM> - - -	The Channel Station ID (SID) is no longer available.		
- - - / - - -	No artist name or song title is available.		
<CAT> - - -	No channels are available for the selected category.	Select another channel category by pressing 4 CATEGORY (or ⓐ A-E/CAT . </>) repeatedly.	39

■ Remote control

Problem	Cause	Remedy	See page
The remote control does not work nor function properly.	Wrong distance or angle.	The remote control functions within a maximum range of 6 m (20 ft) and no more than 30 degrees off-axis from the front panel.	20
	Direct sunlight or lighting (from an inverter type of fluorescent lamp, etc.) is striking the remote control sensor of this unit.	Reposition this unit.	—
	The batteries are weak.	Replace all batteries.	3
	The remote control code is not correctly set.	Set the remote control code correctly using “List of remote control codes” at the end of this manual.	54
		Try setting another code for the same manufacturer using “List of remote control codes” at the end of this manual.	54
Even if the remote control code is correctly set, there are some models that do not respond to the remote control.			

■ Resetting the system

Use this feature to reset all the parameters of this unit to the initial factory settings.

1 Press ① **STANDBY/ON on the front panel to set this unit to the standby mode.**

2 Press and hold ⑩ **TONE CONTROL and then press ① **STANDBY/ON** to turn on this unit.**

The advanced setup menu appears in the front panel display.

3 Press ⑪ **PROGRAM </> to select “PRESET”.**

4 Press ⑫ **STRAIGHT repeatedly to select “RESET”.**

Select “CANCEL” to cancel the initialization procedure without making any changes.

5 Press ① **STANDBY/ON to confirm your selection and set this unit to the standby mode.**

Notes

- This procedure completely resets all the parameters of this unit including the set menu parameters. However, the advanced setup menu parameters will not be initialized.
- The initial factory settings are activated next time you turn on this unit.



To cancel the initialization procedure at any time without making any changes, press ⑫ **STRAIGHT** repeatedly to select “CANCEL” and then press ① **STANDBY/ON**.

Glossary

■ Audio information

Dolby Digital

Dolby Digital is a digital surround sound system that gives you completely independent multi-channel audio. With 3 front channels (front L/R and center), and 2 surround stereo channels, Dolby Digital provides 5 full-range audio channels. With an additional channel especially for bass effects, called LFE (Low Frequency Effect), the system has a total of 5.1-channels (LFE is counted as 0.1 channel). By using 2-channel stereo for the surround speakers, more accurate moving sound effects and surround sound environment are possible than with Dolby Surround. The wide dynamic range from maximum to minimum volume reproduced by the 5 full-range channels and the precise sound orientation generated using digital sound processing provide listeners with unprecedented excitement and realism. With this unit, any sound environment from monaural up to a 5.1-channel configuration can be freely selected for your enjoyment.

Dolby Pro Logic II

Dolby Pro Logic II is an improved technique used to decode vast numbers of existing Dolby Surround sources. This new technology enables a discrete 5-channel playback with 2 front left and right channels, 1 center channel, and 2 surround left and right channels instead of only 1 surround channel for conventional Pro Logic technology. There are three modes available: “Music mode” for music sources, “Movie mode” for movie sources and “Game mode” for game sources.

Dolby Surround

Dolby Surround uses a 4-channel analog recording system to reproduce realistic and dynamic sound effects: 2 front left and right channels (stereo), a center channel for dialog (monaural), and a surround channel for special sound effects (monaural). The surround channel reproduces sound within a narrow frequency range. Dolby Surround is widely used with nearly all video tapes and laser discs, and in many TV and cable broadcasts as well. The Dolby Pro Logic decoder built into this unit employs a digital signal processing system that automatically stabilizes the volume on each channel to enhance moving sound effects and directionality.

DTS (Digital Theater Systems)

Digital Surround

DTS digital surround was developed to replace the analog soundtracks of movies with a 5.1-channel digital sound track, and is now rapidly gaining popularity in movie theaters around the world. Digital Theater Systems Inc. has developed a home theater system so that you can enjoy the depth of sound and natural spatial representation of DTS digital surround in your home. This system produces practically distortion-free 5.1-channel sound (technically, left, right and center channels, 2 surround channels, plus an LFE 0.1 channel as a subwoofer, for a total of 5.1-channels).

LFE 0.1 channel

This channel reproduces low-frequency bass signals. The frequency range of this channel is from 20 Hz to 120 Hz. This channel is counted as 0.1 because it only enforces a low-frequency range compared to the full-range reproduced by the other 5 channels in Dolby Digital or DTS 5.1-channel systems.

Neural Surround

Neural Surround™ represents the latest advancement in surround technology and has been adopted by XM Satellite Radio for digital radio broadcast of surround recordings and live events in surround sound. Neural Surround™ employs psychoacoustic frequency domain processing which allows delivery of a more detailed sound stage with superior channel separation and localization of audio elements.

PCM (Linear PCM)

Linear PCM is a signal format under which an analog audio signal is digitized, recorded and transmitted without using any compression. This is used as a method of recording CDs and DVD audio. The PCM system uses a technique for sampling the size of the analog signal per very small unit of time. Standing for “Pulse Code Modulation”, the analog signal is encoded as pulses and then modulated for recording.

Sampling frequency and number of quantized bits

When digitizing an analog audio signal, the number of times the signal is sampled per second is called the sampling frequency, while the degree of fineness when converting the sound level into a numeric value is called the number of quantized bits. The range of rates that can be played back is determined based on the sampling rate, while the dynamic range representing the sound level difference is determined by the number of quantized bits. In principle, the higher the sampling frequency, the wider the range of frequencies that can be played back, and the higher the number of quantized bits, the more finely the sound level can be reproduced.

■ **Sound field program information**

CINEMA DSP

Since the Dolby Surround and DTS systems were originally designed for use in movie theaters, their effect is best felt in a theater having many speakers designed for acoustic effects. Since home conditions, such as room size, wall material, number of speakers, and so on, can differ so widely, it is inevitable that there are differences in the sound heard. Based on a wealth of actually measured data, Yamaha CINEMA DSP uses Yamaha original DSP technology to combine Dolby Pro Logic, Dolby Digital and DTS systems to provide the audiovisual experience of movie theater in the listening room of your own home.

SILENT CINEMA

Yamaha has developed a natural, realistic sound effect DSP algorithm for headphones. Parameters for headphones have been set for each sound field program so that accurate representations of all the sound field programs can be enjoyed on headphones.

Virtual CINEMA DSP

Yamaha has developed a Virtual CINEMA DSP algorithm that allows you to enjoy DSP surround effects even without any surround speakers by using virtual surround speakers. It is even possible to enjoy Virtual CINEMA DSP using a minimal two-speaker system that does not include a center speaker.

■ **Video information**

Component video signal

With the component video signal system, the video signal is separated into the Y signal for the luminance and the P_B and P_R signals for the chrominance. Color can be reproduced more faithfully with this system because each of these signals is independent. The component signal is also called the “color difference signal” because the luminance signal is subtracted from the color signal. A monitor with component input jacks is required in order to output component signals.

Composite video signal

With the composite video signal system, the video signal is composed of three basic elements of a video picture: color, brightness and synchronization data. A composite video jack on a video component transmits these three elements combined.

Specifications

AUDIO SECTION

- Minimum RMS Output Power for Front, Center, Surround
[U.S.A. and Canada models]
1 kHz, 0.9% THD, 8 Ω 100 W
[Other models]
1 kHz, 0.9% THD, 6 Ω 100 W
- Maximum Power (JEITA)
[U.S.A. and Canada models]
1 kHz, 10% THD, 8 Ω 135 W
[Asia, China, Korea and General models]
1 kHz, 10% THD, 6 Ω 135 W
- MAX Power Per Channel
[U.K. and Europe models]
1 kHz, 0.7% THD, 4 Ω 105 W or more
- IEC Power
[U.K. and Europe models]
1 kHz, 0.1% THD, 8 Ω 90 W or more
- Dynamic Power
[U.S.A. and Canada models] (Impedance Selector: 8 Ω)
(IHF, 8/6/4/2 Ω) 110/130/175/185 W
[Other models]
(IHF, 6/4/2 Ω) 105/135/165 W
- Dynamic Headroom
8 Ω 0.41 dB
- Frequency Response
CD, etc. to Front L/R 10 Hz to 100 kHz, 0/-3 dB
V-AUX to Front L/R 10 Hz to 20 kHz, 0/-3 dB
- Total Harmonic Distortion
CD, etc. (2ch stereo) to Front SP OUT,
50 W/8 Ω 0.06% or less
- Signal to Noise Ratio (IHF-A Network)
CD, etc. (STEREO) Input shorted (250 mV) 100 dB or more
- Residual Noise (IHF-A Network)
Front L/R 150 μV or less
- Channel Separation
CD, etc. Input 5.1 kΩ shorted (1 kHz/10 kHz)
..... 60 dB/45 dB or more
- Tone Control (Front L/R)
BASS Boost/Cut ±10 dB/100 Hz
TREBLE Boost/Cut ±10 dB/20 kHz
- Headphone Jack Rated Output/Impedance
1 kHz, 50 mV/8 Ω 150 mV/100 Ω
- Input Sensitivity/Input Impedance
CD, etc. 200 mV/47 kΩ
MULTI CH INPUT 200 mV/47 kΩ
- Maximum Input Signal
CD, etc. 1 kHz, 0.5%THD (EFFECT ON) 2.0 V or more
- Output Level/Output Impedance
AUDIO OUT (REC) 200 mV/1.2 kΩ
SUBWOOFER OUTPUT
(2ch Stereo and FRONT SP: SMALL) 4 V/1.2 kΩ
- Filter Characteristics (fc=40/60/80/90/100/110/120/160/200 Hz)
H.P.F. (Front, Center, Surround) 12 dB/oct.
L.P.F. (Subwoofer) 24 dB/oct.

VIDEO SECTION

- Signal Level
Composite 1 V_{p-p}/75 Ω
Component 1 V_{p-p}/75 Ω (Y)
- Video Maximum Input Level 1.5 V_{p-p} or more
- Signal to Noise Ratio 50 dB or more
- Frequency Response (MONITOR OUT)
Component Signal 5 Hz to 60 MHz, -3 dB

FM SECTION

- Tuning Range
[U.S.A. and Canada models] 87.5 to 107.9 MHz
[Asia and General models] 87.5/87.50 to 108.0/108.00 MHz
[Other models] 87.50 to 108.00 MHz
- 50 dB Quieting Sensitivity (IHF, 100% mod.)
Mono 2.8 μV (20.2 dBf)
- Signal to Noise Ratio (IHF)
Mono/Stereo 73 dB/70 dB
- Harmonic Distortion (1 kHz)
Mono/Stereo 0.5%/0.5%

AM SECTION

- Tuning Range
[U.S.A. and Canada models] 530 to 1710 kHz
[Asia and General models] 530/531 to 1710/1611 kHz
[Other models] 531 to 1611 kHz

GENERAL

- Power Supply
[U.S.A. and Canada models] 120 V AC, 60 Hz
[Australia model] 240 V AC, 50 Hz
[Korea model] 220 V AC, 60 Hz
[China model] 220 V AC, 50 Hz
[U.K. and Europe models] 230 V AC, 50 Hz
[Asia and General models]
..... 110-120/220-240 V AC, 50/60 Hz
- Power Consumption
[U.S.A. and Canada models] 240 W/320 VA
[Other models] 240 W
- Standby Power Consumption
[Except Asia and General models] 0.8 W
- Maximum Power Consumption
[Asia and General models]
5ch, 10%/THD 530 W
- Dimensions (W x H x D) 435 x 151 x 318 mm
(17-1/8" x 5-15/16" x 12-1/2")
- Weight 8.0 kg (17 lbs 10 oz)

* Specifications are subject to change without notice.

Index

■ Numerics

1 SOUND MENU	43
2 INPUT MENU	43, 48
2ch Stereo	31
3 OPTION MENU	44, 50
5ch Stereo	31

■ A

A)DISPLAY SET	50
A)INPUT ASSIGN	48
A)SPEAKER SET	45
A.DELAY	48
Activating XM Satellite Radio	38
Adjusting speaker levels	
during playback	29
Adjusting the tonal quality	29
All Channel Search mode	39
AM tuning	34
ANTENNA terminals	10
Audio cable plugs	14
Audio delay	48
AUDIO jacks	10, 14
Audio jacks	14
AUDIO SELECT	29, 50
Audio select	50
Audio settings	48
Automatic preset tuning	35
Automatic tuning	34

■ B

B)INPUT RENAME	49
B)MEMORY GUARD	50
B)SP LEVEL	46
BASIC SETUP	21, 43
Basic setup	43
BASS OUT	46

■ C

C)SP DISTANCE	47
C)VOLUME TRIM	49
Category Search mode	39
CD Music Listening	25
CD Listening	25
CENTER	45
Center graphic equalizer	47
Center speaker	45
Center width	32
CINEMA DSP indicator	19
COAXIAL INPUT assignment	48
COMPONENT VIDEO jacks	10, 14
Connecting a cable TV/satellite tuner ..	15
Connecting a CD player	17
Connecting a DVD player	15
Connecting a DVD recorder	15
Connecting a video monitor	15
Connecting audio components	17
Connecting speakers	12
Connecting the AM antennas	18
Connecting the FM antennas	18
Connecting the power cable	18

Connecting the

XM Mini-Tuner Dock	37
--------------------------	----

Connecting to the

CENTER terminals	13
------------------------	----

Connecting to the

COMPONENT VIDEO jacks	16
-----------------------------	----

Connecting to the

FRONT A terminals	13
-------------------------	----

Connecting to the

FRONT B terminals	13
-------------------------	----

Connecting to the

MULTI CH INPUT jacks	17
----------------------------	----

Connecting to the

SURROUND terminals	13
--------------------------	----

Connecting to the VIDEO AUX 16 |

Connecting video components 15 |

Controlling a TV 52 |

Controlling other components 53 |

Creating original SCENE templates 26 |

CROSSOVER 46 |

Crossover 46 |

CT WIDTH 32 |

■ D

D)CENTER GEQ	47
D)DECODER MODE	49
D)PARAM. INI	50
Decoder mode	49
Decoder select mode	49
DIGITAL AUDIO COAXIAL jacks	14
DIGITAL AUDIO OPTICAL jacks	14
DIGITAL INPUT jacks	10
DIMENSION	32
Dimension	32
DIMMER	50
Dimmer	50
Direct Number Access mode	39
Disc Listening	25
Display settings	50
Displaying the XM Satellite Radio	
information	41
DSP LEVEL	32
DSP level	32
DTS decoder indicator	19
DTS decoder prioritize setting	49
DVD Live Viewing	25
DVD Movie Viewing	25
DVD Viewing	25
DVR Viewing	25
Dynamic range	47

■ E

E)LFE LEVEL	47
E)MULTI CH SET	49
Editing sound fields parameters	32
ENHANCER indicator	19
Enjoying 2-channel sources using the	
standard decoders	32
Exchanging preset stations	36

■ F

F)D. RANGE	47
Factory presets	55
FL SCROLL	50
FM tuning	34
FRONT	45
FRONT B	45
FRONT B speaker setting	45
Front panel display	19
Front panel display scroll	50
Front speakers	45

■ G

G)AUDIO SET	48
Game	31
Game Playing	25

■ H

Hall	31
Headphone	47
Headphone dynamic range	47
Headphones indicator	19
HiFi DSP indicator	19
HP D.R	47
HP LFE	47

■ I

Infrared window	20
INI VOL.	48
Initial volume	48
Input assignment	48
Input channel and speaker indicators ..	19
Input channel indicators	19
Input menu	43
Input rename	49
Input source indicators	19
Input source information	30
Installing batteries	
in the remote control	3

■ J

Jazz	31
------------	----

■ L

LFE indicator	19
LFE/Bass out	46
Listening to unprocessed	
input signals	33
Low-frequency effect level	47

■ M

Manual preset tuning	35
MANUAL SETUP	43
Manual setup	43
Manual tuning	34
MAX VOL.	48
Maximum volume	48
MEM. GUARD	50
Memory guard	50
Movie Dramatic	31
Movie Spacious	31

MULTI CH INPUT jacks	10
Multi channel input setup	49
Multi-channel sources and sound field programs with headphones	33
Multi-information display	19
Music Disc Listening	25
Music Enh. 2ch	31
Music Enh. 5ch	31
MUTE indicator	19
MUTE TYP.	48
Muting type	48
■ N	
NIGHT indicator	19
Night listening mode	28
■ O	
OPTICAL INPUT assignment	48
Option menu	44
■ P	
Parameter initialization	50
PCM indicator	19
Placing speakers	11
Playing video sources in the background	30
Pop/Rock	31
PRESET	55
Preset SCENE templates	25
Preset Search mode	39
■ R	
Radio Listening	25
Rear panel	10
Remote control codes	iii
Resetting the system	60
■ S	
SCENE 1	8
SCENE 2	8
SCENE 3	8
SCENE 4	8
Selecting audio input jacks	29
Selecting preset stations	36
Selecting the MULTI CH INPUT component as the input source	28
Selecting the night listening mode	28
Selecting the SCENE templates	23
Set menu	43
Set this unit to the standby mode	18
Setting input source of the customized SCENE template on the remote control	51
Setting remote control codes	54
Setting the speaker impedance	13
Setting XM Satellite Radio preset	40
SILENT CINEMA	33
SILENT CINEMA indicator	19
SLEEP indicator	19
Sleep timer	30
Sound field programs	31
Sound menu	43
SP A B indicators	19
SP D.R	47
SP IMP.	55
SP LFE	47
Speaker	47
Speaker distance	47
Speaker distances	47
Speaker dynamic range	47
Speaker impedance	55
Speaker level	46
Speaker settings	45
SPEAKERS terminals	10
Specifications	63
Straight mode	33
SUBWOOFER OUTPUT jack	10
Subwoofer phase	46
Supplied accessories	3
SUR. LR	45
Surround left/right speakers	45
SWFR PHASE	46
■ T	
TEST	47
Test tone	47
Troubleshooting	56
TU	55
Tuner frequency step	55
Tuner indicators	19
Turning off the power	18
Turning on the power	18
TV Sports	31
TV Sports Viewing	25
TV Viewing	25
■ U	
UNIT	47
Unit	47
Using the remote control	20
Using your headphones	28
■ V	
Video cable plugs	14
VIDEO jacks	10, 14
Video jacks	14
VIRTUAL indicator	19
VOLTAGE SELECTOR	3
VOLUME level indicator	19
Volume Trim	49
■ X	
XM jack	10
XM Listening	25
XM Satellite Radio tuning	37

■ Front panel

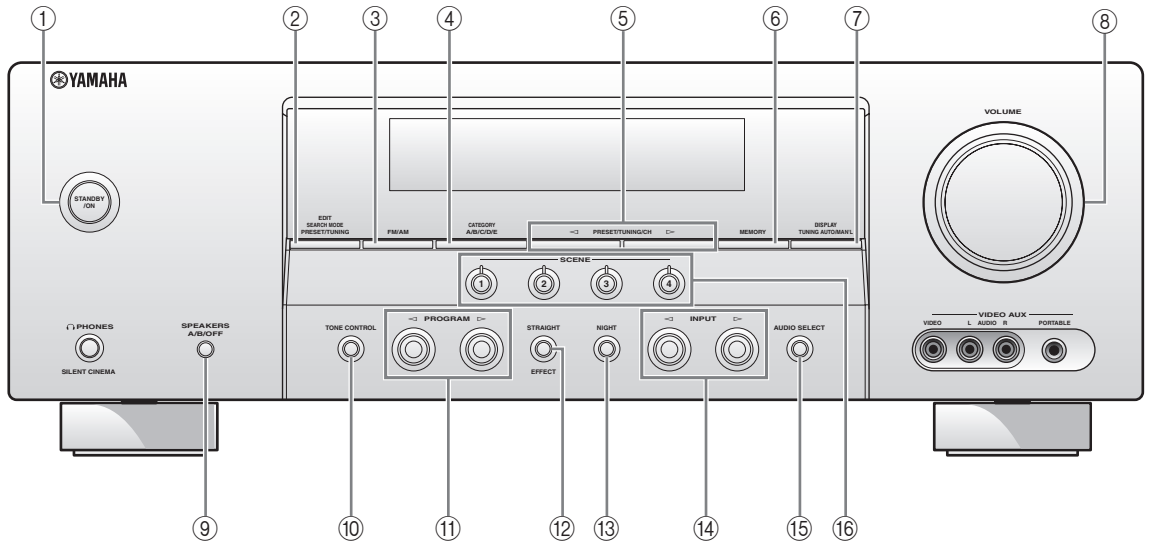

■ Remote control

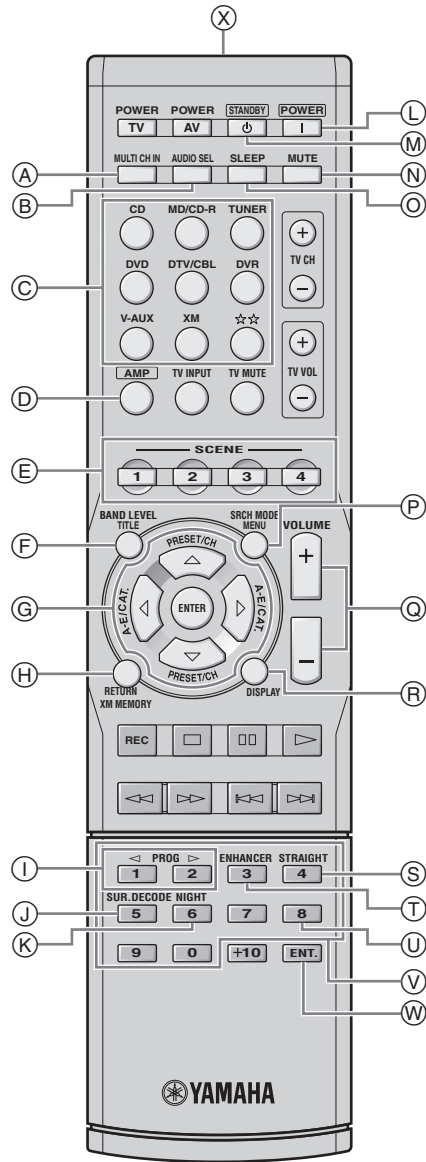

List of remote control codes

TV		BELL & HOWELL		DAINICHI	0200, 0209, 0218	FUTURETECH	
ACER	0093	0058, 0064		DANSAI	0200, 0206, 0213, 0217	GATEWAY	0062
ACME	0207	BENQ	0051, 0081			GBC	0208, 0215, 0218
ACURA	0208	BEON	0213, 0217	DANTAX	0217	GE	0057, 0060, 0061, 0122, 0147
ADA	0255	BESTAR	0213	DAYTRON	0060, 0061, 0208	GEC	0204, 0207, 0211, 0213, 0217
ADC	0206	BINATONE	0207	DE GRAAF	0210	GELOSO	0208, 0210, 0215
ADMIRAL	0058, 0205, 0206, 0210, 0211	BLACK STAR	0214	DECCA	0204, 0207, 0213, 0217	GENERAL TECHNIC	0208
ADYSON	0200, 0207	BLAUPUNKT	0255	DESMET	0213, 0217	GENEXXA	0209, 0211, 0213, 0218
AGASHI	0200	BLUE SKY	0209, 0218	DIAMOND	0200	GIBRALTER	0060
AGAZI	0206	BONDSTEC	0214	DIMENSIA	0057	GOLDHAND	0200
AGB	0204	BOOTS	0207	DIXI	0208, 0213, 0217	GOLDSTAR	0060, 0061, 0127, 0128, 0200, 0201, 0207, 0208, 0210, 0213, 0214, 0215, 0217
AIKO	0127, 0200, 0207, 0208	BRANDT	0216, 0226	DTS	0208	GOODMANS	0171, 0201, 0204, 0206, 0208, 0213, 0217, 0240
AIWA	0028, 0139, 0229, 0237	BRIONVEGA	0205, 0213, 0217	DUAL	0207, 0215, 0216	GPM	0209, 0218
AKAI	0059, 0065, 0127, 0129, 0130, 0200, 0204, 0208, 0209, 0213, 0217, 0218, 0255	BRITANNIA	0200, 0207	DUAL-TEC	0207, 0208, 0215	GRAETZ	0211
AKIBA	0209, 0218	BROCKWOOD	0060	DUMONT	0060, 0127, 0205, 0207	GRANADA	0204, 0207, 0210, 0213, 0217
AKURA	0206, 0209, 0218	BROKSONIC	0138	DURABRAND	0126	GRANDIN	0208, 0209, 0217
ALARON	0200	BRUNS	0205	DUX	0217	GRUNDIG	0128, 0130, 0222, 0236, 0255
ALBA	0200, 0207, 0208, 0209, 0217, 0218	BSR	0215	DYNATRON	0213, 0217	GRUNPY	0062
ALBIRAL	0212	BTC	0209, 0218	ELBE	0203, 0204, 0212, 0218	HALIFAX	0200, 0206, 0207
ALLSTAR	0213	BUSH	0177, 0208, 0209, 0210, 0213, 0215, 0216, 0217, 0218, 0230, 0237	ELBE-SHARP	0204	HALLMARK	0060, 0061
AMPLIVISION	0207	CANDLE	0060, 0061	ELCIT	0204, 0205	HAMPTON	0200, 0207
AMSTRAD	0204, 0206, 0208, 0209, 0218	CAPSONIC	0206	ELECTRO TECH	0208	HANSEATIC	0203, 0207, 0208, 0213, 0215, 0217
AMTRON	0062	CASCADE	0208	ELECTROBAND	0059	HANTAREX	0204, 0208
ANAM	0208	CATHAY	0213, 0217	ELECTROHOME	0059, 0060, 0061	HARVARD	0062
ANAM NATIONAL	0062	CCE	0127	ELIN	0200, 0207, 0213, 0217	HCM	0206, 0207, 0208, 0218
ANGLO	0208	CELEBRITY	0059	ELITE	0209, 0213, 0218	HIFIVOX	0216
ANITECH	0206, 0208	CENTURION	0213, 0217	ELMAN	0215	HIGASHI	0200
ANSONIC	0203, 0208	CENTURY	0205	ELTA	0200, 0208	HINARI	0208, 0209, 0213, 0217, 0218
AOC	0060, 0061	CGE	0214, 0215	EMERSON	0060, 0061, 0062, 0064, 0128, 0205	HISAWA	0209, 0218
APEX	0118, 0122, 0132	CIMLINE	0208, 0218	ENVISION	0060, 0061	HITACHI	0006, 0014, 0015, 0016, 0042, 0060, 0061, 0095, 0105, 0127, 0156, 0179, 0180, 0204, 0207, 0210, 0211, 0215, 0216, 0251
ARC EN CIEL	0216	CITIZEN	0060, 0061, 0062, 0064	ERRES	0213, 0217		
ARCAM	0200	CITY	0208	ESA	0080		
ARCAM DELTA	0207	CLARIVOX	0212, 0217	ETRON	0208		
ARISTONA	0213, 0217	CLATRONIC	0206, 0207, 0208, 0209, 0213, 0214, 0218	EURO-FEEL	0206		
ASA	0205, 0211	CMS	0200	EUROLINE	0217		
ASBERG	0213	COLORTYME	0060, 0061	EUROMAN	0200		
ASTRA	0208	CONCERTO	0060, 0061	EUROMANN	0206, 0207, 0213		
ASUKA	0200, 0206, 0207, 0209, 0218	CONCORDE	0208	EUROPHON	0200, 0204, 0207, 0213, 0215		
ATLANTIC	0200, 0207, 0213, 0217	CONDOR	0200, 0207, 0213	FENNER	0208		
ATORI	0208	CONTEC	0200, 0207, 0208	FERGUSON	0212, 0217, 0226		
AUDIOSONIC	0207, 0208, 0209, 0213, 0216, 0217, 0218	CONTEC/CONY	0062	FIDELITY	0200, 0207, 0210		
AUDIOTON	0207	CONTINENTAL EDISON	0216	FINLANDIA	0210		
AUDIOVOX	0062	COSMEL	0208	FINLUX	0204, 0205, 0207, 0213, 0215, 0217		
AUTOVOX	0205, 0206, 0207	CRAIG	0062	FIRSTLINE	0200, 0207, 0208, 0213, 0214		
AWA	0200	CROSLEY	0205, 0214, 0215	FISHER	0064, 0127, 0128, 0205, 0207, 0215		
BAIRD	0216	CROWN	0062, 0063, 0128, 0208, 0213, 0217	FLINT	0213, 0218		
BANG & OLUFSEN	0205	CS ELECTRONICS	0200, 0207, 0209, 0214, 0218	FORMENTI	0200, 0205, 0207, 0215, 0217		
BASIC LINE	0208, 0209, 0213, 0218	CTC	0214	FORMENTI-PHOENIX	0200		
BASTIDE	0207	CURTIS MATHES	0057, 0060, 0061, 0064, 0065	FORTRESS	0205		
BAUR	0217	CXC	0062	FRONTECH	0206, 0208, 0210, 0211, 0214		
BEKO	0228	CYBERTRON	0209, 0218	FUJITSU	0023, 0024, 0025, 0088, 0127		
BELCOR	0060	DAEWOO	0060, 0061, 0120, 0127, 0155, 0193, 0200, 0207, 0208, 0213, 0218, 0238	FUNAI	0033, 0034, 0035, 0036, 0037, 0062, 0206		
						INDIANA	0213, 0217
						INFINITY	0063
						INGELEN	0211
						INGERSOL	0208

INNO HIT	0201, 0204, 0207, 0208, 0209, 0213, 0217, 0218	MAGNADYNE	0204, 0205, 0214, 0215, 0217	OLEVIA	0052, 0084	PROTECH	0206, 0207, 0208, 0213, 0214, 0215, 0217
INNOVATION	0206, 0208	MAGNAFON	0200, 0204, 0207	ONCEAS	0207	PROTON	0060, 0061
INTERBUY	0208, 0214	MAGNAVOX	0060, 0061, 0063, 0102, 0103, 0150	ONWA	0062, 0218	PROVIEW	0050
INTERFUNK	0205, 0211, 0213, 0214, 0216, 0217	MAGNUM	0206, 0208	ORBIT	0213	PROVISION	0217
INTERNATIONAL	0200	MAJESTIC	0058	ORION	0126, 0204, 0208, 0213, 0217, 0235	PULSAR	0060
INTERVISION	0206, 0207, 0218	MANDOR	0206	ORLINE	0218	PYE	0213, 0217
IRRADIO	0201, 0208, 0209, 0213, 0217, 0218	MANESTH	0206, 0207, 0213, 0217	ORSOWE	0204	PYMI	0208
ISUKAI	0209, 0218	MARANTZ	0060, 0061, 0063, 0090, 0213, 0217	OSAKI	0127, 0206, 0207, 0209, 0218	QUASAR	0152, 0214
ITC	0207, 0215	MARELLI	0205	OSIO	0201	QUELLE	0201, 0206, 0207, 0213, 0214, 0215, 0217
ITS	0200, 0209, 0213, 0218	MARK	0200, 0213, 0217	OSOME	0218	RADIALVA	0218
ITT	0129, 0208, 0211	MATSUI	0204, 0207, 0208, 0210, 0213, 0217	OTTO VERSAND	0204, 0207, 0213, 0215, 0216, 0217, 0255	RADIO SHACK	0064
ITV	0208, 0217	MEDIATOR	0213, 0217	PAEL	0200, 0207	RADIO SHACK/REALISTIC	0057, 0060, 0061, 0062, 0064
JBL	0063	MEDION	0206, 0208	PALLADIUM	0207	RADIOLA	0213, 0217
JC PENNEY	0057, 0060, 0061	MEGATRON	0061	PANAMA	0200, 0206, 0207, 0208	RADIOMARELLI	0204, 0205, 0214
JCB	0059	MELECTRONIC	0200, 0207, 0208, 0211, 0213, 0216, 0217	PANASONIC	0006, 0007, 0063, 0073, 0074, 0097, 0110, 0114, 0137, 0141, 0151, 0162, 0165, 0186, 0204, 0211, 0244, 0245, 0246, 0254	RADIOTONE	0213
JENSEN	0060, 0061	MEMOREX	0058, 0061, 0064, 0208	PATHE CINEMA	0200, 0203, 0207, 0212, 0215	RCA	0057, 0060, 0061, 0091, 0133, 0135, 0147, 0149
JVC	0017, 0018, 0019, 0108, 0136, 0153, 0178, 0190, 0213, 0218	MEMPHIS	0208	PATHE MARCONI	0212, 0216	REALISTIC	0064
KAISUI	0200, 0207, 0208, 0209, 0218	METZ	0205	PAUSA	0208	REVOX	0213, 0217
KAMOSONIC	0207	MGA	0060, 0061	PERDIO	0200	REX	0206, 0210, 0211
KAMP	0200, 0207	MICROMAXX	0206, 0208	PHILCO	0060, 0061, 0063, 0128, 0205, 0214, 0215	RFT	0203, 0205
KAPSCH	0211	MICROSTAR	0206, 0208	PHILHARMONIC	0207	RHAPSODY	0200
KARCHER	0207, 0208, 0212, 0217	MINERVA	0204	PHILIPS	0040, 0060, 0063, 0072, 0115, 0116, 0124, 0130, 0150, 0175, 0184, 0187, 0205, 0207, 0213, 0215, 0217, 0220, 0221, 0232, 0233, 0252, 0253	R-LINE	0213, 0217
KAWASHO	0059, 0060, 0061, 0200	MINOKA	0213	PHILIPS MAGNAVOX	0124	ROADSTAR	0206, 0208, 0209, 0218, 0237
KENDO	0128, 0210	MITSUBISHI	0006, 0015, 0016, 0048, 0060, 0061, 0104, 0112, 0113, 0125, 0205, 0213	PHOENIX	0200, 0205, 0213, 0217	ROBOTRON	0205
KENNEDY	0215	MONTGOMERY WARD	0058	PHONOLA	0200, 0205, 0213, 0217	ROWA	0200
KENWOOD	0060, 0061	MTC	0060, 0061, 0128, 0200	PILOT	0060	RTF	0205
KINGSLEY	0200, 0207	MULTI SYSTEM	0217	PIONEER	0012, 0013, 0060, 0061, 0098, 0109, 0117, 0128, 0181, 0182, 0194, 0195, 0211, 0213, 0216, 0217, 0250	SABA	0204, 0205, 0211, 0216
KLOSS NOVABEAM	0062	MULTITECH	0062, 0127, 0128, 0200, 0207, 0208, 0210, 0214, 0215, 0217	PLANTRON	0206, 0213	SACCS	0212
KNEISSEL	0203	MURPHY	0200, 0207	POLAROID	0075	SAISHO	0204, 0206, 0207, 0208
KOLSTER	0213	NAD	0061	POPPI	0208	SALORA	0201, 0204, 0210, 0211, 0215
KONKA	0209, 0218	NAONIS	0210	PORTLAND	0060, 0061	SAMBERS	0204
KORPEL	0213, 0217	NEC	0026, 0053, 0060, 0061, 0096, 0127	PRANDONI-PRINCE	0204, 0210	SAMPO	0060, 0061, 0083, 0101
KORTING	0205	NECKERMANN	0205, 0207, 0210, 0213, 0217, 0255	PRECISION	0207	SAMSUNG	0029, 0030, 0031, 0032, 0044, 0045, 0046, 0047, 0060, 0061, 0065, 0068, 0069, 0071, 0079, 0087, 0127, 0128, 0130, 0144, 0160, 0161, 0170, 0176, 0183, 0185, 0200, 0201, 0206, 0207, 0208, 0213, 0217, 0239, 0241, 0242, 0243
KOYODA	0208	NEI	0213, 0217	PRIMA	0208, 0211	SANDRA	0200, 0207
KTV	0062, 0127, 0207	NESCO	0214	PROFEX	0208	SANSUI	0123, 0126, 0213
KYOTO	0200, 0212	NET-TV	0082, 0101	PROFI-TRONIC	0213	SANYO	0020, 0021, 0022, 0049, 0060, 0064, 0127, 0128, 0200, 0203, 0207, 0215
LENCO	0208	NEW TECH	0208, 0213	PROLINE	0213	SBR	0217
LENOIR	0207, 0208	NEW WORLD	0209, 0218	PROSCAN	0057	SCHAUB LORENTZ	0200, 0207
LESA	0214	NICAMAGIC	0200, 0207	PROSONIC	0200, 0207, 0217	SCHEIDER	0207, 0209, 0213, 0215, 0216, 0217, 0218
LEYCO	0206, 0213, 0217	NIKKAI	0200, 0206, 0207, 0209, 0213, 0217, 0218	PROSCAN	0057	SCOTCH	0061
LG	0016, 0038, 0039, 0127, 0128, 0157, 0158, 0163, 0164, 0166, 0188, 0189, 0200, 0201, 0207, 0208, 0210, 0213, 0214, 0215, 0217	NOBLIKO	0200, 0207	PROSONIC	0200, 0207, 0217	SCOTT	0060, 0061, 0062
LIESENK	0217	NOGAMATIC	0216				
LIFE	0206, 0208	NOKIA	0129, 0211				
LIFETEC	0206, 0208, 0218	NORDMENDE	0205, 0211, 0213, 0216				
LOEWE	0063, 0128, 0203, 0204, 0223, 0227	NORDVISION	0217				
LOEWE OPTA	0205, 0213, 0217	OCEANIC	0211				
LOGIK	0058						
LUMA	0210, 0217						
LUMATRON	0210, 0213, 0217						
LUX MAY	0213						
LUXMAN	0060, 0061						
LUXOR	0201, 0207, 0210						
LXI	0057, 0061, 0063, 0064						
MAG	0050						

SEARS	0057, 0060, 0061, 0064	TEKNIKA	0058, 0060, 0061, 0062	YAMAHA	0000, 0001, 0002, 0003, 0005, 0060, 0061	SAMSUNG	1021, 1021, 2041, 2104
SEG	0200, 0206, 0207, 0214, 0215, 0217	TELEAVIA	0216	YAMISHI	0218	SHARP	1023, 1073, 2043, 2106
SEI	0204	TELECOR	0218	YOKO	0200, 0206, 0207, 0208, 0209, 0213, 0217, 0218	SONY	1019, 1074, 2039, 2107
SEI-SINUDYNE		TELEFUNKEN	0065, 0213, 0216			TOSHIBA	1024, 1075, 2044, 2108
	0204, 0205, 0211	TELEGAZI	0218			ZENITH	1026, 2047
SELECO	0210, 0211, 0215	TELETECH	0208, 0214, 0217	YORX	0209, 0218		
SENCORA	0208	TELETON	0207	ZANUSSI	0210		
SENTRA	0218	TELEVIDEON	0200	ZENITH	0058, 0060, 0100, 0105, 0119, 0121, 0154		
SERINO	0200	TENSAI	0208, 0209, 0213, 0218				
SHARP	0009, 0010, 0011, 0060, 0061, 0066, 0070, 0087, 0111, 0143, 0145, 0167, 0168, 0169, 0198, 0204, 0224, 0247, 0248, 0249	TESMET	0213				
		TEVION	0206, 0208				
SHOGUN	0060	TEXET	0200, 0207				
SIAREM	0204, 0205, 0215	THOMSON	0191, 0192, 0207, 0213, 0216, 0226				
SICATEL	0212	THORN	0212, 0217				
SIEMENS	0255	TMK	0060, 0061				
SIERRA	0213	TOKAI	0213				
SIGNATURE	0058	TOKYO	0200, 0207				
SILVA	0200	TOSHIBA	0027, 0043, 0053, 0054, 0064, 0078, 0089, 0090, 0106, 0107, 0127, 0131, 0140, 0146, 0159, 0197, 0225, 0231, 0237				
SINGER	0205, 0214, 0215	TOWADA	0211, 0215				
SINUDYNE	0204, 0205, 0215, 0217	TRANSTEC	0200				
SKANTIC	0211	TRIDENT	0204				
SOLAVOX	0211	TRISTAR	0218				
SONOKO	0206, 0207, 0208, 0213, 0217	TRIUMPH	0204				
		UHER	0211, 0213				
SONOLOR	0211	ULTRAVOX	0200, 0205, 0207, 0214, 0215				
SONTEC	0213, 0217	UNITED	0217				
SONY	0041, 0059, 0067, 0085, 0086, 0174, 0196, 0199, 0208, 0219, 0234	UNIVERSUM	0127, 0128, 0129, 0201, 0206, 0213, 0214, 0215, 0217				
SOUND & VISION	0209, 0218	UNIVOX	0212				
SOUNDESIGN	0060, 0061, 0062	VESTEL	0210, 0211, 0213, 0214, 0215, 0217				
SOUNDWAVE	0213, 0217	VEXA	0208, 0217				
SSS	0060, 0062	VICTOR	0213				
STANDARD	0207, 0208, 0209, 0213, 0218	VIDEOLOGIC	0200				
STARLIGHT	0217	VIDEOLOGIQUE	0200, 0207, 0209, 0218				
STARLITE	0062	VIDEOSAT	0214				
STENWAY	0218	VIDEOSYSTEM	0213				
STERN	0210, 0211	VIDEOTECHNIC	0200				
SUNKAI	0208, 0218	VIDTECH	0060, 0061				
SUNWOOD	0208, 0213	VIEWSONIC	0076, 0077, 0092, 0099, 0172, 0173				
SUPERLA	0200, 0204, 0207	VISIOLA	0200, 0207				
SUPERTECH	0200	VISION	0213				
SUPRA	0208	VORTEC	0213, 0217				
SUPREME	0059	VOXSON	0205, 0210, 0211, 0213				
SUSUMU	0209	WALTHAM	0207, 0212				
SUTRON	0208	WARDS	0057, 0058, 0060, 0061, 0063				
SYDNEY	0200, 0207	WATSON	0213, 0217, 0218				
SYLVANIA	0060, 0061, 0063, 0080, 0134, 0142, 0148	WATT RADIO	0200, 0207, 0212, 0215				
		WEGA	0205				
SYMPHONIC	0062, 0080	WELTBlick	0213, 0217				
SYSLINE	0217	WESTON	0215				
SYTONG	0200	WHITE WESTINGHOUSE	0008, 0200, 0207, 0217				
TANDY	0127, 0207, 0209, 0211, 0218	WINCOM	0055, 0056				
TASHIKO	0200, 0207, 0210						
TATUNG	0127, 0204, 0207, 0213, 0217, 0237						
TCM	0206, 0208						
TEAC	0127						
TEC	0207, 0208, 0214, 0215						
TECHWOOD	0060, 0061						

VCR

ADMIRAL	1008, 1013
ADVENTURA	1005
AIWA	1005, 1042, 1043, 1044, 1066
AKAI	1007, 1043
AKIBA	1050
AKURA	1043, 1050
ALBA	1044, 1050
AMERICAN HIGH	1004
AMSTRAD	1042
ANITECH	1050
ASA	1045, 1046
ASHA	1002, 1014
ASUKA	1042, 1045, 1046, 1050
AUDIO DYNAMICS	1000
AUDIOVOX	1003
BAIRD	1042, 1043, 1047
BASIC LINE	1044, 1050
BAUR	1046
BEAUMARK	1002, 1014
BELL & HOWELL	1001
BLAUPUNKT	1046, 1048
BROKSONIC	1012, 1013
BUSH	1044, 1050, 1066
CALIX	1003
CANDLE	1002, 1003
CANON	1004
CCE	1006
CGE	1042, 1043
CIMLINE	1044, 1050
CITIZEN	1002, 1003
COLORTYME	1000
COLT	1006
CRAIG	1002, 1003, 1006, 1014
CROWN	1050
CURTIS MATHES	1000, 1002, 1004, 1009
CYBERNEX	1002, 1014
DAEWOO	1005, 1038, 1061, 1067
DANSAI	1050
DANTAX	1044
DBX	1000
DE GRAAF	1046, 1049
DECCA	1042, 1043, 1046
DENON	1010
DIMENSIA	1009
DUAL	1043, 1046
DUMONT	1042, 1046, 1047, 1049
DYNATECH	1005
ELECTROHOME	1003
ELECTROPHONIC	1003
ELTA	1050

TV/DVD COMBO

AIWA	0139, 2055
APEX	0132, 2049
BROKSONIC	0138, 2060
BUSH	0230, 2112
JVC	0136, 2053
PANASONIC	0137, 2054, 0254, 2110
RCA	0133, 0135, 2050, 2051
SYLVANIA	0134, 2052
THOMSON	0226, 2109
TOSHIBA	0131, 2048, 0231, 2111

TV/DVD/VCR COMBO

PANASONIC	0141, 1040, 2057
SAMSUNG	0241, 1070, 2113
SHARP	0143, 1028, 2059
SYLVANIA	0142, 1041, 2058
TOSHIBA	0140, 1029, 2056

TV/VCR COMBO

AIWA	0237, 1066
BUSH	0237, 1066
DAEWOO	0155, 0238, 1038, 1067
GE	0147, 1030
GOODMANS	0240, 1069
GRUNDIG	0236, 1062
HITACHI	0156, 1039
JVC	0153, 1036
MAGNAVOX	0150, 1033
ORION	0235, 1065
PANASONIC	0151, 1034
PHILIPS	0150, 0232, 0233, 1033, 1062, 1063
QUASAR	0152, 1035
RCA	0149, 1032
ROADSTAR	0237, 1066
SAMSUNG	0144, 0239, 1027, 1068
SHARP	0145, 1028
SONY	0234, 1064
SYLVANIA	0148, 1031
TATUNG	0237, 1066
TOSHIBA	0146, 0237, 1029, 1066
ZENITH	0154, 1037

DVD/VCR COMBO

JVC	1017, 1017, 2045, 2045
LG	1071, 2087
PANASONIC	1020, 1072, 2040, 2105
PHILIPS	1025, 2046
RCA	1022, 2042

EMERSON	1003, 1004, 1005, 1012, 1013	KENWOOD	1000, 1001, 1007, 1011, 1043	PANASONIC	1004, 1020, 1034, 1040, 1048, 1054, 1072	SIEMENS	1045, 1047
ETZUKO	1050	KLH	1006			SIGNATURE 2000	1008
FERGUSON	1043	KODAK	1003, 1004	PATHE MARCONI	1043	SILVA	1045
FIDELITY	1042	KORPEL	1050			SINGER	1004, 1006
FINLANDIA	1046, 1047, 1049	LEYCO	1050	PENNEY	1010, 1014	SINUDYNE	1046
FINLUX	1042, 1043, 1046, 1047, 1049	LG	1003, 1042, 1045, 1071	PENTAX	1010, 1049	SONTEC	1045
FIRST LINE	1044, 1045, 1049, 1050	LIFETEC	1044, 1048	PERDIO	1042	SONY	1016, 1019, 1055, 1060, 1064, 1074
FISHER	1001, 1047	LLOYD'S	1005	PHILCO	1004, 1051	STS	1004, 1010
FLINT	1044	LOEWE	1048	PHILIPS	1004, 1025, 1033, 1046, 1056, 1057, 1059, 1062, 1063	SUNKAI	1044
FORMENTI/PHOENIX	1046	LOEWE OPTA	1045, 1046	PHILIPS MAGNAVOX	1018	SUNSTAR	1042
FUJI	1004	LOGIK	1006, 1050			SUNTRONIC	1042
FUJITSU	1042	LUXOR	1047	PHONOLA	1046	SUNWOOD	1050
FUNAI	1005, 1042	LXI	1003	PILOT	1003	SYLVANIA	1004, 1005, 1031, 1041
GALAXY	1042	M ELECTRONIC	1042	PIONEER	1011, 1046	SYMPHONIC	1005
GARRARD	1005	MAGNASONIC	1047	PRINZ	1042	TAISHO	1044
GBC	1050			PROFEX	1050	TANDY	1001
GE	1002, 1004, 1009, 1014, 1030	MAGNAVOX	1004, 1018, 1033	PROFITRONIC	1014	TASHIKO	1003, 1042
GEC	1046	MAGNIN	1003, 1014			TATUNG	1007, 1042, 1043, 1046, 1066
GELOSO	1050	MANESTH	1050	PROLINE	1042	TCM	1044, 1048
GENERAL TECHNIC	1044, 1048	MARANTZ	1000, 1001, 1004, 1046, 1051	PROSCAN	1009	TEAC	1005, 1007
GO VIDEO	1014	MARTA	1003	PROSONIC	1044	TECHNICS	1004, 1048
GOLDHAND	1050	MATSUI	1044, 1045	PYE	1046, 1056	TEKNIKA	1003, 1004, 1005
GOLDSTAR	1000, 1003, 1042, 1045	MATSUSHITA	1004	PROTEC	1006	TELEAVIA	1043
GOODMANS	1042, 1045, 1050, 1069	MEDIATOR	1046	QUARTER	1001	TELEFUNKEN	1043
GRADIENSTE	1005	MEDION	1044, 1048	QUARTZ	1001, 1047	TENOSAL	1050
GRAETZ	1043, 1047	MEI	1004	QUASAR	1004, 1035	TENSAI	1042, 1045, 1050
GRANADA	1046, 1047, 1049	MEMOREX	1001, 1002, 1003, 1004, 1005, 1008, 1013, 1014, 1042, 1045, 1047	QUELLE	1042, 1046, 1047	TEVION	1044, 1048
GRANDIN	1042, 1045, 1050			RADIO SHACK	1003	THOMSON	1043, 1058
GRUNDIG	1046, 1050, 1062	MEMPHIS	1050			THORN	1043, 1047
HANSEATIC	1045, 1046	METZ	1048	RADIO SHACK/REALISTIC	1001, 1002, 1003, 1004, 1005, 1008	TMK	1002, 1014
HARLEY DAVIDSON	1005	MGA	1014			TOKAI	1045, 1050
HARMAN/KARDON	1000	MGN TECHNOLOGY	1002, 1014	RADIOLA	1046	TONSAI	1050
HARWOOD	1006	MICROMAXX	1044, 1048	RADIX	1003	TOSHIBA	1013, 1024, 1029, 1043, 1046, 1066, 1075
HCM	1050	MICROSTAR	1044, 1048	RANDEX	1003	TOTEVISION	1002, 1003, 1014
HEADQUARTER	1001	MIGROS	1042	RCA	1002, 1004, 1009, 1010, 1014, 1015, 1022, 1032	TOWADA	1050
HINARI	1044, 1050	MINOLTA	1010	REALISTIC	1001, 1002, 1003, 1004, 1005, 1008	TOWIKA	1050
HISAWA	1044	MITSUBISHI	1011, 1042, 1046	REX	1043	UHER	1045
HITACHI	1007, 1010, 1039, 1042, 1043, 1046, 1049	MONTGOMERY WARD	1008	RFT	1046	UNITECH	1002, 1014
HUGHES NETWORK SYSTEMS	1010	MOTOROLA	1004, 1008	ROADSTAR	1045, 1050, 1066	UNIVERSUM	1042, 1045, 1046
HYPSON	1044, 1050	MTC	1002, 1014	SABA	1043	VECTOR RESEARCH	1000
IMPERIAL	1042	MULTITECH	1002, 1005, 1006, 1042, 1046, 1050	SAISHO	1044, 1050	VIDEO CONCEPTS	1000
INNO HIT	1046, 1050	MURPHY	1042	SALORA	1047	VIDEON	1044, 1048
INNOVATION	1044, 1048	NATIONAL	1048	SAMSUNG	1002, 1014, 1021, 1027, 1052, 1068, 1070	VIDEOSONIC	1002, 1014
INSTANT REPLAY	1004	NEC	1000, 1001, 1007, 1011, 1043, 1051	SANKY	1008	WARDS	1002, 1003, 1004, 1005, 1006, 1008, 1010, 1014
INTERBUY	1045	NECKERMANN	1043, 1046	SANSUI	1007, 1011, 1013, 1043	WELTBlick	1045
INTERFUNK	1046, 1047	NEI	1046	SANYO	1001, 1002, 1014, 1047	WHITE WESTINGHOUSE	1013
INTERVISION	1042	NESCO	1050	SBR	1046	XR-1000	1004, 1005, 1006
IRRADIO	1045, 1050	NIKKO	1003	SCHAUB LORENZ	1042, 1043, 1047	YAMAHA	1000, 1001, 1007
ITT	1043, 1047	NOBLEX	1002, 1014	SCHNEIDER	1042, 1044, 1045, 1046, 1050	YAMISHI	1050
ITV	1045	NOKIA	1043, 1047			YOKAN	1050
JC PENNEY	1000, 1001, 1002, 1003, 1004, 1006	NORDMENDE	1043	SCOTT	1012	YOKO	1045, 1050
JCL	1004	OCEANIC	1042, 1043	SEARS	1001, 1003, 1004, 1010	ZENITH	1013, 1026, 1037
JENSEN	1007	OKANO	1044	SEG	1050		
JVC	1000, 1001, 1007, 1011, 1017, 1036, 1043	OLYMPUS	1004	SEI-SINUDYNE	1046	DVD	
KAISUI	1050	OPTIMUS	1003, 1008			ACOUSTIC SOLUTIONS	2078
KARCHER	1046	ORION	1012, 1013, 1044, 1065	SELECO	1043	AIWA	2055, 2100
KENDO	1044	ORSON	1042	SENTRON	1050	AKAI	2096
		OSAKI	1042, 1045, 1050	SHARP	1008, 1023, 1028, 1053, 1073	AKURA	2076
		OTTO VERSAND	1046	SHINTOM	1006, 1047, 1050	ALBA	2078, 2086
		PALLADIUM	1043, 1045, 1050	SHIVAKI	1045	APEX	2027, 2049
				SHOGUN	1002, 1014	AWA	2078

AXION 2078
 BRAINWAVE 2096
 BRANDT 2073, 2085
 BROKSONIC 2060
 BUSH 2075, 2078, 2112
 CENTREX 2077
 CLASSIC 2078
 CLATRONIC 2075
 COBY 2078
 C-TECH 2074
 CYBERHOME

2025, 2079, 2091

DAEWOO 2092, 2098
 DANSAI 2096
 DAYTEK 2080, 2089
 DEC 2075
 DENON 2030, 2102, 2103
 DENVER 2075, 2076
 DIAMOND 2074
 DK DIGITAL 2094
 DUAL 2078
 D-VISION 2096
 DVX 2074
 ELTA 2096
 EUROLINE 2096
 FUNAI 2052, 2058
 GLOBAL SOLUTIONS

2074

GLOBAL SPHERE
 2074
 GOODMAN'S 2075, 2077, 2078
 GRUNDIG 2077, 2098
 H&B 2075
 HAAZ 2074
 HE 2078
 HITACHI 2032, 2072
 HOME ELECTRONICS

2078
 INNOVATION 2072
 IRRADIO 2134
 JDB 2078
 JVC 2033, 2045, 2053,
 2073, 2099

KENWOOD 2030, 2097
 KINGAVON 2075
 KODA 2075
 LAWSON 2074
 LENCO 2075
 LG 2084, 2087
 LIFETEC 2072
 LIMIT 2074
 LOGICLAB 2074
 LUXOR 2077
 MAGNAVOX 2037, 2073, 2075
 MAGNUM 2072
 MBO 2078
 MEDION 2072
 MICROMAXX

2072

MICROMEDIA
 2073
 MICROSTAR 2072
 MITSUBISHI 2035
 MIZUDA 2075
 MUSTEK 2078
 NAIKO 2077
 ONKYO 2073, 2135

ORAVA 2075
 P&B 2075
 PACIFIC 2074
 PANASONIC 2030, 2040, 2054,
 2057, 2105, 2110
 PHILIPS 2019, 2026, 2046,
 2073, 2081, 2090

PIONEER 2036, 2082

PROLINE 2077
 PROVISION 2075
 RCA 2031, 2042, 2050,
 2051

RED STAR 2076
 REOC 2074
 ROADSTAR 2075, 2078, 2086

ROWA 2077
 SABA 2085
 SABAKI 2074
 SAMSUNG 2032, 2041, 2104,
 2113

SANSUI 2074
 SANYO 2095
 SCANMAGIC 2078
 SCIENTIFIC LABS
 2074

SCOTT 2088
 SEG 2074, 2086
 SHARP 2034, 2043, 2059,
 2093, 2106

SILVA 2076
 SINGER 2074
 SKYMASTER 2074, 2078
 SKYWORTH 2076
 SM ELECTRONIC
 2074, 2078

SONY 2028, 2029, 2039,
 2083, 2107

SOUNDMASTER
 2074

SOUNDMAX 2074
 STANDARD 2074
 STAR CLUSTER
 2074

STARMEDIA 2075
 SUPERVISION
 2074, 2078

SYLVANIA 2052, 2058
 SYNN 2074
 TCM 2072
 TEAC 2074
 TEC 2076

TECHNICS 2030
 TECHNIKA 2096
 TECHNOSONIC
 2096

TEVION 2072, 2074
 THOMSON 2085, 2109
 TOKAI 2076
 TOSHIBA 2026, 2044, 2048,
 2056, 2073, 2108,
 2111

UNITED 2078
 VOXSON 2078
 WHARFEDALE
 2074
 XLOGIC 2074
 YAKUMO 2077

YAMADA 2077
 YAMAHA 2000, 2001, 2003,
 2030, 2101
 YUKAI 2078
 ZENITH 2038, 2047, 2073

DVD-DVR

PANASONIC 2067
 PIONEER 2114
 SAMSUNG 2115
 TOSHIBA 2068

DVD/LD COMBO

PIONEER 2036

DVD RECORDER

APEX 2024
 JVC 2070
 LG 2071
 PANASONIC 2020, 2065, 2066,
 2067
 PHILIPS 2019, 2061, 2062,
 2063
 PIONEER 2021
 RCA 2018
 SONY 2022, 2064
 TOSHIBA 2068
 YAMAHA 2023
 YUKAI 2069

DVR

ABS 2132
 ALIENWARE 2132
 CYBERPOWER
 2132

DELL 2132
 DIRECTV 2123, 2128, 2129,
 2133

DISH NETWORK
 2126, 2127

DISHPRO 2126
 ECHOSTAR 2126, 2127
 EXPRESSVU 2126
 GATEWAY 2132
 GOI 2126

HEWLETT PACKARD
 2132
 HITACHI 2008
 HOWARD COMPUTERS
 2132

HTS 2126
 HUGHES 2123, 2128
 HUMAX 2123
 HUSH 2132
 IBUYPOWER 2132

JVC 2126, 2127
 LINKSYS 2132
 MEDIA CENTER PC
 2132

MICROSOFT 2132
 MIND 2132

NIVEUS MEDIA
 2132
 NORTHGATE 2132
 PANASONIC 2015, 2016, 2017,
 2120
 PHILIPS 2117, 2121, 2123,
 2128

PIONEER 2012, 2013, 2014
 PROSCAN 2129
 RCA 2116, 2124, 2129,
 2133

REPLAYTV 2118, 2119, 2120
 SHARP 2009, 2010
 SONIC BLUE 2119, 2120
 SONY 2005, 2006, 2007,
 2122, 2130, 2131,
 2132

STACK 9 2132
 SYSTEMAX 2132
 TAGAR SYSTEMS
 2132

TIVO 2116, 2121, 2122,
 2123, 2130, 2131
 TOSHIBA 2004, 2125, 2132

TOUCH 2132
 ULTIMATETV 2133
 VIEWSONIC 2132
 VOODOO 2132
 YAMAHA 2011
 ZT GROUP 2132

LD PLAYER

YAMAHA 2002

CD PLAYER

YAMAHA 5000, 5013

CD RECORDER

YAMAHA 5001

MD

YAMAHA 5002, 5003, 5004

TAPE DECK

YAMAHA 5005, 5006

TUNER

YAMAHA 5007, 5008, 5009,
 5010, 5012, 5014

OTHER AUDIO ACCESSORIES

YAMAHA 5011
 (iPod)



© 2007 YAMAHA CORPORATION All rights reserved.

YAMAHA ELECTRONICS CORPORATION, USA 6660 ORANGETHORPE AVE., BUENA PARK, CALIF. 90620, U.S.A.
 YAMAHA CANADA MUSIC LTD. 135 MILNER AVE., SCARBOROUGH, ONTARIO M1S 3R1, CANADA
 YAMAHA ELECTRONIK EUROPA G.m.b.H. SIEMENSSTR. 22-34, 25462 BELLINGEN BEI HAMBURG, GERMANY
 YAMAHA ELECTRONIQUE FRANCE S.A. RUE AMBROISE CROIZAT BP70 CROISSY-BEAUBOURG 77312 MARNE-LA-VALLEE CEDEX02, FRANCE
 YAMAHA ELECTRONICS (UK) LTD. YAMAHA HOUSE, 200 RICKMANSWORTH ROAD WATFORD, HERTS WD18 7GQ, ENGLAND
 YAMAHA SCANDINAVIA A.B. J A WETTERGRENS GATA 1, BOX 30053, 400 43 VÄSTRA FRÖLUNDA, SWEDEN
 YAMAHA MUSIC AUSTRALIA PTY, LTD. 17-33 MARKET ST., SOUTH MELBOURNE, 3205 VIC., AUSTRALIA

YAMAHA CORPORATION

Printed in China c WJ63730

The circled numbers and alphabets correspond to those in the Owner's Manual.

■ Front panel

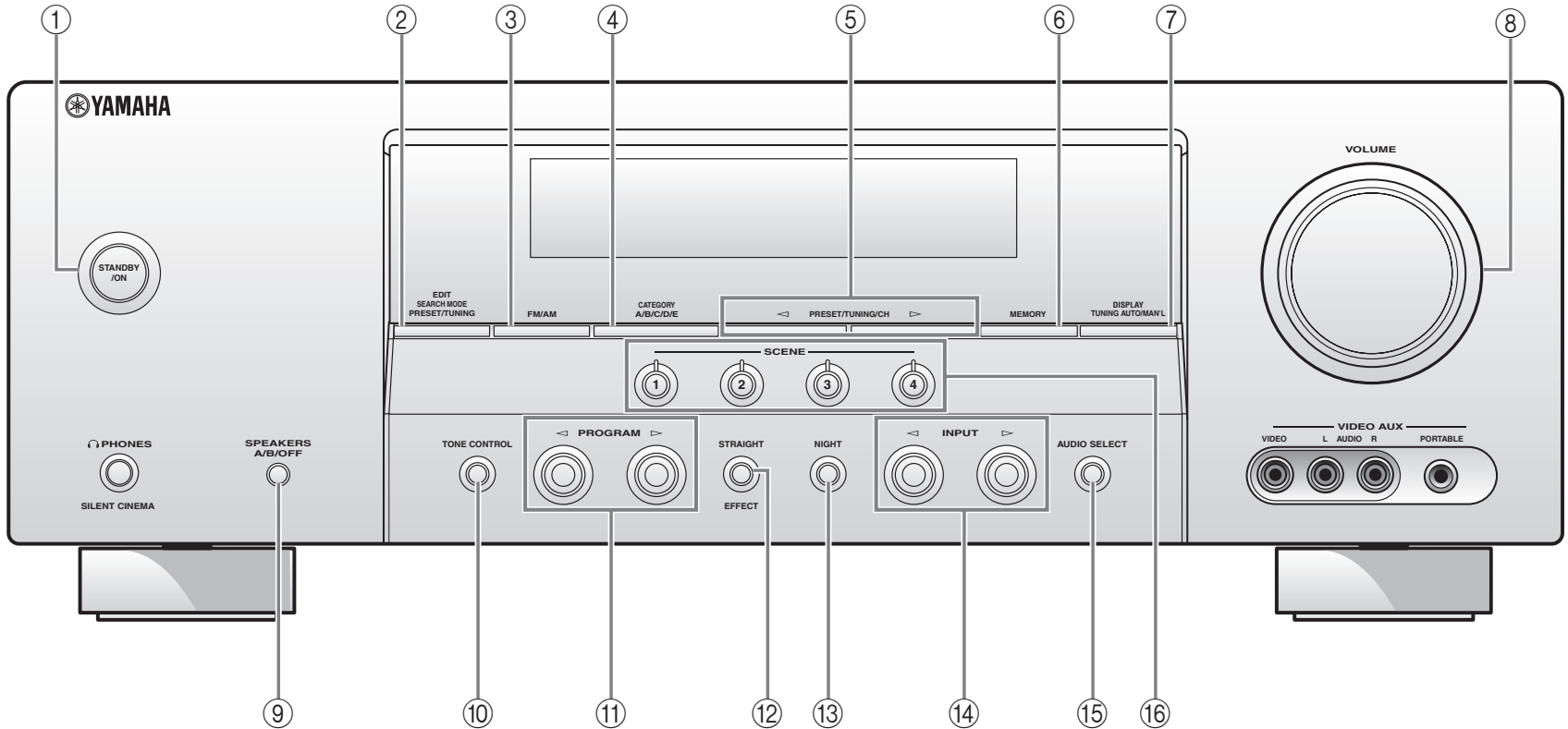

Remote control

