

RX-V561

AV Receiver

Ampli-tuner audio-vidéo

OWNER'S MANUAL
MODE D'EMPLOI

Important safety instructions

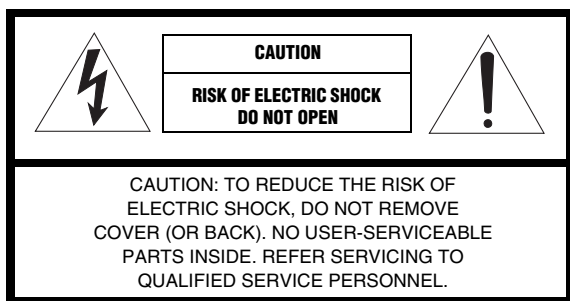

• Explanation of Graphical Symbols



The lightning flash with arrowhead symbol, within an equilateral triangle, is intended to alert you to the presence of uninsulated “dangerous voltage” within the product’s enclosure that may be of sufficient magnitude to constitute a risk of electric shock to persons.



The exclamation point within an equilateral triangle is intended to alert you to the presence of important operating and maintenance (servicing) instructions in the literature accompanying the appliance.

- 1 Read Instructions – All the safety and operating instructions should be read before the product is operated.
 - 2 Retain Instructions – The safety and operating instructions should be retained for future reference.
 - 3 Heed Warnings – All warnings on the product and in the operating instructions should be adhered to.
 - 4 Follow Instructions – All operating and use instructions should be followed.
 - 5 Cleaning – Unplug this product from the wall outlet before cleaning. Do not use liquid cleaners or aerosol cleaners.
 - 6 Attachments – Do not use attachments not recommended by the product manufacturer as they may cause hazards.
 - 7 Water and Moisture – Do not use this product near water – for example, near a bath tub, wash bowl, kitchen sink, or laundry tub; in a wet basement; or near a swimming pool; and the like.
 - 8 Accessories – Do not place this product on an unstable cart, stand, tripod, bracket, or table. The product may fall, causing serious injury to a child or adult, and serious damage to the product. Use only with a cart, stand, tripod, bracket, or table recommended by the manufacturer, or sold with the product. Any mounting of the product should follow the manufacturer’s instructions, and should use a mounting accessory recommended by the manufacturer.
 - 9 A product and cart combination should be moved with care. Quick stops, excessive force, and uneven surfaces may cause the product and cart combination to overturn.
- 
- 10 Ventilation – Slots and openings in the cabinet are provided for ventilation and to ensure reliable operation of the product and to protect it from overheating, and these openings must not be blocked or covered. The openings should never be blocked by placing the product on a bed, sofa, rug, or other similar surface. This product should not be placed in a built-in installation such as a bookcase or rack unless proper ventilation is provided or the manufacturer’s instructions have been adhered to.
 - 11 Power Sources – This product should be operated only from the type of power source indicated on the marking label. If you are not sure of the type of power supply to your home, consult your product dealer or local power company. For products intended to operate from battery power, or other sources, refer to the operating instructions.
 - 12 Grounding or Polarization – This product may be equipped with a polarized alternating current line plug (a plug having one blade wider than the other). This plug will fit into the power outlet only one way. This is a safety feature. If you are unable to insert the plug fully into the outlet, try reversing the plug. If the plug should still fail to fit, contact your electrician to replace your obsolete outlet. Do not defeat the safety purpose of the polarized plug.
 - 13 Power-Cord Protection – Power-supply cords should be routed so that they are not likely to be walked on or pinched by items placed upon or against them, paying particular attention to cords at plugs, convenience receptacles, and the point where they exit from the product.
 - 14 Lightning – For added protection for this product during a lightning storm, or when it is left unattended and unused for long periods of time, unplug it from the wall outlet and disconnect the antenna or cable system. This will prevent damage to the product due to lightning and power-line surges.
 - 15 Power Lines – An outside antenna system should not be located in the vicinity of overhead power lines or other electric light or power circuits, or where it can fall into such power lines or circuits. When installing an outside antenna system, extreme care should be taken to keep from touching such power lines or circuits as contact with them might be fatal.
 - 16 Overloading – Do not overload wall outlets, extension cords, or integral convenience receptacles as this can result in a risk of fire or electric shock.
 - 17 Object and Liquid Entry – Never push objects of any kind into this product through openings as they may touch dangerous voltage points or short-out parts that could result in a fire or electric shock. Never spill liquid of any kind on the product.
 - 18 Servicing – Do not attempt to service this product yourself as opening or removing covers may expose you to dangerous voltage or other hazards. Refer all servicing to qualified service personnel.
 - 19 Damage Requiring Service – Unplug this product from the wall outlet and refer servicing to qualified service personnel under the following conditions:
 - a) When the power-supply cord or plug is damaged,
 - b) If liquid has been spilled, or objects have fallen into the product,
 - c) If the product has been exposed to rain or water,

- d) If the product does not operate normally by following the operating instructions. Adjust only those controls that are covered by the operating instructions as an improper adjustment of other controls may result in damage and will often require extensive work by a qualified technician to restore the product to its normal operation,
 - e) If the product has been dropped or damaged in any way, and
 - f) When the product exhibits a distinct change in performance - this indicates a need for service.
- 20** Replacement Parts – When replacement parts are required, be sure the service technician has used replacement parts specified by the manufacturer or have the same characteristics as the original part. Unauthorized substitutions may result in fire, electric shock, or other hazards.
- 21** Safety Check – Upon completion of any service or repairs to this product, ask the service technician to perform safety checks to determine that the product is in proper operating condition.
- 22** Wall or Ceiling Mounting – The unit should be mounted to a wall or ceiling only as recommended by the manufacturer.
- 23** Heat – The product should be situated away from heat sources such as radiators, heat registers, stoves, or other products (including amplifiers) that produce heat.

- 24** Outdoor Antenna Grounding – If an outside antenna or cable system is connected to the product, be sure the antenna or cable system is grounded so as to provide some protection against voltage surges and built-up static charges. Article 810 of the National Electrical Code, ANSI/NFPA 70, provides information with regard to proper grounding of the mast and supporting structure, grounding of the lead-in wire to an antenna discharge unit, size of grounding conductors, location of antenna discharge unit, connection to grounding electrodes, and requirements for the grounding electrode.

EXAMPLE OF ANTENNA GROUNDING

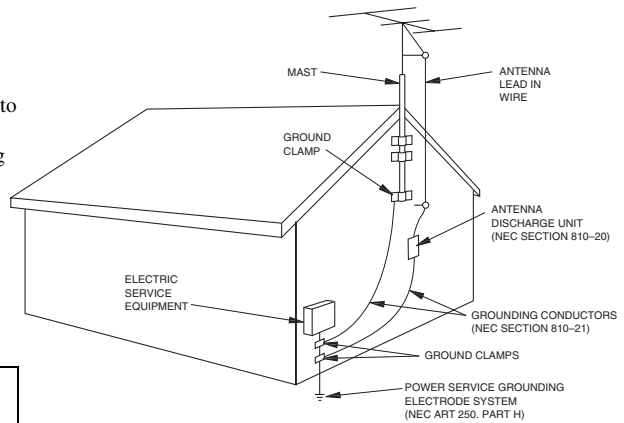

NEC – NATIONAL ELECTRICAL CODE

Note to CATV system installer:

This reminder is provided to call the CATV system installer’s attention to Article 820-40 of the NEC that provides guidelines for proper grounding and, in particular, specifies that the cable ground shall be connected to the grounding system of the building, as close to the point of cable entry as practical.

FCC INFORMATION (for US customers)

1 IMPORTANT NOTICE: DO NOT MODIFY THIS UNIT!

This product, when installed as indicated in the instructions contained in this manual, meets FCC requirements. Modifications not expressly approved by Yamaha may void your authority, granted by the FCC, to use the product.

2 IMPORTANT: When connecting this product to accessories and/or another product use only high quality shielded cables. Cable/s supplied with this product **MUST** be used. Follow all installation instructions. Failure to follow instructions could void your FCC authorization to use this product in the USA.

3 NOTE: This product has been tested and found to comply with the requirements listed in FCC Regulations, Part 15 for Class “B” digital devices. Compliance with these requirements provides a reasonable level of assurance that your use of this product in a residential environment will not result in harmful interference with other electronic devices.

This equipment generates/uses radio frequencies and, if not installed and used according to the instructions found in the users manual, may cause interference harmful to the operation of other electronic devices.

Compliance with FCC regulations does not guarantee that interference will not occur in all installations. If this product is found to be the source of interference, which can be determined by turning the unit “OFF” and “ON”, please try to eliminate the problem by using one of the following measures:

Relocate either this product or the device that is being affected by the interference.

Utilize power outlets that are on different branch (circuit breaker or fuse) circuits or install AC line filter/s.

In the case of radio or TV interference, relocate/reorient the antenna. If the antenna lead-in is 300 ohm ribbon lead, change the lead-in to coaxial type cable.

If these corrective measures do not produce satisfactory results, please contact the local retailer authorized to distribute this type of product. If you can not locate the appropriate retailer, please contact Yamaha Electronics Corp., U.S.A. 6660 Orangethorpe Ave., Buena Park, CA 90620.

The above statements apply **ONLY** to those products distributed by Yamaha Corporation of America or its subsidiaries.

Caution: Read this before operating your unit.

- 1 To assure the finest performance, please read this manual carefully. Keep it in a safe place for future reference.
- 2 Install this sound system in a well ventilated, cool, dry, clean place – away from direct sunlight, heat sources, vibration, dust, moisture, and/or cold. Allow ventilation space of at least 30 cm on the top, 20 cm on the left and right, and 20 cm on the back of this unit.
- 3 Locate this unit away from other electrical appliances, motors, or transformers to avoid humming sounds.
- 4 Do not expose this unit to sudden temperature changes from cold to hot, and do not locate this unit in an environment with high humidity (i.e. a room with a humidifier) to prevent condensation inside this unit, which may cause an electrical shock, fire, damage to this unit, and/or personal injury.
- 5 Avoid installing this unit where foreign object may fall onto this unit and/or this unit may be exposed to liquid dripping or splashing. On the top of this unit, do not place:
 - Other components, as they may cause damage and/or discoloration on the surface of this unit.
 - Burning objects (i.e. candles), as they may cause fire, damage to this unit, and/or personal injury.
 - Containers with liquid in them, as they may fall and liquid may cause electrical shock to the user and/or damage to this unit.
- 6 Do not cover this unit with a newspaper, tablecloth, curtain, etc. in order not to obstruct heat radiation. If the temperature inside this unit rises, it may cause fire, damage to this unit, and/or personal injury.
- 7 Do not plug in this unit to a wall outlet until all connections are complete.
- 8 Do not operate this unit upside-down. It may overheat, possibly causing damage.
- 9 Do not use force on switches, knobs and/or cords.
- 10 When disconnecting the power cable from the wall outlet, grasp the plug; do not pull the cord.
- 11 Do not clean this unit with chemical solvents; this might damage the finish. Use a clean, dry cloth.
- 12 Only voltage specified on this unit must be used. Using this unit with a higher voltage than specified is dangerous and may cause fire, damage to this unit, and/or personal injury. Yamaha will not be held responsible for any damage resulting from use of this unit with a voltage other than specified.
- 13 To prevent damage by lightning, keep the power cord and outdoor antennas disconnected from a wall outlet or the unit during a lightning storm.
- 14 Do not attempt to modify or fix this unit. Contact qualified Yamaha service personnel when any service is needed. The cabinet should never be opened for any reasons.
- 15 When not planning to use this unit for long periods of time (i.e. vacation), disconnect the AC power plug from the wall outlet.
- 16 Install this unit near the AC outlet and where the AC power plug can be reached easily.
- 17 Be sure to read the “Troubleshooting” section on common operating errors before concluding that this unit is faulty.
- 18 Before moving this unit, press STANDBY/ON to set this unit in the standby mode, and disconnect the AC power plug from the wall outlet.
- 19 The batteries shall not be exposed to excessive heat such as sunshine, fire or like.
- 20 Excessive sound pressure from earphones and headphones can cause hearing loss.

WARNING

TO REDUCE THE RISK OF FIRE OR ELECTRIC SHOCK, DO NOT EXPOSE THIS UNIT TO RAIN OR MOISTURE.

This unit is not disconnected from the AC power source as long as it is connected to the wall outlet, even if this unit itself is turned off by STANDBY/ON. This state is called the standby mode. In this state, this unit is designed to consume a very small quantity of power.

FOR CANADIAN CUSTOMERS

To prevent electric shock, match wide blade of plug to wide slot and fully insert.
This Class B digital apparatus complies with Canadian ICES-003.

IMPORTANT

Please record the serial number of this unit in the space below.
MODEL:
Serial No.:
The serial number is located on the rear of the unit.
Retain this Owner’s Manual in a safe place for future reference.

Contents

INTRODUCTION

Features	2
Getting started	3
Quick start guide	4
Preparation: Check the items	4
Step 1: Set up your speakers	5
Step 2: Connect your DVD player and other components	6
Step 3: Turn on the power and press SCENE 1 button	8
What do you want to do with this unit?	9

PREPARATION

Connections	10
Rear panel	10
Placing speakers	11
Connecting speakers	12
Setting the speaker impedance	13
Information on jacks and cable plugs	14
Information on HDMI™	15
Connecting video components	16
Connecting audio components	19
Using the VIDEO AUX jacks on the front panel	20
Connecting the FM and AM antennas	20
Connecting the power cable	21
Turning on and off the power	21
Front panel display	22
Optimizing the speaker setting for your listening room	24
Using AUTO SETUP	24

BASIC OPERATION

Selecting the SCENE templates	28
Selecting the desired SCENE template	28
Creating your original SCENE templates	31
Playback	32
Basic operations	32
Additional operations	33
Sound field programs	37
Sound field program descriptions	37
FM/AM tuning	40
Automatic tuning	40
Manual tuning	40
Automatic preset tuning	41
Manual preset tuning	41
Selecting preset stations	42
Exchanging preset station	42
Using a USB memory device or a USB portable audio player	43
Playback operation	43
Recording	45

ADVANCED OPERATION

SET MENU	46
Using SET MENU	47
1 SOUND MENU	48
2 INPUT MENU	52
3 OPTION MENU	54
Remote control features	56
Using remote control on the SCENE feature	56
Controlling this unit, a TV, or other components	57
Setting remote control codes	59
Advanced setup	60

ADDITIONAL INFORMATION

Troubleshooting	61
Glossary	68
Specifications	70
Index	71

APPENDIX

(at the end of this manual)

Front panel	i
Remote control	ii
List of remote control codes	iii

About this manual

- ✨ indicates a tip for your operation.
- Some operations can be performed by using either the buttons on the front panel or the ones on the remote control. In case the button names differ between the front panel and the remote control, the button name on the remote control is given in parentheses.
- This manual is printed prior to production. Design and specifications are subject to change in part as a result of improvements, etc. In case of differences between the manual and product, the product has priority.
- “**Ⓞ SPEAKERS**” or “**Ⓐ MULTI CH IN**” (example) indicates the name of the parts on the front panel or the remote control. Refer to the attached sheet or the appendix pages at the end of this manual for the information about each position of the parts.
- The symbol “**☞**” with page number(s) indicates the corresponding reference page(s).

INTRODUCTION

PREPARATION

BASIC
OPERATION

ADVANCED
OPERATION

ADDITIONAL
INFORMATION

APPENDIX

English

Features

Built-in 5-channel power amplifier

- ◆ Minimum RMS output power
[Front, Center, Surround channels]
100 W (1 kHz, 0.9% THD, 6 Ω)

SCENE select function

- ◆ Preset SCENE templates for various situations
- ◆ SCENE template customizing capability

Decoders and DSP circuits

- ◆ Proprietary Yamaha technology for the creation of multi-channel surround sound
- ◆ Compressed Music Enhancer mode to improve the sound quality of compression artifacts (such as the MP3 format) to that of a high-quality stereo
- ◆ Dolby Digital decoder
- ◆ Dolby Pro Logic/Dolby Pro Logic II decoder
- ◆ DTS decoder
- ◆ Virtual CINEMA DSP
- ◆ SILENT CINEMA™

Sophisticated FM/AM tuner

- ◆ 40-station random and direct preset tuning
- ◆ Automatic preset tuning

HDMI (High-Definition Multimedia Interface)

- ◆ HDMI interface for standard, enhanced or high-definition video (includes 1080p video signal transmission)

USB features

- ◆ USB port to connect a USB memory device or a USB portable audio player
- ◆ MP3, WMA and WAV capability

Other features

- ◆ YPAO (Yamaha Parametric Room Acoustic Optimizer) for automatic speaker setup
- ◆ 192-kHz/24-bit D/A converter
- ◆ Direct Stereo mode for pure hi-fi sound for analog and PCM 2-channel sources
- ◆ 6 additional input jacks for discrete multi-channel input
- ◆ OSD (on-screen display) menus that allow you to optimize this unit to suit your individual audiovisual system
- ◆ Component video input/output capability (3 COMPONENT VIDEO INs and 1 MONITOR OUT)
- ◆ S-video signal input/output capability
- ◆ Optical and coaxial digital audio signal jacks
- ◆ Sleep timer
- ◆ Cinema and music night listening modes
- ◆ Remote control with preset remote control codes



Manufactured under license from Dolby Laboratories. "Dolby", "Pro Logic", and the double-D symbol are trademarks of Dolby Laboratories.

SILENT™
CINEMA

"SILENT CINEMA" is a trademark of YAMAHA CORPORATION.



"HDMI", the "HDMI" logo and "High-Definition Multimedia Interface" are trademarks or registered trademarks of HDMI Licensing LLC.



"DTS" and "DTS Digital Surround" are registered trademarks of DTS, Inc.

This unit is equipped with the technologies developed by Analog Devices, Inc. and others. It is strictly prohibited to use this unit for use other than audiovisual purposes.

We Want You Listening For A Lifetime

Yamaha and the Electronic Industries Association's Consumer Electronics Group want you to get the most out of your equipment by playing it at a safe level. One that lets the sound come through loud and clear without annoying blaring or distortion – and, most importantly, without affecting your sensitive hearing.

Since hearing damage from loud sounds is often undetectable until it is too late, Yamaha and the Electronic Industries Association's Consumer Electronics Group recommend you to avoid prolonged exposure from excessive volume levels.



Getting started

■ Checking the supplied accessories

Check that you received all of the following parts.

Remote control



Batteries (2) (AAA, R03, UM-4)

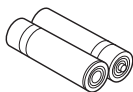

Optimizer microphone



AM loop antenna



Indoor FM antenna

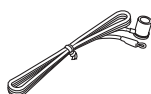

Note

The form of the supplied accessories varies depending on the models.

■ Installing batteries in the remote control

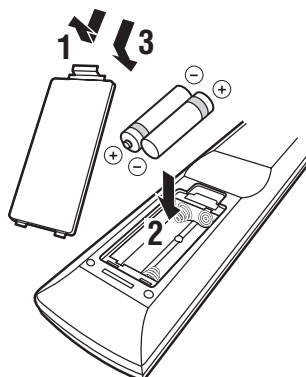

1 Take off the battery compartment cover.

2 Insert the two supplied batteries (AAA, R03, UM-4) according to the polarity markings (+ and -) on the inside of the battery compartment.

3 Snap the battery compartment cover back into place.

Notes

- Change all of the batteries if you notice the following condition:
 - the operation range of the remote control decreases.
- Do not use an old battery and a new one together.
- Do not use different types of batteries (such as alkaline and manganese batteries) together. Read the packaging carefully as these different types of batteries may have the same shape and color.
- If the batteries have leaked, dispose of them immediately. Avoid touching the leaked material or letting it come into contact with clothing, etc. Clean the battery compartment thoroughly before installing new batteries.
- Do not throw away batteries with general house waste; dispose of them correctly in accordance with your local regulations.
- If the remote control is without batteries for more than 2 minutes, or if exhausted batteries remain in the remote control, the contents of the memory may be cleared. When the memory is cleared, insert new batteries and set up the remote control code.

Quick start guide

The following steps describe the easiest way to enjoy DVD movie playback in your home theater.

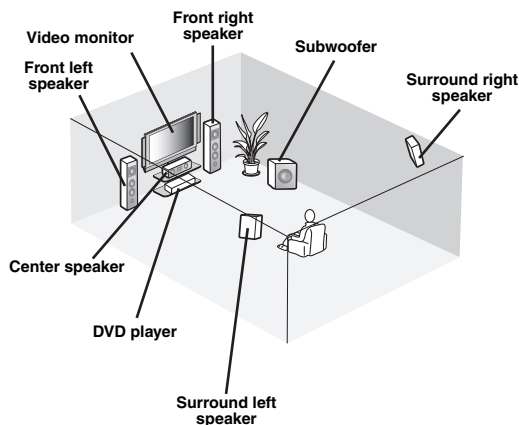

Step 1: Set up your speakers

P. 5

Step 2: Connect your DVD player and other components

P. 6

Step 3: Turn on the power and press SCENE 1 button

P. 8

Enjoy DVD playback!

Preparation: Check the items

In these steps, you need the following supplied accessories.

- Indoor FM antenna
- AM loop antenna

The following items are not included in the package of this unit.

- Speakers**
 - Front speakers 2
 - Center speaker 1
 - Surround speakers 2Select magnetically shielded speakers. The minimum required speakers are two front speakers.
- Active subwoofer** 1
Select an active subwoofer equipped with an RCA input jack.
- Speaker cables** 5
- Subwoofer cable** 1
Select a monaural RCA cable.
- DVD player** 1
Select DVD player equipped with coaxial digital audio output jack and composite video output jack.
- Video monitor** 1
Select a TV monitor, video monitor or projector equipped with a composite video input jack.
- Video cable** 2
Select an RCA composite video cable.
- Digital coaxial audio cable** 1

Step 1: Set up your speakers

Place your speakers in the room and connect them to this unit.

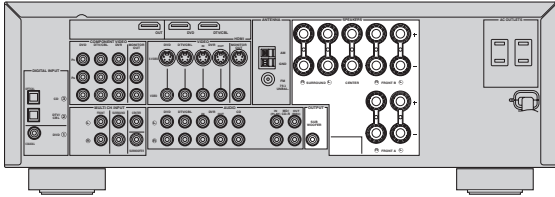

1 Place your speakers and subwoofer in the room.

2 Connect speaker cables to each speaker.

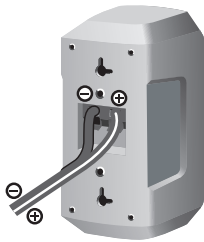

Cables are colored or shaped differently, perhaps with a stripe, groove or ridge. Connect the striped (grooved, etc.) cable to the “+” (red) terminals of your speaker. Connect the plain cable to the “-” (black) terminals.

3 Connect each speaker cable to the corresponding speaker terminal of this unit.

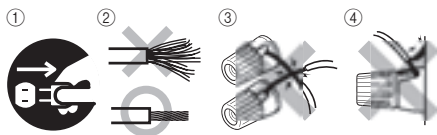

- ① Make sure that this unit and the subwoofer are unplugged from the AC wall outlets.
- ② Twist the exposed wires of the speaker cables together to prevent short circuits.
- ③ Do not let the bare speaker wires touch each other.
- ④ Do not let the bare speaker wires touch any metal part of this unit.

Be sure to connect the left channel (L), right channel (R), “+” (red) and “-” (black) properly.

Front speakers

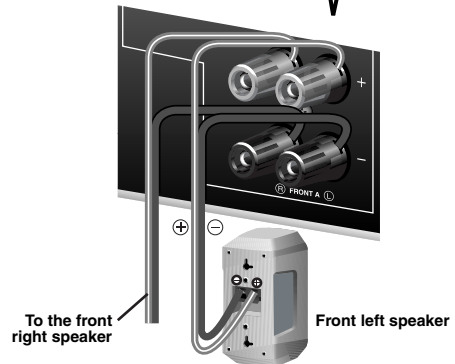
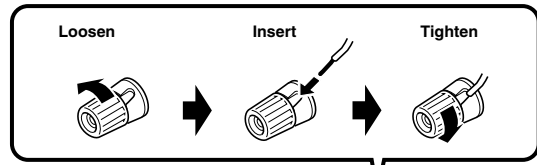

Center and surround speakers

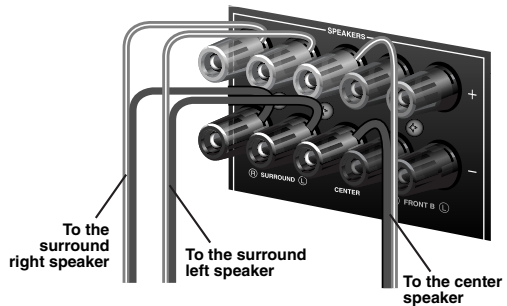

4 Connect the subwoofer cable to the input jack of the subwoofer and the SUBWOOFER OUTPUT jack of this unit.

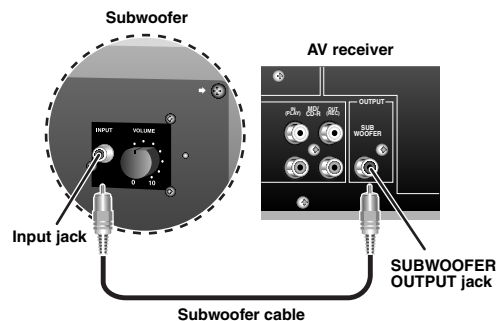

Step 2: Connect your DVD player and other components

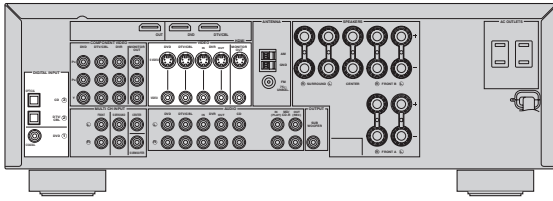

Make sure that this unit and the DVD player are unplugged from the AC wall outlets.

- 1 Connect the digital coaxial audio cable to the digital coaxial audio output jack of your DVD player and the DVD DIGITAL INPUT COAXIAL jack of this unit.

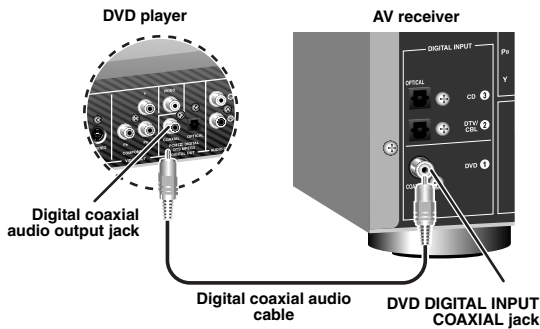

- 2 Connect the video cable to the composite video output jack of your DVD player and the DVD VIDEO jack of this unit.

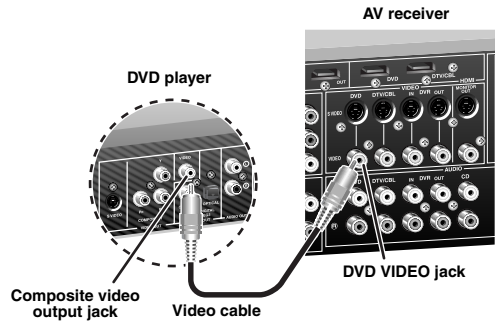

- 3 Connect the video cable to the video input jack of your video monitor and the VIDEO MONITOR OUT jack of this unit.

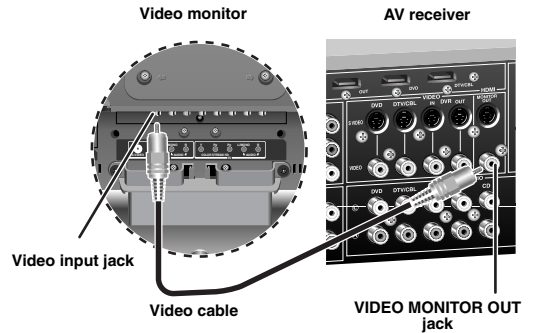

4 Connect the FM and AM antennas to this unit.

See page 20 for the details.

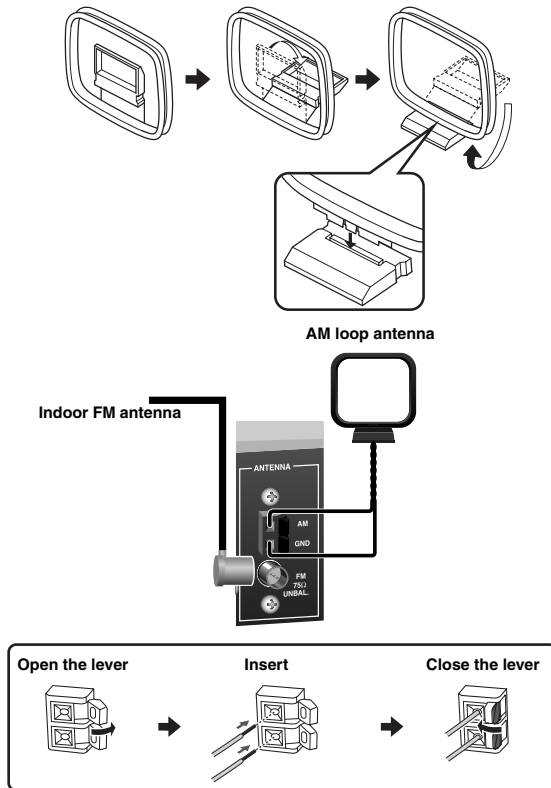

The wire of the AM loop antenna does not have any polarity and you can connect either end of the wire to AM and GND terminal.

Note

The shape of the AM and GND terminals may vary depending on the unit.

5 Connect the power plug of this unit and other components into the AC wall outlet.



This unit is equipped with AC OUTLETS for the power supply of the other components. See page 21 for details.

■ For further connections

- Using the other kind of speaker combinations P. 12
- Connecting a video monitor P. 16
- Connecting a DVD player P. 16
- Connecting a DVD recorder P. 16
- Connecting a cable TV or a satellite tuner P. 16
- Connecting a CD player and an MD recorder P. 19
- Connecting a DVD player via analog multi-channel audio connection P. 19
- Using the VIDEO AUX jacks on the front panel P. 20
- Connecting an outdoor FM/AM antenna P. 20
- Using the USB jack on the front panel P. 43

Step 3: Turn on the power and press SCENE 1 button

Check the type of the connected speakers.
If the speakers are 6 ohm speakers, set “SP IMP.” to “6Ω MIN” before using this unit (see page 13).

- 1 Turn on the video monitor connected to this unit.
- 2 Press ① **STANDBY/ON** on the front panel.



Note

In the standby mode, this unit consumes a small amount of power in order to receive infrared signals from the remote control.

- 3 Press ⑯ **SCENE 1**.
“DVD Viewing” appears in the front panel display, and this unit automatically optimize own status for the DVD playback.



The indicator on the selected SCENE button lights up while this unit is in the SCENE mode.

- 4 Start playback of the desired DVD on your player.

- 5 Rotate ⑧ **VOLUME** to adjust the volume.



Note

When you change the input source or sound field program, the SCENE mode is deactivated, and the indicator on the selected SCENE button turns off.

■ **Using the other SCENE buttons**

In the following cases, try pressing the corresponding SCENE button to enjoy playback of the desired sources.

Case A: “I want to listen to a music disc from the connected DVD player as the back ground music for this room...”

➔ Press ⑯ **SCENE 2** (or ⑤ **SCENE 2**) to select “Disc Listening”.

Case B: “I want to watch a TV program...”

➔ Press ⑯ **SCENE 3** (or ⑤ **SCENE 3**) to select “TV Viewing”.

Note

To use the “TV Viewing” template, you must connect a cable TV or a satellite tuner to this unit in advance. See page 16 for details.

Case C: “I want to listen to a music program from the FM radio station...”

➔ Press **Ⓜ SCENE 4** (or **Ⓜ SCENE 4**) to select “Radio Listening”.

Notes

- To use the “Radio Listening” template, you must tune into the desired radio station in advance. See pages 40 to 42 for tuning information.
- To achieve the best possible reception, orient the connected AM loop antenna, or adjust the position of the end of the indoor FM antenna.



If you cannot find the desired situation, you can select and change the assigned SCENE template for the SCENE buttons. See page 28 for details.

■ After using this unit...

Press **Ⓜ STANDBY/ON** on the front panel to set this unit to the standby mode.

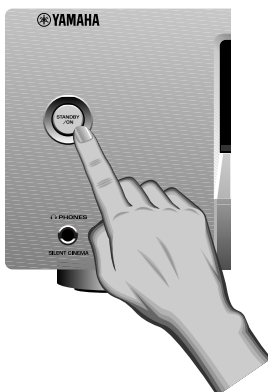

This unit is set to the standby mode. To turn on this unit from the standby mode, press **Ⓜ STANDBY/ON** (or **Ⓜ POWER**). See page 21 for details.

Note

In the standby mode, this unit consumes a small amount of power in order to receive infrared signals from the remote control.

What do you want to do with this unit?

■ Customizing the SCENE templates

- Using various SCENE templates ☞ P. 28
- Creating your original SCENE templates ☞ P. 31

■ Using various input sources

- Basic controls of this unit ☞ P. 32
- Enjoying FM/AM radio programs ☞ P. 40
- Using your USB portable device with this unit ☞ P. 43

■ Using various sound features

- Using various sound field programs ☞ P. 37
- Using the pure direct mode for the high fidelity sound ☞ P. 34
- Customizing the sound field programs ☞ P. 39

■ Adjusting the parameters of this unit

- Automatically optimizing the speaker parameters for your listening room (AUTO SETUP) ☞ P. 24
- Manually adjusting various parameters of this unit ☞ P. 46
- Setting the remote control ☞ P. 56
- Adjusting the advanced parameters ☞ P. 60

■ Additional features

- Automatically turning off this unit ☞ P. 36

Connections

Rear panel

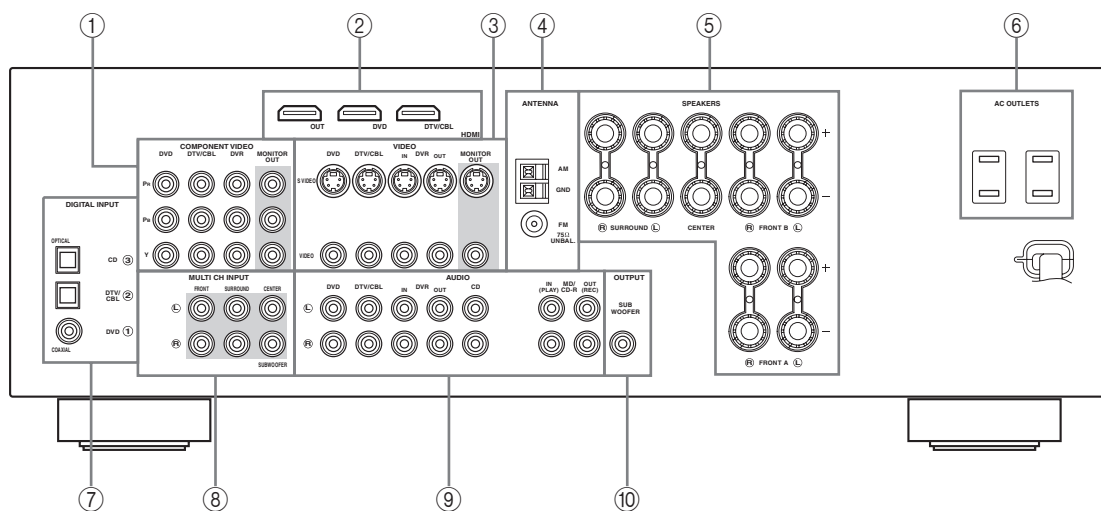

① **COMPONENT VIDEO jacks**

See page 18 for connection information.

② **HDMI jacks**

See page 17 for connection information.

③ **VIDEO jacks**

See pages 16 and 18 for connection information.

④ **ANTENNA terminals**

See page 20 for connection information.

⑤ **SPEAKERS terminals**

See page 12 for connection information.

⑥ **AC OUTLETS**

See page 21 for connection information.

⑦ **DIGITAL INPUT jacks**

See pages 16 and 19 for connection information.

⑧ **MULTI CH INPUT jacks**

See page 19 for connection information.

⑨ **AUDIO jacks**

See pages 16 and 19 for connection information.

⑩ **SUBWOOFER OUTPUT jack**

See page 12 for connection information.

Placing speakers

The speaker layout below shows the speaker setting we recommend. You can use it to enjoy CINEMA DSP and multi-channel audio sources.

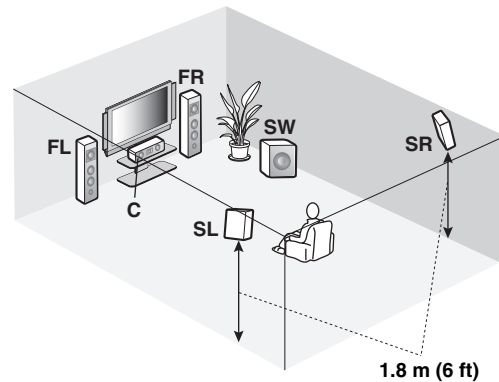
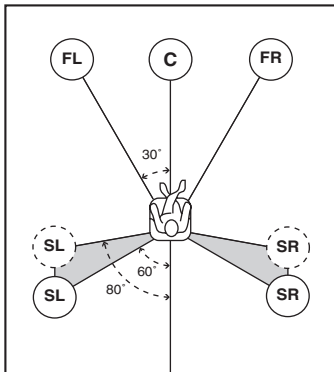

Front left and right speakers (FL and FR)

The front speakers are used for the main source sound plus effect sounds. Place these speakers at an equal distance from the ideal listening position. The distance of each speaker from each side of the video monitor should be the same.

Center speaker (C)

The center speaker is for the center channel sounds (dialog, vocals, etc.). If for some reason it is not practical to use a center speaker, you can do without it. Best results, however, are obtained with the full system.

Surround left and right speakers (SL and SR)

The surround speakers are used for effect and surround sounds.

Subwoofer (SW)

The use of a subwoofer with a built-in amplifier, such as the Yamaha Active Servo Processing Subwoofer System, is effective not only for reinforcing bass frequencies from any or all channels, but also for high fidelity sound reproduction of the LFE (low-frequency effect) channel included in Dolby Digital and DTS sources. The position of the subwoofer is not so critical, because low bass sounds are not highly directional. But it is better to place the subwoofer near the front speakers. Turn it slightly toward the center of the room to reduce wall reflections.

Connecting speakers

Be sure to connect the left channel (L), right channel (R), “+” (red) and “-” (black) properly. If the connections are faulty, this unit cannot reproduce the input sources accurately.

Caution

- Before connecting the speakers, make sure that this unit is turned off (see page 21).
- Do not let the bare speaker wires touch each other or let them touch any metal part of this unit. This could damage this unit and/or the speakers.
- Use the magnetically shielded speakers. If this type of speaker still creates interference with the monitor, place the speakers away from the monitor.
- If you are to use 6 ohm speakers, be sure to set “SP IMP.” to “6Ω MIN” before using this unit (see page 13).

Note

A speaker cable is actually a pair of insulated cables running side by side. Cables are colored or shaped differently, perhaps with a stripe, groove or ridge. Connect the striped (grooved, etc.) cable to the “+” (red) terminals of this unit and your speaker. Connect the plain cable to the “-” (black) terminals.

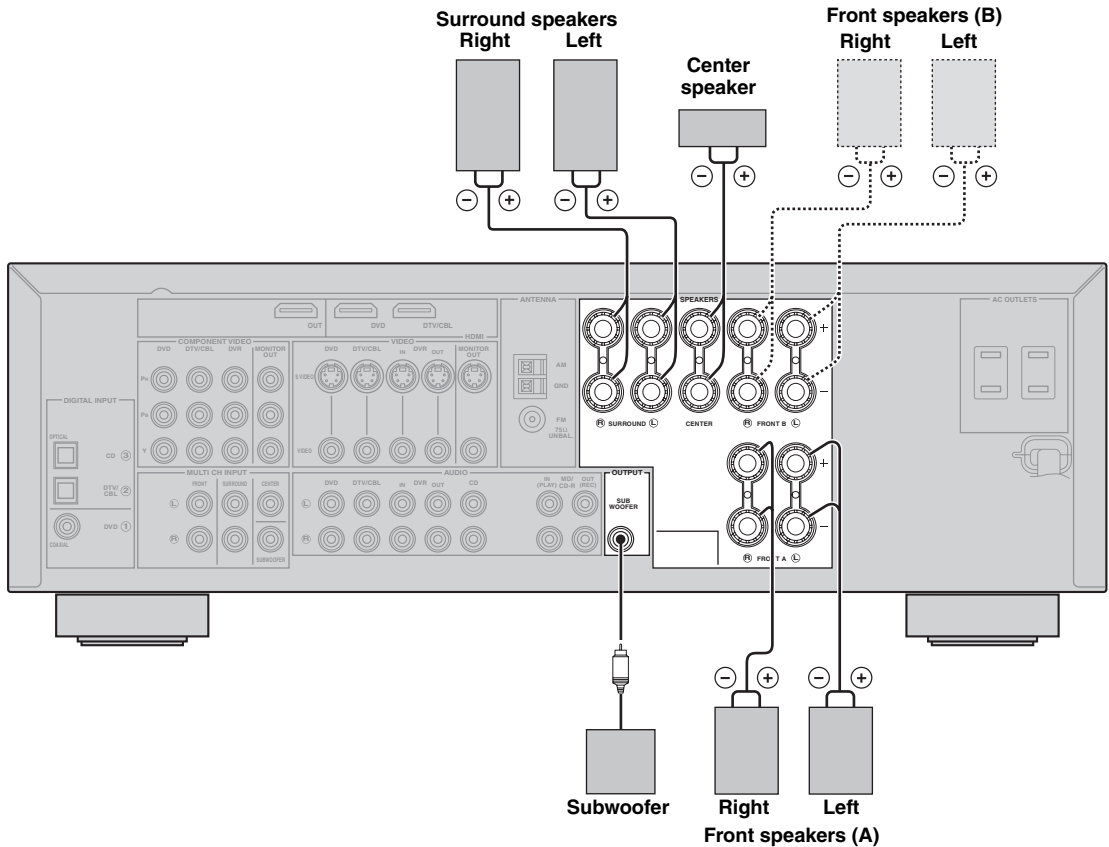

■ Before connecting to the SPEAKERS terminal

A speaker cord is actually a pair of insulated cables running side by side. Cables are colored or shaped differently, perhaps with a stripe, groove or ridges. Connect the striped (grooved, etc.) cable to the “+” (red) terminals of this unit and your speaker. Connect the plain cable to the “-” (black) terminals.

Remove approximately 10 mm (3/8”) of insulation from the end of each speaker cable and then twist the bare wires of the cable together to prevent short circuits.

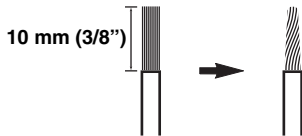

■ Connecting to the SPEAKERS terminals

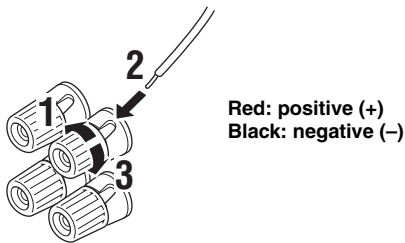

1 Loosen the knob.

2 Insert the bare end of the speaker wire into the hole on the terminal.

3 Tighten the knob to secure the wire.

Connecting the banana plug

The banana plug is a single-pole electrical connector widely used to terminate speaker cables. First, tighten the knob and then insert the banana plug connector into the end of the corresponding terminal.

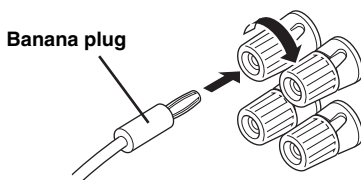

Setting the speaker impedance

Caution

If you are to use 6 ohm speakers, set “SP IMP.” to “6Ω MIN” as follows BEFORE using this unit.

1 Make sure this unit is turned off.

See page 21 for details about turning on or off this unit.

2 Press and hold **⓫ TONE CONTROL** and then press **Ⓛ STANDBY/ON** to turn on this unit.

This unit turns on, and the advanced setup menu appears in the front panel display.

3 Press **Ⓜ PROGRAM** **</>** repeatedly to select “SP IMP.”.

The following display appears in the front panel display.

SP IMP.- 8ΩMIN

4 Press **Ⓜ STRAIGHT** repeatedly to select “6Ω MIN”.

The following display appears in the front panel display.

SP IMP.- 6ΩMIN

5 Press **Ⓛ STANDBY/ON** to confirm your selection and set this unit to the standby mode.

Note

The setting you made is reflected next time you turn on this unit.

Information on jacks and cable plugs

Audio jacks and cable plugs

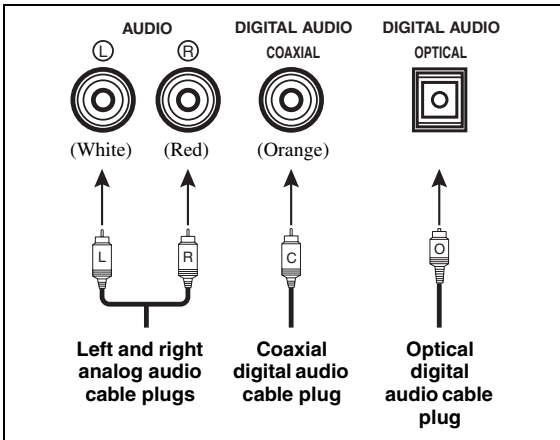

Video jacks and cable plugs

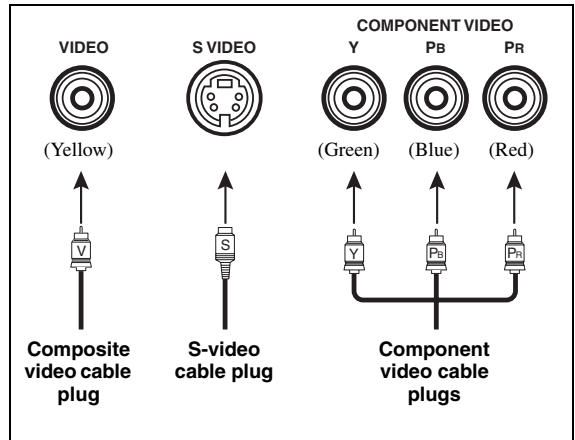

■ Audio jacks

This unit has three types of audio jacks. Connection depends on the availability of audio jacks on your other components.

AUDIO jacks

For conventional analog audio signals transmitted via left and right analog audio cables. Connect red plugs to the right jacks and white plugs to the left jacks.

DIGITAL AUDIO COAXIAL jacks

For digital audio signals transmitted via coaxial digital audio cables.

DIGITAL AUDIO OPTICAL jacks

For digital audio signals transmitted via optical digital audio cables.

Notes

- You can use the digital jacks to input PCM, Dolby Digital and DTS bitstreams. All digital input jacks are compatible with digital signals with up to 96 kHz of sampling frequency.
- This unit handles digital and analog signals independently. Thus audio signals input at the digital jacks are not output at the analog AUDIO OUT (REC) jacks.
- Pull out the cap from the optical jack before you connect the optical digital audio cable. Do not discard the cap. When you are not using the optical jack, be sure to put the cap back in place. This cap protects the jack from dust.



■ Video jacks

This unit has three types of video jacks. Connection depends on the availability of input jacks on your video monitor.

VIDEO jacks

For conventional composite video signals transmitted via composite video cables.

S VIDEO jacks

For S-video signals, separated into the luminance (Y) and chrominance (C) video signals transmitted on separate wires of S-video cables.

COMPONENT VIDEO jacks

For component signals, separated into the luminance (Y) and chrominance (PB, PR) video signals transmitted on separate wires of component video cables.

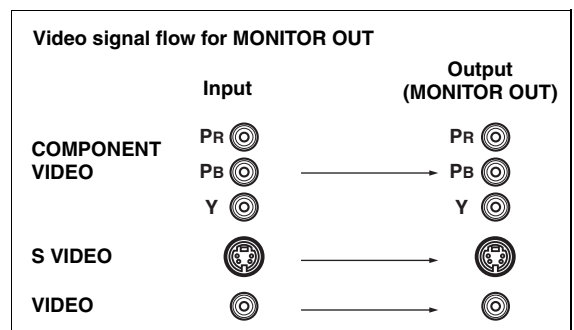

Note

The OSD signal is not output at the DVR OUT (REC) jacks.

Information on HDMI™

Audio signals input at the HDMI jack are not output from any speaker terminals but output from the connected video monitor.

To enjoy the sound from speakers connected to this unit,

- make an analog or digital connection besides the HDMI connection (see page 16).
- mute the volume of the connected video monitor.

You can play back pictures by connecting your video monitor and video source component to this unit using HDMI connections.

At that time, audio/video signals output from the connected component (such as DVD player etc.) are output to the connected video monitor only when this unit is turned on and set to the input source (DVD or DTV/CBL).

Furthermore, available audio/video signals depend on the specification of the connected video monitor. Refer to the instruction manual of each connected component.

■ HDMI jack and cable plug

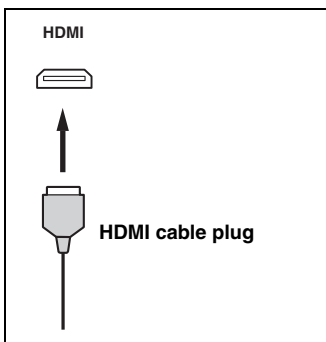

- We recommend using an HDMI cable shorter than 5 meters (16 feet) with the HDMI logo printed on it.
- Use a conversion cable (HDMI jack ↔ DVI-D jack) to connect this unit to other DVI components.

Connecting video components

Connect the video components as follows.



You can also connect a video monitor, DVD player, digital TV, and cable TV to this unit using the S VIDEO or COMPONENT VIDEO connections (see page 17).



Make sure that this unit and other components are unplugged from the AC wall outlets.

■ Connecting a video monitor and a DVD player

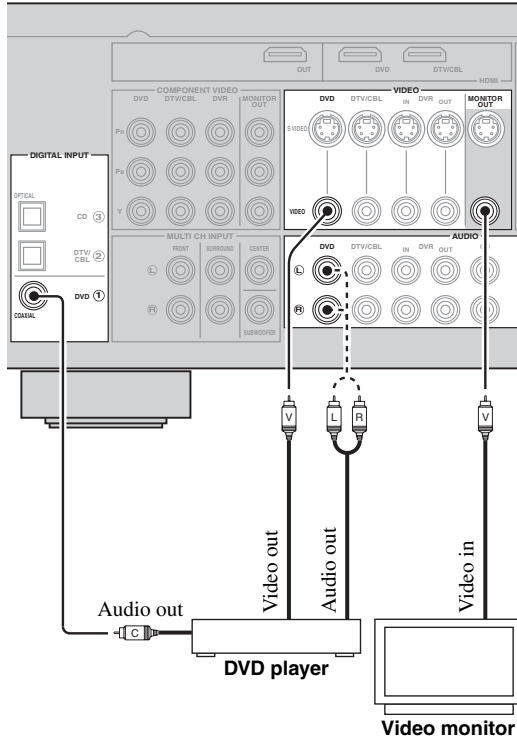

———— indicates recommended connections

----- indicates alternative connections

■ Connecting a cable TV/satellite tuner and a DVD recorder

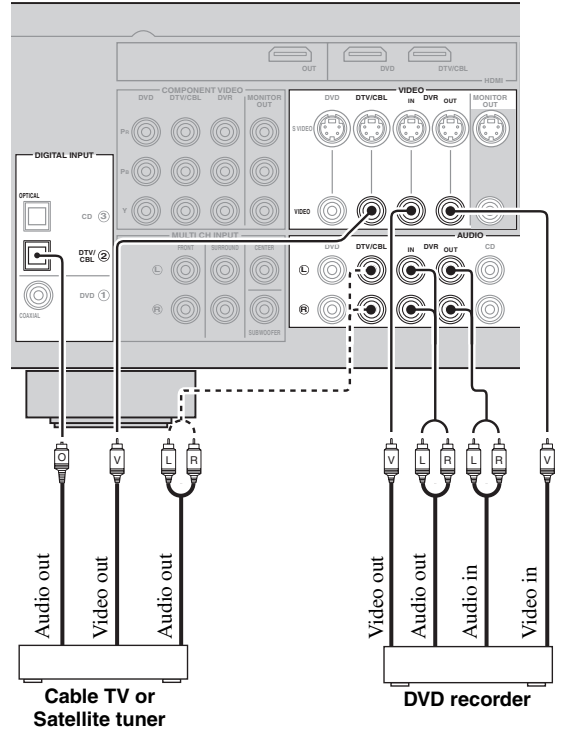

———— indicates recommended connections

----- indicates alternative connections

■ Connecting to the HDMI, COMPONENT VIDEO or S VIDEO jacks

You can enjoy high-quality pictures by connecting your video monitor and video source components to this unit using HDMI, COMPONENT VIDEO or S VIDEO connections.

Note

Be sure to connect your video components in the same way you connect your video monitor to this unit. For example, if you connect your video monitor to this unit using a HDMI connection, connect your video components to this unit using the HDMI connection.

HDMI connection

Audio signals input at the HDMI jack are not output from any speaker terminals but output from the connected video monitor.

To enjoy the sound from speakers connected to this unit,

- make an analog or digital connection besides the HDMI connection (see page 16).
- mute the volume of the connected video monitor.

Notes

- When you connect your TV monitor or projector via HDMI connection, the OSD does not appear. In such cases, connect the TV monitor or projector via component, S-video or video connection.
- Connect the input source components to the HDMI DVD or HDMI DTV/CBL jack to display the video images on the video monitor connected to the HDMI OUT jack.
- Audio/video signals output from the connected component (such as DVD player etc.) are output to the connected video monitor only when this unit is turned on and set to the input source (DVD or DTV/CBL).
- Available audio/video signals depend on the specification of the connected video monitor. Refer to the instruction manual of each connected component.

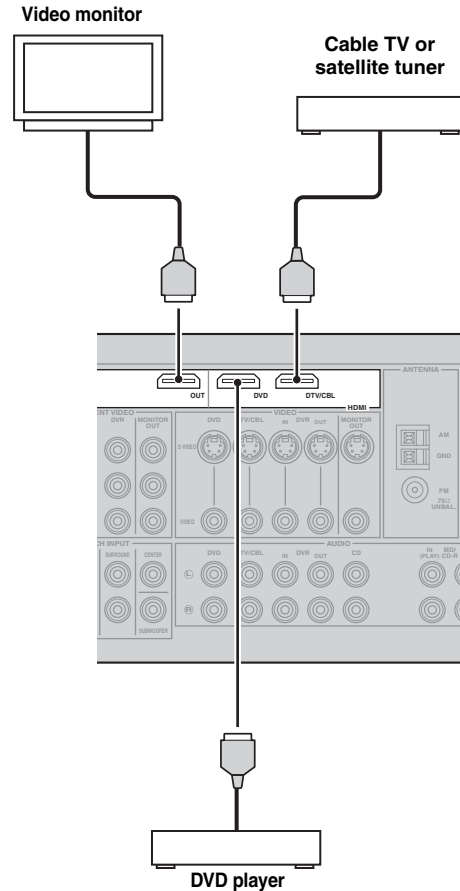

COMPONENT VIDEO connection

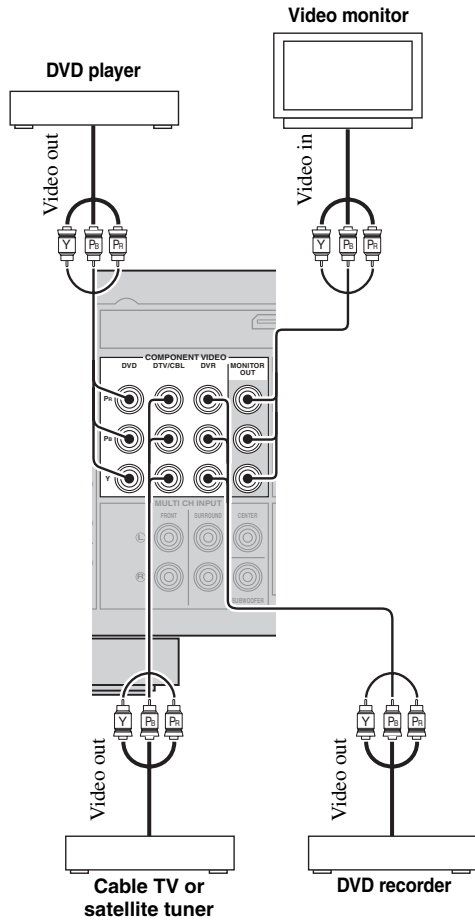

S VIDEO connection

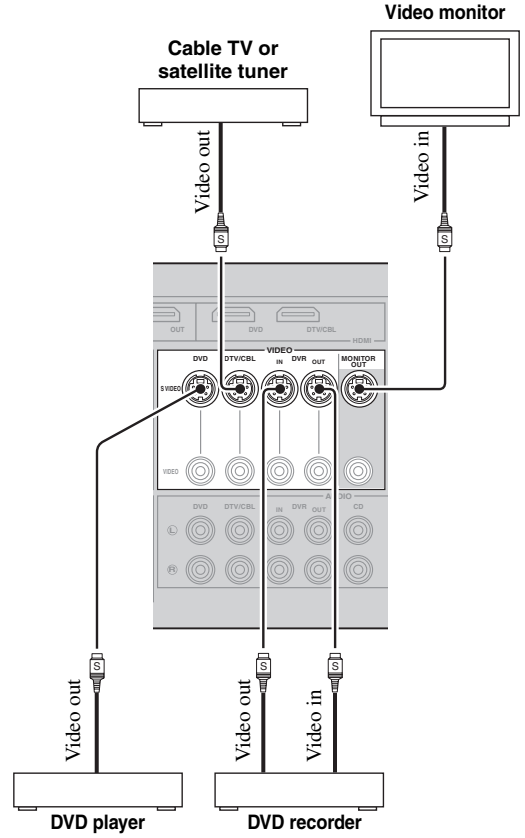

Connecting audio components

Connect the audio components as follows.

■ Connecting a CD player and a CD recorder/MD recorder

Note

When you connect your CD player via analog and digital connection, priority is given to the signal input at the DIGITAL INPUT jack.



Make sure that this unit and other components are unplugged from the AC wall outlets.

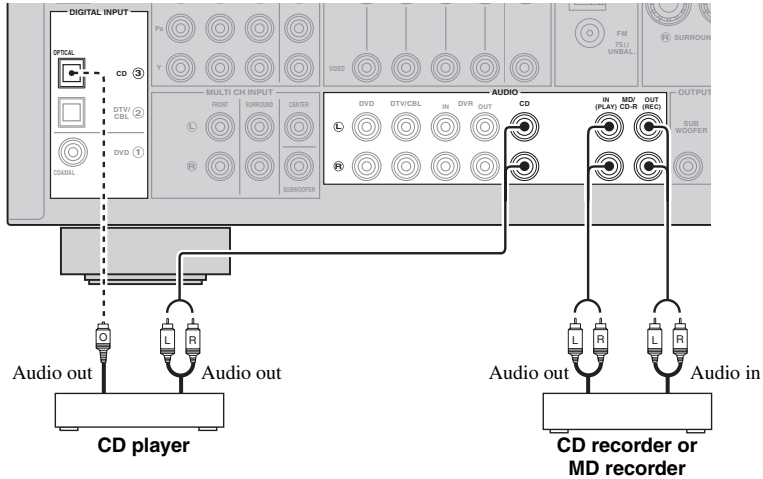

———— indicates recommended connections
 - - - - - indicates alternative connections

■ Connecting to the MULTI CH INPUT jacks

This unit is equipped with 6 additional input jacks (FRONT L/R, SURROUND L/R, CENTER and SUBWOOFER) for discrete multi-channel input from a multi-format player, external decoder or sound processor. Connect the output jacks on your multi-format player or external decoder to the MULTI CH INPUT jacks. Be sure to match the left and right output jacks to the left and right input jacks for the front and surround channels.

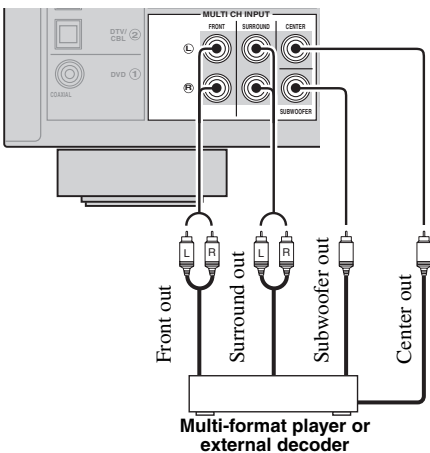

Notes

- When you select the component connected to the MULTI CH INPUT jacks as the input source (see page 33), this unit automatically turns off the digital sound field processor, and you cannot select sound field programs.
- This unit does not redirect signals input at the MULTI CH INPUT jacks to accommodate for missing speakers. We recommend that you connect a 5.1-channel speaker system before using this feature.

Using the VIDEO AUX jacks on the front panel

Use the VIDEO AUX jacks on the front panel to connect a game console or a video camera to this unit.

Caution

Be sure to turn down the volume of this unit and other components before making connections.

Notes

To reproduce the source signals input at these jacks, select "V-AUX" as the input source.

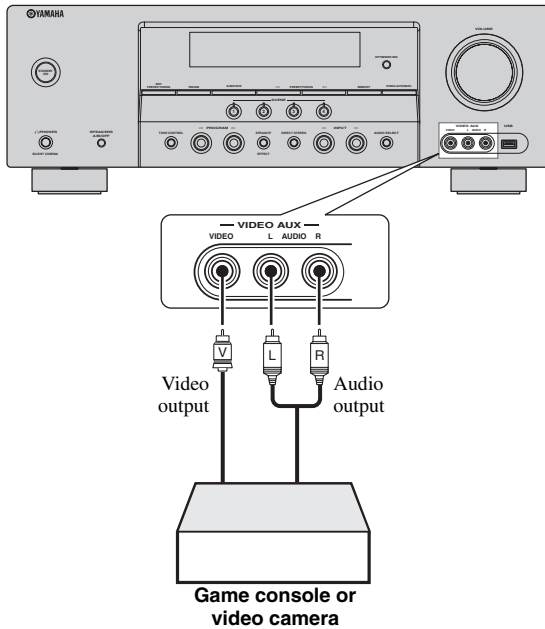

Connecting the FM and AM antennas

Both FM and AM indoor antennas are supplied with this unit. In general, these antennas should provide sufficient signal strength. Connect each antenna correctly to the designated terminals.

Notes

- The AM loop antenna should be placed away from this unit.
- A properly installed outdoor antenna provides clearer reception than an indoor one. If you experience poor reception quality, install an outdoor antenna. Consult the nearest authorized Yamaha dealer or service center about outdoor antennas.
- The AM loop antenna should always be connected, even if an outdoor AM antenna is connected to this unit.

Outdoor AM antenna

Use a 5 to 10 m (16 to 32 ft) of vinyl-covered wire extended outdoors from a window.

AM loop antenna (supplied)

Indoor FM antenna (supplied)

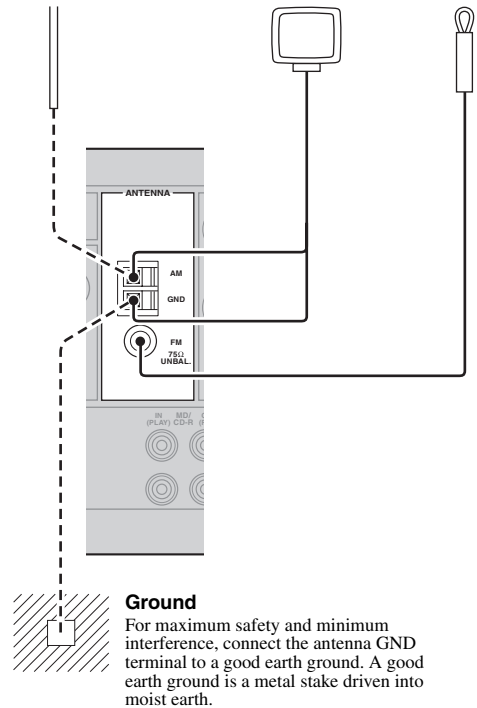

Ground

For maximum safety and minimum interference, connect the antenna GND terminal to a good earth ground. A good earth ground is a metal stake driven into moist earth.

Connecting the power cable

Once all connections are complete, plug the power cable into the AC wall outlet.

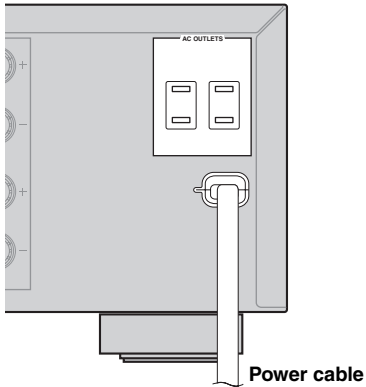

■ AC OUTLETS (SWITCHED)

Use these outlets to supply power to any connected components. Connect the power cable of your other components to these outlets. Power to these outlets is supplied when this unit is turned on. However, power to these outlets is cut off when this unit is set to the standby mode. For information on the maximum power or the total power consumption of the components that can be connected to these outlets, see “Specifications” on page 70.

Turning on and off the power

■ Turning on this unit

Press **ⓘ** **STANDBY/ON** (or **Ⓜ** **POWER**) to turn on this unit.



When you turn on this unit, there will be a 4 to 5-second delay before this unit can reproduce sound.

■ Set this unit to the standby mode

Press **ⓘ** **STANDBY/ON** (or **Ⓝ** **STANDBY**) to set this unit to the standby mode.

In the standby mode, this unit consumes a small amount of power in order to receive infrared signals from the remote control.

Front panel display

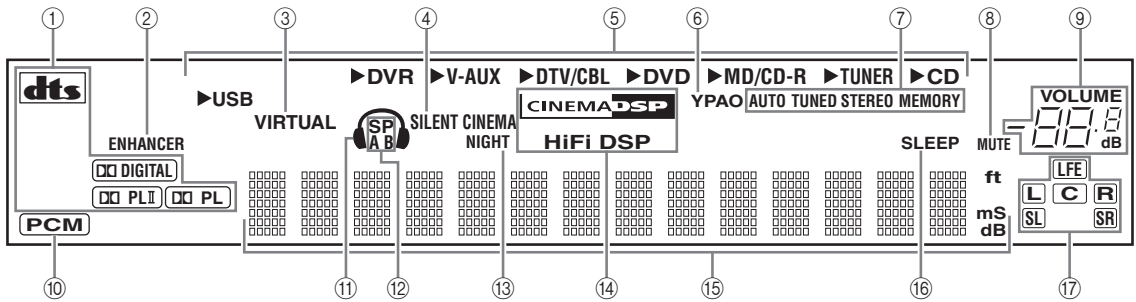

① Decoder indicator

The respective indicator lights up when any of the decoders of this unit functions.

② ENHANCER indicator

Lights up when the Compressed Music Enhancer mode is selected (see page 37).

③ VIRTUAL indicator

Lights up when Virtual CINEMA DSP is active (see page 38).

④ SILENT CINEMA indicator

Lights up when headphones are connected and a sound field program is selected (see page 38).

⑤ Input source indicators

The corresponding cursor lights up to show the currently selected input source.

⑥ YPAO indicator

Lights up when you run "AUTO SETUP" and when the speaker settings set in "AUTO SETUP" are used without any modifications (see page 24).

⑦ Tuner indicators

Lights up when this unit is in the FM or AM tuning mode (see pages 40).

⑧ MUTE indicator

Flashes while the MUTE function is on (see page 36).

⑨ VOLUME level indicator

Indicates the current volume level.

⑩ PCM indicator

Lights up when this unit is reproducing PCM (Pulse Code Modulation) digital audio signals.

⑪ Headphones indicator

Lights up when headphones are connected (see page 36).

⑫ SP A B indicators

Light up according to the set of front speakers selected (see page 33).

⑬ NIGHT indicator

Lights up when you select a night listening mode (see page 35).

⑭ CINEMA DSP indicator

Lights up when you select a CINEMA DSP sound field program (see page 37).

HiFi DSP indicator

Lights up when you select a HiFi DSP sound field program (see page 37).

⑮ Multi-information display

Shows the name of the current sound field program and other information when adjusting or changing settings.

⑯ SLEEP indicator

Lights up while the sleep timer is on (see page 36).

⑰ Input channel and speaker indicators

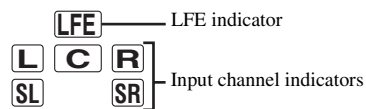

LFE indicator

Lights up when the input signal contains the LFE signal.

Input channel indicators

Indicate the channel components of the current digital input signal.

■ Using the remote control

The remote control transmits a directional infrared ray. Be sure to aim the remote control directly at the remote control sensor on this unit during operation.

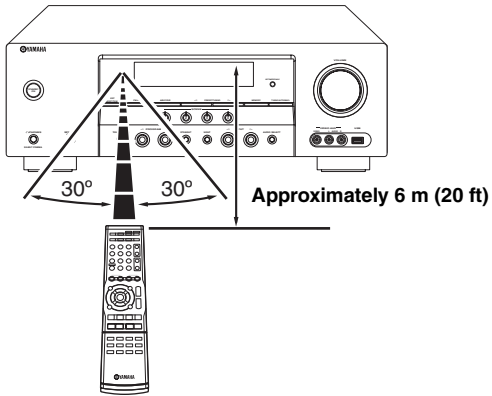

Ⓢ Infrared window

Outputs infrared control signals. Aim this window at the component you want to operate.



To set the remote control codes for other components, see page 59.

Notes

- Do not spill water or other liquids on the remote control.
- Do not drop the remote control.
- Do not leave or store the remote control in the following types of conditions:
 - places of high humidity, such as near a bath
 - places of high temperature, such as near a heater or stove
 - places of extremely low temperatures
 - dusty places

Optimizing the speaker setting for your listening room

This unit employs the YPAO (Yamaha Parametric Room Acoustic Optimizer) technology which lets you avoid troublesome listening-based speaker setup and achieves highly accurate sound adjustments automatically. The supplied optimizer microphone collects and this unit analyzes the sound your speakers produce in your actual listening environment.

Using AUTO SETUP

Notes

- Be advised that it is normal for loud test tones to be output during the “AUTO SETUP” procedure.
- To achieve the best results, make sure the room is as quiet as possible while the “AUTO SETUP” procedure is in progress. If there is too much ambient noise, the results may not be satisfactory.



You can run “AUTO SETUP” using the system menu that appears in the OSD or in the front panel display. This manual uses the OSD illustrations to explain the “AUTO SETUP” procedure.

1 Make sure of the following check points before starting the AUTO SETUP operations.

- Speakers are connected appropriately.
- Headphones are disconnected from this unit.
- This unit and the video monitor are turned on.
- The connected subwoofer is turned on and the volume level is set to about half way (or slightly less).
- The crossover frequency controls of the connected subwoofer is set to the maximum.
- FRONT A speakers are selected as the front speaker system (see page 33).
- The room is sufficiently quiet.

2 Connect the supplied optimizer microphone to the OPTIMIZER MIC jack on the front panel.

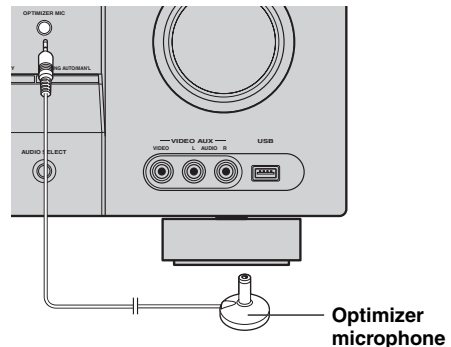

The following display appears in the OSD.

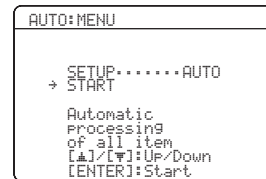

3 Place the optimizer microphone at your normal listening position on a flat level surface with the microphone heading upward.

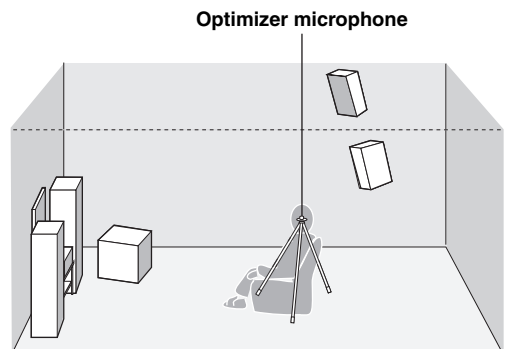

It is recommended that you use a tripod (etc.) to affix the optimizer microphone at the same height as your ears would be when you are seated in your listening position. You can use the attached screw of a tripod (etc.) to fix the optimizer microphone to the tripod (etc.).

4 Make sure that “SETUP” is set to “AUTO” and the pointer is pointing at “START”.



You can also select the following setup methods. In this case, press **Ⓢ** to select “SETUP”, press **Ⓢ** to select the one of the following choices and then select “START”.

Choices: **AUTO**, RELOAD, UNDO, DEFAULT

- Select “AUTO” to automatically run the entire “AUTO SETUP” procedure.
- Select “RELOAD” to reload the last “AUTO SETUP” settings and override the previous settings.
- Select “UNDO” to undo the last “AUTO SETUP” settings and restore the previous settings.
- Select “DEFAULT” to reset the “AUTO SETUP” parameters to the initial factory settings.

Note

“RELOAD” or “UNDO” is available only when you have previously run “AUTO SETUP” and confirmed the results.

5 Press **Ⓢ** AMP and then press **Ⓢ** ENTER to start the setup procedure.

This unit starts the auto setup procedure. Loud test tones are output from each speaker during the auto setup procedure. Once all items are set, the “AUTO:RESULT” display appears in the OSD.

Notes

- During the auto setup procedure, do not perform any operation on this unit.
- We recommend getting out of the room while this unit is in the auto setup procedure. It takes approximately 3 minutes for this unit to complete the auto setup procedure.

This unit performs the following checks:

Speaker wiring/volume level WIRING/LEVEL

Checks which speakers are connected and the polarity of each speaker. Also checks and adjusts the volume level of each speaker.

Speaker distance DISTANCE

Checks the distance of each speaker from the listening position and adjusts the timing of each channel.

Speaker size SIZE

Checks the frequency response of each speaker and sets the appropriate low-frequency crossover for each channel.

The display changes as follows.

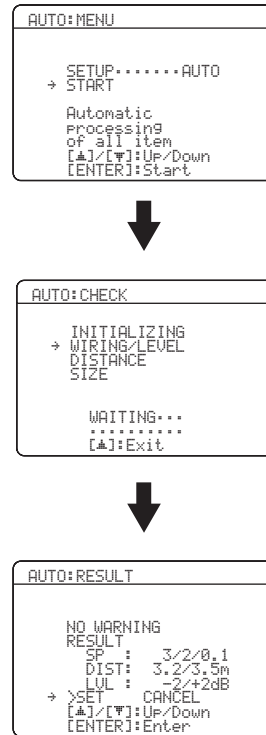

The results displayed under “RESULT” are as follows.

Number of speakers SP

Displays the number of speakers connected to this unit in the following order:
Front/Back/Subwoofer

Speaker distance DIST

Displays the speaker distance from the listening position in the following order:
Closest speaker distance/Farthest speaker distance

Speaker level LVL

Displays the speaker output level in the following order:
Lowest speaker output level/Highest speaker output level

Notes

- If “E-6:INTERNAL ERROR” appears during the testing procedure, restart from step 4.
- If you selected “RELOAD” in step 4, no test tones are output.
- If an error occurs during the “AUTO:CHECK” procedure, the setup procedure is canceled and an error screen appears. For details, see “If an error screen appears” on page 27.
- When this unit detects potential problems during the “AUTO SETUP” procedure, “WARNING” and the number of warning messages appears in the above of “RESULT” (see page 27).

6 Press **Ⓞ** **ENTER** to display the setup results in detail.

7 Press **Ⓞ** **◀/▶** repeatedly to toggle between the setup result displays.

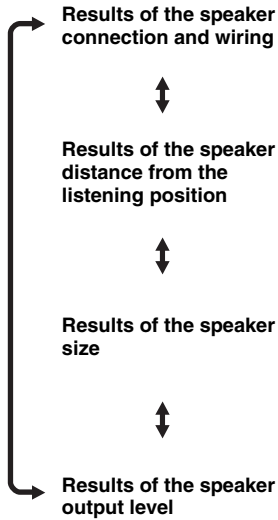

If you are not satisfied with the results or want to manually adjust each parameter, run “MANUAL SETUP” (see page 46).

Note

The distances displayed in the “DISTANCE” results may be longer than the actual distance depending on the characteristics of your speakers.

8 Press **Ⓞ** **ENTER** to return to the “AUTO:RESULT” display.

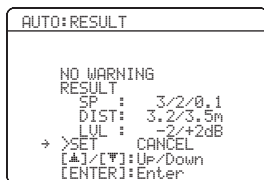

9 Make sure the pointer is pointing at “SET” and “CANCEL” and then press **Ⓞ** **◀/▶** to select “SET” or “CANCEL”.

Choices: **SET**, **CANCEL**

- Select “SET” to confirm the “AUTO SETUP” results.
- Select “CANCEL” to cancel the “AUTO SETUP” results.

10 Press **Ⓞ** **ENTER** to confirm your selection. The top “SET MENU” display appears in the OSD.

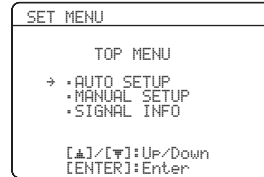

11 Press **Ⓞ** **MENU** to exit from “SET MENU”.

12 Disconnect the optimizer microphone from this unit.

The optimizer microphone is sensitive to heat. Keep it away from direct sunlight and do not place it on top of this unit.



If you change speakers, speaker positions, or the layout of your listening environment, run “AUTO SETUP” again to recalibrate your system.

■ If an error screen appears

Press **Ⓞ** **△** / **▽** / **◀** / **▶** to select “RETRY” or “EXIT” and then press **Ⓞ** **ENTER**.

The following display is an example where “E-5:USER CANCEL” appears in the OSD.

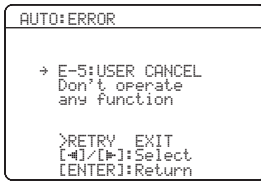

Choices: **RETRY**, **EXIT**

- Select “RETRY” to retry the “AUTO SETUP” procedure.
- Select “EXIT” to exit from the “AUTO SETUP” procedure.

■ If “WARNING” appears

When this unit detects potential problems during the “AUTO SETUP” procedure, “WARNING” appears in the “RESULT:EXIT” display. Check the warning messages to correct your speaker settings.

Note

Warnings differ from errors in that warnings do not cancel the “AUTO SETUP” procedure.

1 Make sure the pointer is pointing at “WARNING” and then press **Ⓞ** **ENTER** to display the detailed information about the warning.

The number on the right of “WARNING” indicates the number of warning messages.

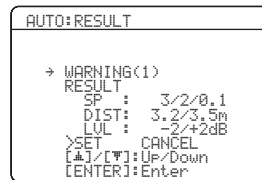

2 Press **Ⓞ** **◀** / **▶** repeatedly to toggle between the warning displays.

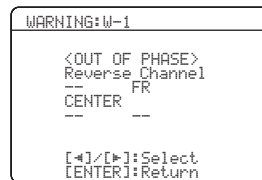

- For details about each warning message, see the “AUTO SETUP” section in “Troubleshooting” on page 65.
- When the corresponding warning message is not applicable to a speaker, “--” is displayed instead.

3 Press **Ⓞ** **ENTER** to return to the top “RESULT:EXIT” display.

Selecting the SCENE templates

This unit is equipped with 15 preset SCENE templates for various situations of using this unit. As the initial factory setting, the following SCENE templates are assigned to each SCENE button:

- SCENE 1:** DVD Viewing
- SCENE 2:** Disc Listening
- SCENE 3:** TV Viewing
- SCENE 4:** Radio Listening

If you want to use other SCENE templates, you can select the desired SCENE templates from the SCENE template library and assign the templates to the selected SCENE buttons on the front panel and the remote control.

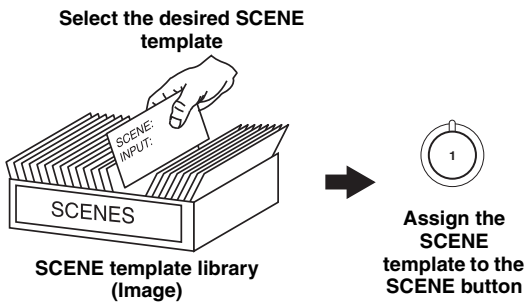

- 2 Press ⓐ INPUT $\triangleleft/\triangleright$ (or press ⓓ AMP and then press ⓐ $\triangleleft/\triangleright$) to select the desired template.**

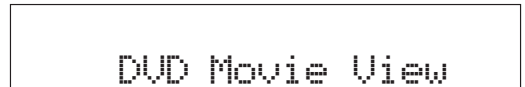
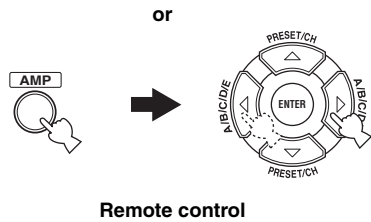
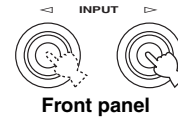

- 3 Press the ⓑ SCENE (or ⓔ SCENE) button again to confirm the selection.**

The selected SCENE template is assigned to the button.



or



Selecting the desired SCENE template

- 1 Press and hold the desired ⓑ SCENE (or ⓔ SCENE) button for 3 seconds.**

The indicator on the selected SCENE button on the front panel starts to flash, and the name of the currently assigned SCENE template appears in the front panel display.

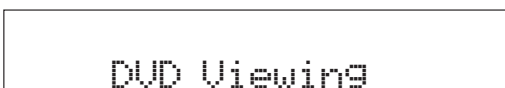
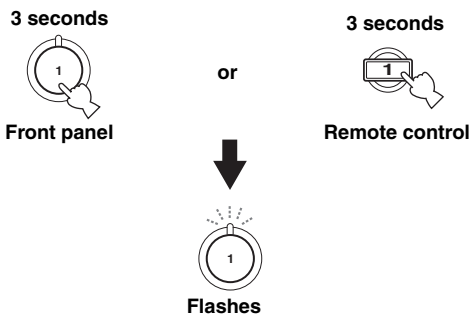

Notes

- If you do not carry out any operation within 30 seconds from the last operation in these steps, this procedure is automatically canceled.
- Once the desired SCENE templates are assigned to the corresponding SCENE buttons, you may need to set the input source of the SCENE template on the remote control. See page 56 for details.

■ Which SCENE template would you like to select?

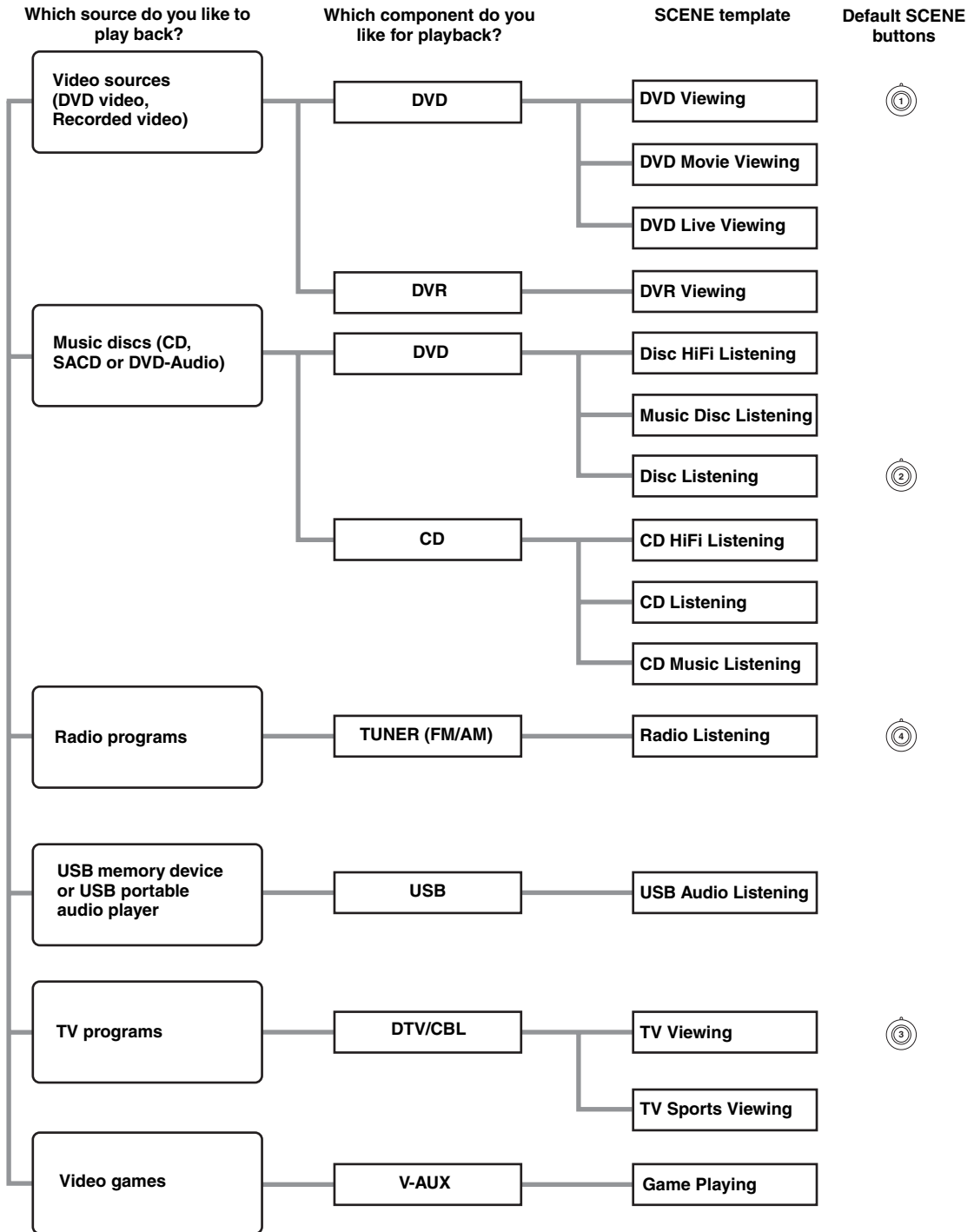

You can create your original SCENE templates by editing the preset SCENE templates. See page 31 for details.

■ Preset SCENE templates descriptions

SCENE template	
Features	
Input source	Playback mode

DVD Viewing (SCENE 1 as the default setting)	
Select this SCENE template when you play back general contents on your DVD player.	
DVD	STRAIGHT

DVD Movie Viewing	
Select this SCENE template when you play back movies on your DVD player.	
DVD	Movie Dramatic

DVD Live Viewing	
Select this SCENE template when you enjoy music live video on your DVD player.	
DVD	Pop/Rock

DVR Viewing	
Select this SCENE template when you play back movies on your digital video recorder.	
DVR	Movie Dramatic

Disc HiFi Listening	
Select this SCENE template when you enjoy the high fidelity sound of the music discs on your DVD player.	
DVD	DIRECT STEREO

Music Disc Listening	
Select this SCENE template when you play back music discs on your DVD player.	
DVD	2ch Stereo

Disc Listening (SCENE 2 as the default setting)	
Select this SCENE template when you play back music sources on your DVD player as the background music.	
DVD	5ch Stereo

CD HiFi Listening	
Select this SCENE template when you enjoy the high fidelity sound of the music discs on your CD player.	
CD	DIRECT STEREO

CD Listening	
Select this SCENE template when you play back music discs on your CD player.	
CD	2ch Stereo

CD Music Listening	
Select this SCENE template when you play back the music source on your CD player as the background music.	
CD	5ch Stereo

Radio Listening (SCENE 4 as the default setting)	
Select this SCENE template when you enjoy FM or AM radio programs.	
TUNER	MUSIC ENHANCER 5ch STEREO

USB Audio Listening	
Select this SCENE template when you play back music on your USB memory device or a USB portable audio player.	
USB	MUSIC ENHANCER 5ch STEREO

TV Viewing (SCENE 3 as the default setting)	
Select this SCENE template when you enjoy TV programs.	
DTV/CBL	STRAIGHT

TV Sports Viewing	
Select this SCENE template when you enjoy sports programs on TV.	
DTV/CBL	TV Sports

Game Playing	
Select this SCENE template when you play video games.	
V-AUX	Game

Creating your original SCENE templates

You can create your original SCENE templates for each SCENE button. You can refer to the preset 15 SCENE templates to create the original SCENE templates.

Customizing the preset SCENE templates

Use this feature to customize the preset SCENE templates.

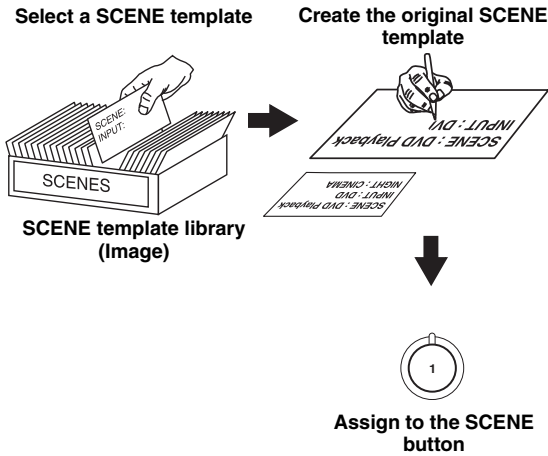

1 Turn on the video monitor connected to this unit.

2 Press and hold the desired **SCENE** button for 3 seconds and then press **AMP**.

The SCENE template customizing screen appears on the video monitor.

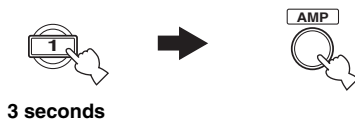

Note

When the SCENE template you want to customize is not assigned to any of the **SCENE** button, press **ENTER** repeatedly to recall the desired SCENE template on the menu screen.

3 Press **ENTER** to select the desired parameter of the SCENE template and then **LEFT** / **RIGHT** to select the desired value of the selected parameter.

You can adjust the following parameters for a SCENE template:

- **INPUT:** The input source component
- **MODE:** The active sound field programs, STRAIGHT or DIRECT STEREO mode (see pages 34 and 38)
- **NIGHT:** The night listening mode setting (see page 35)
 - **SYSTEM:** Keeps the current night listening mode.
 - **CINEMA:** Sets the night listening mode to the CINEMA mode.
 - **MUSIC:** Sets the night listening mode to the MUSIC mode.

4 Press the **SCENE** button again to confirm the edit.



An asterisk mark (*) appears by the name of the original SCENE template.

Notes

- Once the desired SCENE templates are assigned to the corresponding **SCENE** buttons, you may need to set the input source of the SCENE template on the remote control. See page 56 for details.
- You can create a customized SCENE template for each **SCENE** button, and if you create another customized SCENE template, this unit overwrites the old customized SCENE template with the new one.
- The newly created template is only available for the assigned **SCENE** button.

Renaming the SCENE templates

Select “SCENE” in step 3 of “Customizing the preset SCENE templates” and then press **ENTER**.

- Press **ENTER** / **DOWN** to select the desired character.
- Press **LEFT** / **RIGHT** to place “_” (underscore) under the space or the desired character.
- Press **RETURN** to cancel the new name.
- Press **ENTER** to confirm the new name.

Playback

Caution

Extreme caution should be exercised when you play back CDs encoded in DTS. If you play back a CD encoded in DTS on a DTS-incompatible CD player, you will only hear some unwanted noise that may damage your speakers. Check whether your CD player supports CDs encoded in DTS. Also, check the sound output level of your CD player before you play back a CD encoded in DTS.

Basic operations

1 Turn on the video monitor connected to this unit.

2 Press **INPUT** $\triangleleft / \triangleright$ repeatedly (or press one of the input selector buttons **(C)**) to select the desired input source.

The name of the currently selected input source appears in the front panel display for a few seconds.

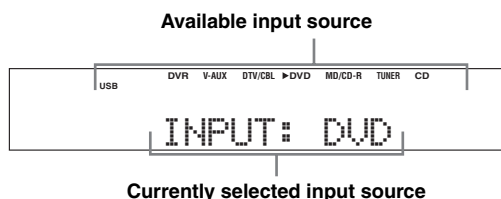

3 Start playback on the selected component or select a broadcast station.

- Refer to the operating instructions for the source component.
- See page 40 for details about FM/AM tuning instructions.

4 Rotate **VOLUME** (or press **VOLUME +/-**) to adjust the volume to the desired output level.

5 Press **PROGRAM** $\triangleleft / \triangleright$ (or press **AMP** and then **PROG** $\triangleleft / \triangleright$) repeatedly to select the desired sound field program.

The name of the selected sound field program appears in the front panel display.

See page 37 for details about sound field programs.

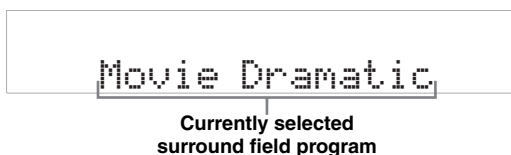

Notes

- Choose a sound field program based on your listening preference, not merely on the name of the program.
- When you select an input source, this unit automatically selects the last sound field program used with the corresponding input source.
- Sound field programs cannot be selected when the component connected to the MULTI CH INPUT jacks is selected as the input source (see page 33).
- When PCM signals with a sampling frequency higher than 48 kHz are input, this unit is automatically set to the "STRAIGHT" mode (see page 38).
- To display information about the currently selected input source in the OSD, see page 35 for details.

■ A quick guide to contents

When you want to...	See page
Enjoy pure hi-fi stereo sound	34
Adjust the tonal quality of the front speakers	34
Adjust the parameters of sound field programs	39
Enjoy the sources with a wide dynamic range at night	35
Use headphones	36
Select a decoder to play back sources with	38
Automatically set this unit to the standby mode	36

Additional operations

■ Selecting the component connected to the MULTI CH INPUT jacks as the input source

Press **14** **INPUT** **</>** repeatedly (or press **A** **MULTI CH IN**) so that “MULTI CH” appears in the front panel display.



Use “MULTI CH SET” menu in “INPUT MENU” to set the parameter for MULTI CH INPUT (see page 54).

Notes

- Sound field programs cannot be selected when the component connected to the MULTI CH INPUT jacks is selected as the input source.
- When headphones are used, signals are output only from the front left and right channels.

■ Selecting the front speaker set

Use this feature to select the front speaker system (FRONT A or FRONT B).

Press **9** **SPEAKERS** on the front panel repeatedly to turn on or off the set of front speakers connected to the FRONT A or FRONT B speaker terminals.

The activate front speaker set changes as follows:

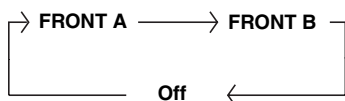

Note

Turn off the volume level of this unit when you switch the front speaker setting.

■ Using the Zone B feature

When you set “FRONT B” to “ZONE B” (see page 48), you can use the speakers connected to the FRONT B speaker terminals in another room (Zone B).

Press **9** **SPEAKERS** on the front panel repeatedly to turn on or off the Zone B speakers.

When you activate the Zone B speakers, all the speakers in the main room are muted.

Notes

- You cannot activate both the main room and Zone B speakers simultaneously.
- If you select CINEMA DSP sound field program and activate the Zone B speakers, Virtual CINEMA DSP activates automatically (see page 38).

■ Selecting audio input jacks (AUDIO SELECT)

This unit comes with a variety of input jacks. Use this feature (audio input jack select) to switch between input jacks when more than one input jack is assigned to the same input source.



- We recommend setting audio input jack select to “AUTO” in most cases.
- You can adjust the default audio input jack select of this unit by using “AUDIO SELECT” in “OPTION MENU” (see page 55).

Press **15** **AUDIO SELECT** (or **B** **AUDIO SEL**) repeatedly to select the desired audio input jack select setting.



Audio input jack select setting

- AUTO** Automatically selects input signals in the following order:
- (1) Digital signals
 - (2) Analog signals
- ANALOG** Selects only analog signals. If no analog signals are input, no sound is output.

Note

This feature is not available when no digital input jacks are assigned to the currently selected input source.

■ Enjoying pure hi-fi stereo sound

The DIRECT STEREO mode allows sources to bypass the decoders and DSP processors of this unit so that you can enjoy pure hi-fi sound from 2-channel PCM and analog sources.

Press **Ⓜ** **DIRECT STEREO** (or press **Ⓜ** **AMP** and then press **Ⓜ** **DIRECT ST.**) to select “DIRECT STEREO”.

Notes

- To avoid unexpected noise, do not play CDs encoded in DTS when the DIRECT STEREO mode is selected.
- When multi-channel signals (Dolby Digital and DTS) are input, this unit automatically switches to the corresponding analog input.
- No sound will be output from the subwoofer.
- “TONE CONTROL” (on this page) and “SOUND MENU” (see page 48) settings (except for speaker level settings) are not effective.
- The front panel display automatically dims.

■ Adjusting the tonal quality

Press **Ⓜ** **TONE CONTROL** repeatedly to select “BASS” or “TREBLE” and then press **Ⓜ** **PROGRAM** **◀/▶** (or **Ⓜ** **PROG** **◀/▶**) to adjust the corresponding frequency response level.

- Select “BASS” to adjust the low-frequency response.
- Select “TREBLE” to adjust the high-frequency response.

Notes

- Speaker and headphone adjustments are stored independently.
- If you increase or decrease the high-frequency or low-frequency sound to an extreme level, the tonal quality of the surround speakers may not match that of the front left and right speakers.

■ Adjusting speaker levels during playback

You can adjust the output level of each speaker while listening to a music source.

Note

This operation will override the level adjustments made in “AUTO SETUP” (see page 24) and “SP LEVEL” (see page 50).

1 Press **Ⓜ** **AMP** and then press **Ⓜ** **LEVEL** repeatedly to select the speaker you want to adjust.

Display	Adjusted speaker
FRONT L	Front left speaker
FRONT R	Front right speaker
CENTER	Center speaker
SWFR	Subwoofer
SUR. L	Surround left speaker
SUR. R	Surround right speaker



Once you press **Ⓜ** **LEVEL** on the remote control, you can also select the speaker by pressing **Ⓜ** **Δ** / **∇**.

2 Press **Ⓜ** **◀/▶** on the remote control to adjust the speaker output level.

The control range is from +10 dB to -10 dB.



You can press **Ⓜ** **A/B/C/D/E** to select a speaker and then **Ⓜ** **PRESET/TUNING** **◀/▶** to adjust the speaker output level.

■ Selecting the night listening mode

The night listening modes are designed to improve listenability at lower volumes or at night.

1 Press **ⓂAMP** and then press **ⓁNIGHT** repeatedly to select “NIGHT:CINEMA” or “NIGHT:MUSIC”.

Choices: NIGHT:CINEMA, NIGHT:MUSIC, OFF

- Select “NIGHT:CINEMA” to reduce the dynamic range of film soundtracks and make dialog easier to hear at lower volumes.
- Select “NIGHT:MUSIC” to preserve ease-of-listening for all sounds.
- Select “OFF” if you do not want to use this feature.



When a night listening mode is selected, the NIGHT indicator lights up in the front panel display.

2 Press **Ⓞ◀/▶** to adjust the effect level while “NIGHT:CINEMA” or “NIGHT:MUSIC” is displayed in the front panel display.

Choices: MIN, MID, MAX

- Select “MIN” for minimum compression.
- Select “MID” for standard compression.
- Select “MAX” for maximum compression.



“NIGHT:CINEMA” and “NIGHT:MUSIC” adjustments are stored independently.

Notes

- You cannot use the night listening modes in the following cases:
 - when the DIRECT STEREO mode (see page 34) is selected.
 - when the component connected to the MULTI CH INPUT jacks is selected as the input source.
 - when headphones are connected to the PHONES jack.
 - when the sound field program is selected while you enjoy music contents in a USB memory device etc.
- The night listening modes may vary in effectiveness depending on the input source and surround sound settings you use.

■ Displaying signal information

You can display the format, sampling frequency, channel, bit rate and flag data of the current input signal.

1 Press **ⓂAMP** and then press **ⓄMENU** on the remote control.

The top “SET MENU” display appears in the OSD.



2 Press **Ⓞ▽** repeatedly to select “SIGNAL INFO” and then press **ⓄENTER**.

The following information about the input source appears in the OSD.

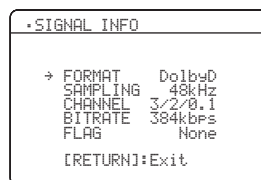

Display	Description
FORMAT	Signal format.
SAMPLING	The number of samples per second taken from a continuous signal to make a discrete signal.
CHANNEL	The number of source channels in the input signal (front/surround/LFE).
BITRATE	The number of bits passing a given point per second.
FLAG	Flag data encoded in DTS, Dolby Digital, or PCM signals that cue this unit to automatically switch decoders.



The information indicated by the cursor is also displayed in the front panel display.

3 Press **ⓄMENU** again to exit from “SET MENU”.

■ Playing video sources in the background

You can combine a video image from a video source with sound from an audio source. For example, you can enjoy listening to classical music while viewing beautiful scenery from the video source on the video monitor.

Press the input selector buttons on the remote control to select a video source and then an audio source.

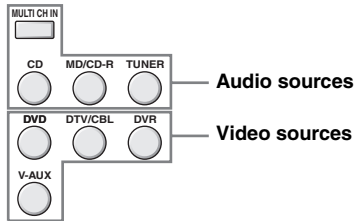

■ Using your headphones

Connect a pair of headphones with a stereo analog audio cable plug to the PHONES jack on the front panel.

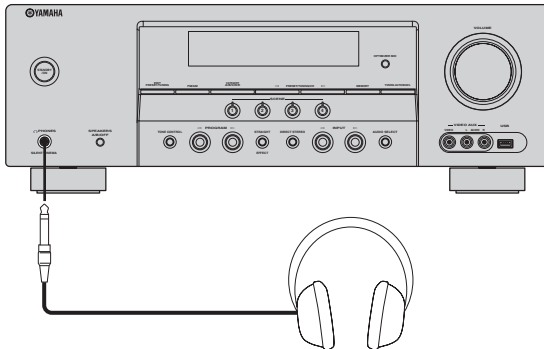

When you select a sound field program, SILENT CINEMA mode activates automatically (see page 38).

Notes

- When you connect headphones, no signals are output at the speaker terminals.
- All Dolby Digital and DTS audio signals are mixed down to the left and right headphone channels.

■ Muting the audio output

Press \odot MUTE to mute the audio output.

Press \odot MUTE again to resume the audio output.



- You can also rotate $\textcircled{8}$ VOLUME (or press \textcircled{R} VOLUME +/-) to resume the audio output.
- You can adjust the muting level by using “MUTE TYPE” in “SOUND MENU” (see page 51).
- The MUTE indicator flashes in the front panel display when the audio output is muted and disappears from the front panel display when the audio output is resumed.

■ Using the sleep timer

Use this feature to automatically set this unit to the standby mode after a certain amount of time. The sleep timer also automatically turns off any external components connected to the AC OUTLETS (see page 21).

Press \textcircled{D} AMP and then press \textcircled{P} SLEEP repeatedly to set the amount of time.

Each time you press \textcircled{P} SLEEP, the front panel display changes as shown below.

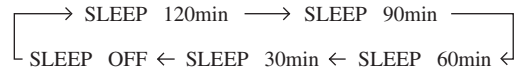

The SLEEP indicator flashes while you are switching the amount of time for the sleep timer. Once the sleep timer is set, the SLEEP indicator lights up in the front panel display, and the display returns to the selected sound field program.



- To cancel the sleep timer, press \textcircled{P} SLEEP on the remote control repeatedly until “SLEEP OFF” appears in the front panel display.
- You can also cancel the sleep timer setting by pressing $\textcircled{1}$ STANDBY/ON (or \textcircled{N} STANDBY) to set this unit to the standby mode.

Sound field programs

This unit is equipped with a variety of precise digital decoders that allow you to enjoy multi-channel playback from almost any stereo or multi-channel sound source.

Press **Ⓜ PROGRAM** $\triangleleft/\triangleright$ (or press **Ⓜ AMP** and then press **Ⓜ PROG** $\triangleleft/\triangleright$ repeatedly).

The name of the selected sound field program appears in the front panel display.



- Choose a sound field program based on your listening preference, not merely on the name of the program itself.
- You can select “Music Enh. 2ch” and “Music Enh. 5ch” by pressing **Ⓜ ENHANCER** on the remote control repeatedly.

Notes

- When you select an input source, this unit automatically selects the last sound field program used with the corresponding input source.
- Sound field programs cannot be selected when the component connected to the MULTI CH INPUT jacks is selected as the input source (see page 33).
- When PCM signals with a sampling frequency higher than 48 kHz are input, this unit is automatically set to the “STRAIGHT” mode.
- The sound field program is canceled when the night listening mode is selected while you enjoy music contents in a USB memory device etc.

Sound field program descriptions

Category	Program	Features
MUSIC	Pop/Rock	CINEMA DSP processing. This program presents an image of pop, rock, or jazz live concert. The sound field reproduces the spaciousness of a massive pavilion with an emphasis on the vividness of vocals on the stage and solo instruments and the beats of rhythm instruments.
	Hall	HiFi DSP processing. This sound field is suitable for classic and orchestral music. The program uses data collected in a large concert hall in Munich. You can enjoy delicate and beautiful reverberation and a majestic atmosphere.
	Jazz	HiFi DSP processing. The sound field is suitable for jazz and fusion music. It uses data collected in a famous jazz club in New York. You can enjoy clear reverberation.
ENTERTAIN	Game	CINEMA DSP processing. You can enjoy dynamic and thrilling sound effects as you play games. The program lets you feel the depth and three-dimensional surrounding sounds of the field where you are playing, and offers cinema-like surrounding sound effects for the scenes of movies.
	TV Sports	CINEMA DSP processing. You can enjoy sports relays broadcast in stereo and variety shows with a live sound environment. For sports relays, the voices of commentators and announcers come clearly from the center; the cheers and atmosphere in the stadium spread around within a comfortable range, and you can feel like as if you are in the stadium.
MOVIE	Movie Spacious	CINEMA DSP processing. The sound field is suitable for movies with an emphasis on spectacular sound effects, and is a perfect fit with a wide screen. The program reproduces a wide dynamic range from minimum sound effects to powerful sounds.
	Movie Dramatic	CINEMA DSP processing. This sound field is also suitable for movies with an emphasis on three-dimensional sound effects. It restrains reverberation to a moderate extent, but reproduces sound effects and background music in a soft, three-dimensional manner with clarity and center orientation of voices as pivots.
STEREO	2ch Stereo	Downmixes multi-channel sources to 2 channel or plays back 2-channel sources as they are.
	5ch Stereo	HiFi DSP processing. Using this program increases the listening position range. This is a sound field suitable for background music at parties.
ENHANCER	Music Enh. 2ch Music Enh. 5ch	Select these programs to play back compression artifacts (such as the MP3 format) in 2-channel or 5-channel stereo. This program enhances your listening experience by regenerating the missing harmonics in a compression artifact.

Note

The sound field programs of this unit are recreations of real-world acoustic environments made from precise measurements taken in the actual concert hall, music venue, movie theater, etc. Thus, you may notice variations in the strength of the reflections coming from each direction.

■ **Enjoying 2-channel sources using the standard decoders**

Signals input from 2-channel sources can also be played back on multi-channels.

Press $\text{\textcircled{D}}$ AMP and then press $\text{\textcircled{K}}$ SUR. DECODE repeatedly to select a decoder.

You can select from the following decoders depending on the type of source you are playing and your personal preference.

STANDARD	Functions
PRO LOGIC	Dolby Pro Logic processing for any sources
PLII Movie	Dolby Pro Logic II processing for movie sources
PLII Music	Dolby Pro Logic II processing for music sources
PLII Game	Dolby Pro Logic II processing for game sources

■ **Using sound field programs without surround speakers (Virtual CINEMA DSP)**

Virtual CINEMA DSP allows you to enjoy the CINEMA DSP programs without surround speakers by creating virtual speakers.

If you set “SUR. L/R SP” to “NONE” (see page 49), Virtual CINEMA DSP activates automatically whenever you select a CINEMA DSP or HiFi DSP program (see page 37).

Note

Virtual CINEMA DSP will not activate even when “SUR. L/R SP” is set to “NONE” (see page 49) in the following cases:

- When “5ch Stereo” (see page 37) is selected.
- When headphones are connected to the PHONES jack.

■ **Enjoying multi-channel sources and sound field programs with headphones (SILENT CINEMA)**

SILENT CINEMA allows you to enjoy multi-channel music or movie sound, including Dolby Digital and DTS sources, through ordinary headphones. SILENT CINEMA activates automatically whenever you connect headphones to the PHONES jack while listening to CINEMA DSP or HiFi DSP sound field programs (see page 37). When activated, the SILENT CINEMA indicator lights up in the front panel display.

Note

SILENT CINEMA does not activate when the component connected to the MULTI CH INPUT jacks is selected as the input source (see page 33).

■ **Enjoying unprocessed input sources (Straight decoding mode)**

When this unit is in the “STRAIGHT” mode, multi-channel sources are decoded straight into the appropriate channels without any additional effect processing. 2-channel stereo sources are output from only the front left and right speakers.

Press $\text{\textcircled{12}}$ STRAIGHT (or press $\text{\textcircled{D}}$ AMP and then press $\text{\textcircled{T}}$ STRAIGHT) to select “STRAIGHT”.

To deactivate the “STRAIGHT” mode, press $\text{\textcircled{12}}$ STRAIGHT (or $\text{\textcircled{T}}$ STRAIGHT) again so that “STRAIGHT” disappears from the front panel display.

■ Editing sound fields parameters

You can enjoy good quality sound with the factory preset parameters. Although you do not have to change the initial settings, you can change some of the parameters to better suit the input source or your listening room.

1 While listening to a source, press DAMP and then press $\text{G}\Delta / \nabla$ to select the desired parameter.

2 Press $\text{G}\triangleleft / \triangleright$ to change the parameter value.

Note

You cannot change parameter values when "MEMORY GUARD" in "OPTION MENU" is set to "ON" (see page 55).



Initial settings are indicated in bold under each parameter.

For Pop/Rock, Hall, Jazz, Game, TV Sports, Movie Spacious and Movie Dramatic:

DSP level DSP LEVEL

Function: Adjusts the effect level.

Choices: MIN, **MID**, MAX

For PRO LOGIC II Music:

Panorama PANORAMA

Function: Sends stereo signals to the surround speakers as well as the front speakers for a wraparound effect.

Choices: **OFF**, ON

Dimension DIMENSION

Function: Gradually adjusts the sound field either towards the front or towards the rear.

Control range: -3 (towards the rear) to +3 (towards the front), initial setting is STD (standard).

Center width CT WIDTH

Function: Adjusts the center image from all three front speakers to varying degrees. A larger value adjusts the center image towards the front left and right speakers.

Control range: 0 (center channel sound is output only from center speaker) to 7 (center channel sound is output only from front left and right speakers), initial setting is 3.

For Music Enh. 2ch and Music Enh. 5ch

Effect level

Function: Adjusts the effect level.

Choices: LOW, **HIGH**

FM/AM tuning

There are 2 tuning methods: automatic and manual. Automatic tuning is effective when station signals are strong and there is no interference. If the signal from the station you want to select is weak, tune into it manually. You can also use the automatic and manual preset tuning features to store up to 40 stations.

Automatic tuning

Automatic tuning is effective when station signals are strong and there is no interference.

- 1 Press **14 INPUT** $\triangleleft/\triangleright$ repeatedly so that “TUNER” is displayed in the front panel display.
- 2 Press **3 FM/AM** to select the reception band (FM or AM).
- 3 Press **7 TUNING AUTO/MAN'L** so that the AUTO indicator lights up in the front panel display.

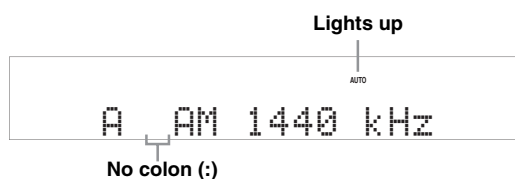

If a colon (:) appears in the front panel display, automatic tuning is not possible. Press **2 PRESET/TUNING** to turn the colon (:) off.

- 4 Press **5 PRESET/TUNING** $\triangleleft/\triangleright$ once to begin automatic tuning.
- When this unit is tuned into a station, the TUNED indicator lights up and the frequency of the received station is shown in the front panel display.

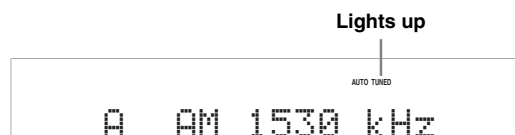

Manual tuning

If the signal received from the station you want to select is weak, tune into it manually.

Note

Manually tuning into an FM station automatically switches the tuner to monaural reception to increase the signal quality.

- 1 Press **14 INPUT** $\triangleleft/\triangleright$ repeatedly so that “TUNER” is displayed in the front panel display.
 - 2 Press **3 FM/AM** to select the reception band (FM or AM).
 - 3 Press **7 TUNING AUTO/MAN'L** so that the AUTO indicator disappears from the front panel display.
-
- No colon (:)
- A AM 1440 kHz
- If a colon (:) appears in the front panel display, manual tuning is not possible. Press **2 PRESET/TUNING** to turn the colon (:) off.
- 4 Press **5 PRESET/TUNING** $\triangleleft/\triangleright$ to tune into the desired station manually.



Hold down the button to continue searching.

Automatic preset tuning

You can use the automatic preset tuning feature to store FM stations with strong signals up to 40 (A1 to E8: 8 preset station numbers in each of the 5 preset station groups) of those stations in order. You can then recall any preset station easily by selecting the preset station number.

- 1 Press **14 INPUT** $\triangleleft/\triangleright$ repeatedly so that “**TUNER**” is displayed in the front panel display.
- 2 Press **3 FM/AM** to select “**FM**” as the reception band.
- 3 Press and hold **6 MEMORY** for more than 3 seconds.
The preset station number as well as the MEMORY and AUTO indicators flashes. After approximately 5 seconds, automatic presetting starts from the current frequency and proceeds toward the higher frequencies.

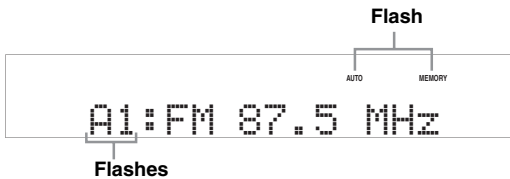

When automatic preset tuning is completed, the front panel display shows the frequency of the last preset station.



You can select the preset station group and the preset station number where the first received station will be stored by pressing **4 A/B/C/D/E** and then **5 PRESET/TUNING** $\triangleleft/\triangleright$.

Notes

- Any stored station data existing under a preset station number is cleared when you store a new station under the same preset station number.
- Only FM stations with sufficient signal strength are stored automatically by automatic preset tuning. If the station you want to store is weak in signal strength, tune into it manually and store it as described in “Manual preset tuning” on this page.

Manual preset tuning

You can also store up to 40 stations (A1 to E8: 8 preset station numbers in each of the 5 preset station groups) manually.

- 1 Tune into a station automatically or manually.
See page 40 for tuning instructions.
- 2 Press **6 MEMORY**.
The MEMORY indicator flashes in the front panel display for approximately 10 seconds.
- 3 Press **4 A/B/C/D/E** and **5 PRESET/TUNING** $\triangleleft/\triangleright$ repeatedly to select a preset station group (A1 to E8) while the MEMORY indicator is flashing.
Check that the colon (:) appears in the front panel display.

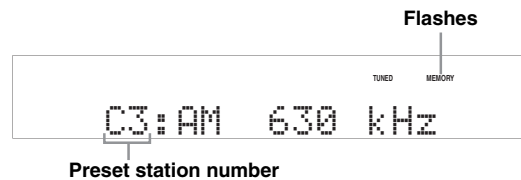

- 4 Press **6 MEMORY** while the MEMORY indicator is flashing.
The station band and frequency appear in the front panel display with the preset station group and number you have selected.



Notes

- Any stored station data existing under a preset station number is cleared when you store a new station under the same preset station number.
- The reception mode (stereo or monaural) is stored along with the station frequency.

Selecting preset stations

You can tune into any desired station simply by selecting the preset station group and number under which it was stored.



When performing this operation with the remote control, press **Ⓞ TUNER** to select “TUNER” as the input source.

- 1 Press **④ A/B/C/D/E** (or **Ⓞ A/B/C/D/E** $\triangleleft / \triangleright$) repeatedly to select the desired preset station group (A to E).

The preset station group letter appears in the front panel display and changes each time you press the button.

- 2 Press **⑤ PRESET/TUNING** $\triangleleft / \triangleright$ (or **Ⓞ PRESET/CH** \triangle / ∇) to select the desired preset station number (1 to 8).

The preset station group and number appear in the front panel display along with the station band and frequency.



You can select the desired preset station number (1 to 8) directly by pressing the numeric buttons on the remote control.

Exchanging preset station

You can exchange the assignments of two preset stations with each other. The example below describes the procedure to exchange preset station “E1” with “A5”.

- 1 Select preset station “E1” using **④ A/B/C/D/E** and **⑤ PRESET/TUNING** $\triangleleft / \triangleright$.
See “Selecting preset stations” on this page.

- 2 Press and hold **② PRESET/TUNING** for more than 3 seconds.

“E1” and the MEMORY indicator flash in the front panel display.



- 3 Select preset station “A5” using **④ A/B/C/D/E** and **⑤ PRESET/TUNING** $\triangleleft / \triangleright$.

“A5” and the MEMORY indicator flash in the front panel display.

See “Selecting preset stations” on this page.



- 4 Press **② PRESET/TUNING** again.

“EDIT E1–A5” appears in the front panel display and the assignments of the two preset stations are exchanged.

Using a USB memory device or a USB portable audio player

Use this feature to enjoy WAV (PCM format only), MP3 and WMA files saved on your USB memory device or USB portable audio player connected to the USB port on the front panel of this unit.

■ Supported USB devices

This unit supports USB mass storage class devices (except USB hard disk drives) using FAT16 or FAT32 format.

Notes

- Only the first partition (32 GB or less) is displayed in the OSD. You cannot select files in other partitions.
- Up to 8 levels of directory hierarchy and 500 music files per directory are recognized.
- Some devices may not work properly even if they meet the requirements.
- Some WAV, MP3 and WMA files may not be playable or may be noisy when played.

■ Connecting a USB memory device or a USB portable audio player

Connect a USB jack of a USB memory device or USB portable audio player to the USB port on the front panel of this unit.

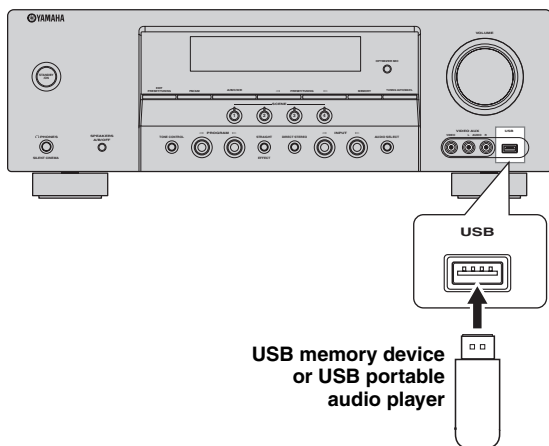

Playback operation

Follow the procedures below to enjoy the music stored in your USB device or a USB portable audio player.

- 1 Press **INPUT** $\triangleleft/\triangleright$ repeatedly (or press **USB**) to select USB.

The cursor on the left of the USB indicator lights up in the front panel display, and the contents previously played is automatically played.

Lights up



- 2 Press **DISPLAY** to display the top USB file list.

The USB file list appears in the OSD.

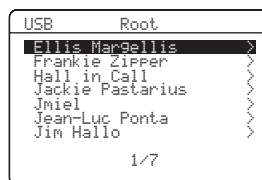

- “>” in the right corner of each menu line indicates that there is a submenu available in the next menu level.
- When this unit is in the top directory, “Root” appears beside “USB”.

3 Press \odot / Δ / ∇ / \triangleleft / \triangleright on the remote control to select the desired file.

- Press \odot / Δ / ∇ to select the desired file/folder.
- Press \odot / **ENTER** or \odot / \triangleright to enter the selected folder.
- Press \odot / \triangleleft to return to the previous folder level.

4 Press \odot / **ENTER** to play the selected file.



- You can use \odot / $\triangleleft\triangleleft$ / $\triangleright\triangleright$ to skip backward/forward and \odot / \triangleright / \square to start/stop playback independently from the menu in the OSD.
- You can set the settings for repeat and shuffle mode by using the “USB PLAY STYLE” parameters in “OPTION MENU” (see page 55).
- You can select the display mode in the front panel display by using “FL SCROLL” in “OPTION MENU” (see page 54).

■ The function of the play information display

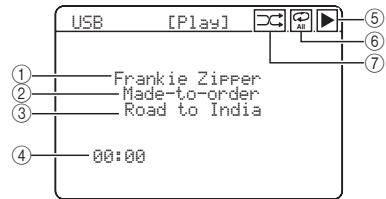

- ① Name of the artist
- ② Name of the album
- ③ Name of the song
- ④ Elapsed time

Note

When the elapsed time exceed “99:59”, “--:--” appeared instead of the time.

- ⑤ (playback) icon
- ⑥ (all repeat), (single repeat) icons
When “REPEAT” of the “USB PLAY STYLE” in “OPTION MENU” (see page 55) is set to “OFF”, no icon appears in the top right corner while files or folders are being played.
- ⑦ (shuffle) icon
When “SHUFFLE” of the “USB PLAY STYLE” in “OPTION MENU” (see page 55) is set to “OFF”, no icon appears in the top right corner while files or folders are being played.

Recording

Recording adjustments and other operations are performed from the recording components. Refer to the operating instructions for those components.

Notes

- When this unit is set to the standby mode, you cannot record between other components connected to this unit.
- TONE CONTROL (see page 34) and VOLUME settings, speaker levels (see page 34) and the sound field programs (see page 37) do not affect recorded material.
- The source connected to the USB jack or the MULTI CH INPUT jacks of this unit cannot be recorded.
- Digital signals input at the DIGITAL INPUT jacks are not output at the analog AUDIO OUT (REC) jacks for recording. Therefore, if your source component is connected to provide only digital signals, you cannot record the source.
- S-video and composite video signals pass independently through the video circuits of this unit. Therefore, when recording or dubbing video signals input from a video source component that provides only an S-video or a composite video signal, you can record only an S-video or a composite video signal on your DVD recorder.
- A given input source is not output on the same OUT (REC) channel.
- Once you have connected a recording component to this unit, keep the component turned on while using this unit. If the component is turned off, this unit may distort the sound from other components.
- Check the copyright laws in your country to record from CDs, radio, etc. Recording of copyrighted material may infringe copyright laws.



Do a test recording before you start an actual recording.

If you play back a video source that uses scrambled or encoded signals to prevent it from being dubbed, the picture itself may be disturbed due to those signals.

1 Turn on all the connected components.

2 Press  INPUT </> repeatedly (or press one of the input selector buttons (C)) to select the source component you want to record from.

3 Start playback on the selected source component or select a broadcast station.

4 Start recording on the recording component.

SET MENU

You can use the following parameters in “SET MENU” to adjust a variety of system settings and customize the way this unit operates. Change the initial settings (indicated in bold under each parameter) to reflect the needs of your listening environment.

■ Auto setup **AUTO SETUP**

Use this feature to automatically adjust speaker and system parameters (see page 24).

■ Manual setup **MANUAL SETUP**

Use this feature to manually adjust speaker and system parameters.

Sound menu **1 SOUND MENU**

Use this menu to manually adjust any speaker settings, alter the quality and tone of the sound output by the system or compensate for video signal processing delays when using LCD monitors or projectors.

Parameter	Features	Page
A>SPEAKER SET	Selects the size of each speaker, the speakers for low-frequency signal output, and the crossover frequency, and the location of the front speakers connected to the FRONT B terminals.	48
B>SP LEVEL	Adjusts the output level of each speaker.	50
C>SP DISTANCE	Adjusts the distance of each speaker.	50
D>CENTER GEO	Adjusts the tonal quality of the center speaker.	51
E>LFE LEVEL	Adjusts the output level of the LFE channel for Dolby Digital or DTS signals.	51
F>D. RANGE	Adjusts the dynamic range of Dolby Digital or DTS signals.	51
G>AUDIO SET	Adjusts the muting level, audio delay, maximum volume level and initial volume level.	51

Input menu **2 INPUT MENU**

Use this menu to manually reassign the input jacks, select the input mode or rename the input source.

Parameter	Features	Page
A>INPUT ASSIGN	Assigns the input jacks of this unit according to the component to be used.	52
B>INPUT RENAME	Changes the name of the input source.	53
C>VOLUME TRIM	Adjusts the output volume of each input source.	53
D>DECODER MODE	Selects the decoder mode for the sources connected to the DIGITAL INPUT jacks on the rear panel of this unit.	53
E>MULTI CH SET	Selects the video source played in the background of the sources input from the MULTI CH INPUT jacks.	54

Option menu 3 OPTION MENU

Use this menu to manually adjust the optional system parameters.

Parameter	Features	Page
A)DISPLAY SET	Adjusts the brightness of the front panel display.	54
B)MEMORY GUARD	Locks sound field program parameters and other “SET MENU” settings.	55
C)AUDIO SELECT	Designates the default audio input jack select setting for the input sources connected to the DIGITAL INPUT jacks when you turn on the power of this unit.	55
D)PARAM. INI	Sets all the parameters of the sound field programs to the factory settings.	55
E)USB PLAY STYLE	Adjusts the playback style of a USB source.	55

■ Signal information SIGNAL INFO

Use this feature to check audio signal information (see page 35).

Using SET MENU

Use the remote control to access and adjust each parameter.



You can change the “SET MENU” parameters while this unit is reproducing sound.

1 Press **[AMP]** and then press **[MENU]** to enter “SET MENU”.

The top “SET MENU” display appears in the OSD.

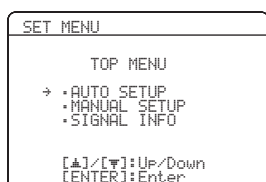

2 Press **[▲/▼]** to select “MANUAL SETUP”.

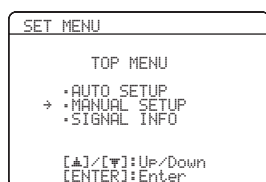

3 Press **[ENTER]** to enter “MANUAL SETUP”.

The “MANUAL SETUP” display appears in the OSD.

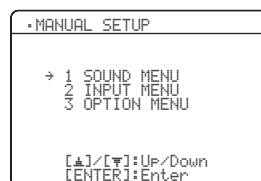

4 Press **[▲/▼/◀/▶]** and **[ENTER]** to select and change the parameter.

- Press **[▲/▼]** to select the desired menu or parameter.
- Press **[◀/▶]** to change the parameter value.
- Press **[ENTER]** to enter the selected menu or to confirm the parameter.
- Press **[RETURN]** to return to the previous menu level.

5 Press **[MENU]** to exit from “SET MENU”.

1 SOUND MENU

Use this menu to manually adjust any speaker settings or compensate for video signal processing delays.

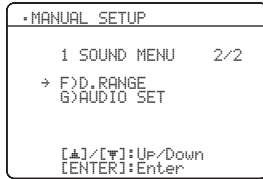
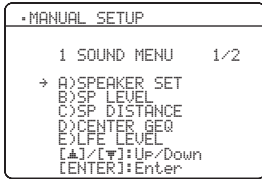

■ Speaker settings A) SPEAKER SET

Use this feature to manually adjust any speaker settings.

FRONT B speaker setting FRONT B

Use this feature to select the location of the front speakers connected to the FRONT B terminals.

Choices: **FRONT**, ZONE B

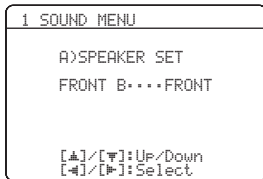

- Select "FRONT" to turn on or off SPEAKERS A and B when the speakers connected to the FRONT B terminals are set in the main zone.
- Select "ZONE B" if the speakers connected to the FRONT B terminals are set in another zone. If SPEAKERS A is turned off and SPEAKERS B is turned on, all the speakers including the subwoofer in the main zone are muted and this unit outputs sound at the FRONT B terminals only.

Notes

- If you connect headphones to the PHONES jack of this unit, the sound is output from both headphones and the FRONT B terminals when "FRONT B" is set to "ZONE B".
- If a DSP program is selected when "FRONT B" is set to "ZONE B", this unit automatically enters the Virtual CINEMA DSP mode (see page 38).

Woofers section of a speaker is 16 cm (6.5 in) or larger: large
 Woofers section of a speaker is smaller than 16 cm (6.5 in): small

Front speakers FRONT SP

Choices: SMALL, **LARGE**

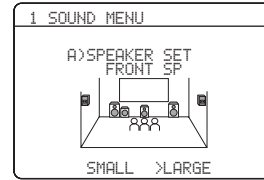

When the front speakers are large

Select "LARGE" (large).

When the front speakers are small

Select "SMALL" (small).

Note

When "LFE/BASS OUT" is set to "FRONT" (see page 49), you can select only "LARGE" in "FRONT SP". If the value of "FRONT SP" is set to a setting other than "LARGE" in advance, this unit automatically changes the value to "LARGE".

Center speaker CENTER SP

Choices: NONE, **SML**, LRG

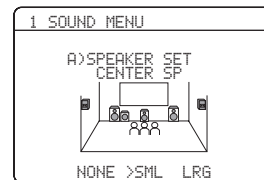

When the center speaker is large

Select "LRG" (large).

When the center speaker is small

Select "SML" (small).

When you do not use the center speaker

Select "NONE" (none). The center channel signals are directed to the front left and right speakers.

Surround left/right speakers SUR. L/R SP

Choices: NONE, SML, LRG

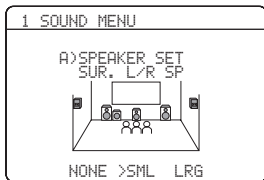
**When the surround speakers are large**

Select "LRG" (large).

When the surround speakers are small

Select "SML" (small).

When you do not use the surround speakers

Select "NONE" (none). This unit is set to the Virtual CINEMA DSP mode (see page 38).

LFE Bass out LFE/BASS OUT

Use this feature to select the speakers that output the LFE (low-frequency effect) and the low-frequency signals.

Choices: SWFR, FRONT, **BOTH**

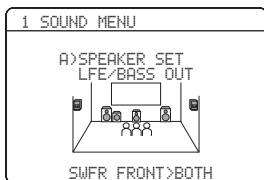
**When a subwoofer is connected to this unit and you want to get natural bass sound**

Select "SWFR" (subwoofer). The LFE signals as well as the low-frequency signals of other speakers set to "SML" (or "SMALL") are directed to the subwoofer.

When a subwoofer is connected to this unit and you want to get rich bass sound

Select "BOTH" (both). The low-frequency signals of any source are output from the subwoofer. The LFE signals as well as the low-frequency signals of other speakers set to "SML" (or "SMALL") are directed to the subwoofer. The low-frequency signals of the front left and right channels are directed to the front left and right speakers and the subwoofer regardless of the "FRONT SP" setting (see page 48).

When you do not use a subwoofer

Select "FRONT" (front). The LFE signals, the low-frequency signals of the front left and right channels, and the low-frequency signals of other speakers set to "SML" (or "SMALL") are all directed to the front left and right speakers regardless of the "FRONT SP" setting (see page 48).

Crossover CROSSOVER

Use this feature to select a crossover frequency of all the speakers set to "SML" (or "SMALL") or to "NONE" in "SPEAKER SET" (see pages 47 and 48). All frequencies below the selected frequency will be sent to the subwoofer or to the speakers set to "LRG" (or "LARGE") in "SPEAKER SET" (see pages 47 and 48).

Choices: 40Hz, 60Hz, **80Hz**, 90Hz, 100Hz, 110Hz, 120Hz, 160Hz, 200Hz

**Subwoofer phase** SUBWOOFER PHASE

Use this feature to switch the phase of your subwoofer if bass sounds are lacking or unclear.

Choices: **NORMAL**, REVERSE

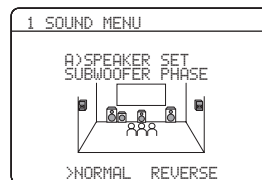

- Select "NORMAL" if you do not want to reverse the phase of your subwoofer.
- Select "REVERSE" to reverse the phase of your subwoofer.

■ **Speaker level** B)SP LEVEL

Use this feature to manually adjust the output level of each speaker.

Control range: -10 to +10 dB
 Control step: 1 dB
 Initial setting: 0 dB

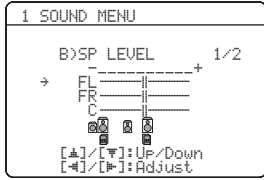

SP LEVEL	Adjusted speaker
FL	Front left speaker
FR	Front right speaker
C	Center speaker
SL	Surround left speaker
SR	Surround right speaker
SWFR	Subwoofer

Note

The available speaker channels differ depending on the setting of the speakers.

■ **Speaker distance** C)SP DISTANCE

Use this feature to manually adjust the distance of each speaker and the delay applied to the respective channel. Ideally, each speaker should be the same distance from the main listening position. However, this is not possible in most home situations. Thus, a certain amount of delay must be applied to the sound from each speaker so that all sounds will arrive at the listening position at the same time.

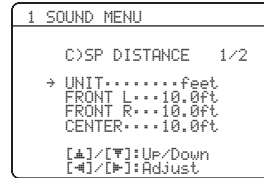

Unit UNIT

Choices: meters (m), feet (ft)

Initial setting: feet (ft)

- Select “feet” to adjust speaker distances in feet.
- Select “meters” to adjust speaker distances in meters.

Speaker distances

Control range: 0.30 to 24.00 m (1.0 to 80.0 ft)

Control step: 0.10 m (0.5 ft)

Initial setting: 3.00 m (10.0 ft)

SP DISTANCE	Adjusted speaker
FRONT L	Front left speaker
FRONT R	Front right speaker
CENTER	Center speaker
SUR. L	Surround left speaker
SUR. R	Surround right speaker
SWFR	Subwoofer

Note

The available speaker channels differ depending on the setting of the speakers.

Center speaker equalizer D)CENTER GEQ

Use this feature to adjust the built-in 5-frequency band (100Hz, 300Hz, 1kHz, 3kHz and 10kHz) graphic equalizer for the center channel so that the tonal quality of the center speaker matches that of the front speakers. You can make adjustments while listening to the currently selected source component or a test tone.

Control range: -6.0 to +6.0 dB

Control step: 0.5 dB

Initial setting: 0 dB

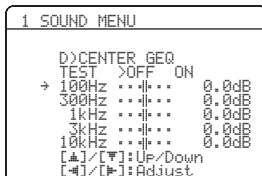

Test tone TEST

Use this feature to make adjustments for “CENTER GEQ” while listening to a test tone.

Choices: **OFF**, **ON**

- Select “OFF” to stop test tones and output the currently selected source component.
- Select “ON” to output test tones from the center and front left speakers.

Low-frequency effect level E)LFE LEVEL

Use this feature to adjust the output level of the LFE (low-frequency effect) channel according to the capacity of your subwoofer or headphones. The LFE channel carries low-frequency special effects which are only added to certain scenes. This setting is effective only when this unit decodes Dolby Digital or DTS signals.

Control range: -20 to 0 dB

Control step: 1 dB



Speaker SPEAKER

Adjusts the speaker LFE level.

Headphone HEADPHONE

Adjusts the headphone LFE level.

Note

Depending on the settings of “LFE/BASS OUT” (see page 49), some signals may not be output at the SUBWOOFER OUTPUT jack.

Dynamic range F)D.RANGE

Use this feature to select the amount of dynamic range compression to be applied to your speakers or headphones. This setting is effective only when this unit is decoding Dolby Digital and DTS signals.

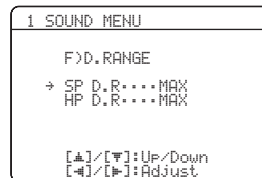

Speaker SP

Adjusts the speaker compression.

Headphone HP

Adjusts the headphone compression.

Choices: **MIN**, **STD**, **MAX**

- Select “MIN” (minimum) if you regularly listen at low volume levels.
- Select “STD” (standard) for general use.
- Select “MAX” (maximum) to preserve the greatest amount of dynamic range.

Audio settings G)AUDIO SET

Use this feature to adjust the overall audio settings of this unit.

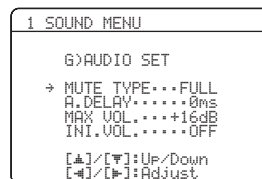

Mute type MUTE TYPE

Use this feature to adjust how much the mute function reduces the output volume (see page 36).

Choices: **FULL**, -20dB

- Select “FULL” to completely mute all the audio output.
- Select “-20dB” to reduce the current volume by 20 dB.

Audio delay A.DELAY

Use this feature to delay the sound output and synchronize it with the video image. This may be necessary when using certain LCD monitors or projectors.

Control range: 0 to 160 ms

Control step: 1 ms

Maximum volume MAX VOL.

Use this feature to set the maximum volume level. This feature is useful to avoid the unexpected loud sound by mistake. For example, the original volume range is 16 dB to -80 dB. However, when "MAX VOL." is set to -5 dB, the volume range becomes -5.0 dB to -80.0 dB.

Control range: **16 dB**, 10 dB to -30 dB
 Control step: 5 dB

Note

The "MAX VOL." setting takes priority over the "INI.VOL." setting. For example, if "INI.VOL." is set to -20 dB and "MAX VOL." is set to -30 dB, the volume level is automatically set to -30 dB when you turn on the power of this unit next time.

Initial volume INI.VOL.

Use this feature to set the volume level when the power of this unit is turned on.
 Choices: **OFF**, -80 dB to +16 dB
 Control step: 1 dB

Note

The "MAX VOL." setting takes priority over the "INI.VOL." setting.

2 INPUT MENU

Use this menu to reassign the input jacks, select the decoder mode or rename the input source.

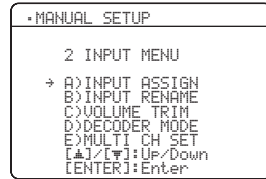

Input assignment

A) INPUT ASSIGN

Use this feature to assign the input jacks according to the component to be used if the initial settings of this unit do not correspond to your needs. Change the following parameters to reassign the respective jacks and effectively connect more components.

Once the input jacks are reassigned, you can select the corresponding component by using **14 INPUT** </> (or the input selector buttons (C)).

For COAXIAL INPUT jack 1

COAXIAL IN (1)

Choices: (1) CD, MD/CD-R, **DVD**, DTV/CBL, V-AUX, DVR

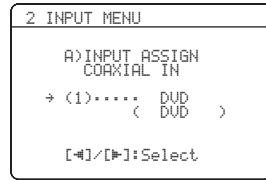

For OPTICAL INPUT jacks 2 and 3

OPTICAL IN (2)

OPTICAL IN (3)

Choices: (2) CD, MD/CD-R, DVD, **DTV/CBL**, V-AUX, DVR
 (3) **CD**, MD/CD-R, DVD, DTV/CBL, V-AUX, DVR

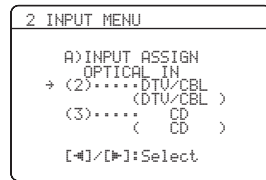

Note

You cannot select a specific item more than once.

■ Input rename B)INPUT RENAME

Use this feature to change the name of the input source that appears in the OSD and in the front panel display.



- 1 Press one of the input selector buttons (C) or A)MULTI CH IN to select the input source you want to change the name of.

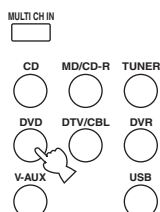

- 2 Press D)AMP and then press G)◀/▶ on the remote control to place the “_” (underscore) under the space or the character you want to edit.

- 3 Press G)▲/▼ to select the character you want to use and then press G)◀/▶ to move to the next space.

Notes

- You can use up to 8 characters for each input.
- Press G)▼ to change the character in the following order, or press G)▲ to go in the reverse order:
A to Z, a space, 0 to 9, a space, a to z, a space, symbols (#, *, -, +, etc.)

- 4 Repeat steps 1 through 3 to rename each input source.

- 5 Press G)ENTER to exit from “INPUT RENAME”.

■ Volume trim C)VOLUME TRIM

Use this feature to adjust the output volume of each source. This is useful if you want to balance the level of each input source to avoid sudden changes in volume when switching between input sources.

Choices: CD, MD/CD-R, TUNER, DVD, DTV/CBL, V-AUX, DVR, USB, MULTI CH IN

Control range: -6.0 to +6.0 dB

Control step: 1.0 dB

Initial setting: 0.0 dB

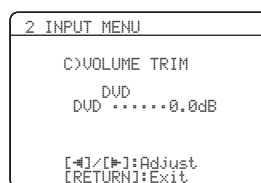

■ Decoder mode D)DECODER MODE

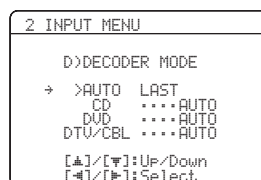

Decoder select mode

Use this feature to designate the default decoder mode for the input sources connected to the DIGITAL INPUT jacks when you turn on the power of this unit.

Choices: **AUTO**, **LAST**

- Select “AUTO” if you want this unit to automatically detect the type of input signals and select the appropriate decoder mode.
- Select “LAST” if you want this unit to automatically select the last decoder mode used the connected input source.

DTS decoder prioritize setting

Choices: **AUTO**, **DTS**

- Select “AUTO” if you want this unit to automatically detect input signal types and select the appropriate input mode.
- Select “DTS” when you play back a DTS-CD.

■ **Multi channel input setup**

E>MULTI CH SET

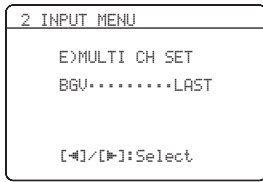

Background Video BGV

Use this feature to select the video source played in the background of the sources input at the MULTI CH INPUT jacks.

Choices: DVD, DTV/CBL, V-AUX, DVR, **LAST**



Select "LAST" to set this unit to automatically select the last selected video source as the background video source.

3 OPTION MENU

Use this menu to adjust the optional system parameters.

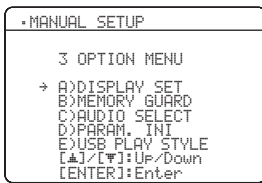

■ **Display settings** A>DISPLAY SET

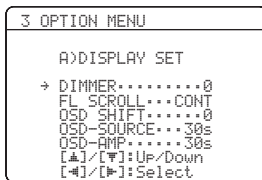

Dimmer DIMMER

Use this feature to adjust the brightness of the front panel display.

Control range: -4 to **0**

Control step: 1

- Press Ⓔ◀ to make the front panel display dimmer.
- Press Ⓔ▶ to make the front panel display brighter.

Front panel display scroll FL_SCROLL

Use this feature to set whether to display the information (such as a song title or a channel name) in the front panel display in a continuous manner or by the first 14 alphanumeric characters after scrolling all characters once when "USB" is selected as the input source.

Choices: **CONT**, ONCE

- Select "CONT" to display the operation status in the front panel display in a continuous manner.
- Select "ONCE" to display the operation status in the front panel display by the first 14 alphanumeric characters after scrolling all characters once.

OSD shift OSD_SHIFT

Use this feature to adjust the vertical position of the OSD. Control range: -5 (upward) to +5 (downward)

Control step: 1

Initial setting: 0

- Press Ⓔ◀ to raise the position of the OSD.
- Press Ⓔ▶ to lower the position of the OSD.

Source feature OSD display time

OSD-SOURCE

Use this feature to set the amount of time to display the USB file list and the play information in the OSD after you perform a certain operation.

Choices: ON, 10s, **30s**

- Select "ON" to display the OSD continuously during an operation.
- Select "10s" to turn off the OSD 10 seconds after you perform a certain operation.
- Select "30s" to turn off the OSD 30 seconds after you perform a certain operation.

Amplifier function OSD display time

OSD-AMP

Use this feature to set the amount of time to display the status and sound field parameters information screen after you perform a certain operation.

Choices: ON, 10s, **30s**

- Select "ON" to display the OSD constantly during an operation.
- Select "10s" to turn off the OSD 10 seconds after you perform a certain operation.
- Select "30s" to turn off the OSD 30 seconds after you perform a certain operation.

■ Memory guard B)MEMORY GUARD

Use this feature to prevent accidental changes to DSP program parameter values and other system settings.

Choices: **OFF**, **ON**

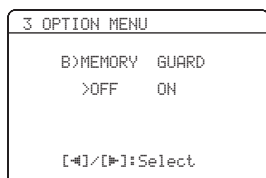

- Select “OFF” to turn off the “MEMORY GUARD” feature.
- Select “ON” to protect:
 - sound field program parameters
 - all “SET MENU” items
 - all speaker levels
 - SCENE template parameters

Note

When “MEMORY GUARD” is set to “ON”, you cannot select and adjust any other “SET MENU” items.

■ Audio select C)AUDIO SELECT

Use this feature to designate the default audio input jack select setting for the input sources when you turn on the power of this unit.

Choices: **AUTO**, **LAST**

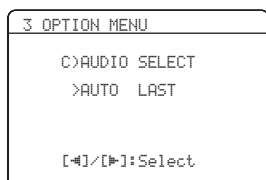

- Select “AUTO” if you want this unit to automatically detect the type of input signals and select the appropriate input mode.
- Select “LAST” if you want this unit to automatically select the last input mode used for the connected input source (see page 33).

■ Parameter initialization D)PARAM. INI

Use this feature to set all the parameters of the sound field programs to the initial factory settings.

Choices: **NO**, **YES**

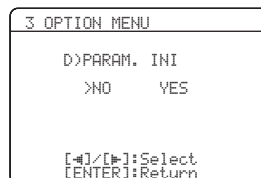

- Select “NO” to cancel the parameter initialization and return to the previous menu screen.
- Select “YES” and then press **Ⓢ ENTER** to set all the sound field parameters to the initial factory settings.

Notes

- You cannot automatically revert to the previous parameter settings once you initialize the sound field program parameters.
- You cannot separately initialize individual sound field programs.
- You cannot initialize any sound field program groups when “MEMORY GUARD” is set to “ON”.

■ USB playback styles E)USB PLAY STYLE

Use this feature to adjust the playback style according to your preference. You can shuffle files in a random order or repeat one specific file or a sequence of files.



Repeat REPEAT

Use this feature to set this unit to repeat one file or a sequence of files.

Choices: **OFF**, **SINGLE**, **ALL**

- Select “OFF” to deactivate this feature.
- Select “SINGLE” to set this unit to repeat one file.
- Select “ALL” to set this unit to repeat a sequence of files.

Shuffle SHUFFLE

Use this feature to set this unit to play files or folders in a random order.

Choices: **OFF**, **ON**

- Select “OFF” to deactivate this feature.
- Select “ON” to set this unit to play files or folders in a random order.

Remote control features

In addition to controlling this unit, the remote control can also operate other audiovisual components made by Yamaha and other manufacturers. To control your TV or other components, you must set up the appropriate remote control code for each input source (see page 59).

Using remote control on the SCENE feature

■ Controlling the input source components in the SCENE mode

You can operate both this unit and the input source component by using the remote control. You must set the appropriate remote control code for each input source in advance (see page 59).

1 Press the desired **SCENE** button on the remote control.

2 Press the desired buttons in the * area below to control the input source component of the selected SCENE template.

■ Setting input source of the customized SCENE template on the remote control

If you customize the input source of the selected SCENE template, you must set the input source of the SCENE template on the remote control to operate the input source component correctly.

Press and hold the **SCENE button and the desired input selector button (**Ⓢ**) for 3 seconds.**



Press the **SCENE** button again to operate the input source component.

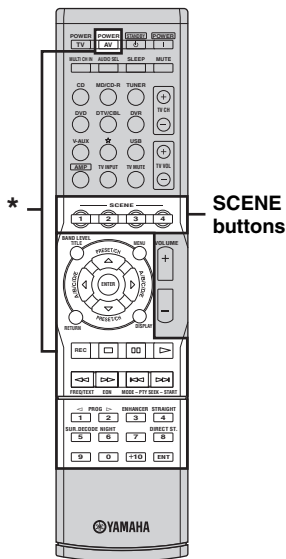

Note

* These buttons control the input source component. See page 58 for details of the function of each button.

Controlling this unit, a TV, or other components

■ Controlling this unit

Press **AMP** to control this unit.

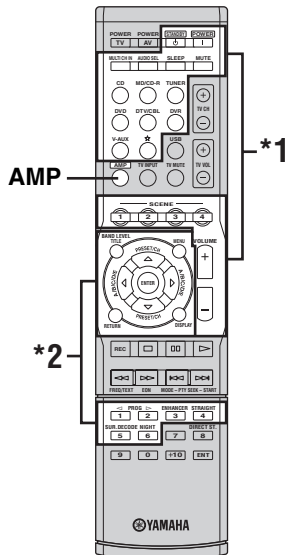

■ Controlling a TV

Press **DTV/CBL** to control your TV. To control your TV, you must set the appropriate remote control code for DTV/CBL (see page 59).

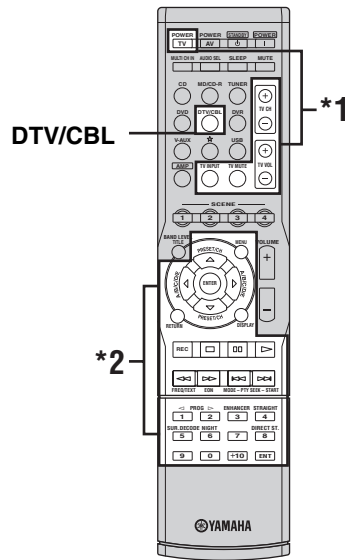

Notes

- *1 These buttons always control this unit regardless of the operation mode selector position.
- *2 These buttons control this unit only when **AMP** is pressed.

Notes

- *1 These buttons always control your TV regardless of whether you press **DTV/CBL** or not.

Remote control	Digital TV/Cable TV
TV POWER	Turns on or off the power.
TV CH +/-	Changes the channel number.
TV VOL +/-	Increases or decreases the volume level.
TV MUTE	Mutes the audio output.
TV INPUT	Changes the input source.

- *2 These buttons control your TV only when the operation mode selector is set to TV. For details, see the “Digital TV/Cable TV” column on page 58.

■ Controlling other components

Press one of the input selector buttons (C) or ☆ to control other components. You must set the appropriate remote control code for each input source in advance (see page 59). The following table shows the function of each control button used to control other components assigned to each input selector button. Be advised that some buttons may not correctly operate the selected component.



The remote control has 10 modes (input areas) to control components so that the remote control can operate up to 10 different components.

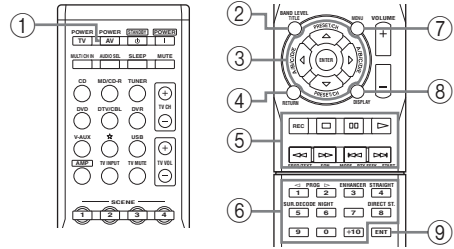

Remote control	DVD player/recorder	VCR	Digital TV/Cable TV	LD player	CD player	MD/CD recorder	Tuner	USB
① AV POWER	Power *1	Power *1	Power *2	Power *1	Power *1	Power *1		
② TITLE	Title						Band	
③ PRESET/CH Δ	Up	VCR channel up	Up				Preset up (1-8)	Up
PRESET/CH ∇	Down	VCR channel down	Down				Preset down (1-8)	Down
A/B/C/D/E <	Left		Left				Preset down (A-E)	Previous menu
A/B/C/D/E >	Right		Right				Preset up (A-E)	Subsequent menu
ENTER	Enter		Enter					Subsequent menu
④ RETURN	Return		Return					Previous menu
⑤ REC/DISC SKIP	Disc skip (player) Rec (recorder)	Rec	Rec *2		Disc skip	Rec		
▷	Play	Play	Play *2	Play	Play	Play		Play
◀◀	Search backward	Search backward	Search backward *2	Search backward	Search backward	Search backward		
▶▶	Search forward	Search forward	Search forward *2	Search forward	Search forward	Search forward		
⏸	Pause	Pause	Pause *2	Pause	Pause	Pause		
◀◀◀	Skip backward	Skip backward	Skip backward *2	Skip backward	Skip backward	Skip backward		Skip backward
▶▶▶	Skip forward	Skip forward	Skip forward *2	Skip forward	Skip forward	Skip forward		Skip forward
◻	Stop	Stop	Stop *2	Stop	Stop	Stop		Stop
⑥ 1-9, 0, +10	Numeric buttons	Numeric buttons	Numeric buttons	Numeric buttons	Numeric buttons	Numeric buttons	Preset stations (1-8)	
⑦ MENU	Menu		Menu					
⑧ DISPLAY	Display	Display	Display	Display	Display	Display		Display
⑨ ENT	Title/Index	Enter	Enter	Chapter/Time	Index	Index		

Notes

*1 This button is operational only when the original remote control supplied with the component has a POWER button.

*2 These buttons operate your DVD recorder only when you set the appropriate remote control code for DVR (see page 59).

Setting remote control codes

You can control other components by setting the appropriate remote control codes. For a complete list of available remote control codes, refer to “List of remote control codes” at the end of this manual.

Remote control code default settings

Input source	Component category	Manufacturer	Default code
CD	CD	YAMAHA	5013
MD/CD-R	CD-R	YAMAHA	5001
DVD	DVD	YAMAHA	2000
DTV/CBL	–	–	–
TUNER	TUNER	YAMAHA	5007
V-AUX	–	–	–
USB	USB	YAMAHA	5012
DVR	DVR	YAMAHA	2011
☆	–	–	–

Note

You may not be able to operate your Yamaha component even if a Yamaha remote control code is preset as listed above. In this case, try setting another Yamaha remote control code.

- 1 While pressing and holding one of the input selector buttons (C) on the remote control to select the input area you want to set up, press **AV POWER** for more than 3 seconds.

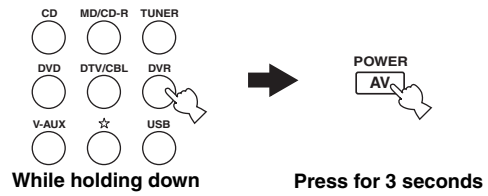

- 2 Press the numeric buttons (0 to 9) (W) to enter the four-digit remote control code for the component to be used.

Notes

- If the manufacturer of your component has more than one code, try each of them until you find the correct one.
- If you do not press any buttons within 30 seconds in step 2, the setup process is canceled. If this happens, repeat the setup procedure.

Advanced setup

This unit has additional menus that are displayed in the front panel display. The advanced setup menu offers additional operations to adjust and customize the way this unit operates. Change the initial settings (indicated in bold under each parameter) to reflect the needs of your listening environment.

Notes

- Only ① **STANDBY/ON** and ⑫ **STRAIGHT** are effective while you are using the advanced setup menu.
- No other operations can be made while you are using the advanced setup menu.
- The advanced setup menu is only available in the front panel display.

1 Press ① **STANDBY/ON on the front panel to set this unit to the standby mode.**

2 Press and hold ⑩ **TONE CONTROL and then press ① **STANDBY/ON** to turn on this unit.**

This unit turns on, and the advanced setup menu appears in the front panel display.

3 Press ⑫ **STRAIGHT repeatedly to change the selected parameter setting.**

4 Press ① **STANDBY/ON to confirm your selection and set this unit to the standby mode.**



The settings you made are reflected next time you turn on this unit.

■ **Speaker impedance** SP IMP.

Use this feature to set the speaker impedance of this unit so that it matches that of your speakers.

Choices: **8Ω MIN**, 6Ω MIN

- Select “8Ω MIN” to set the speaker impedance to 8 Ω .
- Select “6Ω MIN” to set the speaker impedance to 6 Ω .

SP IMP.	Speaker	Impedance level
8Ω MIN	Front (A or B)	The impedance of each speaker must be 8 Ω or higher.
	Center	
	Surround	
6Ω MIN	Front (A or B)	The impedance of each speaker must be 6 Ω or higher.
	Center	
	Surround	

■ **Factory presets** PRESET

Use this feature to reset all the parameters of this unit to the initial factory settings (see page 67).

Choices: **CANCEL**, **RESET**

- Select “CANCEL” not to reset any parameters of this unit.
- Select “RESET” to reset the parameters of this unit.

Notes

- This setting completely resets all the parameters of this unit including the “SET MENU” parameters. However, the advanced setup menu parameters will not be initialized.
- The initial factory settings are activated next time you turn on this unit.

Troubleshooting

Refer to the table below when this unit does not function properly. If the problem you are experiencing is not listed below or if the instruction below does not help, turn off this unit, disconnect the power cable, and contact the nearest authorized Yamaha dealer or service center.

■ General

Problem	Cause	Remedy	See page
This unit fails to turn on or enters the standby mode soon after the power is turned on.	The power cable is not connected or the plug is not completely inserted.	Connect the power cable firmly.	—
	The speaker impedance setting is incorrect.	Set the speaker impedance to match your speakers.	13
	The protection circuitry has been activated.	Make sure that all speaker wire connections on this unit and on all speakers are secure and that the wire for each connection does not touch anything other than its respective connection.	12
	This unit has been exposed to a strong external electric shock (such as lightning or strong static electricity).	Set this unit to the standby mode, disconnect the power cable, plug it back in after 30 seconds and then use it normally.	—
No sound	Incorrect input or output cable connections.	Connect the cables properly. If the problem persists, the cables may be defective.	14-20
	No appropriate Audio input jack select has been set.	Set an appropriate Audio input jack select.	33
	No appropriate input source has been selected.	Select an appropriate input source with ④ INPUT </> on the front panel (or the input selector buttons (Ⓞ) on the remote control).	32, 33
	Speaker connections are not secure.	Secure the connections.	12
	The front speakers to be used have not been selected properly.	Select the front speakers with ⑨ SPEAKERS on the front panel.	33
	The volume is turned down.	Turn up the volume.	—
	The sound is muted.	Press Ⓞ MUTE or Ⓢ VOLUME +/- on the remote control to resume audio output and then adjust the volume.	36
	Signals this unit cannot reproduce are being input from a source component, such as a CD-ROM.	Play a source whose signals can be reproduced by this unit.	—
	Audio signals input at the HDMI jack are not output from any speaker terminals.	Make an analog or digital connection beside the HDMI connection.	—
	The setting of the connected component is improper.	Make an appropriate setting following the instruction manual of the connected component.	—

Problem	Cause	Remedy	See page
The sound suddenly goes off.	The protection circuitry has been activated because of a short circuit, etc.	Check that the impedance setting is correct.	13
		Check that the speaker wires are not touching each other and then turn this unit back on.	—
	The sleep timer has turned off this unit.	Turn on this unit, and play the source again.	—
	The sound is muted.	Press MUTE or VOLUME +/- on the remote control to resume audio output.	36
Sound is heard from the speaker on one side only.	Incorrect cable connections.	Connect the cables properly. If the problem persists, the cables may be defective.	14-20
	Incorrect settings in "SP LEVEL".	Adjust the "SP LEVEL" settings.	34
Only the center speaker outputs substantial sound.	When playing a monaural source with a CINEMA DSP program, the source signal is directed to the center channel, and the front and surround speakers output effect sounds.	This is not malfunction.	—
No sound is heard from the center speaker.	"CENTER" in "SET MENU" is set to "NONE".	Set "CENTER" to "SML" or "LRG".	48
	One of the HiFi DSP programs (except for 5ch Stereo) has been selected.	Try another sound field program.	37
No sound is heard from the surround speakers.	"SUR. L/R SP" in "SPEAKER SET" is set to "NONE".	Set "SUR. L/R SP" to "SML" or "LRG".	49
	This unit is in the "STRAIGHT" mode and a monaural source is being played back.	Press STRAIGHT on the front panel so that "STRAIGHT" disappears from the front panel display.	38
No sound is heard from the subwoofer.	"LFE/BASS OUT" in "SPEAKER SET" is set to "FRONT" when a Dolby Digital or DTS signal is being played.	Set "LFE/BASS OUT" to "SWFR" or "BOTH".	49
	"LFE/BASS OUT" in "SPEAKER SET" is set to "SWFR" or "FRONT" when a 2-channel source is being played.	Set "LFE/BASS OUT" to "SWFR" or "BOTH".	49
	The source does not contain low-frequency bass signals.	This is not malfunction.	—

Problem	Cause	Remedy	See page
Dolby Digital or DTS sources cannot be played. (Dolby Digital or DTS indicator in the front panel display does not light up.)	The connected component is not set to output Dolby Digital or DTS digital signals.	Make an appropriate setting following the operating instructions for your component.	—
	Audio input jack select is set to “ANALOG”.	Set Audio input jack select to “AUTO”.	33
A humming sound is heard.	Incorrect cable connections.	Connect the audio cables firmly. If the problem persists, the cables may be defective.	—
The volume level cannot be increased, or the sound is distorted.	You are attempting to set the volume level higher than the maximum volume level.	Adjust “MAX VOL.” setting.	52
	The component connected to the AUDIO OUT (REC) jacks of this unit is turned off.	Turn on the power of the component.	—
The sound effect cannot be recorded.	It is not possible to record the sound effect with a recording component.	This is not malfunction.	—
A source cannot be recorded by an analog component connected to the AUDIO OUT (REC) jacks.	The source component is not connected to the analog AUDIO IN jacks of this unit.	Connect the source component to the analog AUDIO IN jacks.	16, 19
The sound field parameters and some other settings of this unit cannot be changed.	“MEMORY GUARD” in “OPTION MENU” is set to “ON”.	Set “MEMORY GUARD” to “OFF”.	55
This unit does not operate properly.	The internal microcomputer has been frozen by an external electric shock (such as lightning or excessive static electricity) or by a power supply with low voltage.	Disconnect the power cable from the AC wall outlet and then plug it in again after about 30 seconds.	—
“CHECK SP WIRES” appears in the front panel display.	Speaker cables are short-circuited.	Make sure all speaker cables are connected correctly.	12
There is noise interference from digital or radio frequency equipment.	This unit is too close to the digital or high-frequency equipment.	Move this unit further away from such equipment.	—
The picture is disturbed.	The video source uses scrambled or encoded signals to prevent dubbing.	This is not malfunction.	—
This unit suddenly enters the standby mode.	The internal temperature is too high and the overheat protection circuitry has been activated.	Wait about 1 hour for this unit to cool down and then turn it back on.	—

■ Tuner

	Problem	Cause	Remedy	See page
FM	FM stereo reception is noisy.	The characteristics of FM stereo broadcasts may cause this problem when the transmitter is too far away or the antenna input is poor.	Check the antenna connections.	20
			Try using a high-quality directional FM antenna.	—
			Use the manual tuning method.	40
	There is distortion, and clear reception cannot be obtained even with a good FM antenna.	There is multi-path interference.	Adjust the antenna position to eliminate multi-path interference.	—
FM	The desired station cannot be tuned into with the automatic tuning method.	The signal is too weak.	Use a high-quality directional FM antenna.	—
			Use the manual tuning method.	40
	Previously preset stations can no longer be tuned into.	This unit has been disconnected for a long period.	Set preset stations.	41
AM	The desired station cannot be tuned into with the automatic tuning method.	The signal is weak or the antenna connections are loose.	Tighten the AM loop antenna connections and orient it for the best reception.	—
			Use the manual tuning method.	40
	There are continuous crackling and hissing noises.	Noise can result from lightning, fluorescent lamps, motors, thermostats and other electrical equipment.	Use an outdoor antenna and a ground wire. This will help somewhat, but it is difficult to eliminate all noise.	—
	There are buzzing and whining noises.	A TV set is being used nearby.	Move this unit away from the TV set.	—

■ AUTO SETUP

Before AUTO SETUP

Error message	Cause	Remedy	See page
Connect MIC!	Optimizer microphone is not connected.	Connect the supplied optimizer microphone to the OPTIMIZER MIC jack on the front panel.	24
Unplug HP!	Headphones are connected.	Unplug the headphones.	—

During AUTO SETUP

Error message	Cause	Remedy	See page
E-1:NO FRONT SP	Front L/R channel signals are not detected.	Check the front L/R speaker connections.	12
E-2:NO SUR.SP	A surround channel signal is not detected.	Check the surround speaker connections.	12
E-3:NOISY	Background noise is too loud.	Try running "AUTO SETUP" in a quiet environment.	—
		Turn off noisy electric equipment like air conditioners or move them away from the optimizer microphone.	—
E-4:NO MIC	The optimizer microphone was unplugged during the "AUTO SETUP" procedure.	Connect the supplied optimizer microphone to OPTIMIZER MIC jack on the front panel.	24
E-5:USER CANCEL	The "AUTO SETUP" procedure was cancelled due to user activity.	Run "AUTO SETUP" again.	24
E-6:INTERNAL ERROR	An internal error occurred.	Run "AUTO SETUP" again.	24

After AUTO SETUP

Warning message	Cause	Remedy	See page
W-1:OUT OF PHASE	Speaker polarity is not correct. This message may appear depending on the speakers even when the speakers are connected correctly.	Check the speaker connections for proper polarity (+ or -).	12
W-2:OVER 24m (80ft)	The distance between the nearest speaker and the furthest speaker is out of adjustable range.	Bring the speaker closer to the listening position.	—
W-3:LEVEL ERROR	The difference of volume level among speakers is excessive. (No level correction is made.)	If "SWFR:TOO LOUD" or "SWFR:TOO LOW" appears, adjust the output volume of the subwoofer.	24
		Readjust the speaker installation so that all speakers are set in locations with similar conditions.	—
		Check the speaker connections.	12
		Use speakers of similar quality.	—

Notes

- If the "ERROR" or "WARNING" screens appears, check the cause of the problem, then run "AUTO SETUP" again.
- If a warning message "W-1" appears, corrections are made, but they may not be optimal.
- If a warning message "W-2" or "W-3" appears, no corrections are made.
- If an error message "E-6" occurs repeatedly, please contact a qualified Yamaha service center.

■ USB

Problem	Cause	Remedy	See page
The music files and directories in the USB device cannot be viewed.	The music files and directories are placed in locations other than the FAT area.	Place music files and directories in the FAT area.	—
	You are attempting to browse directory hierarchies of over 8 levels or a directory with more than 500 files.	Modify the data structure on your USB device.	—
The USB device cannot be recognized.	The connected USB device is other than a USB mass storage class USB memory device or USB portable audio player.	This unit can recognize only a USB mass storage class USB memory device (except USB hard disk drives) or USB portable audio player. Also note that it cannot recognize certain USB devices even when they are devices as described above.	43
		Some devices may become easier to recognize when they are inserted before turning this unit on.	21
“Disconnected” is displayed even when a USB device is present.	This unit recognized the USB device as an illegal device.	Turn this unit off then on again.	21

Status message	Cause	Remedy	See page
Disconnected	Your USB memory device or USB portable audio player has been disconnected from the USB port of this unit.	Check the connection between this unit and your USB memory device or USB portable audio player.	—
	There is a problem with the signal path from your USB memory device or USB portable audio player to this unit.	Turn off this unit and reconnect your USB memory device or USB portable audio player to the USB port of this unit.	43
		Try resetting your USB memory device or USB portable audio player.	—
Access error	This unit cannot access your USB memory device or USB portable audio player.	Try another USB memory device or USB portable audio player.	—
	There is a problem with the signal path from your USB memory device or USB portable audio player to this unit.	Turn off this unit and reconnect your USB memory device or USB portable audio player to the USB port of this unit.	43
		Try resetting your USB memory device or USB portable audio player.	—
Unable to play	No varied data is detected.	Try another USB memory device or USB portable audio player.	—

■ Remote control

Problem	Cause	Remedy	See page
The remote control does not work nor function properly.	Wrong distance or angle.	The remote control functions within a maximum range of 6 m (20 ft) and no more than 30 degrees off-axis from the front panel.	23
	Direct sunlight or lighting (from an inverter type of fluorescent lamp, etc.) is striking the remote control sensor of this unit.	Reposition this unit.	—
	The batteries are weak.	Replace all batteries.	3
	The remote control code is not correctly set.	Set the remote control code correctly using “List of remote control codes” at the end of this manual.	59
		Try setting another code for the same manufacturer using “List of remote control codes” at the end of this manual.	59
Even if the remote control code is correctly set, there are some models that do not respond to the remote control.			

■ Resetting the system

Use this feature to reset all the parameters of this unit to the initial factory settings.

1 Press ① STANDBY/ON on the front panel to set this unit to the standby mode.

2 Press and hold ⑩ TONE CONTROL and then press ① STANDBY/ON to turn on this unit.

The advanced setup menu appears in the front panel display.

3 Press ⑫ STRAIGHT repeatedly to select “RESET”.

Select “CANCEL” to cancel the initialization procedure without making any changes.

4 Press ① STANDBY/ON to confirm your selection and set this unit to the standby mode.

Notes

- This procedure completely resets all the parameters of this unit including the “SET MENU” parameters. However, the advanced setup menu parameters will not be initialized.
- The initial factory settings are activated next time you turn on this unit.



To cancel the initialization procedure at any time without making any changes, press ⑫ STRAIGHT repeatedly to select “CANCEL” and then press ① STANDBY/ON.

Glossary

■ Audio information

Dolby Digital

Dolby Digital is a digital surround sound system that gives you completely independent multi-channel audio. With 3 front channels (front L/R and center), and 2 surround stereo channels, Dolby Digital provides 5 full-range audio channels. With an additional channel especially for bass effects, called LFE (Low Frequency Effect), the system has a total of 5.1-channels (LFE is counted as 0.1 channel). By using 2-channel stereo for the surround speakers, more accurate moving sound effects and surround sound environment are possible than with Dolby Surround. The wide dynamic range from maximum to minimum volume reproduced by the 5 full-range channels and the precise sound orientation generated using digital sound processing provide listeners with unprecedented excitement and realism. With this unit, any sound environment from monaural up to a 5.1-channel configuration can be freely selected for your enjoyment.

Dolby Pro Logic II

Dolby Pro Logic II is an improved technique used to decode vast numbers of existing Dolby Surround sources. This new technology enables a discrete 5-channel playback with 2 front left and right channels, 1 center channel, and 2 surround left and right channels instead of only 1 surround channel for conventional Pro Logic technology. There are three modes available: “Music mode” for music sources, “Movie mode” for movie sources and “Game mode” for game sources.

Dolby Surround

Dolby Surround uses a 4-channel analog recording system to reproduce realistic and dynamic sound effects: 2 front left and right channels (stereo), a center channel for dialog (monaural), and a surround channel for special sound effects (monaural). The surround channel reproduces sound within a narrow frequency range. Dolby Surround is widely used with nearly all video tapes and laser discs, and in many TV and cable broadcasts as well. The Dolby Pro Logic decoder built into this unit employs a digital signal processing system that automatically stabilizes the volume on each channel to enhance moving sound effects and directionality.

DTS Digital Surround

DTS digital surround was developed to replace the analog soundtracks of movies with a 5.1-channel digital sound track, and is now rapidly gaining popularity in movie theaters around the world. DTS, Inc. has developed a home theater system so that you can enjoy the depth of sound and natural spatial representation of DTS digital surround in your home. This system produces practically distortion-free 5.1-channel sound (technically, left, right and center channels, 2 surround channels, plus an LFE 0.1 channel as a subwoofer, for a total of 5.1-channels).

LFE 0.1 channel

This channel reproduces low-frequency bass signals. The frequency range of this channel is from 20 Hz to 120 Hz. This channel is counted as 0.1 because it only enforces a low-frequency range compared to the full-range reproduced by the other 5 channels in Dolby Digital or DTS 5.1-channel systems.

PCM (Linear PCM)

Linear PCM is a signal format under which an analog audio signal is digitized, recorded and transmitted without using any compression. This is used as a method of recording CDs and DVD audio. The PCM system uses a technique for sampling the size of the analog signal per very small unit of time. Standing for “Pulse Code Modulation”, the analog signal is encoded as pulses and then modulated for recording.

Sampling frequency and number of quantized bits

When digitizing an analog audio signal, the number of times the signal is sampled per second is called the sampling frequency, while the degree of fineness when converting the sound level into a numeric value is called the number of quantized bits. The range of rates that can be played back is determined based on the sampling rate, while the dynamic range representing the sound level difference is determined by the number of quantized bits. In principle, the higher the sampling frequency, the wider the range of frequencies that can be played back, and the higher the number of quantized bits, the more finely the sound level can be reproduced.

■ Sound field program information

CINEMA DSP

Since the Dolby Surround and DTS systems were originally designed for use in movie theaters, their effect is best felt in a theater having many speakers designed for acoustic effects. Since home conditions, such as room size, wall material, number of speakers, and so on, can differ so widely, it is inevitable that there are differences in the sound heard. Based on a wealth of actually measured data, Yamaha CINEMA DSP uses Yamaha original DSP technology to combine Dolby Pro Logic, Dolby Digital and DTS systems to provide the audiovisual experience of movie theater in the listening room of your own home.

SILENT CINEMA

Yamaha has developed a natural, realistic sound effect DSP algorithm for headphones. Parameters for headphones have been set for each sound field program so that accurate representations of all the sound field programs can be enjoyed on headphones.

Virtual CINEMA DSP

Yamaha has developed a Virtual CINEMA DSP algorithm that allows you to enjoy DSP surround effects even without any surround speakers by using virtual surround speakers. It is even possible to enjoy Virtual CINEMA DSP using a minimal two-speaker system that does not include a center speaker.

■ Video information

Component video signal

With the component video signal system, the video signal is separated into the Y signal for the luminance and the Pb and Pr signals for the chrominance. Color can be reproduced more faithfully with this system because each of these signals is independent. The component signal is also called the “color difference signal” because the luminance signal is subtracted from the color signal. A monitor with component input jacks is required in order to output component signals.

Composite video signal

With the composite video signal system, the video signal is composed of three basic elements of a video picture: color, brightness and synchronization data. A composite video jack on a video component transmits these three elements combined.

S-video signal

With the S-video signal system, the video signal normally transmitted using a pin cable is separated and transmitted as the Y signal for the luminance and the C signal for the chrominance through the S-video cable. Using the S VIDEO jack eliminates video signal transmission loss and allows recording and playback of even more beautiful images.

■ HDMI

HDMI (High-Definition Multimedia Interface) is the first industry-supported, uncompressed, all-digital audio/video interface. Providing an interface between any source (such as a set-top box or AV receiver) and an audio/video monitor (such as a digital television), HDMI supports standard, enhanced or high-definition video as well as multi-channel digital audio using a single cable. HDMI transmits all ATSC HDTV standards and supports 8-channel digital audio, with bandwidth to spare to accommodate future enhancements and requirements. When used in combination with HDCP (High-bandwidth Digital Content Protection), HDMI provides a secure audio/video interface that meets the security requirements of content providers and system operators. For further information on HDMI, visit the HDMI website at “<http://www.hdmi.org/>”.

■ MP3

One of the audio compression methods used by MPEG. It employs the irreversible compression method, which achieves a high compression rate by thinning out the data of hardly audible part to the human ears. It is said to be capable of compressing the data quantity by about 1/11 (128 kbps) while maintaining a similar audio quality to music CD.

■ WAV

Windows standard audio file format, which defines the method of recording the digital data obtained by converting audio signals. It does not specify the compression (coding) method so a desired compression method can be used with it. By default, it is compatible with the PCM method (no compression) and some compression methods including the ADPCM method.

■ WMA

An audio compression method developed by Microsoft Corporation. It employs the irreversible compression method, which achieves a high compression rate by thinning out the data of hardly audible part to the human ears. It is said to be capable of compressing the data quantity by about 1/22 (64 kbps) while maintaining a similar audio quality to music CD.

Specifications

AUDIO SECTION

- Minimum RMS Output Power for Front, Center, Surround
1 kHz, 0.9% THD, 8 Ω 100 W
- Maximum Power for Front, Center, Surround (JEITA)
1kHz, 10% THD, 8 Ω 135 W
- Dynamic Power
(IHF, 8/6/4/2 Ω) 110/130/160/180 W
- Dynamic Headroom
8 Ω 0.41 dB
- Maximum Input Signal
CD, etc. Effect On, 1 kHz, 0.5% THD 2.0 V or more
- Frequency Response
CD, etc. to Front L/R 10 Hz to 100 kHz, -3 dB
- Total Harmonic Distortion
(1 kHz, 50 W, Front L/R, 8 Ω) 0.06% or less
- Signal to Noise Ratio (IHF-A Network)
CD (200 mV) to Front L/R, Effect Off 98 dB or more
CD (250 mV) to Front L/R, Effect Off 100 dB or more
- Residual Noise (IHF-A Network)
Front L/R 150 μV or less
- Channel Separation (1 kHz/10 kHz)
CD, etc. (5.1 kΩ terminated) to Front L/R
..... 60 dB/45 dB or more
- Tone Control (Front L/R)
BASS Boost/Cut ±10 dB/100 Hz
TREBLE Boost/Cut ±10 dB/20 kHz
- Phones Output 400 mV/470 Ω
- Input Sensitivity/Input Impedance
CD, etc. 200 mV/47 kΩ
MULTI CH INPUT 200 mV/47 kΩ
- Output Level/Output Impedance
AUDIO OUT (REC) 200 mV/1.2 kΩ
SUBWOOFER OUTPUT 4 V/1.2 kΩ
- Filter Characteristics (fc=40/60/80/90/100/110/120/160/200 Hz)
H.P.F.
(FRONT SP, CENTER SP, SUR. L/R SP: SMALL/SML)
.....12 dB/oct.
L.P.F. (Subwoofer)24 dB/oct.

VIDEO SECTION

- Video Signal Type (Gray back) NTSC
- Signal Level
Composite 1 V_{p-p}/75 Ω
S-video 1 V_{p-p}/75 Ω (Y), 0.286 V_{p-p}/75 Ω (C)
Component 1 V_{p-p}/75 Ω (Y), 0.7 V_{p-p}/75 Ω (Pb/P_R)
- Signal to Noise Ratio 50 dB or more
- Maximum Input Level 1.5 V_{p-p} or more
- Frequency Response (MONITOR OUT)
Component Signal 5 Hz to 60 MHz, -3 dB

FM SECTION

- Tuning Range 87.5 to 107.9 MHz
- 50 dB Quieting Sensitivity (IHF, 100% mod.)
Mono 2.8 μV (20.2 dBf)
- Signal to Noise Ratio (IHF)
Mono/Stereo 73 dB/70 dB
- Harmonic Distortion (1 kHz)
Mono/Stereo 0.5%/0.5%
- Antenna Input (unbalanced) 75 Ω

AM SECTION

- Tuning Range 530 to 1710 kHz

GENERAL

- Power Supply 120 V AC, 60 Hz
- Power Consumption 240 W/320 VA
- Standby Power Consumption 0.8 W or less
- AC Outlets 2 (Total 100 W maximum)
- Dimensions (W x H x D) 435 x 151 x 318 mm
(17-1/8" x 5-15/16" x 12-1/2")
- Weight 8.1 kg (17 lbs 14 oz)

* Specifications are subject to change without notice.

Index

■ Numerics

1 SOUND MENU, Manual setup	46
2 INPUT MENU, Manual setup	46
2ch Stereo, Sound field program	37
3 OPTION MENU	54
3 OPTION MENU, Manual setup	47
5ch Stereo, Sound field program	37

■ A

A)DISPLAY SET, Option menu	54
A)INPUT ASSIGNMENT, Input menu	52
A)SPEAKER SET, Sound menu	48
A.DELAY, Audio settings	51
AC OUTLETS (SWITCHED)	21
AC OUTLETS, Rear panel	10
AM antenna, Connection	20
AM tuning	40
Amplifier function OSD display time, Display settings	54
Audio components, Connection	19
Audio delay, Audio settings	51
AUDIO jacks	14
Audio jacks	14
AUDIO jacks, Rear panel	10
AUDIO SELECT	33
Audio select, Option menu	55
Audio settings, Sound menu	51
AUTO SETUP	24
AUTO SETUP, Error message	64
AUTO: RESULT display, Auto setup	26
Automatic preset tuning, FM/AM tuning	41
Automatic tuning, FM/AM tuning	40

■ B

B)INPUT RENAME, Input menu	53
B)MEMORY GUARD, Option menu	55
B)SPEAKER LEVEL, Sound menu	50
Background Video, Multi channel input setup	54
BGV, Multi channel input setup	54
BITRATE, Input source information	35

■ C

C)AUDIO SELECT, Option menu	55
C)SP DISTANCE, Sound menu	50
C)VOLUME TRIM, Input menu	53
Cable TV, Connection	16
CD player, Connection	19
CD recorder, Connection	19
CENTER SP, Speaker settings	48
Center speaker equalizer, Sound menu	51
Center speaker, Speaker settings	48

Center width, Sound field parameter	39
CHANNEL, Input source information	35
CINEMA DSP indicator, Front panel display	22
COAXIAL IN (1), Input assignment	52
COAXIAL INPUT assignment, Input assignment	52
COAXIAL INPUT jacks	52
COMPONENT VIDEO jacks	14
COMPONENT VIDEO jacks, Connection	18
COMPONENT VIDEO jacks, Rear panel	10
Connect MIC!, Auto setup error message	64
Connecting to the HDMI	17
Connection, AM antenna	20
Connection, Audio components	19
Connection, Cable TV	16
Connection, CD player	19
Connection, CD recorder	19
Connection, COMPONENT VIDEO jacks	18
Connection, DVD player	16
Connection, DVD recorder	16
Connection, FM antenna	20
Connection, MD recorder	19
Connection, MULTI CH INPUT jacks	19
Connection, Power cable	21
Connection, S VIDEO jacks	18
Connection, Satellite tuner	16
Connection, Speaker	12
Connection, Video components	16
Connection, Video monitor	16
Controlling a TV, Remote control	57
Controlling other components, Remote control	58
Controlling this unit, Remote control	57
Creating original SCENE templates	31
CROSSOVER, Speaker settings	49
Crossover, Speaker settings	49
CT WIDTH, Sound field parameter	39

■ D

D)CENTER GEQ, Sound menu	51
D)DECODER MODE, Input menu	53
D)PARAM. INI, Option menu	55
Decoder mode, Input menu	53
Decoder select mode, Decoder mode	53
Default setting, Remote control code	59
DIGITAL AUDIO COAXIAL jacks	14
DIGITAL AUDIO OPTICAL jacks	14
DIGITAL INPUT jacks, Rear panel	10

DIMENSION, Sound field parameter	39
Dimension, Sound field parameter	39
DIMMER, Display settings	54
Dimmer, Display settings	54
DIRECT STEREO	34
Direct Stereo	34
Display settings, Option menu	54
Display, Input source information	35
DIST	25
DIST, Auto setup result	25
DISTANCE	25
DISTANCE, Auto setup	25
DSP LEVEL, Sound field parameter	39
DSP level, Sound field parameter	39
DTS decoder prioritize setting, Decoder mode	53
DVD player, Connection	16
DVD recorder, Connection	16
Dynamic range, Sound menu	51

■ E

E)LFE LEVEL, Sound menu	51
E)MULTI CH SET, Input menu	54
E-1:NO FRONT SP, Auto setup error message	65
E-2:NO SURR.SP, Auto setup error message	65
E-3:NOISY, Auto setup error message	65
E-4:NO MIC, Auto setup error message	65
E-5:USER CANCEL, Auto setup error message	65
E-6:INTERNAL ERROR, Auto setup error message	65
Effect level, Sound field parameter	39
ENHANCER indicator, Front panel display	22
Exchange, Preset station, FM/AM tuning	42

■ F

F)D. RANGE, Sound menu	51
Factory presets, Advanced setup	60
FL SCROLL, Display settings	54
FLAG, Input source information	35
FM antenna, Connection	20
FM tuning	40
FORMAT, Input source information	35
FRONT B speaker setting, Speaker settings	48
FRONT B, Speaker settings	48
Front panel display	22
Front panel display scroll, Display settings	54
FRONT SP, Speaker settings	48
Front speakers, Speaker settings	48

■ G

G)AUDIO SET, Sound menu	51
Game	37

■ H

Hall	37
HDMI	15
HDMI jack, HDMI cable plug	15
HDMI jacks, Rear panel	10
Headphone, Dynamic range	51
HEADPHONE, Low-frequency effect level	51
Headphone, Low-frequency effect level	51
Headphones indicator, Front panel display	22
Headphones, use	36
HiFi DSP indicator, Front panel display	22
HP, Dynamic range	51

■ I

Infrared window, Remote control	23
INI.VOL., Audio settings	52
Initial volume, Audio settings	52
Input assignment, Input menu	52
Input channel and speaker indicators, Front panel display	22
Input channel indicators, Front panel display	22
Input menu, Manual setup	46
Input rename, Input menu	53
Input source indicators, Front panel display	22
Input source information display	35

■ J

Jazz	37
------------	----

■ L

LFE indicator, Front panel display	22
LFE/BASS OUT, Speaker settings	49
LFE/Bass out, Speaker settings	49
Low-frequency effect level, Sound menu 51	
LVL	25
LVL, Auto setup result	25

■ M

Manual preset tuning, FM/AM tuning	41
MANUAL SETUP, SET MENU	46
Manual setup, SET MENU	46
Manual tuning, FM/AM tuning	40
MAX VOL., Audio settings	52
Maximum volume, Audio settings	52
MD recorder, Connection	19
Memory guard, Option menu	55
Movie Dramatic	37
Movie Spacious	37
MULTI CH INPUT jacks, Connection	19
MULTI CH INPUT jacks, Rear panel	10

Multi channel input setup, Input menu	54
Multi-channel source with headphones	38
Multi-information display, Front panel display	22
Music Enh. 2ch, Sound field program	37
Music Enh. 5ch, Sound field program	37
MUTE indicator, Front panel display	22
MUTE TYPE, Audio settings	51
Muting	36

■ N

NIGHT indicator, Front panel display	22
Night listening mode	35
Number of speakers	25
Number of speakers, Auto setup result	25

■ O

OPTICAL IN (2)	52
OPTICAL IN (2), Input assignment	52
OPTICAL IN (3), Input assignment	52
OPTICAL INPUT assignment, Input assignment	52
OPTIMIZER MIC jack, Auto setup	24
Optimizer microphone	24
Optimizer microphone, Auto setup	24
Optimizing speaker setting	24
Option menu, Manual setup	47
OSD SHIFT, Display settings	54
OSD shift, Display settings	54
OSD-AMP, Display settings	54
OSD-SOURCE, Display settings	54
Other components controlling by remote control	58
Other components controlling, Remote control	58

■ P

PANORAMA, Sound field parameter	39
Panorama, Sound field parameter	39
Parameter initialization, Option menu	55
PCM indicator, Front panel display	22
PHONES jack	36
Play information display, USB controlling	44
Playing video sources in the background	36
PLII Game	38
PLII Movie	38
PLII Music	38
Pop/Rock	37
Power cable, Connection	21
Preset station exchange, FM/AM tuning	42
Preset station selection, FM/AM tuning	42

PRESET, Advanced setup	60
Pro Logic	38
Pure hi-fi stereo sound	34

■ R

Remote control code default setting	59
Remote control code setting	59
Remote control codes	iii
Remote control codes setting	59
Remote control, Troubleshooting	67
Rename, SCENE template	31
Resetting the system	67

■ S

S VIDEO jacks	14
S VIDEO jacks, Connection	18
SAMPLING, Input source information	35
Satellite tuner, Connection	16
SCENE 1	8
SCENE 2	8
SCENE 3	8
SCENE 4	9
SCENE template selection	28
Selection, Audio input jack	33
Selection, Preset station, FM/AM tuning	42
Selection, SCENE template	28
SET MENU	46
Setting remote control code	59
Setting SCENE template input source, Remote control	56
Setting the speaker impedance	13
SIGNAL INFO, SET MENU	35
SILENT CINEMA	38
SILENT CINEMA indicator, Front panel display	22
SIZE	25
SIZE, Auto setup	25
SLEEP indicator, Front panel display	22
Sleep timer	36
Sound field programs with headphones	38
Sound menu, Manual setup	46
Source feature OSD display time, Display settings	54
SP	25
SP A B indicators, Front panel display	22
SP IMP., Advanced setup	60
SP, Auto setup result	25
SP, Dynamic range	51
Speaker distance	25
Speaker distance, Auto setup	25
Speaker distance, Auto setup result	25
Speaker distance, Sound menu	50
Speaker distances, Speaker distance	50
Speaker impedance, Advanced setup	60
Speaker level	25
Speaker level adjustment	34
Speaker level, Auto setup result	25

Speaker level, Sound menu	50	VOLUME level indicator, Front panel display	22
Speaker settings, Sound menu	48	Volume Trim, Input menu	53
Speaker size	25	■ W	
Speaker size, Auto setup	25	W-1:OUT OF PHASE, Auto setup error message	65
Speaker wiring	25	W-2:DISTANCE ERROR, Auto setup error message	65
Speaker wiring, Auto setup	25	W-3:LEVEL ERROR, Auto setup error message	65
Speaker wiring/volume level, Auto setup	25	WIRING/LEVEL	25
Speaker, Connection	12	WIRING/LEVEL, Auto setup	25
Speaker, Dynamic range	51	■ Y	
SPEAKER, Low-frequency effect level	51	Yamaha Parametric Room Acoustic Optimizer	24
Speaker, Low-frequency effect level	51	YPAO	24
SPEAKERS terminals, Rear panel	10	YPAO (Yamaha Parametric Room Acoustic Optimizer)	24
Specifications	70	YPAO indicator, Front panel display	22
STRAIGHT	38	■ Z	
Straight	38	Zone B	33
SUBWOOFER OUTPUT jack, Rear panel	10		
SUBWOOFER PHASE, Speaker settings	49		
Subwoofer phase, Speaker settings	49		
Supplied accessories	3		
SUR. L/R SP, Speaker settings	49		
Surround left/right speakers, Speaker settings	49		
■ T			
Test tone, Center speaker equalizer	51		
TEST, Center speaker equalizer	51		
Tonal quality adjustment	34		
Troubleshooting	61		
Tuner (FM/AM), Troubleshooting	64		
Tuner indicators, Front panel display	22		
Turning off the power	21		
Turning on the power	21		
TV controlling by remote control	57		
TV controlling, Remote control	57		
TV Sports	37		
■ U			
UNIT, Speaker distance	50		
Unit, Speaker distance	50		
Unplug HP!, Auto setup error message	64		
USB memory device using, USB portable audio player using	43		
USB playback operation	43		
USB playback styles	55		
USB, Troubleshooting	66		
■ V			
VIDEO AUX jacks, Front panel	20		
Video components, Connection	16		
VIDEO jacks	14		
Video jacks	14		
VIDEO jacks, Rear panel	10		
Video monitor, Connection	16		
Virtual CINEMA DSP	38		
VIRTUAL indicator, Front panel display	22		

Front panel/Face avant

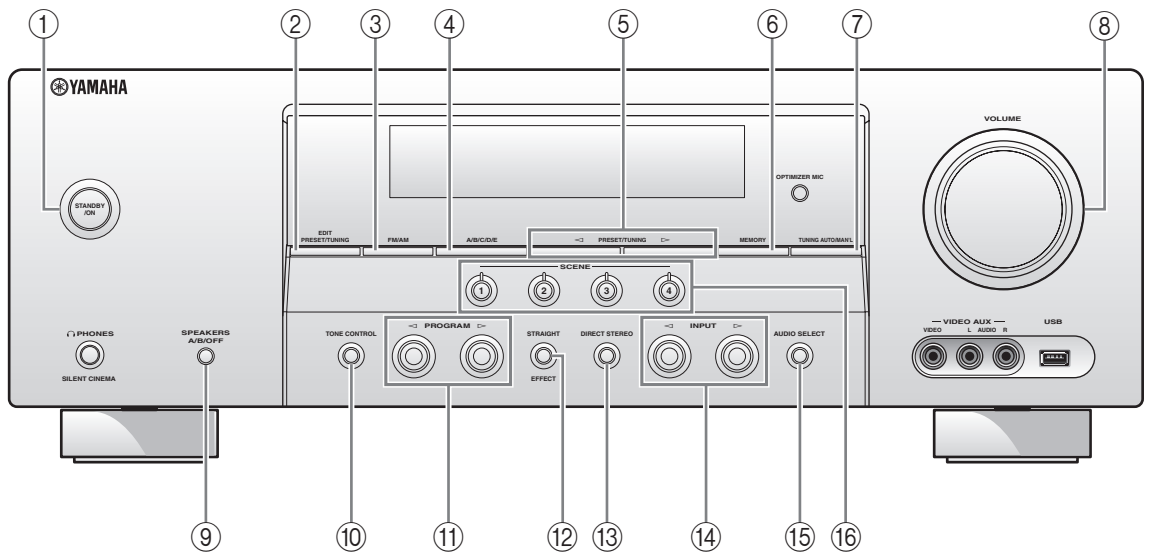

Remote control/Boîtier de télécommande

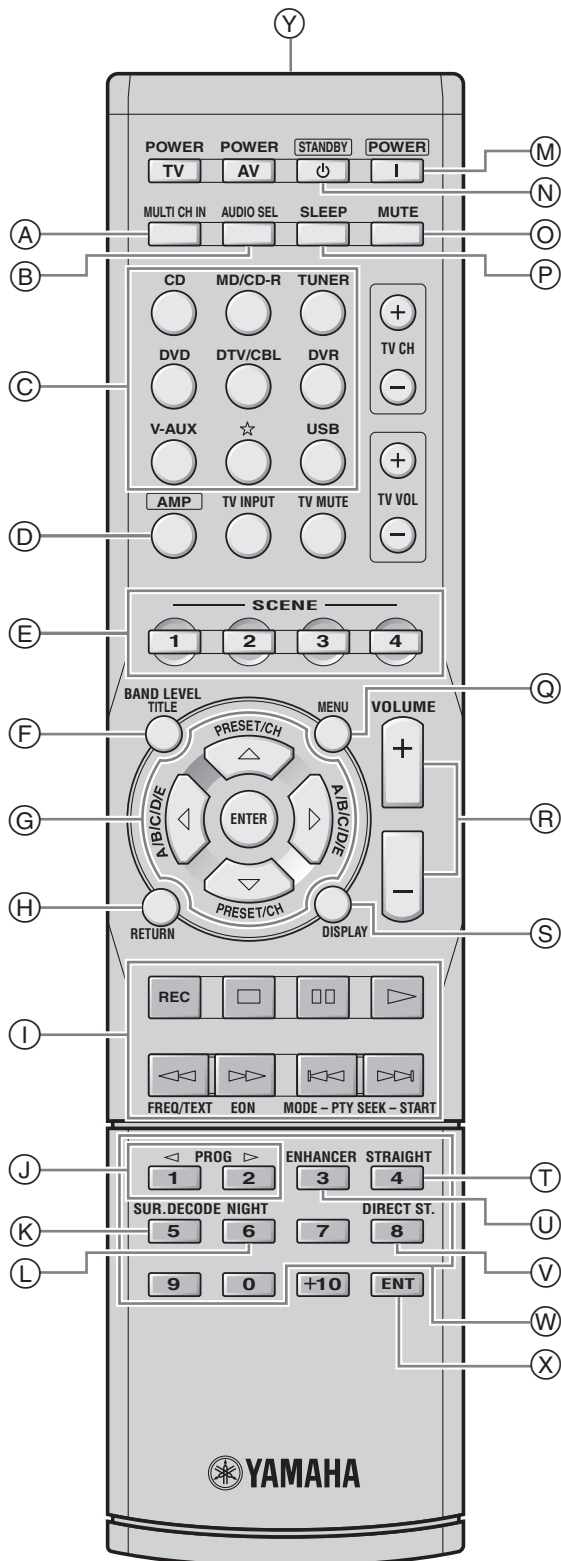

List of remote control codes

Liste des codes de commande

TV		BELL & HOWELL	DANTAX	0217	GEC	0204, 0207, 0211,
ACER	0093	0058, 0064	DAYTRON	0060, 0061, 0208		0213, 0217
ACME	0207	BENQ	DE GRAAF	0210	GELOSO	0208, 0210, 0215
ACURA	0208	BEON	DECCA	0204, 0207, 0213,	GENERAL TECHNIC	0208
ADA	0255	BESTAR		0217		
ADC	0206	BINATONE	DESMET	0213, 0217	GENEXXA	0209, 0211, 0213,
ADMIRAL	0058, 0205, 0206,	BLACK STAR	DIAMOND	0200		0218
	0210, 0211	BLAUPUNKT	DIMENSIA	0057	GIBRALTER	0060
ADYSON	0200, 0207	BLUE SKY	DIXI	0208, 0213, 0217	GOLDHAND	0200
AGASHI	0200	BONDSTEC	DTS	0208	GOLDSTAR	0060, 0061, 0127,
AGAZI	0206	BOOTS	DUAL	0207, 0215, 0216		0128, 0200, 0201,
AGB	0204	BRADFORD	DUAL-TEC	0207, 0208, 0215		0207, 0208, 0210,
AIKO	0127, 0200, 0207,	BRANDT	DUMONT	0060, 0127, 0205,		0213, 0214, 0215,
	0208	BRIONVEGA		0207		0217
AIWA	0028, 0139, 0229,	BRITANNIA	DURABRAND	0126	GOODMANS	0171, 0201, 0204,
	0237	BROCKWOOD	DUX	0217		0206, 0208, 0213,
AKAI	0059, 0065, 0127,	BROKSONIC	DYNATRON	0213, 0217		0217, 0240
	0129, 0130, 0200,	BRUNS	ELBE	0203, 0204, 0212,	GPM	0209, 0218
	0204, 0208, 0209,	BSR		0218	GRAETZ	0211
	0213, 0217, 0218,	BTC	ELBE-SHARP	0204	GRANADA	0204, 0207, 0210,
	0255	BUSH	ELCIT	0204, 0205		0213, 0217
AKIBA	0209, 0218		ELECTRO TECH		GRANDIN	0208, 0209, 0217
AKURA	0206, 0209, 0218			0208	GRUNDIG	0128, 0130, 0222,
ALARON	0200	CANDLE	ELECTROBAND			0236, 0255
ALBA	0200, 0207, 0208,	CAPSONIC		0059	GRUNPY	0062
	0209, 0217, 0218	CASCADE	ELECTROHOME	0059, 0060, 0061	HALIFAX	0200, 0206, 0207
ALBIRAL	0212	CATHAY		0200, 0207, 0213,	HALLMARK	0060, 0061
ALLSTAR	0213	CCE	ELIN	0217	HAMPTON	0200, 0207
AMPLIVISION		CELEBRITY		0217	HANSEATIC	0203, 0207, 0208,
	0207	CENTURION	ELITE	0209, 0213, 0218		0213, 0215, 0217
AMSTRAD	0204, 0206, 0208,	CENTURY	ELMAN	0215	HANTAREX	0204, 0208
	0209, 0218	CGE	ELTA	0200, 0208	HARVARD	0062
AMTRON	0062	CIMLINE	EMERSON	0060, 0061, 0062,	HCM	0206, 0207, 0208,
ANAM	0208	CITIZEN		0064, 0128, 0205		0218
ANAM NATIONAL			ENVISION	0060, 0061	HIFIVOX	0216
	0062	CITY	ERRES	0213, 0217	HIGASHI	0200
ANGLO	0208	CLARIVOX	ESA	0080	HINARI	0208, 0209, 0213,
ANITECH	0206, 0208	CLATRONIC	ETRON	0208		0217, 0218
ANSONIC	0203, 0208		EURO-FEEL	0206	HISAWA	0209, 0218
AOC	0060, 0061		EUROLINE	0217	HITACHI	0006, 0014, 0015,
APEX	0118, 0122, 0132	CMS	EUROMAN	0200		0016, 0042, 0060,
ARC EN CIEL	0216	COLORTYME	EUROMANN	0206, 0207, 0213		0061, 0095, 0105,
ARCAM	0200	CONCERTO	EUROPHON	0200, 0204, 0207,		0127, 0156, 0179,
ARCAM DELTA		CONCORDE		0213, 0215		0180, 0204, 0207,
	0207	CONDOR	FENNER	0208		0210, 0211, 0215,
ARISTONA	0213, 0217	CONTEC	FERGUSON	0212, 0217, 0226		0216, 0251
ASA	0205, 0211	CONTEC/CONY	FIDELITY	0200, 0207, 0210	HORNYPHON	0213
ASBERG	0213		FINLANDIA	0210	HOSHAI	0209, 0218
ASTRA	0208	CONTINENTAL EDISON	FINLUX	0204, 0205, 0207,	HUANYU	0200, 0207
ASUKA	0200, 0206, 0207,			0213, 0215, 0217	HYGASHI	0200, 0207
	0209, 0218	COSMEL	FIRSTLINE	0200, 0207, 0208,	HYPER	0200, 0207, 0208,
ATLANTIC	0200, 0207, 0213,	CRAIG		0213, 0214		0214, 0215
	0217	CROSLEY	FISHER	0064, 0127, 0128,	HYPSON	0206, 0207, 0213,
ATORI	0208	CROWN		0205, 0207, 0215		0217
AUDIOSONIC	0207, 0208, 0209,		FLINT	0213, 0218	ICE	0127, 0200, 0206,
	0213, 0216, 0217,	CS ELECTRONICS	FORMENTI	0200, 0205, 0207,		0207, 0208, 0209,
	0218			0215, 0217		0213, 0218
AUDIOTON	0207		FORMENTI-PHOENIX		ICES	0200, 0218
AUDIOVOX	0062			0200	IMA	0062
AUTOVOX	0205, 0206, 0207	CTC	FORTRESS	0205	IMPERIAL	0211, 0213, 0214,
AWA	0200	CURTIS MATHES	FRONTECH	0206, 0208, 0210,		0215
BAIRD	0216			0211, 0214	INDIANA	0213, 0217
BANG & OLUFSEN			FUJITSU	0023, 0024, 0025,	INFINITY	0063
	0205	CXC		0088, 0127	INGELEN	0211
BASIC LINE	0208, 0209, 0213,	CYBERTRON	FUNAI	0033, 0034, 0035,	INGERSOL	0208
	0218	DAEWOO		0036, 0037, 0062,	INNO HIT	0201, 0204, 0207,
	0207			0206		0208, 0209, 0213,
BASTIDE	0207		FUTURETECH	0062		0217, 0218
BAUR	0217		GATEWAY	0094	INNOVATION	0206, 0208
BEKO	0228	DAINICHI	GBC	0208, 0215, 0218	INTERBUY	0208, 0214
BELCOR	0060	DANSAI	GE	0057, 0060, 0061,	INTERFUNK	0205, 0211, 0213,
				0122, 0147		0214, 0216, 0217

INTERNATIONAL		MANESTH	0206, 0207, 0213, 0217	OSO	0209, 0218	RADIALVA	0218
	0200			OSUME	0218	RADIO SHACK	
INTERVISION	0206, 0207, 0218	MARANTZ	0060, 0061, 0063, 0090, 0213, 0217	OTTO VERSAND			0064
IRRADIO	0201, 0208, 0209, 0213, 0217, 0218	MARELLI	0205		0204, 0207, 0213, 0215, 0216, 0217, 0255	RADIO SHACK/REALISTIC	0057, 0060, 0061, 0062, 0064
ISUKAI	0209, 0218	MARK	0200, 0213, 0217	PAEL	0200, 0207	RADIOLA	0213, 0217
ITC	0207, 0215	MATSUI	0204, 0207, 0208, 0210, 0213, 0217	PALLADIUM	0207	RADIOMARELLI	
ITS	0200, 0209, 0213, 0218	MEDIATOR	0213, 0217	PANAMA	0200, 0206, 0207, 0208		0204, 0205, 0214
ITT	0129, 0208, 0211	MEDION	0206, 0208	PANASONIC	0006, 0007, 0063, 0073, 0074, 0097, 0110, 0114, 0137, 0141, 0151, 0162, 0165, 0186, 0204, 0211, 0244, 0245, 0246, 0254	RADIOTONE	0213
ITV	0208, 0217	MEGATRON	0061			RCA	0057, 0060, 0061, 0091, 0133, 0135, 0147, 0149
JBL	0063	MELECTRONIC					0064
JC PENNEY	0057, 0060, 0061		0200, 0207, 0208, 0211, 0213, 0216, 0217			REALISTIC	0064
JCB	0059	MEMOREX	0058, 0061, 0064, 0208			REVOX	0213, 0217
JENSEN	0060, 0061					REX	0206, 0210, 0211
JVC	0017, 0018, 0019, 0108, 0136, 0153, 0178, 0190, 0213, 0218	MEMPHIS	0208	PATHE CINEMA		RFT	0203, 0205
		METZ	0205		0200, 0203, 0207, 0212, 0215	RHAPSODY	0200
KAISUI	0200, 0207, 0208, 0209, 0218	MGA	0060, 0061			R-LINE	0213, 0217
		MICROMAXX	0206, 0208	PATHE MARCONI		ROADSTAR	0206, 0208, 0209, 0218, 0237
KAMOSONIC	0207	MICROSTAR	0206, 0208		0212, 0216	ROBOTRON	0205
KAMP	0200, 0207	MINERVA	0204	PAUSA	0208	ROWA	0200
KAPSCH	0211	MINOKA	0213	PERDIO	0200	RTF	0205
KARCHER	0207, 0208, 0212, 0217	MITSUBISHI	0006, 0015, 0016, 0048, 0060, 0061, 0104, 0112, 0113, 0125, 0205, 0213	PHILCO	0060, 0061, 0063, 0128, 0205, 0214, 0215	SABA	0204, 0205, 0211, 0216
KAWASHO	0059, 0060, 0061, 0200					SACCS	0212
		MIVAR	0200, 0201, 0202, 0203, 0204, 0207	PHILHARMONIC	0207	SAISHO	0204, 0206, 0207, 0208
KENDO	0128, 0210			PHILIPS	0040, 0060, 0063, 0072, 0115, 0116, 0124, 0130, 0150, 0175, 0184, 0187, 0205, 0207, 0213, 0215, 0217, 0220, 0221, 0232, 0233, 0252, 0253	SALORA	0201, 0204, 0210, 0211, 0215
KENNEDY	0215	MONTGOMERY WARD	0058			SAMBERS	0204
KENWOOD	0060, 0061		0060, 0061, 0128, 0200	PHILIPS MAGNAVOX		SAMPO	0060, 0061, 0083, 0101
KINGSLEY	0200, 0207	MTC			0124	SAMSUNG	0029, 0030, 0031, 0032, 0044, 0045, 0046, 0047, 0060, 0061, 0065, 0068, 0069, 0071, 0079, 0087, 0127, 0128, 0130, 0144, 0160, 0161, 0170, 0176, 0183, 0185, 0200, 0201, 0206, 0207, 0208, 0213, 0217, 0239, 0241, 0242, 0243
KLOSS NOVABEAM	0062	MULTI SYSTEM			0205, 0207, 0210, 0213, 0217, 0255		0200, 0207
KNEISSEL	0203		0217	PHOENIX	0200, 0205, 0213, 0217	SANDRA	
KOLSTER	0213	MULTITECH	0062, 0127, 0128, 0200, 0207, 0208, 0210, 0214, 0215, 0217			SANSUI	0123, 0126, 0213
KONKA	0209, 0218					SANYO	0020, 0021, 0022, 0049, 0060, 0064, 0127, 0128, 0200, 0203, 0207, 0215
KORPEL	0213, 0217	MURPHY	0200, 0207	PHONOLA	0200, 0205, 0213, 0217	SBR	0217
KORTING	0205	NAD	0061			SCHAUB LORENTZ	0211
KOYODA	0208	NAONIS	0210	PILOT	0060	SCHNEIDER	0207, 0209, 0213, 0215, 0216, 0217, 0218
KTV	0062, 0127, 0207	NEC	0026, 0053, 0060, 0061, 0096, 0127	PIONEER	0012, 0013, 0060, 0061, 0098, 0109, 0117, 0128, 0181, 0182, 0194, 0195, 0211, 0213, 0216, 0217, 0250		0061
KYOTO	0200, 0212	NECKERMANN					0060, 0061, 0062
LENCO	0208		0205, 0207, 0210, 0213, 0217, 0255	PLANTRON	0206, 0213	SEARS	0057, 0060, 0061, 0064
LENOIR	0207, 0208	NEI	0213, 0217	POLAROID	0075	SEG	0200, 0206, 0207, 0214, 0215, 0217
LESA	0214	NESCO	0214	POPPY	0208	SEI	0204
LEYCO	0206, 0213, 0217	NET-TV	0082, 0101	PORTLAND	0060, 0061	SEI-SINUDYNE	
LG	0016, 0038, 0039, 0127, 0128, 0157, 0158, 0163, 0164, 0166, 0188, 0189, 0200, 0201, 0207, 0208, 0210, 0213, 0214, 0215, 0217	NEW TECH	0208, 0213	PRANDONI-PRINCE	0204, 0210		0204, 0205, 0211
		NEW WORLD	0209, 0218			SELECO	0210, 0211, 0215
LIESENK	0217	NICAMAGIC	0200, 0207	PRECISION	0207	SENCORA	0208
LIFE	0206, 0208	NIKKAI	0200, 0206, 0207, 0209, 0213, 0217, 0218	PRIMA	0208, 0211	SENTRA	0218
LIFETEC	0206, 0208, 0218			PROFEX	0208	SERINO	0200
LOEWE	0063, 0128, 0203, 0204, 0223, 0227	NOBBLIKO	0200, 0207	PROFI-TRONIC			
LOEWE OPTA	0205, 0213, 0217	NOGAMATIC	0216		0213		
LOGIK	0058	NOKIA	0129, 0211	PROLINE	0213		
LUMA	0210, 0217	NORDMENDE		PROSCAN	0057		
LUMATRON	0210, 0213, 0217		0205, 0211, 0213, 0216	PROSONIC	0200, 0207, 0217		
LUX MAY	0213	NORDVISION	0217	PROTECH	0206, 0207, 0208, 0213, 0214, 0215, 0217		
LUXMAN	0060, 0061	OCEANIC	0211				
LUXOR	0201, 0207, 0210	OLEVIA	0052, 0084	PROTON	0060, 0061		
LXI	0057, 0061, 0063, 0064	ONCEAS	0207	PROVIEW	0050		
MAG	0050	ONWA	0062, 0218	PROVISION	0217		
MAGNADYNE		ORBIT	0213	PULSAR	0060		
	0204, 0205, 0214, 0215, 0217	ORION	0126, 0204, 0208, 0213, 0217, 0235	PYE	0213, 0217		
MAGNAFON	0200, 0204, 0207	ORLINE	0218	PYMI	0208		
MAGNAVOX	0060, 0061, 0063, 0102, 0103, 0150	ORSOWE	0204	QUASAR	0152, 0214		
		OSAKI	0127, 0206, 0207, 0209, 0218	QUELLE	0201, 0206, 0207, 0213, 0214, 0215, 0217		
MAGNUM	0206, 0208	OSIO	0201				
MAJESTIC	0058						
MANDOR	0206						

SHARP	0009, 0010, 0011, 0060, 0061, 0066, 0070, 0087, 0111, 0143, 0145, 0167, 0168, 0169, 0198, 0204, 0224, 0247, 0248, 0249	TEXET	0200, 0207	APEX	0132, 2049	AKIBA	1050				
SHOGUN	0060	THOMSON	0191, 0192, 0207, 0213, 0216, 0226	BROKSONIC	0138, 2060	AKURA	1043, 1050				
SIAREM	0204, 0205, 0215	THORN	0212, 0217	BUSH	0230, 2112	ALBA	1044, 1050				
SICATEL	0212	TMK	0060, 0061	JVC	0136, 2053	AMERICAN HIGH	1004				
SIEMENS	0255	TOKAI	0213	PANASONIC	0137, 2054, 0254, 2110	AMSTRAD	1042				
SIERRA	0213	TOKYO	0200, 0207	RCA	0133, 0135, 2050, 2051	ANITECH	1050				
SIGNATURE	0058	TOSHIBA	0027, 0043, 0053, 0054, 0064, 0078, 0089, 0090, 0106, 0107, 0127, 0131, 0140, 0146, 0159, 0197, 0225, 0231, 0237	SYLVANIA	0134, 2052	ASA	1045, 1046				
SILVA	0200	TOWADA	0211, 0215	THOMSON	0226, 2109	ASHA	1002, 1014				
SINGER	0205, 0214, 0215	TRANSTEC	0200	TOSHIBA	0131, 2048, 0231, 2111	ASUKA	1042, 1045, 1046, 1050				
SINUDYNE	0204, 0205, 0215, 0217	TRIDENT	0204	<hr/>				AUDIO DYNAMICS	1000		
SKANTIC	0211	TRISTAR	0218	TV/DVD/VCR COMBO				AUDIOVOX	1003		
SOLAVOX	0211	TRIUMPH	0204	PANASONIC	0141, 1040, 2057	BAIRD	1042, 1043, 1047				
SONOKO	0206, 0207, 0208, 0213, 0217	UHER	0211, 0213	SAMSUNG	0241, 1070, 2113	BASIC LINE	1044, 1050				
SONOLOR	0211	ULTRAVOX	0200, 0205, 0207, 0214, 0215	SHARP	0143, 1028, 2059	BAUR	1046				
SONTEC	0213, 0217	UNITED	0217	SYLVANIA	0142, 1041, 2058	BEAUMARK	1002, 1014				
SONY	0041, 0059, 0067, 0085, 0086, 0174, 0196, 0199, 0208, 0219, 0234	UNIVERSUM	0127, 0128, 0129, 0201, 0206, 0213, 0214, 0215, 0217	TOSHIBA	0140, 1029, 2056	BELL & HOWELL	1001				
SOUND & VISION	0209, 0218	UNIVOX	0212	<hr/>				BLAUPUNKT	1046, 1048		
SOUNDESIGN	0060, 0061, 0062	VESTEL	0210, 0211, 0213, 0214, 0215, 0217	TV/VCR COMBO				BROKSONIC	1012, 1013		
SOUNDWAVE	0213, 0217	VEXA	0208, 0217	AIWA	0237, 1066	BUSH	1044, 1050, 1066				
SSS	0060, 0062	VICTOR	0213	BUSH	0237, 1066	CALIX	1003				
STANDARD	0207, 0208, 0209, 0213, 0218	VIDEOLOGIC	0200	DAEWOO	0155, 0238, 1038, 1067	CANDLE	1002, 1003				
STARLIGHT	0217	VIDEOLOGIQUE	0200, 0207, 0209, 0218	GE	0147, 1030	CANON	1004				
STARLITE	0062	VIDEOSAT	0214	GOODMANS	0240, 1069	CCE	1006				
STENWAY	0218	VIDEOSYSTEM	0213	GRUNDIG	0236, 1062	CGE	1042, 1043				
STERN	0210, 0211	VIDEOTECHNIC	0200	HITACHI	0156, 1039	CIMLINE	1044, 1050				
SUNKAI	0208, 0218	VIDTECH	0060, 0061	JVC	0153, 1036	CITIZEN	1002, 1003				
SUNWOOD	0208, 0213	VIEWSONIC	0076, 0077, 0092, 0099, 0172, 0173	MAGNAVOX	0150, 1033	COLORTYME	1000				
SUPERLA	0200, 0204, 0207	VISIOLA	0200, 0207	ORION	0235, 1065	COLT	1006				
SUPERTECH	0200	VISION	0213	PANASONIC	0151, 1034	CRAIG	1002, 1003, 1006, 1014				
SUPRA	0208	VORTEC	0213, 0217	PHILIPS	0150, 0232, 0233, 1033, 1062, 1063	CROWN	1050				
SUPREME	0059	VOXSON	0205, 0210, 0211, 0213	QUASAR	0152, 1035	CURTIS MATHES	1000, 1002, 1004, 1009				
SUSUMU	0209	WALTHAM	0207, 0212	RCA	0149, 1032	CYBERNEX	1002, 1014				
SUTRON	0208	WARDS	0057, 0058, 0060, 0061, 0063	ROADSTAR	0237, 1066	DAEWOO	1005, 1038, 1061, 1067				
SYDNEY	0200, 0207	WATSON	0213, 0217, 0218	SAMSUNG	0144, 0239, 1027, 1068	DANSAI	1050				
SYLVANIA	0060, 0061, 0063, 0080, 0134, 0142, 0148	WATT RADIO	0200, 0207, 0212, 0215	SHARP	0145, 1028	DANTAX	1044				
SYMPHONIC	0062, 0080	WEGA	0205	SONY	0234, 1064	DBX	1000				
SYSLINE	0217	WELTBlick	0213, 0217	SYLVANIA	0148, 1031	DE GRAAF	1046, 1049				
SYTONG	0200	WESTON	0215	TATUNG	0237, 1066	DECCA	1042, 1043, 1046				
TANDY	0127, 0207, 0209, 0211, 0218	WHITE WESTINGHOUSE	0008, 0200, 0207, 0217	TOSHIBA	0146, 0237, 1029, 1066	DENON	1010				
TASHIKO	0200, 0207, 0210	WINCOM	0055, 0056	ZENITH	0154, 1037	DIMENSIA	1009				
TATUNG	0127, 0204, 0207, 0213, 0217, 0237	YAMAHA	0000, 0001, 0002, 0003, 0005, 0060, 0061	<hr/>				DUAL	1043, 1046		
TCM	0206, 0208	YAMISHI	0218	DVD/VCR COMBO				DUMONT	1042, 1046, 1047, 1049		
TEAC	0127	YOKO	0200, 0206, 0207, 0208, 0209, 0213, 0217, 0218	JVC	1017, 1017, 2045, 2045	DYNATECH	1005				
TEC	0207, 0208, 0214, 0215	YORX	0209, 0218	LG	1071, 2087	ELECTROHOME	1003				
TECHWOOD	0060, 0061	ZANUSSI	0210	PANASONIC	1020, 1072, 2040, 2105	ELECTROPHONIC	1003				
TEKNIKA	0058, 0060, 0061, 0062	ZENITH	0058, 0060, 0100, 0105, 0119, 0121, 0154	PHILIPS	1025, 2046	ELTA	1050				
TELEAVIA	0216	<hr/>				RCA	1022, 2042	EMERSON	1003, 1004, 1005, 1012, 1013		
TELECOR	0218	TV/DVD COMBO				SAMSUNG	1021, 1021, 2041, 2104	ETZUKO	1050		
TELEFUNKEN	0065, 0213, 0216	AIWA	0139, 2055	SHARP	1023, 1073, 2043, 2106	FERGUSON	1043				
TELEGAZI	0218	<hr/>				SONY	1019, 1074, 2039, 2107	FIDELITY	1042		
TELETECH	0208, 0214, 0217	VCR				TOSHIBA	1024, 1075, 2044, 2108	FINLANDIA	1046, 1047, 1049		
TELETON	0207	VCR				ZENITH	1026, 2047	FINLUX	1042, 1043, 1046, 1047, 1049		
TELEVIDEON	0200	VCR				<hr/>				FIRST LINE	1044, 1045, 1049, 1050
TENSAI	0208, 0209, 0213, 0218	VCR				ADMIRAL	1008, 1013	FISHER	1001, 1047		
TESMET	0213	VCR				ADVENTURA	1005	FLINT	1044		
TEVION	0206, 0208	VCR				AIWA	1005, 1042, 1043, 1044, 1066	FORMENTI/PHOENIX	1046		
		VCR				AKAI	1007, 1043	FUJI	1004		
		VCR						FUJITSU	1042		
		VCR						FUNAI	1005, 1042		
		VCR						GALAXY	1042		
		VCR						GARRARD	1005		
		VCR						GBC	1050		

GE	1002, 1004, 1009, 1014, 1030	MARANTZ	1000, 1001, 1004, 1046, 1051	PYE	1046, 1056	TELEFUNKEN	1043
GEC	1046	MARTA	1003	QUARTER	1001	TENOSAL	1050
GELOSO	1050	MATSUI	1044, 1045	QUARTZ	1001, 1047	TENSAI	1042, 1045, 1050
GENERAL TECHNIC	1044, 1048	MATSUSHITA	1004	QUASAR	1004, 1035	TEVION	1044, 1048
GO VIDEO	1014	MEDIATOR	1046	QUELLE	1042, 1046, 1047	THOMSON	1043, 1058
GOLDHAND	1050	MEDION	1044, 1048	RADIO SHACK	1003	THORN	1043, 1047
GOLDSTAR	1000, 1003, 1042, 1045	MEI	1004	RADIO SHACK/REALISTIC	1001, 1002, 1003, 1004, 1005, 1008	TMK	1002, 1014
GOODMANS	1042, 1045, 1050, 1069	MEMOREX	1001, 1002, 1003, 1004, 1005, 1008, 1013, 1014, 1042, 1045, 1047	RADIOLA	1046	TOKAI	1045, 1050
GRADIENTE	1005	MEMPHIS	1050	RADIX	1003	TONSAI	1050
GRAETZ	1043, 1047	METZ	1048	RANDEX	1003	TOSHIBA	1013, 1024, 1029, 1043, 1046, 1066, 1075
GRANADA	1046, 1047, 1049	MGA	1014	RCA	1002, 1004, 1009, 1010, 1014, 1015, 1022, 1032	TOTEVISION	1002, 1003, 1014
GRANDIN	1042, 1045, 1050	MGN TECHNOLOGY	1002, 1014	REALISTIC	1001, 1002, 1003, 1004, 1005, 1008	TOWADA	1050
GRUNDIG	1046, 1050, 1062	MICROMAXX	1044, 1048	REX	1043	TOWIKA	1050
HANSEATIC	1045, 1046	MICROSTAR	1044, 1048	RFT	1046	UHER	1045
HARLEY DAVIDSON	1005	MIGROS	1042	ROADSTAR	1045, 1050, 1066	UNITECH	1002, 1014
HARMAN/KARDON	1000	MINOLTA	1010	SABA	1043	UNIVERSUM	1042, 1045, 1046
HARWOOD	1006	MITSUBISHI	1011, 1042, 1046	SAISHO	1044, 1050	VECTOR RESEARCH	1000
HCM	1050	MONTGOMERY WARD	1008	SALORA	1047	VIDEO CONCEPTS	1000
HEADQUARTER	1001	MOTOROLA	1004, 1008	SAMSUNG	1002, 1014, 1021, 1027, 1052, 1068, 1070	VIDEON	1044, 1048
HINARI	1044, 1050	MTC	1002, 1014	SANKY	1008	VIDEOSONIC	1002, 1014
HISAWA	1044	MULTITECH	1002, 1005, 1006, 1042, 1046, 1050	SANSUI	1007, 1011, 1013, 1043	WARDS	1002, 1003, 1004, 1005, 1006, 1008, 1010, 1014
HITACHI	1007, 1010, 1039, 1042, 1043, 1046, 1049	MURPHY	1042	SANYO	1001, 1002, 1014, 1047	WELTBlick	1045
HUGHES NETWORK SYSTEMS	1010	NATIONAL	1048	SBR	1046	WHITE WESTINGHOUSE	1013
HYPSON	1044, 1050	NEC	1000, 1001, 1007, 1011, 1043, 1051	SCHAUB LORENZ	1042, 1043, 1047	XR-1000	1004, 1005, 1006
IMPERIAL	1042	NECKERMANN	1043, 1046	SCHNEIDER	1042, 1044, 1045, 1046, 1050	YAMAHA	1000, 1001, 1007
INNO HIT	1046, 1050	NEI	1046	SCOTT	1012	YAMISHI	1050
INNOVATION	1044, 1048	NESCO	1050	SEARS	1001, 1003, 1004, 1010	YOKAN	1050
INSTANT REPLAY	1004	NIKKO	1003	SEG	1050	YOKO	1045, 1050
INTERBUY	1045	NOBLEX	1002, 1014	SEI-SINUDYNE	1046	ZENITH	1013, 1026, 1037
INTERFUNK	1046, 1047	NOKIA	1043, 1047	SELECO	1043		
INTERVISION	1042	NORDMENDE	1043	SENTRON	1050		
IRRADIO	1045, 1050	OCEANIC	1042, 1043	SHARP	1008, 1023, 1028, 1053, 1073		
ITT	1043, 1047	OKANO	1044	SHINTOM	1006, 1047, 1050		
ITV	1045	OLYMPUS	1004	SHIVAKI	1045		
JC PENNEY	1000, 1001, 1002, 1003, 1004, 1006	OPTIMUS	1003, 1008	SHOGUN	1002, 1014		
JCL	1004	ORION	1012, 1013, 1044, 1065	SIEMENS	1045, 1047		
JENSEN	1007	ORSON	1042	SIGNATURE 2000	1008		
JVC	1000, 1001, 1007, 1011, 1017, 1036, 1043	OSAKI	1042, 1045, 1050	SILVA	1045		
KAISUI	1050	OTTO VERSAND	1046	SINGER	1004, 1006		
KARCHER	1046	PALLADIUM	1043, 1045, 1050	SINUDYNE	1046		
KENDO	1044	PANASONIC	1004, 1020, 1034, 1040, 1048, 1054, 1072	SONTEC	1045		
KENWOOD	1000, 1001, 1007, 1011, 1043	PATHE MARCONI	1043	SONY	1016, 1019, 1055, 1060, 1064, 1074		
KLH	1006	PENNEY	1010, 1014	STS	1004, 1010		
KODAK	1003, 1004	PENTAX	1010, 1049	SUNKAI	1044		
KORPEL	1050	PERDIO	1042	SUNSTAR	1042		
LEYCO	1050	PHILCO	1004, 1051	SUNTRONIC	1042		
LG	1003, 1042, 1045, 1071	PHILIPS	1004, 1025, 1033, 1046, 1056, 1057, 1059, 1062, 1063	SUNWOOD	1050		
LIFETEC	1044, 1048	PHILIPS MAGNAVOX	1018	SYLVANIA	1004, 1005, 1031, 1041		
LLOYD'S	1005	PHONOLA	1046	SYMPHONIC	1005		
LOEWE	1048	PILOT	1003	TAISHO	1044		
LOEWE OPTA	1045, 1046	PIONEER	1011, 1046	TANDY	1001		
LOGIK	1006, 1050	PRINZ	1042	TASHIKO	1003, 1042		
LUXOR	1047	PROFEX	1050	TATUNG	1007, 1042, 1043, 1046, 1066		
LXI	1003	PROFITRONIC	1014	TEAC	1005, 1007		
M ELECTRONIC	1042	PROLINE	1042	TECHNICS	1004, 1048		
MAGNASONIC	1047	PROSCAN	1009	TEKNIKA	1003, 1004, 1005		
MAGNAVOX	1004, 1018, 1033	PROSONIC	1044	TELEAVIA	1043		
MAGNIN	1003, 1014	PROTEC	1006				
MANESTH	1050						

DVD

ACOUSTIC SOLUTIONS	2078
AIWA	2055, 2100
AKAI	2096
AKURA	2076
ALBA	2078, 2086
APEX	2027, 2049
AWA	2078
AXION	2078
BRAINWAVE	2096
BRANDT	2073, 2085
BROKSONIC	2060
BUSH	2075, 2078, 2112
CENTREX	2077
CLASSIC	2078
CLATRONIC	2075
COBY	2078
C-TECH	2074
CYBERHOME	2025, 2079, 2091
DAEWOO	2092, 2098
DANSAI	2096
DAYTEK	2080, 2089
DEC	2075
DENON	2030, 2102, 2103
DENVER	2075, 2076
DIAMOND	2074
DK DIGITAL	2094
DUAL	2078
D-VISION	2096
DVX	2074
ELTA	2096
EUROLINE	2096
FUNAI	2052, 2058
GLOBAL SOLUTIONS	2074

GLOBAL SPHERE		SANSUI	2074	TOSHIBA	2068	PANASONIC	2015, 2016, 2017, 2120
	2074	SANYO	2095			PHILIPS	2117, 2121, 2123, 2128
GOODMANS	2075, 2077, 2078	SCANMAGIC	2078	DVD/LD COMBO		PIONEER	2012, 2013, 2014
GRUNDIG	2077, 2098	SCIENTIFIC LABS		PIONEER	2036	PROSCAN	2129
H&B	2075		2074	DVD RECORDER		RCA	2116, 2124, 2129, 2133
HAAZ	2074	SCOTT	2088	APEX	2024	REPLAYTV	2118, 2119, 2120
HE	2078	SEG	2074, 2086	JVC	2070	SHARP	2009, 2010
HITACHI	2032, 2072	SHARP	2034, 2043, 2059, 2093, 2106	LG	2071	SONIC BLUE	2119, 2120
HOME ELECTRONICS				PANASONIC	2020, 2065, 2066, 2067	SONY	2005, 2006, 2007, 2122, 2130, 2131, 2132
	2078	SILVA	2076	PHILIPS	2019, 2061, 2062, 2063	STACK 9	2132
INNOVATION	2072	SINGER	2074	PIONEER	2021	SYSTEMAX	2132
IRRADIO	2134	SKYMASTER	2074, 2078	RCA	2018	TAGAR SYSTEMS	2132
JDB	2078	SKYWORTH	2076	SONY	2022, 2064	TIVO	2116, 2121, 2122, 2123, 2130, 2131
JVC	2033, 2045, 2053, 2073, 2099	SM ELECTRONIC		TOSHIBA	2068	TOSHIBA	2004, 2125, 2132
			2074, 2078	YAMAHA	2023	TOUCH	2132
KENWOOD	2030, 2097	SONY	2028, 2029, 2039, 2083, 2107	YUKAI	2069	ULTIMATETV	2133
KINGAVON	2075	SOUNDMASTER				VIEWSONIC	2132
KODA	2075		2074	DVR		VOODOO	2132
LAWSON	2074	SOUNDMAX	2074	ABS	2132	YAMAHA	2011
LENCO	2075	STANDARD	2074	ALIENWARE	2132	ZT GROUP	2132
LG	2084, 2087	STAR CLUSTER		CYBERPOWER			
LIFETEC	2072		2074		2132	LD PLAYER	
LIMIT	2074	STARMEDIA	2075	DELL	2132	YAMAHA	2002
LOGICLAB	2074	SUPERVISION		DIRECTV	2123, 2128, 2129, 2133		
LUXOR	2077		2074, 2078	DISH NETWORK			
MAGNAVOX	2037, 2073, 2075	SYLVANIA	2052, 2058		2126, 2127	CD PLAYER	
MAGNUM	2072	SYNN	2074	ECHOSTAR	2126, 2127	YAMAHA	5000, 5013
MBO	2078	TCM	2072	EXPRESSVU	2126		
MEDION	2072	TEAC	2074	GATEWAY	2132	CD RECORDER	
MICROMAXX		TEC	2076	GOI	2126	YAMAHA	5001
	2072	TECHNICS	2030	HEWLETT PACKARD			
MICROMEDIA		TECHNIKA	2096		2132	MD	
	2073	TECHNOSONIC		HITACHI	2008	YAMAHA	5002, 5003, 5004
MICROSTAR	2072		2096	HOWARD COMPUTERS			
MITSUBISHI	2035	TEVION	2072, 2074		2132	TAPE DECK	
MIZUDA	2075	THOMSON	2085, 2109	HTS	2126	YAMAHA	5005, 5006
MUSTEK	2078	TOKAI	2076	HUGHES	2123, 2128		
NAIKO	2077	TOSHIBA	2026, 2044, 2048, 2056, 2073, 2108, 2111	HUMAX	2123	TUNER	
ONKYO	2073, 2135			HUSH	2132	YAMAHA	5007, 5008, 5009, 5010, 5012, 5014
ORAVA	2075	UNITED	2078	IBUYPOWER	2132		
P&B	2075	VOXSON	2078	JVC	2126, 2127		
PACIFIC	2074	WHARFEDALE		LINKSYS	2132		
PANASONIC	2030, 2040, 2054, 2057, 2105, 2110		2074	MEDIA CENTER PC			
PHILIPS	2019, 2026, 2046, 2073, 2081, 2090	XLOGIC	2074		2132		
PIONEER	2036, 2082	YAKUMO	2077	MICROSOFT	2132		
PROLINE	2077	YAMADA	2077	MIND	2132		
PROVISION	2075	YAMAHA	2000, 2001, 2003, 2030, 2101	NIVEUS MEDIA			
RCA	2031, 2042, 2050, 2051	YUKAI	2078		2132		
RED STAR	2076	ZENITH	2038, 2047, 2073	NORTHGATE	2132		
REOC	2074						
ROADSTAR	2075, 2078, 2086	DVD-DVR					
ROWA	2077	PANASONIC	2067				
SABA	2085	PIONEER	2114				
SABAKI	2074	SAMSUNG	2115				
SAMSUNG	2032, 2041, 2104, 2113						



© 2007 YAMAHA CORPORATION All rights reserved.

YAMAHA ELECTRONICS CORPORATION, USA 6660 ORANGETHORPE AVE., BUENA PARK, CALIF. 90620, U.S.A.
 YAMAHA CANADA MUSIC LTD. 135 MILNER AVE., SCARBOROUGH, ONTARIO M1S 3R1, CANADA
 YAMAHA ELECTRONIK EUROPA G.m.b.H. SIEMENSSTR. 22-34, 25462 RELLINGEN BEI HAMBURG, GERMANY
 YAMAHA ELECTRONIQUE FRANCE S.A. RUE AMBROISE CROIZAT BP70 CROISSY-BEAUBOURG 77312 MARNE-LA-VALLEE CEDEX02, FRANCE
 YAMAHA ELECTRONICS (UK) LTD. YAMAHA HOUSE, 200 RICKMANSWORTH ROAD WATFORD, HERTS WD18 7GQ, ENGLAND
 YAMAHA SCANDINAVIA A.B. J A WETTERGRENS GATA 1, BOX 30053, 400 43 VÄSTRA FRÖLUNDA, SWEDEN
 YAMAHA MUSIC AUSTRALIA PTY, LTD. 17-33 MARKET ST., SOUTH MELBOURNE, 3205 VIC., AUSTRALIA

YAMAHA CORPORATION
 Printed in China  WK65610

The circled numbers and alphabets correspond to those in the Owner's Manual.
 Les nombres et lettres dans un cercle correspondent à ceux du mode d'emploi.

■ **Front panel/Face avant**

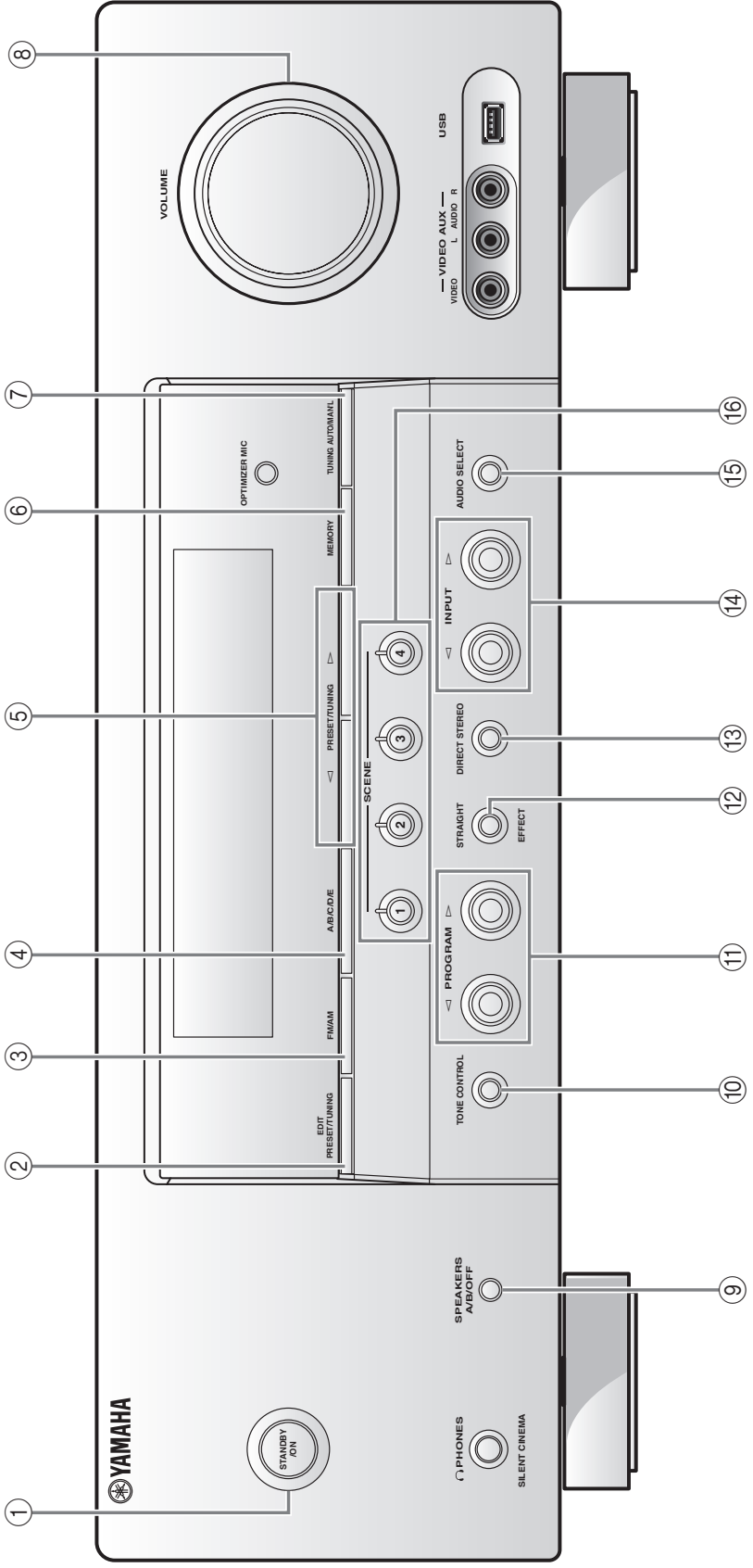

Remote control/Boîtier de télécommande

