



## ALPHA SERIES

---

*Alpha M3 & M8*

*Alpha Em & EF*

*B1-18 & B1-15*

*S2 Sub-bass*

*User Manual*

<b>INTRODUCTION</b>	<b>3</b>
<hr/>	
<b>ALPHA SERIES DESCRIPTION</b>	<b>3</b>
LOUDSPEAKERS	3
NEXO TD CONTROLLERS	4
THE X-BOW FLYING SYSTEM	4
<b>GENERAL SET-UP INSTRUCTIONS</b>	<b>5</b>
SPEAKER WIRING	5
FLYING THE SYSTEM	6
TD CONTROLLERS SETTINGS	9
INITIAL SET-UP PRECAUTIONS	10
<b>ALPHA ARRAYS - SOME BASIC RULES</b>	<b>11</b>
ALPHA S2 PLACEMENT	11
SPL VERSUS FREQUENCY	11
SPL VERSUS DISTANCE	11
DIRECTIVITY - COVERAGE	14
<b>AMPLIFIERS</b>	<b>16</b>
POWER	16
CURRENT RATING	16
AMPLIFIER GAINS	16
GAIN VALUE	17
ADVANCED PROTECTIONS	17
<b>PASSIVE CROSSOVER FUSES</b>	<b>18</b>
<b>TECHNICAL SPECIFICATIONS</b>	<b>19</b>
ALPHA S2	19
ALPHA B1-15 / B1-18	20
ALPHA M3 / M8	21
ALPHA EM / EF	22
DIRECTIVITY TABLES	23
<b>CURVES</b>	<b>24</b>
ALPHA S2	24
ALPHA B1-18	24
ALPHA B1-15	24
ALPHA M3	25
ALPHA M8	28
ALPHA EM	31
ALPHA EF	31
<b>DIMENSIONS</b>	<b>34</b>
<b>TRANSPORT</b>	<b>35</b>
<b>CONNECTION DIAGRAMS</b>	<b>36</b>

## INTRODUCTION

Thank you for selecting NEXO Alpha Series. This manual is intended to provide you with necessary and useful information about your Alpha System:

- S2
- B1-15, B1-18
- M3, M8
- EM, EF

Please devote some attention to reading this manual. A better understanding of some specific features of the Alpha Series will help you to operate your system to its full potential.

This manual is intended to be comprehensive, and we hope that it will satisfy your requirements. Should you require further information, please contact your NEXO agent.

## Alpha Series description

### Loudspeakers

The Alpha range includes the following speakers:

- The S2 Sub-bass is a double 18-inch resonator loaded sub-bass, dedicated to very low frequency reproduction (< 80 Hz).
- The B1-15 & B1-18 are complex loaded (bass-reflex & exponential horn) bass cabinets; the B1-15 houses one 15-inch driver, while the B1-18 houses one 18-inch driver; frequency response ranges from 40 Hz up to 200 Hz.
- The Mid-high M3 & M8 are concentric horn cabinets dedicated to the 200 Hz - 20 kHz frequency range reproduction; the MF range is handled by two exponential horn loaded 10-inch drivers whose response is optimised by two Nexo designed phase plugs; the HF range is handled by one constant directivity horn loaded two-inch Neodymium driver. M3 coverage is 35° (H) x 35°(V), M8 75° (H) x45° (V).
- The Mid-high EM forms part of the recently introduced Alpha E Series; its size and power-rating is smaller than that of the Alpha M3 & M8; the mid range is handled by an exponential horn loaded 10" driver, while the HF range is handled by a constant directivity horn loaded ceramic 2" driver. Alpha EM coverage is 75°x30°.
- The compact EF is dedicated to the full audio range reproduction 40 Hz – 20 kHz; it consists of one EM and one B1-18 stacked in a monoblock compact format.

Alpha cabinet formats are designed for optimal array assembly (see section "DIMENSIONS" p.34); all the cabinets have the same width and depth; height is in multiples of 200 mm UNITS.

- Six UNITS (1200 mm): Alpha S2, Alpha EF.
- Four UNITS (800 mm): Alpha B1-18.

- 
- Three UNITS (600 mm): Alpha B1-15, Alpha M3, Alpha M8.
  - Two UNITS (400 mm): Alpha EM.

## Nexo TDcontrollers

The Alpha Series speakers are associated with the NX241 Digital TDcontroller, which can be configured to provide comprehensive control of the above, mentioned cabinets. For a complete description of this unit please refer to the "NX241 User Manual". You may also use one of the following analogue TDcontrollers that preceded the NX241. Please refer to the corresponding user manual or contact your NEXO agent for more information on these products.

- Sub TDcontroller for use with Alpha S2;
- Alpha TDcontroller for use with Alpha B1-15, B1-18, M3 & M8;
- AlphaE TDcontroller for use with Alpha B1-18, EM & EF;

This manual will only refer to the NX241 TDcontroller. Please remember that the NX241 Digital TDcontroller is a software-based product for which regular updates will be published. Please consult the NEXO web site for the latest software releases.

## The X-BOW flying system

The design of the X-BOW flying system has been optimised for the dispersion specifications of the Alpha range, its mechanical characteristics match accurately the acoustical properties of the speakers.

The concept of this flying system enables efficient array assembly, with minimum space between cabinets, thus reducing edge diffraction.

The X-BOW flying system includes four main components, references are:

- ALXBOW: main chassis (1);
- ALXKIT: hinge (1) and cable links (2);
- ALXBRIDLE: D-ring (1) and leg chains (3);
- ALXCASE: flight-case for a complete X-BOW flying kit (capacity: 4 X-BOWs).

## General Set-up Instructions

### Speaker Wiring

#### Connectors

The loudspeakers are connected via SPEAKON connectors, NL4FC and NL8FC (not supplied). A wiring diagram is printed on the connection panel located on the back of each cabinet. The pins of the SPEAKON sockets are identified in/out and connected in parallel within the enclosures. A single 8-conductor cable carries all four bands required by the Alpha M3/B1/S2 system and the cabinet connectors allow all three types of cabinet to be safely linked at the loudspeaker end. (See Connections Diagrams at the end of this manual).

*NB: The Alpha S2 back panel features only one 4-pin SPEAKON connector in order to prevent accidental parallel connection: very few amplifiers are able to drive such low impedance loads at the required power level.*

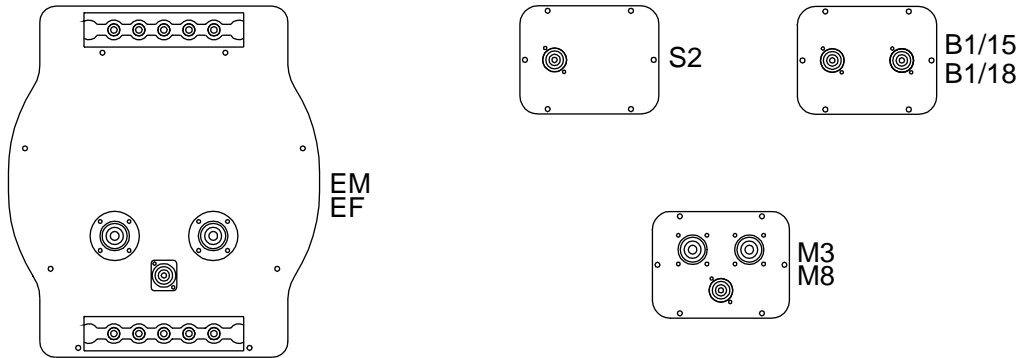

		S2	B1-15 / B1-18	M3 / M8	EM / EF
SP4 #1	1±	In / Out VLF	To VLF (S2)	To VLF (S2)	To VLF (S2)
	2±	Not connected	In / Out LF (B1)	To LF (B1)	To LF (B1)
SP4 #2	1±	-	To VLF (S2)	-	-
	2±	-	In / Out LF (B1)		-
SP8 #1	1±	-	-	In VLF (S2)	In / Out VLF (S2)
	2±	-	-	In / Out LF (B1)	In / Out LF (B1)
	3±	-	-	In / Out MF	P: In / Out MF+HF A: In / Out MF
	4±	-	-	In / Out HF	P: Not connected A: In / Out HF
SP8 #2	1±	-	-	In VLF (S2)	In VLF (S2)
	2±	-	-	In / Out LF (B1)	In / Out LF (B1)
	3±	-	-	In / Out MF	P: In / Out MF+HF A: In / Out MF
	4±	-	-	In / Out HF	P: Not connected A: In / Out HF

P = MF-HF passive / A = MF-HF active

## Cables

Nexo recommends the exclusive use of multi-conductor cables to connect the system: the cable kit is compatible with all the cabinets, and there is no possible confusion between VLF, LF, MF and HF sections.

Cable choice consists mainly of selecting the correct cable section (size) in relation to the load resistance and the cable length. Too small a cable section will increase its serial resistance; this would induce power-loss and response variations (damping factor).

For a serial resistance less or equal to 4% of the load impedance (damping factor = 25), the maximum cable length is given by:

$$L_{\max} = Z \times S \quad S \text{ in mm}^2, Z \text{ in Ohm, } L_{\max} \text{ in meters}$$

The table below indicates these values, for 3 common sizes.

Load Impedance ( $\Omega$ )	2	3	4	6	8	12	16
Cable section	Maximum Length (meters)						
1,5 mm <sup>2</sup> (AWG #14)	3	4.5	6	9	12	18	24
2,5 mm <sup>2</sup> (AWG #12)	5	7.5	10	15	20	30	40
4 mm <sup>2</sup> (AWG #10)	8	12	16	24	32	48	64

**IMPORTANT NOTE:** Long speaker cables induce capacitive effects that impair the quality of audio signals. If long speaker cables must be used, ensure that they do not remain coiled while in use.

## Flying the System

Alpha Series loudspeakers are equipped with steel anchor plates that can be fitted with NEXO X-BOW flying accessories. **The X-BOW Flying Manual must be thoroughly read before flying the system.**

The following points are designed to remind the user of safe practice when flying the X-BOW system. They cannot address every possible circumstance in which the system might be deployed; therefore the user must always apply his or her knowledge, experience and common sense. If in any doubt, seek advice from your NEXO agent.

### Flown Systems Safety

- Always inspect all the X-BOW components and cabinet Fly Rails for damage before assembly. Pay special attention to the lifting points, trombone sockets and safety clips. If you suspect that any of the components are damaged or defective, DO NOT USE THE AFFECTED PARTS. Contact your supplier for replacements.
- Read the X-BOW Flying manual carefully. Also, be familiar with the manuals and safe working procedures for any ancillary equipment which will be used with the X-BOW system such as hoists, steel wires and other rigging components.
- Ensure that all local and National regulations regarding the safety and operation of flying equipment are understood and adhered to. Information on these regulations can usually be obtained from Local Government Offices.
- When deploying the X-BOW system always wear protective headwear, footwear and eye protection.

- Do not allow inexperienced persons to handle X-BOW flying systems. Installation personnel should be trained in loudspeaker flying techniques and should be fully conversant with this manual.
- Ensure that motor hoists, hoist control systems and ancillary rigging components are currently certified as safe and that they pass a visual inspection prior to use.
- Ensure that public and personnel are not allowed to pass beneath the system during the installation process. The work area should be isolated from public access.
- Never leave the system unattended during the installation process.
- Do not place any object, no matter how small or light, on top of the system during the installation procedure. The object may fall when the system is flown and is likely to cause injury.
- Secondary safety steels must be installed once the system has been flown to the operating height. Secondary steels must be fitted irrespective of the local safety standards applicable to the territory.
- Do not fly the system over areas to which the audience has access.
- Ensure that the system is secure and prevented from pivoting about the motor hoist. Avoid any form of dynamic loading to the assembly.
- NEVER attach any item to the X-BOW other than the NEXO X-BOW accessories.
- When flying outdoor systems ensure that the system is not exposed to wind or snow loads and is protected from rainfall.
- The X-BOW requires regular inspection and testing by a competent test centre. NEXO recommend that the system is load tested and certified annually or more frequently if local regulations require.
- When de-rigging the system ensure that the same duty of care is given to the procedure as for the installation. Pack X-BOW components carefully to prevent damage in transit.
- Correct training is fundamental to safe practise when working with loudspeakers flying systems. NEXO recommend that users contact local industry associations for information on specialist course. Information for UK and International training agencies can be obtained by contacting:
  - The Production Services Association (PSA),

School Passage,  
Kingston-upon-Thames,  
KT1 SDU Surrey,  
ENGLAND  
Telephone: +44 (0) 181 392 0180

### Ground Stack Safety

Statistically, many more injuries occur due to unstable ground stacked PA systems than those associated with flown systems. There are several reasons for this fact, however the message is clear:

- Always survey the supporting structure upon which a ground stack is to be built. Always look beneath PA wings to inspect the deck support and if necessary ask for the stage scrims and dressings be removed to allow access.
- X-BOW components should be used to stabilise ground stacks and to ensure that cabinets remain securely registered to each other. The X-HINGE can be used to connect Alpha cabinets both vertically and horizontally at the rear and horizontally at the front edge. In addition the Fly Track can be used as a connection point for a safety wire to a secondary structure.
- If the stage surface slopes, as it does in some theatres, ensure that the system is prevented from sliding forwards due to vibration. This may require the fitting of timber battens to the stage floor.
- For outdoor systems ensure that that the system is protected from wind forces which might cause the ground stack to become unstable. Wind forces can be huge, especially upon large systems, and should never be underestimated. Observe meteorological forecasts, calculate the likely effect upon the system prior to erection and ensure that the system is secured appropriately.
- Take care when stacking cabinets. Always employ safe lifting procedures and never attempt to build stacks without sufficient personnel and equipment.
- Never allow anyone, whether operators, artists or members of the public to climb onto a ground stacked PA system. Anyone who needs to climb over 2m high should be fitted with suitable safety equipment including a clip-on harness. Please refer to local Health and Safety legislation in your territory. Your dealer can help with advice on access to this information.
- Apply the same attention to all safety matters when de-stacking systems.
- Be aware that safety procedures are as important in the truck and in the warehouse as they are at the venue.

## TDcontrollers settings

The Alpha Series cabinets will not perform correctly without their associated TDcontrollers. Sound quality and reliability are totally dependent on the correct use of the TDcontrollers, in association with the Nexo instructions, provided.

All manuals & associated technical notes must be read before set-up. Please contact your NEXO agent for any literature inquiry.

### NX241 Digital TDcontroller

The digital NEXO NX241 controller is able to drive the entire current Nexo range (PS & Alpha series). The following set-ups are supported (at the time of publication).

### Alpha Series

---

ALPHATD B1+M3	Configure Input A to drive a 3-Way Alpha System.
ALPHATD S2+B1+M3 SubTD S2-63Hz	Configure Input A to drive a 4-Way Alpha System.
ALPHATD S2+B1+M3 SubTD S2-80Hz	Configure Input A to drive a 4-Way Alpha System.
ALPHATD S2+B1+M3 S2-63Hz AUX inB	Configures Input B (right) to drive the SUB channel independently.
ALPHATD S2+B1+M3 S2-80Hz AUX inB	Configures Input B (right) to drive the SUB channel independently.

### Alpha E Series

---

AlphaE STEREO	Configures 2 passive Alpha EM + 2 B1-18 (or 2 Alpha EF) in stereo.
AlphaE MONO	Configures Input A to drive 1 passive Alpha EM + B1-18 + S2 sub cabinet. (Channel 4 is unused).

#### Very important:

*Due to the DSP processing time, analogue Sub TDcontroller / Alpha TDcontroller / AlphaE TDcontroller are incompatible with the Digital NX241 and should never be used in conjunction to control cabinets within the same array.*

---

## Initial Set-up Precautions

When running up a system particularly one which includes brand new cabinets for the first time the power should be increased slowly to approximately 50% and the system operated at this level for two hours. During the following two hours of operation the power level should be limited to approximately 75%. This procedure allows the adhesives and suspensions within the loudspeaker components to stabilise and will extend their working life.

In all cases, it is advisable to connect the loudspeakers only after all the other components have been wired and are operating correctly. This is particularly important for the amplifiers and the TDcontroller. It is a good practice to turn down all the amplifier gains before connecting the cabinets and then turn them up again individually with a medium level music source fed into the system. The sense LEDs of the corresponding TDcontroller channel should light up accordingly. This will help to locate cabling errors, particularly channel line inversions, which would disable the TDcontroller protections and may invalidate the warranty.

### IMPORTANT

If more than one amplifier is being driven from an output of the NX241 controller only those amplifiers which are not connected to sense inputs may be attenuated. If the sensed amplifier is attenuated and the slave amplifiers are not severe system damage will result!

## Alpha Arrays - Some Basic Rules

The concept of arraying speakers derives from two requirements:

- Increased sound pressure level;
- Extended coverage area.

Array behaviour is very complex, and a bad design can lead to very poor results. The Alpha system was designed to be flexible, allowing the user to optimise the design for a dedicated situation; its development included a long measurement program on a very large variety of arrays. Below are some simple rules that the user should respect.

### Alpha S2 Placement

The nominal efficiency data for Alpha S2 is given for when positioned on the floor (half-space). When flown the acoustic output on axis will be 3 dB lower and if positioned in a corner the acoustic output on axis will increase by 3 dB.

### SPL Versus Frequency

Array frequency response is strongly related to wavelength and array architecture.

- At low frequencies, wavelength being very large in relation to the size of the cabinets, speakers set close to each other will always radiate in phase. The gain in sound pressure level LGSPL will be of 6 dB per doubling, i.e. if  $n$  Alpha S2 or B1 are installed:

$$\text{LGSPL}(20\text{Hz}-100\text{Hz}) = 20 \log_{10}(n)$$

- In the mid frequency range, the gain depends on the configuration of the array, and will range from 3 to 6 dB per doubling, i.e. for  $n$  Alpha M3, M8, EM or EF:

$$10 \log_{10}(n) \leq \text{LGSPL}(100\text{Hz}-1\text{kHz}) \leq 20 \log_{10}(n)$$

- At high frequencies, wavelength being short in relation to the size of the cabinet, the gain level is smaller: no gain will be obtained for cabinets angled at their nominal coverage, maximum gain will be obtained for  $n$  cabinets pointing in the same direction. Therefore, the gain will range from 0 to 3 dB per doubling; for  $n$  Alpha M3, M8, EM or EF:

$$0 \leq \text{LGSPL}(1\text{kHz}-10\text{kHz}) \leq 10 \log_{10}(n)$$

### SPL Versus Distance

In open-air conditions, the level of sound at a given distance is related to the following parameters:

- The size and the geometry of the source, which determines the shape of the sound wave (spherical, cylindrical, plane);
- Hygrometry and temperature: viscosity of the air and thermal conduction cause an energy loss increasing with frequency. This phenomenon is referred to as excess attenuation.

### Single Cabinet

$L_p(1m)$  being the sound pressure level at 1m, the level at a distance  $d$  (in meters) is given by:

$$L_p(d) = L_p(1m) - 20 \log_{10}(d)$$

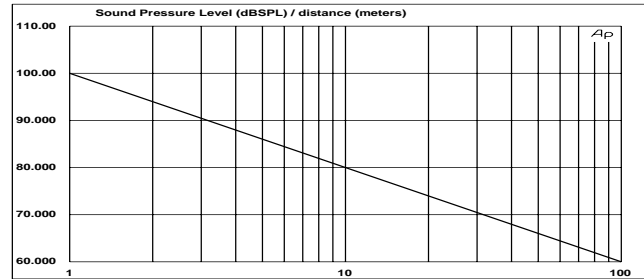
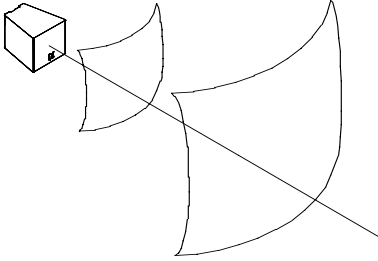

- Single Cabinet SPL versus Distance

For example, if the level measured at 1 meter is  $L_p(1m) = 100$  dB SPL, the level at 2 meters will be 94 dB SPL, 80 dB SPL at 10 meters and so on. Note that under these conditions of small source and open air, the sound pressure level will be decreasing by 6 dB when doubling the distance.

### Straight Vertical Array (long throw)

Some open-air applications might require loud level on a wide frequency range at a long distance. It is then recommended to stack a large number of Alpha M3/M8/EM vertically. Up to a determined distance - function of the frequency and the height of the stack -, the sound wave is cylindrical ( $3dB/2d$ ); it becomes progressively spherical ( $6dB/2d$ ) above that distance.

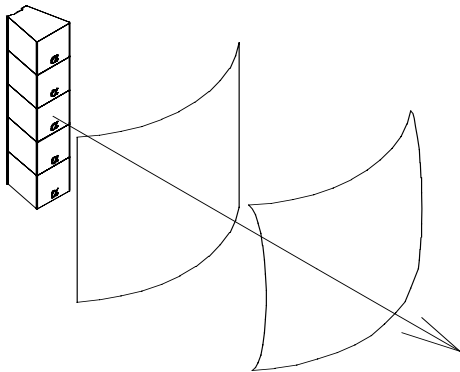

- Transition from cylindrical to spherical wave front

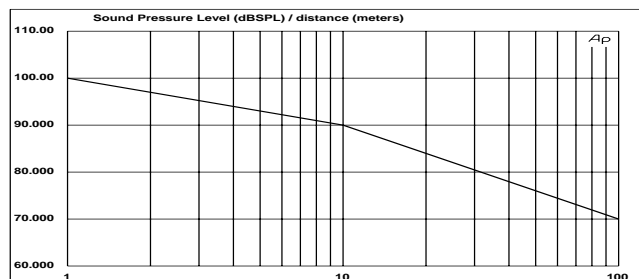

Hygrometry and Temperature - Air Absorption

Under usual conditions, air absorption increases when relative humidity decreases and increases when temperature decreases.

Air absorption gives a linear attenuation, i.e. a constant value of loss of dB per meter: if 1 dB is lost from 10 to 20 meters, 2 dB will be lost from 20 to 40 meters, 4 dB from 40 to 80 meters and so on...

The tables below list these values for normalised frequencies, and various values of relative humidity and temperature:

At 20°C:

[dB] loss / meter	Up to 1 kHz	2 kHz	4 kHz	8 kHz	16 kHz
RH 20%	0	0.02	0.06	0.20	0.66
RH 50%	0	0.01	0.03	0.08	0.27
RH 80%	0	0.00	0.02	0.05	0.17

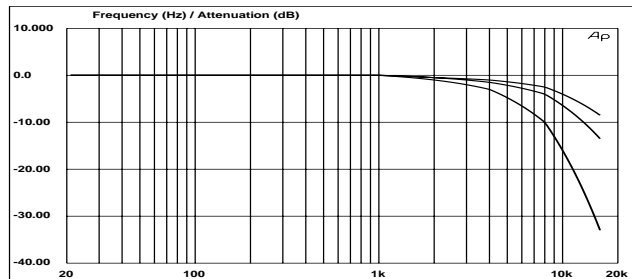

Air absorption over a 50m distance; RH=20%-50%-80%

At RH 50%:

[dB] loss / meter	Up to 1 kHz	2 kHz	4 kHz	8 kHz	16 kHz
10°C	0	0.01	0.04	0.13	0.43
20°C	0	0.01	0.03	0.08	0.27
30°C	0	0.01	0.02	0.06	0.19

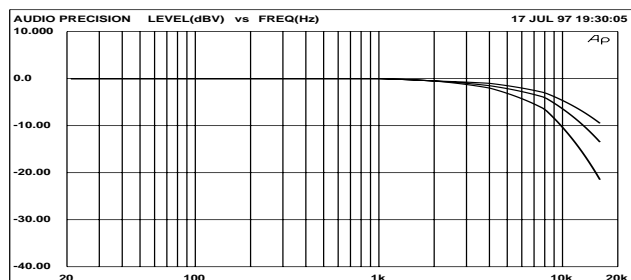

Air absorption over a 50m distance; t=10°C-20°C-30°C

The speed of sound C varies with temperature according to the formula below:

$$C = 20\sqrt{t^{\circ} + 273} \quad \text{Where } t^{\circ} \text{ is the temperature in } ^{\circ}\text{C}$$

The delay time between two sources spaced at a distance d is then:

$$\Delta t = C/d$$

## Directivity - Coverage

The two main qualities one might expect from a cabinet for array constructions are:

- A good directivity control in the mid and high frequency region, which guarantees the steadiness of the interference region where dips and lobes occur;
- A strong roll-off of the directivity function at the -6dB cut-off angle, which minimises the size of the interference region.

The Alpha series cabinets were designed to respect these two criteria. Particularly, the Alpha M3 features a constant coverage angle +/- 5° from as low as 800 Hz up to 12 kHz, with high values of dB loss / degrees at cut-off angle.

### Directivity of Multiple Sources - What HAPPENS?

In order to understand the coverage behaviour of combined sources, wavelength must be related to the space between sources.

The wavelength  $\lambda$  (in meters) of a sine wave is determined by:

$$\lambda = C/f \quad \text{where } f \text{ is the frequency of the sine wave}$$

This gives:  $\lambda(20\text{Hz}) = 17 \text{ m}$ ,  $\lambda(100\text{Hz}) = 3.4 \text{ m}$ ,  $\lambda(1\text{kHz}) = 34 \text{ cm}$  and  $\lambda(20\text{kHz}) = 1.7 \text{ cm}$

### Interference

The distance between sources generates a path length difference between the two signals that is nil on axis and increases with the listening angle. If this path length difference increases to half the wavelength in a specific direction, the two signals will cancel in that direction. This phenomenon is often described as « interference ».

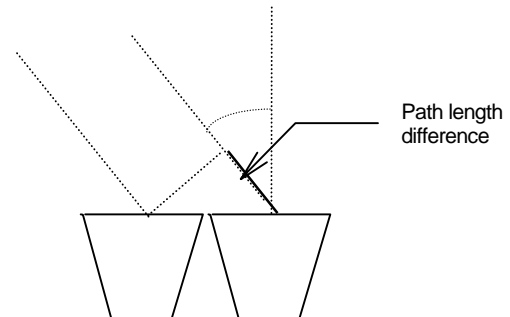

### Resulting directivity

At low frequencies -because wavelength is much larger than the spacing between sources- interference is generally not significant. However the directivity index will increase.

In the mid and high frequency range, where wavelength is comparable to spacing between sources, the directivity polar plots will show dips and lobes. The amplitude of these lobes will depend on the directivity of the individual sources and on their angulations.

### Small Arrays (less than 4 Alphas M3 / M8)

The amplitude of the dips and the lobes is minimised when angling the cabinets at their nominal coverage angle. If the angle is less than the coverage, the interference region will be larger, and if the angle exceeds that value, there will be a « hole » between the cabinets.

It is therefore strongly recommended when using a small amount of cabinets to angle them at their nominal coverage angle (Alpha M3: 35°x35°, M8: 75° x 45°; EM/EF: 75° x 30°).

The only situations where such arrays can be assembled with very little angle are long throw applications (very small vertical coverage) because the interferences are less significant at large distances from the array.

#### Large Arrays (4 Alphas M3 / M8 and above)

Construction of large arrays derives from important SPL requirements rather than large listening angles: although the Alpha M3 is a high Q cabinet, 4 boxes are enough to cover a 140° horizontal plane. Therefore, large arrays will usually assemble cabinets at less than their nominal coverage angle.

Measurements and simulations show that when using a large amount of cabinets, the individual behaviour of a cabinet will determine the roll-off on the limits of the coverage zone, and the architecture of the array will be responsible for the behaviour in the coverage zone.

For examples of suitable cabinet configurations please refer to the Alpha System Flying Manual and to subsequent technical notes.

## Amplifiers

### Power

NEXO recommends high power amplifiers in all cases. Budget constraints are the only reason to select lower power amplifiers. If an incident occurs on an installation without protection the fact that amplifiers only generating half their rated output power (-3dB) are used will not change anything in respect of possible damage. This is due to the fact that the RMS power handling of the weakest component in the system is always 6 to 10 dB lower than the amplifier rating.

### Current rating

It is very important that the amplifier behaves correctly under low load conditions. A speaker system is reactive by nature, on transient signals like music it will require much higher instantaneous current than its nominal impedance would indicate (four to ten times more). Amplifiers are generally specified by continuous RMS power into resistive loads however the only useful information in that respect is the specification into a 2-ohm load. It is possible to make an amplifier listening test by loading them with twice the number of cabinets considered for the application (2 speakers per channel instead of one, 4 instead of 2) and modulating at high level (onset of clipping). If the signal does not noticeably deteriorate the amplifier is well adapted (overheating after approximately ten minutes is normal but thermal protection must not operate too quickly after starting this test).

### Amplifier gains

Technical knowledge on the amplifiers to be used with the system is essential. This data is the key to the correct alignment of the system. It is especially important to know the gain of all amplifiers used in your set-up. The tolerance shall be about  $\pm 0,5$  dB. In practice this can be difficult to achieve because:

- Some amplifier brands have an identical input sensitivity for models of different power rating (this infers a different voltage gain for each model). For example a range of amplifiers with different power outputs having a published input sensitivity of 775mV/0dBm or 1.55V/+6dBm will have a wide range of actual gains, the higher the power, the greater the gain.
- Various other brands may offer constant gain but only within a given product range for example they may fit only fixed input sensitivity on their semi-professional amps.
- Even if a manufacturer applies the constant gain rule to all models, the value selected will not necessarily be the same as that chosen by other manufacturers.
- Some products can exhibit manufacturing tolerances for the same model of  $\pm 1$ dB or more. Some amplifiers may have been modified, possibly without any label indicating the new values and some may have gain switches fitted internally where it is impossible for the user to verify the actual setting without opening the amplifier casing. In cases where you don't know the gain of your amplifier (or want to check it) please read the following instructions.
  1. Unplug any cabinet from the amp
  2. With a signal generator feed a sine wave at 1000Hz at a known voltage (say 0.5V) to the input of the amplifier under test.

3. Measure the Voltage at the output of the amplifier.
4. Calculate the gain using the formula  $\text{Gain} = 20 * \text{LOG}_{10}(\text{Vout}/\text{Vin})$

Some examples:

<b>Vin</b>	<b>Gain</b>	<b>20dB</b>	<b>26dB</b>	<b>32dB</b>	<b>37dB (1.4V sensitivity / 1350Wrms)</b>
0.1V		1V	2V	4V	7.1V
0.5V		5V	10V	20V	35.4V
1V		10V	20V	40V	70.8V

Remember that constant sensitivity settings will give a different gain value when the amplifier power is different.

### Gain value

NEXO recommends low gain amplifiers: +26dB is recommended, as it is at the same time adequately low and quite common amongst amplifier manufacturers. This gain setting improves signal to noise ratio and allows all preceding electronic equipment, including the TDcontroller, to operate at optimum level. Remember that using a high gain amplifier will proportionally raise the noise floor by the same amount.

### Advanced protections

Some high-end amplifiers may have some advanced functions similar to those found in the NX241 TDcontroller ("loudspeaker offset integration", "limiter", "compressor"...). These functions are not adapted to specific system requirements and may interfere with the complex protection algorithms used in the NX241. NEXO do not advise using other protection systems in conjunction with the NX241 and they should be disabled.

## PASSIVE CROSSOVER FUSES

Please note, within both Alpha & AlphaE cabinet families a fuse is fitted to protect the internal passive filter network in the event of a voice coil failure. This fuse is located on the filter network, which is attached to the input panel of the following cabinets.

- Alpha M3/8 cabinets
- Alpha EM series cabinets
- Alpha EF series cabinets

It is vital that this fuse is checked at regular service intervals and especially when replacing any loudspeaker components.

If the fuse fails it will not prevent the cabinet from functioning but, should the cabinets be operated in this condition, the audio quality will be seriously degraded.

Failure to replace a defective fuse will cause a difference in audio quality between fully operational cabinets and those with defective fuses. It is very important to replace the fuse with exactly the same type and value as the original fitted to the cabinet.

The various fuse specifications are:

- |                       |             |        |
|-----------------------|-------------|--------|
| • Alpha M3/8 cabinets | T1.25A/250V | 5X20mm |
| • Alpha EM/F MF       | T6.3A/250V  | 5X20mm |
| • Alpha EM/F HF       | T5A/250V    | 5X20mm |

## TECHNICAL SPECIFICATIONS

### Alpha S2

SYSTEM SPECS	ALPHA S2 with Sub TDcontroller
Frequency Response [a]	32 Hz – 64 Hz ± 3 dB
Usable Range @-6dB [a]	29 Hz – 180 Hz
Sensitivity 1W @ 1m [b]	105 dB SPL
Peak SPL @ 1m [b]	140 dB Peak
Nominal Impedance	3 ohms (2.7 min)
Recommended Amplifiers	1800 to 2400 Watts into 3 ohms

FEATURES	ALPHA S2
Components	2 x 18" (46cm) long excursion 6 ohms drivers, high efficiency acoustic load.
Height x Width x Depth	1200 x 689 x 754 mm carpet version (47 1/4" x 27 1/8" x 29 11/16")
Shape	22.5 Trapezoid
Weight: Net	85 kg (187 Lb) With wheel board: 95 kg (209 Lb)
Connectors	1 x 4 poles Speakon 1+ & 1- (Sub S2)
Construction	Baltic Birch with Dark Grey carpeting, Structured Black coating painting finish also available.
Handles	4 Metal Bar Handles
Front Finish	Acoustic Foam on hex perforated steel grid (77% transparent)
Flying points	4 Flying Tracks on front (7 positions on 2° steps) Top to bottom Steel Back plate 2 Flying Tracks on Back (Hinge fixing) Internal top to bottom Steel links Painted version without Flying Tracks also available
Fixed Installation	The X-BOW Flying Tracks can also receive standard Aircraft Flying Fittings.

As part of a policy of continual improvement, NEXO reserves the right to change specifications without notice.

- [a] Response Curves and Data: Anechoic Far Field above 200 Hz, Half-space Anechoic below 200 Hz.  
Usable Range Data: Frequency Response Capability with TD crossover slopes removed.
- [b] Sensitivity & Peak SPL: will depend on spectral distribution. Measured with band limited Pink Noise.  
Refers to the specified +/- 3 dB range. Data are for Speaker + Processor + recommended amplifier combinations.

## TECHNICAL SPECIFICATIONS

## Alpha B1-15 / B1-18

SYSTEM SPECS	ALPHA B1-15	ALPHA B1-18
Frequency Response [a]	Wideband: 42 Hz – 180 Hz ± 3 dB Xover: 80 Hz – 190 Hz ± 3 dB	40 Hz – 230 Hz ± 3 dB
Usable Range @-6dB [a]	39 Hz – 600 Hz	38 Hz – 600 Hz
Sensitivity 1W @ 1m [b]	106 dB SPL	107 dB SPL Nominal
Peak SPL @ 1m [b]	140 dB Peak	142 dB Peak
Nominal Impedance	6 ohms (5.2 mini)	6 ohms (4.7 mini)
Recommended Amplifiers	900 to 1200 Watts into 6 ohms	900 to 1400 Watts into 6 ohms
FEATURES	ALPHA B1-15	ALPHA B1-18
Components	1 x 15" (38 cm) 6 ohms Folded Horn, Composite Curve	1 x 18" (46 cm) 6 ohms Folded Horn, Composite Curve
Height x Width x Depth	600 x 689 x 754 mm (23 5/8" x 27 1/8" x 29 11/16")	800 x 689 x 754 mm (31.49" x 27 1/8" x 29 11/16")
Shape	22.5° Trapezoid	
Weight: Net	51 kg (112 Lb) With wheel board: 58 kg (128 Lb)	69.9 kg (155 Lb) With wheel board: 79 kg (175 Lb)
Connectors	2x 4 poles Speakon (In / Out)	1+ & 1- (Sub S2) 2+ & 2- (Bass B1)
Construction	Baltic Birch with Dark Grey carpeting, Structured Black coating painting finish also available.	
Handles	2 Metal Bar Handles	4 Metal Bar Handles
Front Finish	Acoustic Foam on hex perforated steel grid (77% transparent)	
Flying points	4 Flying Tracks on front (7 positions on 2° steps) Top to bottom Steel Back plate 4 Flying Tracks on Back (Hinge fixing) Internal top to bottom Steel links Painted version without Flying Tracks also available	Crossbow Flying System cabinet Hardware: Optional 4 Flying Tracks on Front Internal top to bottom Steel links Optional 2 Flying tracks on back (Hinge fixing) Painted version without Flying Tracks also available
Fixed Installation	The X-BOW Flying Tracks can also receive standard Aircraft Flying Fittings.	

As part of a policy of continual improvement, NEXO reserves the right to change specifications without notice.

- [a] Response Curves and Data: Anechoic Far Field above 200 Hz, Half-space Anechoic below 200 Hz.  
Usable Range Data: Frequency Response Capability with TD crossover slopes removed.
- [b] Sensitivity & Peak SPL: will depend on spectral distribution. Measured with band limited Pink Noise.  
Refers to the specified +/- 3 dB range. Data are for Speaker + Processor + recommended amplifier combinations.

## Alpha M3 / M8

SYSTEM SPECS	ALPHA M3	ALPHA M8
Frequency Response [a]	190 Hz – 19 kHz $\pm$ 3 dB	190 Hz – 19 kHz $\pm$ 3 dB
Usable Range @-6dB [a]	150 Hz – 20 kHz	150 Hz – 20 kHz
Sensitivity 1W @ 1m [b]	110 dB SPL	108 dB SPL
Peak SPL @ 1m [b]	145 dB Peak	143 dB Peak
Dispersion [c]	35° x 35°	75° x 45° (HF Horn Rotatable)
Directivity: Q & DI [c]	Q = 32 – DI = 15 dB (Nominal f > 630 Hz)	Q = 20 – DI = 13 dB (Nominal f > 630 Hz)
Nominal Impedance	MF: 12 ohms (15.5 min) HF: 12 ohms (8.0 min)	MF: 12 ohms (15.5 min) HF: 12 ohms (8.0 min)
Recommended Amplifiers	MF: 650 to 900 Watts into 12 ohms HF: 350 to 500 Watts into 12 ohms	MF: 650 to 900 Watts into 12 ohms HF: 350 to 500 Watts into 12 ohms

FEATURES	ALPHA M3	ALPHA M8
Components	MF: 2 x 10" (24 cm) 8 ohms 3" Coil Drivers; Dual Ring Phase Plugs HF: 1 x 3" Neodymium Driver, Titanium diaphragm Coaxial mounted wave guide	
Height x Width x Depth	600 x 689 x 754 mm Carpet version (23 5/8" x 27 1/8" x 29 11/16")	
Shape	22.5° Trapezoid	
Weight: Net	57 kg (126 Lb) With wheel board: 64 kg (141 Lb)	
Connectors	2 x 8 poles Speakon (In / Out)	1+ & 1- (Sub S2) 2+ & 2- (Bass B1) 3+ & 3- (MF) 4+ & 4- (HF)
	1 x 4 poles Speakon (to B1 & S2)	1+ & 1- (Sub S2) 2+ & 2- (Bass B1)
Construction	Baltic Birch with Dark Grey carpeting, Structured Black coating painting finish also available.	
Handles	2 Metal Bar Handles	
Front Finish	Acoustic Foam on hex perforated steel grid (77% transparent)	
Flying points	4 Flying Tracks on front (7 positions on 2° steps) Top to bottom Steel Back plate 4 Flying Tracks on Back (Hinge fixing) Internal top to bottom Steel links Painted version without Flying Tracks also available	
Fixed Installation	The X-BOW Flying Tracks can also receive standard Aircraft Flying Fittings.	

As part of a policy of continual improvement, NEXO reserves the right to change specifications without notice.

- [a] Response Curves and Data: Anechoic Far Field above 200 Hz, Half-space Anechoic below 200 Hz.  
Usable Range Data: Frequency Response Capability with TD crossover slopes removed.
- [b] Sensitivity & Peak SPL: will depend on spectral distribution. Measured with band limited Pink Noise.  
Refers to the specified  $\pm$  3 dB range. Data are for Speaker + Processor + recommended amplifier combinations.
- [c] Directivity Curves and Data: 1/3 octave smoothed frequency response, normalised to On-Axis response.  
Data obtained by computer processing on off-axis response curves.

## TECHNICAL SPECIFICATIONS

## Alpha EM / EF

SYSTEM SPECS	ALPHA EM	ALPHA EF
Frequency Response [a]	220 Hz – 19 kHz $\pm$ 3 dB	40 Hz – 19 kHz $\pm$ 3 dB
Usable Range @ -6dB [a]	180 Hz – 20 kHz $\pm$ 6 dB	38 Hz – 20 kHz $\pm$ 6 dB
Sensitivity 1W @ 1m [b]	107 dB SPL	107 dB SPL
Peak SPL @ 1m [b]	140 dB Peak	LF: 142 dB Peak MF/HF: 140 dB Peak
Dispersion [c]	75° x 30°	75° x 30°
Directivity: Q & DI [c]	Q = 25 – DI = 14 dB (Nominal f > 630 Hz)	Q = 25 – DI = 14 dB (Nominal f > 630 Hz)
Cross-Over Frequency	MF/HF: 2.2 kHz (Passive)	LF/MF: 210 Hz (Active) MF/HF: 2.2 kHz (Passive)
Nominal Impedance	8 ohms (7.5 min)	LF: 6 ohms (4.7 min) MF/HF: 8 ohms (7.5 min)
Recommended Amplifiers	700 to 1000 Watts into 8 ohms	MF: 900 to 1400 Watts into 6 ohms MF/HF: 700 to 1000 Watts into 8 ohms

FEATURES	ALPHA EM	ALPHA EF
Components	MF: 1 x 10" (24 cm) 8 ohms HF: 1 x 3" Ceramic Driver, Titanium diaphragm Coaxial mounted wave guide	LF: 1 x 18" (46cm) 6 Ohms Composite Curve MF: 1 x 10" (24 cm) 8 ohms HF: 1 x 3" Ceramic Driver, Titanium diaphragm Coaxial mounted wave guide
Height x Width x Depth	400 x 689 x 754 mm Carpet version (15 3/4" x 27 1/8" x 29 11/16")	1200 x 689 x 754 mm Carpet version (47 1/4" x 27 1/8" x 29 11/16")
Shape	22.5° Trapezoid	
Weight: Net	46.6 kg (99 Lb)	98 kg (209 Lb) With wheel board: 105 kg (231 Lb)
Connectors	2 x 8 poles Speakon (In / Out)	1+ & 1- (Sub-bass S2) 2+ & 2- (Bass B1) 3+ & 3- (MF/HF) 4+ & 4- (NC)
	1 x 4 poles Speakon (to B1 & S2)	1+ & 1- (Sub-bass S2) 2+ & 2- (Bass B1)
Construction	Baltic Birch with Dark Grey carpeting, Structured Black coating painting finish also available.	
Handles	2 Metal Bar Handles	4 Metal Bar Handles
Front Finish	Acoustic Foam on hex perforated steel grid (77% transparent)	
Flying points (optional)	4 Flying Tracks on front (7 positions on 2° steps) Top to bottom Steel Back plate 4 Flying Tracks on Back (Hinge fixing) Internal top to bottom Steel links Painted version without Flying Tracks also available	
Fixed Installation	The X-BOW Flying Tracks can also receive standard Aircraft Flying Fittings.	

As part of a policy of continual improvement, NEXO reserves the right to change specifications without notice.

- [a] Response Curves and Data: Anechoic Far Field above 200 Hz, Half-space Anechoic below 200 Hz.  
Usable Range Data: Frequency Response Capability with TD crossover slopes removed.
- [b] Sensitivity & Peak SPL: will depend on spectral distribution. Measured with band limited Pink Noise.  
Refers to the specified +/- 3 dB range. Data are for Speaker + Processor + recommended amplifier combinations.
- [c] Directivity Curves and Data: 1/3 octave smoothed frequency response, normalised to On-Axis response.  
Data obtained by computer processing on off-axis response curves.

Directivity Tables

Off-Axis Attenuation from On-Axis Frequency Response (dB)

125 Hz																			
Angle / dB	0	10	20	30	40	50	60	70	80	90	100	110	120	130	140	150	160	170	180
B1+M3 hor	0.0	0.5	1.3	2.0	2.5	3.5	4.3	4.5	5.0	4.8	6.0	6.0	6.5	6.8	6.3	7.0	6.3	5.8	5.5
B1+M3 vert	0.0	0.3	0.5	1.5	2.0	2.8	3.5	4.3	4.8	5.5	6.0	6.8	6.8	6.0	7.0	6.5	6.0	5.5	5.5
B1+M8 hor	0.0	0.5	1.3	2.0	2.5	3.5	4.3	4.5	5.0	4.8	6.0	6.0	6.5	6.8	6.3	7.0	6.3	5.8	5.5
B1+M8 vert	0.0	0.3	0.5	1.5	2.0	2.8	3.5	4.3	4.8	5.5	6.0	6.8	6.8	6.0	7.0	6.5	6.0	5.5	5.5
EMEF hor	0.0	0.3	0.5	1.0	2.0	2.5	3.3	4.0	4.5	5.0	5.5	6.3	6.0	6.0	5.8	5.3	4.5	4.3	4.0
EMEF vert	0.0	0.0	0.3	0.5	1.0	1.5	2.0	2.8	3.5	4.0	4.8	5.5	6.0	6.0	5.8	5.0	4.5	4.3	4.0
250 Hz																			
Angle / dB	0	10	20	30	40	50	60	70	80	90	100	110	120	130	140	150	160	170	180
B1+M3 hor	0.0	0.3	1.0	2.0	3.0	4.3	5.5	6.8	8.0	8.5	9.5	9.8	9.8	10.0	9.5	8.8	8.0	7.5	7.5
B1+M3 vert	0.0	0.3	0.8	1.5	2.5	4.0	5.3	6.5	7.5	8.5	9.8	10.8	12.0	12.0	11.0	9.8	8.5	8.0	7.5
B1+M8 hor	0.0	0.3	0.8	2.0	3.0	4.3	6.0	7.0	8.0	8.8	9.3	10.0	10.5	10.3	10.0	9.3	8.0	7.5	7.8
B1+M8 vert	0.0	0.3	1.0	1.8	3.0	4.3	5.5	7.0	8.0	9.3	10.3	11.3	12.0	12.0	11.0	9.8	8.8	7.8	7.8
EMEF hor	0.0	0.3	0.8	1.8	3.0	4.0	5.3	6.3	7.0	7.8	8.0	8.5	8.8	8.8	8.3	7.5	6.5	6.0	6.0
EMEF vert	0.0	0.0	0.5	1.0	1.5	2.5	3.3	4.0	4.8	5.5	6.5	7.5	8.5	8.8	8.8	8.0	7.0	6.3	6.0
500 Hz																			
Angle / dB	0	10	20	30	40	50	60	70	80	90	100	110	120	130	140	150	160	170	180
B1+M3 hor	0.0	0.5	2.0	4.5	7.3	9.8	12.0	14.0	15.8	16.8	17.8	18.8	19.0	18.8	18.5	18.0	17.0	15.0	14.5
B1+M3 vert	0.0	0.5	2.0	4.3	6.8	9.3	11.8	13.5	15.0	16.3	17.3	18.3	19.0	20.0	20.5	21.0	19.3	16.0	14.5
B1+M8 hor	0.0	0.5	2.0	4.3	6.5	9.0	12.0	14.0	16.3	17.8	18.5	19.0	19.3	19.5	19.5	19.5	17.5	15.5	15.8
B1+M8 vert	0.0	0.5	2.0	4.0	6.5	8.8	11.3	13.5	15.5	16.8	17.5	18.3	19.3	20.5	21.5	21.8	19.5	16.5	15.8
EMEF hor	0.0	0.5	2.0	4.0	6.5	9.3	11.8	14.0	15.8	17.0	17.0	17.3	17.8	18.0	17.8	16.3	14.3	12.5	12.0
EMEF vert	0.0	0.3	1.0	1.8	3.0	4.5	6.0	7.5	8.8	10.0	11.0	11.3	12.0	13.0	15.0	16.3	14.5	12.8	12.0
1000 Hz																			
Angle / dB	0	10	20	30	40	50	60	70	80	90	100	110	120	130	140	150	160	170	180
B1+M3 hor	0.0	1.3	5.0	10.0	13.0	14.5	15.8	17.3	18.8	20.0	21.5	22.3	23.5	24.5	23.5	20.5	21.0	18.5	16.8
B1+M3 vert	0.0	1.8	6.0	10.8	12.3	13.0	14.3	15.5	17.3	18.5	19.5	20.5	21.5	22.0	22.8	23.5	26.3	20.5	16.8
B1+M8 hor	0.0	1.5	5.5	9.8	11.5	12.5	13.8	15.3	17.0	18.8	19.5	21.0	22.0	22.3	22.0	20.0	20.8	17.5	16.3
B1+M8 vert	0.0	1.8	6.5	11.0	11.5	12.0	13.3	15.0	16.5	17.8	18.5	20.0	21.0	21.3	21.8	21.5	20.5	19.5	16.3
EMEF hor	0.0	2.0	6.3	9.8	9.5	9.5	10.3	11.3	12.5	13.5	14.3	15.3	16.5	17.5	18.8	17.3	18.8	19.0	17.0
EMEF vert	0.0	0.8	2.5	5.0	8.0	10.8	13.0	15.3	17.5	19.3	20.3	21.0	21.5	22.0	23.0	23.0	21.3	19.0	17.0
2000 Hz																			
Angle / dB	0	10	20	30	40	50	60	70	80	90	100	110	120	130	140	150	160	170	180
B1+M3 hor	0.0	1.3	6.0	14.0	14.5	16.0	18.3	19.8	21.5	23.3	25.5	27.5	28.5	30.0	30.0	29.8	27.8	27.3	28.0
B1+M3 vert	0.0	1.8	7.0	14.3	15.8	17.0	20.0	21.8	23.3	24.5	25.8	27.0	28.3	29.0	29.0	29.3	29.5	29.3	28.0
B1+M8 hor	0.0	1.5	5.8	10.5	11.5	11.3	13.5	16.5	20.5	24.0	25.5	28.0	27.3	27.5	27.5	28.5	27.0	28.5	28.0
B1+M8 vert	0.0	2.3	7.5	12.5	15.0	16.0	18.0	20.5	22.5	24.5	25.8	27.0	28.0	29.0	27.8	26.8	29.0	29.5	28.0
EMEF hor	0.0	1.5	4.5	7.8	7.8	8.0	10.0	12.5	15.5	18.0	19.5	20.0	21.5	22.8	23.0	23.8	25.5	25.8	24.0
EMEF vert	0.0	1.8	5.5	10.5	14.5	16.5	18.3	20.0	22.0	24.0	25.5	26.3	27.0	28.0	29.3	28.0	26.5	25.0	24.0
4000 Hz																			
Angle / dB	0	10	20	30	40	50	60	70	80	90	100	110	120	130	140	150	160	170	180
M3 hor	0.0	2.0	6.5	11.3	16.0	19.5	22.5	25.5	28.8	31.8	34.5	37.3	38.3	39.8	40.5	40.3	40.5	38.0	37.8
M3 vert	0.0	2.3	6.8	12.3	16.5	19.0	22.5	25.5	29.5	32.0	34.5	36.8	38.3	39.3	39.3	40.0	39.5	38.8	37.8
M8 hor	0.0	1.0	3.8	6.8	11.3	14.3	18.0	21.0	25.0	28.8	31.0	33.0	34.3	35.0	36.0	37.0	38.0	39.5	38.0
M8 vert	0.0	2.0	5.8	11.0	15.5	20.0	23.3	27.0	30.0	33.0	34.8	36.5	37.3	38.0	39.0	40.0	41.0	40.5	38.0
EMEF hor	0.0	1.5	3.8	5.5	6.8	9.3	12.3	16.0	19.8	23.8	26.5	28.3	29.3	30.0	31.0	33.8	33.0	33.5	32.3
EMEF vert	0.0	2.8	7.8	12.8	16.3	19.3	21.8	24.0	26.0	28.3	30.0	31.0	32.5	33.8	34.5	35.0	34.8	34.0	32.3
8000 Hz																			
Angle / dB	0	10	20	30	40	50	60	70	80	90	100	110	120	130	140	150	160	170	180
M3 hor	0.0	1.5	7.0	13.3	18.5	22.3	25.0	29.5	34.8	39.0	42.8	45.3	45.5	47.8	48.8	47.0	48.0	46.3	47.3
M3 vert	0.0	1.8	7.0	13.5	18.8	21.5	25.0	28.5	33.8	38.0	40.5	42.5	44.5	45.5	46.3	47.3	48.0	49.0	47.3
M8 hor	0.0	0.3	2.0	6.3	11.8	15.0	19.0	22.5	28.0	31.8	40.5	43.0	44.0	45.0	46.0	47.0	48.0	49.0	47.5
M8 vert	0.0	1.8	5.8	11.3	16.5	20.8	24.3	29.0	32.0	35.0	42.0	44.0	45.0	46.0	47.0	48.0	49.0	47.0	47.5
EMEF hor	0.0	0.8	3.0	6.0	8.0	11.5	14.5	18.5	24.3	30.0	33.8	36.3	37.0	39.3	40.5	41.8	41.8	42.5	42.0
EMEF vert	0.0	3.3	9.5	15.5	20.0	23.3	24.5	26.5	30.8	34.3	36.0	38.0	38.8	39.8	40.0	41.5	41.5	40.8	42.0

**NOTE:** Those data are also available in electronic format. (EASE™ compatible) contact your NEXO agent.

CURVES

Alpha S2

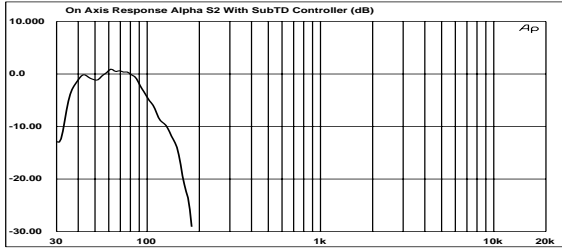

• Figure 1: Frequency Response with Sub TDcontroller (dB)

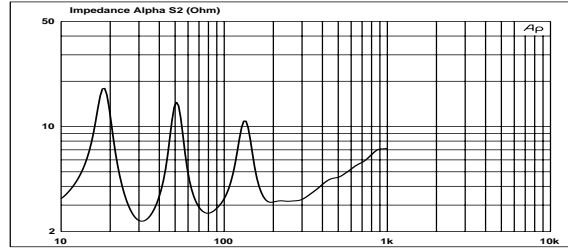

• Figure 2: Impedance (Ohms)

Alpha B1-18

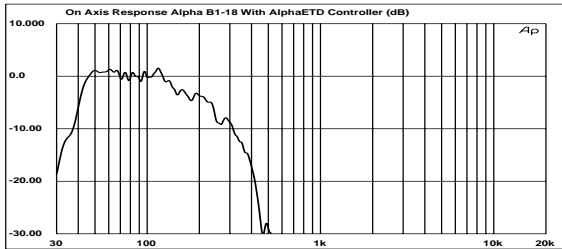

• Figure 3: Frequency Response with AlphaE TDcontroller (dB)

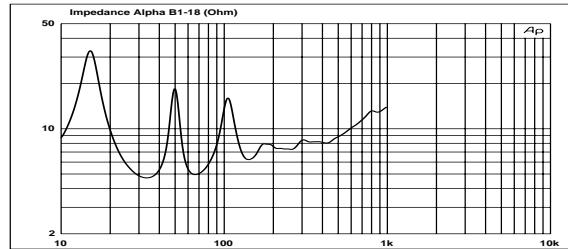

• Figure 4: Impedance (Ohms)

Alpha B1-15

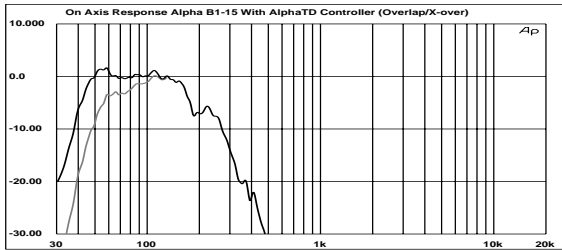

• Figure 5: Frequency Response with Alpha TDcontroller (dB)  
Black: Overlap Mode, Grey: X-Over mode

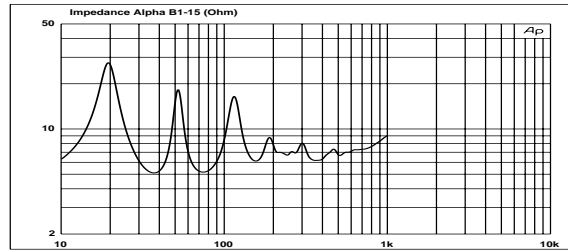

• Figure 6: Impedance (Ohms)

Frequency Response Curves: Anechoic Far Field above 200 Hz, Half-space Anechoic below 200 Hz.

Impedance: Voltage to Current Ratio, Free Field measurement

Off-Axis Frequency Response: 1/3 octave smoothed frequency response, normalised to On-Axis response.

Directivity Curve, Coverage Angle and Polar Diagram from computer processing on off-axis response curves.

# Alpha M3

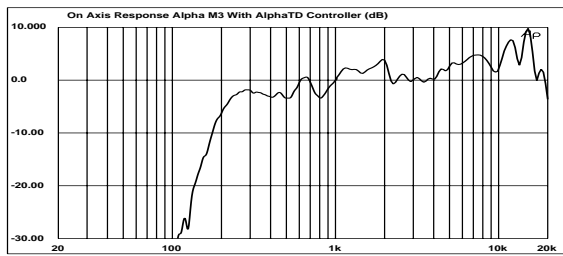

• Figure 7: Frequency Response with Alpha TDcontroller (dB)

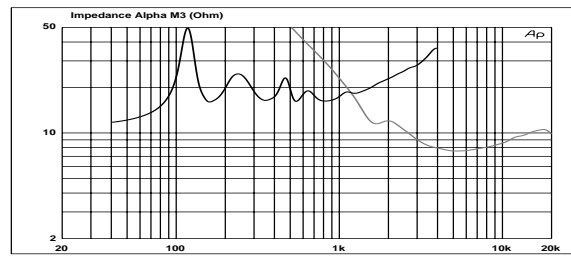

• Figure 8: Impedance (Ohms) *Black: MF, Grey: HF*

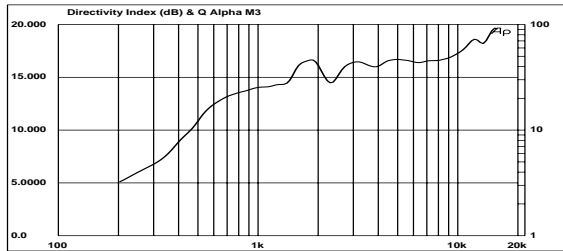

• Figure 9: Directivity Index (dB) and Factor

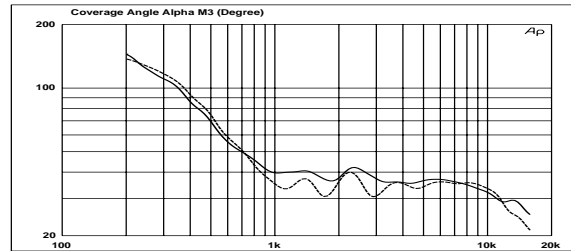

• Figure 10: Nominal Coverage @ -6 dB (Degrees)

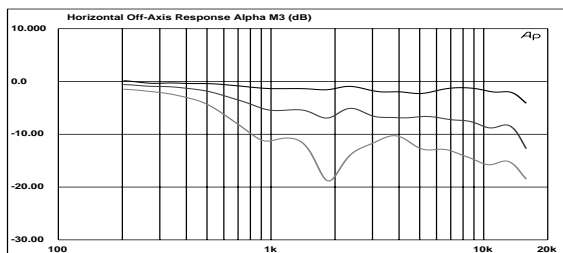

• Figure 11: Horizontal Off-Axis Frequency Response @ 10, 20 & 30°

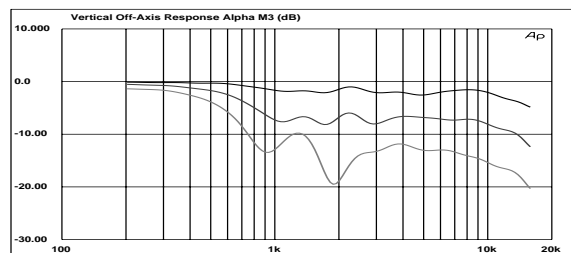

• Figure 12: Vertical Off-Axis Frequency Response @ 10, 20 & 30°

Frequency Response Curves: Anechoic Far Field above 200 Hz, Half-space Anechoic below 200 Hz.

Impedance: Voltage to Current Ratio, Free Field measurement

Off-Axis Frequency Response: 1/3 octave smoothed frequency response, normalised to On-Axis response.

Directivity Curve, Coverage Angle and Polar Diagram from computer processing on off-axis response curves.

CURVES

Alpha M3 - Horizontal Directivity (5dB / div.)

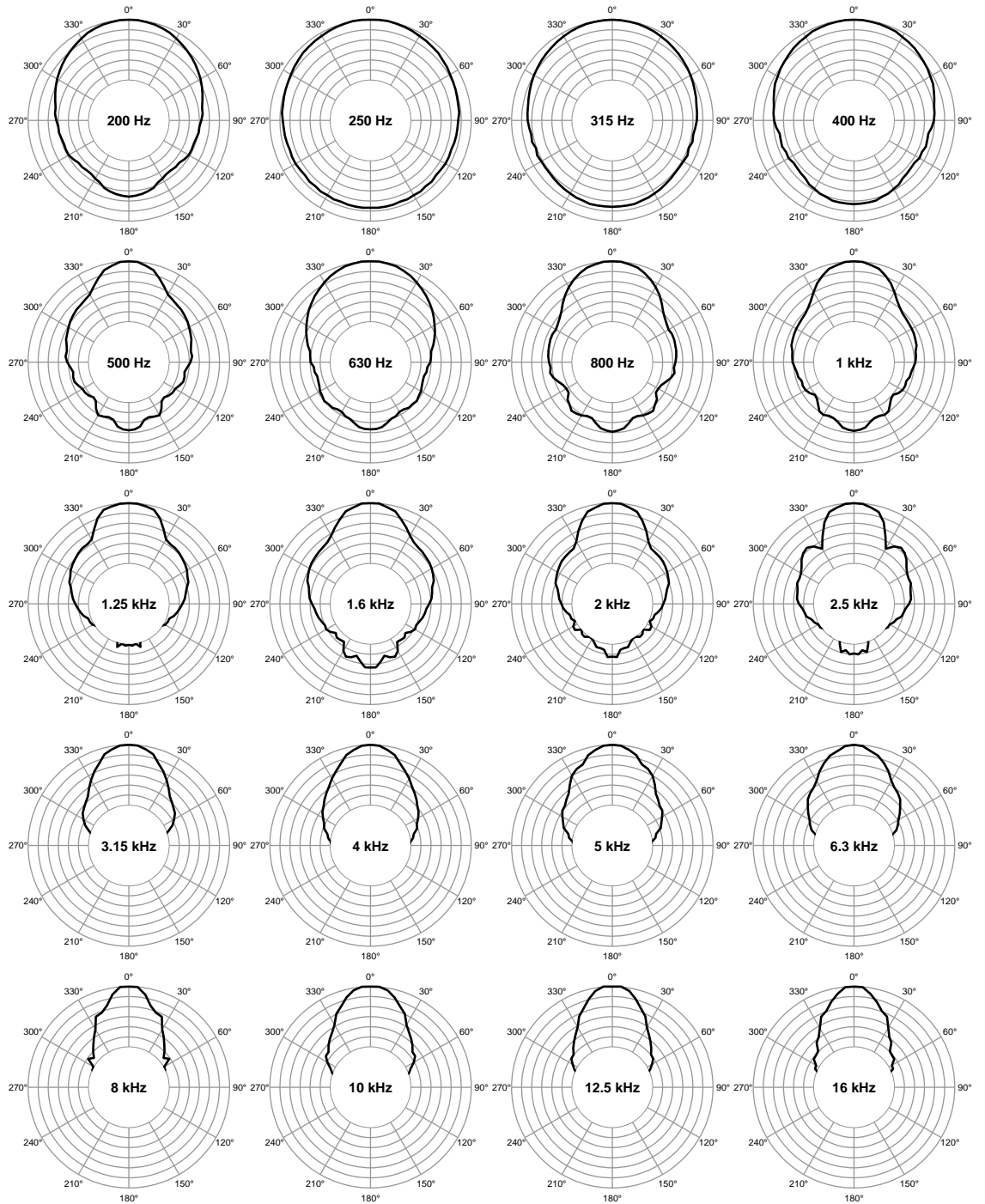

Alpha M3 – Vertical Directivity (5dB / div.)

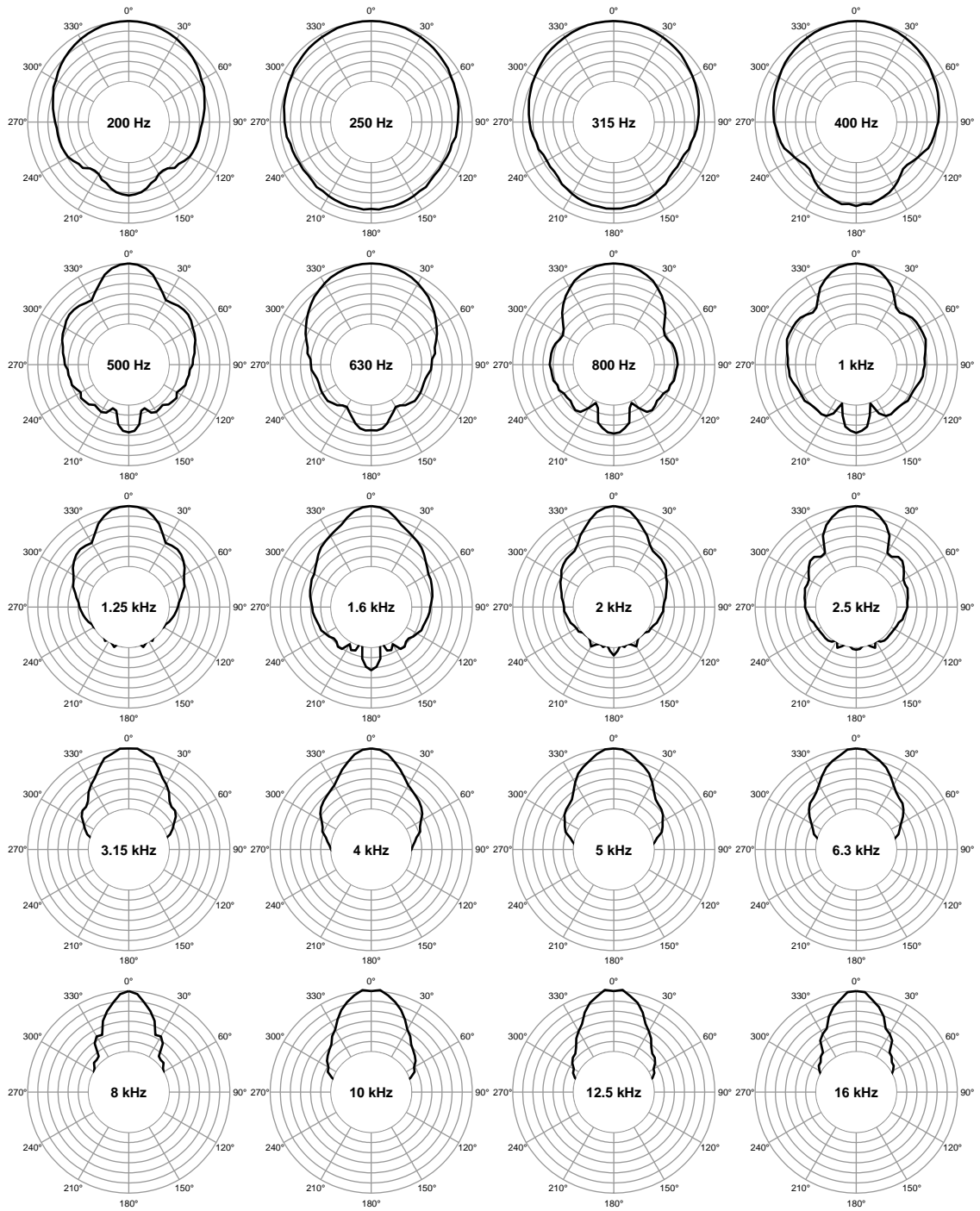

## Alpha M8

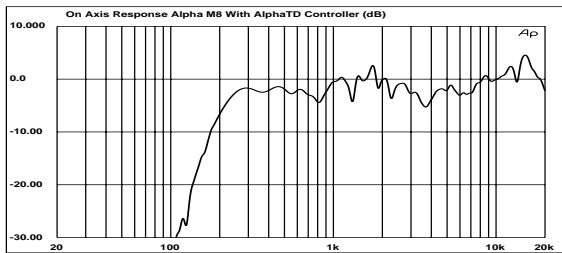

• Figure 13: Frequency Response with Alpha TDcontroller (dB)

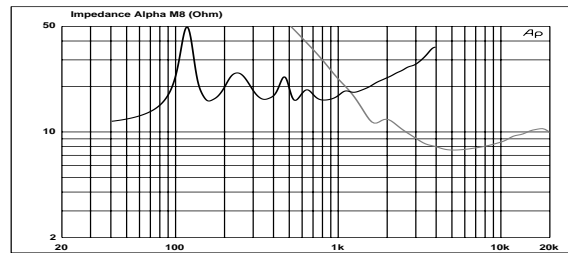

• Figure 14: Impedance (Ohms). *Black: MF, Grey: HF*

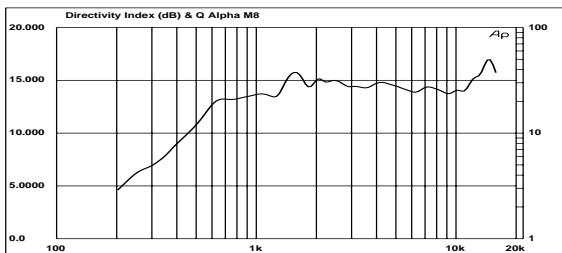

• Figure 15: Directivity Index (dB) and Factor

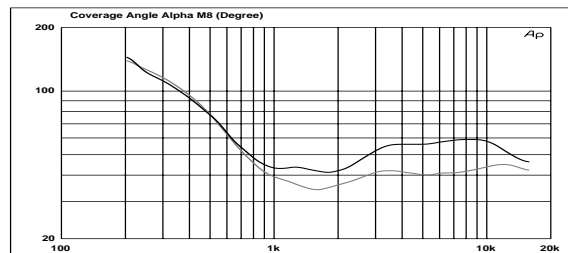

• Figure 16: Nominal Coverage @-6 dB (Degrees)

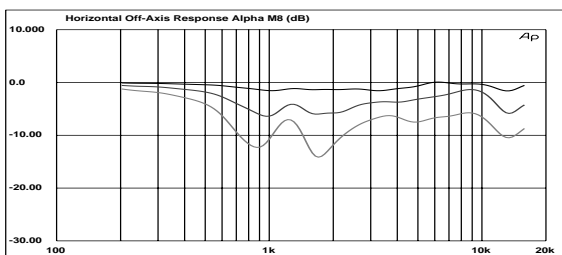

• Figure 17: Horizontal Off-Axis  
Frequency Response @ 10, 20 & 30°

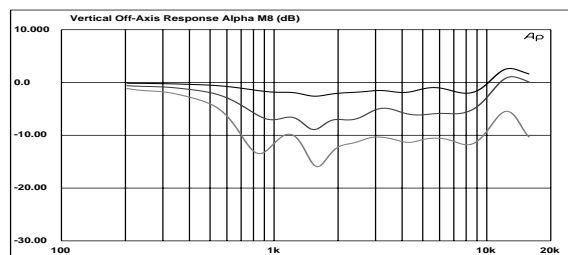

• Figure 18: Vertical Off-Axis  
Frequency Response @ 10, 20 & 30°

Frequency Response Curves: Anechoic Far Field above 200 Hz, Half-space Anechoic below 200 Hz.

Impedance: Voltage to Current Ratio, Free Field measurement

Off-Axis Frequency Response: 1/3 octave smoothed frequency response, normalised to On-Axis response.

Directivity Curve, Coverage Angle and Polar Diagram from computer processing on off-axis response curves.

Alpha M8 – Horizontal Directivity (5dB / div.)

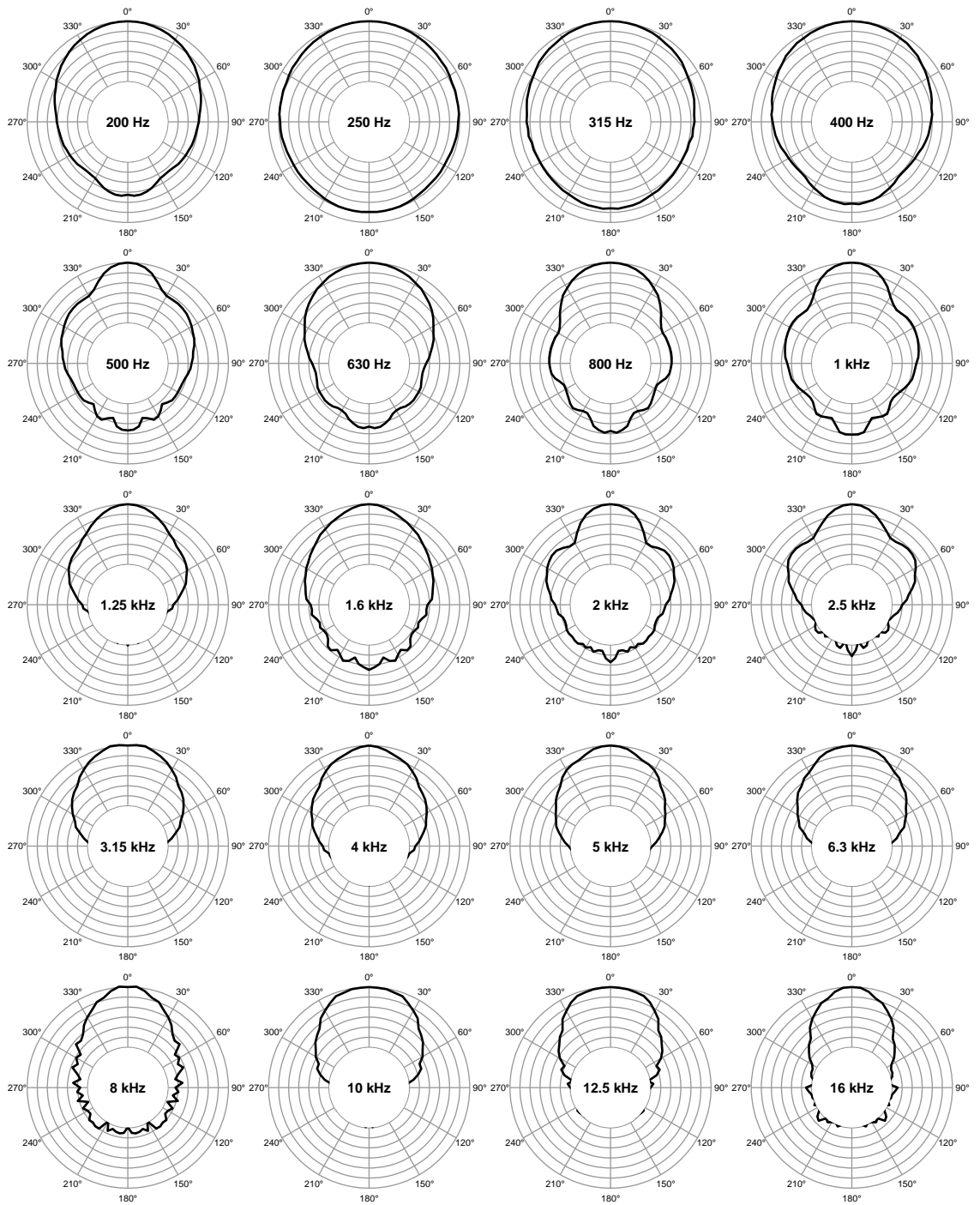

CURVES

Alpha M8 Vertical Directivity (5dB / div.)

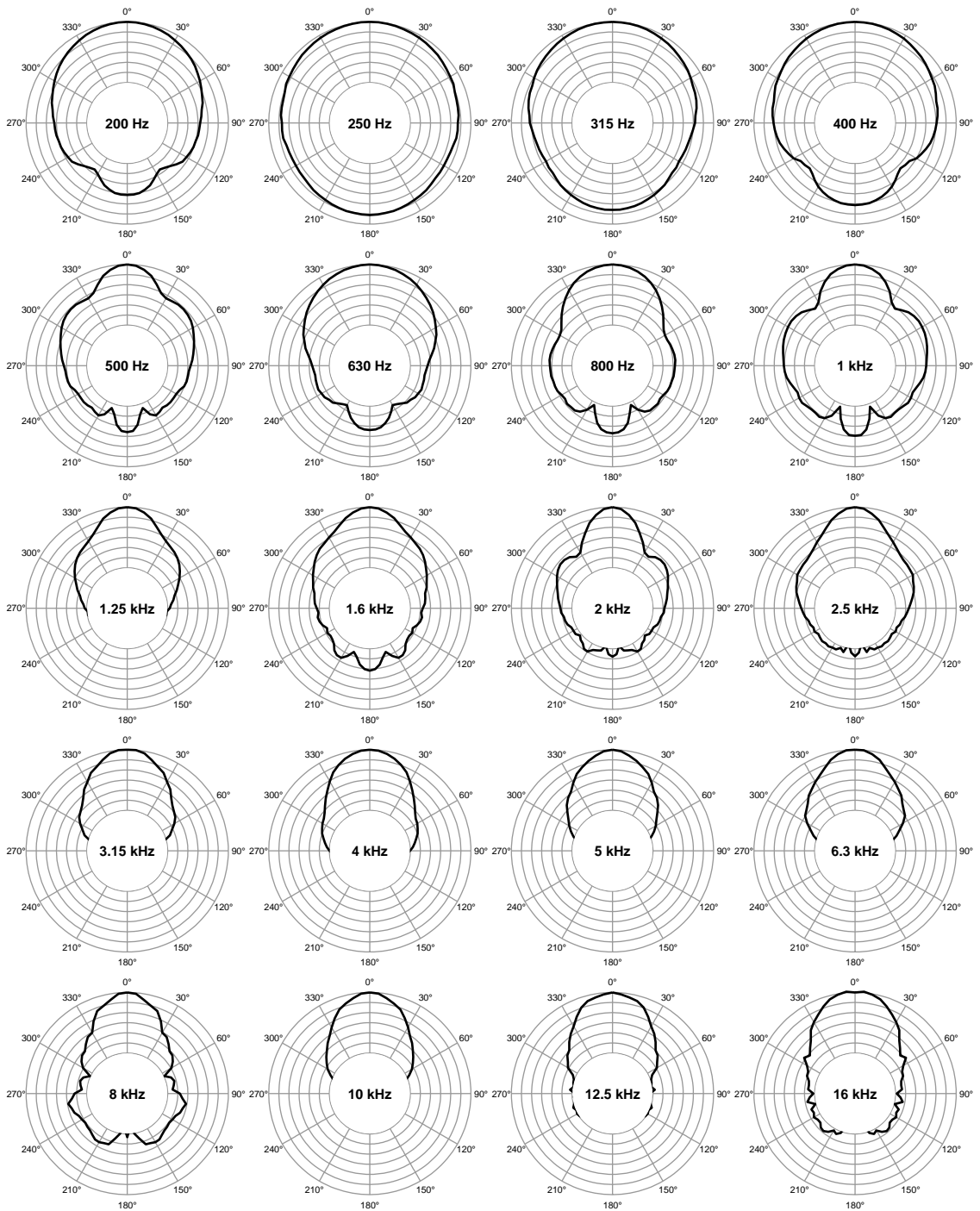

### Alpha EM

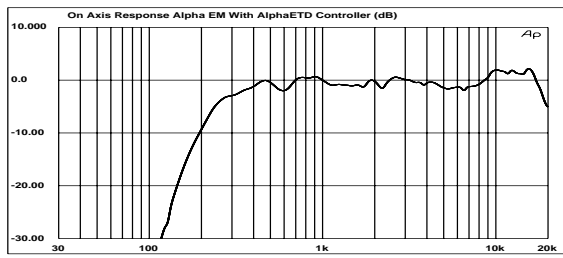

• Figure 19: Frequency Response with AlphaE TDcontroller (dB)

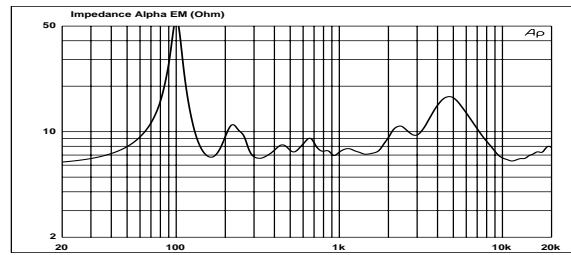

• Figure 20: Impedance (Ohms)

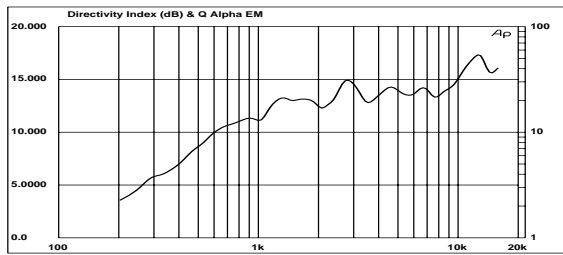

• Figure 21: Directivity Index (dB) and Factor

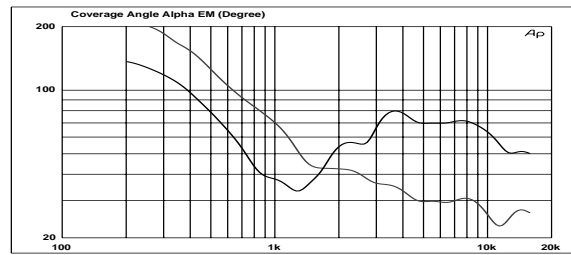

• Figure 22: Nominal Coverage @-6 dB (Degrees)

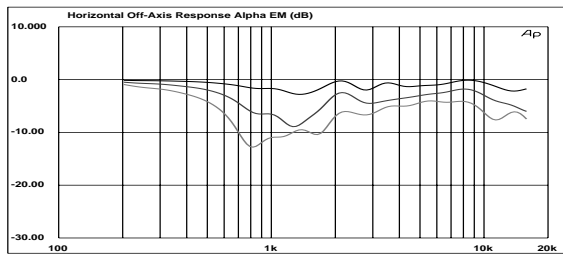

• Figure 23: Horizontal Off-Axis Frequency Response @ 10, 20 & 30°

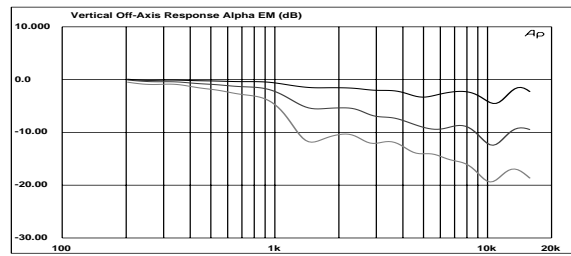

• Figure 24: Vertical Off-Axis Frequency Response @ 10, 20 & 30°

### Alpha EF

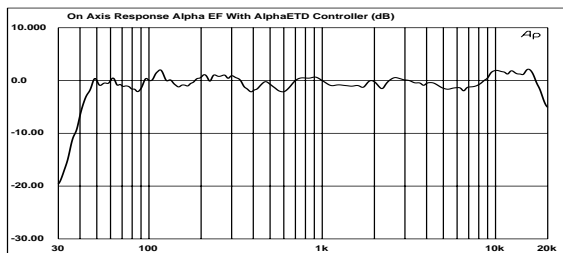

• Figure 25: Frequency Response with AlphaE TDcontroller (dB)

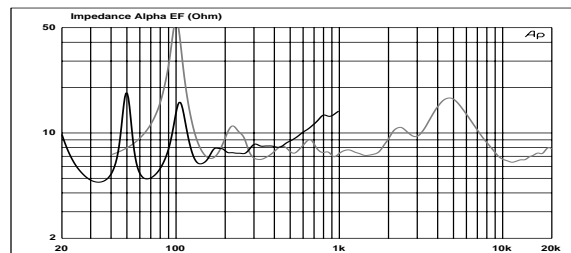

• Figure 26: Impedance (Ohms). Black: LF, Grey: MF+HF

Frequency Response Curves: Anechoic Far Field above 200 Hz, Half-space Anechoic below 200 Hz.  
Impedance: Voltage to Current Ratio, Free Field measurement  
Off-Axis Frequency Response: 1/3 octave smoothed frequency response, normalised to On-Axis response.  
Directivity Curve, Coverage Angle and Polar Diagram from computer processing on off-axis response curves.

CURVES

Alpha EM – Horizontal Directivity (5dB / div.)

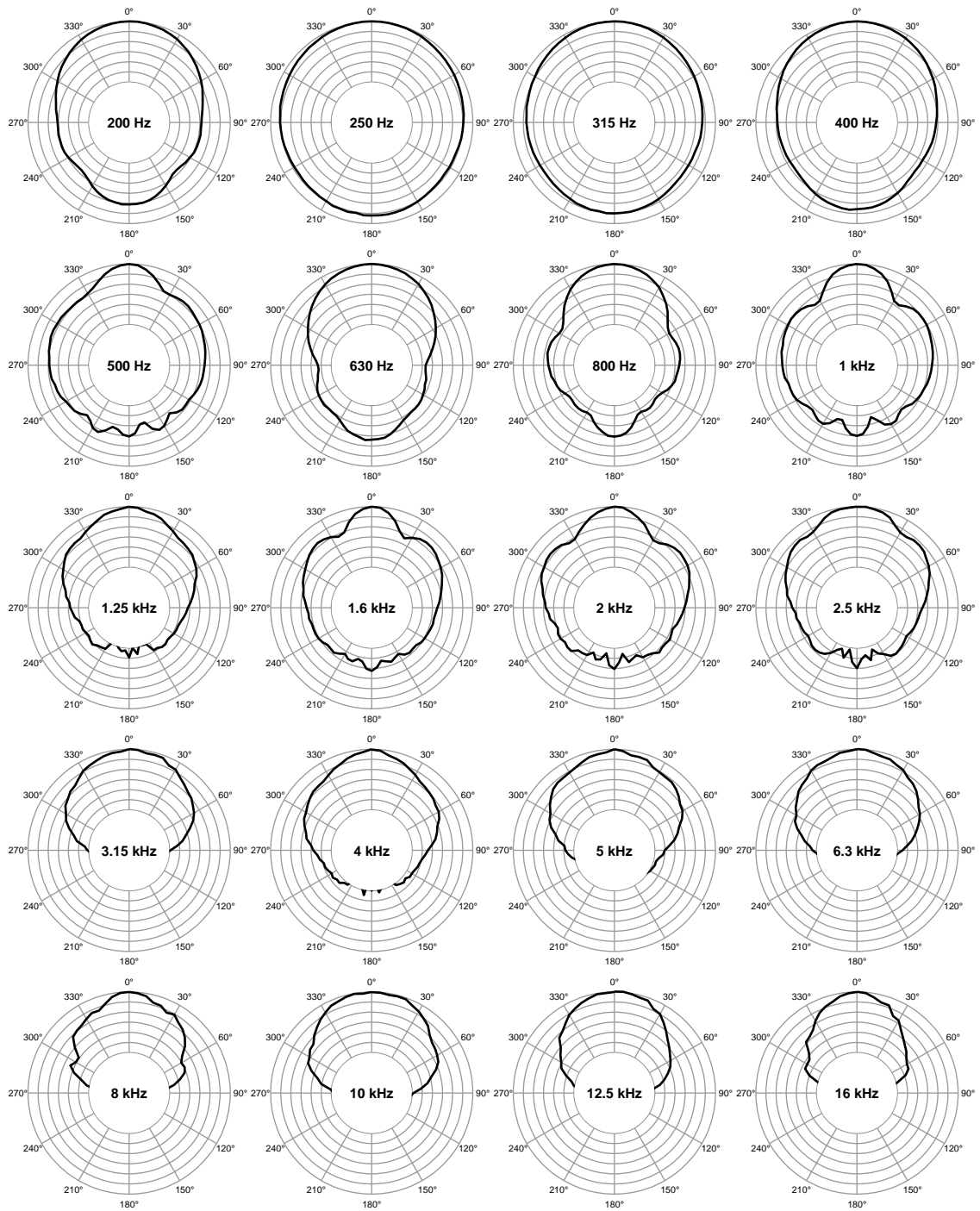

Alpha EM – Vertical Directivity (5dB / div.)

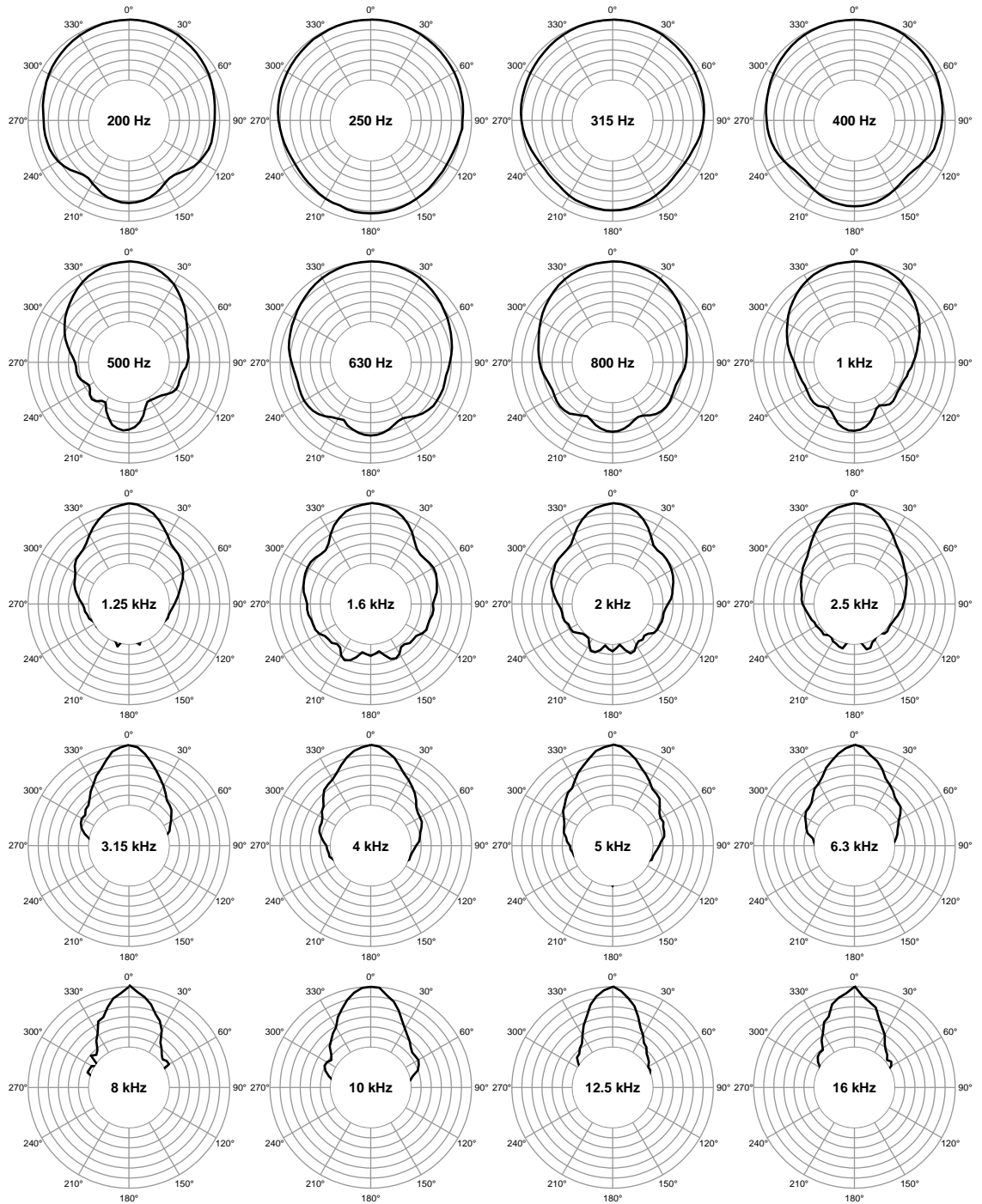

DIMENSIONS

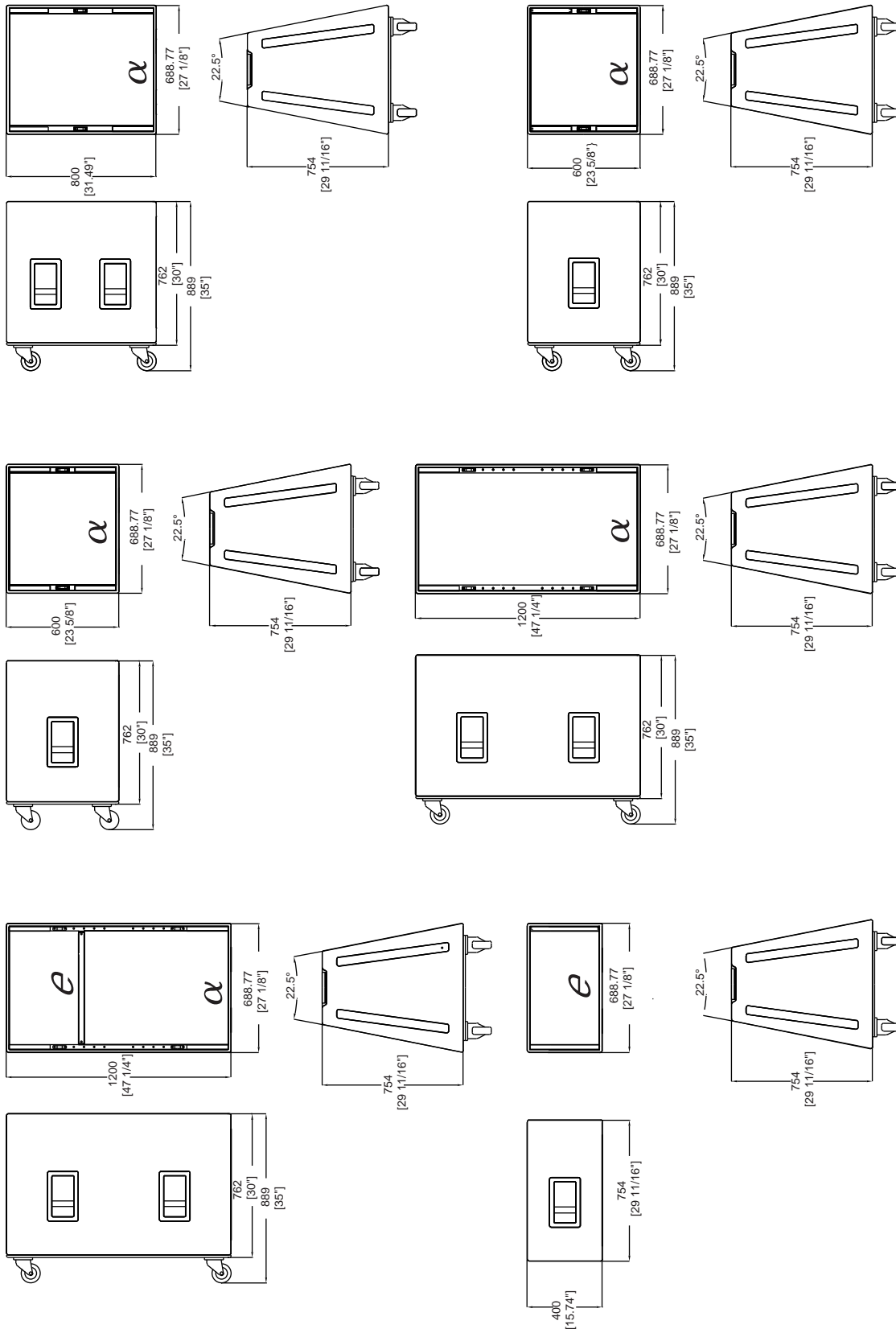

TRANSPORT

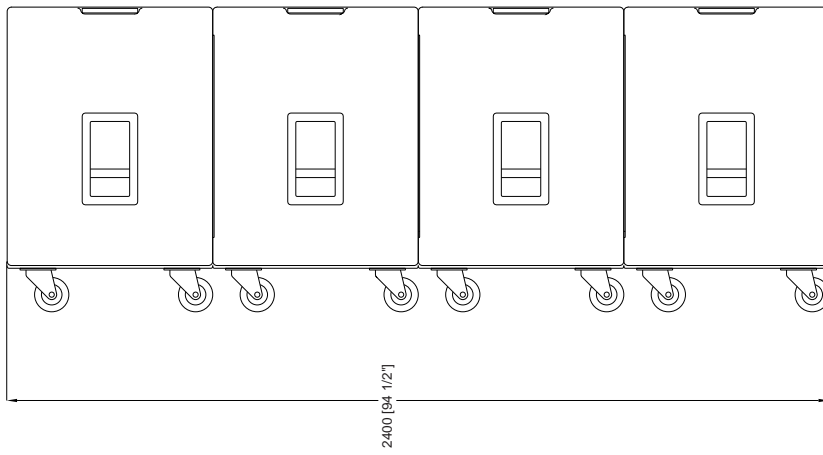

SIDE VIEW

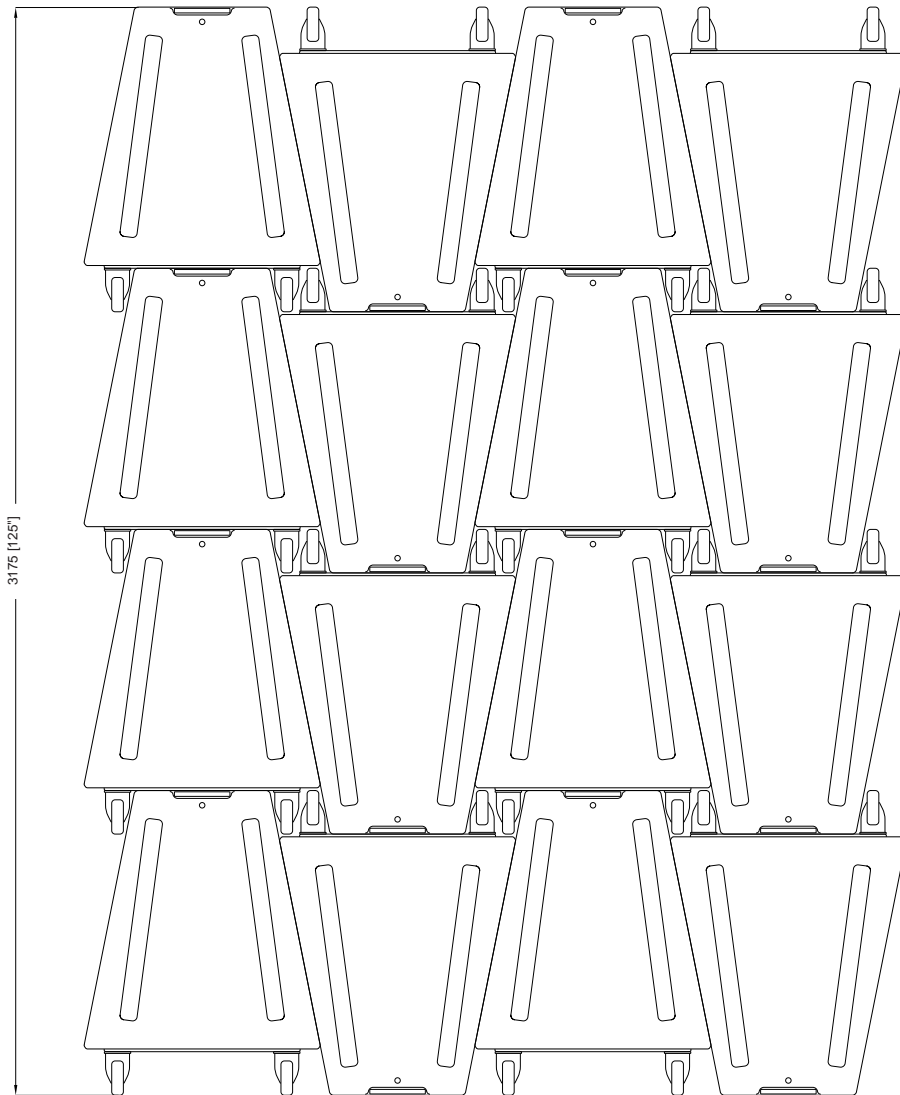

TOP VIEW

Connection Diagrams

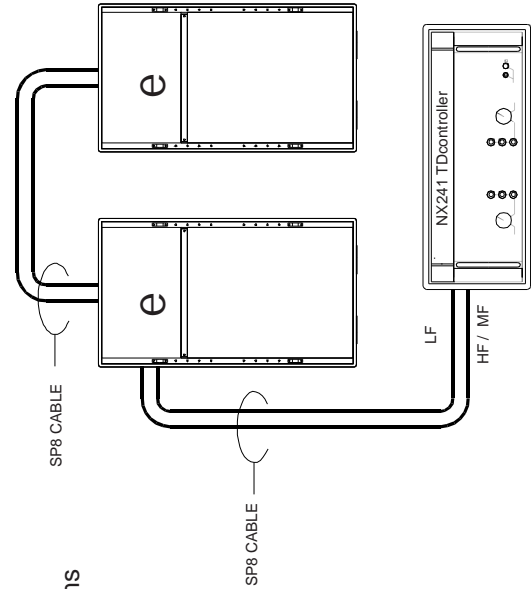
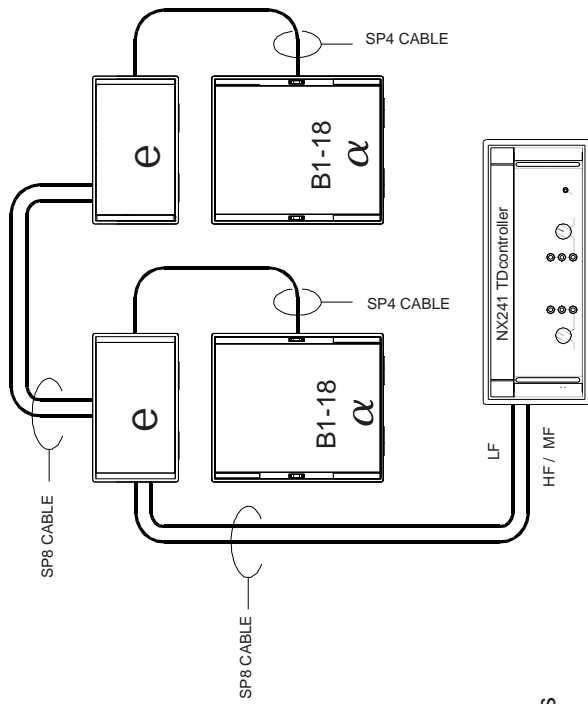

$\alpha^e$

Recommended Amplifiers  
**ALPHA EM**  
 700 to 1000 Watts into 8 ohms  
**ALPHA B1-18**  
 900 to 1400 Watts into 6 ohms

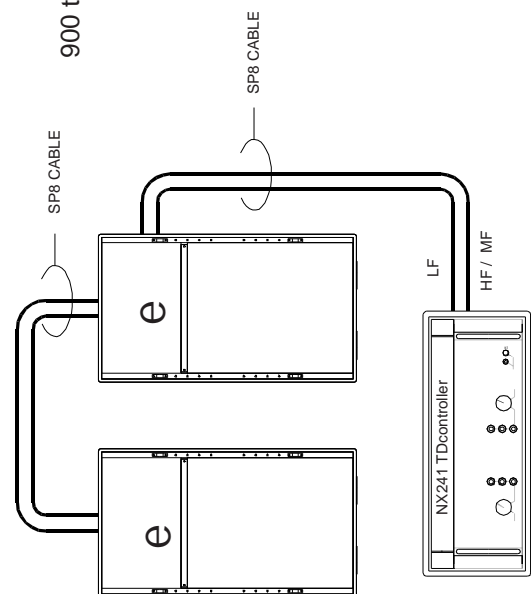
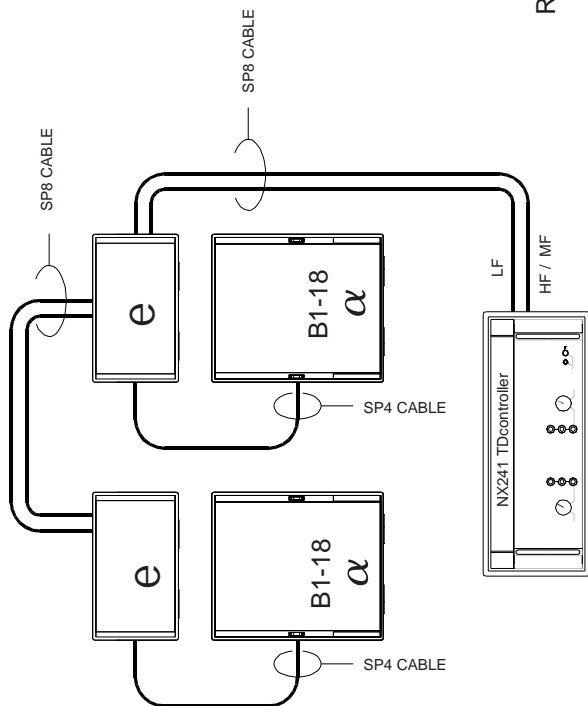

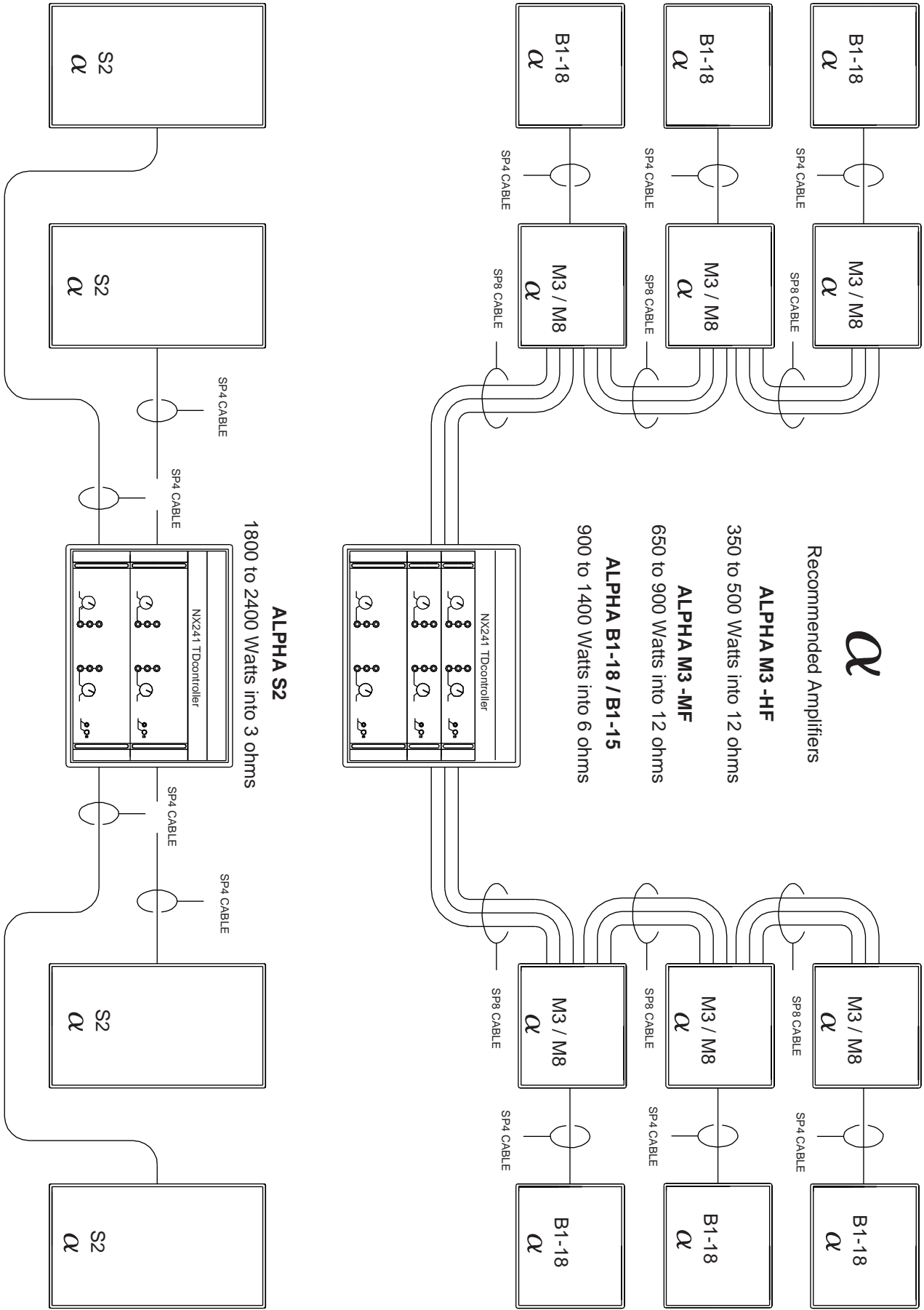

**France**

**NEXO S.A.**

154 Allée des Erables  
ZAC de PARIS NORD II BP 50107  
F-95950 ROISSY CDG CEDEX  
Tel: +33 1 48 63 19 14  
Fax: +33 1 48 63 24 61  
Email: info@nexo.fr

**USA**

**NEXO USA Inc.**

7950 Redwood Drive  
Suite 3  
Cotati CA 94931  
Tel: +1 707 793 9300  
Fax: +1 707 793 9310  
Email: nexousa@aol.com

**UK**

**NEXO limited**

9 Lyon Road  
Walton-on-Thames  
Surrey KT12 3PU  
Tel: +44 1932 886 007  
Fax: +44 1932 886 008  
Email: info@nexo-sa.com

**FAR EAST**

**NEXO Far East Ltd**

101 Lorong, 23 Geyland  
#06-04 Prosper House  
Singapore 388399  
Tel: +65 742 5660  
Fax: +65 742 8050  
Email: info@nexo-sg.com